**User's
Manual**

CW10
クランプ電力チェッカ
Clamp-on Power Meter

保証書付

この取扱説明書は、いつでも使用できるよう
大切に保管してください。

Store this manual in an easily accessible place
for quick reference.

Regarding the Safe Use of This Product

This product is designed to be used by a person with specialized knowledge. When operating the instrument, be sure to observe the cautionary notes given below to ensure correct and safe use of the instrument. If you use the instrument in any way other than as instructed in this manual, the instrument's protective measures may be impaired. This manual is an essential part of the product; keep it a safe place for future reference.

YOKOGAWA is by no means liable for any damage resulting from use of the instrument in contradiction to these cautionary notes.

The following safety symbols are used on the instrument and in this manual.



Danger! Handle with Care.

This symbol indicates that the operator must refer to an explanation in the User's Manual in order to avoid risk of injury or death of personnel or damage to the instrument.



WARNING

Indicates a hazard that may result in the loss of life or serious injury of the user unless the described instruction is abided by.



CAUTION

Indicates a hazard that may result in an injury to the user and/or physical damage to the product or other equipment unless the described instruction is abided by.



Hazardous Voltage

This operator must never attempt to touch equipment or parts marked with this symbol.



This symbol indicates double insulation or reinforced insulation.



This symbol indicates direct current (DC).



This symbol indicates alternating current (AC).



This symbol indicates ground (earth).



This symbol indicates a battery.



This symbol indicates that this instrument designed to be applied around or removed from HAZARDOUS LIVE conductors provided if the RATED circuit-to-earth voltage dose not exceed the value indicated in the measurement category.



This symbol indicates, If the measured voltage is greater than 30 V DC or AC RMS or Overload (OL or -OL).

Always observe the following instructions. Failure to do so may result in electrical shock or other dangers that may lead to serious injury or the loss of life.

 **WARNING**

- The instrument is a power measurement instrument that can measure parameters such as voltage, current, and power.
Do not use this instrument for any other purpose.
 - Do not use the instrument if there is a problem with its physical appearance.
 - Do not use the instrument in an atmosphere where any flammable or explosive gas is present.
 - To avoid a short-circuit or an accident to personnel, use this instrument within the RATED circuit-to-earth voltage, maximum input voltage and current.
 - Avoid using the instrument if it has been exposed to rain or moisture or if your hands are wet.
 - Barrier is for to avoid touching the HAZARDOUS LIVE conductor. Be careful not to across the Barrier when using the instrument.
 - Do not use the instrument if there is any damage to the casing or when the casing is removed.
 - Use the test leads supplied by Yokogawa with this instrument.
 - Do not use test leads that have deteriorated or are defective.
 - Check the test leads continuity.
 - When you attach or remove the test leads or remove the case (for example to charge the battery), be sure to remove the test leads from the circuit under measurement.
 - When you remove the case (for example to change the battery), be sure to remove the test leads from the instrument.
 - Safety protectors such as rubber-insulated gloves should be worn to prevent electrical shock when using the instrument.
 - There are caps at the ends of the test leads. To ensure safety (safety standard EN 61010-031), be sure to put the caps on the leads when you use them.
 - Do not open the case except when replacing batteries.
Only Yokogawa service personnel are authorized to remove the casing or disassemble or modify the instrument.
Do not attempt to repair the instrument yourself, as doing so is extremely dangerous.
-

 **CAUTION**

- The product is for domestic use (Class B) and meets the electromagnetic compatibility requirements.
 - Do not use the instrument near noise-emitting equipment or where there may be sudden changes in temperature.
Otherwise, the instrument may produce an unstable readings or errors.
 - Do not wipe the instrument using an organic solvent.
When cleaning the instrument, use a dry cloth.
 - Do not leave the tester exposed to direct sunlight or in a hot and humid location such as the inside of a car, for any prolonged length of time.
 - If the instrument will not be used for long periods, remove the battery.
-

Contents

Regarding the Safe Use of This Product	1
1. Checking the Contents of the Package	4
2. Measurement Category	4
3. Components	5
4. Display (LCD)	6
5. Power ON/OFF and Auto power off	6
6. Cursor/ENTER key	6
7. Making Basic Measurements	7
7.1 Measuring Voltage	7
7.2 Measuring Current	7
8. Others Function	8
8.1 AUTO SENSE	8
8.2 RANGE	8
8.3 Peak Hold (AC mode only)	9
8.4 Inrush current (AC mode only)	11
8.5 DCA ZERO	12
8.6 Measuring Frequency Hz (AC mode only)	12
8.7 MAX/MIN	13
8.8 Harmonic Measurement (AC mode only)	13
8.8.1 THD Measurement	13
8.8.2 Individual Harmonic Measurement	14
8.9 Low pass filter (AC mode only)	14
8.10 Measuring Active Power	15
8.10.1 Single phase 2 wire	15
8.10.2 3 phase 3 wire (balanced/unbalanced)	16
8.10.3 3 phase 4 wire (balanced/unbalanced)	16
8.10.4 Phase Rotation	17
8.11 Measuring Resistance.	19
8.11.1 Resistance (Ω).	19
8.11.2 Continuity Check	20
8.11.3 Diode Test	20
8.12 HOLD	20
8.13 Voltage Sense	20
8.14 Buzzer	21
8.15 Additional Power-on Function	21
9. Battery State display and Battery Replacement	21
9.1 Battery State display	21
9.2 Battery Replacement	21
10. Specifications	22
10.1 General Specifications	22
10.2 Accuracy	23
11. Maintenance and After-Sales Service	26
12. Sales in Each Country or Region	26
12.1 Disposing the Product	26
12.2 How to Replace and Dispose the Batteries	26
12.3 Authorized Representative in the EEA	26
12.4 For the Pollution Control of Electronic and Electrical Products of the People's Republic of China	27

Disk No. CW10

7th Edition: November 2017

All Rights Reserved, Copyright ©

2011, Yokogawa Test & Measurement Corporation

Printed in Taiwan

1. Checking the Contents of the Package

After opening the package, be sure to check the product as instructed below before use.

1. Main Unit: CW10 (including battery)
2. Test leads: 1set (Black and Red)
3. User's Manual
4. Soft Case

2. Measurement Category



When you use the test leads, attach or remove the caps according to the measurement category.

CW10 main unit:

1000V CAT III, 600V CAT IV

Test leads:

With Caps: 1000V 10A CAT III, 600V 10A CAT IV

Without Caps: 1000V 10A CAT II

Measurement Category	Description	Remarks
○ None Other	Other circuits that are not directly connect to MAINS.	Circuits not connected to a mains power source.
CAT II	For measurement performed on circuits directly connected to the low-voltage installation.	Appliances, portable equipment, etc.
CAT III	For measurement performed in the building installation.	Distribution board, circuit breaker, etc.
CAT IV	For measurement performed at the source of the low-voltage installation.	Overhead wire, cable systems, etc.

3. Components

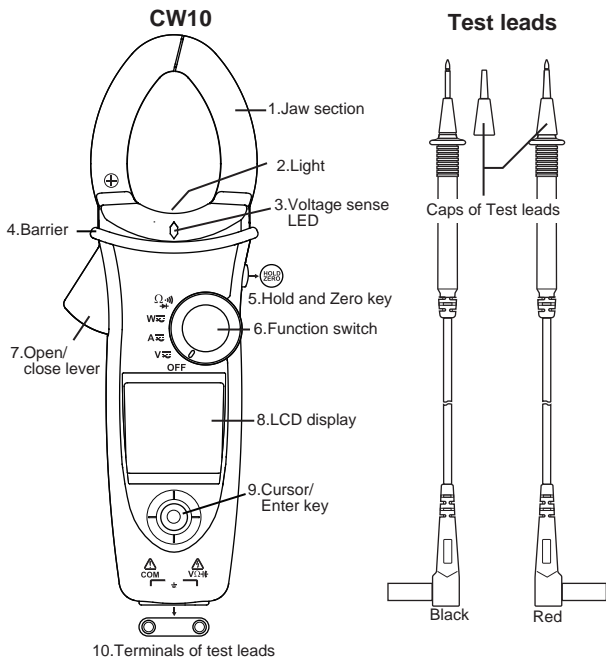

Main Unit: CW10

1. Is a precision sensor for detecting currents.
2. When the jaws are open, the light will illuminate.
3. In case voltage is detected by the jaw, the red LED lights up.
4. Prevents contact with the wires.
5. Retains the measured data or DCA ZERO: Zero adjustment
6. Use this switch to turn the power on and off and to select the measurement mode.
7. Opens and closes the jaws.
8. LCD display
9. Cursor and Enter key
10. Input terminals for test leads

[NOTE]

There is the ⚡ mark on the terminal, but this device does not have a function for measuring capacitance.

4. Display (LCD)

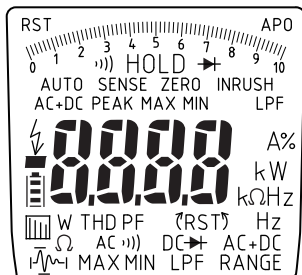

5. Power ON/OFF and Auto power off

CAUTION

Check that the meter operates normally.

Turn the function switch to the measurement (any) position from OFF. To end measurement, turn the function switch off.

<Auto power off>

Indication: APO

This instrument automatically turns off about 15 minutes after the last switch operation.

Recovering the Auto power off function:

Turn off the power. Turn on the power.

When the function is not use (cancellation):

Turn off the power. Hold down Downward of cursor key, turn the function switch to any position.

(The APO display goes off.)

If the instrument is used with the Auto power off function cancelled, take care not to let the battery run down.

6. Cursor/ENTER key

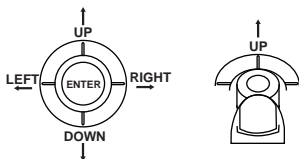

Cursor key: Moves the Cursor (four directions) to the item (mode) of display you wish select. Press the convex key toward selecting mode.

ENTER key: Confirms the item (mode).

[NOTE]

Push whole key toward requisite item.

Push down the center position of key to confirm (ENTER key).

7. Making Basic Measurements

7.1 Measuring Voltage



WARNING

Do not apply more than 1000 VDC or 1000 Vrms (1414.2 Vpk).

Plug the test leads to the input terminals.

[NOTE]

When connecting the test leads to the circuit under measurement, connect the black (common) before connecting the red (live); when removing the test leads, remove the red (live) before removing the black (common).

Turn the function switch to the Voltage V $\overline{\sim}$ position.

Read the voltage value of display.

On Auto Sense mode, the CW10 automatically detects AC or DC.

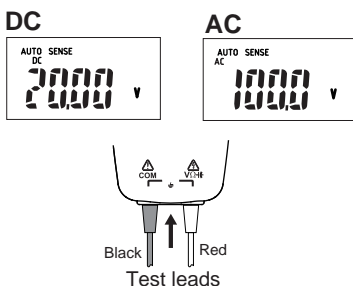

7.2 Measuring Current



WARNING

-
- Do not apply more than 600 ADC or 600 Arms (848.5 Apk).
 - When you measure the current, be sure to remove the test leads from the instrument.
-

Squeeze the open/close lever to open the jaws. Insert a wire from the measurable conductors under the test though the jaws, making sure the tops of the jaws are tightly shut.

Turn the function switch to the Current A $\overline{\sim}$ position.

Read the current value of display.

Using Auto Sense mode, the CW10 automatically detects AC or DC.

[NOTE]

- When performing a measurement, hold the instrument so that the measured conductor cable runs at the center of the clamp.
- Ensure that the orientation of the clamp to the direction of the conductor wire is correct as shown right.

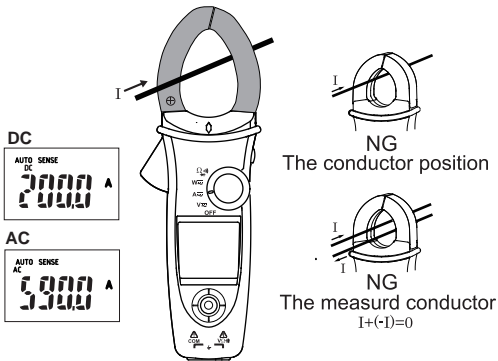

8. Others Function

8.1 AUTO SENSE

Using Auto Sense mode, the CW10 automatically detects AC or DC. (The detection is determined by whichever input is greater.)

To select manual mode (Example: DC mode);

Use the cursor key to select under "DC" (flash) and then press the ENTER key to confirm.

Upper "DC" indication is fixed and AUTO (AUTO RANGE) is displayed.

To return AUTO SENSE, press the ENTER key for more than 2 seconds.

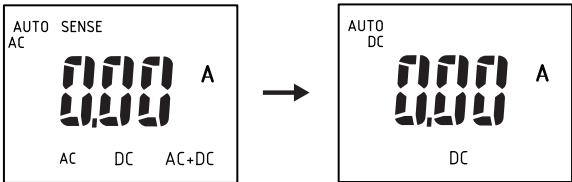

8.2 RANGE

To select manual range (fixed);

Use the cursor key to select "RANGE" and then press the ENTER key to confirm.

(To cancel manual range, press the ENTER key for more than 2 seconds.)

Example: ACV 100 V range ← → 1000 V range

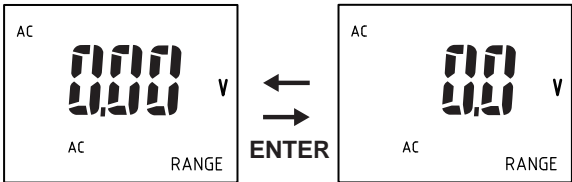

On Auto sense mode, the measuring range is automatic.

8.3 Peak Hold (AC mode only)

(1) AC Voltage

Turn the function switch to the voltage (V) position.

After using the ENTER key to confirm AC mode, use the cursor key to select Peak Hold $\overline{\sim}$ and then press the ENTER key to confirm.

Press the ENTER key to switch between PEAK MAX (polarity+) and

PEAK MIN (polarity-).

(To cancel Peak Hold, press the ENTER key

for more than 2 seconds.)

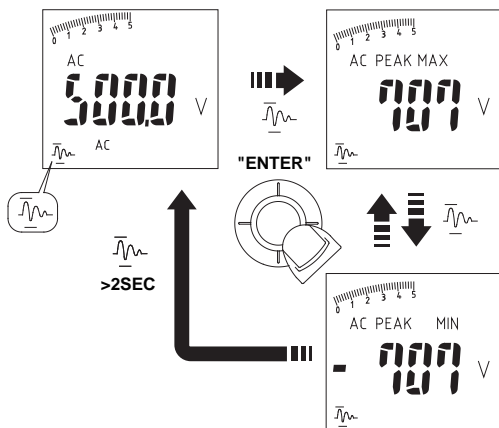

[NOTE]

Bar-graph indication is not PEAK value.

Bar-graph indication is affected by the ACV value.

(Example: 500.0 V)

(2) AC Current

Turn the function switch to the current (A) position.

After using the ENTER key to confirm AC mode,

use the cursor key to select Peak Hold. 

Press the ENTER key for more than 2 seconds

to select PEAK MAX. 

Press the ENTER key to switch between PEAK MAX (polarity+) and PEAK MIN (polarity-).

(To cancel Peak Hold, press the ENTER key for more than 2 seconds.)

[NOTE]

Bar-graph indication is not PEAK value.

Bar-graph indication is affected by the ACA value.

(Example: 500.0 A)

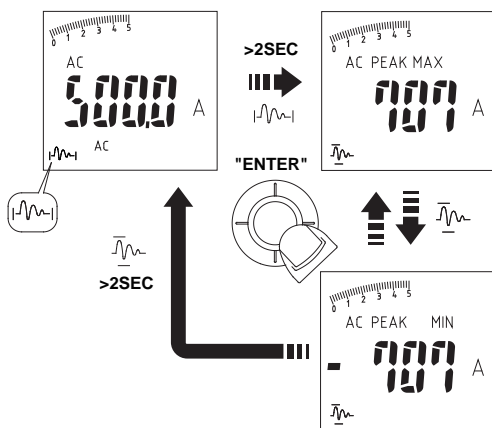

8.4 Inrush current (AC mode only)

The CW10 has a function for measuring Inrush current.

Turn the function switch to the current **A**  position.

Using the ENTER key to confirm AC mode.

Using the cursor key to select Peak Hold  (Inrush current) and then press the ENTER key to confirm. (INRUSH)

Waiting state, after trigger, the Inrush current value (RMS) for 100m seconds (measurement period) is displayed.

Press the ENTER key once to return ACA mode.

Press the ENTER key once again to return waiting state (restart).

[NOTE]

If the Inrush current is expected to exceed 100 ACA, select 600 A range in advance of measuring.

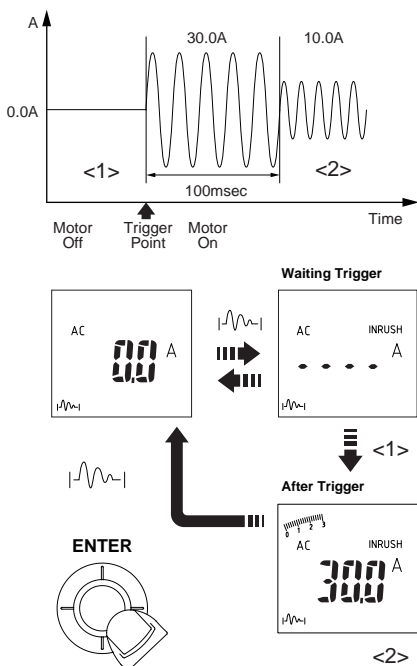

8.5 DCA ZERO

We recommend that you perform zero adjust (DCA ZERO) before measuring DCA mode.

[NOTE]

Remove the jaws out of the conductor.

Press the HOLD key of right side for more than 2 seconds.

After "----" is displayed, ZERO adjustment is confirmed.

DCA Zero is only available in AUTO SENSE, DC and AC+DC mode.

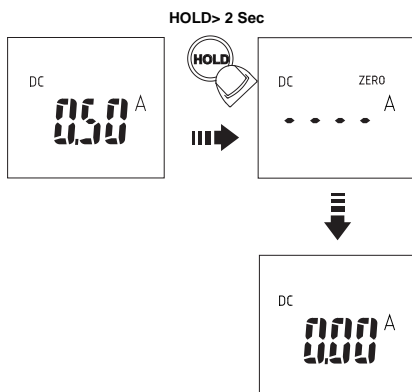

8.6 Measuring Frequency Hz (AC mode only)

- <1> Turn the function switch to the voltage $V \sim$ or current $A \sim$ position.
- <2> Using the ENTER key to confirm AC mode.
- <3> Using the cursor key to select "Hz" and then press the ENTER key to confirm.
(The unit of Hz and the frequency value are displayed.)
Using ENTER key to change unit (to cancel).

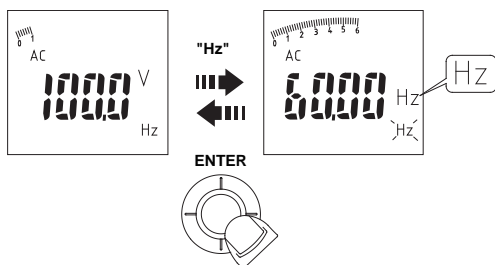

< RANGE >

On measuring frequency, Using the cursor key to select "RANGE" and then press the ENTER key to confirm. The frequency range is fixed. Each time "RANGE" (ENTER) key is pressed, range is changed. On measuring frequency, ACV or ACA range is fixed.

8.7 MAX/MIN

The minimum and maximum value during measurement are updated (displayed).

Using the cursor key to select "MAX/MIN" and then press the ENTER key to MAX/MIN mode.

(To cancel the function, press the ENTER key for more than 2 seconds.)

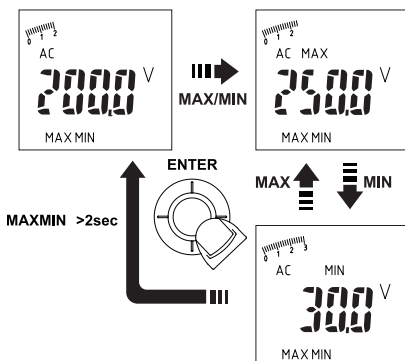

[NOTE]

HOLD key is pressed in MAX/MIN mode, the MAX and MIN values are not updated. ("HOLD" is appeared)

To cancel the function, press the HOLD key again.

8.8 Harmonic Measurement (AC mode only)

8.8.1 THD Measurement

Harmonic measurements (fundamental wave to 25th harmonics) can be displayed. In ACV or ACA mode (after confirming AC using the ENTER key), use the cursor key to select "THD," and then press the ENTER key to confirm.

Press the ENTER key to toggle between the rms value and the distortion factor.

$$\text{THD-F} = \sqrt{\frac{\sum_{n=2}^{25} (\text{nth order harmonic voltage(current) rms value})^2}{(\text{fundamental wave voltage(current) rms value})^2}} \times 100\%$$

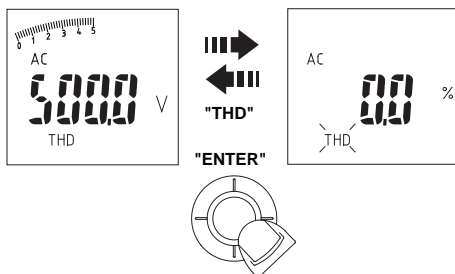

8.8.2 Individual Harmonic Measurement

Harmonic measurements individual order (fundamental wave to 25th) can be displayed. In ACV or ACA mode (after confirming AC using the ENTER key), use the cursor key to select , and then press the ENTER key to confirm.

(To cancel the function, press the ENTER key for more than 2 seconds.)

$$H_n = \frac{\text{nth order harmonic voltage (current) rms value}}{\text{fundamental wave voltage (current) rms value}} \times 100\%$$

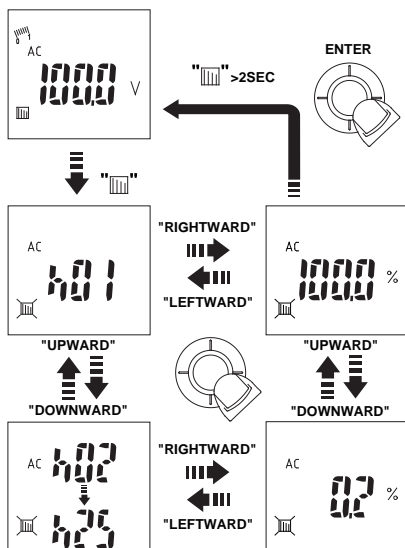

8.9 Low pass filter (AC mode only)

The CW10 has a function for turning the filter on (use) /off. On ACV or ACA mode (using ENTER key to confirm AC), Using the cursor key to select "LPF" and then press the ENTER key to confirm.

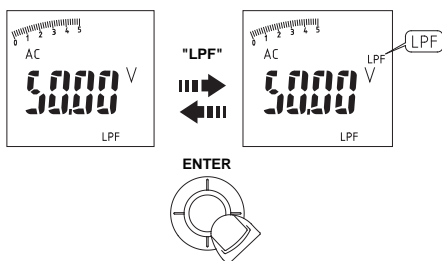

[NOTE]

Cut of frequency: approximately 1 kHz

8.10 Measuring Active Power

WARNING

- Do not apply more than 1000 VDC or 1000 Vrms (1414.2 Vpk).
- Do not apply more than 600 ADC or 600 Arms (848.5 Apk).

8.10.1 Single phase 2 wire

- <1> Turn the function switch to the Active power **W**  position.
- <2> Connect the red test lead to Line (+) and the black test lead to N (-).
- <3> Squeeze the open/close lever to open the jaws and clamp them onto the wire under test. (Ensure that the jaws are properly closed and the conductor runs thru the center of the clamp.)

- <4> When measuring Active power:

Use the cursor key to select "W" and then press the ENTER key to confirm.

When measuring Power factor:

Use the cursor key to select "PF" and then press the ENTER key to confirm.

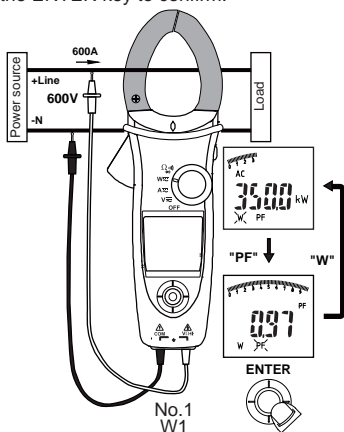

[NOTE]

- The "+" symbol on the jaw must face on the power source side.
- In Auto sense mode, The CW10 can detect ACW or DCW automatically.

Overload (over range) Description

OL.U: Voltage overload

OL.A: Current overload

OL.UA: Both Voltage and current overload.

OL kW, -OL kW: Active Power > 1000 kW or < -1000 kW.

Active power polarity

Non-display (+):

Indicates the power flows from the power source to the load.

Minus (-):

Indicates the power flows from the load to the power source.

Power factor polarity

Non-display (+): The phase of the current signal is lagging behind the voltage signal (inductive load).

Minus (-): The phase of the current signal is leading the voltage signal (capacitive load).

8.10.2 3 phase 3 wire (balanced/unbalanced)

To use two the CW10

- <1> Turn the function switch to the Active power W  position.
- <2> Connect following connecting diagram.
- <3> Use the cursor key to select "W" and then press the ENTER key to confirm.

Active power (W) = $W1+W2$: sum total

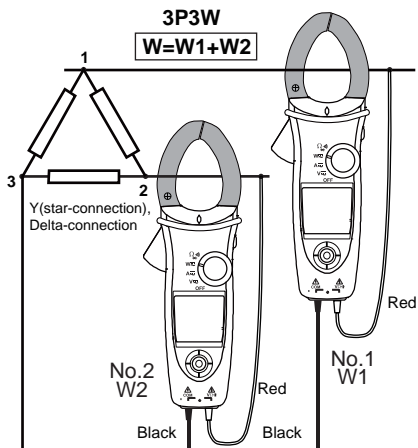

8.10.3 3 phase 4 wire (balanced/unbalanced)

To use three the CW10

- <1> Turn the function switch to the Active power W  position.
- <2> Connect following connecting diagram.
- <3> Use the cursor key to select "W" and then press the ENTER key to confirm.

Active power (W) = $W1+W2+W3$: sum total

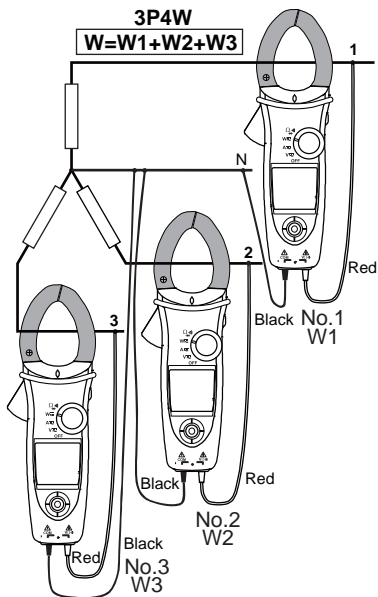

8.10.4 Phase Rotation

The CW10 can measure (test) phase rotation.
(Only if the system frequency is stable.)

- <1> Turn the function switch to the Active power W position.
- <2> Use the cursor key to select "RST" and then press the ENTER key to confirm.
- <3> Connect the red test lead to the phase Line1 and the black test lead to the phase Line3.
If connecting is normal, "L1" is displayed (flash for about 3 seconds.)

Indication (flash)	Condition
OLU	Voltage > 1000 V
LoU	Voltage < 30 V
outF	Frequency < 45 Hz, 65 Hz < Frequency

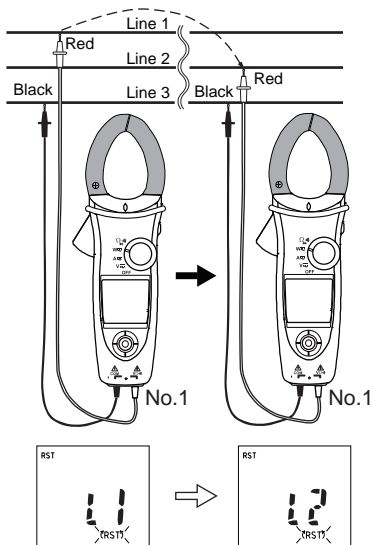

- <4> "L2" is displayed and then buzzer beeps twice.
Switch over the red test lead to connect to the phase Line2 immediately before "L2" disappears.
- <5> After "L2" disappears, the following testing result is displayed.

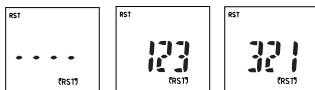

Indication (testing result)	Explanation
123	Forward sequence; The phase Line1 is ahead of Line2.
321	Reversed sequence; The phase Line2 is ahead of Line1.
----	It is not possible to judge
LoU	It is possible that you remove the test leads before completing the whole testing procedures.

- <6> To repeat the test, use the cursor key to select "RST" again and then press the ENTER key to confirm.

8.11 Measuring Resistance



CAUTION

To avoid damage to instrument

Turn off the power to the circuit under test before starting measurement in order to prevent any excessive voltage from being applied to the instrument.

On measuring resistance (Ω), use AUTO SENSE mode to measure three items automatically: Resistance, Continuity check and Diode test

[NOTE]

Maximum open circuit voltage;

Resistance (continuity check): approximately +3 V

Diode test: approximately -1.8 V, +1.8 V

Manual setting (When you do not use the AUTO SENSE)

8.11.1 Resistance (Ω)

- <1> Turn the function switch to the Resistance position.
- <2> Plug the test leads to terminals.
- <3> Use the cursor key to select Resistance Ω and then press the ENTER key to confirm.
- <4> Read the measured value.
(To return AUTO SENSE, press the cursor key for more than 2 seconds)

[NOTE]

To measure manual range (the range is fixed), use the cursor key to select RANGE and then press the ENTER key to confirm.

Function switch (Ω) position

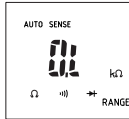

Resistance

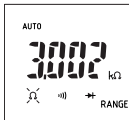

Test leads

Continuity

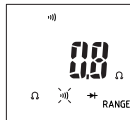

Buzzer(Beep)



Test leads

Diode Test

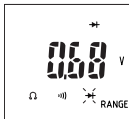

Forward-bias



Test leads

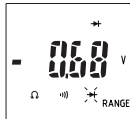

Reverse-bias

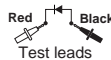

Test leads

8.11.2 Continuity Check

- <1> Turn the function switch to the Resistance position.
- <2> Plug the test leads to terminals.
- <3> Use the cursor key to select Continuity check (•)) and then press the ENTER key to confirm.

[NOTE]

At 1000 Ω range (continuity check), the buzzer turns on for resistances lower than approx. 30 Ω .

8.11.3 Diode Test

- <1> Turn the function switch to the Resistance position.
- <2> Plug the test leads to terminals.
- <3> Use the cursor key to select Diode test \rightarrow and then press the ENTER key to confirm.

[NOTE]

The "bad" is displayed when measuring a diode conducted at forward and reverse bias.

8.12 HOLD

Press the HOLD key (right side) to hold the measured value. To cancel, press the HOLD key again.

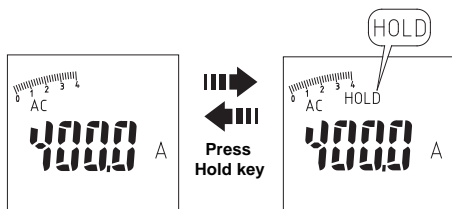

[NOTE]

On ACA mode, Press the HOLD key for more than 2 seconds for zero adjust. See also: Section 8.5 DCA ZERO

Alarm during Hold

The CW10 beeps continuously and the display will flash if the measured signal is larger than the display reading. (at Voltage, Current and Active power function)
To cancel, press the HOLD key.

8.13 Voltage Sense

WARNING

Even if Voltage Sense LED does not light, do not touch unshielded wire/cable with bare hand.

In case voltage is detected by the jaw, the red LED lights up. Ensure that the tip of the jaw touches the object wire. Take care that the tip of the jaw does not touch other wires. Use the Voltage Sense LED as an aid only if wire is energized or not.

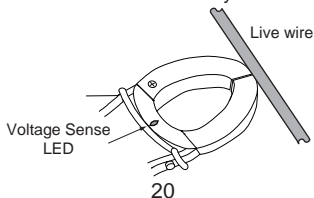

8.14 Buzzer

The CW10 beeps once for every valid key-press (operation), and beeps twice for every invalid key-press.

8.15 Additional Power-on Function

Hold one of the keys below, and turn the function switch from OFF to any position to configure various function.

Key	Configured Function
Upward of Cursor key	Display of the software version. Example: c128
Downward of Cursor key	Disable (cancel) Auto power off.
Leftward of Cursor key	Disable (cancel) Backlight.
HOLD key (ZERO)	Display all LCD symbols approx. 10 sec.

9. Battery State display and Battery Replacement

9.1 Battery State display

A decrease in the battery voltage is displayed in the following four steps.

Replace the battery as soon as the low battery (4 Replacement) indicator appears, to avoid inaccurate reading.

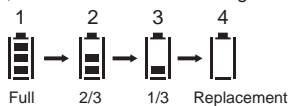

9.2 Battery Replacement



WARNING

- Turn the function switch to OFF and remove the test leads before the battery case is opened.
- Insert the battery correctly to the holder with their polarities.

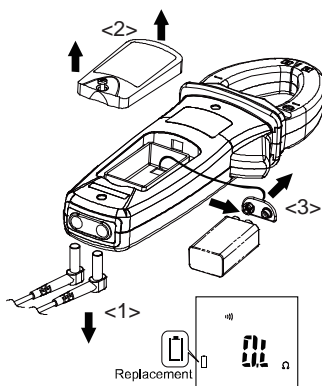

10. Specifications

10.1 General Specifications

Display count:	9999 / 6000
Measuring rate:	3 times / sec.
Over range indicator:	"OL" or "-OL"
Auto Power Off:	Approx. 15 minute.
Low-battery indicator:	 (four steps)
Power supply:	9V alkaline battery (6LR61)
Battery life:	When using alkaline battery, backlight off Approx. 20 hours
Operating temperature and humidity:	0 to 50 °C (with no condensation) ≤ 80% RH (0 to 30 °C) ≤ 75% RH (30 to 40 °C) ≤ 45% RH (40 to 50 °C)
Temperature coefficient:	At 0 to 18 °C and 28 to 50 °C Add 23±5 °C accuracy × 0.2 / °C
Storage temperature:	-10 to 50 °C, 80% RH or less (remove the battery)
Withstand voltage:	AC 6880 Vrms 5 seconds (between the core and the case) AC 4300 Vrms 5 seconds (between the core and the voltage input terminals) AC 6880 Vrms 5 seconds (between the voltage input terminals and the case)
Insulation resistance:	100 MΩ or greater at 1000 VDC (between the core and the case, the core and the voltage input terminals and the voltage input terminals and the case)
Safety standards:	EN 61010-1, EN 61010-2-033, EN 61010-2-032 1000 V CAT III, 600 V CAT IV EN 61010-031 (the test leads) Pollution degree 2, indoor use, altitude 2000m or less
EMC standards:	EN 61326-1 Class B, EN 61326-2-1, EN 61326-2-2, EMC Regulatory Arrangement in Australia and New Zealand EN 55011 Class B Group 1 Korea Electromagnetic Conformity Standard (한국 전자파적합성기준)
Environmental standard:	EN 50581 Monitoring and control instruments including industrial monitoring and control instruments
Dimensions:	Approx. 87.5 mm (W) × 242 mm (L) × 51 mm (D)
Diameter of measurable conductors:	φ 37mm (Maximum)
Weight:	Approx. 435g (including the battery)
Accessories:	Test leads 1set (Red and Black) Soft case: 93044 9V alkaline battery (6LR61) User's Manual

10.2 Accuracy

23± 5°C, 80%RH or less

Accuracy: ±(% of reading + digits)

(1) Voltage V

Rms-value detection

Function	Range	Resolution (Maximum reading)	Accuracy*
DCV	100 V	99.99 V	0.7% + 2
	1000 V	999.9 V	
ACV	100 V	99.99 V	1.0% + 5 50 ≤ f ≤ 500 Hz
	1000 V	999.9 V	
LPF ACV	100 V	99.99 V	50 ≤ f ≤ 60 Hz: 1.0% + 5 60 < f ≤ 400 Hz: 5.0% + 5
	1000 V	999.9 V	

* DCV<1000 digits: add 6 digits to accuracy

ACV<1000 digits: add 3 digits to accuracy

Maximum input voltage: 1000 Vrms, 1414.2 Vpk

Input impedance: approx. 3.5MΩ, <100pF

AC+DC accuracy = ACV accuracy + DCV accuracy

Crest factor effects

1.4 < CF ≤ 2.0: add 1.0% of reading to accuracy

2.0 < CF ≤ 2.5: add 2.5% of reading to accuracy

2.5 < CF ≤ 3.0: add 4.0% of reading to accuracy

Maximum input voltage 690 Vrms CF=2, 460Vrms CF=3

(2) Current A

Rms-value detection

Function	Range	Resolution (Maximum reading)	Accuracy
DCA	100 A	99.99 A	1.5% + 20
	600 A	600.0 A***	1.5% + 5*
ACA	100 A**	99.99 A	50 ≤ f ≤ 60 Hz: 1.5% + 5* 60 < f ≤ 400 Hz: 2.0% + 5*
	600 A	600.0 A***	
LPF ACA	100 A**	99.99 A	50 ≤ f ≤ 60 Hz: 1.5% + 5* 60 < f ≤ 400 Hz: 5.0% + 5*
	600 A	600.0 A***	

* The measured value <1000 digits: add 5 digits to accuracy

** Input current ≥ 0.10A at 100 A range of ACA and LPF ACA

*** 600 A : Guaranteed accuracy (not maximum reading)

Maximum input current: 600 Arms, 848.5Apk

Conductor position effects: ±1.0% of reading

AC+DC accuracy = ACA accuracy + DCA accuracy

Crest factor effects

1.4 < CF ≤ 2.0: add 1.0% of reading to accuracy

2.0 < CF ≤ 2.5: add 2.5% of reading to accuracy

2.5 < CF ≤ 3.0: add 4.0% of reading to accuracy

Maximum input current: 420 Arms CF=2, 280 Arms CF=3

DCA accuracy: after DCA zero adjustment

(3) Peak Hold (AC mode only)

Function	Range	Resolution (Maximum reading)	Accuracy
ACV	100 V	140.0 V	3.0% + 15
	1000 V	1400 V	
ACA	100 A	140.0 A	3.0% + 15
	600 A	850 A	

PEAK MAX: polarity+, polarity-

Maximum input voltage and current: 1000 Vrms, 600 Arms

Sine wave, ACV > 5 Vrms, ACA ≥ 5 Arms, 50 to 400 Hz continuous wave

(4) Frequency (Hz)

Function	Resolution (Measuring reading)	Accuracy
100 Hz	20.00 to 99.99 Hz	0.5% + 3
1000 Hz	20.0 to 999.9 Hz	
10 kHz	0.020 to 9.999 kHz	

Maximum input voltage and current: 1000 Vrms, 600 Arms

Input condition; (Sine wave)

100 V range: 10 to 100 Vrms

1000 V range: 100 to 1000 Vrms

100 A range: 10 to 100 Arms (< 400 Hz)

600 A range: 100 to 600 Arms (< 400 Hz)

The measured value < approx. 10 Hz: 0.00Hz

(5) Harmonic Measurement

Individual Harmonic

Harmonic order	Resolution (Maximum reading)	Accuracy
1st to 12th (h01-h12)	99.9 %	5% + 10
13th to 25th (h13-h25)		10% + 10

Maximum input voltage and current: 1000 Vrms, 600 Arms

The "rdy" is displayed at ACV < 10 Vrms, ACA < 10 Arms

The "OutF" is displayed at $f < 45$ to $65 < f$ (f: fundamental frequency)

(6) Inrush Current

Function	Range	Resolution (Maximum reading)	Accuracy
ACA	100 A	99.99 A	2.5% + 20
	600 A	600.0 A*	2.5% + 5

Maximum input current: 600 Arms

* 600 A : Guaranteed accuracy (not maximum reading)

100A range: ACA ≥ 10 Arms (Sine wave, 50Hz/60Hz)

600A range: ACA ≥ 100 Arms (Sine wave, 50Hz/60Hz)

Measurement time: approx. 100ms

(7) Active Power W

Function	Range	Resolution (Maximum reading)	Accuracy
ACW DCW	10 kW	9.999 kW*	ACW : 2.5% + 11*** DCW : 2.2% + 22***
	100 kW	99.99 kW	
	600 kW	600.0 kW**	

* The measured value < 1.000 kW: add 10 digits to the accuracy.

** 600 kW: Guaranteed accuracy (not maximum reading)

*** Conditions of accuracy (combination of Voltage and Current range)

10 kW range: 100 V and 100 A

100 kW range: 100 V and 600 A or 1000 V and 100 A

600 kW range: 1000 V and 600 A

Other combinations:

Accuracy: (Current accuracy × Voltage reading) +
(Voltage accuracy × Current reading)

Maximum input voltage and current: 1000 Vrms, 600 Arms

ACW : ACV ≥ 10 Vrms and ACA ≥ 5 Arms

(Sine wave, 50 ≤ f ≤ 60 Hz, PF = 1.00)

DCW : at DCV ≥ 10 V and DCA ≥ 5 A, after DCA zero adjustment

(8) Power Factor

Function	Resolution (Measuring reading)	Accuracy
Power factor	-1.00 to 0.00 to 1.00	±(3° + 2 digits)

Maximum input voltage and current: 1000 Vrms, 600 Arms

PF: ACV ≥ 10 Vrms and ACA ≥ 5 Arms (Sine wave, 50 ≤ f ≤ 60 Hz)

(9) Resistance/Continuity check Ω

Function	Range	Resolution (Maximum reading)	Accuracy
Resistance Ω	1000 Ω	999.9 Ω	1.0% + 5
	10 k Ω	9.999 k Ω	1.0% + 3
	100 k Ω	99.99 k Ω	
Continuity check	1000 Ω	999.9 Ω	1.0% + 5
	The buzzer turns on for resistances lower than approx. 30 Ω . (Response time: approx. 100 ms)		

Maximum input voltage: 1000 Vrms

Maximum test current: approx. 0.5 mA

Open circuit voltage: approx. 3 V

(10) Diode Test Ω

Function	Resolution (Measuring reading)	Accuracy
Diode Test	0.40 to 0.80 V	±0.1 V

Maximum test current: approx. 0.5 mA

Open circuit voltage: approx. 1.8 V

11. Maintenance and After-Sales Service

Please direct question about this product to the contact listed on the “Inquiries” or to your nearest Yokogawa dealer.

Recommended calibration period: 1 year

12. Sales in Each Country or Region

12.1 Disposing the Product

Waste Electrical and Electronic Equipment (WEE), Directive

(This directive is valid only in the EU.)

This product complies with the WEEE directive marking requirement.

This marking indicates that you must not discard this electrical/ electronic product in domestic household waste.

Product Category

With reference to the equipment types in the WEEE directive, this product is classified as a “Monitoring and Control instrumentation” product.

When disposing products in the EU, contact your local Yokogawa Europe B.V. office.

Do not dispose in domestic household waste.



12.2 How to Replace and Dispose the Batteries

EU Battery Directive

(This directive is valid only in the EU.)

Batteries are included in this product.

When you remove batteries from this product and dispose them, discard them in accordance with domestic law concerning disposal.

Take a right action on waste batteries, because the collection system in the EU on waste batteries are regulated.

Battery type: Alkaline dry cell



Notice:

This marking indicates they shall be sorted out and collected as ordained in the EU battery directive.

How to remove batteries safely:

For further details, see “9.2 Battery Replacement”.

12.3 Authorized Representative in the EEA

Yokogawa Europe B.V. is the authorized representative of Yokogawa Test & Measurement Corporation for this product in the EEA. (EEA: European Economic Area)

To contact Yokogawa Europe B.V., see the separate list of worldwide contacts, PIM 113-01Z2.

12.4 For the Pollution Control of Electronic and Electrical Products of the People's Republic of China

They are applicable only in China.

产品中有害物质的名称及含量

部件名称	有害物质					
	铅 (Pb)	汞 (Hg)	镉 (Cd)	六价铬 (Cr (VI))	多溴联苯 (PBB)	多溴二苯醚 (PBDE)
框架 (塑料)	×	○	○	○	○	○
线路板 ASSY	×	○	○	○	○	○
导线	×	○	○	○	○	○
电池	×	○	○	○	○	○

- ：表示该有害物质在该部件所有均质材料中的含量均在 GB/T 26572 规定的限量要求以下。
- ×：表示该有害物质至少在该部件的某一均质材料中的含量超出 GB/T 26572 规定的限量要求。

环保使用期限：



该标识适用于 SJ/T 11364 中所述，在中华人民共和国销售的电子电气产品的环保使用期限。

只要您遵守该产品相关的安全及使用注意事项，在自制造日起算的年限内，则不会因产品中有害物质泄漏或突发变异，而造成对环境的污染或对人体及财产产生恶劣影响。

注)

该年数为“环保使用期限”，并非产品的质量保证期。

零件更换的推荐周期，请参照使用说明书。

■ Notice Regarding This Manual

- Every effort has been made to ensure accuracy in the preparation of this manual. However, should any errors or omissions come to the attention of the user, please contact Yokogawa.
- The contents of this manual is subject to change without prior notice because of improvement in performance or function.
- All rights reserved. No part of this manual may be reproduced in any form without Yokogawa's written permission.

YOKOGAWA ◆

横河計測株式会社

Yokogawa Test & Measurement Corporation

各国や地域の当社営業拠点の連絡先は、
下記シートに記載されています。

PIM 113-01Z2: お問い合わせ先 国内海外の連絡先一覧

Contact information of Yokogawa offices worldwide is
provided on the following sheet.

PIM 113-01Z2: Inquiries List of worldwide contacts

Compliance with the Radio Waves Act (Republic of Korea)

This product complies with the Radio Waves Act (Republic of Korea).
Note the following when using the product in Republic of Korea.

The product is for domestic use (Class B) and meets
the electromagnetic compatibility requirements.

Registration No: KCC-REM-IMY-EEN301

Equipment Name: Clamp-on Power Meter

Trade Name: Yokogawa Test & Measurement Corporation

Manufacturer: Yokogawa Test & Measurement Corporation

Country of Origin: Taiwan

