

SD 01C27E10-01EN

Unit: mm (approx. inch)

● EJX310B and EJX430B with Wetted parts material code: S

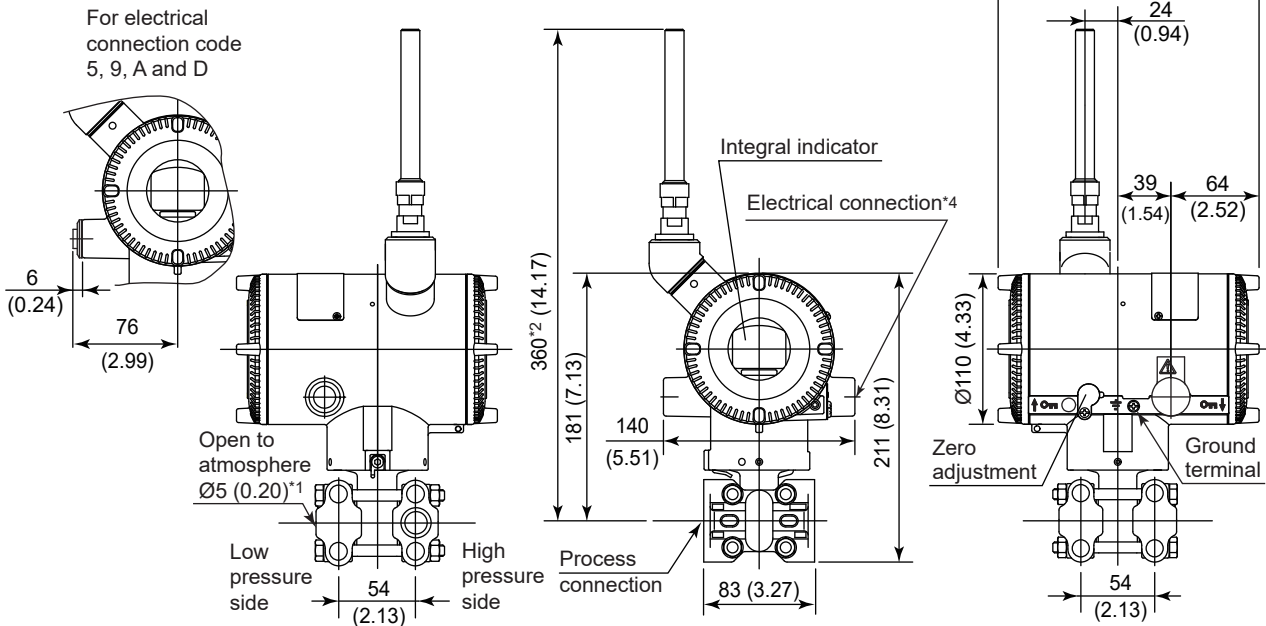

● EJX430B with Wetted parts material code: H, M, and T

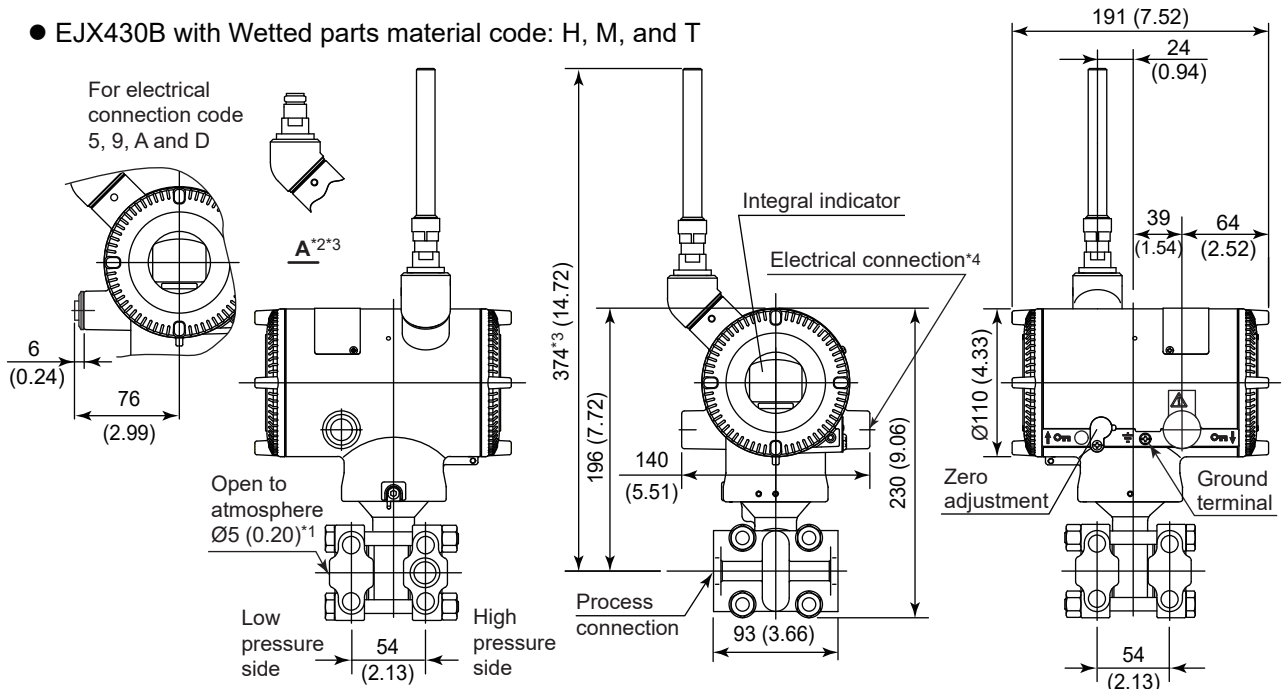

*1: Applicable for EJX430B.

*2: When amplifier housing code 9 is selected, the value is 240 mm (9.45 inch). In this case, the figure is shown as A.

*3: When amplifier housing code 9 is selected, the value is 254 mm (10.00 inch). In this case, the figure is shown as A.

*4: Applicable for the external powered type.

*5: When electrical connection code 7 or C is selected, a blind plug is protruded upto 8 mm from the electrical connection.

- Infrared Configuration

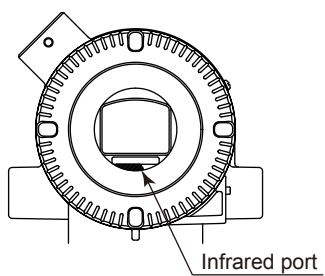

- Terminal Configuration for the External Powered type

