**User's
Manual**

**DM7560
Digital Multimeter
Getting Started Guide**

Product Registration

Thank you for purchasing YOKOGAWA products.

YOKOGAWA provides registered users with a variety of information and services. Please allow us to serve you best by completing the product registration form accessible from our website.

<http://tmi.yokogawa.com/>

Thank you for purchasing the DM7560 Digital Multimeter.
This getting started guide primarily explains the handling precautions and basic operations of the DM7560. To ensure correct use, please read this manual thoroughly before operation.
Keep this manual in a safe place for quick reference in the event that a question arises.

List of Manuals

The following manuals, including this one, are provided as manuals for the DM7560. Please read all manuals.

Manual Title	Manual No.	Description
DM7560 Digital Multimeter User's Manual	IM DM7560-01EN	The supplied CD contains the PDF file of this manual. The manual explains all DM7560 features, except for the communication features, and how to use them.
DM7560 Digital Multimeter Getting Started Guide	IM DM7560-02EN	This guide. It explains the handling precautions and specifications of the DM7560.
DM7560 Digital Multimeter Communication Interface User's Manual	IM DM7560-17EN	The supplied CD contains the PDF file of this manual. The manual explains the DM7560 communication interface features and instructions on how to use them.
DM7560 Digital Multimeter User's Manual	IM DM7560-92Z1	Document for China

The "EN" and "Z1" in the manual numbers are the language codes.

Contact information of Yokogawa offices worldwide is provided on the following sheet.

Document No.	Description
PIM 113-01Z2	List of worldwide contacts

Notes

- The contents of this manual are subject to change without prior notice as a result of continuing improvements to the instrument's performance and functions. The figures given in this manual may differ from those that actually appear on your screen.
- Every effort has been made in the preparation of this manual to ensure the accuracy of its contents. However, should you have any questions or find any errors, please contact your nearest YOKOGAWA dealer.
- Copying or reproducing all or any part of the contents of this manual without the permission of YOKOGAWA is strictly prohibited.
- Since the display panel of this instrument contains a fluorescent tube, when discarding it, be sure to comply with the appropriate dumping regulations.

Trademarks

- Microsoft, Internet Explorer, Windows 7, Windows 8.1, and Windows 10 are either registered trademarks or trademarks of Microsoft Corporation in the United States and/or other countries.
- Adobe and Acrobat are either registered trademarks or trademarks of Adobe Systems Incorporated.
- In this manual, the ® and TM symbols do not accompany their respective registered trademark or trademark names.
- Other company and product names are trademarks or registered trademarks of their respective holders.

Revisions

- September 2016: 1st Edition
- October 2017 : 2nd Edition

Checking the Contents of the Package

Unpack the box, and check the contents before operating the instrument. If the wrong items have been delivered, if items are missing, or if there is a problem with the appearance of the items, contact your nearest YOKOGAWA dealer.

DM7560

Check that the product that you received is what you ordered by referring to the model name and suffix code given on the name plate on the rear panel.

MODEL	Suffix ¹	Description
DM7560		Main device
Power voltage	-1	100 VAC, 50/60 Hz
	-3	115 VAC, 50/60 Hz
	-6	220 VAC, 50/60 Hz
	-8	240 VAC, 50/60 Hz
Power cord ²	-D	UL/CSA Standard power cord, Maximum rated voltage: 125 V
	-F	VDE Standard power cord, Maximum rated voltage: 250 V
	-Q	BS Standard power cord, Maximum rated voltage: 250 V
	-R	AS Standard power cord, Maximum rated voltage: 250 V
	-H	GB Standard power cord, Maximum rated voltage: 250 V
	-N	NBR Standard power cord, Maximum rated voltage: 250 V
Option	/C1 ³	GP-IB Interface
	/C2 ³	LAN & RS-232 Interface
	/CMP	DIO Interface

- 1 For products whose suffix code contains "Z," an exclusive manual may be included. Please read it along with the standard manual.
- 2 Make sure that the attached power cord meets the designated standards of the country and area that you are using it in.
- 3 The/C1 and/C2 options cannot be installed on the same instrument.

No. (Instrument Number)

When contacting the dealer from which you purchased the instrument, please give them the instrument number.

Standard Accessories

The standard accessories below are supplied with the instrument. Check that all contents are present and undamaged.

Fuses for current measurement (B8509LK)	2 pieces for each(3A, 250V)
(The above-mentioned accessories are storage in the main unit to another.)	
Test leads(red, black)	1 couple
Power code	1
A1006WD	UL, CSA, and PSE standard
A1009WD	VDE standard
A1054WD	BS standard
A1024WD	AS standard
A1064WD	GB standard
A1088WD	NBR standard
Instruction manual(CD)	1
User's Manual.pdf (IM DM7560-01EN)	
Communication Interface.pdf (IM DM7560-17EN)	
IM DM7560-02EN (This manual)	1
IM DM7560-02JA (Japanese)	1
IM DM7560-92Z1 (Document for China)	1
PIM 113-01Z2 (List of worldwide contacts).....	1

Manual CD

The English folder in the manual CD contains the PDF files shown below. The CD also contains Japanese manuals.

File Name	Manual Title	Manual No.
Users Manual.pdf	DM7560 Digital Multimeter Use's Manual	IM DM7560-01EN
Communication Interface.pdf	DM7560 Digital Multimeter Communication Interface User's Manual	IM DM7560-17EN

To view the PDF files above, you need Adobe Reader 5.0 or later.

WARNING

Never play this manual CD, which contains the user's manuals, in an audio CD player. Doing so may cause loss of hearing or speaker damage due to the large sounds that may be produced.

French

AVERTISSEMENT

Ce CD contient les manuels d'utilisation. Ne jamais insérer ce CD dans un lecteur de CD audio. Cela pourrait entraîner une perte d'audition ou l'endommagement des enceintes en raison du volume potentiellement élevé des sons produits.

Optional Accessories (Sold Separately)

The optional accessories below are available for purchase separately. Check that all contents are present and undamaged.

- Use the accessories specified in this manual. Moreover, use the accessories of this product only with Yokogawa products that specify them as accessories.
- Use the accessories of this product within the rated range of each accessory. When using several accessories together, use them within the specification range of the accessory with the lowest rating.









Name	Model	Safety standard	Note	Manual No.
Test lead	B8509LJ	1000V CAT II	Standard accessory	—
Measurement lead	758917	1000V CAT II 600V CAT III	Safety terminal cable. Length: 0.75 m. Red and black, 1 pc. each	—
Measurement lead	758933	1000V CAT III	Safety terminal cable. Length: 1 m. Red and black, 1 pc. each	—
Small alligator clip adapter	758922	300V CAT II	Safety terminal-to-alligator clip adapter. Red and black, 1 pc. each	—
Large alligator clip adapter	758929	1000V CAT II	Safety terminal-to-alligator clip adapter. Red and black, 1 pc. each	—
Safety terminal adapter	758923	600V CAT II	Spring clamp type. Red and black, 1 pc. each	—
Safety terminal adapter	758931	1000V CAT III	Screw-in type. Red and black, 1 pc. each	—
Sheath type thermocouple	90050	—	-50°C to 600°C for liquid	IM 90050
Sheath type thermocouple	90051	—	-50°C to 600°C for liquid	IM 90050
Static surface type thermocouple	90055	—	-20°C to 250°C for surface	IM 90050
Static surface type thermocouple	90056	—	-20°C to 500°C for surface	IM 90050
Clamp-on probe	96095	300V CAT III	AC/DC clamp-on probe	IM 96095-EN

Safety Precautions









This instrument is an IEC safety class I instrument (provided with a terminal for protective earth grounding).

The general safety precautions described herein must be observed during all phases of operation. If the instrument is used in a manner not specified in this manual, the protection provided by the instrument may be impaired. YOKOGAWA assumes no liability for the customer's failure to comply with these requirements.

The following symbols are used on this instrument.

-  Warning: handle with care. Refer to the user's manual or service manual. This symbol appears on dangerous locations on the instrument which require special instructions for proper handling or use. The same symbol appears in the corresponding place in the manual to identify those instructions.
-  Risk of electric shock
-  Protective ground or protective ground terminal
-  Ground or the functional ground terminal (do not use as the protective earth ground terminal)
-  Frame Ground
-  Alternating current
-  ON (power)
-  OFF (power)

French

-  Avertissement : À manipuler délicatement. Toujours se reporter aux manuels d'utilisation et d'entretien. Ce symbole a été apposé aux endroits dangereux de l'instrument pour lesquels des consignes spéciales d'utilisation ou de manipulation ont été émises. Le même symbole apparaît à l'endroit correspondant du manuel pour identifier les consignes qui s'y rapportent.
-  Risque de choc électrique
-  Mise à la terre de protection ou borne de mise à la terre de protection
-  Borne de terre ou borne de terre fonctionnelle (ne pas utiliser cette borne comme prise de terre.)
-  Terre de Frame
-  Courant alternatif
-  Marche (alimentation)
-  Arrêt (alimentation)

Failure to comply with the precautions below could lead to injury or death or damage to the instrument.

WARNING**Use the Instrument Only for Its Intended Purpose**

This instrument is a measurement instrument that can measure voltage, current, and resistance. Do not use this instrument for anything other than as a measurement instrument.

Check the Physical Appearance

Do not use the instrument if there is a problem with its physical appearance.

Do Not Operate in an Explosive Atmosphere

Do not operate the instrument in the presence of flammable gases or vapors. Doing so is extremely dangerous.

Do Not Remove the Covers or Disassemble or Alter the Instrument

Only qualified YOKOGAWA personnel may remove the covers and disassemble or alter the instrument. The inside of the instrument is dangerous because parts of it have high voltages.

Measurement Category

The measurement category of the DM7560 signal input terminals is Other (O, 1100V) or II (300V). Do not use it to measure the main power supply or for Measurement Categories II, III, and IV when use the input terminal for 1100V, and Measurement Categories III and IV when use the input terminal for 300V.

Install or Use the Instrument in Appropriate Locations

- Do not install or use the instrument outdoors or in locations subject to rain or water.
- Install the instrument so that you can immediately remove the power cord if an abnormal or dangerous condition occurs.

In the event of smoke, abnormal odors or abnormal sounds, immediately turn the power off and unplug the power plug from the receptacle.

Continued use under these circumstances may result in electric shock or fire. After the power switch has been put in the OFF position, and the power plug has been disconnected from the power outlet, contact your nearest YOKOGAWA dealer. Repairing the instrument yourself is very dangerous. Do not attempt to repair the instrument under any circumstances.

Ensure that water does not get on or inside the instrument.

Do not use the instrument if this happens. Failure to observe this precaution may result in electric shock or fire. If water gets on or inside the unit, after the power switch has been put in the OFF position, and the power plug has been disconnected from the power outlet, contact your nearest YOKOGAWA dealer.

Do not touch the power cord plug with wet hands

This may result in an electric shock.

Do not put any foreign objects, such as metallic or flammable objects through the ventilation port.

If any foreign object is put through the ventilation port, this may result in electric shock, fire, and/or malfunction. If any foreign object enters the instrument, after the power switch has been put in the OFF position, and the power plug has been disconnected from the power outlet, and contact your nearest YOKOGAWA dealer.

Do not place this instrument in an unstable location such as on an unsteady stand or an inclined place.

If the instrument is placed in an unstable location, it may fall or topple over, resulting in electric shock, fire or injury. If this instrument falls or its cover is damaged, after the power switch has been put in the OFF position, and the power plug has been disconnected from the power outlet, and contact your nearest YOKOGAWA dealer.

Be careful when taking high-voltage measurements.

Coming into contact with high voltages during measurements may result in electric shock.

Except for the input terminal for measurement on the front of this instrument, always connect the grounding line of the input connector of this instrument to the ground potential level (ground) of the object to be measured.

If the grounding line of the above-mentioned input connector of this instrument is connected to a level other than the ground level of the object to be measured, this may result in electric shock (damage to the object to be measured, this instrument, or other connected devices).

Always use a 3-prong power cord

Failing to use a 3-prong power cord may result in electric shock, fire, or malfunction. When supplying power via a three-wire power outlet using the 3-prong power cord accessory, ground the cord using the ground wire.

Always use a 3-prong power cord compatible with the power voltage.

Using a power cord that is incompatible with the power voltage may result in fire or malfunction.

Do not use the power cord provided with instrument for other products.

In accordance with electrical safety regulations, the power cord provided with this instrument is not to be used with other electrical equipment.

Use the instrument at a rated supply voltage.

Before connecting the power cord, ensure that the source voltage matches the rated supply voltage of the instrument and that it is within the maximum rated voltage of the provided power cord. The power supply voltages that can be used are shown in Table 1. The center voltages are displayed near the AC LINE INPUT on the rear panel.

Table1 Power supply voltage range

Center voltage	Voltage range
AC 100V	90V - 110V
AC 115V	103.5V – 126.5V
AC 220V	198V - 242V
AC 240V	216V - 264V

Do not touch the input terminal mid operation.

Touching the input terminal mid operation may result in electric shock.

Follow the rules below when handling the power cord.

Failing to follow these rules may result in electric shock, fire, or malfunction. If the power cord is damaged, contact your nearest YOKOGAWA dealer.

- Do not attempt to modify the power cord.
- Do not forcibly bend the power cord.
- Do not twist the power cord.
- Do not bind the power cord.
- Do not yank the power cord.
- Do not heat the power cord.
- Do not allow the power cord to become wet.
- Do not place heavy objects on top of the power cord.

Confirm that there is no dust on the power plug, and then insert it securely into the receptacle. In addition, every six months to a year, remove the power plug and the power adapter from the receptacle and check and clean them.

Dust may result in electrical shock, fire, or malfunction.

Metal objects and the like must not touch the power plug blades.

This may cause electric shock, fire, or malfunction.

Put the power switch in the OFF position before connecting or disconnecting the power cord.

Connecting or disconnecting the power cord while the power switch is ON may result in electric shock or malfunction.

When disconnecting the power cord from the receptacle, hold the plug to pull it out.

Pulling the power cord may result in electric shock or fire.

When the power cord or test lead is connected to this instrument, be careful not to topple this instrument by pulling on the cord or test lead.

Toppling this instrument may result in electric shock, injury, or fire.

Do not use a damaged power cord, test lead, or adapter.

Using a damaged power cord, test lead, or adapter may result in electric shock, fire, or malfunction.

Do not use multiple-connection outlets.

Power strips and other multiple-connection outlets may cause fire or overheating.

Do not place containers of water or chemicals, small metal objects, and the like near this instrument.

If the contents are spilled and enter the instrument, it may cause electric shock, fire, or malfunction. If water, chemicals, or metal objects enter the instrument, set the power switch to the OFF position (the state of "O"; The switch is convex), and remove the plug from the outlet, and then contact your nearest YOKOGAWA dealer for repair

Do not place this instrument in an area where frequent vibrations or impacts occur.

If this instrument is dropped or overturned, it may cause a physical injury or malfunction.

Before transporting this instrument, remove all devices under testing, probes, and cables, and then grasp the center of the unit with both hands and carry it carefully to avoid dropping.

If this instrument is dropped, it may result in a physical injury or property damage.

Do not stack anything on top of this instrument.

Doing so will cause the cover to come into contact with the internal circuitry, which may result in electric shock, fire, or malfunction.

Do not place this instrument under direct sunlight or a location where humidity is high.

Doing so will cause the internal temperature rise and may lead to a fire.

Use a specified fuse (accessory: ratings 3 A and 250 V) when you exchange fuses.

Never use a fuse with different ratings.

Doing so may cause a fire or malfunction.

If you use up the accessory fuse or lose it, contact your nearest YOKOGAWA dealer.

Do not use or store this instrument in a location that is humid (bathroom, etc.) or dusty.

Placing it in a humid or dusty location may cause an electric shock, fire, or malfunction.

Do not place this instrument next to a worktable or humidifier, where it may be exposed to oily smoke or steam.

Doing so may cause an electric shock, fire, or malfunction.

Safety Precautions

Do not place any objects close to the ventilation port or fan of this instrument.

If any object is placed close to the ventilation port or fan of this instrument, the air ventilation is blocked, causing the internal temperature to increase. This can cause a fire or malfunction.

Put the power switch in the OFF position, and pull the power plug from the outlet when a thunderstorm is near.

Thunderbolts can cause electric shock, fire, or malfunction.

Do not use this instrument if it is not functioning correctly.

Using a malfunctioning instrument (due to dropping, etc.) may cause an electric shock or a fire. If the instrument is not functioning correctly, set the power switch to the OFF position, remove the plug from the outlet, and then contact your nearest YOKOGAWA dealer.

When voltage is being applied to the LO terminal, do not connect it to the ground terminal of another measuring device.

The LO terminal is not grounded and is just floating. If voltage is being applied to the LO terminal, connecting it to the ground terminal of another measuring device may result in fire or damage.

Do not apply a voltage exceeding the specifications between the LO terminal and the ground.

The specified voltage is ± 500 Vpeak. Applying excessive voltage may cause fire or damage.

Do not apply a voltage or current exceeding the specifications to the input terminal.

Applying a voltage/current exceeding the specifications may result in fire or damage.

The maximum permissible inputs are shown in Table 2 and Table 3.

Table 2. Maximum permissible inputs (Front panel)

Input terminal	Function ¹	Max. permissible input
INPUT V • Ω • \rightarrow HI-LO ²	DCV (100 mV to 100 V range) 2W Ω , 4W Ω , CONT, DIOD, TEMP	800 Vpeak (continuous), 1100 Vpeak (1 min.)
	DCV (1000V range)	1100 Vpeak (continuous)
	ACV, FREQ	750 Vrms and ± 500 VDC or less ³
SENSE 4W Ω HI-LO	4W Ω , TEMP (RTD)	200 Vpeak
I-LO	DCI, ACI	3 A (DC or rms, continuous)
		(250 V)

1 For the names of the corresponding functions, see the functions in section 4.3, "Measurement function" in IM DM7560-01EN.

2 For measurement in measurement category II (CAT II), the maximum permissible input is 300 V.

3 The maximum permissible input for the AC voltage component superimposed on the DC component is 1100 Vpeak.

Table 3. Maximum permissible inputs (Rear panel)

Parts (Standard/Option)	Input terminal	Max. permissible input (Voltage)
Rear panel (Standard equipment)	TRIG IN	0 to 5 V
Rear panel (When DIO option/CMP is installed)	INH IN	0 to 5 V

Do not apply voltage to the COMPLETE output terminal (BNC) on the rear panel.

It can cause a fire or malfunction.

Do not apply voltage or current exceeding the specifications to the contact output of the DIO option/CMP on the rear panel.

It can cause a fire or malfunction. The specifications of HI, GO, LO, and COMPLETE are as follows:

- Withstand voltage between terminals: 42 Vpeak
- Withstand voltage to ground: ± 42 Vpeak
- Maximum allowed current: 100 mA

Prior to maintenance, unplug the power plug from the outlet for safety reasons. Use a cloth to wipe away any moisture.

Cleaning this instrument while the power plug is connected to the outlet or while the instrument is wet may cause an electric shock or a malfunction.

Do not use the instrument without cleaning the interior for a long term.

Long-term use of the instrument with dirty or dusty interior may cause a fire or injury. We recommend that you contact your nearest YOKOGAWA dealer to have the interior cleaned about once a year.

French

AVERTISSEMENT

Utiliser l'instrument exclusivement pour l'usage auquel il est destiné

Cet instrument est un instrument de mesure qui peut mesurer la tension, le courant et la résistance. Ne pas utiliser cet instrument à des fins différentes de celles d'un instrument de mesure.

Inspecter l'apparence physique

Ne pas utiliser l'instrument si son intégrité physique semble être compromise.

Ne pas utiliser dans un environnement explosif

Ne pas utiliser l'instrument en présence de gaz ou de vapeurs inflammables. Cela pourrait être extrêmement dangereux.

Ne pas retirer le capot, ni démonter ou modifier l'instrument

Seul le personnel YOKOGAWA qualifié est habilité à retirer le capot et à démonter ou modifier l'instrument. Certains composants à l'intérieur de l'instrument sont à haute tension et par conséquent, représentent un danger.

Catégorie de mesure

La catégorie de mesure des bornes d'entrée de signal du DM7560 est Autre (0, 1100 V) ou II (300 V). Ne pas l'utiliser pour mesurer l'alimentation électrique ni pour les catégories de mesure II, III et IV lors de l'utilisation de la borne d'entrée pour 1100 V et les catégories de mesure III et IV lors de l'utilisation de la borne d'entrée pour 300 V.

Installer et utiliser l'instrument aux emplacements appropriés

- Ne pas installer, ni utiliser l'instrument à l'extérieur ou dans des lieux exposés à la pluie ou à l'eau.
- Installer l'instrument de manière à pouvoir immédiatement le débrancher du secteur en cas de fonctionnement anormal ou dangereux.

En présence de fumée, d'odeurs anormales ou de bruits anormaux, couper immédiatement l'alimentation et débrancher la fiche d'alimentation du boîtier.

Une utilisation continue dans ces conditions peut provoquer un choc électrique ou un incendie. Après avoir mis l'interrupteur en position OFF (hors tension) et débranché la fiche d'alimentation de la prise de courant, contacter le revendeur YOKOGAWA le plus proche. Il est dangereux de réparer soi-même l'instrument. Ne tenter sous aucun prétexte de réparer l'instrument.

Veiller à ce que de l'eau n'entre pas en contact avec l'instrument ni ne pénètre à l'intérieur.

Ne pas utiliser l'instrument si cela se produit. Le non-respect de cette précaution peut provoquer un choc électrique ou un incendie. Si de l'eau entre en contact avec l'unité ou pénètre à l'intérieur de l'unité après avoir mis l'interrupteur en position OFF (hors tension) et débranché la fiche d'alimentation de la prise de courant, contacter le revendeur YOKOGAWA le plus proche.

Ne pas toucher le cordon d'alimentation avec les mains humides

Ceci peut provoquer un choc électrique.

Ne pas faire pénétrer de corps étrangers tels que objets métalliques ou inflammables à travers l'orifice d'aération.

Un choc électrique, un incendie et/ou un dysfonctionnement peuvent se produire si un corps étranger pénètre à travers l'orifice d'aération. Si un corps étranger pénètre à l'intérieur de l'instrument après avoir mis l'interrupteur en position OFF (hors tension) et débranché la fiche d'alimentation de la prise de courant, contacter le revendeur YOKOGAWA le plus proche.

Ne pas placer cet instrument dans une position instable, par ex. sur un support instable ou une surface inclinée.

Si l'instrument est dans une position instable, il peut basculer ou tomber et provoquer un choc électrique, un incendie ou des lésions corporelles. Si cet instrument tombe ou si son couvercle s'est détérioré après avoir mis l'interrupteur en position OFF (hors tension) et débranché la fiche d'alimentation de la prise de courant, contacter le revendeur YOKOGAWA le plus proche.

Faire attention lors de la mesure de tensions élevées.

Un contact avec des tensions élevées pendant les mesures peut provoquer un choc électrique.

En excluant la borne d'entrée pour la mesure de cette face de l'instrument, toujours relier la ligne de mise à la terre du connecteur d'entrée de cet instrument au niveau du potentiel de terre (terre) d'un objet à mesurer.

Si la ligne de mise à la terre du connecteur d'entrée mentionné ci-dessus de cet instrument est reliée à un niveau différent du niveau du sol de l'objet à mesurer, ceci peut provoquer un choc électrique (détérioration de l'objet à mesurer, de cet instrument ou d'autres dispositifs raccordés).

Toujours utiliser un cordon d'alimentation à 3 broches

L'utilisation d'un cordon d'alimentation différent peut provoquer un choc électrique, un incendie ou un dysfonctionnement.

Lors de l'alimentation électrique via une sortie à trois fils à l'aide du cordon électrique à 3 broches, mettre le cordon à la terre à l'aide du câble de terre.

Toujours utiliser un cordon d'alimentation à 3 broches compatible avec la tension d'alimentation.

L'utilisation d'un cordon d'alimentation incompatible avec la tension d'alimentation peut provoquer un incendie ou un dysfonctionnement.

Ne pas utiliser le cordon d'alimentation fourni avec l'instrument pour d'autres produits.

Conformément à la réglementation en matière de sécurité électrique, le cordon d'alimentation fourni avec cet instrument ne doit pas être avec d'autres équipements électriques.

Utiliser l'instrument à la tension d'alimentation nominale.

Avant de brancher le cordon d'alimentation, vérifier que la tension de la source d'alimentation correspond à la tension d'alimentation nominale de l'instrument et qu'elle est compatible avec la tension nominale maximale du cordon d'alimentation fourni. Les tensions d'alimentation électrique pouvant être utilisées sont indiquées dans le Tableau 1. Les tensions médianes s'affichent près de l'ENTRÉE DE LA LIGNE CA sur le panneau arrière.

Tableau1 Plage de tension d'alimentation

Tension médiane	Plage de tension
CA 100 V	90 V - 110 V
CA 115 V	103,5 V – 126,5 V
CA 220 V	198 V - 242 V
CA 240 V	216 V - 264 V

Ne pas toucher la commande intermédiaire de la borne d'entrée.

Un contact avec la commande intermédiaire de la borne d'entrée peut être à l'origine d'un choc électrique.

Respecter les instructions ci-dessous lors de la manipulation du cordon d'alimentation.

Le non-respect de ces instructions peut provoquer un choc électrique, un incendie ou un dysfonctionnement. Si le cordon d'alimentation est endommagé, contacter le revendeur YOKOGAWA le plus proche.

- Ne pas tenter de modifier le cordon d'alimentation.
- Ne pas plier par la force le cordon d'alimentation.
- Ne pas tordre le cordon d'alimentation.
- Ne pas lier le cordon d'alimentation.
- Ne pas tirer sur le cordon d'alimentation.
- Ne pas chauffer le cordon d'alimentation.
- Éviter d'exposer le cordon d'alimentation à l'humidité.
- Ne pas poser d'objets lourds à l'extrémité du cordon d'alimentation.

Vérifier qu'il n'y a pas de poussière sur la fiche avant de l'introduire dans le boîtier. En outre, retirer la fiche et l'adaptateur du boîtier et les contrôler/nettoyer une fois tous les six mois ou une fois par an.

La poussière peut provoquer un choc électrique, un incendie ou un dysfonctionnement.

Le métal ne doit pas entrer en contact avec la lame de la fiche.

Ceci peut provoquer un choc électrique, un incendie ou un dysfonctionnement.

Mettre l'interrupteur en position OFF (hors tension) avant de brancher ou de débrancher le cordon d'alimentation.

Le branchement ou le débranchement du cordon d'alimentation lorsque l'interrupteur est en position ON (sous tension) peut provoquer un choc électrique ou un dysfonctionnement.

En débranchant le cordon d'alimentation du boîtier, saisir la fiche pour la sortir.

Le fait de tirer sur la fiche peut provoquer un choc électrique ou un incendie.

En branchant le cordon d'alimentation ou le fil d'essai à cet instrument, les tirer délicatement pour éviter de renverser l'instrument.

Le renversement de cet instrument peut provoquer un choc électrique, des lésions corporelles ou un incendie.

Ne pas utiliser un cordon d'alimentation, un câble d'essai ou un adaptateur détérioré.

L'utilisation d'un cordon d'alimentation, d'un câble d'essai ou d'un adaptateur détérioré, peut provoquer un choc électrique, un incendie ou un dysfonctionnement.

Ne pas utiliser de multiprises.

Les multiprises et autres raccordements multiples peuvent provoquer un incendie ou une surchauffe.

Ne pas poser de récipients contenant de l'eau ou des produits chimiques, de petits objets en métal, etc., près de cet instrument.

Si leur contenu se disperse et pénètre dans l'instrument, cela peut provoquer un choc électrique, un incendie ou un dysfonctionnement. Si de l'eau, des produits chimiques ou des objets en métal pénètrent dans l'instrument, mettre l'interrupteur en position OFF (état « O », l'interrupteur est convexe), débrancher la fiche de la prise et contacter le bureau Iwatsu ou nos revendeurs pour le réparer.

Ne pas mettre cet instrument dans un endroit exposé à des vibrations ou des chocs fréquents.

Si cet instrument tombe ou est renversé, cela peut provoquer des lésions corporelles ou un dysfonctionnement.

Avant de transporter cet instrument, enlever tous les dispositifs en cours de test, les sondes et les câbles, saisir ensuite l'unité par la partie centrale avec les deux mains et la déplacer délicatement en évitant de la faire tomber.

Si cet instrument tombe, cela peut provoquer des lésions corporelles ou des dégâts matériels.

Ne rien poser sur cet instrument.

Le couvercle pourrait entrer en contact avec le circuit interne, ce qui peut provoquer un choc électrique, un incendie ou un dysfonctionnement.

Ne pas placer cet instrument dans un endroit exposé aux rayons directs du soleil et où règne un taux d'humidité élevé.

Ceci peut entraîner une augmentation de la température intérieure ou provoquer un incendie.

Utiliser un fusible adapté (accessoire : puissance de 3 A et 250 V) lors du remplacement des fusibles. Ne jamais utiliser de fusibles d'une puissance différente.

Ceci est susceptible de provoquer un incendie ou un dysfonctionnement.

En cas de perte d'un fusible accessoire, contacter le bureau Iwatsu ou nos revendeurs.

Ne pas utiliser ni entreposer cet instrument dans un lieu humide (salle de bain, etc.) ou poussiéreux.

Le laisser dans un endroit humide ou poussiéreux peut provoquer un choc électrique, un incendie ou un dysfonctionnement.

Ne pas mettre l'appareil dans un endroit proche d'une table de travail ou d'un humidificateur, ce qui est susceptible de l'exposer à de la fumée huileuse ou de la vapeur.

Ceci peut provoquer un choc électrique, un incendie ou un dysfonctionnement.

Ne mettre aucun objet à proximité de l'orifice de ventilation ou du ventilateur de cet instrument.

Si un objet est placé près de l'orifice d'aération ou du ventilateur de cet instrument, la ventilation est bloquée et la température intérieure augmente, ce qui provoque un incendie ou un dysfonctionnement.

Mettre l'interrupteur d'alimentation en position OFF (hors tension) et sortir la fiche d'alimentation de la prise lorsque le tonnerre est sur le point d'être généré.

Ceci provoque un choc électrique, un incendie et le dysfonctionnement selon le tonnerre.

Ne pas utiliser cet instrument s'il ne fonctionne pas correctement.

L'utilisation d'un instrument défectueux (suite à une chute, etc.) peut provoquer un choc électrique ou un incendie. Si l'instrument ne fonctionne pas correctement, mettre l'interrupteur sur OFF (hors tension), sortir la fiche de la prise et contacter ensuite le revendeur YOKOGAWA le plus proche.

Lorsque la tension est appliquée à la borne LO, ne pas la relier à la borne de terre d'un autre dispositif de mesure.

La borne LO n'est pas reliée à la terre et flotte seulement. Lorsque la tension est appliquée à la borne LO, le fait de la relier à la borne de terre d'un autre dispositif de mesure peut provoquer un incendie ou des dommages.

Ne pas appliquer une tension supérieure à la tension spécifiée entre la borne LO et la terre.

La tension spécifiée est égale à ± 500 V crête. Des tensions supérieures peuvent provoquer un incendie ou des dommages.

Ne pas appliquer de tension ou de courant à la borne d'entrée dépassant les niveaux spécifiés.

L'application d'une tension/d'un courant dépassant les niveaux spécifiés peut provoquer un incendie ou des dommages.

Les entrées maximales admissibles sont indiquées dans le Tableau 2 et le Tableau 3.

Tableau 2. Entrées maximales admises (panneau avant)

Borne d'entrée	Fonction ^{Remarque 1}	Entrée max. admise
ENTRÉE V • Ω • \rightarrow HI-LO	DCV(plage de 100 mV à 100 V) 2 W Ω , 4 W Ω , CONT, DIOD, TEMP	800 V crête(continue), 1100 V crête(1 min.)
	DCV(plage de 1000 V)	1100 V crête(continue)
	ACV, FREQ	750 Vrms et \pm DC 500V ou moins ^{Remarque 2}
SENSE 4 W Ω HI-LO	4W Ω , TEMP(RTD)	200 V crête
I-LO	DCI, ACI	3 A (DC ou rms, continue) (250V ^{Remarque 3})

Remarque 1) Voir la fonction de la « section 4.3 Fonction de mesure » dans le manuel IM DM7560-01EN pour le nom de chaque fonction correspondante.

Remarque 2) Pour la mesure dans la catégorie de mesure II (CAT II), l'entrée maximale admissible est de 300 V.

Remarque 3) Concernant la tension à laquelle le composant en courant alternatif est superposé au composant en DC, l'entrée maximale admise est de 1100 V en conversion V crête.

Tableau 3. Entrées maximales admises (panneau arrière)

Pièces (Standard / Option)	Borne d'entrée	Entrée maximale admise (tension)
Panneau arrière (équipement standard)	TRIG IN	0 à 5 V
Panneau arrière (lorsque l'option DIO/CMP est installée)	INH IN	0 à 5 V

• **Ne pas ajouter la tension en la confondant avec la borne de sortie COMPLETE (BNC) au dos.**

Ceci provoque un incendie et une panne.

Ne pas ajouter de tension et de courant supérieurs aux normes à la sortie contact de l'option DIO/CMP.

Ceci provoque un incendie et une panne. Chaque sortie contact de HI, GO, LO et COMPLETE a les spécifications suivantes.

- Tension résistive entre les bornes : 42 V crête
- Tension résistive de terre : ± 42 V crête
- Courant maximal admis : 100 mA

Avant la maintenance, débrancher la fiche de la prise par mesure de sécurité. Utiliser un chiffon pour éliminer toute trace d'humidité.

Le nettoyage de cet instrument lorsque la fiche est branchée dans la prise ou lorsque l'instrument est humide peut provoquer un choc électrique ou un dysfonctionnement.

Ne pas utiliser l'instrument si l'intérieur n'a pas été nettoyé depuis longtemps.

L'utilisation prolongée d'un instrument dont l'intérieur est sale ou poussiéreux peut provoquer un incendie ou des lésions corporelles. Il est conseillé de contacter le bureau Iwatsu ou nos revendeurs pour vérifier et nettoyer l'intérieur, effectuer l'étalonnage, etc., une fois par an environ.

CAUTION

The tip of the test lead is sharp to facilitate measurements. Be careful not to inadvertently prick your finger.

Be careful not to get your fingers caught when removing or installing the handle of this product.

Be careful not to get your fingers caught when removing or installing the handle, when changing the position of the handle, or when mounting the product on a rack. Under normal circumstances, do not remove the handle, except when mounting the instrument on a rack or the like.

Use this instrument only within the specified operating ranges.

Using this instrument outside of the operating ranges may cause a malfunction. The permissible humidity and temperature ranges are as follows.

Indoor use only

Operating temperature: 0°C to +50°C

Operating humidity: 80%RH (at 40°C, no condensation)

Storage temperature: -20°C to +60°C

Storage humidity: 90%RH (at 40°C, no condensation)

Allow appropriate space at the rear and on both sides of this instrument.

If this instrument is mounted on a rack or placed on top of other measuring instrument, be careful of the temperature increase. If the temperature increases excessively, this may cause an operation fault or a specification fault.

If this instrument remains unused for a long period, unplug the power cord for safety reasons.

When transporting this instrument, use the original packing materials or their equivalent.

Excessive vibration or shock applied to this instrument during transportation may cause it to malfunction, resulting in fire.

Operating Environment Limitations

This product is a Class A (for industrial environments) product. Operation of this product in a residential area may cause radio interference in which case the user will be required to correct the interference.

French

ATTENTION

L'extrémité du câble d'essai est pointue pour faciliter les mesures. Faire attention à ne pas se piquer les doigts, etc.

Faire attention aux doigts lorsque la poignée de cette unité est enlevée ou montée.

Faire attention aux doigts lorsque la poignée est enlevée ou montée, lors du changement de position de la poignée ou lorsque l'unité est mise sur le rack. En règle générale, ne pas enlever la poignée, sauf lors de son montage dans l'équipement, comme les racks.

Utiliser cet instrument uniquement dans les plages de fonctionnement admises.

L'utilisation de cet instrument en dehors des plages de fonctionnement peut être à l'origine d'un dysfonctionnement. Les plages admises pour l'humidité et la température sont les suivantes :

Utilisation à l'intérieur uniquement

Température de fonctionnement : 0°C à +50°C

Humidité de fonctionnement : 40°C et aucune rosée admise au-dessous d'un taux d'humidité relative de 80 %

Température de conservation : -20°C à +60°C

Humidité de conservation : 40°C et aucune rosée admise au-dessous d'un taux d'humidité relative de 90 %.

Respecter une distance adaptée au dos et sur les deux côtés de cet instrument.

Si cet instrument est mis à l'intérieur du rack ou sur un autre instrument de mesure, contrôler attentivement toute augmentation de température. Si la température augmente de façon excessive, ceci peut entraîner un dysfonctionnement ou une défaillance.

En cas de période d'inutilisation prolongée, débrancher le cordon d'alimentation pour des raisons de sécurité.

Lors du transport de cet instrument, utiliser un emballage similaire à celui original.

Des vibrations excessives ou des chocs pendant le transport peuvent provoquer le dysfonctionnement de l'instrument et provoquer, par conséquent, un incendie.

Limitations relatives à l'environnement opérationnel

Ce produit est un produit de classe A (pour environnements industriels). L'utilisation de ce produit dans un zone résidentielle peut entraîner une interférence radio que l'utilisateur sera tenu de rectifier.

Sales in Each Country or Region

Waste Electrical and Electronic Equipment



Waste Electrical and Electronic Equipment (WEEE), Directive

(This directive is valid only in the EU.)

This product complies with the WEEE directive marking requirement. This marking indicates that you must not discard this electrical/electronic product in domestic household waste.

Product Category

With reference to the equipment types in the WEEE directive, this product is classified as a “Monitoring and control instruments” product.

When disposing products in the EU, contact your local Yokogawa Europe B.V. office.

Do not dispose in domestic household waste.

EU Battery Directive



EU Battery Directive

(This directive is valid only in the EU.)

Batteries are included in this product. This marking indicates they shall be sorted out and collected as ordained in the EU battery directive.

Battery type: Lithium battery

You cannot replace batteries by yourself. When you need to replace batteries, contact your local Yokogawa Europe B.V. office.

Authorized Representative in the EEA

Yokogawa Europe B.V. is the authorized representative of Yokogawa Test & Measurement Corporation for this product in the EEA. To contact Yokogawa Europe B.V., see the separate list of worldwide contacts, PIM 113-01Z2.

Symbols and Notation Used in This Manual

Unit

k: Denotes 1000.

Example: 100 kS/s (sample rate)

K: Denotes 1024.

Example: 720 KB (file size)

Displayed Characters

Bold characters in procedural explanations are used to indicate panel keys and soft keys that are used in the procedure and menu items that appear on the screen.

Notes and Cautions

The notes and cautions in this manual are categorized using the following symbols.



Improper handling or use can lead to injury to the user or damage to the instrument. This symbol appears on the instrument to indicate that the user must refer to the user's manual for special instructions. The same symbol appears in the corresponding place in the user's manual to identify those instructions. In the manual, the symbol is used in conjunction with the word "WARNING" or "CAUTION."

WARNING

Calls attention to actions or conditions that could cause serious or fatal injury to the user, and precautions that can be taken to prevent such occurrences.

CAUTION

Calls attentions to actions or conditions that could cause light injury to the user or damage to the instrument or user's data, and precautions that can be taken to prevent such occurrences.

French

AVERTISSEMENT

Attire l'attention sur des gestes ou des conditions susceptibles de provoquer des blessures graves (voire mortelles), et sur les précautions de sécurité pouvant prévenir de tels accidents.

ATTENTION

Attire l'attention sur des gestes ou des conditions susceptibles de provoquer des blessures légères ou d'endommager l'instrument ou les données de l'utilisateur, et sur les précautions de sécurité susceptibles de prévenir de tels accidents.

Note

Calls attention to information that is important for proper operation of the instrument.

Contents

Checking the Contents of the Package.....	iii
Safety Precautions.....	vi
Sales in Each Country or Region.....	xviii
Symbols and Notation Used in This Manual	xix
Chapter 1 Name and function of each part	
1.1 Name and outline of each part on front panel	1-1
1.2 Name and function of each part on rear panel	1-9
Chapter 2 Basic Operation	
2.1 Installing the instrument	2-1
⚠ 2.2 Connecting the power supply and powering on	2-3
Chapter 3 Daily check and calibration	
3.1 Daily cleaning	3-1
3.2 Calibration	3-2
3.3 Fuse replacement.....	3-3
3.4 Recommended Part Replacement	3-4
Chapter 4 Specifications	
4.1 Common Specifications.....	4-1
4.2 Specifications of Basic Measuring Function.....	4-6
4.3 Trigger function.....	4-12
4.4 Calculation function	4-13
4.5 Log function	4-15
4.6 Screen display switching	4-17
4.7 Trend chart display function	4-18
4.8 Histogram chart display function	4-20
4.9 Arc scale meter (ARC SCALE METER) display function	4-22
4.10 Analog meter (ANALOG METER) display function	4-23
4.11 Save / recall setting of SETUP condition.....	4-24
4.12 Setting of System	4-25
4.13 Appearance drawing	4-27

1.1 Name and outline of each part on front panel

Figure 1.1 shows the front panel and Table 1.1 on the next page describes names of 1 to 5, screens, keys, input terminals, and switches being arranged.

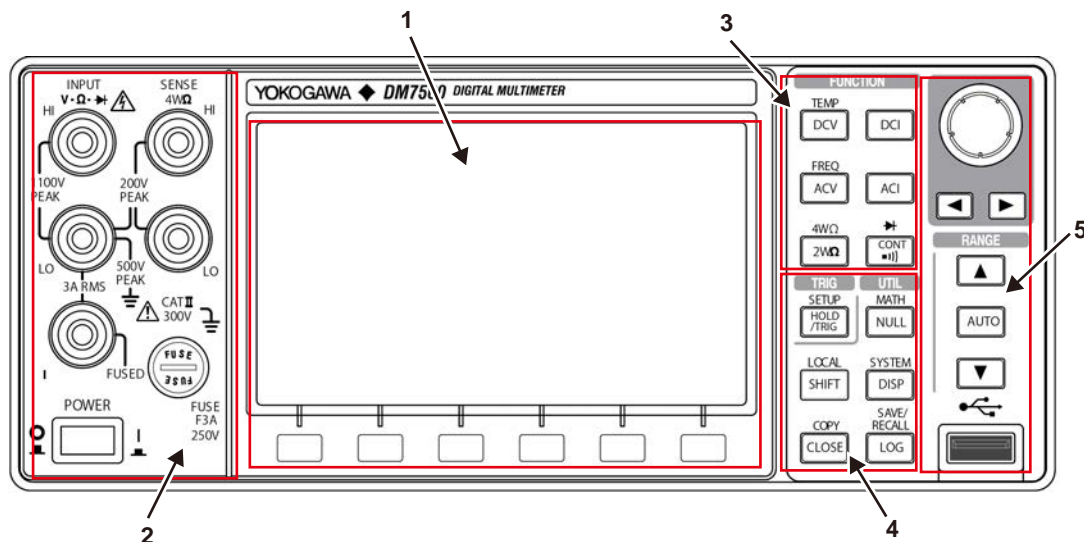

Figure 1.1 Front panel

Table 1.1 Name and arrangement of parts on front panel

No	Name	Arrangement
1	Display part	It consists of the LCD screen and menu keys below the screen.
2	Input terminal part	Input terminals to measure voltage, current, resistance, and the others are arranged. There are the fuse holder and POWER switch on the lower side.
3	FUNCTION part	Function keys to set and measure various measurement functions; e.g. voltage, current, resistance, continuity test, and diode are arranged.
4	TRIG & UTILITY setting part	Various setting keys; e.g. trigger, display, calculation, log, and system and execution keys; e.g. [SHIFT], [COPY] are arranged.
5	Rotary knob & RANGE switching part	The Rotary knob (switch) and arrow keys are arranged on the upper side, [AUTO] key (AUTO RANGE switching) at the center, and the USB memory connection on the lower side.

1.1 Name and outline of each part on front panel

1.1.1 Display part

Figure 1.2 shows the display part on the front panel and Table 1.2 describes the name and function of each parts.

*Figure 1.2 also shows the location of the display part in the instrument of front panel by enlarging them.

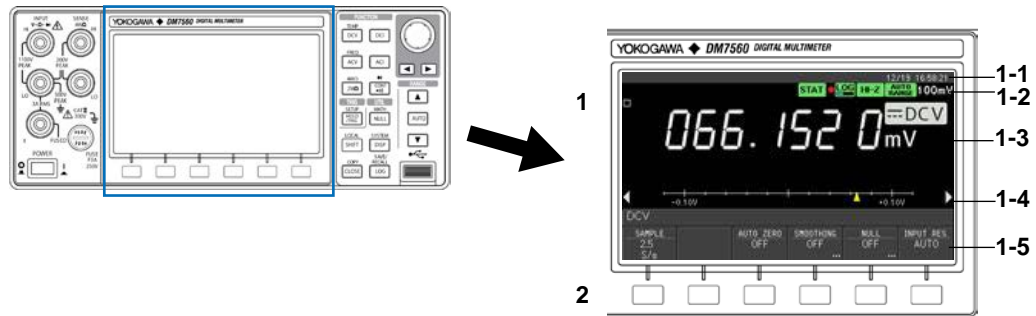

Figure 1.2 Display part

Table 1.2 Contents of display part

No	Name	Contents and functions (outline)
1	LCD screen	The screen is the 4.3-inch color LCD (LED backlight). The screen displays the items below from the upper side. 1-1 Message and header information 1-2 Annunciator (multiple indicators) and range 1-3 Primary display : Measurement result of main function Sampling indicator 1-4 Secondary display: Measurement result of sub function, various calculation result, histogram information, cursor measurement result 1-5 Menu : It sets contents of each functions and functions of TRIG & UTILITY part.
2	Menu keys	Menu keys (for convenience, this document uses M1 to M6 keys) corresponding to the horizontal sections of the setting menu are arranged below the LCD screen. Pressing of the key allows selection and execution of the menu item and the sub-menu at the lower layer to be opened.

Menu keys

Menu keys (for convenience, this document uses M1 to M6 keys) corresponding to the horizontal sections of the setting menu are arranged below the LCD screen. Pressing of the key allows selection and execution of the menu item and the sub-menu at the lower layer to be opened.

1.1.2 Input terminal part

Figure 1.3 shows the input terminal part on the front panel and Table 1.3 describes the name and function of each part.

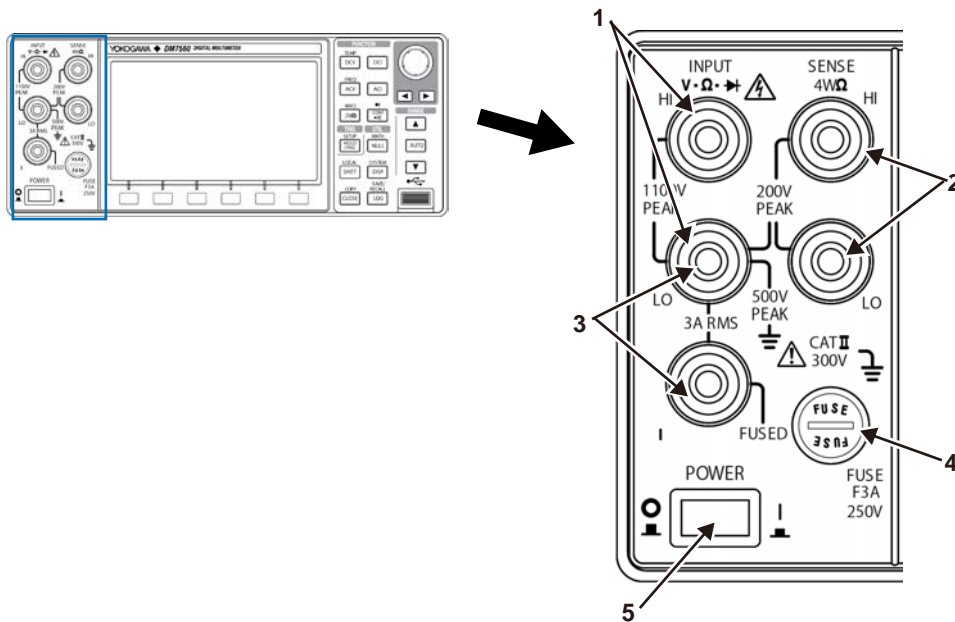

Figure 1.3 Input terminal part

Table 1.3 Input terminal part

No	Name	Contents and functions (outline)
1	INPUT V · Ω · \rightarrow · \rightarrow HI-LO input terminal	It is the input terminal for measurement of voltage (DCV, ACV), resistance ($2W\Omega$), temperature (TEMP), diode (\rightarrow) and Continuity test (CONT). The attached test lead (pair of red and black leads) or banana terminal is connected to it. Take care of the range and maximum permissible input.
2	SENSE $4W\Omega$ HI-LO input terminal	It is used for resistance measurement ($4W\Omega$) and temperature measurement (TEMP, RTD-4Wire). • Max. permissible input: 200 Vpeak for all ranges
3	I-LO input terminal	It is the input terminal for current measurement (DCI, ACI). • Max. permissible input : 3 A DC or rms (continuous) / 250 V (Open circuit voltage)
4	FUSE	The fuse is installed for overcurrent protection when measuring current (DCI, ACI). • Fuse specification: F3A, 250 V In addition to the fuse installed in this instrument, two fuses are attached.
5	POWER switch	It is the power switch of this instrument. • ON: I (switch is pressed) • OFF: O (switch is not pressed)

1.1 Name and outline of each part on front panel

1.1.3 FUNCTION part

Figure 1.4 shows the FUNCTION part on the front panel and Table 1.4 describes the name and function of each part.

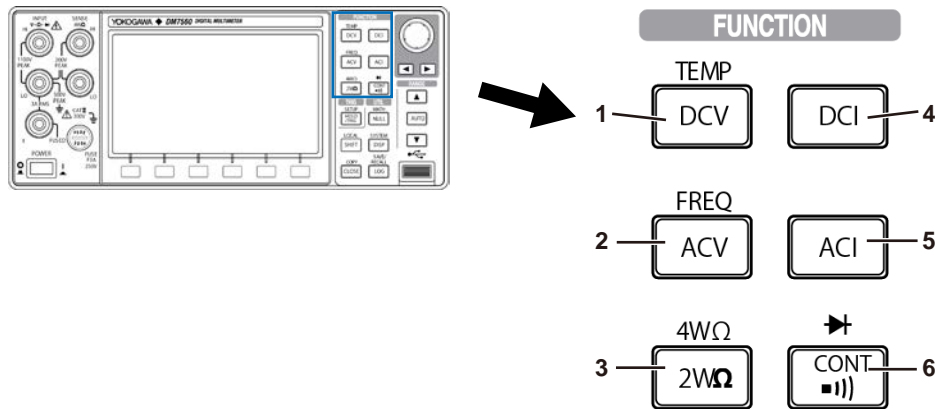

Figure 1.4 FUNCTION part

Table 1.4 Name and function of each part of FUNCTION part

No	Name	Contents and functions (outline)
1	DCV (TEMP) key TEMP	<ul style="list-style-type: none"> It selects the DC voltage measurement (DCV). If pressed, the DCV menu opens on the lower part of the screen. It also selects the temperature measurement (TEMP); i.e. after pressing [SHIFT] key, press it. If pressed, the TEMP menu opens on the lower part of the screen.
2	ACV(FREQ) key FREQ	<ul style="list-style-type: none"> It selects the AC voltage measurement. If pressed, the ACV menu opens on the lower part of the screen. It also selects the frequency measurement; i.e. after pressing [SHIFT] key, press it. If pressed, the FREQ menu opens on the lower part of the screen.
3	2WΩ (4WΩ) key 4WΩ	<ul style="list-style-type: none"> It selects the 2-terminal resistance measurement. If pressed, the 2WΩ menu opens on the lower part of the screen. It also selects the 4-terminal resistance measurement; i.e. after pressing [SHIFT] key, press it. If pressed, the 4WΩ menu opens on the lower part of the screen.
4	DCI key	<ul style="list-style-type: none"> It selects the DC current measurement. If pressed, the DCI menu opens on the lower part of the screen.
5	ACI key	<ul style="list-style-type: none"> It selects the AC current measurement. If pressed, the ACI menu opens on the lower part of the screen.
6	CONT(▶) key ▶	<ul style="list-style-type: none"> It selects the Continuity test. If pressed, the CONT menu opens on the lower part of the screen. It also selects the diode measurement; i.e. after pressing [SHIFT] key, press it. If pressed, the DIOD menu opens on the lower part of the screen.

1.1.4 TRIG & UTILITY setting part

Figure 1.5 shows the TRIG & UTILITY part on the front panel and Table 1.5 describes the name and function of each part.

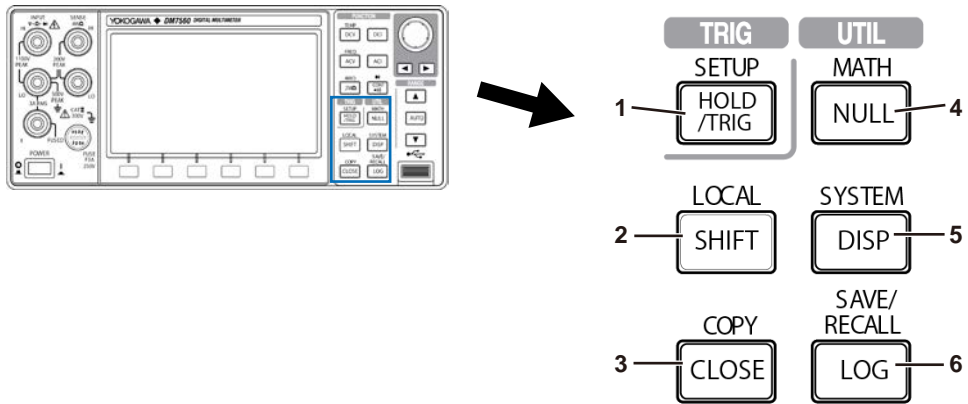

Figure 1.5 TRIG & UTILITY setting part

1.1 Name and outline of each part on front panel

Table 1.5 Name and function of each part of TRIG & UTILITY setting part

№	Name	Contents and functions (outline)
1	HOLD/TRIG (SETUP) key SETUP	<ul style="list-style-type: none"> It selects start/stop of measurement when the trigger mode is set to AUTO and is the key for manual trigger when set to SINGLE. When the mark □ flashes to indicate the trigger action state on the upper left of the screen when the key is pressed, the state is TRIG action state. On the other hand, when the mark on the left of the screen becomes II when pressed, the state is HOLD. It also selects the trigger setting (SETUP); i.e. after pressing [SHIFT] key, press it. If pressed, the TRIG menu opens on the lower part of the screen.
2	SHIFT (LOCAL) key LOCAL	<ul style="list-style-type: none"> If pressed once, the mark indicating the shift state is displayed and if pressed again, the shift state is released. If [SHIFT] key is pressed and the corresponding key is pressed, the measurement function or setting (blue characters) above the key in the FUNCTION part and TRIG & UTILITY setting part on the front panel is available. The function to select to which of a primary display or a secondary display to switch the measurement screen is provided, too. If this instrument is remotely controlled, it operates as [LOCAL] key. This instrument changes from the remote state to the local state; i.e. keys on the front panel become available.
3	CLOSE (COPY) key COPY	<ul style="list-style-type: none"> It is normally used to close the menu. Every time it is pressed after moving to the lower layer; i.e. menu to submenu, the menu returns by one layer. If the setting menu of TRIG & UTILITY setting part opens, the setting menu of TRIG & UTILITY setting part closes when the menu returns to the highest layer and the screen returns the FUNCTION menu currently set. If [SHIFT] key is pressed and then [CLOSE(COPY)] key is pressed, the screen hard copy (HARD COPY) or data that makes the latest measurement result text can be output to the USB memory.
4	NULL (MATH) key MATH	<ul style="list-style-type: none"> It switches ON/OFF the NULL function (difference calculation function) in each measurement function of FUNCTION part. It is available to the function currently opened. It is also used to select MATH calculation menu; i.e. if [SHIFT] key is pressed and then [NULL(MATH)] key is pressed, MATH menu opens at the lower part of the screen and setting can be changed.
5	DISP (SYSTEM) key SYSTEM	<ul style="list-style-type: none"> It selects DISP setting menu; i.e. if pressed, DISPLAY menu opens at the lower part of the screen and setting can be changed. It is also used to select SYSTEM setting menu. If [SHIFT] key is pressed and then [DISP(SYSTEM)] key is pressed, SYSTEM menu opens at the lower part of the screen and setting can be changed.
6	LOG (SAVE/RECALL) key SAVE/RECALL	<ul style="list-style-type: none"> It sets the log function menu; i.e. if pressed, LOG menu opens at the lower part of the screen and setting can be changed. It is also used to set Save/Recall of the setting condition. Press [SHIFT] key and then press [LOG(SAVE/RECALL)] key for selection. If the key is pressed, SETUP SAVE/RECALL menu opens at the lower part of the screen and setting and Execution of preservation/recall can be changed.

1.1.5 Rotary knob & RANGE switching part

Figure 1.6 shows the Rotary knob & RANGE switching part on the front panel and Table 1.6 on next page describes the name and function of each part.

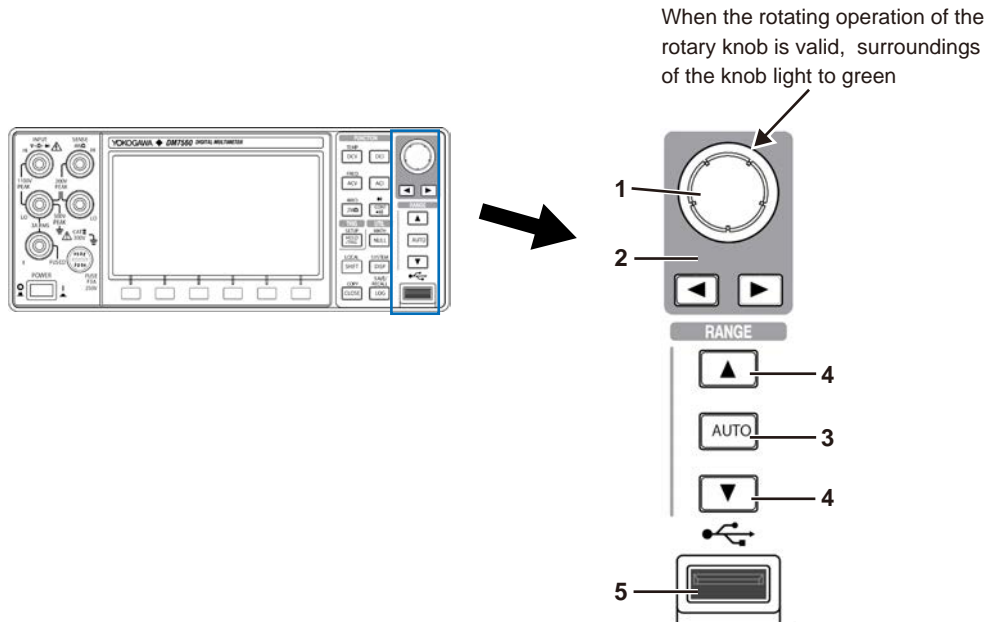

Figure 1.6 Rotary knob & RANGE switching part

1.1 Name and outline of each part on front panel

Table 1.6 Name and function of each part of Rotary knob & RANGE switching part

№	Name	Contents and functions (outline)
1	Rotary knob (switch)	<p><When surroundings of the rotary knob light ></p> <ul style="list-style-type: none"> • It is used to select one from multiple setting items in the screen menu. When the periphery of the knob lights up, the function is available. Clockwise or counterclockwise rotation of knob can make selection. Ex. Selection of SAMPLE (sampling rate) of the function • Rotation of the knob allows input of character, numeric value, or symbol, and selection of list, cursor movement. Ex. SETUP NAME is set in SETUP SAVE/RECALL menu. <p><When surroundings of the rotary knob are turned off ></p> <ul style="list-style-type: none"> • If the knob is pushed at the highest layer of the menu, the trend chart, histogram chart, and statistic data can be cleared. <p><Regardless of light/turning off around rotary knob ></p> <ul style="list-style-type: none"> • It can return the screen menu to the upper layer by one. (The equivalent function to CLOSE key in Section 1.1.4) Every push allows the screen menu to return to the upper layer by one. (It is available regardless of whether the periphery of the knob lights up or not.)
2	Arrow key	<p><When surroundings of the rotary knob light ></p> <ul style="list-style-type: none"> • It can move the cursor position when selecting a character, numeric value, or symbol. <p><When surroundings of the rotary knob are turned off ></p> <ul style="list-style-type: none"> • Usually, push the DISPLAY key to switch the content of the display of secondary / primary by the DISPLAY menu. It is also possible to switch by combining the arrow key and the SHIFT key. Refer to section 3.4.2.2 for details.
3	AUTO key	<ul style="list-style-type: none"> • It switches the range between AUTO/MANUAL of the voltage and current in each function. Each time the key is pushed, the state of AUTO RANGE/MANUAL RANGE is displayed on the annunciator of the screen. • When the trend chart of off-line is displayed, T cursor is displayed and the statistic calculation and the display between T1 cursor and T2 cursor are executed. Use this key when it calculates again and is displayed after T cursor is moved.
4	Range switching key (up arrow/down arrow)	<ul style="list-style-type: none"> • It manually switches the range of the voltage and current in each function. The up arrow key makes switching to the larger range and the down arrow key makes switching to smaller range. Even if this key is pressed in AUTO RANGE state, the state is changed to MANUAL RANGE and the range can be switched.
5	USB memory connection	<ul style="list-style-type: none"> • It can connect the USB memory. Output of screen hard copy, save/recall of setting condition or export of log data etc. can be done.

1.2 Name and function of each part on rear panel

Figure 1.7 (a) shows the rear panel of DM7560 (only main unit; no option), Figure 1.7 (b) shows that of DM7560 (main unit, /C2+/CMP), Figure 1.7 (c) shows that of DM7560 (main unit, /C1+/CMP), and Table 1.7 describes names and functions of parts of 1 to 6.

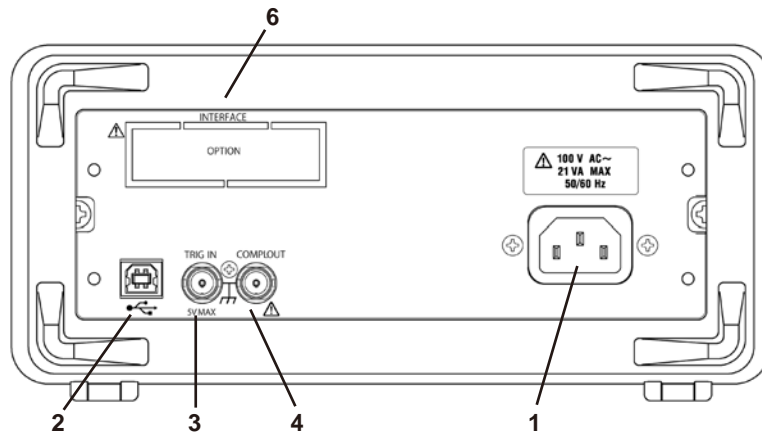

Figure 1.7(a) Rear panel of DM7560 (only main unit, no option)

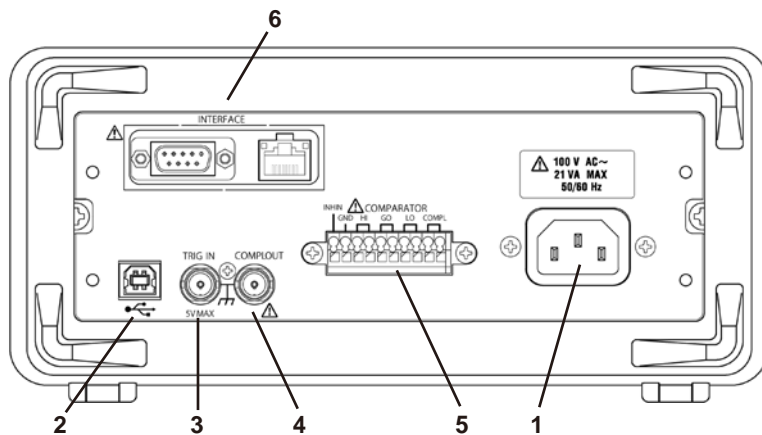

Figure 1.7(b) Rear panel of DM7560 (main unit+/C2+/CMP)

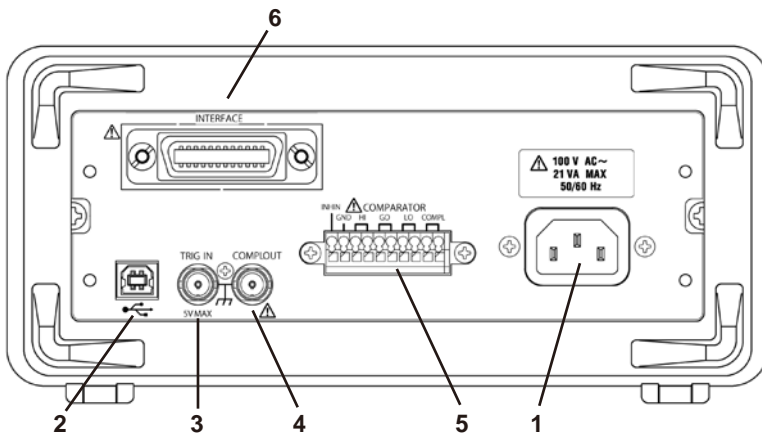

Figure 1.7(c) Rear panel of DM7560 (main unit+/C1+/CMP)

1.2 Name and function of each part on rear panel

Table 1.7 Name and function of each part on rear panel

No	Name	Contents and functions (outline)
1	AC LINE INPUT	<ul style="list-style-type: none"> It is the inlet for power supply cord connection. Use the attached power supply cord. The power supply specification is as follows and is indicated above the inlet. AC100 V/115 V/220 V/240 V\pm10 %, 50 Hz/60 Hz Power consumption (POWER) is 21 VA MAX.
2	USB (device) terminal	<ul style="list-style-type: none"> It is the connection terminal for the USB interface (Type A). Connection to the PC allows remote control from the outside. For rules, commands, and use methods, see Remote Control Manual. Selection of USB in SYSTEM/REMOTE/INTERFACE menu makes the terminal available. For the specifications, see Chapter 4 Specifications in this manual.
3	TRIG IN terminal (BNC)	<ul style="list-style-type: none"> It is the input terminal of the external trigger. Use of TRIG/EXT TRIG menu allows selection of use or not and the slope polarity. Maximum permissible input: 5 V MAX (H:2.4 Vmin, L:0.9 Vmax) Input impedance: about 10 kΩ
4	COMPL output terminal (complete, output terminal, BNC)	<ul style="list-style-type: none"> It is the pulse output terminal that shows the measurement completion and can be used when synchronizing this instrument with the other equipment. <ul style="list-style-type: none"> a) TTL level output (H:2.4 Vmin, L:0.4 Vmax) b) Polarity: positive logic * When LIMIT judgment is available, it is originally the same signal as COMPLof /CMP output in 5 below. Because the logic signal is output directly, it is output according to timing that is earlier than the signal of 5.
5	DIO option /CMP	<ul style="list-style-type: none"> It allows output of the LIMIT judgment result or input of the trigger control signal. (See Figure 1.7(b).) <ul style="list-style-type: none"> a) Hi/Lo/Go : Output of LIMIT judgment result b) COMPL : Complete output * The output above is the Photo MOS relay contact output. c) INH IN : Trigger inhibit signal input Input impedance: about 10 kΩ H:2.4 Vmin, L:0.6 Vmax
6	Option installation unit /C2 option or /C1 option	<ul style="list-style-type: none"> Either of two options below can be installed. If installed, the corresponding connector can be seen. If not installed, the cover is done. <ul style="list-style-type: none"> a) LAN/RS-232 interface /C2 (See Figure 1.7(b).) b) GP-IB interface /C1 (See Figure 1.7(c).)

2.1 Installing the instrument

Before using this instrument, install it in a location and under environment conditions according to section 2.1.1, "Installation conditions." In addition, we recommend that you read the warnings and cautions provided in "Safety Precautions" at the beginning of this document.

2.1.1 Installation conditions

- Flat and horizontal location

Install this instrument on a stable location, and keep it horizontal in all directions. Using it in an unstable location may cause the instrument to fall, which can lead to injury or damage.

- Well-ventilated location

This instrument has vent holes on each side. To prevent internal overheating, allow sufficient space around it, and do not block the vent holes.

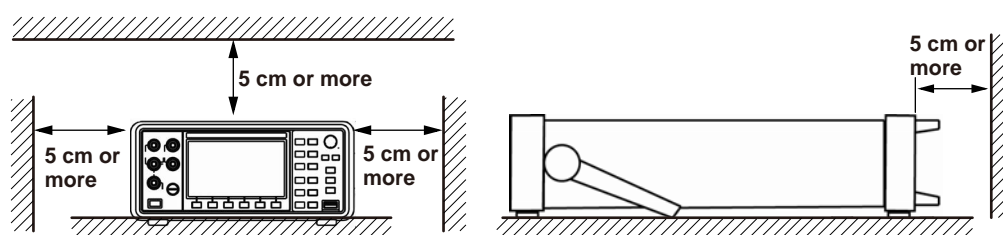

- Operating temperature and humidity ranges and storage temperature and humidity ranges
- Use the instrument in the following operating and storage ranges.

Indoor use only

Operating temperature: 0°C to +50°C

Operating humidity: 80%RH (at 40°C, no condensation)

Preservation temperature: -20°C to +60°C

Preservation humidity: 90%RH (at 40°C, no condensation)

CAUTION

Moving the instrument to an environment with different temperature and humidity may result in condensation because of the drastic temperature change.

In such situations, allow the instrument to gradually adjust to the new ambient temperature before use.

French

ATTENTION

Un déplacement dans un environnement où règnent des températures et des taux d'humidité différents peut entraîner la formation de rosée ou de condensation due aux rapides écarts de température.

Dans ce cas, l'utiliser après l'avoir suffisamment adapté à la température ambiante pour que la température varie progressivement.

2.1 Installation of instrument

2.1.2 Installation state

This instrument may be installed horizontally or tilted using the handle as shown in Figure 2.1(a) and (b). When moving the handle, pull it outward at the handle pivot, and lock the handle in any of the (a), (b), and (c) positions in Figure 2.1 by pressing inward.

CAUTION

When changing the handle position, be careful not to get your fingers caught.

French

ATTENTION

Lors d'un déplacement, faire attention à ne pas se pincer les doigts.

The state in Figure 2.1(c) (with the back facing down) is a temporary position; do not measure in this state.

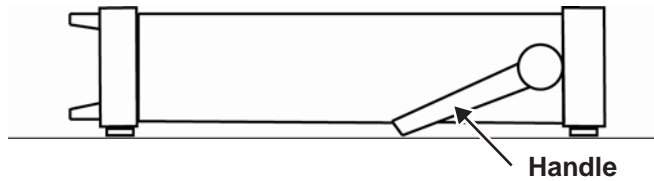

Figure 2.1(a) Installation state A (horizontal)

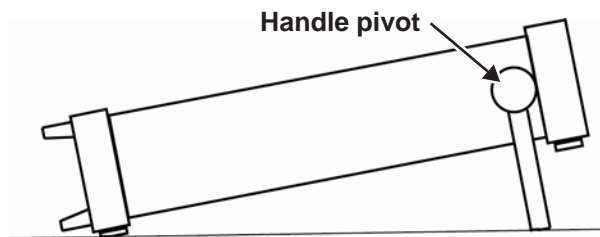
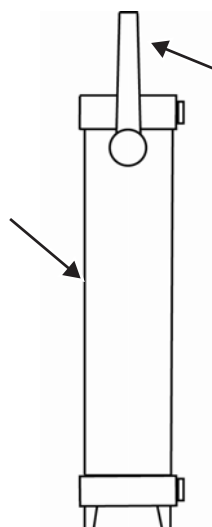

Figure 2.1(b) Installation state B (tilted using handle)

Do not use this state for measurement.
The performance cannot be ensured.
Use this position for storage and temporary placement.
Be careful not to tip over the instrument due to vibration or shock.



When carrying this instrument, hold the handle with your hand with the handle in this position.

Figure 2.1(c) State C (with the back facing down)

2.2 Connecting the power supply and powering on

This section describes the procedures to connect the power supply, turn the power on, and display the initial screen. Follow steps **1** to **4** in Section 2.2.1 and Section 2.2.2.

WARNING

- Before connecting the power cord, ensure that the source voltage matches the rated supply voltage of the instrument and that it is within the maximum rated voltage of the provided power cord.
- Connect the power cord after checking that the power switch of the instrument is turned off.
- To prevent electric shock or fire, be sure to use the power cord for the instrument that is supplied by YOKOGAWA.
- Make sure to connect protective earth grounding to prevent electric shock. Connect the power cord to a three-prong power outlet with a protective earth terminal.
- Do not use an extension cord without a protective earth ground. Otherwise, the protection function will be compromised.
- If an AC outlet that conforms to the supplied power cord is unavailable and you cannot ground the instrument, do not use the instrument.

French

AVERTISSEMENT

- Avant de brancher le cordon d'alimentation, vérifier que la tension source correspond à la tension d'alimentation nominale de l'instrument et qu'elle est compatible avec la tension nominale maximale du cordon d'alimentation.
- Brancher le cordon d'alimentation après avoir vérifié que l'interrupteur d'alimentation de l'instrument est sur OFF.
- Pour éviter tout risque de choc électrique ou d'incendie, utiliser exclusivement le cordon d'alimentation fourni par YOKOGAWA et prévu pour l'instrument.
- Relier l'instrument à la terre pour éviter tout risque de choc électrique. Brancher le cordon d'alimentation sur une prise de courant à trois plots reliée à la terre.
- Toujours utiliser une rallonge avec broche de mise à la terre, à défaut de quoi l'instrument ne serait pas relié à la terre.
- En l'absence de prise secteur conforme au cordon d'alimentation et dans l'impossibilité de mettre l'instrument à la terre, ne pas utiliser l'instrument.

2.2 Power supply connection and powering on

2.2.1 Connecting the power cord

Warnings and cautions on power supply connection and the power cord are provided on pages III to V at the beginning of this document. Before connecting the power supply, be sure to read them. Steps **1** and **2** below describe the procedure to connect the power cord.

- 1 Check that the POWER switch on the lower left of the front panel is OFF.
- 2 Insert the plug of the supplied power cord into the AC LINE INPUT connector on the rear panel (see Figure 2.2).

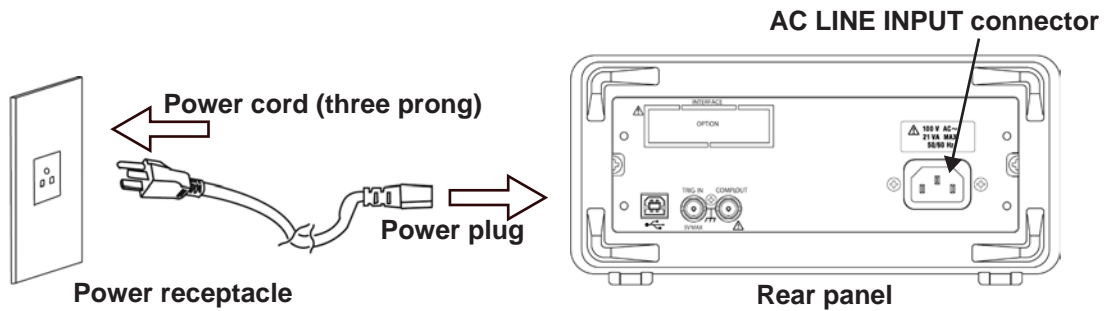

Figure 2.2 Connecting the power cord

2.2.2 Powering on and off

- 3 Press the POWER switch on the lower left of the front panel (in Figure 2.3) to turn it ON. The initial setting screen (factory setting when the instrument is turned on for the first time after delivery) appears after several seconds.
- 4 To turn the power off, press the POWER switch again.

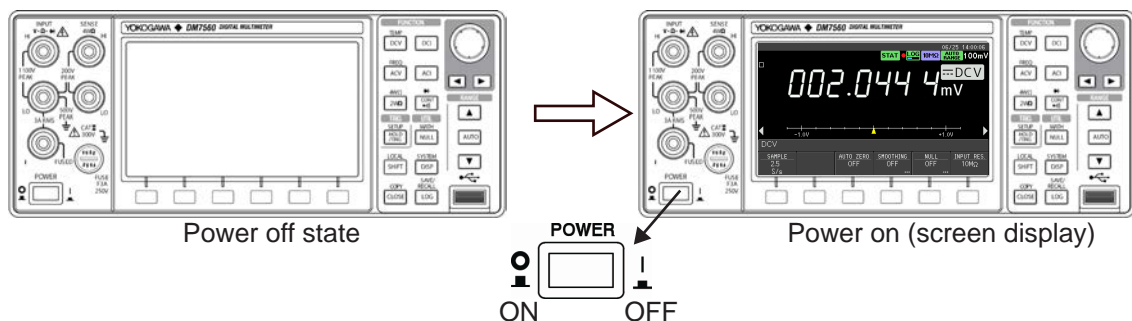

Figure 2.3 Powering on and off

Power-on operation

When you turn on the power switch and the instrument starts normally, the normal measurement screen appears. Check that the instrument has started normally before you use it.

If the DM7560 Does Not Start Normally When the Power Is Turned On

Turn off the power switch, and check the following items.

- Check that the power cord is securely connected.
- Check that the correct voltage is coming to the power outlet.

If the instrument still does not work properly, contact your nearest YOKOGAWA dealer for repairs.

3.1 Daily cleaning

CAUTION

Since the electric shock may occur, be sure to remove the power supply cord before cleaning.

French

ATTENTION

Un choc électrique pouvant se produire, veiller à enlever le cordon d'alimentation avant le nettoyage.

Softly wipe the dirt on the exterior with soft cloth including a small amount of water or thinned neutral detergent.

Use of inhibited solvent or detergent for cleaning may result in discoloration or unexpected failure.

The solvent or detergent should be selected as shown below:

- Solvent and detergent to be used: Water, neutral detergent (thinned)
- Solvent and detergent not to be used: Alcohol, gasoline, acetone, lacquer, ether, thinner, and detergent including ketone

3.2 Calibration

For this instrument to make accurate measurement, the regular calibration (after receiving it, charged calibration and adjustment are executed at our site) is recommended.

For the regular calibration for the entire instrument, contact your nearest YOKOGAWA dealer. The regular calibration is recommended once a year.

Note that the life of the battery for data backup is 5 years in the normal temperature. The battery cannot be replaced by the customer.

In addition, the customer can make CALIBRATION (calibration and adjustment) for this instrument with SYSTEM/TOOLS/CALIBRATION menu.

The performance of each function has the standard range and there may be deviation from the range because of temporal change. CALIBRATION is done in such a case.

Section 5.3 in the IM DM7560-01EN describes the calibration (adjustment) by CALIBRATION menu.

3.3 Fuse replacement

In current measurement, the fuse may be blown because of overcurrent. In such a case, replace the fuse.

WARNING

- Since the electric shock may occur, be sure to power off this instrument, remove the power supply cord from the outlet, and remove all cables (e.g. test lead). Since this instrument may be damaged, use the attached or specified 2 fuses for replacement. If there is no fuse, contact your nearest YOKOGAWA dealer.
- Specified fuse 3A/250V (B8509LK)

French

AVERTISSEMENT

- Un choc électrique pouvant se produire, s'assurer de mettre cet instrument hors tension, débrancher le cordon d'alimentation de la prise et enlever tous les câbles (par exemple, câble d'essai). Compte tenu du fait que cet instrument peut se détériorer, utiliser les 2 fusibles de rechange fournis ou préconisés. En l'absence de fusible, contacter le revendeur YOKOGAWA le plus proche.
- Fusible préconisé 3 A/250 V (B8509LK)

- 1 As shown below, press the fuse terminal (FUSE) with the minus driver (-) and rotate it counterclockwise. The fuse holder appears. Remove the fuse with the holder.

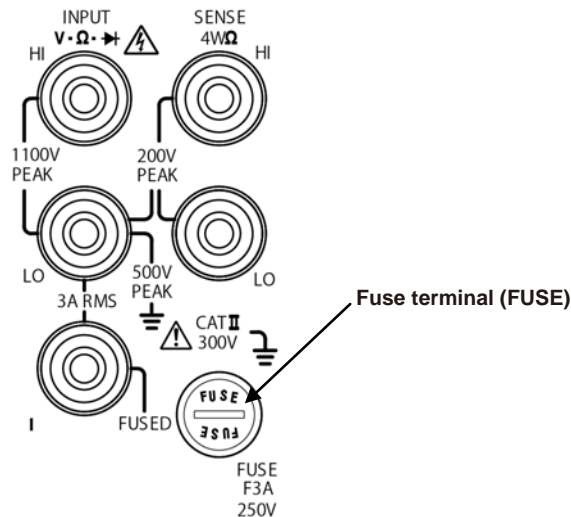

- 2 Replace with the specified fuse.
- 3 Press the fuse holder with new fuse.
- 4 Press it with the minus driver and rotate it clockwise to lock it.

3.4 Recommended Part Replacement

For part replacement and purchase, contact your nearest YOKOGAWA dealer.

Part Name	Lifetime
LCD backlight	Approximately 70000 hours at 23°C
Relay	Approximately 100,000 times (under maximum load at 1000 V) Approximately 10 million times (under normal operating conditions without overloading)

The following are consumable parts. We recommend replacing them at the following intervals. For part replacement, contact your nearest YOKOGAWA dealer.

Part Name	Recommended Replacement Interval
Backup battery (lithium battery)	5 years

4.1 Common Specifications

Operation system	$\Delta\Sigma$ ADC system
Measuring mode	
Trigger setting mode	AUTO/SINGLE (switching)
Range	Auto range (AUTO RANGE)/Manual range Selection by (MANUAL RANGE)
AUTO range	It exceeds "1199999" and improves the range. It downs the range by less than "100000"
Screen	LCD
Size	4.3 inch
Number of dot	480 dots × 272 dots
Color	16bit, 65,536 colors
Drive system	TFT active matrix
Back light	LED

* The LCD may include a few defective dots (7 dots or less).

The LCD may contain some dots that are always illuminated or that never illuminate. Please be aware that these are not defects.

Measuring cycle	*Figures in parenthesis below is at 60Hz of power frequency.	
DCV, 6 and 1/2 digits	2.5S/s to 50(60)S/s	
5 and 1/2 digits	100 S/s to 30 kS/s	
ACV, 6 and 1/2 digits MID	2.5 S/s	
6 and 1/2 digits HIGH	2.5 S/s to 50(60) S/s	

Sampling rate

Table description thereafter depends on following condition and definition.

Response time : Time that enters into accuracy within each range

DC function (DCV, DCI, 2W Ω ., 4W Ω , TEMP)

Power frequency : 50Hz		Power frequency : 60Hz		Display digit	Remarks
Sampling rate *1 (S/s)	PLC converted value *2	Sampling rate *1 (S/s)	PLC converted value *2		
2.5 (1)	20	2.5 (1)	24	6 and 1/2 digits,	Figures in () is AUTOZERO ON or at 4W Ω
10 (4)	5	10 (4)	6		
50 (20)	1	60 (20)	1		
100	0.5	100	0.6	5 and 1/2 digits,	This setting doesn't exist at 4W Ω .
500	0.1	500	0.12		
1 k	0.05	1 k	0.06		
2 k	25 m	2 k	0.03		
7.5 k	6.67 m	7.5 k	8 m		
15 k	3.33 m	15 k	4 m		
30 k	1.67 m	30 k	2 m		

*1. The sampling rate is guaranteed only when the mode of the Log function is at the incorporation in the BULK mode.

*2.PLC converted value: Value corresponding to Sampling cycle/power cycle value

4.1 Common Specifications

AC function (ACV, ACI)

AC filter	Sampling rate		Display digit	Response time *1
	Power freq.:50 Hz	Power freq.:60 Hz		
MID	2.5 S/s (20PLC)	2.5 S/s (24PLC)	6 and 1/2 digits,	Within 3 sec.
HIGH	2.5 S/s (20PLC)	2.5 S/s (24PLC)		Within 2 sec.
	10 S/s (5PLC)	10 S/s (6PLC)		
	50 S/s (1PLC)	60 S/s (1PLC)		

*1:In 0 → FS (full-scale) in the same range, the time to the start of ± 100 final value counts or less.

Additional error margin \pm (% of range) of each PLC

PLC 50 Hz / 60 Hz	DCV 0.1 V RES 100 Ω DCI 1 A	DCV 1 V, 100 V RES 1 k Ω , 10 k Ω	DCV 10 V, 1000 V
0.00167 / 0.002	0.1	0.01	0.006
0.00333 / 0.004	0.06	0.006	0.003
0.00667 / 0.008	0.06	0.006	0.0012
0.025 / 0.03	0.03	0.003	0.0006
0.05 / 0.06	0.02	0.002	0.0003
0.1 / 0.12	0.02	0.002	0.0002
0.5 / 0.6	0.001	0.001	0
1 / 1	0.001	0.001	0
5 / 6	0.0005	0	0
20 / 24	0	0	0

Remote Interface

USB2.0	Standard equipment
LAN&RS-232	/C2 (option)
GP-IB	/C1 (option)
DIO	/CMP (option)

Remote Command

SCPI basis command

USB memory connection entrance

Standard	USB2.0
Correspondence USB memory	USB memory formatted with FAT or FAT32 However, it is non-correspondence to the memory with the security functions of the virus check and the fingerprint authentication, etc.

Rear panel input/output (BNC and DIO)

Trigger input (BNC)

Signal level	H: 2.4 Vmin, L: 0.9 Vmax
Maximum input resisting voltage	0 to 5 V
Input impedance	Approx. 10 kΩ.
Polarity	Both edges are selectable
Pulse width	1 μs or more
Default delay	Less than 1 μs

COMPLETE output (BNC)

Signal level	H: 2.4 Vmin, L: 0.4 Vmax
Output impedance	Approx. 1 kΩ.
Polarity	Positive logic
Output pulse width	
At OFF of LIMIT judge	10 μs
At ON of LIMIT judge	4.0 ms or more

INHIBIT input (DIO option)

Signal level	H: 2.4 Vmin, L: 0.6 Vmax
Maximum input resisting voltage	0 to 5 V
Polarity	POSITIVE (positive logic operation) / NEGATIVE (negative logic operation)
Input impedance	Approx. 5 kΩ.

LIMIT judge output (DIO option)

COMPLETE, GO, HI, LO
 1) Outputs only at LIMIT judge ON and DIO output ON.
 2) This outputs contact signal by PHOTO MOS FET and BNC is outputted with timing delayed from output.

Withstand voltage between terminals	42 Vpeak
Max.allowable current	±42 Vpeak 100 mA

4.1 Common Specifications

Signal timing

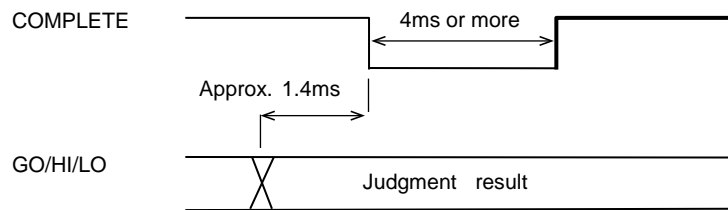

Warm-up time	1 hour after power up
Installation	Only indoor use
Operation environment	
Ambient temperature/humidity	0°C to 50°C (40°C and no dew allowed below the moisture amount of 80%RH.)
Altitude	2000 m or less(25°C or less)
Storage temp./humid.	-20°C to +60°C (40°C and no dew allowed below the moisture amount of 90%RH.)
Power supply	DM7560-1: AC100 ±10%, 50 Hz /60 Hz DM7560-3: AC115 ±10%, 50 Hz /60 Hz DM7560-6: AC220 ±10%, 50 Hz /60 Hz DM7560-8: AC240 ±10%, 50 Hz /60 Hz
Power consumption	21 VA or less (option included)
Withstand voltage	DC±500 V (between LO terminal and ground earth)
Installation (over voltage) category	Category II (local level, electric product and portable product)
Dimension	225(W)×100(H)×366(D) mm (protuberance such as leg, handle and knob excluded)
Weight	Approx. 3.0kg (protector and option included)
Expected life	
LCD 50%	reduction of LED back light brightness around 70,000 hours
Relay	Approx. 10 million times (at normal use condition without overload) Approx. 100, 000 times (at max. overload of 1,000 V applied voltage)
Data backup battery	5 years Note) These attach to the articles of consumption, and the exchange becomes a repair for a fee treatment.
Safety standard	Compliant standards EN61010-1, EN61010-2-030 • Overvoltage category (installation category) II ¹ • Measurement Category: II ² (300 V), O(1100 Vpeak) • Pollution degree 2 ³

- 1 The overvoltage category (installation category) is a value used to define the transient overvoltage condition and includes the rated impulse withstand voltage. Category I applies to electric equipment whose power is supplied from a circuit that incorporates withstand voltage control. Category II applies to electrical equipment that is powered through a fixed installation, such as a switchboard.
- 2 The measurement category of this instrument's signal input terminals varies depending on the modules that are installed. Use the instrument within the scope of the measurement category that corresponds to the module specifications. Do not use the instrument outside the scope of the measurement category that corresponds to the module specifications. The scope of each measurement category is as follows.

Measurement category Other (O) applies to measurement of circuits that are not directly connected to a main power supply.

This category applies to measurement of secondary electric circuits in equipment across a transformer.

Measurement category II applies to measurement of circuits, such as household electric appliances and portable electric tools, that are connected to low-voltage installations.

Measurement category III applies to measurement of facility circuits, such as distribution boards and circuit breakers.

Measurement category IV applies to measurement of power source circuits, such as entrance cables to buildings and cable systems, for low-voltage installations.

3. The pollution degree refers to the degree of adhesion of a solid, liquid, or gas which deteriorates withstand voltage or surface resistivity. Pollution degree 2 applies to normal indoor atmospheres (with only non-conductive pollution).

Emissions

Compliant standards

EN61326-1 Class A, EN 55011 Class A, Group 1, EMC Regulatory Arrangement in Australia and New Zealand EN 55011 Class A, Group 1,

Korea Electromagnetic Conformity Standard (한국 전자파적합성기준)

EN61000-3-2

EN61000-3-3

This product is a Class A (for industrial environments) product. Operation of this product in a residential area may cause radio interference in which case the user is required to correct the interference.

Immunity

Compliant standards

EN61326-1 Table 2(for industrial locations)

Environmental standard

Compliant standard: EN50581 Monitoring and instruments

4.2 Specifications of Basic Measuring Function

The Specifications after Chapter 4.2 depends on the following condition and definition.

Temp./humid. : 23 ± 5 °C, 80 %RH or less 1 year accuracy: ± (% reading value + % range)

Response time : Time that enters into accuracy within each range

4.2.1 Direct current voltage measurement (DCV)

4.2.1.1 Accuracy and resolution

Unit: ± (% of reading + % of range)

Range	Full scale at 6 and 1/2 digits	Resolution	Accuracy ± (% of reading + % of range)	Temperature coefficient ±(% of reading + % of range)/°C	Input impedance
100 mV	119.9999	0.1 μV	0.0050 + 0.0035	0.0005 + 0.0005	1 GΩ or more or 10 MΩ±1%
1 V	1.199999	1 μV	0.0040 + 0.0007		
10 V	11.99999	10 μV	0.0035 + 0.0005		
100 V	119.9999	0.1 mV	0.0045 + 0.0006		
1000 V	1100.000	1 mV	0.0045 + 0.0010		10 MΩ±1%

- Sampling rate : 1 S/s
- Maximum allowable voltage
 - 100 mV to 100 V range : ±800 V_{peak} (continuous), ±1100 V_{peak} (for 1 minute)
 - 1000 V range : ±1100 V_{peak} (continuous)
- Response time : Within 1 second

4.2.1.2 Noise rejection

PLC	NMRR 50 Hz/60 Hz±0.1%	CMRR 50 Hz/60 Hz*±0.1% Unbalance resistance1 kΩ
Multiple of 1PLC	55 dB	120 dB
Other than above	0 dB	-

* 50 Hz/60 Hz: Power frequency

4.2.2 Alternating current voltage (ACV)

4.2.2.1 Resolution and measuring range

True RMS, crest factor :<5

Range	Full scale	Resolution	Measuring range		Input impedance
			MID	HIGH	
100 mV	119.9999	0.1 μV	20 Hz to 300 kHz	200 Hz to 300 kHz	Approx. 1 MΩ// 100 pF or less
1 V	1.199999	1 μV			
10 V	11.99999	10 μV			
100V	119.9999	0.1 mV			
750 V	750.000	1 mV	20 Hz to 100 kHz	200 Hz to 100 kHz	

4.2.2.2 Accuracy

It specifies at 5% to 100% of each range.

Unit : \pm (% of reading+% of range)

Range	Frequency	Accuracy	Temp. coefficient
100.0000 mV	20 Hz to 45 Hz	0.70 + 0.04	0.070 + 0.004
	45 Hz to 100 Hz	0.20 + 0.04	0.020 + 0.004
	100 Hz to 20 kHz	0.06 + 0.04	0.005 + 0.004
	20 kHz to 50 kHz	0.12 + 0.05	0.011 + 0.005
	50 kHz to 100 kHz	0.60 + 0.08	0.060 + 0.008
	100 kHz to 300 kHz	4.00 + 0.50	0.200 + 0.020
1.000000 V to 750.000 V	20 Hz to 45 Hz	0.70 + 0.03	0.070 + 0.003
	45 Hz to 100 Hz	0.20 + 0.03	0.020 + 0.003
	100 Hz to 20 kHz	0.06 + 0.03	0.005 + 0.003
	20 kHz to 50 kHz	0.11 + 0.05	0.011 + 0.005
	50 kHz to 100 kHz	0.60 + 0.08	0.060 + 0.008
	100 kHz to 300 kHz	4.0 + 0.50	0.200 + 0.020

- Sampling rate: 2.5 S/s
- Sine wave input.
- Maximum allowable voltage 750 Vrms or 1100 Vpeak and DC content are ± 500 V or less.
- 750 V range is limited to 100 kHz or 8×10^7 V*Hz.
- Crest factor (CF) guarantees either 5 or smaller of maximum input voltage.

4.2.2.3 Additional error by AC filter setting

Unit: \pm (% of reading)

AC filter	20 Hz to 40 Hz	40 Hz to 100 Hz	100 Hz to 200 Hz	200 Hz to 1 kHz	Over 1 kHz
MID	0.22	0.06	0.01	0	0
HIGH		0.73	0.22	0.18	0

4.2.2.4 Additional tolerance by crest factor

Unit: \pm (% of range)

Crest factor	Additional error of Crest Factor	Additional error of bandwidth
1-2	0.1	$0.00015 \times f$
2-3	0.3	$0.00024 \times f$
3-4	0.5	$0.00060 \times f$
4-5	1.2	$0.00150 \times f$

*f is basic frequency [Hz] of input signal.

4.2 Specifications of Basic Measuring Function

4.2.3 Direct current measurement (DCI)

4.2.3.1 Accuracy and resolution

Unit: \pm (% of reading + % of range)

Range	Full scale at 6 and 1/2 digits	Resolution	Accuracy	Temp. coefficient	Shunt resistance
1 mA	1.199999	1 nA	0.050 + 0.060	0.0020 + 0.0050	90 Ω
10 mA	11.99999	10 nA	0.050 + 0.020	0.0020 + 0.0020	5 Ω
100 mA	119.9999	100 nA	0.050 + 0.005	0.0020 + 0.0005	5 Ω
1 A	1.199999	1 μ A	0.100 + 0.010	0.0050 + 0.0010	0.1 Ω
3 A	3.00000	10 μ A	0.120 + 0.020	0.0050 + 0.0020	0.1 Ω

- Sampling rate : 1 S/s
- Resolution applies to the status 6 and 1/2.
- Maximum allowable current
Full range: 3 ADC or 3 Arms (continuous, protection by 3 A fuse)

4.2.4 Alternating current measurement (ACI)

4.2.4.1 Resolution and measuring range

True RMS crest factor: <5

Range	Full scale	Resolution	Measuring range		Shunt resistance
			MID	HIGH	
1 A	1.199999	1 μ A	20 Hz to 5 kHz	200 Hz to 5 kHz	0.1 Ω
3 A	3.00000	10 μ A			

4.2.4.2 Accuracy

It specifies by 5 % to 100 % of each range.

Unit: \pm (% of reading + % of range)

Range	Frequency	Accuracy	Temp. coefficient
1 A	20 Hz to 45 Hz	0.70 + 0.04	0.100 + 0.006
	45 Hz to 100 Hz	0.30 0.04	0.035 + 0.006
	100 Hz to 5 kHz	0.10 + 0.04	0.015 + 0.006
3 A	20 Hz to 45 Hz	0.70 + 0.06	0.100 + 0.006
	45 Hz to 100 Hz	0.35 0.06	0.035 + 0.006
	100 Hz to 5 kHz	0.15 + 0.06	0.015 + 0.006

- Sampling rate: 2.5 S/s
- Sine wave input.
- Maximum allowable current
Full range: 3 Arms (continuous, protection by 3 A fuse)

4.2.4.3 Additional error by AC filter

Unit: \pm (% of reading)

AC filter	20 Hz to 40 Hz	40 Hz to 100 Hz	100 Hz to 200 Hz	200 Hz to 1 kHz	Over 1 kHz
MID	0.22	0.06	0.01	0	0
HIGH		0.73	0.22	0.18	0

4.2.4.4 Additional error by crest factor

Unit: \pm (% of range)

Crest factor	Additional error of Crest Factor	Additional error of bandwidth
1-2	0.1	0.00015 \times f
2-3	0.3	0.00024 \times f
3-4	0.5	0.00060 \times f
4-5	1.2	0.00150 \times f

- f is basic frequency [Hz] of input signal.

4.2.5.2 terminal resistance measurement (2W Ω)/4 terminal resistance measurement (4W Ω)

4.2.5.1 Resolution, accuracy and measuring current

Unit: \pm (% of reading+ % of range)

Range	Full scale	Resolution	Accuracy	Temp. coefficient	Measuring current
100 Ω	119.9999	0.1 m Ω	0.010 + 0.004	0.0006 + 0.0005	Approx. 1 mA
1k Ω	1.199999	1 m Ω	0.010 + 0.001	0.0006 + 0.0001	Approx. 1 mA
10k Ω	11.99999	10 m Ω	0.010 + 0.001	0.0006 + 0.0001	Approx. 100 μ A
100 k Ω	119.9999	0.1 Ω	0.010 + 0.001	0.0006 + 0.0001	Approx. 10 μ A
1 M Ω	1.199999	1 Ω	0.010 + 0.001	0.0010 + 0.0002	Approx. 5 μ A
10 M Ω	11.99999	10 Ω	0.040 + 0.001	0.0030 + 0.0004	Approx. 500 nA
100 M Ω	119.9999	100 Ω	0.800 + 0.010	0.1500 + 0.0002	Approx.500 nA //10 M Ω

- Sampling rate: 1 S/s
- This is accuracy by 6 and 1/2 digits resolution for 4 terminal resistance measurement or 2 terminal resistance measurement after zero compensation by NULL calculation. In the case NULL calculation is not performed, 0.2 Ω additional error is added to 2 terminal resistance measurement.
- Maximum allowable voltage
 - Between Ω -COM terminals: 800 Vpeak (continuous), or 1100 Vpeak (for 1 minute)
 - Between Sense Hi-Lo: 200 Vpeak
- Terminal open voltage <17 V

4.2.6 Continuity test (CONT ■■■)

4.2.6.1 Accuracy, resolution and measuring current

Unit: \pm (% of reading + % of range)

Resist. range	Resolution	Threshold	Accuracy	Temp. coefficient	Measuring current	Sampling rate
1 k Ω	10 m Ω	1 Ω to 1000 Ω	0.010 + 0.020	0.001 + 0.002	Approx.1 mA	100 S/s

- Sounding of electronics buzzer
- Maximum allowable voltage : 800 Vpeak (continuous), or 1100 Vpeak (for 1 minute)

4.2.7 Diode (▶)

4.2.7.1 Accuracy and measuring range

Unit: \pm (% of reading + % of range)

Measuring current	Measuring range	Accuracy	Temp. coefficient	Terminal open voltage	Sampling rate
Approx.1 mA	0.01 mV to 1.19999 V	0.010 + 0.020	0.001 + 0.020	<17 V	100 S/s

- Maximum allowable voltage : 800 Vpeak (continuous), or 1100 Vpeak (for 1 minute)

4.2.8 Temperature measurement (TEMP, TC: THERMOCOUPLE)

4.2.8.1 Accuracy and resolution

Unit: \pm (% of reading + °C)

Thermocouple	Measuring range (°C)	Accuracy	Resolution	Max. allowable voltage
R	-50 to 0	0.20 + 0.70	0.001°C	800 V _{peak} (continuous), 1100 V _{peak} (for 1 minute)
	0 to +100	0.20 + 0.50		
	+100 to +1765	0.20 + 0.30		
K(CA)	-200 to -100	0.15 + 0.50		
	-100 to 0	0.15 + 0.35		
	0 to +1370	0.15 + 0.20		
T(CC)	-200 to -100	0.15 + 0.50		
	-100 to 0	0.15 + 0.35		
	0 to +400	0.15 + 0.20		
J(IC)	-200 to -100	0.15 + 0.50		
	-100 to 0	0.15 + 0.35		
	0 to +1200	0.15 + 0.20		
E(CRC)	-200 to -100	0.15 + 0.50		
	-100 to 0	0.15 + 0.35		
	0 to +1000	0.15 + 0.20		

- Sampling rate: 1 S/s
- Thermocouple accuracy is not included.
- Cold junction temperature shall be input by TEMP/SENSOR menu and does not include its error.
- In calculational guarantee temperature 0°C to 18°C and 28°C to 50°C, $\pm 0.1^\circ\text{C}/^\circ\text{C}$ is added to all thermocouples.
- It is outside the accuracy guarantee though temperatures that are lower than -200°C might be displayed as measurements.
- Standard heat electromotive force depends on line graph approximate calculation by JIS C 1602.
- This instrument does not support internal reference junction compensation. Set the reference junction compensation temperature manually (see section 4.3.9 in the IM DM7560-01EN).
Internal reference junction compensation: A function that measures internally the input terminal temperature and compensates the temperature at the measurement point.

4.2.9 Temperature measurement (TEMP, RTD: Resistance temperature detector)

4.2.9.1 Measuring range, accuracy and resolution

RTD	Measuring range (°C)	Accuracy	Temp. coefficient	Resolution
Pt100	-200 to +850	$\pm 0.06^\circ\text{C}$	$\pm 0.003^\circ\text{C}/^\circ\text{C}$	0.001°C
JPt100	-200 to +510			

- Sampling rate: 1 S/s
- This complies with Pt100 : JIS C1604 standards.
- This complies with JPt100 : JIS C1604 standards.
- In 4 lead wire system, accuracy of measuring cable (or probe) is not included.
- Maximum allowable voltage : 800 V_{peak} (continuous), or 1100 V_{peak} (for 1 minute)

4.2.10 Frequency measurement (FREQ)

4.2.10.1 Accuracy, display digit number and measuring range

AC coupling, reciprocal system and crest factor<5

Gate time	Display digit number and measuring range	Accuracy (% of reading)			
		3 to 5 Hz	5 to 10 Hz	10 to 40 Hz	40 to 300k Hz
1 s	7 digits :3.000000 Hz to 300.0000 kHz	0.1	0.05	0.03	0.01
100 ms	6 digits:3.00000 Hz to 300.000 kHz	0.1	0.05	0.03	0.01
10 ms	5 digits:3.0000 Hz to 300.00 kHz	0.1	0.05	0.03	0.01
1 ms	4 digits:3.000 Hz to 300.0 kHz	0.1	0.05	0.03	0.01

- Maximum allowable voltage: 750 Vrms, or 1100 Vpeak (continuous), however DC content are ± 500 V or less.
- An input attenuator is the case when 100 mV to 750 V range of ACV is switched automatically or manually.
- An input range is 100 mVrms to 750 Vrms at 3 Hz to 100 kHz.
- However up to maximum 2.2×10^7 [V·HZ] in 100 kHz to 300 kHz
- An input 200 Vrms or more guarantees up to 100 kHz.
- In the input 3Hz or less and more than 300 kHz, measuring and display may be performed but it is out of accuracy guarantee.

4.3 Trigger function

Trigger mode

AUTO	Measures automatically in accordance with sampling rate and interval.
SINGLE	Measures in accordance with TRIG input.

Trigger source

Back TRIG input terminal (External trigger)	Polarity and valid/invalid are switchable by menu.
HOLD/TRIG key (Manual trigger)	Enters by key manually.
REMOTE	Please refer to the Communication Interface User's Manual (PDF files are stored in CD)

Trigger sample number

Setting range	1 to 100000
---------------	-------------

Trigger delay

Setting range	0.00 ms to 3600 s
Resolution	10 μ s

Interval

	Measuring interval setting of sampling
	*This is valid when larger value than current sampling rate is set.
Setting range	0.00 ms to 3600 s
Resolution	10 μ s

4.4 Calculation function

Please refer to various operations of the following Sections 4.4.1 to 4.4.6. Simultaneous setting is possible.

However combination of scaling calculation and decibel calculation cannot operate and set simultaneously.

4.4.1 SMOOTHING (Moving average) calculation

Average count Is selectable in range of 2 to 100 (positive integer).
*In case trigger is SINGLE, after it reaches the set average count, required trigger sample quantity is obtained.

4.4.2 NULL (Difference) calculation

Calculation Calculation result = RAW value - NULL value
RAW value Measured value of function at that time
NULL value Value set by following "NULL value setting".

Setting

Calculation ON/OFF On/Off are set by [NULL] key or NULL menu of each function.
*When turning on with the NULL key, the measured value at that time is set to NULL value of each function.

NULL value setting

It is possible to set it by three kinds (DEFAULT value, measurements, and a numeric input) when setting according to the NULL menu of each function.

Numerical setting by NULLVAL menu of each function manually.
With multiplier (p, n, μ , m, k, M, G, T), effective figures 7 digits

4.4.3 Scaling calculation

*This cannot be set with section 4.4.4 decibel calculation (dB calculation) simultaneously.

Calculation formula Two kinds of the following can be selected.
• Display value = (Measured value - A) * B/C
• Display value = D/Measured value

Constant The 4 constants of A, B, C, D are set.

Valid digit 7

Multiplier 8 types of p, n, μ , m, k, M, G, T

4.4.4 dB calculation

*This cannot be set with Section 4.4.3 Scaling (SCALING / dB) calculation simultaneously.

Calculation	Selection of dBV, dBm
dBm	Calculation result = $10 \cdot \log_{10} \{ (\text{measurements})^2 / (\text{standard resistance}) / (1.0 \times 10^{-3}) \}$
Standard resistance value	Unit Ω Selection from 4, 8, 16, 32, 50, 75, 93, 110, 124, 125, 135, 150, 200, 250, 300, 500, 600, 800, 900, 1000, 1200, 8000
dBV	Calculation result = $20 \cdot \log_{10} (\text{measurements} / \text{standard voltage})$
Standard voltage value	Selection from unit V, 1 μ V, 1mV, 1V
REL calculation	Is possible to set by above 2 calculations. Display of different value deducted dB standard value from calculation result.
dB standard value	It is possible to set by three kinds (DEFAULT value, measurements, and a numeric input).
Setting range	The range of a numeric input is ± 500.0000 . (Seven significant digits)
Appropriate function	Valid only for DCV, ACV function

4.4.5 STATISTIC calculation

Calculation	Calculates maximum value (MAX), minimum value (MIN), average value (AVE) and standard deviation (σ).
ON/OFF	Setting by menu
Display	Is possible to display on secondary display. The mean value cursor and the σ cursor are displayed in the histogram chart.

4.4.6 Limit calculation

Judgment	All function
ON/OFF	The Upper limit and the lower limit value can be enabled or disabled individually.
Limit value	The upper limit and the lower limit values are set in seven significant digits with eight kinds of multiplier (p,n, μ ,m,k,M,G,T).
HIGH	Measurement value > the upper limit value
LOW	Measurement value < the lower limit value
GO	When either or both HIGH judgment and LOW judgment is ON
---	State that is neither HIGH nor LOW.
Setting range	Seven significant digits With eight kinds of multiplier (p,n, μ ,m,k,M,G,T)
Display	
Trend chart	Displays HIGH/LOW threshold line in graphics.
Histogram chart	Displays HIGH/LOW marks and threshold line in graphics.
LIMIT judgment	Displays HIGH/GO/LOW on upper part of screen, primary display and secondary display.

4.5 Log function

Log mode	Switchable between 2 modes; i.e. NORMAL and BULK
Data size	
NORMAL mode	100 k Readings fixed
BULK mode	Selectable from; 1 k, 2 k, 5 k, 10 k, 20 k, 50 k, and 100 k (Units: Readings)
Data to be Saved	The following are saved: <ul style="list-style-type: none"> • Measurement data • Logged date and time • Name of each function • Configuration information of each function <p>* The calculation name is displayed when NULL, dB, or SCALING calculation is set on.</p>
Export function	Outputting the measurement data stored in the LOG memory to the USB memory.
File format	Text file
Saved data	Measurement data of function
Logging time	ON/ OFF can be set. * When set ON, the date and time are saved.
Format	YYYY/MM/DD HH:mm:SS, xxxxxx * x: unit of μ sec
Attribute information	ON/ OFF can be set. * The calculation name in the ON status (i.e. NULL, dB, or SCALING) is saved.

4.5.1 NORMAL mode

It is a mode stored in the LOG memory while in real time monitoring the measurement data. The sampling rate is not guaranteed.

After acquiring log data count	When the number of acquired data pieces exceeds 100 k Readings, the mode continues by the FIFO* operation. * FIFO: First In, First Out (First-in data is processed in sequence.)
Log data clear	It is cleared at the following. <ul style="list-style-type: none"> • INITIALIZE action by DISPLAY menu (M5 key is pressed) • PUSH action when the rotary knob is invalid • Additionally, refer to the clear condition table of each data of section 6.4 in the use's manual(IM DM7560-01EN).

4.5.2 BULK mode

It is a mode that guarantees the sampling rate though the measurement data cannot be in real time monitored.

It cannot operate as the SINGLE mode of the TRIG menu.

LOG start	Data acquisition starts by executing START LOG menu (pressing M4 key).
LOG stop	By 2 methods below <ul style="list-style-type: none">• After the stop event occurs, the data corresponding to the number of post triggers has been completely acquired.• Executing STOP LOG menu (pressing M4 key)
STOP EVENT	Selectable from 3 kinds below:
NONE	No condition of stop event
EXT TRIG	It makes the external trigger input an event.
LEVEL	It is used as the stop event when the measurement data exceeds a threshold value and sets two parameters below:
THRESHOULD	Setting range: 7-digit significant figure is used for setting(with multiplier)Multiplier: 8 types of p, n, μ , m, k, M, G, and T
SLOPE (polarity)	Selectable from Positive / Negative
LIMIT	Selectable from 4 limit judgments of GO/ NOGO (Hi or Lo)/ Hi/ Lo
POST Readings (Number of post triggers)	Settable in the 1% unit of preset MEM LENGTH (log data length) 0 to 100 % (Resolution: 1 %) If an event occurs before the number of pre-triggers is reached, the total data amount is reduced.

4.6 Screen display switching

4.6.1 Primary display

Numeric value display	
Size	NORMAL, LARGE
Font	NORMAL (Gothic), 7SEG.
Trend chart display	Refer to 4.7.
Histogram chart display	Refer to 4.8.
Arc scale meter display	Refer to 4.9.
LIMIT display	Displays judgment result of LIMIT calculation.

4.6.2 Secondary display (in online)

Numeric value display	Enabled if the primary display shows other than numeric values.
Analog meter display	Refer to 4.10.
Statistics display	Enabled if statistics calculation is set ON.
LIMIT display	Enabled if LIMIT judgment is set ON. * Enabled if HIGH of LIMIT calculation is ON or LOW is ON.
Time display	Enabled for trend chart display.
BIN information display	Enabled for histogram chart display
Cursor display of histogram chart	Enabled for histogram chart display

4.6.3 Secondary display (in offline)

Time cursor display	Enabled for trend chart display/ histogram chart display
Voltage cursor display	Enabled for trend chart display/ histogram chart display
BIN information display	Enabled for histogram chart display
Cursor display of histogram chart	Enabled for histogram chart display
Statistics display	Enabled for trend chart display/ histogram chart display

4.7 Trend chart display function

4.7.1 Online trend chart display function

Displayed data number	For maximum 100 k Readings
Horizontal axis	401 dots (10 div)
Vertical axis	121 dots (12 div)
Display method	At first data is displayed from left, and when wave form reached screen right end, compression is displayed. After compression display of 100 k, it becomes roll mode display.
Vertical axis	
MANUAL	Is possible to specify range and offset.
Range	1 p / div to 500 T / div (1-2-5 steps) *p: pico, T: terra
Offset	-100000 div to +100000 div
Offset setting resolution	1 div
AUTO	Displays by updating to scale which is possible to display max/min values of measured data from obtained data automatically.
APPLY TO MANUAL	The content of the range and the offset set automatically is reflected in the MANUAL mode.
FULLSCALE	Max/min values of measuring range is displayed by scale which is possible to display. The following condition is impossible to select FULLSCALE. (If it is set to FULLSCALE, it becomes AUTO.) • In case function is in frequency measurement (FREQ) • In case SCALING calculation (D/X) has been set. * Moreover, when the data measured by a different range exists together on the trend chart, it becomes FULLSCALE of the highest in that range.
Data clear	As for a clear condition of the measurement result, refer to section 4.9.1 or 6.4 in the use's manual(IM DM7560-01EN).

4.7.2 Offline trend chart display function

The case where the trend chart display is selected when the offline browse mode is entered in LOG menu is called the "offline trend chart display." At that time, the data in the LOG memory is displayed.

VERTICAL (vertical axis)	Same setting as online setting can be made.
HORIZONTAL (horizontal axis)	
Readings/div	Data amount displayed per 1div 1, 2, 5, 10, 20, 50, 100, 200, 500, 1 k, 2 k, 5 k, 10 k
CENTER ADDR	0 to number of data of LOG memories
SHOW ALL	The entire LOG memory is displayed.
T1, T2 cursor function	
KNOB (cursor selection)	It selects the cursor which moves when the rotary knob is rotated. Selectable from 3 methods below: TCURSOR1(T1 cursor)/ TCURSOR2 (T2 cursor)/ TRACK
Cursor initial position	Just after the offline trend chart display is entered, T1 cursor moves the address of the beginning data of LOG and T2 cursor moves the address of the last data of LOG.
Histogram relation to statistics calculation	It decides the range of object of statistics calculation and the data range to display the total amount in the offline histogram chart display.
SET DISP POSITION function	It sets the address of the selected cursor at the center on the screen. (Set to CENTER ADDR.) If the selected cursor is TRACK, RDGs/div is set to the expansion ratio so that both of T1 and T2 cursors are included and CENTER ADDR is the center of T1 and T2 cursors.
SEARCH MODE (edge search)	The function makes jump to the nearest data depending on the condition below in the direction of rotating the rotary knob. <ul style="list-style-type: none"> • LIMITGO : GO of LIMIT judgment • LIMITNOGO : NOGO of LIMIT judgment • LIMITHIGH : HIGH of LIMIT judgment • LIMITLOW : LOW of LIMIT judgment • EDGEPOSITIVE : Data when the edge level is crossed in the positive direction • EDGENEGATIVE : Data when the edge level is crossed in the negative direction • EDGEBOTH : Data when the edge level is crossed in both directions
EDGE LEVEL	Settable when EDGEPOSITIVE / EDGENEGATIVE / EDGEBOTH is selected in the edge search function
Setting range	Seven significant digits Multiplier: 8 types of p, n, μ , m, k, M, G, and T
Secondary display	
Time display	Time of points of T1 and T2 cursors Data amount between T1 and T2 cursors Time difference between T1 and T2 cursors
Voltage display	Measurement value of points of T1 and T2 cursors Maximum and minimum values of measurement data which is compressed and displayed in the same row as the cursor point on the screen

4.8 Histogram chart display function

4.8.1 Online histogram chart display function

Vertical axis	BIN with the highest occurrence frequency is displayed as MAX 100 pix.
Display unit	Selectable from COUNT and PERCENT
Horizontal axis	3 types for each mode of MANUAL, AUTO, and FULLSCALE
No. of BINs	Selectable from: 2, 4, 5, 10, 20, 40, 50, 100, 200, and 400
MANUAL	
Center value	An arbitrary value is set by 7-digit significant figure with multiplier Multiplier: 8 types of p, n, μ , m, k, M, G, and T
Span	$\pm 100p$ to $\pm 500T$ Set by 1-2-5 step with multiplier Multiplier: 8 types of p, n, μ , m, k, M, G, and T
AUTO	By using the maximum and minimum values of the data collected in this period, the center value and span of the histogram are decided.
APPLY TO MANUAL	The content of the range and the offset set automatically is reflected in the MANUAL mode. * However, it is rounded according to the set resolution capability of the MANUAL mode.
FULLSCALE	A central value of the histogram and span are additionally decided full-scale about the measurement range. It clears the data of the histogram once when the range including an automatic change by an auto range changes. Since the conditions below do not decide the maximum and minimum values of FULLSCALE, this mode is handled as AUTO mode. <ul style="list-style-type: none">• If the function is FREQ or TEMP• If the scaling (SCALING calculation: D/X) is set• If dB calculation is set
Data clear	As for a clear condition of the measurement result, refer to section 4.10.1.2 or 6.4 in the IM DM7560-01EN.
Statistical cursor	The positions of the average value \bar{x} and standard deviation σ are indicated by cursors. (Statistics calculation is on.)
Standard deviation σ	Selectable from 1, 2, and 3
H1, H2 cursor function	
KNOB (cursor selection)	When the rotary knob is rotated, the moving cursor can be selected from: HCURSOR1 (H1 cursor)/ HCURSOR2 (H2 cursor)/ TRACK
Secondary display	Range of BIN measurement value of H1 and H2 cursors Count of BIN of H1 and H2 cursors Range of measurement value between H1 and H2 cursors Count and ratio (%) between H1 and H2 cursors

4.8.2 Offline histogram chart display function

The case where the histogram chart display is selected when the offline browse mode is entered in LOG menu is called the "offline histogram chart display." At that time, the data in the LOG memory is displayed.

The setting method of the display mode, BIN count, vertical axis, horizontal axis, and cursor function is the same as the online mode. Even if the display condition is changed, redisplay is possible without clearing the LOG memory.

Relation to trend chart display

The target data to be collected and displayed is the data between T1 and T2 cursors in the trend chart display

4.9 Arc scale meter (ARC SCALE METER) display function

The function can be set with the parameter independent of the analog meter on the secondary display.

MODE	One item is selected from AUTO/ FULLSCALE/ MANUAL/ LOG. * However, FULLSCALE cannot be selected only for frequency measurement (FREQ).
AUTO	Max. and Min. values of measurement data in the acquired data are automatically displayed. Display is done while updating to the possible scale.
FULLSCALE	FULLSCALE of the measurement range is max. or min. value.
MANUAL	
Range	500 T/div to 1 p/div (can be set with 1-2-5 steps) Displayed with offset of ± 6 div.
Offset	-100.000 kdiv to 100.000 kdiv
LOG	
LOG MAX	10.0 p/div to 100.0 T/div (can be set with 10-time step)
LOG MIN	1.0 p/div to 10.0 T/div (can be set with 10-time step)
	Note 1) 10 times or more and 106 times or less between LOG MAX and LOG MIN
	Note 2) Absolute value is displayed if the acquired data is the minus value.
	Note 3) Positive value is valid in HIGH/ LOW setting range of LIMIT calculation.
APPLY TO MANUAL	Function to copy AUTO mode range and offset setting to MANUAL mode
TITLE	Function to display characters (alphabets, numbers, symbols) in the center of the meter
Display	Selected from UNIT/ BLANK/ TEXT
UNIT	Function unit is displayed
BLANK	Blank (not displayed)
TEXT	Up to 8 arbitrary characters are displayed.

4.10 Analog meter (ANALOG METER) display function

MODE	One item is selected from AUTO/ FULLSCALE/ MANUAL/ LOG * However, FULLSCALE cannot be selected only for frequency measurement (FREQ).
AUTO	Max. and Min. values of measurement data in the acquired data are automatically displayed. Display is done while updating to the possible scale.
APPLY TO MANUAL	Reflecting automatically set range and offset content on MANUAL mode
FULLSCALE	FULLSCALE of the measurement range is max. or min. value.
MANUAL	
Range	500 T/div to 1 p/div (can be set with 1-2-5 steps) Displayed with offset of ± 6 div.
Offset	-100.000 kdiv to 100.000 kdiv
LOG	
LOG MAX	10.0 p/div to 100 .0 T/div (can be set with 10-time step)
LOG MIN	1.0 p/div to 10 .0 T/div (can be set with 10-time step)
	Note 1) 10 times or more and 106 times or less between LOG MAX and LOG MIN
	Note 2) Absolute value is displayed if the acquired data is the minus value.
	Note 3) Positive value is valid in HIGH/ LOW setting range of LIMIT calculation.
APPLY TO MANUAL	Function to copy AUTO mode range and offset setting to MANUAL mode.

4.11 Save / recall setting of SETUP condition

POWER ON RECALL

LAST

DEFAULT

RECALL

Setting condition when powering on can be selected from:

Setting condition at the last powering off

Factory setting condition

Setting condition recalled by specifying the number from the data of the internal SETUP memory

SAVE/RECALL

Save destination

Number of internal

External control

Internal or USB memory

memories: 10

It internal sets up by an external signal of RS-232 by using the control signal allocated in the pin not used to communicate with PC.

Function to call memory sequentially

(allowed only when LAN & RS-232 interface /C2 option is equipped)

Input signal

Level

Maximum rating

Time width

INC

DEC

BEGIN

H: +2.0 Vmin, L: +0.8 Vmax

±15 V

Positive polarity, 10 ms or more

Recall is done while forwarding SETUP memory number.

Recall is done while SETUP memory number goes back.

Recall is done while SETUP memory number goes back to the initial value.

Output signal

BUSY

Indicates whether the input signal can be accepted.

- Acceptable at L level

- Pulse is ignored at H level.

Level

H: +5.0 Vmin, L: -5.0 Vmax

Pin number and signal name

Signal names	PIN numbers
INC	1
GND	5
DEC	6
BUSY	7
BEGIN	9

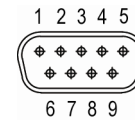

4.12 Setting of System

Remote (REMOTE)	The following can be selected.
At GPIB option attached	USB, GPIB
At LAN&RS-232 option attached	USB, LAN, RS-232
USB IF setting parameter	
Delimiter	CR+LF, LF
Command	SCPI
GPIB IF setting parameter	
Address	0 to 30
Delimiter	CR+LF, LF
Command	SCPI,
LAN IF Setting parameter	
DHCP	ON/OFF is set.
IP address	Sets by installation environment.
Gateway	Sets by installation environment.
Subnet mask	Sets by installation environment.
Delimiter	CR+LF, LF
Command	SCPI
RS-232 IF setting parameter	
Parity	NONE, EVEN, ODD
Stop bit	1bit, 2bit
Bit rate	Selects from 300, 600, 1200, 2400, 4800, 9600, 19200, 38400bps.
Delimiter	CR+LF, LF
Command	SCPI
Beep sound (BEEP)	The following 3 can be set independently.
KEY (When the key is operated.)	ON/OFF is set.
CAUTION (When the error occurs.)	ON/OFF is set.
LIMIT judgment	ON/OFF/NO-GO is set
Equipment setting (SETUP)	
Animation	ON/OFF of animation of menu
Screen header	The following 3 can be set.
	<ul style="list-style-type: none"> • DATE TIME : Displays current date and time. • SETUP NAME : Displays name of setting condition.
• OFF : No header displayed.	
DATE TIME	Sets by YYYY/MM/DD HH:mm.
PLC	Detection display and setting of power frequency
AUTO	Setting by detecting automatically at the time of power-up.
MANUAL	50 Hz/60Hz are switchable manually.
Copy (COPY)	Setting of hard copy relation to USB memory
Mode	operation when [COPY] key is pressed.
Screen hard copy	Saves screen data.
Numerical data	Measured value, date and function are added by 1 line with text file.
Hard copy output setting	
Format	
File format	PNG, BMP, TIFF
Color number setting	Color, Gray scale
Directory	Setting of folder name of USB memory

4.12 Setting of System

File name	Setting of file name of hard copy data to be saved.
Setting of output measurement data	
Action	
ONE TIME	Outputting the latest only one measurement result when pushing [COPY] key
CONTINUOUS	Beginning / Stopping an USB memory continuous writing with the [COPY] key This instrument outputs every time a new measurement result is acquired while executing a continuous writing in the USB memory.
Directory	Setting of folder name of USB memory
File name	Setting of file name of numerical data to be saved
Time stamp	ON/OFF of date information
Attribute	Presence of measurement function, and calculation of NULL, SCALING, and dB
TOOLS	Maintenance related menu of the instrument
Status information display	Displays information such as model name, firmware version, etc.
Setting condition initialization	Sets to setting condition at the time of factory shipment (execution).
Panel lock	ON/OFF of key Calculation when key is pressed.
Firmware updates	Setting on update of firmware
Calibration	Self-calibration by user

4.13 Appearance drawing

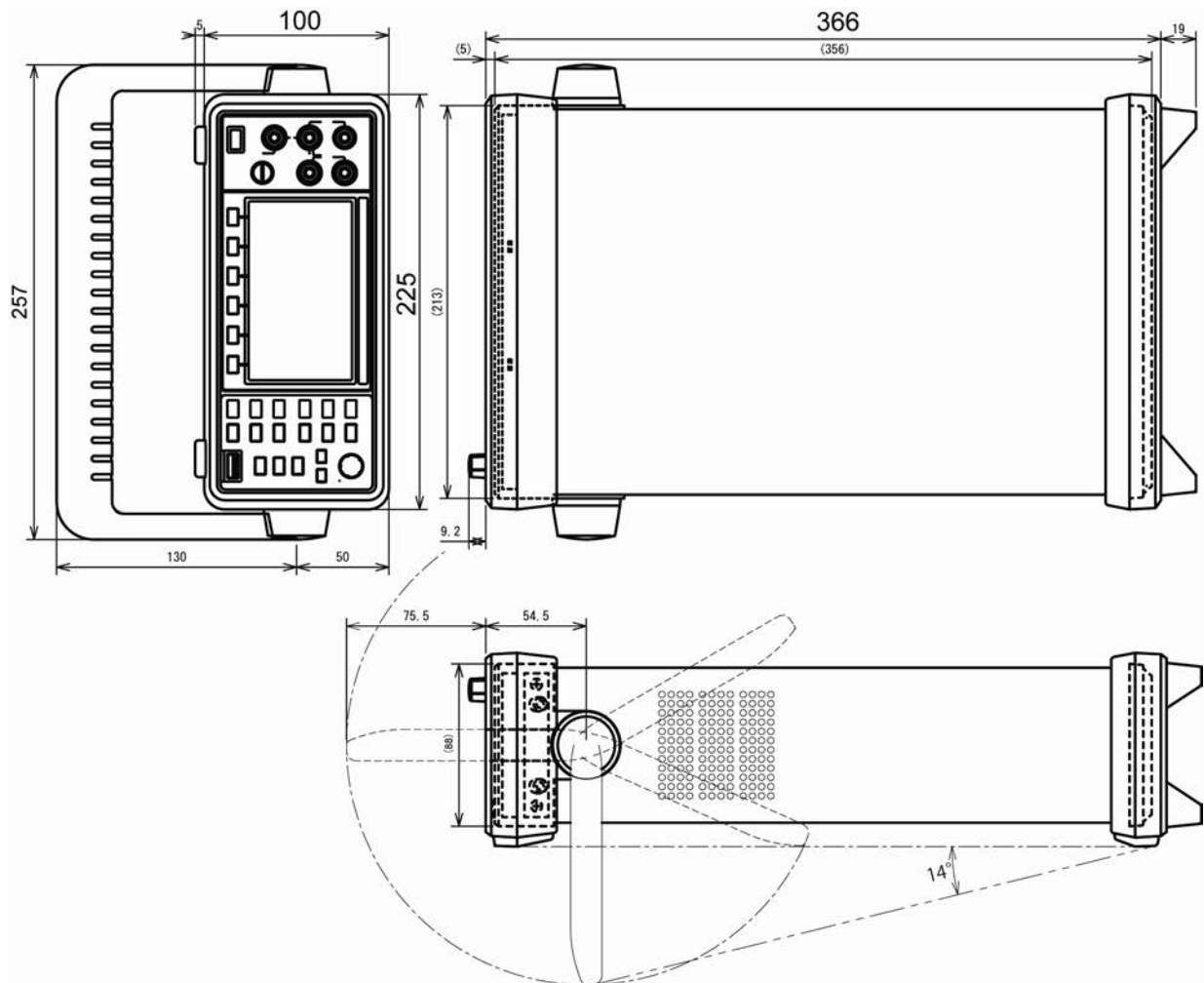

Unit: mm

Unless otherwise specified, tolerances are $\pm 3\%$
(however, tolerances are ± 0.3 mm when below 10 mm).