

SUPERtrol II

FLOW COMPUTER

THIRD EDITION



KEP

KESSLER-ELLIS PRODUCTS

10 Industrial Way East
Eatontown, NJ 07724

800-631-2165 • 732-935-1320

Fax: 732-935-9344

kep.com
<http://www.kep.com>



CONTENTS

SAFETY INSTRUCTIONS	1
1. INTRODUCTION	
1.1 Unit Description	2
1.2 Specifications	3
2. INSTALLATION	
2.1 General Mounting Hints.....	8
2.2 Mounting Diagrams	8
3. APPLICATIONS	
3.1 Steam Mass.....	13
3.2 Steam Heat.....	11
3.3 Steam Net Heat.....	13
3.4 Steam Delta Heat.....	14
3.5 Corrected Gas Volume	15
3.6 Gas Mass	16
3.7 Gas Combustion Heat	17
3.8 Corrected Liquid Volume	18
3.9 Liquid Mass	19
3.10 Liquid Combustion Heat.....	20
3.11 Liquid Sensible Heat.....	21
3.12 Liquid Delta Heat.....	22
3.13 Steam – Condensate Heat	23
4. WIRING	
4.1 Terminal Designations	24
4.2 Typical Wiring Connections	25
4.2.1 Flow Input.....	25
4.2.2 Stacked DP Input.....	25
4.2.3 Pressure Input	25
4.2.4 Temperature Input	26
4.2.5 Temperature 2 Input	26
4.3 Wiring In Hazardous Areas.....	29
4.3.1 Flow Input.....	27
4.3.2 Pressure Input	27
4.3.3 Temperature Input	27
5. UNIT OPERATION	
5.1 Front Panel Operation Concept for Operate Mode.....	28
5.2 General Operation.....	29
5.3 Password Protection.....	29
5.4 Relay Operation.....	29
5.5 Pulse Output	29
5.6 Analog Outputs	29
5.7 Function Keys; Display Grouping	29
5.8 RS-232 Serial Port Operation.....	30
5.8.1 PC Communications.....	30
5.8.2 Operation of RS-232 Serial Port with Printers	30
5.9 RS-485 Serial Port Operation.....	30
5.10 Pause Computations Prompt.....	30
6. PROGRAMMING	
6.1 Front Panel Operation Concept for Program Mode.....	31
6.2 EZ Setup	32
6.3 Detailed Menu Descriptions.....	34
6.4 System Parameters	35
6.5 Display	40
6.6 System Units	42
6.7 Fluid Data	49
6.8 Flow Input.....	54
6.9 Other Input.....	66
6.10 Pulse Output.....	69
6.11 Current Output	70
6.12 Relays.....	74
6.13 Communication.....	78
6.14 Network Card.....	85
6.15 Service & Analysis	86

CONTENTS

7. PRINCIPLE OF OPERATION	
7.1 General.....	92
7.2 Square Law Flowmeter Considerations.....	92
7.3 Flow Equations.....	92
7.3.1 Flow Input Computation.....	92
7.3.2 Pressure Computation.....	93
7.3.3 Temperature Computation.....	93
7.3.4 Density/Viscosity Computation.....	93
7.3.5 Corrected Volume Flow Computation.....	94
7.3.6 Mass Flow Computation.....	95
7.3.7 Combustion Heat Flow Computation.....	95
7.3.8 Heat Flow Computation.....	96
7.3.9 Sensible Heat Flow Computation.....	96
7.3.10 Liquid Delta Heat Computation.....	96
7.3.11 Expansion Factor Computation for Square Law Flowmeters.....	96
7.3.12 Uncompensated Flow Computation.....	99
7.3.13 ILVA Flow Meter Equations.....	100
7.4 Computation of the D.P. Factor.....	101
8. RS-232 SERIAL PORT	
8.1 RS-232 Serial Port Description.....	102
8.2 Instrument Setup by PC Over Serial Port.....	102
8.3 Operation of Serial Communication Port with Printers.....	102
8.4 SUPERtrol II RS-232 Port Pinout.....	102
9. RS-485 SERIAL PORT	
9.1 RS-485 Serial Port Description.....	103
9.2 General.....	103
9.3 Operation of Serial Communication Port with PC.....	103
9.4 SUPERtrol II RS-485 Port Pinout.....	103
10. FLOW COMPUTER SETUP SOFTWARE	
10.1 System Requirements.....	104
10.2 Cable and Wiring Requirements.....	104
10.3 Installation for Windows™ 3.1 or 3.11.....	104
10.4 Using the Flow Computer Setup Software.....	104
10.5 File Tab.....	105
10.6 Setup Tab.....	105
10.7 View Tab.....	106
10.8 Misc. Tab.....	106
11. GLOSSARY OF TERMS	
10 Glossary Of Terms.....	107
12. Diagnosis and Troubleshooting	
12.1 Response of SUPERtrol II on Error or Alarm.....	110
12.2 Diagnosis Flowchart and Troubleshooting.....	110
12.3 Error Messages.....	111
Appendix A	
Fluid Properties Table.....	114
Appendix B - Setup Menus	
Setup Menus with Operator Code Access.....	115
Setup Menus with Supervisor Code Access.....	116
Appendix C - RS-485 Modbus Protocol	
Description.....	117
Wiring Pinout and Installation.....	118
Register and Coil Usage.....	120
Warranty.....	123
Decoding Part Number.....	123



SAFETY INSTRUCTIONS

The following instructions must be observed.

- This instrument was designed and is checked in accordance with regulations in force EN 60950 (“Safety of information technology equipment, including electrical business equipment”). A hazardous situation may occur if this instrument is not used for its intended purpose or is used incorrectly. Please note operating instructions provided in this manual.
- The instrument must be installed, operated and maintained by personnel who have been properly trained. Personnel must read and understand this manual prior to installation and operation of the instrument.
- The manufacturer assumes no liability for damage caused by incorrect use of the instrument or for modifications or changes made to the instrument.

Technical Improvements

- The manufacturer reserves the right to modify technical data without prior notice.

1. Introduction

1.1 Unit Description:

The SUPERtrol II (SUPERtrol II) Flow Computer satisfies the instrument requirements for a variety of flowmeter types in liquid, gas, steam and heat applications. Multiple flow equations are available in a single instrument with many advanced features.

The alphanumeric display offers measured parameters in easy to understand format. Manual access to measurements and display scrolling is supported.

The versatility of the Flow Computer permits a wide measure of applications within the instrument package. The various hardware inputs and outputs can be "soft" assigned to meet a variety of common application needs. The user "soft selects" the usage of each input/output while configuring the instrument.

The isolated analog output can be chosen to follow the volume flow, corrected volume flow, mass flow, heat flow, temperature, pressure, or density by means of a menu selection. Most hardware features are assignable by this method.

The user can assign the standard RS-232 Serial Port for data logging, or transaction printing, or for connection to a modem for remote meter reading.

A PC Compatible software program is available which permits the user to rapidly redefine the instrument configuration.

Language translation option features also permit the user to define his own messages, labels, and operator prompts. These features may be utilized at the OEM level to creatively customize the unit for an application or alternately to provide for foreign language translations. Both English and a second language reside within the unit.

NX-19 option

Advanced ordering options are available for Natural Gas calculations where the user requires compensation for compressibility effects. Compensation for these compressibility effects are required at medium to high pressure and are a function of the gas specific gravity, % CO₂, % Nitrogen, as well as temperature and pressure. The compressibility algorithm used is that for NX-19.

Stacked differential pressure transmitter option

This option permits the use of a low range and high range DP transmitter on a single primary element to improve flow transducer and measurement accuracy.

Peak demand option

This option permits the determination of an hourly averaged flow rate. Demand last hour, peak demand and time/date stamping for applications involving premium billing.

Data logging option

This option provides data storage information in 64k of battery backed RAM. Items to be logged, conditions to initiate the log and a variety of utilities to clear and access the data via the RS-232 port are provided.

Peak Demand Option

There are applications where customer charges are determined in part by the highest hourly averaged flowrate observed during a billing period.

The peak demand option for the SUPERtrol II is intended for applications where it is important to compute such an hourly average flowrate, to note the value of the peak occurrence and the corresponding time and date of that event.

The demand last hour rate is computed based on the current total and the total 60 minutes prior. This value is recomputed every 5 minutes.

The peak demand is the highest value observed in the demand last hour.

The time and date stamp is the time and date at which the highest peak demand occurred.

The Demand Last Hour and/or Peak Demand can be directly viewed on the display by pressing the RATE key and then scrolling through the rates with the \wedge/v arrow key until the desired item is viewed.

The Peak Time and Date stamp can be viewed on the display by pressing the TIME and then scrolling through the time related parameters using the \wedge/v arrow keys until the desired item is viewed.

All of these items can be included into the scrolling display list along with the other process values and totalizers in a user selectable list.

The peak demand may be cleared by pressing the CLEAR key while viewing the PEAK DEMAND or by means of a command on the serial port.

The Peak Time and Date stamp can be viewed on the display by pressing the TIME and then scrolling through the time related parameters using the \wedge/v arrow keys until the desired item is viewed.

The Demand Last Hour and Peak Demand can be assigned to one of the analog outputs. The demand last hour or peak demand could thusly be output on a recording device such as a strip chart recorder or fed into a building energy automation system.

The Demand Last Hour and Peak Demand can be assigned to one of the relays. The customer can be notified that he is approaching or exceeding a contract high limit by assigning the demand last hour to one of the relays and setting the warning point into the set point. A warning message would also be displayed.

The peak demand may be used in conjunction with the print list and data logger to keep track of hourly customer usage profiles.

The Demand Last Hour, Peak Demand, and Time and Date Stamp information can be accessed over the serial ports. The Peak Demand may also be reset over the serial ports.

The peak demand option may also be used as a condition to call out in remote metering by modem.

EZ Setup

The unit has a special EZ setup feature where the user is guided through a minimum number of steps to rapidly configure the instrument for the intended use. The EZ setup prepares a series of questions based on flow equation, fluid, and flowmeter type desired in the application.

1.2 Specifications:

Environmental

Operating Temperature: 0 to +50 C
 Storage Temperature: -40 to +85 C
 Humidity : 0-95% Non-condensing
 Materials: UL, CSA, VDE approved

Approvals: CE Approved Light Industrial, UL/CSA Pending

Display

Type: 2 lines of 20 characters
 Types: Backlit LCD, OLED and VFD ordering options
 Character Size: 0.2" nominal
 User selectable label descriptors and units of measure

Keypad

Keypad Type: Membrane Keypad
 Keypad Rating: Sealed to Nema 4
 Number of keys: 16
 Raised Key Embossing

Enclosure

Enclosure Options: Panel, Wall, Explosion Proof
 Size: See Chapter 2; Installation
 Depth behind panel: 6.5" including mating connector
 Type: DIN
 Materials: Plastic, UL94V-0, Flame retardant
 Bezel: Textured per matt finish
 Equipment Labels: Model, safety, and user wiring

NX-19 Compressibility Calculations

Temperature	-40 to 240 F
Pressure	0 to 5000 psi
Specific Gravity	0.554 to 1.0
Mole % CO2	0 to 15%
Mole % Nitrogen	0 to 15%

Power Input

The factory equipped power options are internally fused. An internal line to line filter capacitor is provided for added transient suppression. MOV protection for surge transient is also supported

Universal AC Power Option:
 85 to 276 Vrms, 50/60 Hz
 Fuse: Time Delay Fuse, 250V, 500mA

DC Power Option:
 24 VDC (16 to 48 VDC)
 Fuse: Time Delay Fuse, 250V, 1.5A
 Transient Suppression: 1000 V

Flow Inputs:

Flowmeter Types Supported:

Linear:
 Vortex, Turbine, Positive Displacement, Magnetic, GilFlo, GilFlo 16 point, ILVA 16 Point, Mass Flow and others

Square Law:
 Orifice, Venturi, Nozzle, V-Cone, Wedge, Averaging Pitot, Target, Verabar, Accelabar and others

Multi-Point Linearization:
 May be used with all flowmeter types. Including: 16 point, UVC and dynamic compensation.

Analog Input:

Ranges

Voltage: 0-10 VDC, 0-5 VDC, 1-5 VDC
 Current: 4-20 mA, 0-20 mA

Basic Measurement Resolution: 16 bit
 Update Rate: 2 updates/sec minimum
 Accuracy: 0.02% FS

Automatic Fault detection: Signal over/under-range,
 Current Loop Broken

Calibration: Operator assisted learn mode. Learns Zero and Full Scale of each range

Fault Protection:

Fast Transient: 1000 V Protection (capacitive clamp)
 Reverse Polarity: No ill effects
 Over-Voltage Limit: 50 VDC Over voltage protection
 Over-Current Protection: Internally current limited protected to 24 VDC

Optional: Stacked DP transmitter 0-20 mA or 4-20 mA

Pulse Inputs:

Number of Flow Inputs: one
 Input Impedance: 10 kΩ nominal
 Trigger Level: (menu selectable)
 High Level Input
 Logic On: 2 to 30 VDC
 Logic Off: 0 to .9 VDC
 Low Level Input (mag pickup)
 Selectable sensitivity: 10 mV and 100 mV

Minimum Count Speed: 0.25 Hz

Maximum Count Speed: Selectable: 0 to 40 kHz

Overvoltage Protection: 50 VDC

Fast Transient: Protected to 1000 VDC (capacitive clamp)

Temperature, Pressure, Density Inputs

The compensation inputs usage are menu selectable for temperature, temperature 2, pressure, density, steam trap monitor or not used.

Calibration: Operator assisted learn mode

Operation: Ratiometric

Accuracy: 0.02% FS

Thermal Drift: Less than 100 ppm/C

Basic Measurement Resolution: 16 bit

Update Rate: 2 updates/sec minimum

Automatic Fault detection:

Signal Over-range/under-range

Current Loop Broken

RTD short

RTD open

Transient Protection: 1000 V (capacitive clamp)

Reverse Polarity: No ill effects

Over-Voltage Limit (Voltage Input): 50 VDC

Over-Current Limit (Internally limited to protect input to 24 VDC)

Available Input Ranges

(Temperature / Pressure / Density / Trap Monitor)

Current: 4-20 mA, 0-20 mA

Resistance: 100 Ohms DIN RTD

100 Ohm DIN RTD (DIN 43-760, BS 1904):

Three Wire Lead Compensation

Internal RTD linearization learns ice point resistance

1 mA Excitation current with reverse polarity protection

Temperature Resolution: 0.1°C

Temperature Accuracy: 0.5°C

Datalogger (optional)

Type: Battery Backed RAM
 Size: 64k
 Initiate: Key, Interval or Time of Day
 Items Included: Selectable List
 Data Format: Printer or CSV Access via RS-232 command

Stored Information (ROM)

Steam Tables (saturated & superheated), General Fluid Properties, Properties of Water, Properties of Air, Natural Gas

User Entered Stored Information (EEPROM / Nonvolatile RAM)

Transmitter Ranges, Signal Types
 Fluid Properties
 (specific gravity, expansion factor, specific heat, viscosity,
 isentropic exponent, combustion heating value, Z factor,
 Relative Humidity)
 Units Selections (English/Metric)

RS-232 Communication

Uses: Printing, Setup, Modem, Datalogging
 Baud Rates: 300, 1200, 2400, 9600
 Parity: None, Odd, Even
 Device ID: 0 to 99
 Protocol: Proprietary, Contact factory for more information
 Chassis Connector Style: DB 9 Female connector
 Power Output: 8V (150 mA max.) provided to Modem

RS-485 Communication (optional)

Uses: Network Communications
 Baud Rates: 300, 600, 1200, 2400, 4800, 9600, 19200
 Parity: None, Odd, Even
 Device ID: 1 to 247
 Protocol: ModBus RTU
 Chassis Connector Style: DB 9 Female connector (standard)

Excitation Voltage

24 VDC @ 100 mA overcurrent protected

Relay Outputs

The relay outputs usage is menu assignable to (Individually for each relay) Hi/Lo Flow Rate Alarm, Hi/Lo Temperature Alarm, Hi/Lo Pressure Alarm, Pulse Output (pulse options), Wet Steam or General purpose warning (security).
 (Peak demand and demand last hour optional)

Number of relays: 2 (3 optional)
 Contact Style: Form C contacts (Form A with 3 relay option)
 Contact Ratings: 240 V, 1 amp
 Fast Transient Threshold: 2000 V

Analog Outputs

The analog output usage is menu assignable to correspond to the Heat Rate, Uncompensated Volume Rate, Corrected Volume Rate, Mass Rate, Temperature, Density, or Pressure.

(Peak demand and demand last hour optional)

Number of Outputs: 2

Type: Isolated Current Sourcing (shared common)

Isolated I/P/C: 500 V

Available Ranges: 0-20 mA, 4-20 mA (menu selectable)

Resolution: 16 bit

Accuracy: 0.05% FS at 20 Degrees C

Update Rate: 5 updates/sec

Temperature Drift: Less than 200 ppm/C

Maximum Load: 1000 ohms

Compliance Effect: Less than .05% Span

60 Hz rejection: 40 dB minimum

EMI: No effect at 10 V/M

Calibration: Operator assisted Learn Mode

Averaging: User entry of DSP Averaging constant to cause a smooth control action

Isolated Pulse output

The isolated pulse output is menu assignable to Uncompensated Volume Total, Compensated Volume Total, Heat Total or Mass Total.

Isolation I/O/P: 500 V

Pulse Output Form (menu selectable): Open Collector NPN or 24 VDC voltage pulse

Nominal On Voltage: 24 VDC

Maximum Sink Current: 25 mA

Maximum Source Current: 25 mA

Maximum Off Voltage: 30 VDC

Saturation Voltage: 0.4 VDC

Pulse Duration: User selectable

Pulse output buffer: 8 bit

Real Time Clock

The Flow Computer is equipped with either a super cap or a battery backed real time clock with display of time and date.

Format:

24 hour format for time

Day, Month, Year format for date

Daylight Savings Time (optional)

Measurement

The Flow Computer can be thought of as making a series of measurements of flow, temperature/density and pressure sensors and then performing calculations to arrive at a result(s) which is then updated periodically on the display. The analog outputs, the pulse output, and the alarm relays are also updated. The cycle then repeats itself.

Step 1: Update the measurements of input signals-

Raw Input Measurements are made at each input using equations based on input signal type selected. The system notes the "out of range" input signal as an alarm condition.

Step 2: Compute the Flowing Fluid Parameters-

The temperature, pressure, viscosity and density equations are computed as needed based on the flow equation and input usage selected by the user.

Step 3 : Compute the Volumetric Flow-

Volumetric flow is the term given to the flow in volume units. The value is computed based on the flowmeter input type selected and augmented by any performance enhancing linearization that has been specified by the user.

Step 4: Compute the Corrected Volume Flow at Reference Conditions-

In the case of a corrected liquid or gas volume flow calculation, the corrected volume flow is computed as required by the selected compensation equation.

Step 5 : Compute the Mass Flow-

All required information is now available to compute the mass flow rate as volume flow times density. A heat flow computation is also made if required.

Step 6: Check Flow Alarms-

The flow alarm functions have been assigned to one of the above flow rates during the setup of the instrument. A comparison is now made by comparing the current flow rates against the specified hi and low limits.

Step 7: Compute the Analog Output-

This designated flow rate value is now used to compute the analog output.

Step 8: Compute the Flow Totals by Summation-

A flow total increment is computed for each flow rate. This increment is computed by multiplying the respective flow rate by a time base scaler and then summing. The totalizer format also includes provisions for total rollover.

Step 9: Pulse Output Service-

The pulse output is next updated by scaling the total increment which has just been determined by the pulse output scaler and summing it to any residual pulse output amount.

Step 10: Update Display and Printer Output-

The instrument finally runs a task to update the various table entries associated with the front panel display and serial outputs.

Instrument Setup

The setup is password protected by means of a numeric lock out code established by the user. The help line and units of measure prompts assure easy entry of parameters.

An EZ Setup function is supported to rapidly configure the instrument for first time use. A software program is also available which runs on a PC using a RS-232 Serial for connection to the Flow Computer. Illustrative examples may be down loaded in this manner.

The standard setup menu has numerous subgrouping of parameters needed for flow calculations. There is a well conceived hierarchy to the setup parameter list. Selections made at the beginning of the setup automatically affect offerings further down in the lists, minimizing the number of questions asked of the user.

In the setup menu, the flow computer activates the correct setup variables based on the instrument configuration, the flow equation, and the hardware selections made for the compensation transmitter type, the flow transmitter type, and meter enhancements (linearization) options selected. All required setup parameters are enabled. All setup parameters not required are suppressed.

Also note that in the menu are parameter selections which have preassigned industry standard values. The unit will assume these values unless they are modified by the user.

Most of the process input variables have available a "default" or emergency value which must be entered. These are the values that the unit assumes when a malfunction is determined to have occurred on the corresponding input.

It is possible to enter in a nominal constant value for temperature or density, or pressure inputs by placing the desired nominal value into the default values and selecting "manual". This is also a convenience when performing bench top tests without simulators.

The system also provides a minimum implementation of an "audit trail" which tracks significant setup changes to the unit. This feature is increasingly being found of benefit to users or simply required by Weights and Measurement Officials in systems used in commerce, trade, or "custody transfer" applications.

Simulation and Self Checking:

This mode provides a number of specialized utilities required for factory calibration, instrument checkout on start-up, and periodic calibration documentation.

A service password is required to gain access to this specialized mode of operation. Normally quality, calibration, and maintenance personnel will find this mode of operation very useful.

Many of these tests may be used during start-up of a new system. Output signals may be exercised to verify the electrical interconnects before the entire system is put on line.

The following action items may be performed in the Diagnostic Mode:

- Print Calibration/Maintenance Report
- View Signal Input (Voltage, Current, Resistance, Frequency)
- Examine Audit Trail
- Perform a Self Test
- Perform a Service Test
- View Error History
- Perform Pulse Output Checkout / Simulation
- Perform Relay Output Checkout / Simulation
- Perform Analog Output Checkout / Simulation
- Calibrate Analog Inputs using the Learn Feature
- Calibrate Analog Output using the Learn Feature
- Schedule Next Maintenance Date

Note that a calibration of the analog input/output will advance the audit trail counters since it effects the accuracy of the system.

Operation of Steam Trap Monitor

In applications on Saturated Steam, the otherwise unused Compensation Input may be connected to a steam trap monitor that offers the following compatible output signal levels:

4mA = trap cold

12 mA = trap warm and open (blowing)

20 mA = trap warm and closed

In normal operation a steam trap is warm and periodically opens and closes in response to the accumulation of condensate. A cold trap is indication that it is not purging the condensate, a trap that is constantly blowing is an indication that it is stuck open. To avoid a false alarm, the SUPERtrol II permits the user to program a delay, or time period, which should be considered normal for the trap to be either cold, or open. An alarm will only be activated if the trap is detected as continuously being in the abnormal states for a time period greater than this TRAP ERROR DELAY time.

The user selects to use the Compensation Input for Trap Monitoring by selecting "4-20mA TRAP STATUS as the INPUT SIGNAL for OTHER INPUT1.

The user can program the ERROR DELAY time in HH:MM format into both the TRAP ERROR DELAY (cold trap error) menu and the TRAP BLOWING DELAY (trap stuck open) menu.

The SUPERtrol II will warn the operator of a TRAP ERROR when an abnormal condition is detected. The error can be acknowledged by pressing the ENTER key. However, the problem may reassert itself if there is a continued problem with the steam trap.

In addition, the event is noted in the ERROR LOG.

It is also possible for the user to program a trap malfunction as one of the conditions worthy of a CALL OUT of a problem by selecting this error in the ERROR MASK.

The Data-Logging option of the SUPERtrol II can also be used to log the performance of the trap by storing the % of time the trap has been cold, and/or blowing open during the datalog interval.

Datalogging Option

The Datalogging Option for the SUPERtrol II permits the user to automatically store sets of data items as a record on a periodic basis. A datalog record may be stored as the result of either a PRINT key depression, or an INTERVAL, or a TIME OF DAY request for a datalog.

The user defines the list of items to be included in each datalog by selecting these in the PRINT LIST menu located within the COMMUNICATIONS SUBMENU.

The user selects what will trigger a datalog record being stored in the PRINT INITIATE menu. The choices are PRINT KEY, INTERVAL, and TIME OF DAY.

The user can select the datalog store interval in a HH:MM format in the PRINT INTERVAL menu.

The user can also select the store time of day in a 24 hr HH:MM format in the PRINT TIME menu.

The user can also define whether he just wants the data stored into the datalogger, or if he wants the data both stored in the datalogger and sent out over the RS232 port in the DATALOG ONLY menu.

The user can define the format he wishes the data to be output in using the DATALOG FORMAT menu. Choices are PRINTER and DATABASE. PRINTER format will output the data records in a form suitable to dump to a printer. DATABASE format will output the values in a CSV, or Comma Separated Variable with Carriage return delimiting of each record.

A number of serial commands are also included to access and manipulate information stored within the datalogger. Among these RS232 command capabilities are the following actions:

Clear Data Logger

Send all Data in Datalogger

Send Only New Data since Datalogger was last Read

Send Data for the date included in the request

Send the column heading text for the CSV data fields

Send the column units of measure text for the CSV data fields

Store one new record into datalogger now

Read Number of New Records in the datalogger

Read number of records currently in the datalogger

Read the maximum number of records capacity of the datalogger

Move Pointer Back N records

Dump Record at Pointer

Dump records newer than pointer

Dump data from N records back

The datalogger option is used in conjunction with the RS-232 port in remote metering applications.

The technical details associated with the serial commands are listed in Universal Serial Protocol Manual available upon request.

RS-232 Serial Port

The Flow Computer has a general purpose RS-232 Port which may be used for any one of the following purposes:

Transaction Printing

Data Logging

Remote Metering by Modem

Computer Communication Link

Configuration by Computer

Print System Setup

Print Calibration/Malfunction History

Instrument Setup by PC's over Serial Port

A Diskette program is provided with the Flow Computer that enables the user to rapidly configure the Flow Computer using an Personnel Computer. Included on the diskette are common instrument applications which may be used as a starting point for your application. This permits the user to have an excellent starting point and helps speed the user through the instrument setup.

Operation of Serial Communication Port with Printers

The Flow Computer's RS-232 channel supports a number of operating modes. One of these modes is intended to support operation with a printer in metering applications requiring transaction printing, data logging and/or printing of calibration and maintenance reports.

For transaction printing, the user defines the items to be included in the printed document. The user can also select what initiates the transaction print generated as part of the setup of the instrument. The transaction document may be initiated via a front panel key depression.

In data logging, the user defines the items to be included in each data log as a print list. The user can also select when or how often he wishes a data log to be made. This is done during the setup of the instrument as either a time of day or as a time interval between logging.

The system setup and maintenance report list all the instrument setup parameters and usage for the current instrument configuration. In addition, the Audit trail information is presented as well as a status report listing any observed malfunctions which have not been corrected.

The user initiates the printing of this report at a designated point in the menu by pressing the print key on the front panel.

Operating Serial Communication Port with Modems

The SUPERtrol II offers a number of capabilities that facilitate its use with modems. The SUPERtrol II's RS232 port can be connected to a modem in order to implement a remote metering system that uses either the phone companies standard phone lines or cellular telephone system. In addition to remote meter readings, the serial commands may also be used to examine and/or make setup changes to the unit, and to check for proper operation or investigate problems. Several hundred commands are supported. A compatible industrial modem accessory and interconnecting cabling is offered in the MPP2400N specifically designed for use with the SUPERtrol II.

The SUPERtrol II and Modem can be used together to create systems with one or more of the following capabilities:

1. Poll the SUPERtrol II unit for information from a remote PC.
2. Call Out from the SUPERtrol II unit to a remote PC on a scheduled reading time and/or crisis basis
3. Some combination of the above two descriptions where the unit is polled by one PC and calls into to a different PC if a problem is detected.

In fact, up to five SUPERtrol II units can share the same modem. Each SUPERtrol II must have a unique DEVICE ID. This multidropping of flow computers on a single modem is popular when there are several flow computers mounted near each other.

In most applications using modem communications, the SUPERtrol II's RS232 USAGE is first set equal to MODEM. Each SUPERtrol II on a shared modem cable is given a unique serial device address or DEVICE ID. The BAUD RATE is commonly set to 2400, the PARITY set to NONE, and the HANSHAKING set to NONE to complete the basic setup. The remote PC's communication settings are chosen to match these.

The level of complexity of the SUPERtrol II to Modem connection can range from simple to more complex.

In a simple system a remote PC will call into the telephone number of the modem. The modem will answer the call, and establish a connection between the SUPERtrol II and the remote PC. An exchange of information can now occur. The SUPERtrol II will act as a slave and respond to commands and requests for information from the remote MASTER PC. The MASTER PC will end the exchange by hanging up.

However, it is more common that the SUPERtrol II will be used to control the modem. In these applications the following communication menu settings would be used:

```
RS232 USAGE = MODEM
DEVICE ID, BAUD RATE, PARITY, and HANDSHAKING
are set
MODEM CONTROL = YES
DEVICE MASTER = YES (When multidropping several
SUPERtrol II's, only one unit will be the DEVICE
MASTER)
MODEM AUTO ANSWER = YES (This instructs the unit
to answer incoming calls)
HANG UP IF INACTIVE = YES (This instructs the unit
to hang up the line if no activities occur within several
minutes).
```

A more complex form of a remote metering system can be implemented where the SUPERtrol II will initiate a call to contact the remote PC at a scheduled time and/or in the event of a problem that has been detected. In these applications the SUPERtrol II has additional setup capabilities including:

```
The SUPERtrol II must have a unique identifier
assigned to it (using the TAG NUMBER)
Call Out Telephone number must be entered in the
CALL OUT NUMBER
The scheduled call out time for the daily reading must
be entered in CALL OUT TIME
A decision must be made whether the unit will be used
to call on error(s) in CALL ON ERROR
The particular error conditions to call out on must be
defined in the ERROR MASK
The NUMBER OF REDIALS to be attempted if line is
busy must be entered in that cell
HANG UP IF INACTIVE= YES will disconnect the call
if remote computer does not respond.
```

Consult the Universal Serial Commands User Manual for details on the individual commands supported by the SUPERtrol II. Contact the Flow Applications Group for a discussion on the remote metering system capabilities you are considering.

NOTE: Some modems can be configured in advance to answer incoming calls, terminate phone connections if communications is lost. In such applications there may be no need for the SUPERtrol II to be functioning to "control" the modem. Setting the RS233 USAGE = COMPUTER will likely work.

RS-485 Serial Port (optional)

The RS-485 serial port can be used for accessing flow rate, total, pressure, temperature, density and alarm status information. The port can also be used for changing presets and acknowledging alarms.

2. Installation

General Mounting Hints

2.1 General Mounting Hints:

The SUPERtrol II Flow Computer should be located in an area with a clean, dry atmosphere which is relatively free of shock and vibration. The unit is installed in a 5.43" (138mm) wide by 2.68" (68mm) high panel cutout. (see Mounting Dimensions)
To mount the Flow Computer, proceed as follows:

Mounting Procedure

- a. Prepare the panel opening.
- b. Slide the unit through the panel cutout until it touches the panel.
- c. Install the screws (provided) in the mounting bracket and slip the bracket over the rear of the case until it snaps in place.
- d. Tighten the screws firmly to attach the bezel to the panel. 3 in. lb. of torque must be applied and the bezel must be parallel to the panel.

NEMA4X / IP65 Specifications

NOTE: To seal to NEMA4X / IP65 specifications, supplied bezel kit must be used and panel cannot flex more than .010".
When the optional bezel kit is used, the bezel adaptor must be sealed to the case using an RTV type sealer to maintain NEMA4X / IP65 rating.

2.2 Mounting Diagrams:

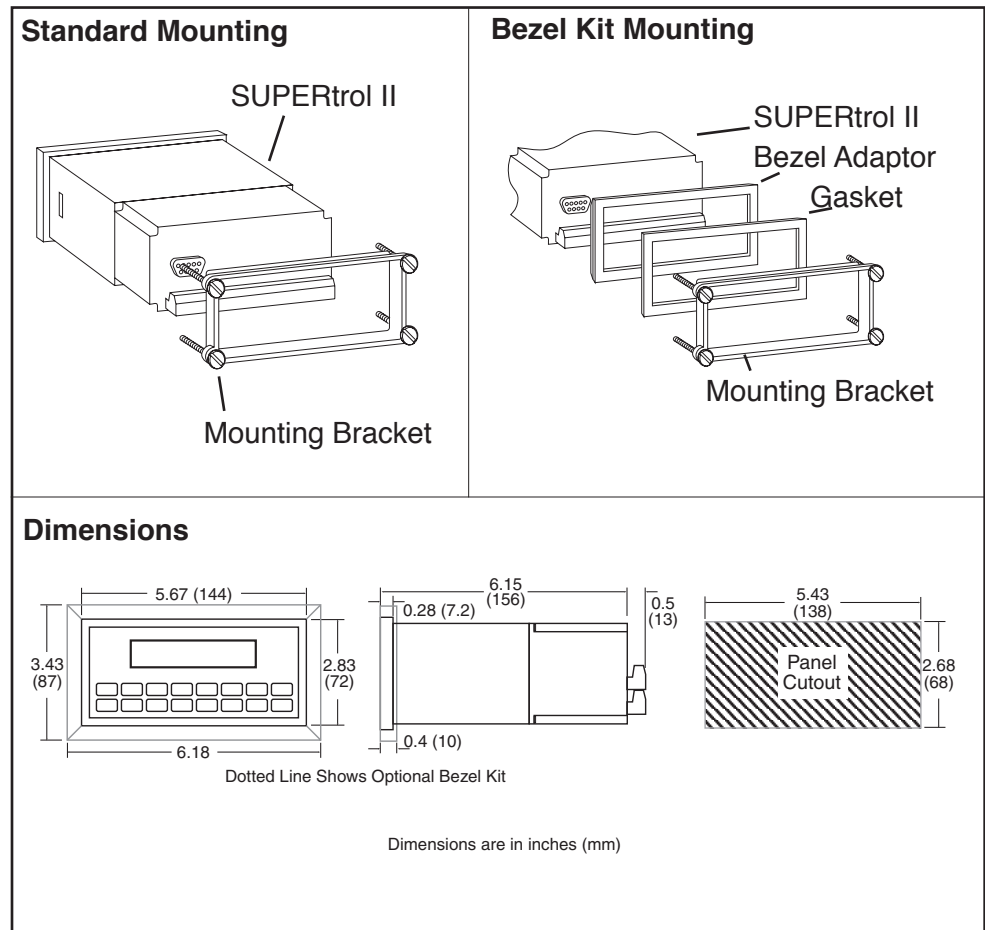

2.2 Mounting Diagrams:
(continued)

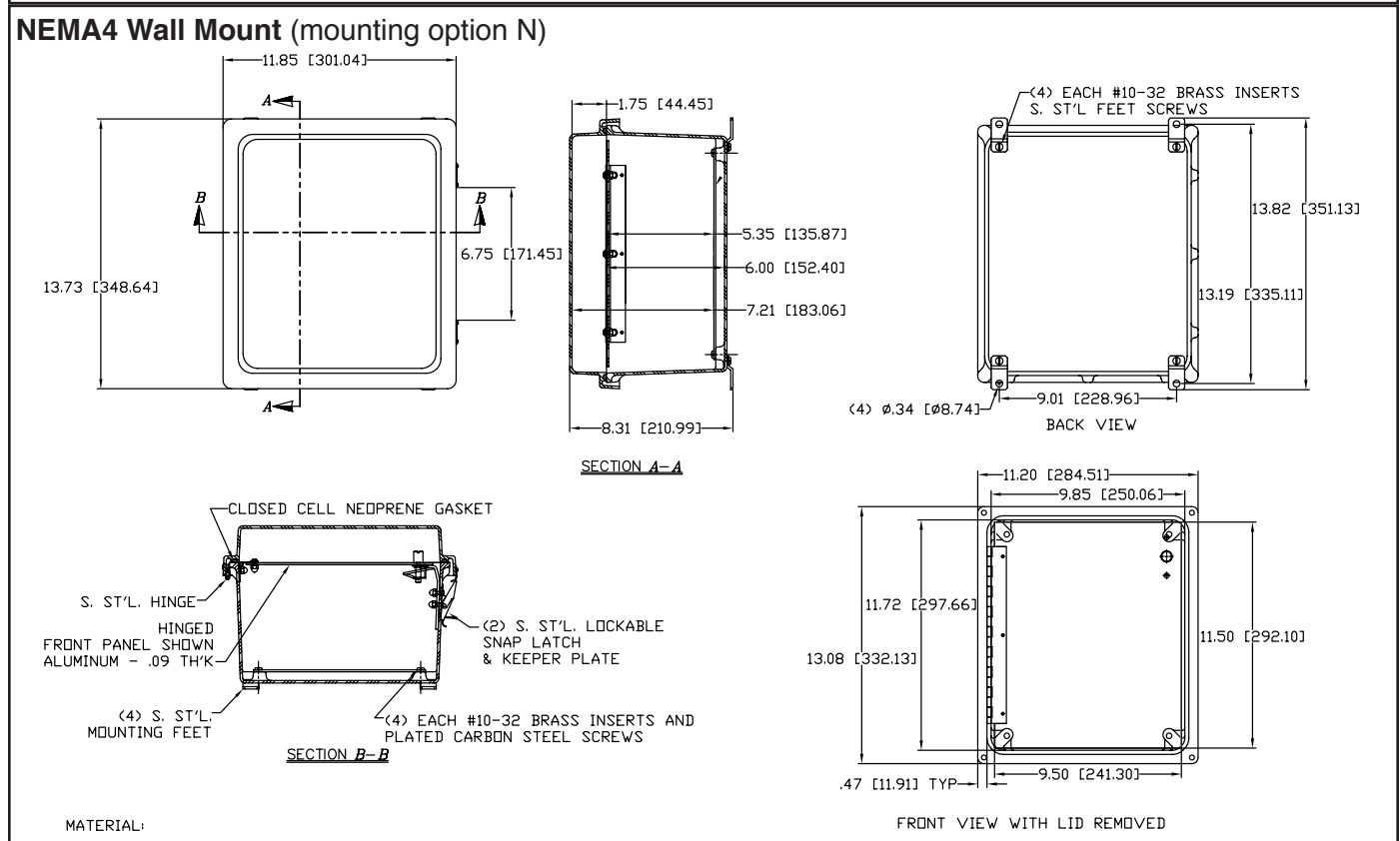
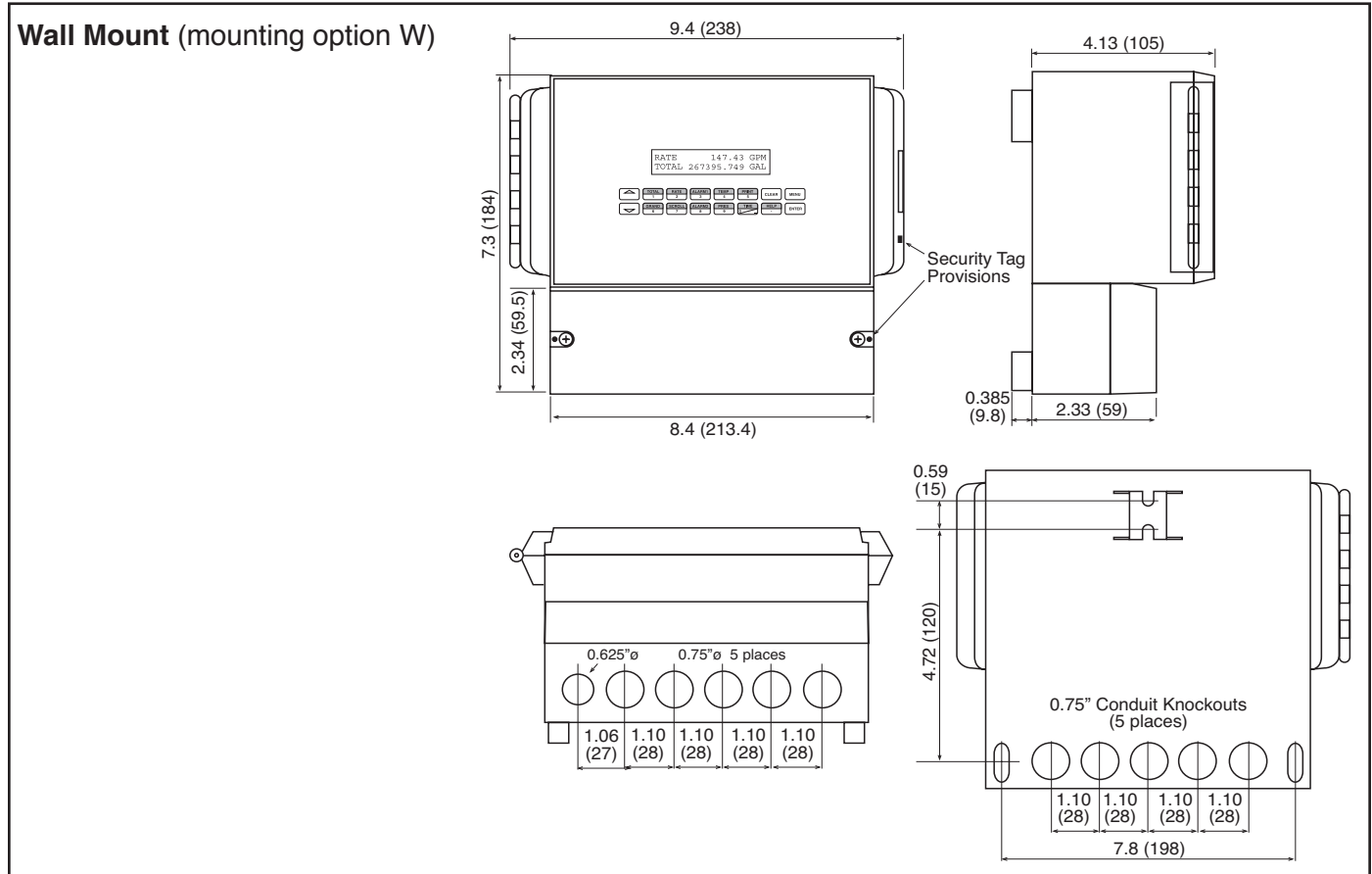

2.2 Mounting Diagrams:
(continued)

Explosion Proof Mount (mounting option E)

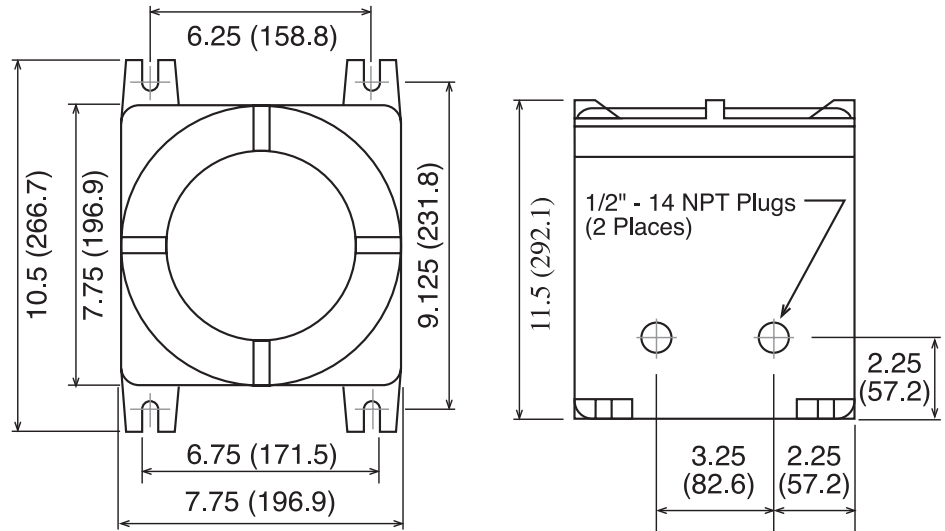

3. Applications

STEAM MASS

3.1 Steam Mass

Measurements:

A flowmeter measures the actual volume flow in a steam line. A temperature and/or pressure sensor is installed to measure temperature and/or pressure.

Calculations:

- Density and mass flow are calculated using the steam tables stored in the flow computer.
- With square law device measurement the actual volume is calculated from the differential pressure, taking into account temperature and pressure compensation.
- Saturated steam requires either a pressure or temperature measurement with the other variable calculated using the saturated steam curve.
- Optional steam trap monitoring using Compensation Input 1.

Input Variables:

Superheated Steam: Flow, temperature and pressure

Saturated Steam: Flow, temperature or pressure

Output Results:

- Display Results
Mass or Volume Flow Rate, Resettable Total, Non-Resettable Total, Temperature, Pressure, Density (optional: peak demand, demand last hour, time/date stamp)
- Analog Output
Mass or Volume Flow Rate, Temperature, Pressure Density, Peak Demand, Demand Last Hour
- Pulse Output
Mass or Volume Total
- Relay Outputs
Mass or Volume Flow Rate , Total, Pressure, Temperature, Alarms, Peak Demand, Demand Last Hour

Applications:

Monitoring mass flow and total of steam. Flow alarms are provided via relays and datalogging is available via analog (4-20mA) and serial outputs.

Steam Mass Illustration

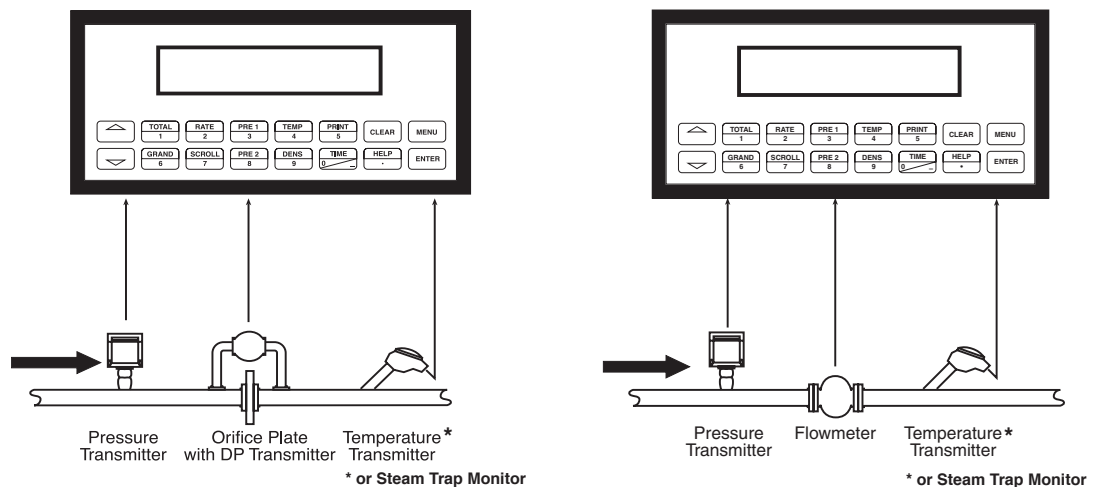

Calculations

Mass Flow

$$\text{Mass Flow} = \text{volume flow} \cdot \text{density (T, p)}$$

STEAM HEAT

3.2 Steam Heat

Measurements:

A flowmeter measures the actual volume flow in a steam line. A temperature and/or pressure sensor is installed to measure temperature and/or pressure.

Calculations:

- Density, mass flow and heat flow are calculated using the steam tables stored in the flow computer. The heat is defined as the enthalpy of steam under actual conditions with reference to the enthalpy of water at T=0°C.
- With square law device measurement the actual volume is calculated from the differential pressure, taking into account temperature and pressure compensation.
- Saturated steam requires either a pressure or temperature measurement with the other variable calculated using the saturated steam curve.
- Optional steam trap monitoring using compensation input.

Input Variables:

Superheated Steam: Flow, temperature and pressure

Saturated Steam: Flow, temperature or pressure

Output Results:

- Display Results
Heat, Mass or Volume Flow Rate, Resettable Total, Non-Resettable Total, Temperature, Pressure, Density (optional: peak demand, demand last hour, time/date stamp)
- Analog Output
Heat, Mass or Volume Flow Rate, Temperature, Pressure, Density, Peak Demand, Demand Last Hour
- Pulse Output
Heat, Mass or Volume Total
- Relay Outputs
Heat, Mass or Volume Flow Rate, Total, Pressure, Temperature Alarms, Peak Demand, Demand Last Hour

Applications:

Monitoring heat flow and total heat of steam. Flow alarms are provided via relays and datalogging is available via analog (4-20mA) and serial outputs.

Steam Heat Illustration

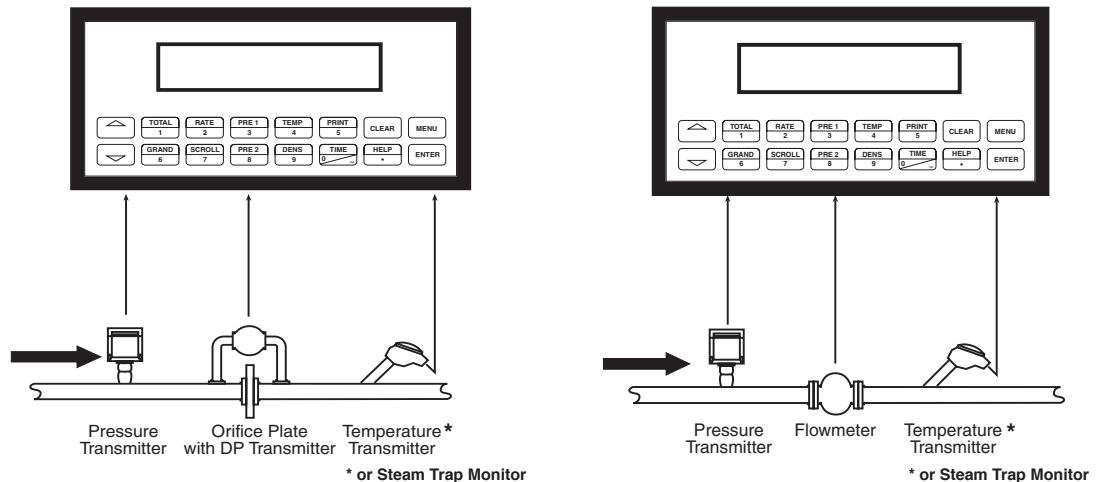

Calculations

Heat Flow

$$\text{Heat Flow} = \text{Volume flow} \cdot \text{density} (T, p) \cdot \text{Sp. Enthalpy of steam} (T, p)$$

STEAM NET HEAT

3.3 Steam Net Heat

Measurements:

A flowmeter measures the actual volume flow in a steam line. A temperature and a pressure sensor are installed to measure temperature and/or pressure. All measurement are made on the steam side of a heat exchanger.

Calculations:

- Density, mass flow and net heat flow are calculated using the steam tables stored in the flow computer. The net heat is defined as the difference between the heat of the steam and the heat of the condensate. For simplification it is assumed that the condensate (water) has a temperature which corresponds to the temperature of saturated steam at the pressure measured upstream of the heat exchanger.
- With square law device measurement the actual volume is calculated from the differential pressure, taking into account temperature and pressure compensation.
- Saturated steam requires either a pressure or temperature measurement with the other variable calculated using the saturated steam curve.
- Optional steam trap monitoring using compensation input.

Input Variables:

Superheated Steam: Flow, temperature and pressure

Saturated Steam: Flow, temperature or pressure

Output Results:

- Display Results
Heat, Mass or Volume Flow Rate, Resettable Total, Non-Resettable Total, Temperature, Pressure, Density, (optional: peak demand, demand last hour, time/date stamp)
- Analog Output
Heat, Mass or Volume Flow Rate, Temperature, Pressure, Density, Peak Demand, Demand Last Hour
- Pulse Output
Heat, Mass or Volume Total
- Relay Outputs
Heat, Mass or Volume Flow Rate , Total, Pressure, Temperature Alarms, Peak Demand, Demand Last Hour

Applications:

Monitoring the thermal energy which can be extracted by a heat exchanger taking into account the thermal energy remaining in the returned condensate. For simplification it is assumed that the condensate (water) has a temperature which corresponds to the temperature of saturated steam at the pressure measured upstream of the heat exchanger.

Steam Net Heat Illustration

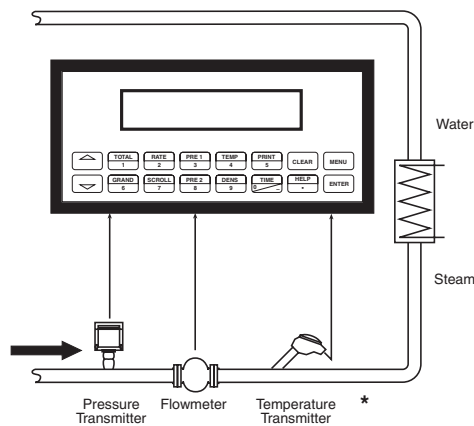

Calculations

Net Heat Flow

$$\text{Net Heat Flow} = \text{Volume flow} \cdot \text{density} (T, p) \cdot [E_D (T, p) - E_W (T_{S(p)})]$$

E_D = Specific enthalpy of steam

E_W = Specific enthalpy of water

$T_{S(p)}^W$ = Calculated condensation temperature
(= saturated steam temperature for supply pressure)

STEAM DELTA HEAT**3.4 Steam Delta Heat****Measurements:**

Measures actual volume flow and pressure of the saturated steam in the supply piping as well as the temperature of the condensate in the downstream piping of a heat exchanger.

Calculations:

- Calculates density, mass flow as well as the delta heat between the saturated steam (supply) and condensation (return) using physical characteristic tables of steam and water stored in the flow computer.
- With square law device measurement the actual volume is calculated from the differential pressure, taking into account temperature and pressure compensation.
- The saturated steam temperature in the supply line is calculated from the pressure measured there.

Input Variables:

Supply: Flow and pressure (saturated steam)

Return: Temperature (condensate)

Output Results:

- Display Results
Heat, Mass or Volume Flow Rate, Resettable Total, Non-Resettable Total, Temperature, Pressure, Density (optional: peak demand, demand last hour, time/date stamp)
- Analog Output
Heat, Mass or Volume Flow Rate, Temperature, Pressure, Density, Peak Demand, Demand Last Hour
- Pulse Output
Heat, Mass or Volume Total
- Relay Outputs
Heat, Mass or Volume Flow Rate, Total, Pressure, Temperature Alarms, Peak Demand, Demand Last Hour

Applications:

Calculate the saturated steam mass flow and the heat extracted by a heat exchanger taking into account the thermal energy remaining in the condensate.

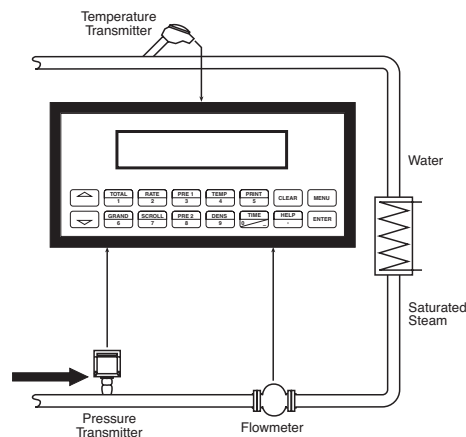
Steam Delta Heat Illustration**Calculations****Delta Heat Flow**

$$\text{Net Heat Flow} = \text{Volume flow} \cdot \text{density } (\rho) \cdot [E_D (\rho) - E_w (T)]$$

E_D = Specific enthalpy of steam

E_w = Specific enthalpy of water

Note: Assumes a closed system.

CORRECTED GAS VOLUME

3.5 Corrected Gas Volume

Measurements:

A flowmeter measures the actual volume flow in a gas line. Temperature and pressure sensors are installed to correct for gas expansion effects.

Calculations:

- Corrected Volume is calculated using the flow, temperature and pressure inputs as well as the gas characteristics stored in the flow computer (see "FLUID DATA" submenu). Use the "OTHER INPUT" submenu to define reference temperature and reference pressure values for standard conditions.

Output Results:

- Display Results
Corrected Volume or Actual Volume Flow Rate, Resettable Total, Non-Resettable Total, Temperature, Pressure, Density (optional: peak demand, demand last hour, time/date stamp)
- Analog Output
Corrected Volume or Actual Volume Flow Rate, Temperature, Pressure, Density, Peak Demand, Demand Last Hour
- Pulse Output
Corrected Volume or Actual Volume Total
- Relay Outputs
Corrected Volume or Actual Volume Flow Rate, Total, pressure, Temperature Alarms, Peak Demand, Demand Last Hour

Applications:

Monitoring corrected volume flow and total of any gas. Flow alarms are provided via relays and datalogging is available via analog (4-20mA) and serial outputs.

Corrected Gas Volume Illustration

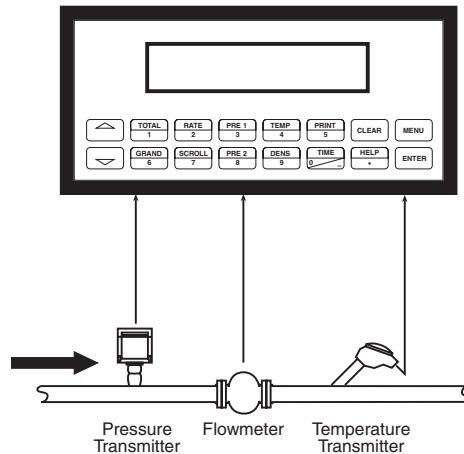

Calculations

Volume Flow

Pulse Input; Average K-Factor

$$\text{Volume Flow} = \frac{\text{input frequency} \cdot \text{time scale factor}}{\text{K-Factor}}$$

Analog Input; Linear

$$\text{Volume Flow} = \% \text{ input} \cdot \text{Full Scale Flow}$$

Corrected Volume Flow

$$\text{Corrected Volume Flow} = \text{Volume Flow} \cdot \frac{P}{P_{ref}} \cdot \frac{T_{ref}}{T} \cdot \frac{Z_{ref}}{Z}$$

GAS MASS

3.6 Gas Mass

Measurements:

A flowmeter measures the actual volume flow in a gas line. Temperature and pressure sensors are installed to measure temperature and pressure.

Calculations:

- Density and mass flow are calculated using gas characteristics stored in the flow computer.
- With square law device measurement the actual volume is calculated from the differential pressure, taking into account temperature and pressure compensation.

Output Results:

- Display Results
Mass or Volume Flow Rate, Resettable Total, Non-Resettable Total, Temperature, Pressure, Density (optional: peak demand, demand last hour, time/date stamp)
- Analog Output
Mass or Volume Flow Rate, Temperature, Pressure, Density, Peak Demand, Demand Last Hour
- Pulse Output
Mass or Volume Total
- Relay Outputs
Mass or Volume Flow Rate, Total, Pressure, Temperature, Density Alarms, Peak Demand, Demand Last Hour

Applications:

Monitoring mass flow and total of gas. Flow alarms are provided via relays and datalogging is available via analog (4-20mA) and serial outputs.

Gas Mass Illustration

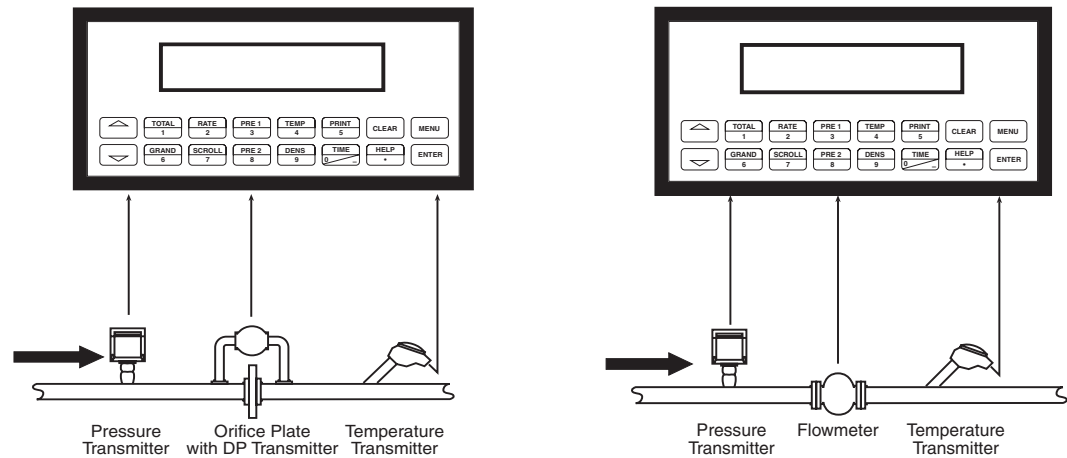

Calculations

Mass Flow

$$\text{Mass Flow} = \text{Actual Volume Flow} \cdot \rho_{\text{ref}} \cdot \frac{P}{P_{\text{ref}}} \cdot \frac{T_{\text{ref}}}{T} \cdot \frac{Z_{\text{ref}}}{Z}$$

- ρ_{ref} = Reference density
- T_{ref} = Reference temperature
- P_{ref} = Reference pressure
- Z_{ref} = Reference Z-factor

GAS COMBUSTION HEAT

3.7 Gas Combustion Heat

Measurements:

A flowmeter measures the actual volume flow in a gas line. Temperature and pressure sensors are installed to measure temperature and pressure.

Calculations:

- Density, mass flow and combustion heat are calculated using gas characteristics stored in the flow computer.
- With square law device measurement the actual volume is calculated from the differential pressure, taking into account temperature and pressure compensation.

Output Results:

- Display Results
Heat, Mass or Volume Flow Rate, Resettable Total, Non-Resettable Total, Temperature, Pressure, Density (optional: peak demand, demand last hour, time/date stamp)
- Analog Output
Heat, Mass or Volume Flow Rate, Temperature, Pressure, Density, Peak Demand, Demand Last Hour
- Pulse Output
Heat, Mass or Volume Total
- Relay Outputs
Heat, Mass or Volume Flow Rate, Total, Pressure, Temperature Alarms, Peak Demand, Demand Last Hour

Applications:

Calculate the energy released by combustion of gaseous fuels.

Gas Combustion Heat

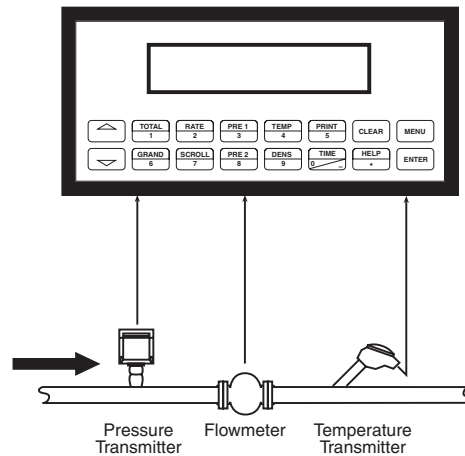

Calculations

Combustion Heat Flow

$$\text{Combustion Energy} = C \cdot \rho_{\text{ref}} \cdot Q \cdot \frac{P}{P_{\text{ref}}} \cdot \frac{T_{\text{ref}}}{T} \cdot \frac{Z_{\text{ref}}}{Z}$$

- C = Specific combustion heat
- ρ_{ref} = Reference density
- Q = Volume flow

Corrected Liquid Volume

3.8 Corrected Liquid Volume

Measurements:

A flowmeter measures the actual volume flow in a liquid line. A temperature sensor is installed to correct for liquid thermal expansion. A pressure sensor can be installed to monitor pressure. Pressure measurement does not affect the calculation.

Calculations:

- Corrected Volume is calculated using the flow and temperature inputs as well as the thermal expansion coefficient stored in the flow computer (see "FLUID DATA" submenu). Use the "OTHER INPUT" submenu to define reference temperature and density values for standard conditions.

Output Results:

- Display Results
Corrected Volume and Actual Volume Flow Rate, Resettable Total, Non-Resettable Total, Temperature, Pressure, Density (optional: peak demand, demand last hour, time/date stamp)
- Analog Output
Corrected Volume and Actual Volume Flow Rate, Temperature, Pressure, Density, Peak Demand, Demand Last Hour
- Pulse Output
Corrected Volume and Actual Volume Total
- Relay Outputs
Corrected Volume and Actual Volume Flow Rate, Total, Pressure, Temperature Alarms, Peak Demand, Demand Last Hour

Applications:

Monitoring corrected volume flow and total of any liquid. Flow alarms are provided via relays and datalogging is available via analog (4-20mA) and serial outputs.

Corrected Liquid Volume Illustration

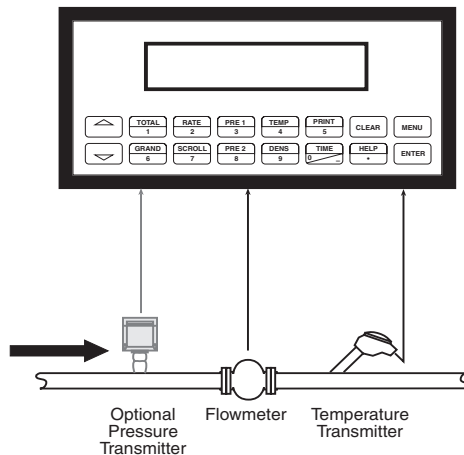

Calculations

Volume Flow

Pulse Input; Average K-Factor

$$\text{Volume Flow} = \frac{\text{input frequency} \cdot \text{time scale factor}}{\text{K-Factor}}$$

Analog Input; Linear

$$\text{Volume Flow} = \% \text{ input} \cdot \text{Full Scale Flow}$$

Corrected Volume Flow

$$\text{Corrected Volume Flow} = \text{vol. flow} \cdot (1 - \alpha \cdot (T_f - T_{ref}))^2$$

$$\alpha = \text{Thermal expansion coefficient} \cdot 10^{-6}$$

Liquid Mass

3.9 Liquid Mass

Measurements:

Actual volume flow is measured by the flow element (DP transmitter, Flowmeter). Temperature is measured by the temperature transmitter. A pressure transmitter can be used to monitor pressure. Pressure measurement does not affect the calculation. A density transmitter may be used in place of a temperature transmitter for direct density measurement.

Calculations:

- The density and mass flow are calculated using the reference density and the thermal expansion coefficient of the liquid (see "FLUID DATA" submenu)

Output Results:

- Display Results
Mass or Volume Flow Rate, Resettable Total, Non-Resettable Total, Temperature, Pressure, Density (optional: peak demand, demand last hour, time/date stamp)
- Analog Output
Mass or Volume Flow Rate, Temperature, Pressure, Density, Peak Demand, Demand Last Hour
- Pulse Output
Mass or Volume Total
- Relay Outputs
Mass or Volume Flow Rate, Total, Temperature, Pressure, Density Alarms, Peak Demand, Demand Last Hour

Applications:

Monitoring mass flow and total of any liquid. Flow alarms are provided via relays and datalogging is available via analog (4-20mA) and serial outputs.

Liquid Mass Illustration

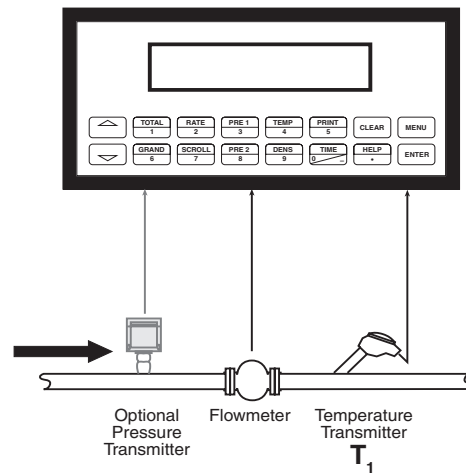

NOTE:
A density transmitter may be used for direct density measurement.

Calculations

Volume Flow

As calculated in section 3.8

Mass Flow

$$\text{Mass Flow} = \text{volume flow} \cdot (1 - \alpha \cdot (T_1 - T_{ref}))^2 \cdot \text{ref. density}$$

$$\alpha = \text{Thermal expansion coefficient} \cdot 10^{-6}$$

LIQUID COMBUSTION HEAT **3.10 Liquid Combustion Heat**

Measurements:

Actual volume flow is measured by the flow element (DP transmitter, Flowmeter). Temperature is measured by the temperature transmitter. A pressure transmitter can be used to monitor pressure. Pressure measurement does not affect the calculation.

Calculations:

- The density, mass flow and combustion heat are calculated using the fluid characteristics stored in the flow computer. (see "FLUID DATA" submenu)

Output Results:

- Display Results
 Combustion Heat, Mass or Volume Flow Rate, Resettable Total, Non-Resettable Total, Temperature, Pressure, Density (optional: peak demand, demand last hour, time/date stamp)
- Analog Output
 Combustion Heat, Mass or Volume Flow Rate, Temperature, Pressure, Density, Peak Demand, Demand Last Hour
- Pulse Output
 Combustion Heat, Mass or Volume Total
- Relay Outputs
 Combustion Heat, Mass or Volume Flow Rate, Total, Temperature, Pressure Alarms, Peak Demand, Demand Last Hour

Applications:

Calculate the energy released by combustion of liquid fuels

Liquid Combustion Heat Illustration

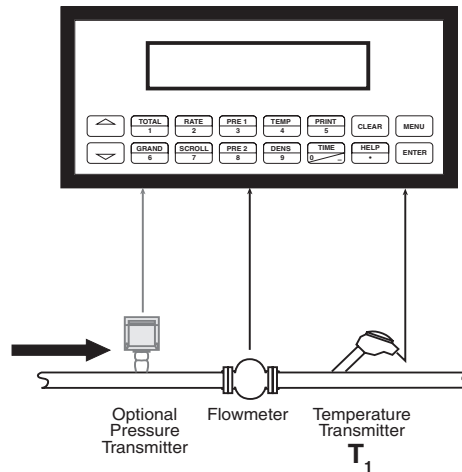

Calculations

Volume Flow

As calculated in section 3.8

Heat Flow

$$\text{Heat Flow} = C \cdot \text{volume flow} \cdot (1 - \alpha \cdot (T_1 - T_{ref}))^2 \cdot \text{ref. density}$$

- α = Thermal expansion coefficient $\cdot 10^{-6}$
- C = Specific combustion heat

LIQUID SENSIBLE HEAT

3.11 Liquid Sensible Heat

Measurements:

Actual volume flow is measured by the flow element (DP transmitter, Flowmeter). Temperature is measured by the temperature transmitter. A pressure transmitter can be used to monitor pressure. Pressure measurement does not affect the calculation.

Calculations:

- The density, mass flow and sensible heat are calculated using the fluid characteristics stored in the flow computer. (see "FLUID DATA" submenu)

Output Results:

- Display Results
Sensible Heat, Mass or Volume Flow Rate, Resettable Total, Non-Resettable Total, Temperature, Pressure, Density (optional: peak demand, demand last hour, time/date stamp)
- Analog Output
Sensible Heat, Mass or Volume Flow Rate, Temperature, Pressure, Density, Peak Demand, Demand Last Hour
- Pulse Output
Sensible Heat, Mass or Volume Total
- Relay Outputs
Sensible Heat, Mass or Volume Flow Rate, Total, Temperature, Pressure Alarms, Peak Demand, Demand Last Hour

Applications:

Calculate the energy stored in a condensate with respect to water at 32°F (0°C).

Liquid Sensible Heat Illustration

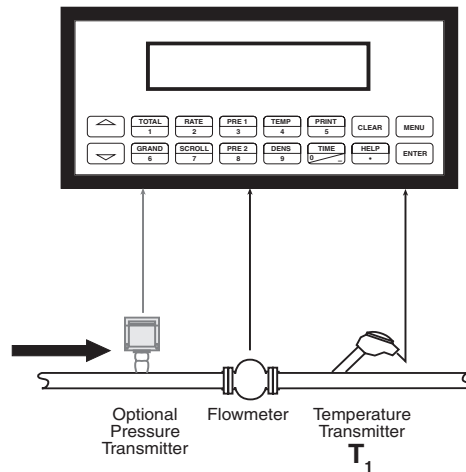

Calculations

Volume Flow

As calculated in section 3.8

Heat Flow

$$\text{Heat Flow} = C \cdot \text{volume flow} \cdot (1 - \alpha \cdot (T_1 - T_{ref}))^2 \cdot \text{ref. density} \cdot (T_1 - 32)$$

- α = Thermal expansion coefficient $\cdot 10^{-6}$
- C = Specific heat

LIQUID DELTA HEAT 3.12 Liquid Delta Heat

Measurements:

Actual volume flow is measured by the flow element (DP transmitter, Flowmeter). Temperature of the supply and return lines are measured by the temperature transmitters.

Calculations:

- The density, mass flow and delta heat are calculated using values of the heat carrying liquid stored in the flow computer. (see "FLUID DATA" submenu)

Output Results:

- Display Results
Heat, Mass or Volume Flow Rate, Resettable Total, Non-Resettable Total, Temperature1, Temperature2, Delta Temperature, Density, (optional: peak demand, demand last hour, time/date stamp)
- Analog Output
Heat, Mass or Volume Flow Rate, Temperature1, Temperature2, Delta Temperature, Density, Peak Demand, Demand Last Hour
- Pulse Output
Heat, Mass or Volume Total
- Relay Outputs
Heat, Mass or Volume Flow Rate, Total, Temperature Alarms, Peak Demand, Demand Last Hour

Applications:

Calculate the energy which is extracted by a heat exchanger from heat carrying liquids.

Liquid Delta Heat Illustration

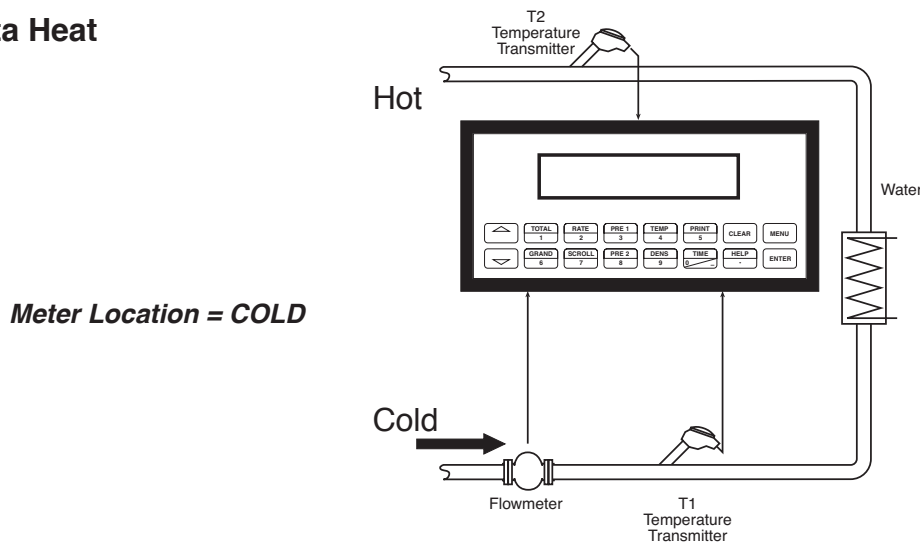

Meter Location = COLD

Calculations

Water

$$\text{Heat} = \text{Volume Flow} \cdot \rho(T1) \cdot [h(T_2) - h(T_1)]$$

Other heat carrying liquids

$$\text{Heat} = C \cdot \text{volume flow} \cdot (1 - \alpha \cdot (T_1 - T_{ref}))^2 \cdot \rho_{ref} \cdot (T_2 - T_1)$$

WHERE: Delta T > Low Delta T Cutoff

- α = Thermal expansion coefficient $\cdot 10^{-6}$
- C = Mean specific heat
- $\rho(T1)$ = Density of water at temperature T_1
- $h(T1)$ = Specific enthalpy of water at temperature T_1
- $h(T2)$ = Specific enthalpy of water at temperature T_2
- ρ_{ref} = Reference density
- T_{ref} = Reference temperature

STEAM – CONDENSATE ENERGY METER

3.13 Steam – Condensate Heat

Measurements:

Actual condensate volume flow is measured by the flow element (DP transmitter, Flowmeter). Condensate temperature is measured by the temperature transmitter. A pressure transmitter is used to monitor steam pressure.

Calculations:

- The condensate density, volume flow, mass flow and saturated steam energy - condensate energy are calculated using the fluid characteristics stored in the flow computer. (see "FLUID DATA" submenu)

Output Results:

- Display Results
Steam – Condensate Heat, Condensate Mass and Volume Flow Rate, Resettable Total, Non-Resettable Total, Temperature, Pressure, Condensate Density (optional: peak demand, demand last hour, time/date stamp)
- Analog Output
Net Heat Flow, Mass and Volume Flow Rate, Condensate Temperature, Steam Pressure, Condensate Density, Peak Demand, Demand Last Hour
- Pulse Output
Net Heat, Mass or Volume Total
- Relay Outputs
Net Heat, Mass or Volume Flow Rate, Total, Condensate Temperature, Steam Pressure Alarms, Peak Demand, Demand Last Hour

Applications:

Calculate the energy stored in steam – the energy in returned condensate water.

Steam – Condensate Heat Illustration

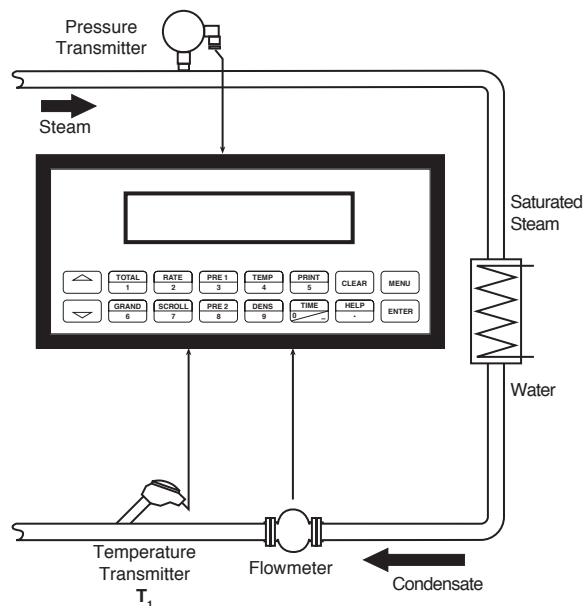

Calculations

Volume Flow

As calculated in section 3.8

Net Heat Flow

$$\text{Net Heat Flow} = \text{condensate volume flow} \cdot \text{condensate density} \cdot [\text{enthalpy steam } (P_t) - \text{enthalpy water } (T_t)]$$

4. WIRING

4.1 Terminal Designations

Two Relay Terminations

1	DC OUTPUT			
2	PULSE IN	Vin (+)*	FLOW	IN
3	-----	Iin (+)		
4	COMMON			
5	RTD EXCIT (+)		TEMPERATURE	
6	RTD SENS (+)			IN
7	RTD SENS (-)	Iin (+)**		
8	DC OUTPUT			
9	RTD EXCIT (+)		PRESSURE	
10	RTD SENS (+)		(TEMP 2)	
11	RTD SENS (-)	Iin (+)		IN
12	PULSE OUTPUT (+)			
13	PULSE OUTPUT (-)			
14	ANALOG OUTPUT 1 (+)			
15	ANALOG OUTPUT 2 (+)			
16	ANALOG OUTPUT COMMON (-)			
17	NO			
18	COM RLY1			
19	NC			
20	NC			
21	COM RLY2			
22	NO			
23	AC LINE	DC (+)	POWER IN	
24	AC LINE	DC (-)		

Three Relay Option Terminations

1	DC OUTPUT			
2	PULSE IN	Vin (+)*	FLOW	IN
3	-----	Iin (+)		
4	COMMON			
5	RTD EXCIT (+)		TEMPERATURE	
6	RTD SENS (+)			IN
7	RTD SENS (-)	Iin (+)**		
8	DC OUTPUT			
9	RTD EXCIT (+)		PRESSURE	
10	RTD SENS (+)		(TEMP 2)	
11	RTD SENS (-)	Iin (+)		IN
12	PULSE OUTPUT (+)			
13	PULSE OUTPUT (-)			
14	ANALOG OUTPUT 1 (+)			
15	ANALOG OUTPUT 2 (+)			
16	ANALOG OUTPUT COMMON (-)			
17	N.O. RLY1			
18	COM.RLY1			
19	N.O. RLY3			
20	COM.RLY3			
21	N.O. RLY2			
22	COM.RLY2			
23	AC LINE	DC (+)	POWER IN	
24	AC LINE	DC (-)		

* In stacked DP mode, terminal 2 is used for Iin (+) DP Hi Range.
Terminal 3 is used for Iin (+) DP Lo Range.

** In trap monitor mode, terminal 7 is used for Iin (+) from trap monitor.

4.2 Typical Wiring Connections:

4.2.1 Flow Input

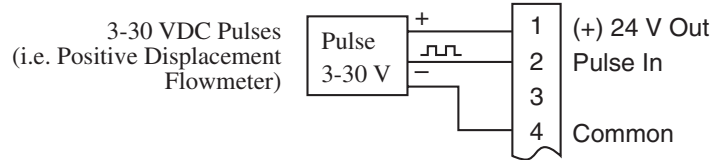
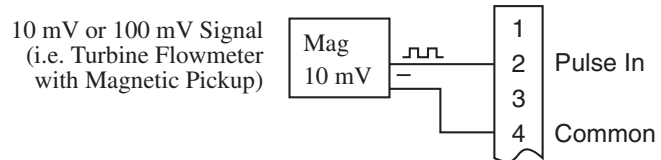
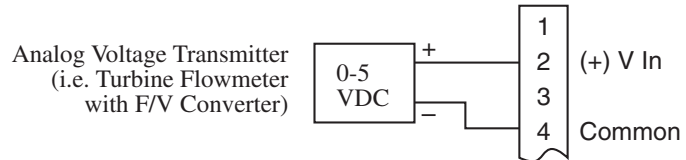
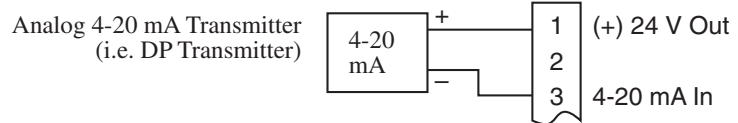

4.2.2 Stacked DP Input

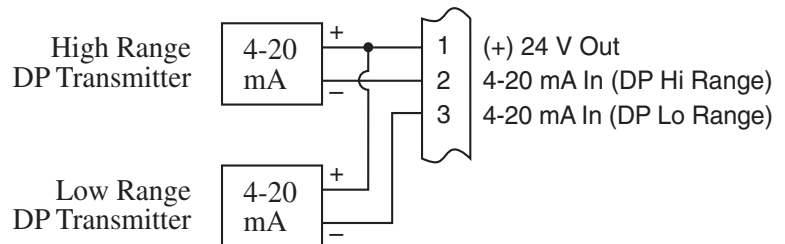

4.2.3 Pressure Input

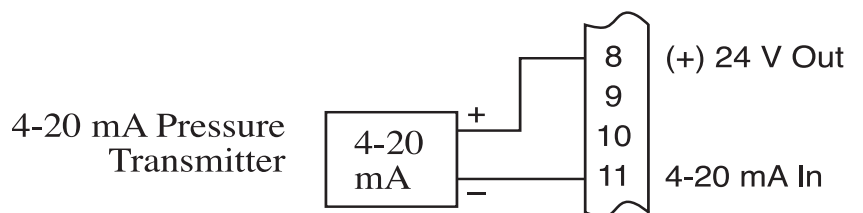

4.2.4 Temperature Input

RTD Connections
2, 3 & 4 wire RTD's

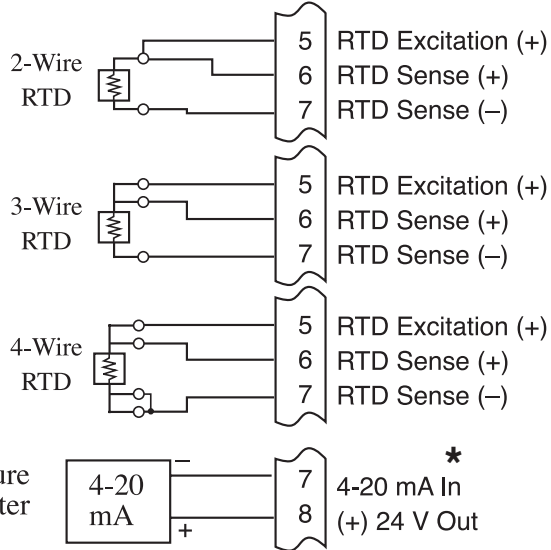

* Or optional steam trap monitoring input in some saturated steam applications.

4.2.5 Temperature 2 Input

RTD Connections
2, 3 & 4 wire RTD's

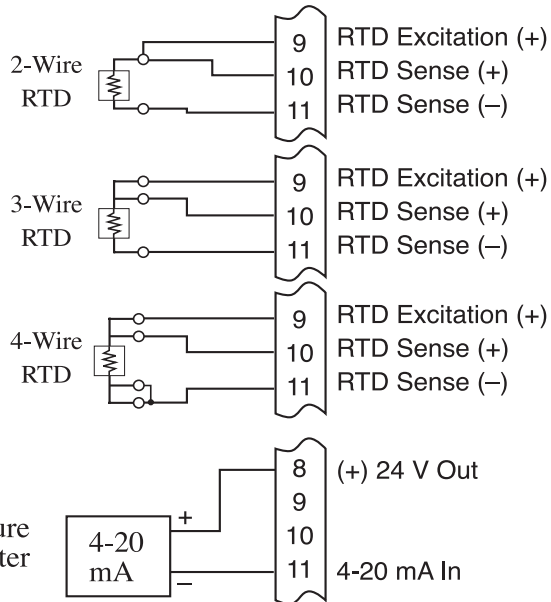

4.3 Wiring In Hazardous Areas

Examples using MTL787S+ Barrier (MTL4755ac for RTD)

4.3.1 Flow Input

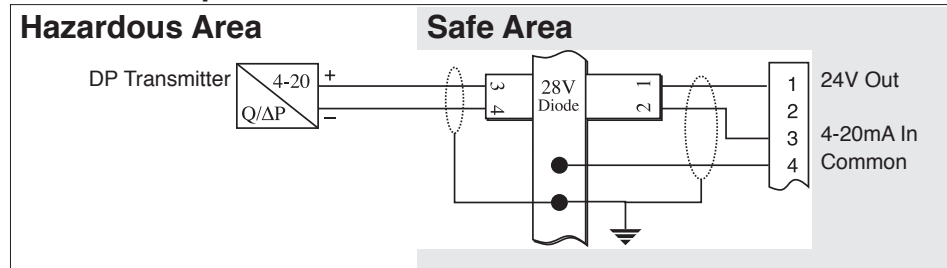

4.3.2 Pressure Input

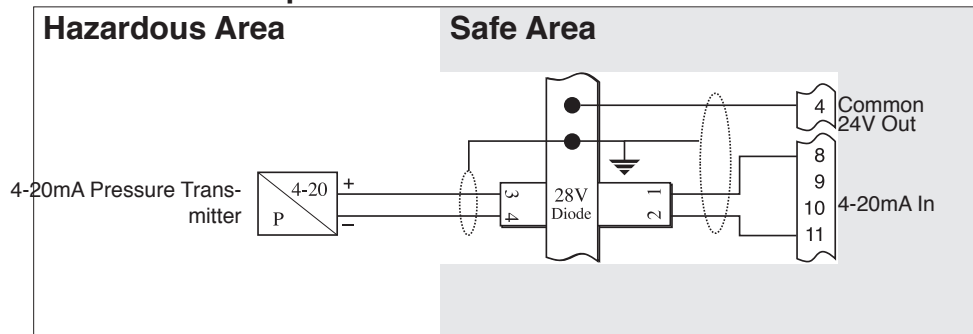

4.3.3 Temperature Input

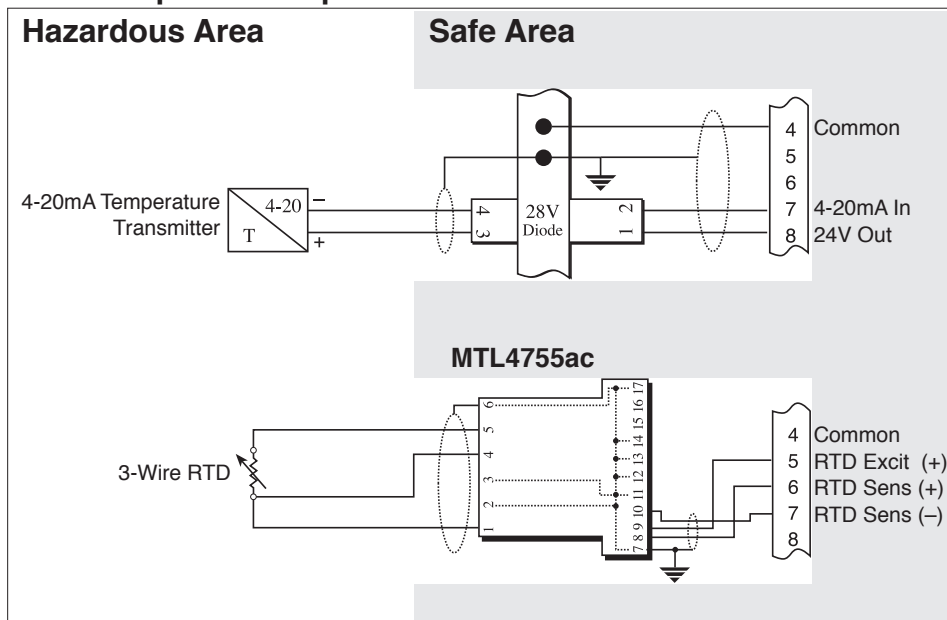

5. UNIT OPERATION

5.1 Front Panel Operation Concept for Operate Mode

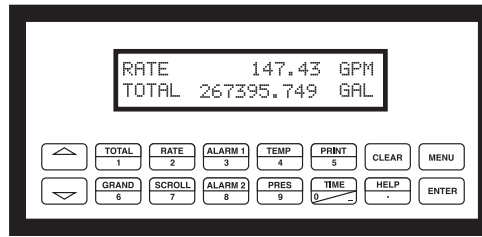

How To Use On-Line Help

HELP

On-line help is provided to assist the operator in using this product. The help is available during OPERATE and SETUP modes simply by pressing the HELP key. The HELP key is used to enter decimals when entering numeric values.

How To View Process Values

VIEWING PROCESS VALUES

In the OPERATE mode, several keys have a special, direct access feature, to display an item of interest (i.e. RATE, TOTAL, ALARM SETPOINT, etc.). Press the key to view your choice. Press the Δ ∇ keys to view other items in that group.

How To Clear The Totalizer

CLEARING TOTALIZER

To clear the totalizers, you must press the TOTAL Function Key to select the totalizer group. Press the Δ ∇ keys to select the desired totalizer. Once the desired totalizer is displayed, press the CLEAR key to reset the total. The operator will be prompted to verify this action and to enter a password if the unit is locked.

How To Clear The Grand Total

CLEARING GRAND TOTAL

To clear the grand totalizers, you must press the GRAND Function Key and use the Δ ∇ keys to select the desired grand total. Once the grand total is selected, press the CLEAR key to reset the grand total. The operator will be prompted to verify this action and to enter service password if the unit is locked.

How To Enter Alarm Setpoints

ALARM SETPOINT KEYS

ALARM 1 & ALARM 2 keys are used to view and/or change the alarm setpoints. To view the setpoints, simply press the desired Alarm setpoint key once. Rapidly press the alarm setpoint keys several times for direct editing of the alarm setpoints. The operator will be prompted to enter password if the unit is locked. Press CLEAR, "###", ENTER to enter value.

How To Activate The Scrolling Display List

SCROLL

Press the Scroll key to activate the scrolling display list. See section 6 to setup the display list.

How To Use The Print Key

PRINT

The PRINT key is used to print on demand when the communication port is set for printer. When the PRINT key is pressed, a user defined list of data (TOTAL, RATE, ALARM SETPOINT, etc.) is sent to the RS-232 port. A timed message of "PRINTING" will be displayed to acknowledge the print request.

How To Use The Menu Key

MENU KEY

The MENU key is used to view/enter the Instrument Setup and Service Mode. Press the MENU key to access the Setup and Service modes. (See section 6 for Setup mode). The MENU key is also used for a "Pop-Back" function. When the MENU key is pressed, the display will "Pop-Back" to the current submenu heading. Multiple MENU key depressions will return the unit to the Operate Mode.

How To Acknowledge Alarms

ACKNOWLEDGING ALARMS

Most alarm messages are self-clearing. Press the ENTER key to acknowledge and clear latching alarms.

NOTE: Some keys and functions are password protected. Enter the password to gain access. The passwords are factory set as follows:

Private = 1000, Service = 2000

General Operation**5.2 General Operation**

This instrument is used primarily to monitor flowrate and accumulated total. The inputs can be software configured for a variety of flowmeter, temperature and pressure sensors. The standard output types include: Pulse, Relay, Analog and RS-232. The unit can display the flowrate, total and process variables. RS-485 is an available option for a second communication channel.

Password Protection**5.3 Password Protection**

After an Private and/or Service Code is entered in the "System Parameters" Submenu Group. (see section 6.3, Private Code and Service Code sub-menus), the unit will be locked. The unit will prompt the user for the password when trying to perform the following functions:

- Clear Totals
- Clear Grand Totals (service code required)
- Edit a Setup Menu Item
- Edit Alarm Setpoints (ALARM 1 & ALARM 2 Keys)

The Service Code should be reserved for service technicians. The Service Code will allow access to restricted areas of the Service and Test menus. Changes in these areas may result in lost calibration information.

Relay Operation**5.4 Relay Operation**

Two relay alarm outputs are standard. The relays may also be used for pulse outputs. The relays can be assigned to trip according to various rate, total, temperature or pressure readings. The relays can be programmed for low/high alarms, latch or unlatch, or as relay pulse outputs.

ALARM SETPOINT 1 (RLY1) and ALARM SETPOINT 2 (RLY2) are easily accessible by pressing the ALARM 1 or ALARM 2 key on the front panel.







Pulse Output**5.5 Pulse Output**

The isolated pulse output is menu assignable to any of the available totals. The pulse output duration and scaling can be set by the user. The pulse output is ideal for connecting to remote totalizers or other devices such as a PLC. See section 1.2 for electrical specifications.

Analog Outputs**5.6 Analog Outputs**

The analog outputs are menu assignable to correspond to any of the process parameters. The outputs are menu selectable for 0-20 mA or 4-20 mA. The analog outputs are ideal for "trend" tracking using strip chart recorders or other devices.

Function Keys Display Grouping**5.7 Function Keys; Display Grouping**

TOTAL	Press the  keys to view HEAT TOTAL, MASS TOTAL, CORRECTED VOLUME TOTAL, VOLUME TOTAL
GRAND TOTAL	Press the  keys to view GRAND HEAT, GRAND MASS, GRAND CORRECTED VOLUME, GRAND VOLUME
RATE	Press the  keys to view HEAT, MASS, CORRECTED VOLUME, VOLUME, PEAK DEMAND, DEMAND LAST HOUR
TEMPERATURE	Press the  keys to view TEMPERATURE 1, TEMPERATURE 2, DELTA TEMPERATURE, DENSITY
PRESSURE	Press the  keys to view PRESSURE, DIFFERENTIAL PRESSURE, Y ₁ , SPECIFIC ENTHALPY
TIME	Press the  keys to view TIME/DATE, PEAK TIME/DATE, ACCUMULATIVE POWER LOSS TIME, TIME OF LAST POWER OUTAGE, TIME POWER WAS LAST RESTORED

RS-232 Serial Port Operation**5.8 RS-232 Serial Port Operation**

The RS-232 serial port can be used for programming (using the Setup Disk) or for communicating to printers and computers in the Operating Mode (Run Mode). Enhanced uses include remote metering by modem.

PC Communications**5.8.1 PC Communications:**

The Setup Disk also allows the user to query the unit for operating status such as Flow Rate, Flow Total, Temperature, Pressure, Alarm Setpoints, etc.

In this mode of operation the RS232 port is assumed connected to a computer. The SUPERtrol II will act as a slave and answer requests from the PC. See the Universal Protocol Users Manual for a complete listing of the commands set supported. A DDE/OPC Server is also available for use in exchanging information with DDE Clients such as Spread Sheets, Database Programs, and HMI software.

RS-232 Serial Port Operation of RS-232 Serial Port with Printers**5.8.2 Operation of RS-232 Serial Port with Printers:**Transaction Printing

For transaction printing, the user defines the items to be included in the printed document (see section 6.13 COMMUNICATION, Print List). The transaction document can be initiated by pressing the PRINT key.

Data Logging

The user can select when (time of day) or how often (print interval) the data log is to be made (see section 6.13 COMMUNICATION, Print Initiate). Information will be stored to the datalogger and optionally output to the RS-232 port.

System Setup and Maintenance Report

The system setup and maintenance report lists all of the instrument setup parameters and usage for the current instrument configuration. The audit trail information and a status report is also printed. This report is initiated in the Service and Analysis Group (see section 6.15 SERVICE & ANALYSIS, Print System Setup).

Operation of RS-232 Serial Port with Modems**5.8.3 Operation of RS-232 Serial Port with Modems**

In this mode of operation the RS232 port is assumed to be connected to a MPP2400N or similar telephone modem. The SUPERtrol II is responsible for communicating to a remote computer through the modem to perform such actions as:

Answer incoming calls, process requests for information or action items or data log contents or change setup parameters, call out daily readings to designed phone number, call out to designated phone number in the case of a designated exception or malfunction in the unit, terminating telephone calls if a connection is lost.

RS-485 Serial Port Operation**5.9 RS-485 Serial Port Operation**

The RS-485 serial port is intended to permit operation of the flow computer in a RS-485 network. Access is limited to reading process variables, totalizers, error logs and to executing action routines such as clearing totalizers, alarms, and changing setpoints.

Pause Computations Prompt**5.10 Pause Computations Prompt**

The user will be prompted with a "Pause Computations" message when making significant setup changes to the instrument. Pausing computations is necessary to make any significant changes. With computations paused, all outputs assume a safe state equal to that of an unpowered unit. Computations resume when exiting the setup menu.

6. PROGRAMMING

6.1 Front Panel Operation Concept for Program Mode

The SUPERtrol II is fully programmable through the front panel. The instrument setup menu structure is based on a number of topical submenu groups with one submenu group for each instrument function. Each submenu contains all of the individual settings associated with that function. During the instrument setup, setup topics are shown on the bottom line of the display while the detailed selection options are shown on the top line. A help menu is available for each menu item.

Please review the following key usage summary before attempting to setup the instrument.

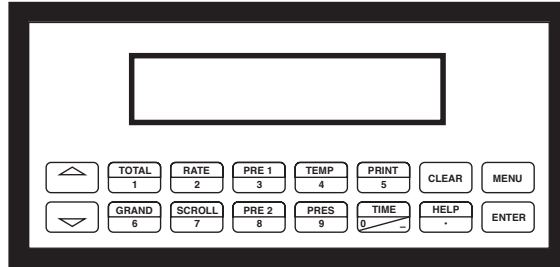

CAUTION: When the computations are paused the instrument outputs will go to a safe state which is the same as if the unit lost power. All calculations stop.

Key Usage Summary:

 **Menu Key**

MENU KEY

Pressing the MENU key while in the "HOME" position will select the view setup parameters mode. Thereafter, the MENU key is used to "pop up" one menu level (i.e. return to the start of the submenu group). The unit will "pop up" one level for each time the **MENU key is pressed until finally returning to the "HOME" position of showing the "scroll" display list.**

 **Up & Down Arrow Keys**

UP & DOWN ARROW KEYS

Use the UP and DOWN arrow keys to navigate through the submenu groups. The up and down arrow keys are also used to view the next/previous selection in a selection list within a submenu cell. When entering text characters, the UP and DOWN arrow keys are used to scroll through the available character sets for each individual character location. Press the ENTER key to accept the character and advance to the next character.

 **Help Key**

HELP KEY

On-line help is available to assist the user during instrument setup. A quick help is provided at each setup step. Press the HELP key to display a help message for the current setup selection. This key is also used to enter decimals during numeric entry sequences.

 **Numeric Entry Keys**

NUMERIC ENTRY KEYS

The keys labeled "0 - 9", "-", ".", CLEAR and ENTER are used to enter numerical values. A leading 0 will assume that you intend to enter a minus "-" sign. The standard numeric entry sequence is: CLEAR, "###", ENTER. Numeric entry values are bounded or clamped by minimum and maximum permitted values.

 **Clear Key**

CLEAR KEY





The CLEAR key is used to clear numeric values to "0".

 **Enter Key**

ENTER KEY

The ENTER key is used to accept the current value and advance to the next selection (Successfully terminate the current numeric entry sequence).

6.2
EZ
SETUP
(Continued)

EZ SETUP	
Fluid Type	<p>Select the type of fluid appropriate for your application.</p> <p>Selection:</p> <p> SATURATED STEAM, SUPERHEATED STEAM</p> <p>Display: SATURATED STEAM FLUID TYPE</p>
FLOWMETER TYPE	<p>Select the flowmeter type used in your application.</p> <p>Selection:</p> <p> LINEAR, SQR LAW, SQR LAW-LIN., LINEAR 16 PT, SQR LAW 16 PT, SQR LAW-LIN. 16 PT, LINEAR UVC, GILFLO, GILFLO 16 PT, BYPASS, ILVA16PT, MASS FLOW</p> <p>Display: LINEAR FLOWMETER TYPE</p>
INPUT SIGNAL	<p>Select the appropriate input signal.</p> <p>Selection:</p> <p> 4-20 mA, 0-20 mA, 0-5 Vdc, 1-5 Vdc, 0-10 Vdc, DIGITAL: 10 mV LEVEL, DIGITAL: 100 mV LEVEL, DIGITAL: 2.5 V LEVEL, 4-20mA STACKED, 0-20mA STACKED, 4-20mA LINEAR MANIFOLD, 0-20mA LINEAR MANIFOLD</p> <p>Display: DIGITAL 2.5 V LEVEL INPUT SIGNAL</p>
K-FACTOR	<p>Enter the K-Factor for the flowmeter.</p> <p>Input:</p> <p> Number with floating decimal point: 0.0001...999999</p> <p>Display: 123.67 P/ft³ K-FACTOR</p>
INPUT SIGNAL (PRESSURE)	<p>Select the appropriate pressure input signal.</p> <p>Selection:</p> <p> MANUAL PRESSURE, 4-20 PRESSURE (ABS.), 0-20 PRESSURE (ABS.), 4-20 PRESSURE (G), 0-20 PRESSURE (G)</p> <p>Display: 4-20 PRESSURE (ABS.) INPUT SIGNAL</p>

6.2
EZ
SETUP
(Continued)

EZ SETUP

FULL SCALE VALUE (PRESSURE)

Enter the full scale value for the pressure input signal.

Input:



Number with fixed decimal point:
000.000 ... 999.999

Display:

580.000 psia
FULL SCALE VALUE

DEFAULT VALUE (PRESSURE)

Enter the default value for the pressure input signal.

Input:



Number with fixed decimal point:
000.000 ... 999.999

Display:

14.696 psia
DEFAULT VALUE

NOTE: After the last entry has been saved, the display automatically returns to the HOME position. The “EZ Setup” routine is completed and the flow computations are resumed.



6.3
DETAILED
MENU
DESCRIPTION

DETAILED MENU DESCRIPTION

The menu organization for the unit is depicted in Appendix B. The first depiction is that available with the operator password. The second is that available with supervisor password.

Please reference Appendix B while reviewing the detailed descriptions for each menu location in the following sections.

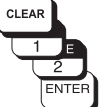

6.4
SYSTEM
PARAMETERS
(Continued)

SYSTEM PARAMETERS	
FLOW EQUATION	<p>The Flow Equation sets the basic functionality of the unit. Choose the Flow Equation for your particular application.</p> <p>Note: Various setup data is only available depending on the flow equation selected. The flow equation also determines the assignment of the inputs.</p> <p>Caution: Select the flow equation as the first step. We recommend using the EZ Setup to select the proper flow equation. The user can then enter the submenu groups and make additional changes as desired.</p> <p>Selection:</p> <p> GAS COMBUSTION HEAT, GAS MASS, GAS CORRECTED VOLUME, STEAM DELTA HEAT, STEAM NET HEAT, STEAM HEAT, STEAM MASS, LIQUID DELTA HEAT, LIQUID SENSIBLE HEAT, LIQ. COMBUSTION HEAT, LIQUID MASS, LIQ. CORRECTED VOLUME, STM – CONDENSATE HEAT</p> <p>Display: STEAM MASS FLOW EQUATIONS</p>
ENTER DATE	<p>Enter the date in this format: Day - Month - Year.</p> <p>Note: After prolonged breaks in the power supply (several days) or upon initial start-up of the unit, the date and time must be reset. This does not apply to units with the datalogger or language option.</p> <p>Input:</p> <p> Flashing selections can be changed. Store and Confirm entries with the ENTER key</p> <p>Display: 08 FEB 1996 ENTER DATE</p>
DAYLIGHT SAVINGS TIME	<p>The "Daylight Savings" mode allows the unit to automatically adjust the time according to daylight savings time change</p> <p>Note: Select "Yes" to enable the Daylight Savings Mode</p> <p>Selection:</p> <p> Yes, No</p> <p>Display: Yes DAYLIGHT SAVINGS</p>

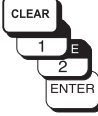
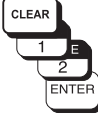
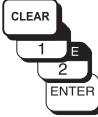
6.4
SYSTEM
PARAMETERS
(Continued)

SYSTEM PARAMETERS	
<p>ENTER TIME</p>	<p>Enter the actual time in this format: Hours - Minutes</p> <p>Note: After prolonged breaks in the power supply (several days) or upon initial start-up of the unit, the date and time must be reset.</p> <p>Input:</p>  <p>Flashing selections can be changed. Store and Confirm entries with the ENTER key</p> <p>Display: 13:24 ENTER TIME</p>
<p>PRIVATE CODE</p> <p>Special Note: After returning to the run mode, program editing is automatically locked after 60 seconds as long as no keys are pressed. The program editing can also be disabled by entering a number other than the private code at the Access Code prompt.</p>	<p>A personal code may be defined. This code is used to enable program editing.</p> <p>Note:</p> <ul style="list-style-type: none"> • The private code is factory set to 1000 • Entering a private code of "0" will always enable program editing (Turns automatic lock off) <p>Input:</p>  <p>Maximum 4 digit number: 0...9999 Store and Confirm entries with the ENTER key</p> <p>Display: 1000 PRIVATE CODE</p>
<p>SERVICE CODE</p> <p>Note: The Service Code will allow access to the same information as the Private Code with the following additional functions:</p> <ul style="list-style-type: none"> • Change the Service Code • Change the Order Code • Change the Serial No. • Clear Grand Total • Clear Errors in Error Log • View & Perform calibration in Service & Analysis Menu • Restore Factory Calibration Information in Service & Analysis Menu • Set Next Calibration Date • Print Maint.Report • Perform Service Test 	<p>A personal service code may be defined. This code is used to enable program menus that are normally reserved for factory and service personnel. (i.e.: Service & Analysis Submenu Group)</p> <p>Note:</p> <ul style="list-style-type: none"> • The service code is factory set to 2000 • The service code submenu will only appear if the service code was entered for the "Access Code". <p>Input:</p>  <p>Maximum 4 digit number: 0...9999 Store and Confirm entries with the ENTER key</p> <p>Display: 2000 SERVICE CODE</p>

**6.4
SYSTEM
PARAMETERS**
(Continued)

SYSTEM PARAMETERS	
ORDER CODE	<p>The order code (part number) of the unit can be entered. This will help in identifying what options were ordered.</p> <p>Note:</p> <ul style="list-style-type: none"> • The order number is set at the factory and should only be altered if options are added in the field by an authorized service technician. • Maximum of 10 characters. <p>Input:</p> <p> Alphanumeric characters for each of 10 positions 1...9; A...Z;</p> <p>Flashing selections can be changed. Store and Confirm entries with the ENTER key</p> <p>Display: SUPERtrol IIV10P ORDER CODE</p>
SERIAL NUMBER	<p>The serial number of the unit is assigned at the factory.</p> <p>Note:</p> <p>Maximum of 10 characters.</p> <p>Input:</p> <p> Alphanumeric characters for each of 10 positions 1...9; A...Z;</p> <p>Display: SN 12345 SERIAL NUMBER</p>
SERIAL-NO. SENS.	<p>The serial number or tag number of the flowmeter can be entered.</p> <p>Note:</p> <p>Maximum of 10 characters.</p> <p>Input:</p> <p> Alphanumeric characters for each of 10 positions 1...9; A...Z;_, <, =, >, ?, etc.</p> <p>Flashing selections can be changed. Store and Confirm entries with the ENTER key.</p> <p>Display: SN 12345 SERIAL-NO. SENS.</p>

6.5
DISPLAY

DISPLAY

SCROLL LIST

Select the variable that are to be displayed in the "HOME position" during normal operation. Each variable can be assigned to line 1 (L1), line 2 (L2) or NO (removed from scroll list).

Note:

- To initiate the scroll list press the SCROLL key. The list will be displayed in groups of two, each group is displayed for approximately 3 to 4 seconds.
- Any alarm messages will be displayed periodically, alternating throughout the scroll list.

Selection (with Prompt):

CHANGE? YES, NO
ADD TO LIST? L1, L2, NO

Variable Selection:
HEAT FLOW, MASS FLOW, VOLUME FLOW, STD. VOLUME FLOW, TEMP.1, TEMP.2, DELTA T, PRESSURE, DENSITY, SPEC. ENTHALPY, TIME, DATE, HEAT TOTAL, HEAT GRAND TOTAL, MASS TOTAL, MASS GRAND TOTAL, STD VOLUME TOTAL, STD.V. GRAND TOTAL, VOLUME TOTAL, VOL. GRAND TOTAL, PEAK DEMAND, DEMAND LAST HOUR, PEAK DEMAND TIME, PEAK DEMAND DATE

Note: Variable selection will vary depending on Flow Equation selected and options supplied.

Display:

```
ADD TO LIST?      L1
HEAT FLOW?
```

DISPLAY DAMPING

The "display damping" constant is used to stabilize fluctuating displays. The higher the constant, the less fluctuation will be displayed.

Note: Relay response time is affected by the value entered for display damping. The larger the display damping value, the slower the relay response time will be. This is intended to prevent false triggering of the relays. Enter a display damping factor of zero (0) for fastest response time.

Note:

- Factory setting: 1



Input:

2 digits max; 0...99

Display:

```
CONSTANT?      1
DISPLAY DAMPING
```

6.5
DISPLAY
 (Continued)

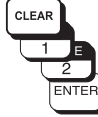
DISPLAY	
MAX. DEC. POINT	<p>Enter the number of decimal places for numerical values.</p> <p>Note:</p> <ul style="list-style-type: none"> • The number of decimal places applies to all displayed variables and totalizers. • The number of decimal places is automatically reduced if there is insufficient space available on the display for large numbers. • The number of decimal places set here does not affect the functions set in the programming setup. <p>Selection:</p> <div style="display: flex; align-items: center;">  <p>0, 1, 2, 3 or 4 (decimal places)</p> </div> <p>Display: 3</p> <p style="text-align: center;">MAX. DEC. POINT</p>
LANGUAGE	<p>The language can be selected in which all text, parameters and operating messages are to be displayed.</p> <p>Note:</p> <ul style="list-style-type: none"> • This function is supported by a special capability in the setup diskette. <p>Selection:</p> <div style="display: flex; align-items: center;">  <p>ENGLISH, OTHER</p> </div> <p>Display: ENGLISH</p> <p style="text-align: center;">LANGUAGE</p>
TOTAL ROLL OVER	<p>Some customer software can not handle very large numbers (such as 999,999,999) without going to scientific notation (such as 9.9999999E8). This menu can be used to force the totalizers to roll over at a lower numerical value (such as 999,999).</p> <p>Input:</p> <div style="display: flex; align-items: center;">  <p>Maximum 9 digit number: 0...999999999 Store and Confirm entries with the ENTER key</p> </div> <p>Display: 999999999</p> <p style="text-align: center;">TOTAL ROLL OVER</p>

6.6 SYSTEM UNITS

SYSTEM UNITS

TIME BASE

Select "one" unit of time to be used as a reference for all measured or derived and time-dependant process variables and functions such as:

- flowrate (volume/time; mass/time)
- heat flow (amount of energy/time) etc.

Selection:

 /s (per second), /m (per minute),
/h (per hour), /d (per day)

Display:

/h
TIME BASE

HEAT FLOW UNIT

Select the unit for heat flow (amount of energy, combustion heat).

Note:

The unit selected here also applies to the following:

- Zero and full scale value for current.
- Relay setpoints

Selection:

 kBtu/time base, kW, MJ/time base, kCal/time base, MW,
tons, GJ/h, Mcal/h, Gcal/h, Mbtu/h, Gbtu/h

Display:

kBtu/h
HEAT FLOW UNIT

HEAT TOTAL UNIT

Select the unit of heat for the particular totalizer.

Note:

The unit selected here also applies to the following:

- Pulse value for pulse output
- Relay setpoints

Selection:

 kBtu, kWh, MJ, kCal, MWh, tonh,GJ, Mcal, Gcal, Mbtu, Gbtu

Display:

kBtu
HEAT FLOW UNIT

6.6
SYSTEM
UNITS
 (Continued)

SYSTEM UNITS

MASS FLOW UNIT

Select the unit of mass flowrate (mass/time base).

Note:

The unit selected here also applies to the following:

- Zero and full scale value for current
- Relay setpoints

Selection:



lbs/time base, kg/time base, g/time base,
 t/time base, tons(US)/time base,
 tons(long)/time base

Display:

lbs/h
 MASS FLOW UNIT

MASS TOTAL UNIT

Select the unit of mass for the particular totalizer.

Note:

The unit selected here also applies to the following:

- Pulse value for pulse output
- Relay setpoints

Selection:



lbs, kg, g, t, tons(US), tons(long), hlbs, Klbs, Mlbs

Display:

lbs
 MASS TOTAL UNIT

6.6
SYSTEM
UNITS
(Continued)

SYSTEM UNITS

VOLUME FLOW UNIT

Select the unit for volumetric flowrate.

Note:

The unit selected here also applies to the following:

- Zero and full scale value for current
- Relay setpoints

Selection:

The available selections will change depending on the flow equation selected.



bbl/time base, gal/time base, l/time base, hl/time base, dm³/time base, ft³/time base, m³/time base, acf/time base, igal/time base

All units listed above apply to the actual volume measured under operating conditions.

Display:

ft³/h
VOLUME FLOW UNIT

VOLUME TOTAL UNIT

Select the unit for uncorrected volume totalizer.

Note:

The unit selected here also applies to the following:

- Pulse value for pulse output
- Relay setpoints

Selection:

The available selections will change depending on the flow equation selected.





bbl, gal, l, hl, dm³, ft³, m³, acf, igal

All units listed above apply to the actual volume measured under operating conditions.

Display:

ft³
VOLUME TOTAL UNIT

**6.6
SYSTEM
UNITS**
(Continued)

SYSTEM UNITS	
DEFINITION bbl	<p>In certain countries the ratio of gallons (gal) per barrels (bbl) can vary according to the fluid used and the specific industry. Select one of the following definitions:</p> <ul style="list-style-type: none"> • US or imperial gallons • Ratio gallons/barrel <p>Selection:</p> <p>  US: 31.0 gal/bbl for beer (brewing) US: 31.5 gal/bbl for liquids (normal cases) US: 42.0 gal/bbl for oil (petrochemicals) US: 55.0 gal/bbl for filling tanks imp: 36.0 gal/bbl for beer (brewing) imp: 42.0 gal/bbl for oil (petrochemicals) </p> <p>Display: US: 31.0 gal/bbl DEFINITION bbl</p>
TEMPERATURE UNIT	<p>Select the unit for the fluid temperature.</p> <p>Note: The unit selected here also applies to the following:</p> <ul style="list-style-type: none"> • Zero and full scale value for current • Relay setpoints • Reference conditions • Specific heat <p>Selection:</p> <p>  °C (Celsius), °F (Fahrenheit), °K (Kelvin), °R (Rankine) </p> <p>Display: °F TEMPERATURE UNIT</p>

**6.6
SYSTEM
UNITS**
(Continued)

SYSTEM UNITS																												
PRESSURE UNIT	<p>Select the unit for process pressure.</p> <p>Note: The unit selected here also applies to the following:</p> <ul style="list-style-type: none"> • Zero and full scale value for current • Relay setpoints • Reference conditions <p>Differential pressure is in mbar for Metric selections Differential pressure is in "H₂O f or English selections</p> <p>Selection:</p> <div style="display: flex; align-items: center; margin-bottom: 10px;"> bara, kpaa, kc2a, psia, barg, psig, kpag, kc2g </div> <p>Definitions:</p> <table style="margin-left: 20px; border: none;"> <tr> <td style="padding-right: 10px;">bara</td> <td style="padding-right: 10px;">bar</td> <td></td> </tr> <tr> <td>kpaa</td> <td>kpa</td> <td>Absolute pressure</td> </tr> <tr> <td>kc2a</td> <td>kg/cm²</td> <td>("a" for absolute)</td> </tr> <tr> <td>psia</td> <td>psi</td> <td></td> </tr> <tr> <td colspan="3"> </td> </tr> <tr> <td>barg</td> <td>bar</td> <td>Gauge pressure compared to atmospheric pressure</td> </tr> <tr> <td>kpag</td> <td>kpa</td> <td></td> </tr> <tr> <td>kc2g</td> <td>kg/cm²</td> <td>("g" for gauge)</td> </tr> <tr> <td>psig</td> <td>psi</td> <td></td> </tr> </table> <p>Gauge pressure differs from absolute pressure by the atmospheric pressure, which can be set in the submenu group "OTHER INPUT".</p> <p>Display: psia PRESSURE UNIT</p>	bara	bar		kpaa	kpa	Absolute pressure	kc2a	kg/cm ²	("a" for absolute)	psia	psi					barg	bar	Gauge pressure compared to atmospheric pressure	kpag	kpa		kc2g	kg/cm ²	("g" for gauge)	psig	psi	
bara	bar																											
kpaa	kpa	Absolute pressure																										
kc2a	kg/cm ²	("a" for absolute)																										
psia	psi																											
barg	bar	Gauge pressure compared to atmospheric pressure																										
kpag	kpa																											
kc2g	kg/cm ²	("g" for gauge)																										
psig	psi																											
DENSITY UNIT	<p>Select the unit for the density of the fluid.</p> <p>Note: The unit selected here also applies to the following:</p> <ul style="list-style-type: none"> • Zero and full scale value for current • Relay setpoints <p>Selection:</p> <div style="display: flex; align-items: center; margin-bottom: 10px;"> kg/m³, kg/dm³, #/gal, #/ft³ (# = lbs = 0.4536 kg) </div> <p>Display: #/ft³ DENSITY UNIT</p>																											

6.6
SYSTEM
UNITS
(Continued)

SYSTEM UNITS

SPEC. ENTHALPY UNIT

Select the unit for the combustion value (spec. enthalpy).

Note:

The unit selected here also applies to the following:

- Specific thermal capacity
(kWh/kg → kWh/kg - °C)

Selection:



btu/#, kWh/kg, MJ/kg, kCal/kg
(# = lbs = 0.4536 kg)

Display:

Btu/#
SPEC. ENTHALPY UNIT

LENGTH UNIT

Select the unit for measurements of length.

Selection:

in, mm

Display:

in
LENGTH UNIT

6.7
FLUID DATA

FLUID DATA

FLUID TYPE

Select the fluid. There are three types:

1. Steam / Water

All information required for steam and water (such as saturated steam curve, density and thermal capacity) is permanently stored in the flow computer.

2. Fluid Displayed

Preset information for other fluids (such as air and natural gas) is stored in the flow computer and can directly adopted by the user.

If the preset values need to be changed to fit your specific process conditions, then proceed as follows:

Select the fluid (air or natural gas) and press the ENTER key (this sets all of the preset values).

Re-select the submenu group "FLUID TYPE", now choose "GENERIC" and ENTER. Now the preset values for the previously selected fluid can be altered.

3. Generic Fluid

Select the setting "GENERIC" for the Fluid type submenu. The characteristics of any fluid can now be defined by the user.

Selection:



GENERIC, WATER, SATURATED STEAM, SUPERHEATED STEAM, DRY AIR, HUMID AIR, HUMID GAS, NATURAL GAS, NATURAL GAS (NX-19), HYDROGEN, ARGON, METHANE, NITROGEN, CARBON DIOXIDE, PROPANE, OXYGEN, ETHANE, HELIUM

Display: GENERIC
 FLUID TYPE

REF. DENSITY

Select the density for a generic fluid at reference temperature and pressure (see "STP REFERENCE" in "OTHER INPUT" submenu group).

Input:

Number with floating decimal point: 0.0001...10000.0

Display: .0760 #/ft³
 REF. DENSITY

6.7
FLUID DATA
 (Continued)

FLUID DATA

THERM. EXP. COEF. Enter the thermal expansion coefficient for a generic liquid. The coefficient is required for the temperature compensation of volume with various flow equations (i.e. Liquid Mass or Corrected Liquid Volume).

Input:



Number with floating decimal point: 0.000...100000 (e-6)

The thermal expansion coefficient can be calculated as follows:

$$c = \frac{1 - \sqrt{\frac{\rho(T_1)}{\rho(T_0)}}}{T_1 - T_0} + 10^6$$

c Thermal expansion coefficient
 T₀, T₁ Temperatures at known points (see below)
 ρ (T₀, T₁) Density of the liquid at temperature T₀ or T₁

For optimum accuracy, choose the reference temperatures as follows:
 T₀: midrange temperature
 T₁: choose a second point at or near the maximum process temperature

10⁶ The value entered is internally multiplied by a factor of 10⁻⁶ (display: e-6/temp. unit) since the value to be entered is very small.

Display: 104.300 (e-6/oF)
 THERM. EXP. COEF.

COMBUSTION HEAT Enter the specific combustion heat for generic fuels.

Input:



Number with floating decimal point: 0.000...100000

Display: 1000.000 kBtu/lbs
 COMBUSTION HEAT

SPECIFIC HEAT Enter the specific heat capacity for generic fluids. This value is required for calculating the delta heat of liquids.



Input:



Number with floating decimal point: 0.000...10.000

Display: 10.000 kBtu/lbs-°F
 SPECIFIC HEAT

6.7
FLUID DATA
 (Continued)

FLUID DATA	
FLOW. Z-FACTOR	<p>Enter a Z-factor for the gas at operating conditions. The Z-factor indicates how different a "real" gas behaves from an "ideal gas" which exactly obeys the "general gas law" ($P \times V/T = \text{constant}$; $Z=1$). The further the real gas is from its condensation point, the closer the Z-factor approaches "1".</p> <p>Note:</p> <ul style="list-style-type: none"> • The Z-factor is used for all gas equations. • Enter the Z-factor for the average process conditions (pressure and temperature). <p>Input:</p> <div style="display: flex; align-items: center;">  <p>Number with fixed decimal point: 0.1000...10.0000</p> </div> <p>Display:</p> <pre style="text-align: right; margin-right: 100px;"> 1.0000 FLOW. Z-FACTOR </pre>
REF. Z-FACTOR	<p>Enter a Z-factor for the gas at reference conditions.</p> <p>Note:</p> <ul style="list-style-type: none"> • The Z-factor is used for all gas equations. • Define the standard conditions in the submenu "STP REFERENCE" (OTHER INPUT submenu group). <p>Input:</p> <p style="text-align: center;">Number with fixed decimal point: 0.1000...10.0000</p> <p>Display:</p> <pre style="text-align: right; margin-right: 100px;"> 1.0000 REF. Z-FACTOR </pre>
ISENTROPIC EXP.	<p>Enter the isentropic exponent of the fluid. The isentropic exponent describes the behavior of the fluid when measuring the flow with a square law flowmeter. The isentropic exponent is a fluid property dependent on operating conditions.</p> <p>Note:</p> <p>Select one of the "SQR LAW" selections in "FLOWMETER TYPE" of submenu group "FLOW INPUT" to activate this function.</p> <p>Input:</p> <div style="display: flex; align-items: center;">  <p>Number with fixed decimal point: 0.1000...10.0000</p> </div> <p>Display:</p> <pre style="text-align: right; margin-right: 100px;"> 1.4000 ISENTROPIC EXP. </pre>

6.7
FLUID DATA
 (Continued)

FLUID DATA

MOLE % NITROGEN

Enter the Mole % Nitrogen in the anticipated natural gas mixture. This information is needed by the NX-19 computation

Note:

Select "NATURAL GAS (NX-19)" in "FLUID TYPE" to activate this function.

Input:



Number with fixed decimal point: 0.00...15.00

Display:

0.00
 MOLE % NITROGEN

MOLE % CO₂

Enter the Mole % CO₂ in the anticipated natural gas mixture. This information is needed by the NX-19 computation

Note:

Select "NATURAL GAS (NX-19)" in "FLUID TYPE" to activate this function.

Input:



Number with fixed decimal point: 0.00...15.00

Display:

0.00
 MOLE % CO₂

VISCOSITY COEF. A

Enter the Viscosity coefficient A for the anticipated fluid. This information is needed by the viscosity computation for UVC and for Reynolds Number calculations.

Note:

Select "SQUARE LAW 16PT" or "LINEAR UVC" in "FLOWMETER TYPE" to activate this function.

Input:



Number with fixed decimal point: 0.000000...1000000

Display:

0.000444
 VISCOSITY COEF. A

6.7
FLUID DATA
 (Continued)

FLUID DATA

VISCOSITY COEF. B

Enter the Viscosity coefficient B for the anticipated fluid. This information is needed by the viscosity computation for UVC and for Reynolds Number calculations.

Note:

Select "SQUARE LAW 16PT" or "LINEAR UVC" in "FLOWMETER TYPE" to activate this function.

Input:



Number with fixed decimal point: 0.000000...1000000

Display:

0.3850
 VISCOSITY COEF. B

**Computation
 of Viscosity
 Coef. A and B**

Computation of Viscosity Coef. A and B

The flow computer solves an equation which computes the viscosity as a function of temperature. Two parameters must be entered for this calculation to be performed. These are the setup parameters Viscosity Coef. A and Viscosity Coef. B. A table listing these values for common fluids is available from the factory.

Alternately, if your intended fluid is not listed, the Viscosity Coef. A and B can be derived from two known temperature/viscosity pairs. Begin by obtaining this information for you intended fluid. Convert these known points to units of Degrees F and centipoise (cP)

The information is now in a suitable form to compute the Viscosity Coef. A and Viscosity Coef. B using the following equation based on the fluid state.

For a liquid, A and B are computed as follows:

$$B = \frac{(T1 + 459.67) \cdot (T2 + 459.67) \cdot \ln [cP1/cP2]}{(T2 + 459.67) - (T1 + 459.67)}$$

$$A = \frac{cP1}{\exp [B / (T1 + 459.67)]}$$

For a gas, A and B are computed as follows:

$$B = \frac{\ln [cP2 / cP1]}{\ln [(T2 + 459.67) / (T1 + 459.67)]}$$

$$A = \frac{cP1}{(T1 + 459.67)^B}$$

NOTE: $cS = \frac{cP}{\text{Density (in kg/l)}}$

% RELATIVE HUMIDITY

Enter the % Relative Humidity in the anticipated gas mixture. This information is needed to more accurately compute the density of a Humid gas.

nput:



Number with fixed decimal point: 0.000000...100.0000

Display:

0.3850
 % RELATIVE HUMIDITY

6.8
FLOW INPUT**FLOW INPUT****FLOWMETER TYPE**

Select the flowmeter type. The flow equation (see SYSTEM PARAMETERS) and the flowmeter selected here determine the basic operation of the flow computer.

Selection:



LINEAR		Volumetric flowmeter with linear pulse or analog output.
SQR LAW		Differential pressure transmitter without square root extraction, with analog output.
SQR LAW-LIN.		Differential pressure transmitter with square root extraction and analog output.
LINEAR 16 PT*		Volumetric flowmeter with nonlinear pulse or analog output; with 16 point linearization table.
SQR LAW 16 PT*		Differential pressure transmitter without square root extraction, with analog output and 16 point linearization table.
SQR LAW-LIN. 16 PT*		Differential pressure transmitter with square root extraction, analog output and 16 point linearization table.
LINEAR UVC		Volumetric Turbine flowmeter with UVC calibration curve documentation and pulse output.
LINEAR MANIFOLD		Linear manifold consists of 2 linear flowmeters used in conjunction with an external bypass/diverter valve. It may be used with turbine, PD, Mag, Vortex flowmeters equipped with analog outputs to extend the allowable turndown range.
GILFLO		Gilflo flowmeters are special purpose differential pressure type flowmeters with an analog output where the differential pressure is linear with flow.
GILFLO 16PT		Gilflo 16 PT flowmeters are special purpose differential pressure type flowmeters with an analog output where the differential pressure is approximately linear with flow, but can be further enhanced by a 16 point linearization table.
BYPASS		BYPASS is a selection for use with Bypass(Shuntflow) flowmeters equipped with a pulse output.
ILVA 16PT		ILVA 16 PT flowmeters are special purpose differential pressure type flowmeters with an analog output where the differential pressure is approximately linear with flow, but can be further enhanced by a 16 point linearization table.
MASS FLOW METER		Flowmeter type such as Coriolis, or Thermal Flowmeter whose output is directly proportional to mass flow. Multivariable transmitters whose output is proportional to a computed mass flow rate can also use this meter type selection.

* A linearization table must be entered by user.
(see "LINEARIZATION" submenu).

Display:

LINEAR
FLOWMETER TYPE

6.8
FLOW INPUT
(Continued)

FLOW INPUT																					
SQUARE LAW FLOWMETER	<p>Select the type of square law flowmeter to be used with the instrument.</p> <p>Note: This selection will only appear if one of the Square Law selections were made in "FLOWMETER TYPE".</p> <p>Selection:  ORIFICE, V-CONE, ANNUBAR, PITOT, VENTURI, FLOW NOZZLE, BASIC SQRLAW/TARGET, WEDGE, VERABAR, ACCELABAR</p> <p>Display: ORIFICE SQUARE LAW FLOWMETER</p>																				
ILVA METER SIZE	<p>Select the size of the ILVA flowmeter.</p> <p>Selection:  DN50, DN80, DN100, DN150, DN200, DN250, DN300</p>																				
ACCELABAR SIZE	<p>Select the size of the Accelabar flowmeter.</p> <p>Selection:  1 inch, 2 inch, 3 inch, 4 inch, 6 inch, 8 inch, 10 inch, 12 inch</p>																				
INPUT SIGNAL	<p>Select the type of measuring signal produced by the flowmeter.</p> <p>Selection:</p> <table style="width: 100%; border: none;"> <tr> <td style="width: 50%;">DIGITAL, 10 mV LEVEL</td> <td style="width: 50%;">Voltage pulses, 10mV trigger threshold.</td> </tr> <tr> <td>DIGITAL, 100 mV LEVEL</td> <td>Voltage pulses, 100mV trigger threshold.</td> </tr> <tr> <td>DIGITAL, 2.5 V LEVEL</td> <td>Voltage pulses, 2.5V trigger threshold.</td> </tr> <tr> <td>4-20 mA</td> <td>4-20 mA current signal</td> </tr> <tr> <td>0-20 mA</td> <td>0-20 mA current signal</td> </tr> <tr> <td>4-20 mA STACKED</td> <td>4-20 mA current signal</td> </tr> <tr> <td>0-20 mA STACKED</td> <td>0-20 mA current signal</td> </tr> <tr> <td>0-5 V</td> <td>0-5 V voltage signal</td> </tr> <tr> <td>1-5 V</td> <td>1-5 V voltage signal</td> </tr> <tr> <td>0-10 V</td> <td>0-10 V voltage signal</td> </tr> </table> <p>Display: 4-20 mA INPUT SIGNAL</p>	DIGITAL, 10 mV LEVEL	Voltage pulses, 10mV trigger threshold.	DIGITAL, 100 mV LEVEL	Voltage pulses, 100mV trigger threshold.	DIGITAL, 2.5 V LEVEL	Voltage pulses, 2.5V trigger threshold.	4-20 mA	4-20 mA current signal	0-20 mA	0-20 mA current signal	4-20 mA STACKED	4-20 mA current signal	0-20 mA STACKED	0-20 mA current signal	0-5 V	0-5 V voltage signal	1-5 V	1-5 V voltage signal	0-10 V	0-10 V voltage signal
DIGITAL, 10 mV LEVEL	Voltage pulses, 10mV trigger threshold.																				
DIGITAL, 100 mV LEVEL	Voltage pulses, 100mV trigger threshold.																				
DIGITAL, 2.5 V LEVEL	Voltage pulses, 2.5V trigger threshold.																				
4-20 mA	4-20 mA current signal																				
0-20 mA	0-20 mA current signal																				
4-20 mA STACKED	4-20 mA current signal																				
0-20 mA STACKED	0-20 mA current signal																				
0-5 V	0-5 V voltage signal																				
1-5 V	1-5 V voltage signal																				
0-10 V	0-10 V voltage signal																				

6.8
FLOW INPUT
(Continued)

FLOW INPUT

LOW SCALE

Set the low scale value for the analog input signal.
The value entered here must be identical to the value set for the flowmeter.

Note:

- For flowmeters with analog/linear output, the flow computer uses the selected system units for volumetric flowrate.
- The units for differential pressure flowmeters are dependent on the system units selected for pressure:
 - Imperial units [inches H2O]
 - Metric units: [mbar]

Input:



Number with floating decimal point: 0.000...999999

Display:

.000 ft³/h
LOW SCALE VALUE

FULL SCALE

Set the full scale value for the analog input signal.
The value entered here must be identical to the value set for the flowmeter.

Note:

- For flowmeters with analog/linear output, Target, generic square law and Gilflo flowmeters, the flow computer uses the selected system units for volumetric flowrate.
- The units for differential pressure flowmeters are dependent on the system units selected for pressure:
 - Imperial units [inches H2O]
 - Metric units: [mbar]

Input:



Number with floating decimal point: 0.000...999999

Display:

10000.00 ft³/h
FULL SCALE VALUE

LOW SCALE-HI RANGE

Set the low scale value for the high range transmitter analog input signal.
The value entered here must be identical to the value set for the flowmeter.

Note:

- The units for differential pressure flowmeters are dependent on the system units selected for pressure:
 - Imperial units [inches H2O]
 - Metric units: [mbar]

Input:







Number with floating decimal point: 0.000...999999

Display:

.000 ft³/h
LOW SCALE-HIGH RANGE

6.8
FLOW INPUT
(Continued)

FLOW INPUT	
FULL SCALE-HI RANGE	<p>Hi scale value for the high range transmitter analog input signal. The value entered here must be identical to the value set for the flowmeter.</p> <p>Note:</p> <ul style="list-style-type: none"> • The units for differential pressure flowmeters are dependent on the system units selected for pressure: <ul style="list-style-type: none"> - Imperial units [inches H2O] - Metric units: [mbar] <p>Input:</p> <div style="display: flex; align-items: center;">  Number with floating decimal point: 0.000...999999 </div> <p>Display:</p> <div style="text-align: right; margin-right: 50px;"> 10000.00 ft³/h FULL SCALE VALUE </div>
SWITCH UP DP	<p>Enter the value of delta P at which the unit will begin using the hi range delta P pressure transmitter signal.</p> <p>Input:</p> <div style="display: flex; align-items: center;">  Number with floating decimal point: 0.000...999999 </div> <p>Display:</p> <div style="text-align: right; margin-right: 50px;"> 0.000 in H2O SWITCH UP DP </div>
SWITCH DOWN DP	<p>Enter the value of delta P at which the unit will begin using the lo range delta P pressure transmitter signal.</p> <p>Input:</p> <div style="display: flex; align-items: center;">  Number with floating decimal point: 0.000...999999 </div> <p>Display:</p> <div style="text-align: right; margin-right: 50px;"> 0.000 in H2O SWITCH UP DP </div>
LOW FLOW CUTOFF	<p>Enter the low flow cutoff. This is used as a switchpoint for creep suppression. This can be used to prevent low flows from being registered.</p> <p>Input:</p> <div style="display: flex; align-items: center;">  Number with floating decimal point: 0.000...999999 </div> <p>Display:</p> <div style="text-align: right; margin-right: 50px;"> .000 ft³/h LOW FLOW CUTOFF </div>

6.8
FLOW INPUT
(Continued)

FLOW INPUT

K-FACTOR

Enter the K-Factor of the flowmeter.

Note:

- The K-Factor is expressed in pulses per unit volume (as defined by "total units")

Input:



Number with floating decimal point: 0.001...999999

Display:

.000 ft³/h
LOW FLOW CUTOFF

INLET PIPE BORE

Enter the inlet pipe diameter or bore for the piping section upstream of the flow measurement device.

Input:



Number with floating decimal point: 0.001...1000.00

Display:

4.090 in
INLET PIPE BORE

ENTER BETA

Enter the geometric ratio for the square law device being used. This value is given by the manufacturer of the orifice plate, or other square law device.

Note:

"Beta" is only required for measuring gas or steam with some square law flowmeters.

Input:

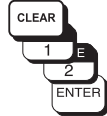

Number with fixed decimal point: 0.0000...1.0000

Display:

1.0000
ENTER BETA

CAL. DENSITY

Enter the calibration density. This is the fluid density upon which the flowmeter's calibration is based.

Input:

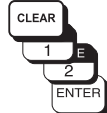

Number with floating decimal point in requested units:
0.000...10.000

Display:

8.3372 (#/gal)
CAL. DENSITY

6.8
FLOW INPUT
 (Continued)

FLOW INPUT

METER EXP. COEF.

The flowmeter pipe expands depending on the temperature of the fluid. This affects the calibration of the flowmeter. This submenu allows the user to enter an appropriate correction factor. This is given by the manufacturer of the flowmeter. This factor converts the changes in the measuring signal per degree variation from calibration temperature. The calibration temperature is entered into the flow computer to 70 F / 21 °C.

Some manufacturers use a graph or a formula to show the influence of temperature on the calibration of the flowmeter. In this case use the following equation to calculate the meter expansion coefficient:

$$K_{me} = \frac{1 - \frac{Q(T)}{Q(T_{CAL})}}{T - T_{CAL}} \cdot 1,000,000$$

K_{ME} Meter expansion coefficient
 $Q(T)$ Volumetric flow at temperature T resp. T_{CAL}
 T Average process temperature
 T_{CAL} Calibration temperature

Note:

- This correction should be set in either the flowmeter or in the flow computer.
- Entering the value "0.000" disables this function
- Value can be calculated from Fa factor

Input:



Number with floating decimal point:
 0.000...999.9 (e-6/°X)

Display: 27.111 (E-6/°F)
 METER EXP. COEF.

6.8
FLOW INPUT
(Continued)

FLOW INPUT

DP FACTOR

The DP-Factor describes the relationship between the flowrate and the measured differential pressure. The flowrate is computed according to one of the three following equations, depending on the selected flow equation:

Steam (or gas) mass flow:

$$M = \frac{K_{DP} \cdot \varepsilon_1 \cdot \sqrt{2 \cdot \Delta p \cdot \rho}}{1 - K_{ME} \cdot (T - T_{CAL})}$$

Liquid volume flow:

$$Q = \frac{K_{DP} \cdot \sqrt{(2 \cdot \Delta p) / \rho}}{(1 - K_{ME} \cdot (T - T_{CAL}))}$$

Gas corrected volume flow:

$$Q_{REF} = \frac{K_{DP} \cdot \varepsilon_1 \cdot \sqrt{2 \cdot \Delta p \cdot \rho}}{\rho_{REF} \cdot (1 - K_{ME} \cdot (T - T_{CAL}))}$$

M	Mass flow
Q	Volumetric flow
Q _{REF}	Corrected volumetric flow
K _{DP}	DP-Factor
ε ₁	Gas expansion factor (Y ₁)
T	Operating temperature
T _{CAL}	Calibration temperature
Δp	Differential pressure
ρ	Density at flowing conditions
K _{ME}	Meter expansion coefficient x 10 ⁻⁶
ρ _{REF}	Reference density

6.8
FLOW INPUT
 (Continued)

FLOW INPUT

DP FACTOR
 (Continued)

The DP-Factor (K_{DP}) can be entered manually or the flow computer can compute it for you. The information necessary for this calculation can be found on the sizing sheet from a flowmeter sizing program.

Note:

The following data must be entered before the flow computer can compute the DP-Factor.

- | | |
|------------------------------------|------------------------|
| 1. Flow equation | see "SYSTEM PARAMETER" |
| 2. Fluid Data | see "FLUID DATA" |
| 3. Beta | see "FLOW INPUT" |
| 4. Meter expansion coef. ref | see "FLOW INPUT" |
| 5. STP Ref. temperature*, pressure | see "OTHER INPUT" |
| 7. Inlet Pipe Bore | see "FLOW INPUT" |
| 8. Calibration Temp. | see "OTHER INPUT" |

* only for gas flow equations.

Entries:



CHANGE FACTOR? NO
 CHANGE FACTOR? YES

If "YES" the flow computer will prompt you further:



COMPUTE FACTOR? NO
 COMPUTE FACTOR? YES

If "NO": Enter DP FACTOR

If "YES": You will be prompted for the following:



ENTER DELTA P
 ENTER FLOWRATE
 ENTER DENSITY
 ENTER TEMPERATURE
 ENTER INLET PRESSURE
 ENTER ISENTROPIC EXP

6.8
FLOW INPUT
(Continued)

FLOW INPUT

DP FACTOR
(Continued)

The flow computer will then compute the gas expansion factor (ϵ_1), (Y_1) using one of the following equation:

Orifice Case:

$$Y_1 = \epsilon_1 = 1 - \left[(0.41 + 0.35 \beta^4) \cdot \frac{\Delta p}{\kappa \cdot p_1 \cdot 27.7} \right]$$

Venturi, Flow Nozzle, Wedge Case:

$$R = 1 - \frac{\Delta p}{27.7 \cdot p_1}$$

$$Y_1 = \epsilon_1 = \sqrt{\frac{(1 - \beta^4) \cdot \frac{\kappa}{\kappa - 1} \cdot R^{2/\kappa} \cdot (1 - R^{(\kappa-1)/\kappa})}{[(1 - (\beta^4 \cdot R^{2/\kappa})) \cdot (1 - R)]}}$$

V-Cone Case

NOTE: $Y=1$ for noncompressible fluids (e.g. water, oil etc.).

$$Y = 1 - (0.649 + 0.696\beta^4) \frac{\Delta P / 27.7}{\kappa \cdot P}$$

Note that ΔP and P can be in any units as long as they are the same.

Annubar, Pitot, Target Case;

$$Y_1 = \epsilon_1 = 1.0$$

ϵ_1 Gas expansion factor
 β BETA (geometric ratio)
 Δp Differential pressure
 κ Isentropic exponent
 p_1 Inlet pressure (absolute)

NOTE: 27.7 is a units conversion constant from the absolute inlet pressure units to the differential pressure units. (27.7 is for psia to "H2O, use other units conversions as required.).

**6.8
FLOW INPUT**
(Continued)

FLOW INPUT

DP FACTOR
(Continued)

The DP-Factor (K_{DP}) is then computed using one of the following equations:

Steam:

$$K_{DP} = \frac{M \cdot (1 - K_{ME} \cdot (T - T_{CAL}))}{\epsilon_1 \cdot \sqrt{2 \cdot \Delta p} \cdot \rho}$$

Liquid:

$$K_{DP} = \frac{Q \cdot (1 - K_{ME} \cdot (T - T_{CAL}))}{\sqrt{\frac{2 \cdot \Delta p}{\rho}}}$$

Gas:

$$K_{DP} = \frac{Q_{REF} \cdot \rho_{REF} \cdot (1 - K_{ME} \cdot (T - T_{CAL}))}{\epsilon_1 \cdot \sqrt{2 \cdot \Delta p} \cdot \rho}$$

- K_{DP} DP-Factor
- M Mass flow
- Q Volumetric flow
- Q_{REF} Corrected volumetric flow
- ϵ_1 Gas expansion factor
- T Operating temperature
- T_{CAL} Calibration temperature
- Δp Differential pressure
- ρ Density at flowing conditions
- ρ_{REF} Reference density

Note:

The computation accuracy can be enhanced by entering up to 16 values for Reynold's Number DP-Factor in a linearization table (see "LINEARIZATION"). Each DP-Factor can be calculated using the above procedure. For every calculation, a sizing sheet is required. The results have to be entered in the linearization table afterwards.

LOW PASS FILTER

Enter the maximum possible frequency of a flowmeter with a digital output. Using the value entered here, the flow computer selects a suitable limiting frequency for low pass filter to help suppress interference from higher frequency signals.

Input:



Max. 5 digit number: 10...40000 (Hz):

Display:

40000 Hz
LOW PASS FILTER

6.8
FLOW INPUT
(Continued)

FLOW INPUT

LINEARIZATION

With many flowmeters, the relationship between the flowrate and the output signal may deviate from an ideal curve (linear or squared). The flow computer is able to compensate for this documented deviation using a linearization table. The appearance of the linearization table will vary depending on particular flowmeter selected.

Linear flowmeters with pulse output

The linearization table enables up to 16 different frequency & K-factor pairs. The frequency and corresponding K-factor are prompted for each pair of values. Pairs are entered in ascending order by frequency.

Linear Flowmeters with pulse outputs and a UVC Curve:

The linearization table enables up to 16 different Hz/cstks and K-Factor points. The Hz/cstks and corresponding K-Factors are prompted for each pair of values. Pairs are entered in ascending order by Hz/cstks.

Linear flowmeters with analog output (excluding Gilflo, ILVA)

The linearization table enables up to 16 different flowrate & correction factor pairs. The flowrate and corresponding correction factor are prompted for each pair of values. The correction factor (C_f) is determined as follows.

$$C_f = \frac{\text{actual flowrate}}{\text{displayed flowrate}}$$

Linear/squared DP transmitters with analog output

The linearization table enables up to 16 different Reynold's Number an DP factor pairs. The Reynold's Number and corresponding DP factor are prompted for each pair of values.

Selection:



CHANGE TABLE?	NO
CHANGE TABLE?	YES

If "YES" the linearization table sequence of prompts will begin.

Example (for linear flowmeters with analog output)





```
Enter flow rate:
FLOW ft3/h  3.60
POINT 0
```

```
Entry of corresponding correction factor:
COR.FACTOR  1.0000
POINT 0
```

Note:

Enter "0" for the value of a pair (other than point 0) to exit the linearization table routine and use the values stored up to that point.

6.8
FLOW INPUT
(Continued)

FLOW INPUT	
FLOWMETER LOCATION	<p>Enter the Flowmeter Location</p> <p>Selection:</p>  Hot, Cold: <p>Display: COLD FLOWMETER LOCATION</p>
BYPASS CAL. FACTOR	<p>Enter the Bypass Calibration Factor.</p> <p>Input:</p>  Max. 6 digit number: 0.000001...999999 <p>Display: 1.000000 BYPASS CAL. FACTOR</p>
BYPASS EAm FACTOR	<p>Enter the Bypass EAm Factor.</p> <p>Input:</p>  Max. 6 digit number: 0.000001...999999 <p>Display: 1.000000 BYPASS EAm FACTOR</p>
BYPASS DC FACTOR	<p>Enter the Bypass DC Factor.</p> <p>Input:</p>  Max. 6 digit number: 0.1...10.0 <p>Display: 1.000000 BYPASS DC FACTOR</p>
BYPASS Ym FACTOR	<p>Enter the Bypass Ym Factor.</p> <p>Input:</p>  Max. 6 digit number: 0.001...1.0 <p>Display: 1.000000 BYPASS Ym FACTOR</p>
VIEW INPUT SIGNAL	<p>This feature is used to see the present value of the flow input signal. The type of electrical signal is determined by the flowmeter input signal type selection.</p> <p>Display: 150 Hz VIEW INPUT SIGNAL</p>
VIEW HIGH RANGE SIGNAL	<p>This feature is used to see the present value of the high range flow input signal. The type of electrical signal is determined by the flowmeter input signal type selection.</p> <p>Display: 4 mA VIEW HIGH RANGE SIGNAL</p>

6.9 OTHER INPUT

OTHER INPUT

SELECT INPUT

In addition to the flow input, the flow computer provides two other inputs for temperature, density and/or pressure signals. In this submenu, select the particular input which is to be configured in the following submenus. Input 1 may also be used in conjunction with a steam trap monitor.

Selection:



1 (input 1: Temperature or Steam Trap Monitor)

2 (input 2: Pressure, Temperature 2, Density)

Display:

1

SELECT INPUT

INPUT SIGNAL

Determine the type of measuring signal produced by the temperature, pressure or density sensor.

Note:

When saturated steam is measured with only a pressure sensor, "INPUT 1 NOT USED" must be selected. If only a temperature sensor is used, "INPUT 2 NOT USED" must be selected.

Selection:

Input 1 (Temperature):



INPUT 1 NOT USED, RTD TEMPERATURE, 4-20 TEMPERATURE, 0-20 TEMPERATURE, MANUAL TEMPERATURE*, 4-20 mA TRAP STATUS

Input 2 (Process pressure, Temperature 2, Density):



INPUT 2 NOT USED, 4-20 PRESSURE (G), 0-20 PRESSURE (G), MANUAL PRESSURE*, 4-20 PRESSURE (ABS.), 0-20 PRESSURE (ABS.), RTD TEMPERATURE 2, 4-20 TEMPERATURE 2, 0-20 TEMPERATURE 2, MANUAL TEMPERAT. 2*, 4-20 DENSITY, 0-20 DENSITY, MANUAL DENSITY*





* Select this setting if a user defined fixed value for the corresponding measuring value is required.

Display:



4-20 TEMPERATURE

INPUT SIGNAL

**6.9
OTHER
INPUT**
(Continued)

OTHER INPUT	
LOW SCALE VALUE	<p>Set the low scale value for the analog current input signal (value for 0 or 4 mA input current). The value entered here must be identical to the value set in the pressure, temperature or density transmitter.</p> <p>Input:</p>  Number with fixed decimal point: -9999.99...+9999.99 <p>Display:</p> <p style="text-align: center;">32.00 of LOW SCALE VALUE</p>
FULL SCALE VALUE	<p>Set the full scale value for the analog current input signal (value for 20 mA input current). The value entered here must be identical to the value set in the pressure, temperature or density transmitter.</p> <p>Input:</p>  Number with fixed decimal point: -9999.99...+9999.99 <p>Display:</p> <p style="text-align: center;">752.00 of FULL SCALE VALUE</p>
DEFAULT VALUE	<p>A fixed value can be defined for the assigned variable (pressure, temperature, density). The flow computer will use this value in the following cases:</p> <ul style="list-style-type: none"> • In case of error (i.e. defective sensors). The flow computer will continue to operate using the value entered here. • if "MANUAL TEMPERATURE", "MANUAL PRESSURE" or "MANUAL DENSITY" was selected for "INPUT SIGNAL". <p>Input:</p>  Number with fixed decimal point: -9999.99...+9999.99 <p>Display:</p> <p style="text-align: center;">70.00 of DEFAULT VALUE</p>
STP REFERENCE	<p>Define the STP reference conditions (standard temperature and pressure) for the variable assigned to the input. Presently, standard conditions are defined differently depending on the country and application.</p> <p>Input:</p>  Number with fixed decimal point: -9999.99...+9999.99 <p>Display:</p> <p style="text-align: center;">60.00 of STP REFERENCE</p>

**6.9
OTHER
INPUT**
(Continued)

OTHER INPUT	
BAROMETRIC PRESS.	<p>Enter the actual atmospheric pressure. When using gauge pressure transmitters for determining gas pressure, the reduced atmospheric pressure above sea level is then taken into account.</p> <p>Input:</p> <p> Number with floating decimal point: 0.0000...10000.0</p> <p>Display: 1.013 bara BAROMETRIC PRESS.</p>
CALIBRATION TEMP.	<p>Enter the temperature at which the flowmeter was calibrated. This information is used in the correction of temperature induced effects on the flowmeter body dimensions.</p> <p>Input:</p> <p> Number with fixed decimal point: -9999.99...+9999.99</p> <p>Display: 68.00 of CALIBRATION TEMP.</p>
VIEW INPUT SIGNAL	<p>This feature is used to see the present value of the compensation input signal. The type of electrical signal is determined by the compensation input signal type selection.</p> <p>Display: 20 mA VIEW INPUT SIGNAL</p>
TRAP ERROR DELAY	<p>Enter the TRAP ERROR DELAY (cold trap error) in HH:MM format. An alarm will only be activated if the trap is detected as continuously being in the abnormal states for a time period greater than this TRAP ERROR DELAY time.</p> <p>Display: HH:MM TRAP ERROR DELAY</p>
TRAP BLOWING DELAY	<p>Enter the TRAP BLOWING DELAY (trap stuck open) in HH:MM format. An alarm will only be activated if the trap is detected as continuously being in the abnormal states for a time period greater than this TRAP BLOWING DELAY time.</p> <p>Display: HH:MM TRAP BLOWING DELAY</p>

**6.10
PULSE
OUTPUT****PULSE OUTPUT****ASSIGN PULSE OUT-
PUT**

Assign the pulse output to a measured or calculated totalizer value.

Selection:

HEAT TOTAL, MASS TOTAL,
CORRECTED VOL. TOTAL,
ACTUAL VOLUME TOTAL

Display:

ACTUAL VOLUME TOTAL
ASSIGN PULSE OUTPUT

**6.10
PULSE
OUTPUT**
(Continued)

PULSE OUTPUT

PULSE TYPE

The pulse output can be configured as required for an external device (i.e. remote totalizer, etc.).

- ACTIVE:** Internal power supply used (+24V).
- PASSIVE:** External power supply required.
- POSITIVE:** Rest value at 0V (active high).
- NEGATIVE:** Rest value at 24V (active low) or external power supply.

Active:

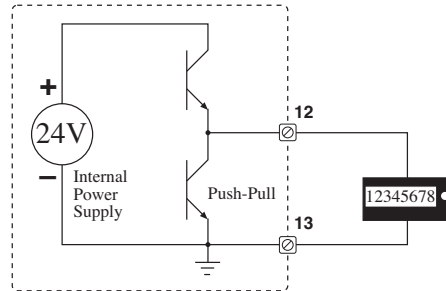

Passive:

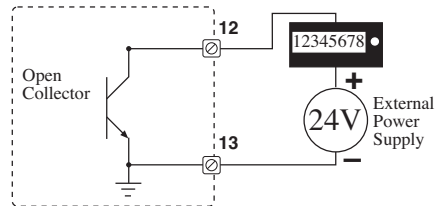

Positive Pulse:

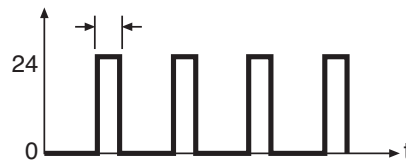

Negative Pulse:

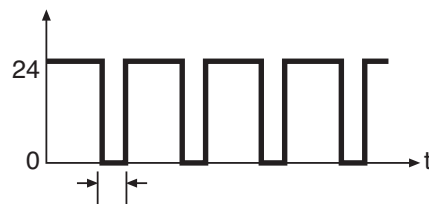

Selection:





PASSIVE-NEGATIVE, PASSIVE-POSITIVE,
ACTIVE-NEGATIVE, ACTIVE-POSITIVE





Display:

PASSIVE/POSITIVE
PULSE TYPE



**6.10
PULSE
OUTPUT**
(Continued)

PULSE OUTPUT	
PULSE VALUE	<p>Define the flow quantity per output pulse. This is expressed in units per pulse (i.e. ft³ / pulse).</p> <p>Note: Ensure that the max. flowrate (full scale value) and the pulse value entered here agree with one another. The max. possible output frequency is 50Hz. The appropriate pulse value can be determined as follows:</p> $\text{Pulse value} > \frac{\text{estimated max. flowrate (full scale)}/\text{sec}}{\text{required max. output frequency}}$ <p>Input:  Number with floating decimal point: 0.001...10000.0</p> <p>Display: 1.000 ft³/P PULSE VALUE</p>
PULSE WIDTH	<p>Set the pulse width required for external devices. The pulse width limits the max. possible output frequency of the pulse output. For a certain output frequency, the max permissible pulse width can be calculated as follows:</p> $\text{Pulse width} < \frac{1}{2 \cdot \text{max. output frequency (Hz)}}$ <p>Input:  Number with floating decimal point: 0.01...9.999 s (seconds)</p> <p>Display: .01 s PULSE WIDTH</p>
SIMULATION FREQ.	<p>Frequency signals can be simulated in order to check any instrument that is connected to the pulse output. The simulated signals are always symmetrical (50/50 duty cycle).</p> <p>Note:</p> <ul style="list-style-type: none"> • The simulation mode selected affects the frequency output. The flow computer is fully operational during simulation. • Simulation mode is ended immediately after exiting this submenu. <p>Selection:  OFF, 0.0 Hz, 0.1 Hz, 1.0 Hz, 10 Hz, 50 Hz</p> <p>Display: OFF SIMULATION FREQ></p>

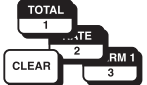

6.11
CURRENT
OUTPUT

CURRENT OUTPUT	
SELECT OUTPUT	<p>Select the current output to be configured. The flow computer offers two current outputs.</p> <p>Selection:</p> <p> 1 (Current output 1) 2 (Current output 2)</p> <p>Display: 1 SELECT OUTPUT</p>
ASSIGN CURRENT OUT	<p>Assign a variable to the current output.</p> <p>Selection:</p> <p> HEAT FLOW, MASS FLOW, COR. VOLUME FLOW, VOLUME FLOW, TEMPERATURE, TEMPERATURE 2, DELTA TEMPERATURE, PRESSURE, DENSITY, PEAK DEMAND, DEMAND LAST HOUR</p> <p>Display: VOLUME FLOW ASSIGN CURRENT OUT.</p>
CURRENT RANGE	<p>Define the 0 or 4 mA low scale current value. The current for the scaled full scale value is always 20 mA.</p> <p>Selection:</p> <p> 0-20 mA, 4-20 mA, NOT USED</p> <p>Display: 4-20 mA CURRENT RANGE</p>
LOW SCALE	<p>Set the low scale value to the 0 or 4 mA current signal for the variable assigned to the current output.</p> <p>Input:</p> <p> Number with floating decimal point: -999999...+999999</p> <p>Display: .000 ft³/h LOW SCALE VALUE</p>
FULL SCALE	<p>Set the full scale value to the 20 mA current signal for the variable assigned to the current output.</p> <p>Input:</p> <p> Number with floating decimal point: -999999...+999999</p> <p>Display: 1000.00 ft³/h FULL SCALE VALUE</p>





6.12 RELAYS

RELAYS	
SELECT RELAY	<p>Set relay output to be configured. Two or three relay outputs are available.</p> <p>Selection:</p>  <p>1 (Relay 1) 2 (Relay 2) 3 (Relay 3, optional)</p> <p>Display: 1 SELECT RELAY</p>
RELAY FUNCTION	<p>Both relays (1 and 2, and optional 3rd relay) can be assigned to various functions as required:</p> <p>Alarm functions Relays activate upon exceeding limit setpoints. Freely assignable to measured or calculated variables or totalizers.</p> <p>Malfunction Indication of instrument failure, power loss, etc.</p> <p>Pulse output The relays can be defined as additional pulse outputs for totalizer values such as heat, mass, volume or corrected volume.</p> <p>Wet steam alarm The flow computer can monitor pressure and temperature in superheated steam applications continuously and compare them to the saturated steam curve. When the degree of superheat (distance to the saturated steam curve) drops below 5 °C, the relay switches and the message "WET STEAM ALARM" is displayed.</p> <p>NOTE: Relay response time is affected by the value entered for display damping. The larger the display damping value, the slower the relay response time will be. This is intended to prevent false triggering of the relays. Enter a display damping factor of zero (0) for fastest relay response time.</p> <p>Selection: Different selections are available depending on the flow equation and type of transmitter selected.</p>  <p>HEAT TOTAL, MASS TOTAL, CORRECTED VOL. TOTAL, ACTUAL VOLUME TOTAL, HEAT FLOW, MASS FLOW, COR. VOL. FLOW, VOLUME FLOW, TEMPERATURE, TEMPERATURE 2, DELTA TEMPERATURE, PRESSURE, DENSITY, WET STEAM ALARM, MALFUNCTION, PEAK DEMAND, DEMAND LAST HOUR</p> <p>Display: VOLUME FLOW RELAY FUNCTION</p>

6.12
RELAYS
(Continued)

RELAYS	
PULSE VALUE	<p>Define the flow quantity per output pulse if the relay is configured for "RELAY PULSE OUTPUT".. This is expressed in units per pulse (i.e. ft³ / pulse).</p> <p>Note: Ensure that the max. flowrate (full scale value) and the pulse value entered here agree with one another. The max. possible output frequency is 5Hz. The appropriate pulse value can be determined as follows:</p> $\text{Pulse value} > \frac{\text{estimated max. flowrate (full scale)/sec}}{\text{required max. output frequency}}$ <p>Input:</p>  Number with floating decimal point: 0.001...1000.0
	<p>Display: 1.000 ft³/P PULSE VALUE</p>
PULSE WIDTH	<p>Enter the pulse width. Two cases are possible:</p> <p>Case A: Relay set for "MALFUNCTION" or limit value The response of the relay during alarm status is determined by selecting the pulse width.</p> <ul style="list-style-type: none"> • Pulse width = 0.0 s (Normal setting) Relay is latched during alarm conditions. • Pulse width = 0.1...9.9 s (special setting) Relay will energize for selected duration, independent of the cause of the alarm. This setting is only used in special cases (i.e. for activating signal horns). <p>Case B: Relay set for "RELAY PULSE OUTPUT" Set the pulse width required for the external device. The value entered here can be made to agree with the actual flow amount and pulse value by using the following:</p> $\text{Pulse width} < \frac{1}{2 \cdot \text{max. output frequency (Hz)}}$ <p>Input:</p>  Number with floating decimal point: 0.01...9.99 s (pulse output) 0.00...9.99 s (all other configurations)
	<p>Display: .01 s PULSE WIDTH</p>

6.13
COMMUNICATION
 (Continued)

COMMUNICATION	
RS-232 USAGE	<p>The flow computer can be connected via RS-232 interface to a personal computer or printer.</p> <p>Selection:</p> <p> COMPUTER, PRINTER, MODEM</p> <p>Display: COMPUTER RS-232 USAGE</p>
DEVICE ID	<p>Enter the unique unit I.D. tag number for the flow computer if a number of flow computers are connected to the same interface.</p> <p>Selection:</p> <p> Max. 2 digit number: 0...99</p> <p>Display: 1 DEVICE ID</p>
BAUD RATE	<p>Enter the baud rate for serial communication between the flow computer and a personal computer, modem, or printer.</p> <p>Selection:</p> <p> 9600, 2400, 1200, 300</p> <p>Display: 9600 BAUD RATE</p>
PARITY	<p>Select the desired parity. The setting selected here must agree with the parity setting for the computer, modem, or printer.</p> <p>Selection:</p> <p> NONE, ODD, EVEN</p> <p>Display: NONE PARITY</p>
HANDSHAKE	<p>The control of data flow can be defined. The setting required is determined by the handshaking of the printer.</p> <p>Selection:</p> <p> NONE, HARDWARE</p> <p>Display: NONE HANDSHAKE</p>

6.13
COMMUNICATION
 (Continued)

COMMUNICATION

PRINT LIST

Select the variables or parameters which are to be logged or printed via the RS-232 interface.

Selection (Procedure):



CHANGE? NO
 CHANGE? YES

If YES selected, the available variables are displayed one after another. Only some of the following options are available depending on the flow equation selected:



Store option
 advance to next



Print?







- | | |
|----------------------|---------|
| PRINT HEADER? | NO(YES) |
| INSTRUMENT TAG? | NO(YES) |
| FLUID TYPE? | NO(YES) |
| TIME? | NO(YES) |
| DATE? | NO(YES) |
| TRANSACTION NO.? | NO(YES) |
| HEAT FLOW? | NO(YES) |
| HEAT TOTAL? | NO(YES) |
| HEAT GRAND TOTAL? | NO(YES) |
| MASS FLOW? | NO(YES) |
| MASS TOTAL? | NO(YES) |
| MASS GRAND TOTAL? | NO(YES) |
| COR. VOLUME FLOW? | NO(YES) |
| COR.VOL.GRAND TOTAL? | NO(YES) |
| VOLUME FLOW? | NO(YES) |
| VOLUME TOTAL? | NO(YES) |
| VOL. GRAND TOTAL? | NO(YES) |
| TEMPERATURE? | NO(YES) |
| TEMPERATURE 2? | NO(YES) |
| DELTA TEMPERATURE? | NO(YES) |
| PROCESS PRESSURE? | NO(YES) |
| DENSITY? | NO(YES) |
| SPEC. ENTHALPY? | NO(YES) |
| DIFF. PRESSURE? | NO(YES) |
| ERRORS? | NO(YES) |
| ALARMS? | NO(YES) |
| PEAK DEMAND? | NO(YES) |
| DEMAND LAST HOUR? | NO(YES) |
| PEAK TIME STAMP? | NO(YES) |
| PEAK DATE STAMP? | NO(YES) |
| TRAP MONITOR? | NO(YES) |

"YES" + ENTER: Parameter is added to the print list











"NO" + ENTER: parameter is not printed

After the last option the display advances to the next submenu.







6.13
COMMUNICATION
 (Continued)

COMMUNICATION	
PRINT INITIATE	<p>Datalogger and/or printing variables and parameters over the serial RS-232 interface can be initiated at regular intervals (INTERVAL) or daily at a fixed time (TIME OF DAY) or by front key depression.</p> <p>Note: Printing can always be initiated by pressing the PRINT key.</p> <p>Selection:</p> <p> NONE, TIME OF DAY, INTERVAL, ENABLE PRINT KEY</p> <p>Display: TIME OF DAY PRINT INITIATE</p>
DATALOG ONLY	<p>Select YES or NO for Datalog Only prompt.</p> <p>Selection:</p> <p> YES - Data is logged but no information is sent on print event.  NO - Data is logged and immediately transmitted.</p> <p>Display: YES DATALOG ONLY</p>
PRINT INTERVAL	<p>Define a time interval. Variables and parameters will be periodically logged at regular intervals of this value of time. The setting "00:00" deactivates this feature.</p> <p>Input:</p> <p> Time value in hours & minutes (HH:MM).</p> <p>Display: 00:00 PRINT INTERVAL</p>
PRINT TIME	<p>Define the time of day that variables and parameters will be logged out daily.</p> <p>Input:</p> <p> Time of day in hours & minutes (HH:MM).</p> <p>Display: 00:00 PRINT TIME</p>
DATALOG FORMAT	<p>Define the Datalog Format.</p> <p>Selection:</p> <p> DATABASE - Data sets sent in comma seperated variable format.  PRINTER - Individual output variables sent with text label and units suitable for printing.</p> <p>Display: PRINTER DATALOG FORMAT</p>

6.13
COMMUNICATION
(Continued)

COMMUNICATION	
SEND INC. TOT. ONLY	<p>Select YES or NO for Send Inc. Tot. Only</p> <p>Selection:</p> <p> YES - Unit will send Inc. Tot. Only  NO - Unit will not send Inc. Tot. Only</p> <p>Display: YES SEND INC. TOT. ONLY</p>
INC ONLY SCALER	<p>Enter multiplying factor for Inc Only Scaler</p> <p>Selection:</p> <p> X1, X10, X100, X1000 </p> <p>Display: X1 INC ONLY SCALER</p>
CLEAR DATALOG	<p>Select YES or NO for Clear Datalog</p> <p>Selection:</p> <p> YES - Unit will clear datalog contents  NO - Unit will not clear datalog contents</p> <p>Display: YES CLEAR DATALOG</p>
MODEM CONTROL (Modem)	<p>Select YES or NO for Modem Control.</p> <p>Selection:</p> <p> YES - Modem initialization and dialing commands are sent during transactions.  NO - Modem initialization and dialing commands are NOT sent during transactions.</p> <p>Display: YES MODEM CONTROL</p>
DEVICE MASTER (Modem)	<p>Select YES or NO for Device Master</p> <p>Selection:</p> <p> YES - Sets sole master device responsible for initializing modem.  NO - Device will not be used to initialize modem.</p> <p>Display: YES DEVICE MASTER</p>

6.13
COMMUNICATION
 (Continued)

COMMUNICATION	
MODEM AUTO ANSWER (Modem)	<p>Select YES or NO for Modem Auto Answer</p> <p>Selection:</p> <p> YES - Modem will answer incoming calls.  NO - Modem will not answer incoming calls.</p> <p>Display: YES MODEM AUTO ANSWER</p>
CALL OUT NO (Modem)	<p>Define a Call Out Number. Enter the telephone number, or email address to be called.</p> <p>Input:</p> <p> max. 16 digit phone number</p> <p>Display: ### ## ## ## #### CALL OUT NO</p>
CALL OUT TIME (Modem)	<p>Define the Call Out Time. Enter scheduled call out time (24 hr format), if you want the unit to call out to a remote PC.</p> <p>Input:</p> <p> Time of day in hours & minutes (HH:MM).</p> <p>Display: 00:00 CALL OUT TIME</p>
CALL ON ERROR (Modem)	<p>Select YES or NO for Call On Error prompt.</p> <p>Selection:</p> <p> YES - Unit will call out to remote PC if a designated CSI error occurs.  NO - Unit will not call out to remote PC if error occurs.</p> <p>Display: YES CALL ON ERROR</p>
NUMBER OF REDIALS (Modem)	<p>Enter the Number Of Redials desired in the event of a busy signal or communication problem.</p> <p>Input:</p> <p> max. 2 digit number</p> <p>Display: 3 NUMBER OF REDIALS</p>

6.13
COMMUNICATION
 (Continued)

COMMUNICATION

HANG UP IF INACTIVE
(Modem)

Select YES or NO for Hang Up If Inactive

Selection:



- YES - Unit will hang up if remote PC fails to respond within several minutes after connection is established.
- NO - Unit will not hang up if remote PC fails to respond after connection is established.

Display:

YES
 HANG UP IF INACTIVE

6.13
COMMUNICATION
 (Continued)

COMMUNICATION

ERROR MASK
(Modem)

Select YES or NO for Change Error Mask? prompt

Selection:



Display:

00:00
 CALL OUT TIME

If YES selected, define the conditions that you wish to call out on. The possible conditions are displayed one after another.



Store option
 advance to next



Change?

POWER FAILURE	NO(YES)
WATCHDOG TIMEOUT	NO(YES)
COMMUNICATION ERROR	NO(YES)
CALIBRATION ERROR	NO(YES)
PRINT BUFFER FULL	NO(YES)
TOTALIZER ERROR	NO(YES)
WET STEAM ALARM	NO(YES)
OFF FLUID TABLE	NO(YES)
FLOW IN OVERRANGE	NO(YES)
INPUT1 OVERRANGE	NO(YES)
INPUT2 OVERRANGE	NO(YES)
FLOW LOOP BROKEN	NO(YES)
LOOP1 BROKEN	NO(YES)
LOOP2 BROKEN	NO(YES)
RTD 1 OPEN	NO(YES)
RTD 1 SHORT	NO(YES)
RTD 2 OPEN	NO(YES)
RTD 2 SHORT	NO(YES)
PULSE OUT OVERRUN	NO(YES)
lout 1 OUT OF RANGE	NO(YES)
lout 2 OUT OF RANGE	NO(YES)
RELAY 1 HIGH ALARM	NO(YES)
RELAY 1 LOW ALARM	NO(YES)
RELAY 2 HIGH ALARM	NO(YES)
RELAY 2 LOW ALARM	NO(YES)
RELAY 3 HIGH ALARM	NO(YES)
RELAY 3 LOW ALARM	NO(YES)
TRAP ERROR	NO(YES)
TRAP BLOWING	NO(YES)
INPUT 3 OVERRANGE	NO(YES)
INPUT 3 BROKEN	NO(YES)
24VDC OUT ERROR	NO(YES)
PULSE IN ERROR	NO(YES)
INPUT 1 Vin ERROR	NO(YES)
INPUT 1 Iin ERROR	NO(YES)
INPUT 2 Iin ERROR	NO(YES)
INPUT 2 RTD ERROR	NO(YES)
INPUT 3 Iin ERROR	NO(YES)
INPUT 3 RTD ERROR	NO(YES)
PULSE OUT ERROR	NO(YES)
lout 1 ERROR	NO(YES)
lout 2 ERROR	NO(YES)
RELAY 1 ERROR	NO(YES)
RELAY 2 ERROR	NO(YES)
RS-232 ERROR	NO(YES)
A/D MALFUNCTION	NO(YES)
PROGRAM ERROR	NO(YES)
SETUP DATA LOST	NO(YES)
TIME CLOCK LOST	NO(YES)
DISPLAY MALFUNCTION	NO(YES)
RAM MALFUNCTION	NO(YES)
DATALOG LOST	NO(YES)

6.15
SERVICE &
ANALYSIS

SERVICE & ANALYSIS

EXAMINE AUDIT TRAIL

Two counters contain the number of times the calibration and/or configuration parameters have been changed. Changes in important calibration and configuration data are registered and displayed ("electronic stamping"). These counters advance automatically. These counters cannot be reset so that unauthorized changes can be identified.

Example:

CAL 015 CFG 076

Display: CAL 015 CFG 076
EXAMINE AUDIT TRAIL

ERROR LOG

A list of errors that have occurred can be viewed and cleared.

Selection:



VIEW? NO
VIEW? YES

If "YES" is selected the error log can be viewed and errors individually cleared (if editing enabled with Service Code).

Display: CLEAR? NO
POWER FAILURE

SOFTWARE VERSION

Display the software version of the flow computer. (Contact local agent for upgrade information)

Example:

02.00.14

Display: 02.00.14
SOFTWARE VERSION

HARDWARE VERSION

Display the hardware version of the flow computer. (Contact local agent for upgrade information)

Example:

01.00.01

Display: 01.00.01
HARDWARE VERSION

7. Principle Of Operation

General Operation

7.1 General:

The SUPERtrol II Flow Computer uses several internal calculations to compute the compensated flow based on specific data input. Several computations are performed to arrive at the uncompensated flow, temperature, pressure, density and viscosity. This information is then used to compute the Corrected Volume Flow, Mass Flow or Heat Flow.

Square Law Flowmeter Considerations

7.2 Square Law Flowmeter Considerations:

Head class flowmeters are supplied by the manufacturers with a 4-20 mA output span which is already in flow units. The SUPERtrol II permits the user to enter this flowmeter information directly. However, closely associated with this information is the density that was assumed during flowmeter calibration. This information must also be input if the user is to obtain maximum accuracy.

It is assumed that the user has the printout from a standardized sizing program for the particular device he will be using. Such standardized printouts list all the necessary information which the user will then be prompted for.

Several specialized flow equations are listed that are not intended for the standard unit but to be offered to appropriate OEMs or as special order items. These are designated by a “†”.

Note concerning Fluid Information

The user will be prompted for Fluid Information during the setup of the instrument. See Appendix A for the properties of several common fluids.

Flow Equations

7.3 Flow Equations:

7.3.1 Flow Input Computation

Flow Input Computation:

Linear

$$\text{Input Flow} = [\% \text{ input span} \cdot (\text{flow FS} - \text{flow low scale})] + \text{flow low scale}$$

Square Law without External SQRT Extractor

$$\text{delta P} = [(\% \text{ input span}) \cdot (\text{flow FS} - \text{flow low scale})] + \text{flow low scale}$$

Square Law with External SQRT Extractor

$$\text{delta P} = [(\% \text{ input span})^2 \cdot (\text{flow FS} - \text{flow low scale})] + \text{flow low scale}$$

NOTE: For stacked differential pressure option, the appropriate input sensor signal is used in calculations at all times to maximize accuracy.

7.3.2 Pressure Computation

Pressure Input:

General Case

$$P_f = [\% \text{ input span} \cdot (\text{Pres full scale} - \text{Pres low scale})] + \text{Pres low scale}$$

Gauge Case

$$P_f = P_f + \text{Barometric}$$

Manual Case or In Event of Fault

$$P_f = \text{Pressure Default Value}$$

7.3.3 Temperature Computation

Temperature Computation:

General Case

$$T_f = [\% \text{ input span} \cdot (\text{Temp full scale} - \text{Temp low scale})] + \text{Temp low scale}$$

RTD Case

$$T_f = f(\text{measured input resistance})$$

Manual Case or In Event of Fault

$$T_f = \text{Temperature Default Value}$$

Delta Temp Case

$$\text{Delta Temp} = T_2 - T_1 \quad \text{Flowmeter location} = \text{cold}$$

$$\text{Delta Temp} = T_1 - T_2 \quad \text{Flowmeter location} = \text{hot}$$

7.3.4 Density/Viscosity Computation

Density Computation:

Water Case

$$\text{density_water} = \text{density}(T_f)$$

Liquid Case

$$\text{density} = \text{reference density} \cdot (1 - \text{Therm.Exp.Coef} \cdot (T_f - T_{ref}))^2$$

Steam Case

$$\text{density} = 1 / \text{specific volume}(T_f, P_f)$$

Gas Case

$$\text{density} = \text{reference density} \cdot \frac{P_f}{P_{ref}} \cdot \frac{(T_{ref} + 273.15)}{(T_f + 273.15)} \cdot \frac{Z_{ref}}{Z_f}$$

NOTE: For Natural Gas:

$\frac{Z_{ref}}{Z_f}$ is determined by NX-19 when this selection is supplied and selected.

NOTE: Therm.Exp.Coef is ($\times 10^{-6}$)

7.3.4
Density/Viscosity
Computation
 (continued)

Viscosity (cP) Computation:

Liquid Case

$$\text{cP viscosity} = A \cdot \exp \frac{B}{(T_f + 459.67)}$$

NOTE:

$$\text{Viscosity cS} = \frac{\text{viscosity (in cP)}}{\left(\frac{\text{flowing density}}{\text{density of water @ 4°C}} \right)}$$

Gas Case

$$\text{cP viscosity} = A \cdot (T_f + 459.67)^B$$

Steam Case

$$\text{cP viscosity} = f(T_f, P_f)$$

7.3.5
Corrected
Volume Flow
Computation

Corrected Volume Flow Computation:

Liquid Case

$$\text{std. volume flow} = \text{volume flow} \cdot (1 - \text{Therm.Exp.Coef.} \cdot (T_f - T_{\text{ref}}))^2$$

Gas Case

$$\text{std. volume flow} = \text{volume flow} \cdot \frac{P_f}{P_{\text{ref}}} \cdot \frac{(T_{\text{ref}} + 273.15)}{(T_f + 273.15)} \cdot \frac{Z_{\text{ref}}}{Z_f}$$

NOTE: For Natural Gas:

$$\frac{Z_{\text{ref}}}{Z_f} \quad \text{is determined by NX-19 when this selection is supplied and selected.}$$

Natural Gas NX-19 Equation: The NX-19 (1963) natural gas state equations are widely used in custody transfer applications. Over most normal measurement ranges, 500 to 5000 psia (3.5 to 10.4 MPa) and -10 to 100°F (-23 to 38°C), the NX-19 equation will compute the gas compressibility factor to within 0.2% of the values computed by the newer AGA-8 state equation.

The ranges over which the NX-19 equation applies are:

Pressure P_G	To 5000 psig (10.34 MPa gauge)
Temperature T_f	-40 to 240°F (-40 to 116°C)
Specific Gravity G	0.554 to 1.0
CO ₂ and N ₂	0 to 15%

Our Flow Computer uses the Specific Gravity method to first obtain the adjusted temperature and pressure before entering the state equation. This method calculates the adjusted pressure and temperature from the mole fractions of carbon dioxide and nitrogen as

$$P_{\text{adj}} = \frac{156.47 P_G}{160.8 - 7.22 G_g + 100X_{\text{CO}_2} - 39.2X_{\text{N}_2}} \quad \text{psig}$$

Where X_{CO_2} and X_{N_2} are the mole fractions of carbon dioxide and nitrogen, respectively. The adjusted temperature is defined by

$$T_{\text{adj}} = \frac{226.29 (T_f + 460)}{99.15 + 211.9 G_g - 100X_{\text{CO}_2} - 168.1X_{\text{N}_2}} \quad \text{°F}$$

**7.3.5
Corrected
Volume Flow
Computation
(continued)**

After calculating the adjusted pressure and temperature, the mixture's pressure and temperature *correlations parameters* are calculated by

$$P = \frac{P_{adj} + 14.7}{1000} \qquad T = \frac{T_{adj}}{500}$$

The compressibility factor is then calculated by first determining

$$\begin{aligned} m &= 0.0330378T^{-2} - 0.0221323T^{-3} + 0.0161353T^{-5} \\ n &= (0.265827T^{-2} + 0.0457697T^{-4} - 0.133185T^{-1})m^{-1} \\ B &= \frac{3 - mn^2}{9mp^2} \\ b &= \frac{9n - 2mn^3}{54mp^2} - \frac{E}{2mp^2} \\ D &= [b + (b^2 + B^3)^{0.5}]^{1/3} \end{aligned}$$

Where *E* is a function of the pressure *p* and temperature *T* correlation parameters. The equations for *E* are given in the following table for the designated regions. The following compressibility *Z_f* is determined by

$$Z_f = \frac{1}{B/D - D + n/3p}$$

NX-19 Natural Gas Regions and *E* Equations

Ranges		<i>E</i>
<i>P</i>	<i>T</i>	
0 to 2	1.09 to 1.40	<i>E</i> ₁
0 to 1.3	0.84 to 1.09	<i>E</i> ₂
1.3 to 2.0	0.88 to 1.09	<i>E</i> ₃
1.3 to 2.0	0.84 to 0.88	<i>E</i> ₄
2.0 to 5.0	0.84 to 0.88	<i>E</i> ₅
2.0 to 5.0	0.88 to 1.09	<i>E</i> ₆
2.0 to 5.0	1.09 to 1.32	<i>E</i> ₇
2.0 to 5.0	1.32 to 1.40	<i>E</i> ₈

$$\begin{aligned} T_a &= T - 1.09 & T_b &= 1.09 - T \\ E_1 &= 1 - 0.00075p^{2.3} \exp(-20T_a) - 0.0011T_a^{0.5}p^2(2.17 + 1.4T_a^{0.5} - p) \\ E_2 &= 1 - 0.00075p^{2.3} [2 - \exp(-20T_b)] - 1.317T_b^4p(1.69 - p^2) \\ E_3 &= 1 - 0.00075p^{2.3} [2 - \exp(-20T_b)] + 0.455(200T_b^6 - 0.03249T_b \\ &\quad + 2.0167T_b^2 - 18.028T_b^3 + 42.844T_b^4)(p - 1.3)[1.69(2)^{1.25} - p^2] \\ E_4 &= 1 - 0.00075p^{2.3} [2 - \exp(-20T_b)] + 0.455(200T_b^6 - 0.03249T_b \\ &\quad + 2.0167T_b^2 - 18.028T_b^3 + 42.844T_b^4)(p - 1.3)[1.69(2)^{1.25 + 80(0.88 - 1)^2} - p^2] \\ E_5 &= E_4 - X & E_6 &= E_3 - X & E_7 &= E_1 - X & E_8 &= E_7 - X_1 \\ X &= A(T - 2) + A_1(p - 2)^2 + A_2(p - 2)^3 + A_3(p - 2)^4 \\ X_1 &= (p - 1.32)^2(p - 2)[3 - 1.483(p - 2) - 0.1(p - 2)^2 + 0.0833(p - 2)^3] \\ A &= 1.7172 - 2.33123T - 1.56796T^2 + 3.47644T^3 - 1.28603T^4 \\ A_1 &= 0.016299 - 0.028094T - 0.48782T^2 - 0.78221T^3 + 0.27839T^4 \\ A_2 &= -0.35978 + 0.51419T + 0.165453T^2 - 0.52216T^3 + 0.19687T^4 \\ A_3 &= 0.075255 - 0.10573T - 0.058598T^2 + 0.14416T^3 - 0.054533T^4 \end{aligned}$$

When NX-19 is used for custody transfer applications, the base compressibility factor is calculated by:

$$Z_b = \left(1 + \frac{0.00132}{T^{3.25}} \right)^{-2}$$

**7.3.6
Mass Flow
Computation**

Mass Flow Computations:

$$\text{mass flow} = \text{volume flow} \cdot \text{density}$$

**7.3.7
Comb. Heat Flow
Computation**

Combustion Heat Flow Computations:

$$\text{combustion heat flow} = \text{mass flow} \cdot \text{combustion heating value}$$

7.3.8 Heat Flow Computation

Heat Flow Computation:

Steam Heat

$$\text{heat flow} = \text{mass flow} \cdot \text{total heat steam}(T_f, P_f)$$

Steam Net Heat

$$\text{heat flow} = \text{mass flow} \cdot [\text{total heat steam}(T_f, P_f) - \text{heat saturated water}(P_f)]$$

Steam Delta Heat

$$\text{heat flow} = \text{mass flow} \cdot [\text{total heat saturated steam}(P_f) - \text{heat water}(T_f)]$$

7.3.9 Sensible Heat Flow Computation

Sensible Heat Flow:

Special Case for Water

$$\text{heat flow} = \text{mass flow}(T_f) \cdot \text{enthalpy}(T_f)$$

7.3.10 Liquid Delta Heat Computation

Liquid Delta Heat:

General Case

$$\text{heat flow} = \text{mass flow} \cdot \text{specific heat} \cdot (T_2 - T_f)$$

Water Case

$$\text{heat flow} = \text{mass flow}(T_f) \cdot [\text{enthalpy}(T_2) - \text{enthalpy}(T_f)]$$

7.3.11 Expansion Factor Computation for Square Law Flow- meters

Expansion Factor Computation for Square Law Flowmeters:

In the following Equations, delta P is assumed in ("H₂O), Pf is in PSIA, 27.7 is a PSIA to ("H₂O) units conversion.

Liquid Case

$$Y = 1.0$$

Gas, Steam Case

Orifice Case

$$Y = 1.0 - (0.41 + 0.35 \cdot B^4) \cdot \frac{\text{delta P}}{\text{isentropic exponent} \cdot P_f \cdot 27.7}$$

Venturi, Flow Nozzle, Wedge Case:

$$R = 1 - \frac{\Delta p}{27.7 \cdot p_f}$$

$$Y = \sqrt{\frac{(1 - \beta^4) \cdot \frac{\kappa}{\kappa - 1} \cdot R^{2/\kappa} \cdot (1 - R^{(\kappa-1)/\kappa})}{[(1 - (\beta^4 \cdot R^{2/\kappa})) \cdot (1 - R)]}}$$

7.3.11
Expansion Factor
Computation for
Square Law
Flowmeters
 (Continued)

V-Cone Case

NOTE: $Y=1$ for noncompressible fluids (e.g. water, oil etc.).

$$Y = 1 - (0.649 + 0.696\beta^4) \frac{\Delta P / 27.7}{k \cdot P}$$

Note that ΔP and P can be in any units as long as they are the same.

Verabar Case

$$Y_v = 1 + (18093 - .4191(1 - \beta)^2) \cdot \left(\frac{h_w}{27.73 \cdot P_{fa} \cdot \Gamma} \right)$$

Where:

$$\beta = \text{The sensor blockage} = \frac{4 \cdot P_w}{\pi \cdot D}$$

$$\pi = 3.14159$$

D = Internal pipe diameter in inches.

P_w = The sensor's probe width in inches.

$$P_w = 0.336'' \text{ for a } -05 \text{ sensor.}$$

$$P_w = 0.614'' \text{ for a } -10 \text{ sensor.}$$

$$P_w = 1.043'' \text{ for a } -15 \text{ sensor.}$$

h_w = Verabar differential pressure in inches of H₂O.

P_{fa} = Absolute static pressure (high side of the Verabar) in psia.

$\Gamma = k$ = Isentropic exponent for a real gas or steam.

7.3.11
Expansion Factor
Computation for
Square Law
Flowmeters
 (Continued)

Accelabar Case

For 1 inch Accelabar Body

$$Y_a = .9824 - .5890 \cdot \left(\frac{h_w}{27.73 \cdot P_{fta} \cdot \gamma} \right)$$

For 2 inch Accelabar Body

$$Y_a = .9730 - \left(.5850 \cdot \left(\frac{h_w}{27.73 \cdot P_{fta} \cdot \gamma} \right) \right)$$

Where:

- Y_a = Accelabar gas expansion factor (dimensionless)
 h_w = Differential pressure (inches H₂O @ 68°F)
 P_{fta} = Flowing Pressure in Accelabar Throat (psia)
 = Flowing pressure in psig + atmospheric pressure in psi
 γ = Isentropic Exponent for a real gas

For 3 inch to 12 inch Accelabar Body

$$Y_a = 1 - Y_{a-coef} \cdot \left(\frac{h_w}{27.73 \cdot P_{fta} \cdot \Gamma} \right)$$

Where:

- Y_a = General Accelabar gas expansion factor (dimensionless)
 Y_{a-coef} = Accelabar gas expansion factor coefficient (dimensionless)
 h_w = Differential pressure (inches H₂O @ 68°F)
 P_{fta} = Flowing Accelerator Throat Pressure (psia)
 = Flowing throat pressure in psig + atmospheric pressure in psi
 Γ = Isentropic Exponent for a real gas or steam

Accelabar Size	Y_{a-coef}
3"	0.7432
4"	0.6986
6"	0.6865
8"	0.6407
10"	0.6095
12"	0.5891

7.3.12 Uncompensated Flow Computation

Uncompensated Flow Computation:

Pulse, Linear Case

$$\text{volume flow} = \frac{\text{input frequency} \cdot \text{Time Scaling Factor}}{\text{K-Factor} \cdot [1 - \text{Meter Exp.Coeff.} \cdot (T_f - T_{cal})]}$$

Analog, Linear Case

$$\text{volume flow} = \frac{\text{Measured Input Flow}}{[1 - \text{Meter Exp.Coeff.} \cdot (T_f - T_{cal})]}$$

Square Law Case

$$\text{volume flow} = \frac{\text{DP Factor}}{[1 - \text{Meter Exp.Coeff.} \cdot (T_f - T_{cal})]} \cdot Y \cdot \left[\frac{2 \cdot \Delta P}{\text{density}} \right]^{1/2}$$

Square Law, Target Flowmeter Case

$$\text{volume flow} = \text{input flow} \cdot \frac{\sqrt{\text{density cal.}}}{\sqrt{\text{density flowing}}}$$

Pulse, Linearization Case

$$\text{volume flow} = \frac{\text{input frequency} \cdot \text{Time Scaling Factor}}{\text{K-Factor(Hz)} \cdot [1 - \text{Meter Exp.Coeff.} \cdot (T_f - T_{cal})]}$$

Analog, Linearization Case

$$\text{volume flow} = \frac{\text{Input Flow} \cdot \text{Correction Factor (Input Flow)}}{[1 - \text{Meter Exp.Coeff.} \cdot (T_f - T_{cal})]}$$

Square Law, Linearization Case

$$\text{volume flow} = \frac{\text{DP Factor(RN)}}{[1 - \text{Meter Exp.Coeff.} \cdot (T_f - T_{cal})]} \cdot Y \cdot \left[\frac{2 \cdot \Delta P}{\text{density}} \right]^{1/2}$$

Pulse, UVC Case

$$\text{volume flow} = \frac{\text{input frequency} \cdot \text{Time Scaling Factor}}{\text{K-Factor (Hz/cstks)} \cdot [1 - \text{Meter Exp.Coeff.} \cdot (T_f - T_{cal})]}$$

Shunt Flow Bypass Flowmeter

$$\text{volume flow} = \frac{\text{input frequency} \cdot 457 \cdot E_{pa} \cdot Y_m}{\sqrt{\text{flowing density}} \cdot \text{DC} \cdot \text{bypass calibration factor}}$$

Gilflo Flowmeter

$$\text{volume flow at flowing conditions} = \text{input flow at design conditions} \cdot \sqrt{\frac{\text{calibration density}}{\text{flowing density}}}$$

NOTE: Therm.Exp.Coef is 10^{-6}

7.3.13 ILVA Flow Meter Equations

ILVA Flowmeter - This meter type requires an initial linearization using the linearization table. In addition, the following specialized corrections are required.

For Gas/Steam Expansion (imperial) $Y = 1 - (115.814 \cdot (dp / p) \cdot 0.0001)$

Where: Y = gas expansion correction (NOTE: Y=1 for liquid)
dp = differential pressure - inches water gauge
p = upstream pressure - psia

For Reynolds Number (volumetric calculations for Gas/Steam)

$Cre = (1 - (n / Qn))^{-1}$
to a maximum value of m

Where: Cre = Reynolds number correction (NOTE Cre = 1 for liquid)
Qn = nominal water volumetric flowrate (column 6)
m = (see table below)
n = (see table below)

Meter Size	n	m
DN50	2.53	1.200
DN80	0.64	1.125
DN100	0.21	1.100
DN150	0.13	1.067
DN200	0.07	1.050
DN250	0	1
DN300	0	1

The final gas expansion and Reynolds number correction is: $Qc = Qn \cdot Y \cdot Cre$

For Volumetric Calculations: (calculate the density corrected volumetric flowrate):

$Qd = Qc \cdot (Dn / Da)^{0.5}$

Where: Qd = density corrected volumetric flowrate
Qc = nominal water volumetric flowrate (column 6) corrected for Reynolds Number and gas expansion effects.
Da = actual flowing density of working fluid
Dn = nominal density of water at reference conditions

Once corrected for density a further correction is required to take into account the effect of temperature on the ILVA primary element.

Temperature Compensation

For Volumetric Calculations: Using the value of Qd derived above, the temperature corrected flowrate can be calculated: $Qa = ((Ta - Tref) \cdot 0.000189 \cdot Qd) + Qd$

Where: Qa = actual volumetric flowrate
Qd = density corrected volumetric flowrate (from above)
Tref = reference temperature in °C (generally 20°C)
Ta = actual flowing temperature of working fluid (in °C)

It is possible to convert from a mass flowrate to a volumetric flowrate and vice versa using the following simple formula: $Ma = Qn \cdot Da$

Where: Da = actual flowing density of working fluid

7.4 Computation of the DP Factor

It is assumed that the user has the printout from a standardized sizing program for the particular device he will be using. Such standardized printouts list all the necessary information which the user will then be prompted for by the instrument or diskette.

It is also important that the user select the flow equation to be used and either select or enter the following items:

Flowmeter Type
 The fluid type or the fluid properties applicable to the fluid to be measured
 Beta, Meter Exp. Coeff., Inlet Pipe Bore
 Reference Conditions of temperature, pressure, Z and calibration temperature

The user is prompted for the following:

mass flow or volume flow or corrected volume flow as indicated by the flow equation
 Differential Pressure
 Inlet Pressure
 Temperature
 Density
 Isentropic Exponent

The unit then computes the following results corresponding to the user entry conditions and appropriate methods:

Y

Finally the DP Factor is computed as follows:

Steam Case

$$\text{DP Factor} = \frac{\text{mass flow} \cdot [1 - \text{Meter Exp.Coeff.} \cdot (T_f - T_{cal})]}{Y \cdot [2 \cdot \text{delta P} \cdot \text{density}]^{1/2}}$$

Liquid Case

$$\text{DP Factor} = \frac{\text{volume} \cdot [1 - \text{Meter Exp.Coeff.} \cdot (T_f - T_{cal})]}{\left[\frac{2 \cdot \text{delta P}}{\text{density}} \right]^{1/2}}$$

Gas Case

$$\text{DP Factor} = \frac{\text{Std.Vol.Flow} \cdot \text{ref density} \cdot [1 - \text{Meter Exp.Coeff.} \cdot (T_f - T_{cal})]}{Y \cdot [2 \cdot \text{delta P} \cdot \text{density}]^{1/2}}$$

Application Hint:

The user may reenter this DP Factor multiple times to assist him in assembling the table points of DP Factor and Reynold's Number necessary to construct a 16 point table for the meter run.

NOTE: Meter Exp.Coeff is ($\times 10^{-6}$)

8. RS-232 Serial Port

8.1 RS-232 Port Description:

The SUPERtrol II has a general purpose RS-232 Port which may be used for any one of the following purposes:

Transaction Printing, Data Logging, Remote Metering by Modem (optional), Computer Communication Link, Configuration by Computer, Print System Setup, Print Calibration/Malfuction History

8.2 Instrument Setup by PC's over Serial Port

A Diskette program is provided with the SUPERtrol II that enables the user to rapidly configure the SUPERtrol II using a Personal Computer. Included on the diskette are common instrument applications which may be used as a starting point for your application. This permits the user to have an excellent starting point and helps speed the user through the instrument setup.

8.3 Operation of Serial Communication Port with Printers

SUPERtrol II's RS-232 channel supports a number of operating modes. One of these modes is intended to support operation with a printer in metering applications requiring transaction printing, data logging and/or printing of calibration and maintenance reports.

For transaction printing, the user defines the items to be included in the printed document. The user can also select what initiates the transaction print generated as part of the setup of the instrument. The transaction document may be initiated via a front panel key depression.

In data logging, the user defines the items to be included in each data log as a print list. The user can also select when or how often he wishes a data log to be made. This is done during the setup of the instrument as either a time of day or as a time interval between logging.

The system setup and maintenance report list all the instrument setup parameters and usage for the current instrument configuration. In addition, the Audit trail information is presented as well as a status report listing any observed malfunctions which have not been corrected.

The user initiates the printing of this report at a designated point in the menu by pressing the print key on the front panel.

8.4 SUPERtrol II RS-232 Port Pinout

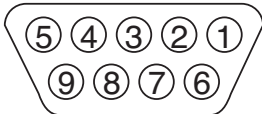

- 1 Handshake Line (cd in)
- 2 Transmit (tx)
- 3 Receive (rx)
- 4 Do Not Use
- 5 Ground
- 6 Do Not Use
- 7 RTS out
- 8 Do Not Use or Ground for Modem Power Option
- 9 Do Not Use or 8VDC Out for Modem Power Option

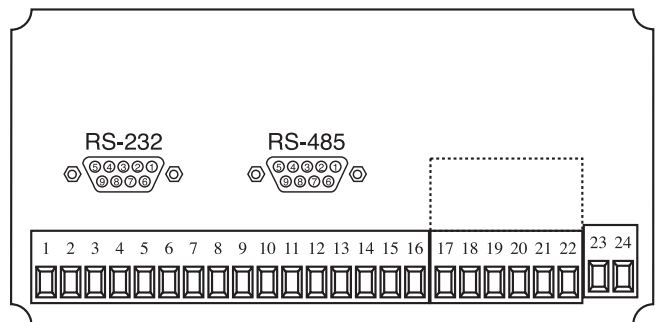

9. RS-485 Serial Port (optional)

9.1 RS-485 Port Description:

The SUPERtrol II has a an optional general purpose RS-485 Port which may be used for any one of the following purposes:

Accessing Process Parameters

Rate, Temperatures, Pressures, Density, Time & Date, Setpoints, etc.

Accessing System Alarms

System, Process, Self Test, Service Test Errors

Accessing Totalizers

Heat, Mass, Corrected Volume, Volume Totalizers and Grand Totalizers

Executing Various Action Routines

Reset Alarms, Reset Totalizers, Print Transaction, Reset Error History,

9.2 General

The optional RS-485 card utilizes Modbus RTU protocol to access a variety of process parameters and totalizers. In addition, action routines can be executed. For further information, contact factory and request RS-485 Protocol manual.

9.3 Operation of Serial Communication Port with PC

The flow computer's RS-485 channel supports a number of Modbus RTU commands. Refer to port pinout (below) for wiring details. Modbus RTU drivers are available from third party sources for a variety of Man Machine Interface software for IBM compatible PC's.

The user reads and writes information from/to the RS-485 using the Modbus RTU commands. The SUPERtrol II then responds to these information and command requests.

Process variables and totalizers are read in register pairs in floating point format. Time and date are read as a series of integer register values. Alarms are individually read as coils. Action routines are initiated by writing to coils.

9.4 SUPERtrol II RS-485 Port Pinout

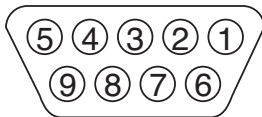

- 1 Ground
- 2 Ground
- 3 Ground
- 4 TX/RX (+)
- 5 TX/RX (-)
- 6 Do Not Use
- 7 Terminating Resistor (180 Ω)
- 8 TX/RX (+)
- 9 TX/RX (-)

NOTES:

4 is internally connected to 8
5 is internally connected to 9

To terminate end of cable, connect pin 7 to either 4 or 8.

Request *SUPERtrol II RS-485 Option with Modbus RTU Protocol* manual for complete details of RS-485

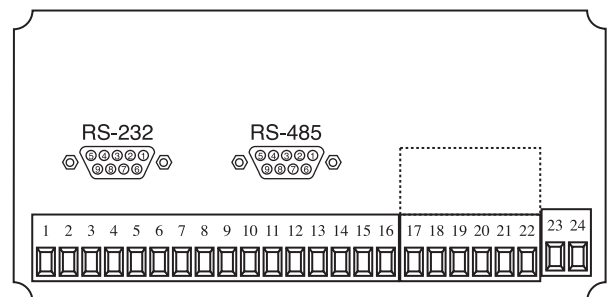

10. Flow Computer Setup Software

The SUPERtrol II setup program provides for configuring, monitoring and controlling a SUPERtrol II unit.

Sample applications are stored in disk files. The setup program calls these *Templates*. You can store the setup from the program's memory to either the SUPERtrol II (*Downloading* the file) or to a disk file (*Saving* the file) for later usage. Similarly you can load the setup in program memory from either a disk file (*Opening* a file) or from the SUPERtrol II unit (*Uploading* a file).

The program can monitor outputs from the unit while it is running.

The program can reset alarms and totalizers.

The peak demand may be reset when the option is supplied.

For assistance there are mini-helps at the bottom of each screen in the program. There is also context sensitive help available for each screen accessible by pressing the F1 key.

10.1 System Requirements:

IBM PC or compatible with 386 or higher class microprocessor

4 MB RAM

3 MB free disk space

VGA or higher color monitor at 640 x 480

Microsoft® Windows™ 3.1 or 3.11 or Windows 95/98™ or higher

Communication Port - RS-232

RS-232 Cable (customer supplied)

10.2 Cable and Wiring Requirements:

The serial communication port on your PC is either a 25 pin or 9 pin connector. No cabling is supplied with the setup software. A cable must be purchased separately or made by the user. It is recommended to purchase a serial cable which matches the available communication port on your PC and a 9 pin male connection for the SUPERtrol II serial port.

10.3 Installation for Windows™ 3.1 or 3.11

The Setup Software includes an installation program which copies the software to your hard drive.

Insert Setup Disk 1 in a floppy drive.

In the Program Manager, click File, and then select Run.

NOTE: For Windows 95™ Click the Start button, select Run and proceed as follows:

Type the floppy drive letter followed by a colon (:), and a backslash (\), and the word setup.

For Example:

a:\setup

Follow the instructions on your screen.

10.4 Using the Flow Computer Setup Software

The setup software window consists of several menu "Tabs". Each tab is organized into groups containing various configuration and/or monitoring functions. To view the tab windows, simply click on the tab. The previous tab window will be hidden as the new tab window is brought to the foreground.

Caution: It is required that the SUPERtrol II unit which is being configured be kept in the operating mode while using the setup diskette. If not, uncertainty exists as to what information will be retained when the session is concluded.

10.5 File Tab

The File Tab has three sections. Any of the options on this tab can also be accessed from the File submenu.

The **Template Section** provides for opening and saving templates. The *Save* and *Save As* buttons provide the standard Windows functionality for dealing with files. The *Open* button is used to open existing templates.

The *Open* option allows for creating custom templates using the existing template in memory as the starting point. Assign a new name for this template. The template will be saved under this new name.

A typical scenario using the setup program would be the following:

- Open up a predefined template from the supplied list
- Choose 'Save As' to save this to a new file name
- Proceed to customize the template by making any changes that are needed
- Save the template to disk (if you want to reuse this template)
- Download the template to an attached unit.

The **Communications with SUPERtrol II Section** allows the user to upload the setup from the unit or download the program's current template to the unit.

The **Print (report) Section** allows the user to:

1. Configure the current Windows printer through the Select Printer option.
2. Print a Maintenance Report through the PC's printer using the Print Maintenance option.
3. Print the current setup through the PC's printer using Print Setup option.

10.6 Setup Tab

The Setup tab is where the majority of the SUPERtrol II instrument setup modifications are done. The Setup tab is divided into five sections.

System Section: Parameters, Display, Units

Input Section: Flow, Fluid, Compensation Inputs

Output Section: Pulse, Currents

Relay Section: Relays

Other Settings Section: Administration, Communication, Printing

NOTE: Many setup items are enabled or disabled depending on previous setup selections, It is important to work your way through the above list in the order shown. Be sure to verify your selections when you are through programming to insure that no settings were changed automatically.

10.7 View Tab

The View Tab screen allows for viewing selected group items on the PC in a similar format to that shown on the unit display. Data from the following groups can be viewed in the List of Values section:

- Process Parameters (i.e. rate, temperature)
- Totalizers (i.e. total, grand total)
- Input Signals
- Analog Output
- Error Status
- SUPERtrol II Software Version Information

The setup software assumes the current setup has been uploaded from the flow computer into the PC. It is important that the setup program and the SUPERtrol II unit are using the same setup information at all times or the data will be inconsistent. It is best to upload or download the setup before using this feature to synchronize the setups.

Error Log

Data from the error logger is viewed in a separate Error Log section on the screen.

To start the viewer, first check the boxes of items to view and then click the start button. The data will appear in the appropriate sections and will be continuously updated. The refresh rate is dependent on the number of items that are being viewed and the baud rate of the connection. Data in the List of Values section can be collapsed by clicking on the 'minus' sign in front of the group title. The data can be expanded by clicking on the 'plus' sign in front of the group title. If a group is collapsed and data in the group changes on refresh, the group will automatically expand. Data in the Error Log section does not expand or collapse. Changing the view items requires stopping the current viewing, checking the new selections and then restarting the viewer.

If communication errors occur while reading data from the SUPERtrol II device, the word 'Error' will appear in place of the actual value. If the connection to the SUPERtrol II is lost, the viewer will time out with a message saying the device is not responding.

The viewer will attempt to communicate with the SUPERtrol II device matching the device ID set in the communications screen. If you are having trouble establishing communication, compare settings for the PC and the flow computer. Also verify the connections between the PC and flow computer.

10.8 Misc. Tab

This tab has three sections: Tools, Actions and Options.

The tools section contains various system administration activities such as creating/modifying the initial sign-on screen or create print headers.

The Actions section is used to send commands to the SUPERtrol II unit.

Reset Totalizers, Reset Alarms, Simulations, Self Check, Reset Peak Demand (if equipped)

The Options section has the following selections:

Language Translations, Network Card Configuration
Additional capabilities may be provided in the future.

11. Glossary of Terms

Access Code

A numeric password which is entered by a user attempting to gain entry to change setup parameters.

AGA-3

A empirical flow equation applicable to orifice and several other square law flowmeters.

AGA-5

A gas flow equation for computing the combustion heat flow from measured volume flow, temperature and pressure as well as stored gas properties.

AGA-7

A gas flow equation for pulse producing, volumetric flowmeters which computes the equivalent flow at reference conditions from the measurements made at flowing line conditions.

Assign Usage

A menu selection during the setup of the instrument which selects the intended usage for the input/output.

Barometric Pressure

An entry of the average, local atmospheric pressure at the altitude or elevation of the installation. (typically 14.696 psia)

Beta

A important geometric ratio for a square law flowmeters.

Calibration

An order sequence of adjustments which must be performed in order for the equipment to operate properly.

Calibration Temperature

The temperature at which a flow sensor was calibrated on a test fluid.

Combustion Heat

The energy released by a fluid fuel during combustion .

Default

A value to be assumed for manual inputs or in the event of a failure in a input sensor.

Display Damping

An averaging filter constant used to smooth out display bounce.

DP Factor

A scaling constant for a square law flowmeter.

Error Log

A historical record which captures errors which have occurred.

Flow Equation

A recognized relationship between the process parameters for flow, temperature, pressure and density used in flow measurements.

Galvanic Isolation

Input and or output functions which do not share a conductive ground or common connection between them.

Gas Cor. Vol Eq.

An equation where the corrected volume flow of gas at STP is computer from measured volume flow, temperature and pressure as well as stored gas properties.

Gas Comb. Heat Eq.

An equation where the combustion heat flow of gas is computer from measured volume flow, temperature and pressure as well as stored gas properties.

Gas Mass Eq.

An equation where the mass flow of gas is computer from measured volume flow, temperature and pressure as well as stored gas properties.

Flowing Z-Factor

The mean Z-Factor under flowing conditions of temperature and pressure for a specific gas.

11. Glossary of Terms (Continued)

Full Scale

The value of the process variable at the full scale or maximum input signal.

Inlet Pipe Bore

The internal pipe diameter upstream of the flow measurement element.

Isentropic Exponent

A property of a gas or vapor utilized in orifice meter calculations.

K-Factor

The calibration constant for a pulse producing flowmeter expressed in pulses per unit volume

Linear

A flow measurement device where the output signal is proportional to flow.

Linear 16 Pt.

A mathematical approximation to a nonlinear device where by a correction factor or K-Factor table as a function of input signal is utilized to eliminate flowmeter nonlinearity.

Low Flow Cutoff

The value of input signal below which flow rate may be assumed to be 0 and at which totalization will cease.

Low Scale

The value of the process variable at the zero input signal.

Manual

An entry value to be used as a fixed condition in a equation

Meter Exp. Coef.

A coefficient in an equation which may be used to correct for changes in flowmeter housing dimensioned changes with temperature.

Mole %

The % composition of an individual gas in a gas mixture.

NX-19

A series of equations used to compute the compressibility of natural gas as a function of specific gravity, temperature, pressure and gas composition.

Protocol

An agreed upon method of information exchange.

Print Initiate

A user specified condition which must be satisfied for a transaction document to be printed.

Pulse Type

A menu selectable equivalent pulse output stage.

Pulse Value

An output scaling factor defining the equivalent amount of flow total represented by 1 output pulse.

Ref. Z-Factor

The Z-Factor for a gas at reference conditions of temperature and pressure.

Ref. Density

The density of a fluid at reference conditions of temperature and pressure.

Relay Function

The assigned usage for a relay output.

Relay Mode

The user's desired operating mode for the relay. Examples: follow, latch, timed pulse, above setpoint, below setpoint

Safe State

The state of an instrument's outputs which will occur during a power down state. The state the instrument assumes when the computations are paused.

11. Glossary of Terms (Continued)

Scroll List

The user's desired display list which can be presented on the two list display on Line 1 and/or L2 when the SCROLL key is depressed.

Self Check

A diagnostic sequence of steps a unit performs to verify it's operational readiness to perform it's intended function.

Service Test

A diagnostic sequence requiring specialized test apparatus to function to verify system readiness.

Setpoint

An alarm trip point.

Simulation

A special operating mode for an output feature which enables a service personnel to manually exercise the output during installation or trouble shooting operations.

Square Law Flowmeters

Types of measurement devices which measure differential pressure across a known geometry to make a flow measurement.

SQR LAW (Square Law w/o SQRT)

A square law flow measurement device equipped with a pressure transmitter with out a integral square root extractor.

SQR LAW-LIN (Square Law w/ SQRT)

A square law flow measurement device equipped with a pressure transmitter with integral square root extraction.

SQR Law 16PT (Square Law 16pt)

A mathematical approximation to a square law device where the discharge coefficient is represented as a table of DP Factor vs Reynold's Number.

Steam Delta Heat

A computation of the net heat of saturated steam equal to the total heat of steam minus the heat of water at the measured actual temperature.

Steam Heat

A computation of the total heat of steam.

Steam Net Heat

A computation of the net heat of steam equal to the total heat of steam minus the heat of water at the same saturated temperature.

STP Reference

The user's desired pressure and/or temperature to be considered as the reference condition in the computation of fluid properties or corrected volume conditions.

TAG

An alphanumeric designation for a particular instrument.

Time Constant

An averaging filter constant used to reduce bounce on the analog output. The high the number the slower the response, the greater filtering.

UVC

Universal Viscosity Curve is a representation of the calibration factor for a turbine flowmeter. It is expressed as a table of K-Factor as a function of Hz/CSTKS.

Viscosity Coef

A parameter in an equation which is used to estimate the viscosity as a function of temperature.

12. Diagnosis and Troubleshooting

12.1 Response of SUPERtrol II on Error or Alarm:

Error indications which occur during operation are indicated alternately with the measured values. The SUPERtrol II Flow Computer has four types of error:

TYPE OF ERROR	DESCRIPTION
System Alarms	Errors detected due to system failure
Sensor/Process Alarms	Errors detected due to sensor failure or process alarm conditions
Service Test Errors	Errors detected due to problems found during service test. (Service test can only be performed by qualified Factory service technicians because service code and special equipment are needed)
Self Test Errors	Errors detected during self test. (Each time the unit is powered, it runs a self test)

12.2 Diagnosis Flow Chart and Troubleshooting

All instruments undergo various stages of quality control during production. The last of these stages is a complete calibration carried out on state-of-the-art calibration rigs. A summary of possible causes is given below to help you identify faults.

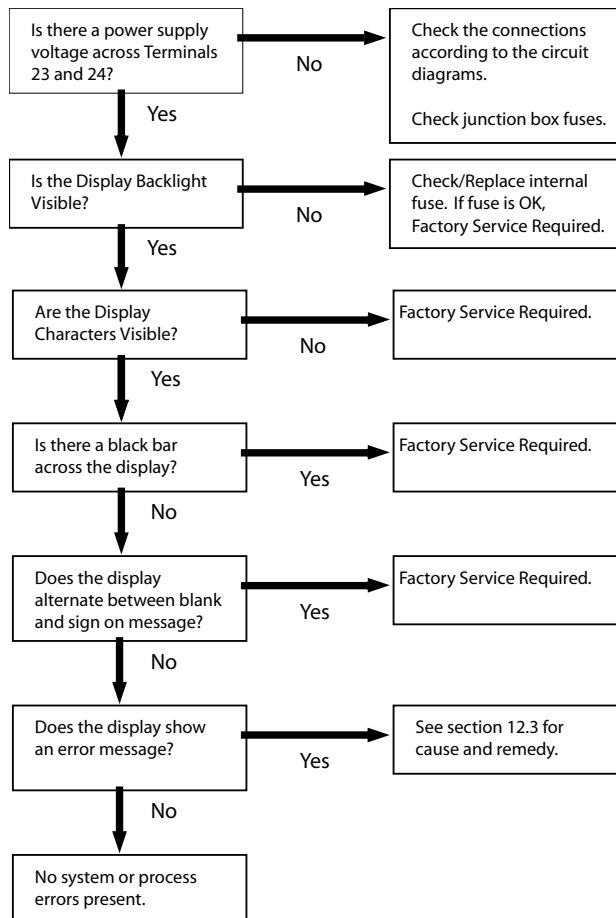

12.3 Error Messages:

NOTE: The 24 VDC output has a self resetting fuse.

Error Message	Cause	Remedy
POWER FAILURE	Power has been interrupted	Acknowledge Error Remedy not required
WATCHDOG TIMEOUT	Possible transient	Acknowledge Error Remedy not required
COMMUNICATION ERROR	Possible Improper wiring or usage Message Transmission failure.	Check wiring and communication settings / protocol
CALIBRATION ERROR	Operator Error	Repeat Calibration
PRINT BUFFER FULL	Print buffer full, Data may be lost	Check paper and printer connections
WET STEAM ALARM	Temperature or pressure input has gone below the saturated steam range of the internal steam tables	Check application, Insure that all sensors are working properly
OFF FLUID TABLE	Temperature or pressure input has gone below or exceeded the range of the internal steam tables	Check application, Insure that all sensors are working properly
FLOW IN OVERRANGE	Flow input has exceeded input range (if stacked, may be lo or hi transmitter)	Check sensor calibration
INPUT 1 OVERRANGE	Input 1 signal from sensor has exceeded input range	Check sensor calibration
INPUT 2 OVERRANGE	Input 2 signal from sensor has exceeded input range	Check sensor calibration
INPUT 3 OVERRANGE	Input 3 signal from sensor has exceeded input range	Check sensor calibration
FLOW LOOP BROKEN	Open circuit detected on flow input (if stacked, may be lo or hi transmitter)	Check wiring and sensor
LOOP 1 BROKEN	Open circuit detected on input 1	Check wiring and sensor
LOOP 2 BROKEN	Open circuit detected on input 2	Check wiring and sensor
LOOP 3 BROKEN	Open circuit detected on input 3	Check wiring and sensor
RTD 1 OPEN	Open circuit detected on RTD 1 input	Check wiring and RTD
RTD 1 SHORT	Short circuit detected on RTD 1 input	Check wiring and RTD

12.3 Error Messages: (Continued)

Error Message	Cause	Remedy
RTD 2 OPEN	Open circuit detected on RTD 2 input	Check wiring and RTD
RTD 2 SHORT	Short circuit detected on RTD 2 input	Check wiring and RTD
PULSE OUT OVERRUN	Pulse output has exceeded the internal buffer	Adjust pulse value or pulse width
Iout 1 OUT OF RANGE	Current output 1 is below or above specified range	Adjust the "0"/ "Full Scale" values or increase/ lower flowrate
Iout 2 OUT OF RANGE	Current output 1 is below or above specified range	Adjust the "0"/ "Full Scale" values or increase/ lower flowrate
TOTALIZER ERROR		
RELAY 1 HI ALARM	Relay 1 is active due to high alarm condition	Not required
RELAY 1 LO ALARM	Relay 1 is active due to low alarm condition	Not required
RELAY 2 HI ALARM	Relay 2 is active due to high alarm condition	Not required
RELAY 2 LO ALARM	Relay 2 is active due to low alarm condition	Not required
RELAY 3 HI ALARM	Relay 3 is active due to high alarm condition	Not required
RELAY 3 LO ALARM	Relay 3 is active due to low alarm condition	Not required
24VDC OUT ERROR	24V output error detected during service test run	By Factory Service
PULSE IN ERROR	Pulse input error detected during service test run	By Factory Service
INPUT 1 Vin ERROR	Error detected on input 1 voltage input during service test run	By Factory Service
INPUT 1 Iin ERROR	Error detected on input 1 current input during service test run	By Factory Service
INPUT 2 Iin/RTD ERROR	Error detected on input 2 during service test run	By Factory Service
INPUT 3 Iin/RTD ERROR	Error detected on input 3 during service test run	By Factory Service

Error Message	Cause	Remedy
PULSE OUT ERROR	Pulse output error detected during service test run	By Factory Service
Iout 1 ERROR	Current output 1 error detected during service test run	By Factory Service
Iout 2 ERROR	Current output 2 error detected during service test run	By Factory Service
RELAY 1 ERROR	Relay 1 error detected during service test run	By Factory Service
RELAY 2 ERROR	Relay 2 error detected during service test run	By Factory Service
RS-232 ERROR	RS-232 error detected during service test run	By Factory Service
A/D MALFUNCTION	Error detected in A/D converter during self test	By Factory Service
PROGRAM ERROR	Error on access to the program memory	By Factory Service
SETUP DATA LOST	All or part of the EEPROM data for setup is damaged or has been overwritten	Re-Enter setup data, If problem persists, Factory service required
TIME CLOCK LOST	The real time clock data was lost during extended power outage	Re-Enter time and date
DISPLAY MALFUNCTION	A display malfunction has been detected.	By Factory Service
RAM MALFUNCTION	Part or all of the internal RAM is damaged	By Factory Service
TRAP ERROR	Steam trap malfunction	Service steam trap
TRAP BLOWING	Steam trap malfunction	Change error delay
DATALOG LOST	Contents of datalog were corrupt and lost	Clear datalog, Clear errors

Appendix A - Fluid Properties Table

Fluid Properties Table

LIQUID

FLUID	REF. DENSITY (lb./ft ³)	REF. TEMP. (°F)	COEFF. OF EXPANSION	COMBUSTION HEAT (Btu/lb) LIQUID H ₂ O and CO ₂	SPECIFIC HEAT (Btu/lb °F)	LIQ.VISC. ANDREDE's EQUATION COEFF. "A"	VISCOSITY BY ANDREDE's EQUATION COEFF. "B"
AIR	54.56	-317.8	0.0016262	0	0.45	0.172	0
AMMONIA	42.63	-28.2	0.0005704	0	1.05	0.00157	2228.25
ARGON	86.89	-302.6	0.0014861	0	0.45	0.011291	511.34
CO2	65.333	-10.0	0.0012609	0	0.45	0.000001	5305.44
METHANE	26.48	-258.7	0.0010523	23920	0.80	0.006819	526.08
NATURAL GAS	26.48	-258.7	0.0010523	23920	0.80	0.006819	526.08
NITROGEN	50.44	-320.4	0.0014917	0	0.55	0.006524	434.94
OXYGEN	71.21	-297.4	0.0013458	0	0.41	0.019773	340.29
PROPANE	31.671	60	0.0007178	21690	0.6	0.009969	1267.35
Nx-19	26.48	-258.7	0.0010523	23920	0.80	0.006819	526.08
GASOLINE	46.8	60	0.0003703	20400	0.5	0.045617	1432.26
KEROSENE	51.79	60	0.0002681	18400	0.45	0.004378	3245.78
No. 2 FUEL	58.97	60	0.0000885	17970	0.42	0.000453	4946.15
WATER	62.37	60	0.0001015	0	1	0.001969	3315.61
HYDROGEN	4.41874	-432.2	0.0007259	60620.5	2.336	0.003537	48.5432
ETHYLENE	34.085	-127.5	0.00068257	22292	1	0.000238	26665.90
HELIUM	9.14157	-452.1	0.00011477	0	1	0.0033	0

GAS

FLUID	REF. DENSITY (lb./ft ³)	REF. TEMP. (°F)	REF. Z FACTOR (14.696 PSIA)	Z FACTOR AT 100 PSIA and 60°F	SPECIFIC HEAT (Btu/lb °F)	COMBUSTION HEAT (Btu/lb) LIQUID H ₂ O and CO ₂	ISENTROPIC EXPONENT	VISCOSITY BY ANDREDE's EQUATION COEFF. "A"	VISCOSITY BY ANDREDE's EQUATION COEFF. "B"
AIR	0.076	60	1	0.997	0.24	0	1.4	0.000138	0.775522
AMMONIA	0.045	60	1	0.955	0.52	0	1.31	0.000013	1.05951
ARGON	0.105	60	1	0.995	0.125	0	1.67	0.00021	0.750757
CO2	0.116	60	1	0.954	0.21	0	1.32	0.000049	0.91136
METHANE	0.042	60	1	0.970	0.55	23920	1.31	0.000018	1.015892
NAT. GAS	0.0456	60	1	0.970	0.55	23920	1.31	0.000018	1.015892
NITROGEN	0.074	60	1	0.998	0.25	0	1.41	0.000202	0.7128734
OXYGEN	0.084	60	1	0.995	0.22	0	1.41	0.000169	0.761811
PROPANE	0.116	60	1	0.870	0.4	21690	1.14	0.00002	0.952092
Nx-19	0.0456	60	1	0.97	0.55	23920	1.31	0.000018	1.015892
HYDROGEN	0.00532	60	1	1.0042	3.42	60620.5	1.405	0.000151	0.647667
ETHYLENE	0.074717	60	1	0.994	0.386	22292	1.244	0.0093	0
HELIUM	0.01055	60	1	1	1.25	0	1.630	0.000209	0.721975

Appendix B - Setup Menus

SETUP MENUS
Operator Code Access

START HERE

SYSTEM PARAMETER

EZ SETUP	ACCESS CODE	FLOW EQUATION	ENTER DATE	ENTER TIME	DAYLIGHT SAVINGS	OPERATOR CODE	TAG #	ORDER CODE	SERIAL #	SENSOR SERIAL #
----------	-------------	---------------	------------	------------	------------------	---------------	-------	------------	----------	-----------------

DISPLAY

SCROLL LIST	DISPLAY DAMPING	MAX. DEC. POINT	LANGUAGE	TOTAL ROLL OVER
-------------	-----------------	-----------------	----------	-----------------

SYSTEM UNITS

TIME BASE	HEAT FLOW UNIT	HEAT TOTAL UNIT	MASS FLOW UNIT	MASS TOTAL UNIT	COR. VOL. FLOW UNIT	COR. VOL. TOTAL UNIT	VOLUME FLOW UNIT	VOLUME TOTAL UNIT	DEFINITION	TEMPERATURE UNIT	PRESSURE UNIT	DENSITY UNIT	SPEC. ENTHALPY UNIT	LENGTH UNIT
-----------	----------------	-----------------	----------------	-----------------	---------------------	----------------------	------------------	-------------------	------------	------------------	---------------	--------------	---------------------	-------------

FLUID DATA

FLUID TYPE	REF. DENSITY	THERM. EXP. COEF.	COMBUSTION HEAT	SPECIFIC HEAT	FLOW Z-FAC-TOR	REF. Z-FAC-TOR	ISENTROPIC EXP.	MOLE % NITROGEN	MOLE % CO2	VISCOSITY COEF. A	VISCOSITY COEF. B
------------	--------------	-------------------	-----------------	---------------	----------------	----------------	-----------------	-----------------	------------	-------------------	-------------------

FLOW INPUT

FLOWMETER TYPE	SQUARE LAW FLOWMETER	ILVA SIZE	ACCELERAB. SIZE	INPUT SIGNAL	LOW SCALE	FULL SCALE	LOW SCALE HIGH RANGE	FULL SCALE HIGH RANGE	SWITCH UP	SWITCH DOWN	LOW FLOW CUTOFF	CALIBRATION DENSITY	K-FACTOR	PIPE INNER DIAMETER	ENTER BETA
----------------	----------------------	-----------	-----------------	--------------	-----------	------------	----------------------	-----------------------	-----------	-------------	-----------------	---------------------	----------	---------------------	------------

COMPENSATION INPUT

1	INPUT SIGNAL	LOW SCALE VALUE	FULL SCALE VALUE	DEFAULT VALUE	STP. REFER-ENCE	CALIBRATION TEMP.	LOW DELTA T CUTOFF	VIEW INPUT SIGNAL	TRAP ERROR DELAY	TRAP BLOW-ING DELAY
2	INPUT SIGNAL	LOW SCALE VALUE	FULL SCALE VALUE	DEFAULT VALUE	STP. REFER-ENCE	BAROMETRIC PRESS.	VIEW INPUT SIGNAL			

PULSE OUTPUT

ASSIGN PULSE OUTPUT	PULSE TYPE	PULSE VALUE	PULSE WIDTH	SIMULATION FREQ.
---------------------	------------	-------------	-------------	------------------

CURRENT OUTPUT

1	ASSIGN CURRENT OUT.	CURRENT RANGE	LOW SCALE VALUE	FULL SCALE VALUE	TIME CON-STANT	CURRENT OUT VALUE (DISPLAY)	SIMULATION CURRENT
2	ASSIGN CURRENT OUT.	CURRENT RANGE	LOW SCALE VALUE	FULL SCALE VALUE	TIME CON-STANT	CURRENT OUT VALUE (DISPLAY)	SIMULATION CURRENT

RELAYS

SELECT RELAY 1, 2, 3	RELAY FUNCTION	RELAY MODE	LIMIT SET-POINT	PULSE VALUE	PULSE WIDTH	HYSTERESIS	RELAY SIMULA-TION	RESET ALARM
----------------------	----------------	------------	-----------------	-------------	-------------	------------	-------------------	-------------

COMMUNICATION

RS232 USAGE	DEVICE ID	BAUD RATE	PARITY	HANDSHAKE	PRINT LIST	PRINT INITIATE	DATALOG ONLY	PRINT INTERVAL	PRINT TIME	DATALOG FORMAT	MODEM CONTROL	DEVICE MASTER	SEND INC TO ONLY	INC ONLY SCALER	CLEAR DATALOG
-------------	-----------	-----------	--------	-----------	------------	----------------	--------------	----------------	------------	----------------	---------------	---------------	------------------	-----------------	---------------

NETWORK CARD

PROTOCOL	DEVICE ID	BAUD RATE	PARITY
----------	-----------	-----------	--------

SERVICE & ANALYSIS

EXAMINE AUDIT TRAIL	ERROR LOG	SOFTWARE VERSION (DISPLAY)	HARDWARE VERSION (DISPLAY)	PRINT SYSTEM SETUP	SELF CHECK
---------------------	-----------	----------------------------	----------------------------	--------------------	------------

MODEM AUTO ANSWER	CALL OUT NO	CALL OUT TIME	CALL ON ERROR	NUMBER OF REDIALS	HANGUP IF INACTIVE	ERROR MASK
-------------------	-------------	---------------	---------------	-------------------	--------------------	------------

METER EXP. COEF.	DP-FACTOR	LOW PASS FILTER	LINEARIZATION	FLOWMETER LOCATION	BYPASS CAL. FACTOR	BYPASS EAM FACTOR
BYPASS DC FACTOR	BYPASS YM FACTOR	VIEW INPUT SIGNAL	VIEW HI RANGE SIGNAL			

These functions will only appear with appropriate settings in other functions.

Appendix B- Setup Menus
(continued)

START HERE

SETUP MENUS
Service Code Access

SYSTEM PARAMETER

EZ SETUP	ACCESS CODE	FLOW EQUATION	ENTER DATE	ENTER TIME	DAYLIGHT SAVINGS	OPERATOR CODE	SUPERVISOR CODE	ENGINEERING CODE	TAG #	ORDER CODE	SERIAL #	SENSOR SERIAL #
----------	-------------	---------------	------------	------------	------------------	---------------	-----------------	------------------	-------	------------	----------	-----------------

DISPLAY

SCROLL LIST	DISPLAY DAMPING	MAX. DEC. POINT	LANGUAGE	TOTAL ROLL OVER
-------------	-----------------	-----------------	----------	-----------------

SYSTEM UNITS

TIME BASE	HEAT FLOW UNIT	HEAT TOTAL UNIT	MASS FLOW UNIT	MASS TOTAL UNIT	COR VOL FLOW UNIT	COR VOL TOTAL UNIT	VOLUME FLOW UNIT	VOLUME TOTAL UNIT	DEFINITION	TEMPERATURE UNIT	PRESSURE UNIT	DENSITY UNIT	SPECIFIC ENTHALPY UNIT	LENGTH UNIT
-----------	----------------	-----------------	----------------	-----------------	-------------------	--------------------	------------------	-------------------	------------	------------------	---------------	--------------	------------------------	-------------

FLUID DATA

FLUID TYPE	REF. DENSITY	THERM. EXP. COEF.	COMBUSTION HEAT	SPECIFIC HEAT	FLOW Z-FAC-TOR	REF. Z-FAC-TOR	ISENTROPIC EXP.	MOLE % NITROGEN	MOLE % CO2	VISCOSITY COEF. A	VISCOSITY COEF. B
------------	--------------	-------------------	-----------------	---------------	----------------	----------------	-----------------	-----------------	------------	-------------------	-------------------

FLOW INPUT

FLOWMETER TYPE	SQUARE LAW FLOWMETER	ILVA SIZE	ACCELABAR SIZE	INPUT SIGNAL	LOW SCALE	FULL SCALE	LOW SCALE HIGH RANGE	FULL SCALE HIGH RANGE	SWITCH UP	SWITCH DOWN	LOW FLOW CUTOFF	CALIBRATION DENSITY	K-FACTOR	PIPE INNER DIAMETER	ENTER BETA
----------------	----------------------	-----------	----------------	--------------	-----------	------------	----------------------	-----------------------	-----------	-------------	-----------------	---------------------	----------	---------------------	------------

COMPENSATION INPUT

1	INPUT SIGNAL	LOW SCALE VALUE	FULL SCALE VALUE	DEFAULT VALUE	STP. REFER-ENCE	CALIBRATION TEMP	LOW DELTA T CUTOFF	VIEW INPUT SIGNAL	TRAP ERROR DELAY	TRAP BLOW-ING DELAY
---	--------------	-----------------	------------------	---------------	-----------------	------------------	--------------------	-------------------	------------------	---------------------

PULSE OUTPUT

2	INPUT SIGNAL	LOW SCALE VALUE	FULL SCALE VALUE	DEFAULT VALUE	STP. REFER-ENCE	BAROMETRIC PRESS	VIEW INPUT SIGNAL
---	--------------	-----------------	------------------	---------------	-----------------	------------------	-------------------

CURRENT OUTPUT

1	ASSIGN CUR-RENT OUT.	CURRENT RANGE	LOW SCALE VALUE	FULL SCALE VALUE	TIME CON-STANT	CURRENT OUT VALUE (DISPLAY)	SIMULATION CURRENT
---	----------------------	---------------	-----------------	------------------	----------------	-----------------------------	--------------------

RELAYS

2	ASSIGN CUR-RENT OUT.	CURRENT RANGE	LOW SCALE VALUE	FULL SCALE VALUE	TIME CON-STANT	CURRENT OUT VALUE (DISPLAY)	SIMULATION CURRENT
---	----------------------	---------------	-----------------	------------------	----------------	-----------------------------	--------------------

COMMUNICATION

SELECT RELAY 1, 2, 3	RELAY FUNC-TION	RELAY MODE	LIMIT SET-POINT	PULSE VALUE	PULSE WIDTH	HYSTERESIS	RELAY SIMULA-TION	RESET ALARM
----------------------	-----------------	------------	-----------------	-------------	-------------	------------	-------------------	-------------

NETWORK CARD

RS232 USAGE	DEVICE ID	BAUD RATE	PARITY	HANDSHAKE	PRINT LIST	PRINT INITIATE	DATALOG ONLY	PRINT INTERVAL	PRINT TIME	DATALOG FORMAT	MODEM CONTROL	DEVICE MASTER	SEND INC TOT ONLY	INC ONLY SCALER	CLEAR DATALOG
-------------	-----------	-----------	--------	-----------	------------	----------------	--------------	----------------	------------	----------------	---------------	---------------	-------------------	-----------------	---------------

SERVICE & ANALYSIS

PROTOCOL	DEVICE ID	BAUD RATE	PARITY	MODEM AUTO ANSWER	CALL OUT NO	CALL OUT TIME	CALL ON ERROR	NUMBER OF REDIALS	HANGUP IF INACTIVE	ERROR MASK
----------	-----------	-----------	--------	-------------------	-------------	---------------	---------------	-------------------	--------------------	------------

EXAMINE

EXAMINE	ERROR LOG	SOFTWARE VERSION (DISPLAY)	HARDWARE VERSION (DISPLAY)	RESTORE FACTORY CALIBRATION	PRINT MAINT. REPORT	PRINT SYSTEM SETUP	SELF CHECK	SERVICE TEST
---------	-----------	----------------------------	----------------------------	-----------------------------	---------------------	--------------------	------------	--------------

These functions will only appear with appropriate settings in other functions.

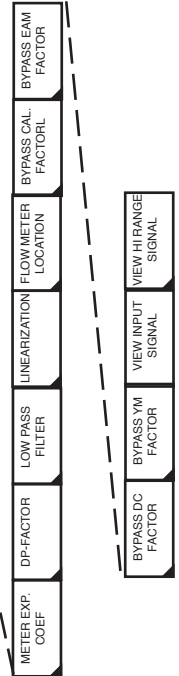

Appendix C- RS-485 Modbus Protocol

RS-485 & Modbus RTU Protocol

When the Flow Computer is equipped with the RS-485 communication option, the protocol it uses is the Modbus RTU protocol. This protocol defines a message structure that hosts and clients will recognize and use on the RS-485 network over which they communicate. It describes the process a master device (PC compatible) uses to request access to another device (Flow Computer), how it will respond to requests from the other devices, and how errors will be detected and reported. It establishes a common format for the layout and contents of message fields.

During communications on a Modbus RTU network, the protocol determines how each Flow Computer will know its device address, recognize a message addressed to it, determine the kind of action to be taken, and extract any data or other information contained in the message. If a reply is required, the Flow Computer will construct the reply message and send it using Modbus RTU protocol.

RTU Mode

The Flow Computer with RS-485 communications option supports the Modbus RTU (Remote Terminal Unit) mode only. The Modbus ASCII mode is not supported. The main advantage of the RTU mode is that its greater character density allows better data throughput than ASCII for the same baud rate. The Modbus RTU uses a Master-Slave Query-Response Cycle in which the Flow Computer is the slave device.

Control Functions

The Flow Computer with RS-485 communications option supports the following function codes:

CODE	NAME	DESCRIPTION
01	Read Coil Status	Read a single coil
03	Read Holding Register	Read a range of holding registers
05	Force Single Coil	Forces a single coil (0x reference) to either ON or OFF
06	Preset Single Register	Presets a value into a single holding register (4x reference)
15	Force Multiple Coil	Forces each coil (0x reference) in a sequence of coils to either ON or OFF
16	Preset Multiple Registers	Presets values into a sequence of holding registers (4x reference)

Appendix C- RS-485 Modbus Protocol (continued)

Flow Computer RS-485 Port Pinout (recommended mating connector: DB-9M)

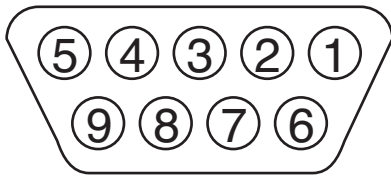

- 1 Ground
- 2 Ground
- 3 Ground
- 4 TX/RX (+)
- 5 TX/RX (-)
- 6 Do Not Use
- 7 Terminating Resistor (180 Ω)
- 8 TX/RX (+) (spare internally connected to 4)
- 9 TX/RX (-) (spare internally connected to 5)

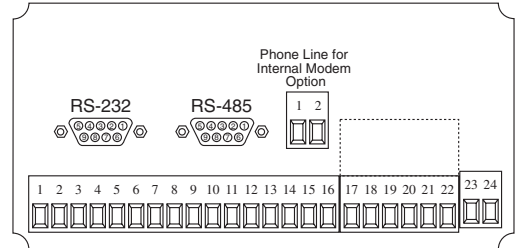

Flow Computer RS-485 Port Pinout (Terminal Block Option)

- 1 Common
- 2 TX/RX (+)
- 3 TX/RX (-)
- 4 Terminating Resistor (180Ω)

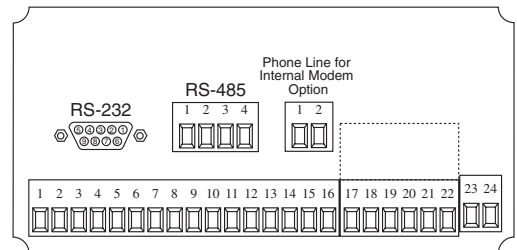

Installation Overview

A two wire RS-485 may be multidropped up to 4000 ft. and up to 32 units may be chained together. A RS-485 to RS-232 interface adaptor is required at the PC. An optically isolated type is recommended. Suitable wiring should be selected based on anticipated electrical interference. Terminators should be used to help improve the quality of electronic signals sent over the RS-485 wires. The RS-485 chain should be terminated at the beginning (RS-485 adaptor) and at the last device in the RS-485 chain and nowhere else. On the Flow Computer this is accomplished by connecting a jumper from the terminal labeled **Terminating Resistor (180 Ω)** to the terminal labeled **TX/RX(+)** at the RS-485 port. If lightning protection is required, a suitable surge protector should be used.

For additional information, refer to the technical requirements of EIA-485, interface adaptor user manual and the communication software user manual

Flow Computer Communication Setup Menu

The setup menu allows Modbus RTU Protocol communications parameters of: Device ID, Baud Rate, and Parity to be selected to match the parameters of your RS-485 network. Each Flow Computer must have it's own Device ID and the same Baud Rate and Parity setting.

Appendix C- RS-485 Modbus Protocol (continued)

Terminal Layout for Wall Mount Option:

NEMA 12, 13 Terminal Designations

RS-232	
1	TX
2	RX
3	COM
4	BIAS
5	DCD
6	MP (+8 VDC)

RS-485	
1	TX/RX(+)
2	Terminating Resistor (180 ohms)
3	TX/RX(-)
4	Common

Phone	
1	TIP
2	RING
3	Not Used
4	Not Used
5	Not Used
6	Not Used

NEMA 12, 13 Terminal Layout

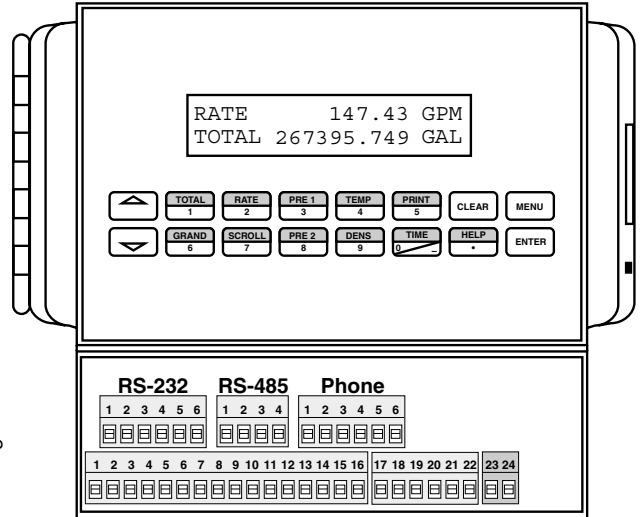

DC Power
3 Relay Option

1	DC OUTPUT	FLOW IN
2	PULSE IN	Vin (+) * IN
3	-----	lin (+)
4	COMMON	
5	RTD EXCIT (+)	TEMPERATURE IN
6	RTD SENS (+)	
7	RTD SENS (-)	lin (+)
8	DC OUTPUT	
9	RTD EXCIT (+)	PRESSURE (TEMP 2)
10	RTD SENS (+)	
11	RTD SENS (-)	lin (+)
12	PULSE OUTPUT (+)	
13	PULSE OUTPUT (-)	
14	ANALOG OUTPUT 1 (+)	
15	ANALOG OUTPUT 2 (+)	
16	ANALOG OUTPUT COMMON (-)	
17	NO RLY1	17 NO RLY1
18	COM RLY1	18 COM RLY1
19	NC RLY1	19 NO RLY2
20	NC RLY2	20 COM RLY2
21	COM RLY2	21 NO RLY3
22	NO RLY2	22 COM RLY3
23	AC LINE	DC (+) POWER IN
24	AC LINE	DC (-)

Specify Power Input When Ordering.

Appendix C- RS-485 Modbus Protocol (continued)

Register & Coil Usage

Register Usage (each register is 2 bytes) **NOTE:** The Float data type follows the IEEE format for a 32 bit float.

<u>SUPERtrol II Data</u>	<u>Register</u>	<u>Data Type</u>
Heat Flow	Reg 40001 & 40002	Float
Mass Flow	Reg 40003 & 40004	Float
STD Volume Flow	Reg 40005 & 40006	Float
Volume Flow	Reg 40007 & 40008	Float
Temperature 1	Reg 40009 & 40010	Float
Temperature 2	Reg 40011 & 40012	Float
Delta Temperature	Reg 40013 & 40014	Float
Process Pressure	Reg 40015 & 40016	Float
Diff. Pressure	Reg 40017 & 40018	Float
Density	Reg 40019 & 40020	Float
Specific Enthalpy	Reg 40021 & 40022	Float
Heat Total	Reg 40023 & 40024	Float
Mass Total	Reg 40025 & 40026	Float
STDVolumeTotal	Reg 40027 & 40028	Float
Volume Total	Reg 40029 & 40030	Float
Heat Grand Total	Reg 40031 & 40032	Float
Mass Grand Total	Reg 40033 & 40034	Float
STDVolumeGrandTotal	Reg 40035 & 40036	Float
Volume Grand Total	Reg 40037 & 40038	Float
Alarm Point 1	Reg 40039 & 40040	Float
Alarm Point 2	Reg 40041 & 40042	Float
Alarm Point 3	Reg 40043 & 40044	Float
Year	Reg 40045	Integer
Month	Reg 40046	Integer
Day	Reg 40047	Integer
Hours	Reg 40048	Integer
Min	Reg 40049	Integer
Sec	Reg 40050	Integer
Peak Demand	Reg 40051 & 40052	Float
Demand Last	Reg 40053 & 40054	Float
Viscosity	Reg 40055 & 40056	Float
Abs. Viscosity	Reg 40057 & 40058	Float
Reserved	Reg 40059 & 40060	Float
Power Lost Hour	Reg 40061	Integer
Power Lost Min.	Reg 40062	Integer
Reserved	Reg 40063 & 40064	Float
Reserved	Reg 40065 & 40066	Float
Reserved	Reg 40067 & 40068	Float
Reserved	Reg 40069 & 40070	Float
Reserved	Reg 40071 & 40072	Float
Reserved	Reg 40073 & 40074	Float
Reserved	Reg 40075 & 40076	Float
Time base	Reg 40077	Integer
Heat Flow Units	Reg 40078	Integer
Mass Flow Units	Reg 40079	Integer
STD Flow Units	Reg 40080	Integer
Vol. Flow Units	Reg 40081	Integer
Temperature Units	Reg 40082	Integer
Pressure Units	Reg 40083	Integer
Density Units	Reg 40084	Integer
Heat Total Units	Reg 40085	Integer
Mass Total Units	Reg 40086	Integer

Appendix C- RS-485 Modbus Protocol (continued)

Register Usage (each register is 2 bytes)

<u>SUPERtrol II Data</u>	<u>Register</u>	<u>Data Type</u>
STD Total Units	Reg 40087	Integer
Vol. Total Units	Reg 40088	Integer
Definition of Barrel	Reg 40089	Integer
Specific Enthalpy Units	Reg 40090	Integer
Length Units	Reg 40091	Integer
Calibration trail	Reg 40092	Integer
Configuration trail	Reg 40093	Integer
Tag Number	Reg 40094	Integer
Peak Year	Reg 40095	Integer
Peak Month	Reg 40096	Integer
Peak Day	Reg 40097	Integer
Peak Hours	Reg 40098	Integer
Peak Min	Reg 40099	Integer
Unused	Reg 40100	Integer
Unused	Reg 40101 & 40102	Float
Unused	Reg 40103 & 40104	Float
Unused	Reg 40105 & 40106	Float
Unused	Reg 40107 & 40108	Float
Unused	Reg 40109 & 40110	Float
Unused	Reg 40111 & 40112	Float
Unused	Reg 40113 & 40114	Float
Unused	Reg 40115 & 40116	Float
Unused	Reg 40117 & 40118	Float
Unused	Reg 40119 & 40120	Float
Unused	Reg 40121 & 40122	Float
Unused	Reg 40123 & 40124	Float

COIL USAGE (each coil is 1 bit)

<u>SUPERtrol II Data</u>	<u>Coil</u>	<u>Data Type</u>
System Alarm Power Failure	Coil 00001	bit
System Alarm Watchdog	Coil 00002	bit
System Alarm Communication Error	Coil 00003	bit
System Alarm Calibration Error	Coil 00004	bit
System Alarm Print Buffer Full	Coil 00005	bit
System Alarm Totalizer Error	Coil 00006	bit
Sensor/Process Alarm Wet Steam Alarm	Coil 00007	bit
Sensor/Process Alarm Off Fluid Table	Coil 00008	bit
Sensor/Process Alarm Flow In Over Range	Coil 00009	bit
Sensor/Process Alarm Input 1 Over Range	Coil 00010	bit
Sensor/Process Alarm Input 2 Over Range	Coil 00011	bit
Sensor/Process Alarm Flow Loop Broken	Coil 00012	bit
Sensor/Process Alarm Loop 1 Broken	Coil 00013	bit
Sensor/Process Alarm Loop 2 Broken	Coil 00014	bit
Sensor/Process Alarm RTD 1 Open	Coil 00015	bit
Sensor/Process Alarm RTD 1 Short	Coil 00016	bit
Sensor/Process Alarm RTD 2 Open	Coil 00017	bit
Sensor/Process Alarm RTD 2 Short	Coil 00018	bit
Sensor/Process Alarm Pulse Out Overrun	Coil 00019	bit
Sensor/Process Alarm Iout 1 Out Of Range	Coil 00020	bit
Sensor/Process Alarm Iout 2 Out Of Range	Coil 00021	bit
Sensor/Process Alarm Relay 1 Hi Alarm	Coil 00022	bit

COIL USAGE (each coil is 1 bit)

<u>SUPERtrol II Data</u>	<u>Coil</u>	<u>Data Type</u>
Sensor/Process Alarm Relay 1 Lo Alarm	Coil 00023	bit
Sensor/Process Alarm Relay 2 Hi Alarm	Coil 00024	bit
Sensor/Process Alarm Relay 2 Lo Alarm	Coil 00025	bit
Sensor/Process Alarm Relay 3 Hi Alarm	Coil 00026	bit
Sensor/Process Alarm Relay 3 Lo Alarm	Coil 00027	bit
Service Test 24Vdc Out Error	Coil 00028	bit
Service Test Pulse In Error	Coil 00029	bit
Service Test Input 1 Vin Error	Coil 00030	bit
Service Test Input 1 Iin Error	Coil 00031	bit
Service Test Input 2 Iin Error	Coil 00032	bit
Service Test Input 2 RTD Error	Coil 00033	bit
Service Test Input 3 Iin Error	Coil 00034	bit
Service Test Input 3 RTD Error	Coil 00035	bit
Service Test Pulse Out Error	Coil 00036	bit
Service Test Iout 1 Error	Coil 00037	bit
Service Test Iout 2 Error	Coil 00038	bit
Service Test Relay 1 Error	Coil 00039	bit
Service Test Relay 2 Error	Coil 00040	bit
Service Test RS-232 Error	Coil 00041	bit
Self Test A/D Malfunction	Coil 00042	bit
Self Test Program Error	Coil 00043	bit
Self Test Setup Data Lost	Coil 00044	bit
Self Test Time Clock Lost	Coil 00045	bit
Self Test Display Malfunction	Coil 00046	bit
Self Test Ram Malfunction	Coil 00047	bit
Language Select	Coil 00048	bit Write
Reset Totalizers	Coil 00049	bit Write with Caution
Reset All Error Codes	Coil 00050	bit Write
Reset Alarm 1	Coil 00051	bit Write
Reset Alarm 2	Coil 00052	bit Write
Reset Alarm 3	Coil 00053	bit Write
Print Transaction Document	Coil 00054	bit Write
Reset Peak Demand	Coil 00055	bit Write
Reset Accumulated Power Loss	Coil 00056	bit Write
Aux. Status Input	Coil 00057	bit
Reserved	Coil 00058	bit
Reserved	Coil 00059	bit
Reserved	Coil 00060	bit
Reserved	Coil 00061	bit
Reserved	Coil 00062	bit
Flowmeter Location	Coil 00063	bit
Unused	Coil 00064	bit

WARRANTY

This product is warranted against defects in materials and workmanship for a period of two (2) years from the date of shipment to Buyer.

The Warranty is limited to repair or replacement of the defective unit at the option of the manufacturer. This warranty is void if the product has been altered, misused, dismantled, or otherwise abused.

ALL OTHER WARRANTIES, EXPRESSED OR IMPLIED, ARE EXCLUDED, INCLUDING BUT NOT LIMITED TO THE IMPLIED WARRANTIES OF MERCHANTABILITY AND FITNESS FOR A PARTICULAR PURPOSE.

DECODING PART NUMBER

Example	ST2	L	1	0	P	10
Series: _____	_____	_____	_____	_____	_____	_____
ST2 = Flow Computer						
Display Type: _____	_____	_____	_____	_____	_____	_____
L = LCD						
O = OLED						
V = VFD						
Input Type: _____	_____	_____	_____	_____	_____	_____
1 = 85 to 276 VAC						
3 = 24 VDC						
Network Card: _____	_____	_____	_____	_____	_____	_____
0 = None						
1 = RS-485/Modbus						
Mounting: _____	_____	_____	_____	_____	_____	_____
P = Panel Mount						
N = NEMA 4 Wall Mount						
W = NEMA 12/13 Wall Mount w/ Clear Cover						
E = Explosion Proof (No Button Access)						
Options: _____	_____	_____	_____	_____	_____	_____
1 = Peak Demand						
2 = AGA NX-19 calculation for natural gas						
3 = Three Relays						
4 = Stacked DP option						
5 = Datalogger option						
6 = Stack Emissions Controller option						
7 = Manifold Flowmeter Controller option						
9 = 3 Relay Super Chip (options 1, 2, 4, 6,7)						
10 = 2 Relay Super Chip (options 1, 2, 4, 6,7)						
13 = Superchip; 2 relay, Positive heat only						
14 = Superchip; 3 relay, Positive heat only						
Accessories:						
KEPS-KEP1-32 = 32 Bit OPC/DDE Server for KEP RS-232 Protocol						
KEPS-MBS-32 = 32 Bit Modbus RTU OPC/DDE server						
MPP200N = Industrial Wall Mount Modem						
P1000 = Hand Held Printer						
CA-285 = RS-232 to RS-485 Converter						



KESSLER-ELLIS PRODUCTS

10 Industrial Way East
Eatontown, NJ 07724

800-631-2165 • 732-935-1320

Fax: 732-935-9344

www.kep.com