

---

**User's  
Manual**

**Model IR200  
Infrared Gas Analyzer**

IM 11G02M01-01E

---

**vigilantplant.<sup>®</sup>**

# PREFACE

We are grateful for your purchase of Yokogawa's Infrared Gas Analyzer, Model: IR200.

- First read this instruction manual carefully until an adequate understanding is acquired, and then proceed to installation, operation and maintenance of the analyzer. Wrong handling may cause an accident or injury.
- The specifications of this analyzer are subject to change without prior notice for further product improvement.
- Modification of this analyzer is strictly prohibited unless a written approval is obtained from the manufacturer. Yokogawa will not bear any responsibility for a trouble caused by such a modification.
- This instruction manual shall be stored by the person who actually uses the analyzer.
- After reading the manual, be sure to store it at a place easier to access.
- This instruction manual should be delivered to the end user without fail.

The related documents are as follows.

General Specifications: GS 11G02M01-01E

User's Manual:	IM 11G02M01-01E	(this manual)
	IM 11G02P01-01E	Communication Functions (MODBUS)
	IM 11G00E01-01EN	ZX8D Zirconia Oxygen Analyzer

The "E" or "EN" in the document number is the language code.

Manufacturer: Yokogawa Electric Corporation

Type: Described in Yokogawa's company nameplate on main frame

Date of manufacture: Described in Yokogawa's company nameplate on main frame

Product nationality: Japan

## Request

- It is prohibited to transfer part or all of this manual without Yokogawa's permission in written format.
- Description in this manual is subject to change without prior notice for further improvement.

## ■ For the safe use of this equipment



### WARNING

---

---

- This unit is not explosion-proof type. Do not use it in a place with explosive gases to prevent explosion, fire or other serious accidents.

In piping, the following precautions should be observed.

Wrong piping may cause gas leakage.

If the leaking gas contains a toxic component, there is a risk of serious accident being induced.

Also, if combustible gas is contained, there is a danger of explosion, fire or the like occurring.

- Connect pipes correctly referring to the instruction manual.
  - Exhaust should be led outdoors so that it will not remain in the locker and installation room.
  - Exhaust from the analyzer should be relieved in the atmospheric air in order that an unnecessary pressure will not be applied to the analyzer. Otherwise, any pipe in the analyzer may be disconnected to cause gas leakage.
  - For piping, use a pipe and a pressure reducing valve to which oil and grease are not adhering. If such a material is adhering, a fire or the like accident may be caused.
- For correct handling of calibration gas or other reference gases, carefully read their instruction manuals beforehand.  
Otherwise, carbon monoxide or other hazardous gases may cause an intoxication particularly.
  - When doors are open during maintenance or inspection, be sure to purge sufficiently the inside of the gas analyzer as well as the measuring gas line with nitrogen or air, in order to prevent poisoning, fire or explosion due to gas leak.
- 
-



## CAUTION

---

- For installation, observe the rule on it given in the instruction manual and select a place where the weight of gas analyzer can be endured.  
Installation at an unsuited place may cause turnover or fall and there is a risk of injury.
  - For lifting the gas analyzer, be sure to wear protective gloves.  
Bare hands may invite an injury.
  - Before transport, fix the casing so that it will not open. Otherwise, the casing may be separated and fall to cause an injury.
  - During installation work, care should be taken to keep the unit free from cable chips or other foreign objects. Otherwise, it may cause fire, trouble or malfunction of the unit.
  - Wiring work must be performed with the main power set to OFF to prevent electric shocks.
  - Enforce construction of class-D grounding wire by all means.  
If the specified grounding construction is neglected, a shock hazard or fault may be caused.
  - Wires should be the proper one meeting the ratings of this instrument. If using a wire which cannot endure the ratings, a fire may occur.
  - Be sure to use a power supply of correct rating. Connection of power supply of incorrect rating may cause fire.
  - Before leaving unused for a long time or restarting after left at such a status for an extended length of time, follow the directions of each instruction manual because they are different from normal starting or shutdown. Otherwise, the performance may be poor and accidents or injuries may be caused.
  - Do not operate the analyzer for a long time with its door left open. Otherwise, dust, foreign matter, etc. may stick on internal walls, thereby causing faults.
- Be sure to observe the following for safe operation avoiding the shock hazard and injury.
- Remove the watch and other metallic objects before work.
  - Do not touch the instrument wet-handed.
  - If the fuse is blown, eliminate the cause, and then replace it with the one of the same capacity and type as before. Other wise, shock hazard or fault may be caused.
  - Do not use a replacement part other than specified by the instrument maker. Otherwise, adequate performance will not be provided. Besides, an accident or fault may be caused.
  - Replacement parts such as a maintenance part should be disposed of as incombustibles. For details, follow the local ordinance.
- If the cause of any fault cannot be determined despite reference to the instruction manual, be sure to contact your dealer or Fuji Electric's technician in charge of adjustment. If the instrument is disassembled carelessly, you may have a shock hazard or injury.
  - Do not use the supplied power cord with another device.
- 



## NOTE

---

- Do not allow metal, finger or others to touch the input/output terminals in the instrument. Otherwise, shock hazard or injury may occur.
  - Do not smoke nor use a flame near the gas analyzer. Other wise, a fire may be caused.
  - Do not allow water to go into the gas analyzer. Otherwise, hazard shock or fire in the instrument may be caused.
-





---

## ■ Product Disposal

The instrument should be disposed of in accordance with local and national legislation/regulations.

## ■ Authorized Representative in EEA

The Authorized Representative for this product in EEA is Yokogawa Europe B.V. (Euroweg 2, 3825 HD Amersfoort, The Netherlands).

---

## ◆ After-Sales Warranty

- **Do not modify the product.**
  
- **Yokogawa warrants the product for the period stated in the pre-purchase quotation. Yokogawa shall conduct defined warranty service based on its standard. When the customer site is located outside of the service area, a fee for dispatching the maintenance engineer will be charged to the customer.**
  
- **During the warranty period, for repair under warranty carry or send the product to the local sales representative or service office. Yokogawa will replace or repair any damaged parts and return the product to you.**
  - Before returning a product for repair under warranty, provide us with the model name and serial number and a description of the problem. Any diagrams or data explaining the problem would also be appreciated.
  - If we replace the product with a new one, we won't provide you with a repair report.
  
- **In the following cases, customer will be charged repair fee regardless of warranty period.**
  - Failure of components which are out of scope of warranty stated in instruction manual.
  - Failure caused by usage of software, hardware or auxiliary equipment, which Yokogawa did not supply.
  - Failure due to improper or insufficient maintenance by user.
  - Failure due to misoperation, misuse or modification which Yokogawa does not authorize.
  - Failure due to power supply (voltage, frequency) being outside specifications or abnormal.
  - Failure caused by any usage out of scope of recommended usage
  - Any damage from fire, earthquake, a storm and flood, lightning, disturbance, riot, warfare, radiation and other natural changes.
  
- **Yokogawa does not warrant conformance with the specific application at the user site. Yokogawa will not bear direct/indirect responsibility for damage due to a specific application.**
  
- **Yokogawa will not bear responsibility when the user configures the product into systems or resells the product.**
  
- **Maintenance service and supplying repair parts will be covered for five years after the production ends. For repair this product, please contact the nearest sales office described in this instruction manual.**

# Model IR200 Infrared Gas Analyzer

IM 11G02M01-01E 4th Edition

## CONTENTS

PREFACE .....	i
◆ After-Sales Warranty .....	vi
1. OVERVIEW .....	1-1
2. NAME AND DESCRIPTION OF EACH UNIT .....	2-1
3. INSTALLATION .....	3-1
3.1 Selection of installation location.....	3-1
3.2 Installation of analyzer .....	3-2
3.3 Piping .....	3-2
3.4 Sampling .....	3-3
3.5 Wiring method.....	3-6
4. OPERATION .....	4-1
4.1 Preparation for operation.....	4-1
4.2 Warm-up operation and regular operation.....	4-1
5. DESCRIPTION OF DISPLAY AND OPERATION PANELS .....	5-1
5.1 Name and description of operation panel.....	5-1
5.2 Overview of display and operation panels.....	5-2
5.3 Overview of display screen .....	5-3
5.4 General operation .....	5-6
6. SETTING AND CALIBRATION .....	6-1
6.1 Changeover of range .....	6-1
6.2 Calibration setting .....	6-2
6.2.1 Setting of calibration concentration.....	6-2
6.2.2 Setting of calibration gas.....	6-4
6.2.3 Setting of manual zero calibration .....	6-6
6.2.4 Setting of calibration range .....	6-8
6.2.5 Setting of auto-calibration component.....	6-10
6.3 Alarm setting .....	6-12
6.3.1 Setting of alarm values .....	6-12
6.3.2 Hysteresis setting.....	6-14
6.4 Setting of auto calibration.....	6-15
6.4.1 Auto calibration .....	6-15
6.4.2 Forced run/stop of auto calibration .....	6-17
6.5 Setting of auto zero calibration .....	6-19

6.5.1	Auto zero calibration .....	6-19
6.5.2	Forced run/stop of auto zero calibration .....	6-21
<b>6.6</b>	<b>Peak alarm setting .....</b>	<b>6-23</b>
<b>6.7</b>	<b>Parameter setting.....</b>	<b>6-25</b>
<b>6.8</b>	<b>Maintenance mode .....</b>	<b>6-29</b>
<b>6.9</b>	<b>Calibration .....</b>	<b>6-32</b>
6.9.1	Zero calibration .....	6-32
6.9.2	Span calibration .....	6-33
<b>7.</b>	<b>MAINTENANCE.....</b>	<b>7-1</b>
7.1	Daily check .....	7-1
7.2	Daily check and maintenance procedures.....	7-1
7.3	Replacement of power fuse .....	7-2
7.4	Moisture interference compensation adjustment.....	7-3
7.5	Cleaning of measuring cell .....	7-4
7.5.1	Disassembly and assembly of measuring cell.....	7-4
7.5.2	How to clean cell .....	7-9
7.6	Inspection and maintenance of limited service-life components .....	7-9
<b>8.</b>	<b>TROUBLE SHOOTING .....</b>	<b>8-1</b>
8.1	Error message.....	8-1
8.2	Other troubleshooting.....	8-3
<b>9.</b>	<b>SPECIFICATIONS .....</b>	<b>9-1</b>
9.1	Specifications.....	9-1
9.2	Model and Suffix codes.....	9-8
9.3	External Dimensions .....	9-13
	<b>Customer Maintenance Parts List.....</b>	<b>CMPL 11G02M01-01E</b>
	<b>Revision Information .....</b>	<b>i</b>

---

# 1. OVERVIEW

The infrared gas analyzer (IR200) measures the concentrations of CO<sub>2</sub>, CO, CH<sub>4</sub>, SO<sub>2</sub>, NO and O<sub>2</sub> contained in sample gas.

CO<sub>2</sub>, CO, CH<sub>4</sub>, SO<sub>2</sub>, and NO are measured by non-dispersion infrared method, while O<sub>2</sub> is measured by paramagnetic or fuel cell method. Up to 4 components including O<sub>2</sub> (3 at the maximum for measurement of components other than O<sub>2</sub>) can be measured simultaneously.

A high-sensitivity mass flow sensor is used in the detector unit of infrared method. Due to use of single beam system for measurement, maintenance is easy and an excellent stability is ensured for a long period of time.

In addition, a microprocessor is built in and a large sized liquid crystal display is provided for easier operation, higher accuracy and more functions.

This analyzer is thus optimum for combustion control of various industrial furnaces, botanical study and global atmospheric research.

---

Blank Page

# 2. NAME AND DESCRIPTION OF EACH UNIT

## ■ Description of each unit

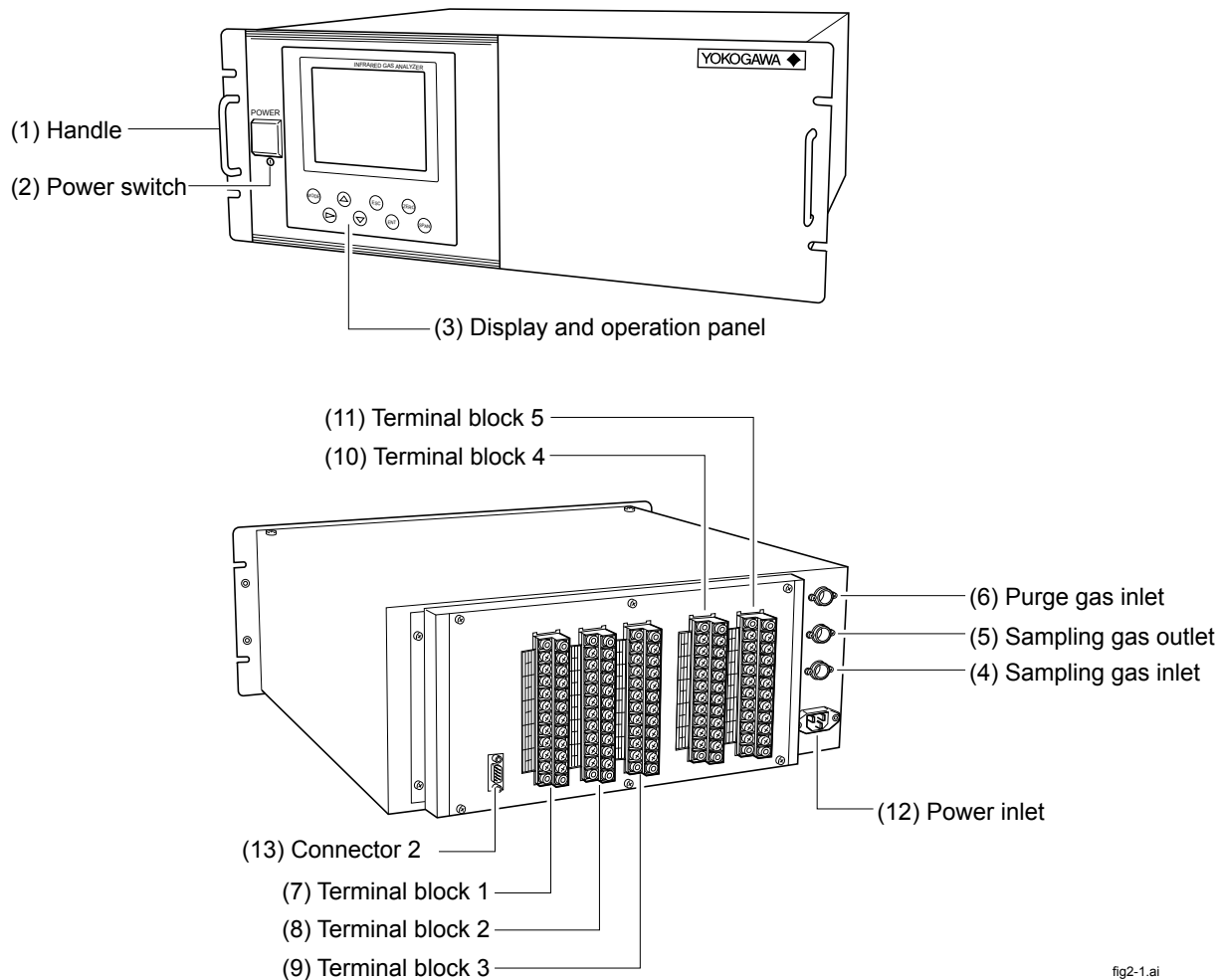

fig2-1.ai

Name	Description
(1) Handle	Draws the analyzer unit from the case.
(2) Power switch	Turns ON/OFF this analyzer.
(3) Display/Operation panel	Liquid crystal display and keys for various operational settings are arranged.
(4) Sampling gas inlet	Port for connecting the sample gas injection pipe
(5) Sampling gas outlet	Port for connecting the pipe for discharging the gas after analysis
(6) Purge gas inlet	Port for connecting the purge gas pipe
(7) Terminal block 1	Analog output terminals
(8) Terminal block 2	O <sub>2</sub> analyzer signal and contact input terminals
(9) Terminal block 3	Contact input/output terminals
(10) Terminal block 4	Contact output terminal
(11) Terminal block 5	Alarm output terminal
(12) Power inlet	Used to connect the power cable.
(13) Connector for communication	Used to connect the communication cable.

**Fig. 2-1 Name and description of each unit**



---

Blank Page

## 3. INSTALLATION

### WARNING

---

---

This unit is Non-Explosion-proof type. Do not use it in a place with explosive gases to prevent explosion, fire or other serious accidents.

---

---

### CAUTION

- 
- For installation, observe the rule on it given in the instruction manual and select a place where the weight of gas analyzer can be endured.  
Installation at an unsuited place may cause turnover or fall and there is a risk of injury.
  - For lifting the gas analyzer, be sure to wear protective gloves. Bare hands may invite an injury.
  - Before transport, fix the casing so that it will not open. Otherwise, the casing may be separated and fall to cause an injury.
  - The gas analyzer is heavy. It should be transported carefully by two or more persons if manually required. Otherwise, body may be damaged or injured.
  - During installation work, care should be taken to keep the unit free from cable chips or other foreign objects. Otherwise, it may cause fire, trouble or malfunction of the unit.
- 

### 3.1 Selection of installation location

To install the analyzer for optimum performance, select a location that meets the following conditions;

- (1) Use this instrument indoors.
- (2) A vibration-free place
- (3) A place which is clean around the analyzer.
- (4) Power supply
  - Voltage rating ; 100 V AC to 240 V AC
  - Allowable range ; 85 to 264 V AC
  - Frequency ; 50 Hz / 60 Hz
  - Power consumption; 70 VA max.
  - Inlet ; Conform to EN60320  
Protection Class I
- (5) Operation conditions
  - Ambient temperature : -5 to 45°C
  - Ambient humidity : 90%RH or less, no condensation

### 3.2 Installation of analyzer

There are two methods of installing the analyzer.  
 For detailed dimensions, see Chapter 9.3.

(Unit:mm)

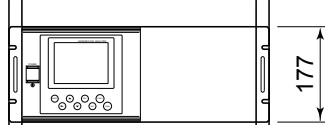
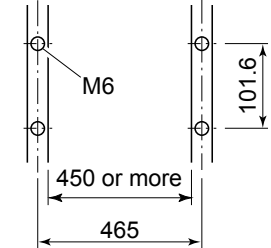
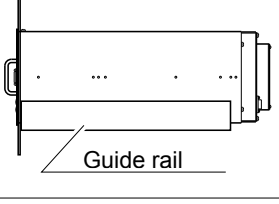
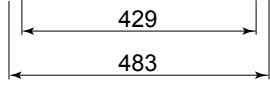
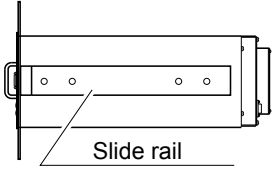
Types	External dimensions	Mounting dimensions	Mounting method
19 inch rack mounting (Note)			
			

Note 1 The mounting method should be selected to meet the installation requirements since the top cover must be detached from the gas analyzer for maintenance and check.

Mounting method	Conditions	Remarks
Slide rail	No maintenance space is provided at the top.	These methods must be rigid enough to withstand the mass (about 10 kg) of the gas analyzer.
Guide rail	Maintenance space is provided at the top.	

Recommended slide rail: 305A-20, Accuride International Inc.

### 3.3 Piping

#### CAUTION

In piping, the following precautions should be observed.

**Wrong piping may cause gas leakage.**

**If the leaking gas contains a toxic component, there is a risk of serious accident being induced.**

**Also, if combustible gas is contained, there is a danger of explosion, fire or the like occurring.**

- Connect pipes correctly referring to the instruction manual.
- Exhaust should be led outdoors so that it will not remain in the locker and installation room.
- Exhaust from the analyzer should be relieved in the atmospheric air in order that an unnecessary pressure will not be applied to the analyzer. Otherwise, any pipe in the analyzer may be disconnected to cause gas leakage.
- For piping, use a pipe and a pressure reducing valve to which oil and grease are not adhering. If such a material is adhering, a fire or the like accident may be caused.

Observe the following when connecting the gas pipes.

- The pipes should be connected to the gas inlet and outlet at the rear panel of the analyzer, respectively.
- Connect the sampling system to the instrument by using corrosion-resistant tube such as Teflon, stainless steel, or polyethylene. In case where there is no danger of corrosion, don't use rubber or soft vinyl tube. Analyzer indication may become inaccurate due to the adsorption of gases.
- Piping connections are Rc1/4 (1/4 NPT) female-threaded. Cut the pipe as short as possible for quick response. Pipe of  $\varnothing 4$  mm (inside diameter) is recommendable.
- Entry of dust in the instrument may cause operation fault. Use clean pipes and couplings.

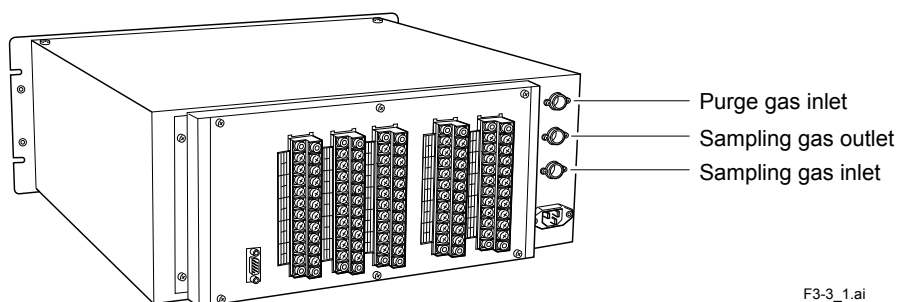

F3-3\_1.ai

**Fig. 3-1 Piping**

- Sampling gas inlet:** Connect the pipe so that zero/span calibration standard gas or measured gas pretreated with dehumidification is supplied properly. The gas flow rate should be kept constant within the range of  $1 \pm 0.5$  L/min.
- Sampling gas outlet:** Measured gas is exhausted after measurement. Connect the pipe so that the gas may escape through the gas outlet into the atmosphere.
- Purge gas inlet:** It is used for purging the inside of the total gas analyzer. When the analyzer must be purged, refer to Item 3.4, Purging inside Analyzer. Use dry gas  $N_2$  or instrumentation air for purge gas. (flow rate of 1 L/min or more should be used and no dust or mist is contained).

## 3.4 Sampling

### (1) Conditions of sampling gas

1. The dust contained in sample gas should be eliminated completely with filters. The filter at the final stage should be capable of eliminating dust of 0.3 microns.
2. The dew point of sample gas must be lower than the ambient temperature for preventing formation of drain in the analyzer. If water vapor is contained in sample gas, its dew point should be reduced down to about  $0^\circ\text{C}$  through a dehumidifier.
3. If  $\text{SO}_3$  mist is contained in sample gas, the mist should be eliminated with a mist filter, cooler, etc. Eliminate other mist in the same way.
4. If a large amount of highly corrosive gas such as  $\text{Cl}_2$ ,  $\text{F}_2$  or  $\text{HCl}$  is contained in sample gas, the service life of analyzer will be shortened. So, avoid such gases.
5. Sample gas temperature is allowed within a range from 0 to  $50^\circ\text{C}$ . Pay attention not to flow hot gas directly into the analyzer.

**(2) Sampling gas flow**

A flow rate of sampling gas must be  $1 \pm 0.5$  L/min. A flow meter should be provided as shown in Fig. 3-2 to measure flow rate values.

**(3) Preparation of standard gas**

Prepare the standard gas for zero/span calibration.

	Without O <sub>2</sub> Analyzer	Built-in O <sub>2</sub> Analyzer	Externally mounted zirconia O <sub>2</sub> Analyzer
Zero gas	N <sub>2</sub> gas	N <sub>2</sub> gas	Dry air, air or gas in concentration of 80% or higher of the O <sub>2</sub> range (CO <sub>2</sub> should not be contained in zero gas if CO <sub>2</sub> meter is provided.)
Span gas except for O <sub>2</sub>	Gas with concentration of 90% or more of full scale	Gas with concentration of 90% or more of full scale	Gas with concentration of 90% or more of full scale
Span gas for O <sub>2</sub>		Gas with concentration of 90% or more of full scale or atmospheric air (21%)	1 to 2% O <sub>2</sub> gas

\* We recommend you to feed the zero gas shown above by humidifying it, if NO or SO<sub>2</sub> is included in components to be analyzed.

(Note)

It is understood to influence the calibration model of the infrared gas analyzer when a lot of H<sub>2</sub>, He, and Ar are included in the measurement gas (pressure broadening).

The span gas must use a gas near the composition of the measurement gas when you measure the gas like the above-mentioned.

**(4) Reduction of moisture interference**

NO and SO<sub>2</sub> measurement is subject to moisture interference.

As shown by the configuration example on the next page, provide a device for humidifying zero calibration gas, thus controlling the moisture content at a constant level (moisture content in sample gas should also be controlled here) in configuring a sampling system. That allows the same moisture content as in the case of measurement to be contained in zero gas for calibration.

**(5) Purging of instrument inside**

The inside of instrument need not be purged generally except for the following cases.

1. A combustible gas component is contained in sample gas.
2. Corrosive gas is contained in the atmospheric air at the installation site.
3. The same gas as the sample gas component is contained in the atmospheric air at the installation site.

In such cases as above, the inside of analyzer should be purged with the air for instrumentation or N<sub>2</sub>. Purging flow rate should be about 1 L/min.

If dust or mist is contained in purging gas, it should be eliminated completely in advance.

**(6) Pressure at sampling gas outlet**

Pressure at the sampling gas outlet should be adjusted to atmospheric pressure.

**(7) Example configuration of gas sampling system**

The system configuration may vary depending upon the nature of measured gas, coexistent gases or application. A typical configuration diagram is shown in Fig. 3-2. Since a system configuration depends upon measured gas, consult with Yokogawa.

Measurement of sample gas with low moisture content (room-temperature saturation level or below):  
CO, CO<sub>2</sub> and CH<sub>4</sub> measurement

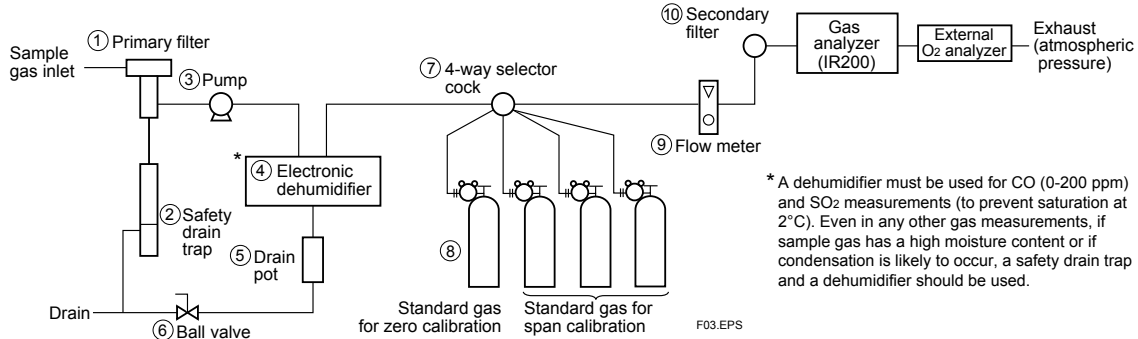

When NO or SO<sub>2</sub> is included in components to be analyzed  
When measurement range of CO meter is 0 to 200 ppm  
When condensation may occur due to excessive moisture content in measured gas

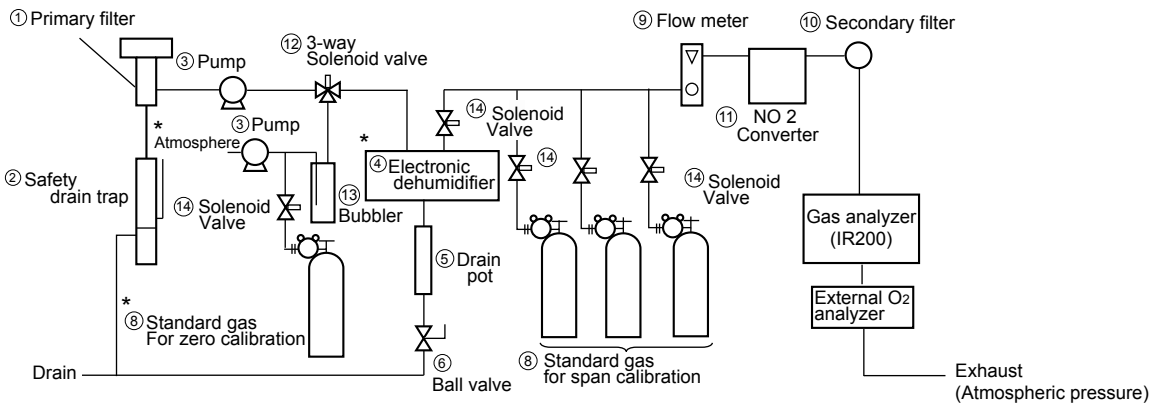

\* A dehumidifier must be used for NO, SO<sub>2</sub>, and CO (0-200 ppm) measurements (to prevent Saturation at 2°C). Use either atmospheric air or cylinder gas as a zero calibration gas and Supply it through a bubbler (humidifying) to reduce interference of water.

No.	Item	Description
①	Primary filter (mist filter)	Remove dust and mist
②	Safety drain trap	Separate and discharges drain
③	Pump	Suck in sample gas
④	Electronic dehumidifier	Dehumidify sample gas
⑤	Drain pot	Collect discharged water from dehumidifier
⑥	Ball valve	Used for discharging drain
⑦	4-way selector cock	Used for switching sampling and calibration lines
⑧	Standard gas for calibration	Used for zero/span calibration
⑨	Flow meter	Adjust and monitor sample gas flow rate
⑩	Secondary filter (membrane filter)	Remove fine dust
⑪	NO <sub>2</sub> /NO converter	Convert NO <sub>2</sub> gas into NO gas
⑫	3-way solenoid valve	Used for introducing humidified gas
⑬	Bubbler	Humidify calibration gas
⑭	Solenoid valve	Used for switching sampling and calibration lines

T03.EPS

**Fig. 3-2 A typical example of sampling system**

## 3.5 Wiring method

### CAUTION

- Wiring work must be performed with the main power set to OFF to prevent electric shocks.
- Enforce construction of class-D grounding wire by all means, 100  $\Omega$  or less.  
If the specified grounding construction is neglected, a shock hazard or fault may be caused.
- Wires should be the proper one meeting the ratings of this instrument. If using a wire which cannot endure the ratings, a fire may occur.
- Be sure to use a power supply of correct rating. Connection of power supply of incorrect rating may cause fire.

Each external terminal is provided on the rear panel of the analyzer. (See Fig. 3-3)  
Wire each terminal, referring to Fig. 3-3 and (1) to (7).

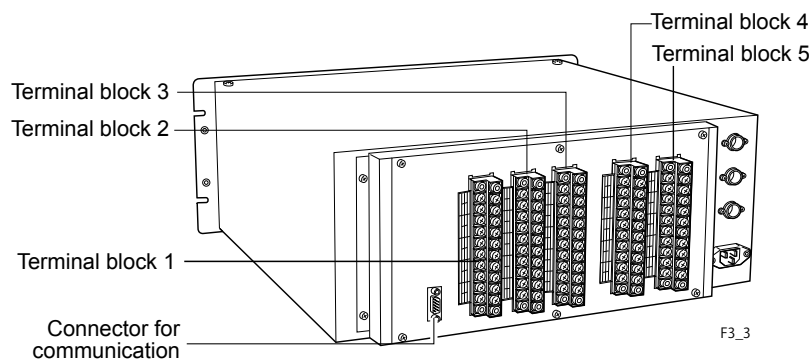

Fig. 3-3

#### (1) Power inlet

When using supplied power cable, connect the female side to the power inlet at the rear panel of the analyzer, and insert the male side into a receptacle matching the rating.

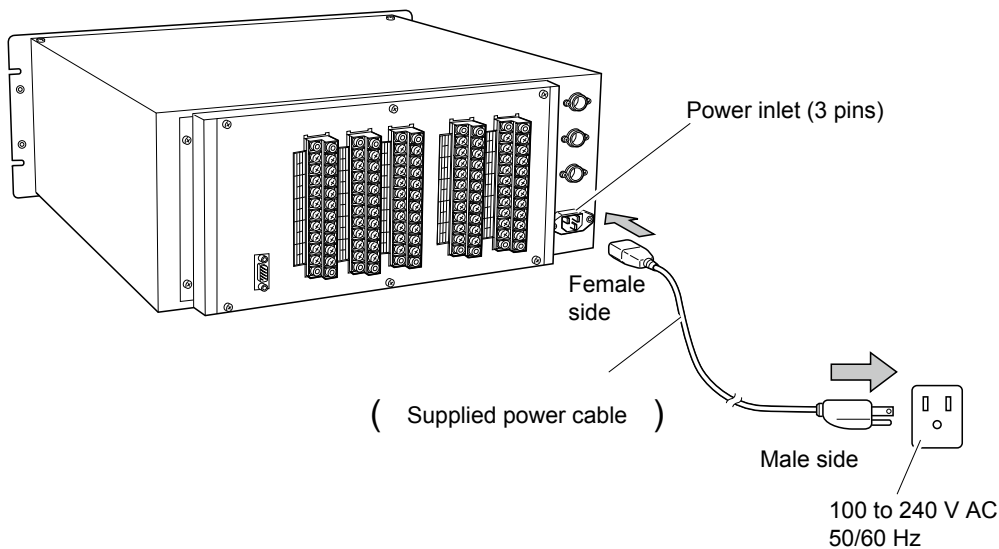
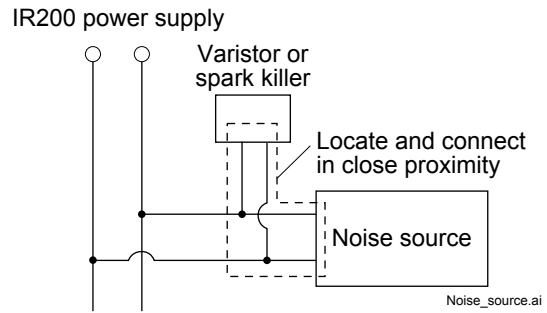

Fig. 3-4

When noise source is in the vicinity

Do not install the instrument near an electric device that generates noise from the power supply (such as high-frequency furnace and electric welder). If there is no other choice but to install it near such devices, provide completely separate power line to eliminate noise. In case noise may enter from a relay, solenoid valve, etc. through power supply, connect a varistor or spark killer to the noise source as shown below. If the varistor or spark killer is located away from the noise source, no effect is obtainable. So, locate near the noise source.



**(2) Analog output signal (AO):** terminal block 1, ① to ⑩, ⑮ to ⑳ .

Output signal: 4 to 20 mA DC or 0 to 1 V DC (selected when ordering)  
Non-insulated output

Allowable load: 4 to 20 mA DC, 550 Ω or less  
0 to 1 V DC, 100 kΩ or more

- Analog output is provided from each terminal corresponding to the channel displayed in the measurement screen.



**NOTE**

All of analog output signals for the instrument are not isolated. It is recommended to isolate signals individually to prevent interference from unnecessary signals or to prevent external interference, especially leading the cable of more than 30 meters or to outdoor.

**(3) O<sub>2</sub> sensor input:** Terminal block 2 , ① to ② .

Input signal:

External zirconia O<sub>2</sub> analyzer: Zirconia O<sub>2</sub> sensor signal (ZX8D\* C output)  
External O<sub>2</sub> analyzer: 0 to 1 V DC (DC input resistor of 1 MΩ or more)

- It is used when the external zirconia O<sub>2</sub> analyzer or external O<sub>2</sub> analyzer is specified as order.
- To connect to the output of the external Zirconia analyzer or external O<sub>2</sub> analyzer prepared separately.
- In case of an external O<sub>2</sub> analyzer, input a signal of 0 to 1 V DC with respect to O<sub>2</sub> full scale of the analyzer.
- In case of built-in O<sub>2</sub> analyzer, do not use the terminals.



**NOTE**

O<sub>2</sub> sensor input is not isolated. It is recommended to isolate when an external O<sub>2</sub> analyzer is installed apart from this analyzer. Zirconia O<sub>2</sub> sensor (ZX8D) should be installed at a location that is as close to this instrument as possible.



**(4) Contact input (DI):** Terminal block 2, ⑬ to ⑳, Terminal block 3, ⑤ to ⑩.

- It is for a contact input at no voltage. An input is provided when switching to short circuit (on) or open (off).
- No voltage is applied to the terminals.

**(5) Contact input (DO):** Terminal block 3, ⑬ to ⑳, Terminal block 4 and terminal block 5.

- Contact rating: 250 V AC/2 A, load resistance.
- An output is for a relay contact output. An input is provided when switching to short circuit (on) or open (off).



## NOTE

---

The wires of analog output signals, O<sub>2</sub> sensor input and contact input should be fixed separately from power supply wiring and contact output wiring.

---

**(6) Communication interface:** connector for communication (RS-232C interface)

- Please refer to the manual (IM 11G02P01-01E) about communication function.

(7) List of terminal blocks 1 to 5

Terminal block 1  
<TN1>

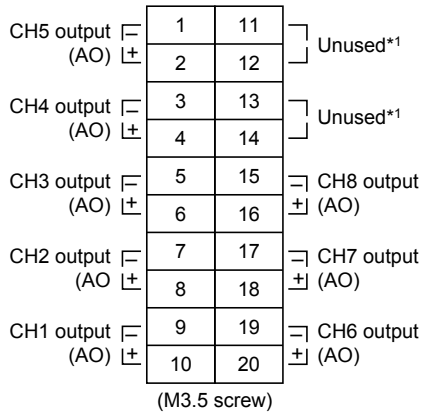

Terminal block 2  
<TN2>

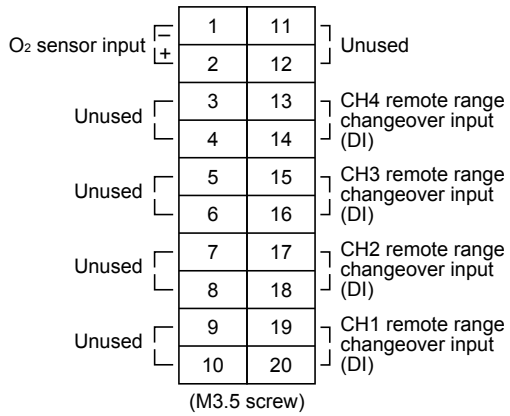

Terminal block 3  
<TN3>

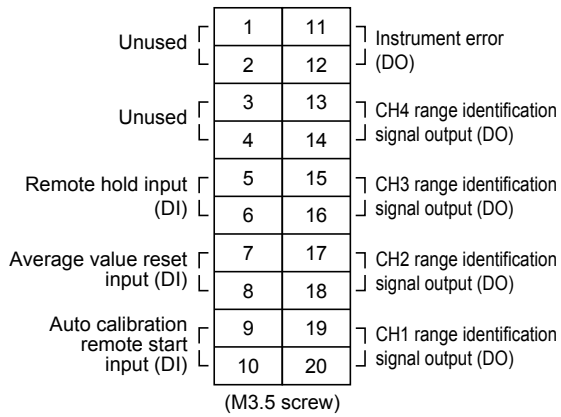

Terminal block 4  
<TN4>

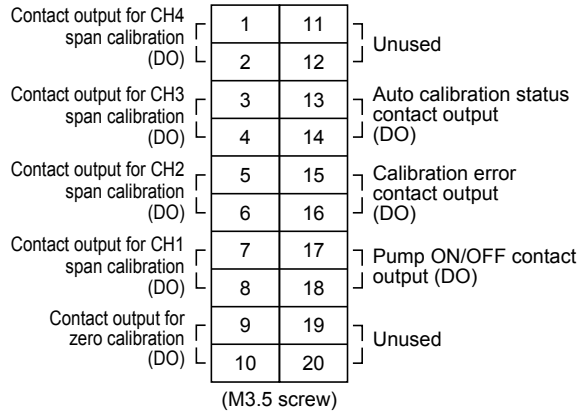

Terminal block 5  
<TN5>

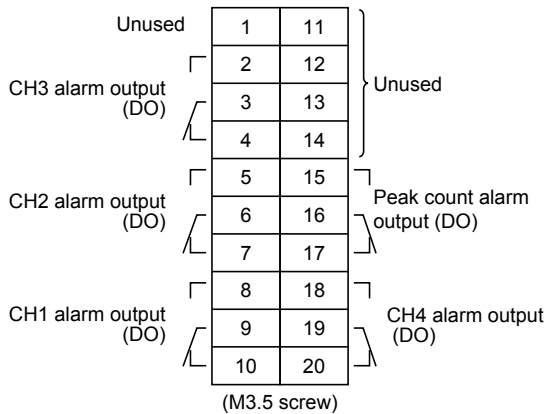

- \*1) Unused terminals are used for internal connection. So they should not be used as repeating terminals either.
- \*2) O<sub>2</sub> sensor input is used when an external O<sub>2</sub> analyzer is selected.

Terminal\_ail.ai

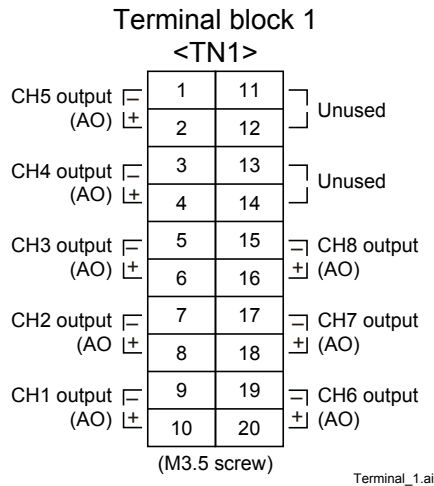
**(8) Description on terminal block****Terminal block 1 <TN1>**

Terminal block for analog output (non-isolated output)

Output : 4 to 20 mA or 0 to 1 V DC

Between 1–2: Ch5 output

Between 3–4: Ch4 output

Between 5–6: Ch3 output

Between 7–8: Ch2 output

Between 9–10: Ch1 output

Between 11 to 14: For internal connection.

Must not be wired. (Must not be used as junction terminal.)

Between 15–16: Ch8 output

Between 17–18: Ch7 output

Between 19–20: Ch6 output

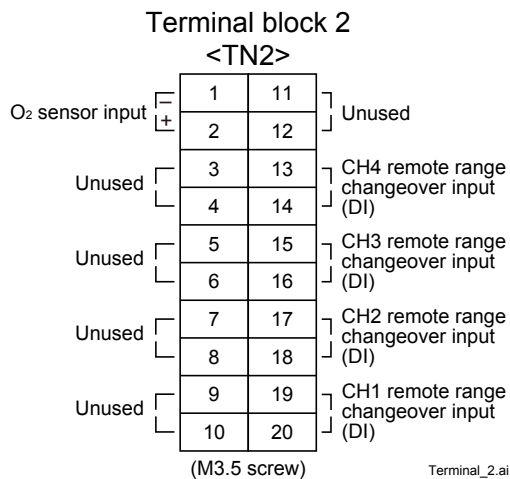
**Terminal block 2 <TN2>**

Between 1–2: For O<sub>2</sub> sensor input (Input for our Zirconia oxygen sensor or external O<sub>2</sub> sensor. Must not be used unless O<sub>2</sub> meter is added.)

Between 3 to 12 : For internal connection. Must not be wired. (Must not be used as junction terminal.)

Between 13–14: Ch4 remote range switch input

Between 15–16: Ch3 remote range switch input

Between 17–18: Ch2 remote range switch input

Between 19–20: Ch1 remote range switch input

Note) High range is selected when open. Low range is selected when short-circuited.

For details of action, refer to “6.1 Changeover of range”.

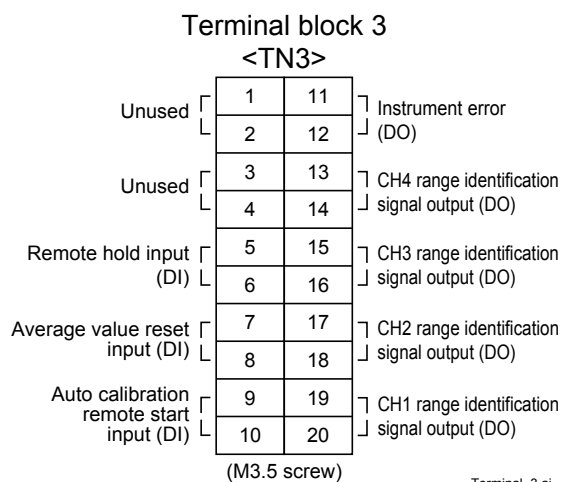

**Terminal block 3 <TN3>**

- Between 1 to 4: For internal connection. Must not be wired. (Must not be used as junction terminal.)
  - Between 5–6: Remote hold input. No hold when open. Output hold when short-circuited.
  - Between 7–8: Average value reset input. Short-circuiting the contact input (for at 1.5 sec. or more.) resets O<sub>2</sub> average and O<sub>2</sub> corrected average simultaneously. Opening it restarts the average value.
  - Between 9–10: Automatic calibration remote start input. Open input after strapping for at least 1.5 seconds starts the automatic calibration whether automatic calibration setting is ON or OFF.  
  
For details, refer to “Item 6.4 Setting of auto calibration”
  - Between 11–12: Conductive when analyzer unit error is produced. Normally open.
  - Between 13–14: CH4 range identification signal output
  - Between 15–16: CH3 range identification signal output
  - Between 17–18: CH2 range identification signal output
  - Between 19–20: CH1 range identification signal output
- Note) Range identification signal is conductive at Low range or open at High range. In case of 1-range system, the signal remains open.

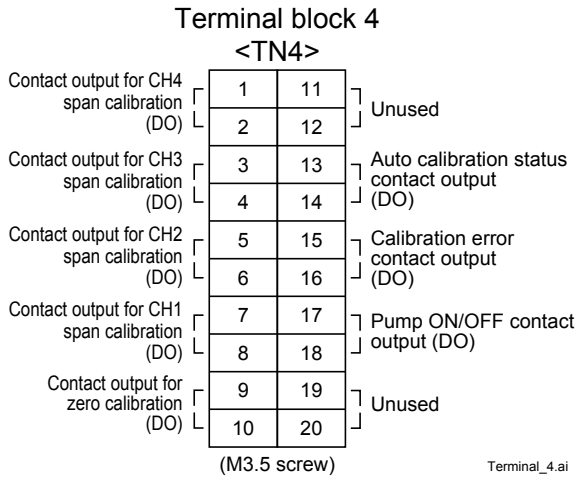
**Terminal block 4 <TN4>**

- Between 1–2: CH4 span calibration contact output
- Between 3–4: CH3 span calibration contact output
- Between 5–6: CH2 span calibration contact output
- Between 7–8: CH1 span calibration contact output
- Between 9–10: Zero calibration contact output  
When the calibration contact output is measured with manual calibration, the calibration contact corresponding to calibration channel is conductive.  
For the automatic calibration, they are worked sequentially according to “6.4 Auto calibration setting”. If calibration is not performed, all of them are open.
- Between 11–12: For internal connection. Must not be wired. (Must not be used as junction terminal.)
- Between 13–14: Automatic calibration in progress, contact output. Conductive during automatic calibration. Open otherwise.
- Between 15–16: Calibration error contact output. Conductive when error is produced at zero or span calibration. Normally open.
- Between 17–18: Pump ON/OFF contact output. (Used for turning ON/OFF the pump. Conductive during measurement and open at zero span calibration.)

Note) For the output of calibration contacts, see Item 3.5 (9) “Timing of calibration contact output”.

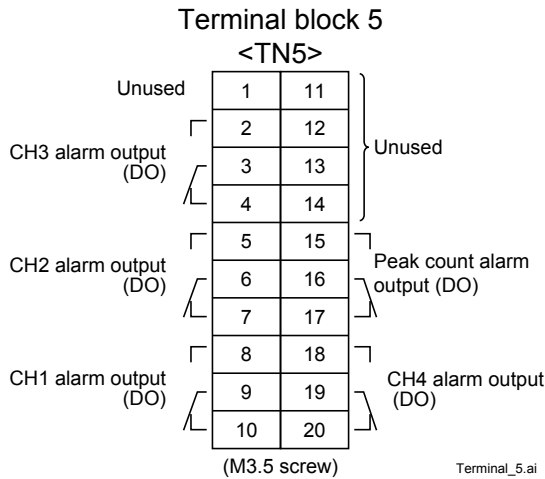

**Terminal block 5 <TN5>**

- 1 and 11 – 14: For internal connection. Must not be wired. (Must not be used as junction terminal.).
  
- Between 2– 3 and 3– 4: CH3 alarm output. Conductive at 2–3 and open at 3– 4 when set value is exceeded. Open at 2– 3 and conductive at 3– 4 otherwise..
  
- Between 5– 6 and 6– 7: CH2 alarm output. Conductive at 5–6 and open at 6– 7 when set value is exceeded. Open at 5– 6 and conductive at 6– 7 otherwise.
  
- Between 8– 9 and 9– 10: CH1 alarm output. Conductive at 8–9 and open at 9– 10 when set value is exceeded. Open at 8– 9 and conductive at 9– 10 otherwise.
  
- Between 15–16 and 16– 17: Peak count alarm contact output. Conductive at 15 – 16 and open at 16 – 17 when preset peak count is exceed. Otherwise, open at 15 – 16 and conductive at 16 – 17. For setting and action, refer to instruction manual “6.6 Peak Alarm Setting”..
  
- Between 18–19 and 19– 20: CH4 alarm output. Conductive at 18– 19 and open at 19– 20 when set value is exceeded. Open at 18– 19 and conductive at 19– 20 otherwise..

(9) Timing of calibration contact output

1. Manual calibration (See “6.9 Calibration”).

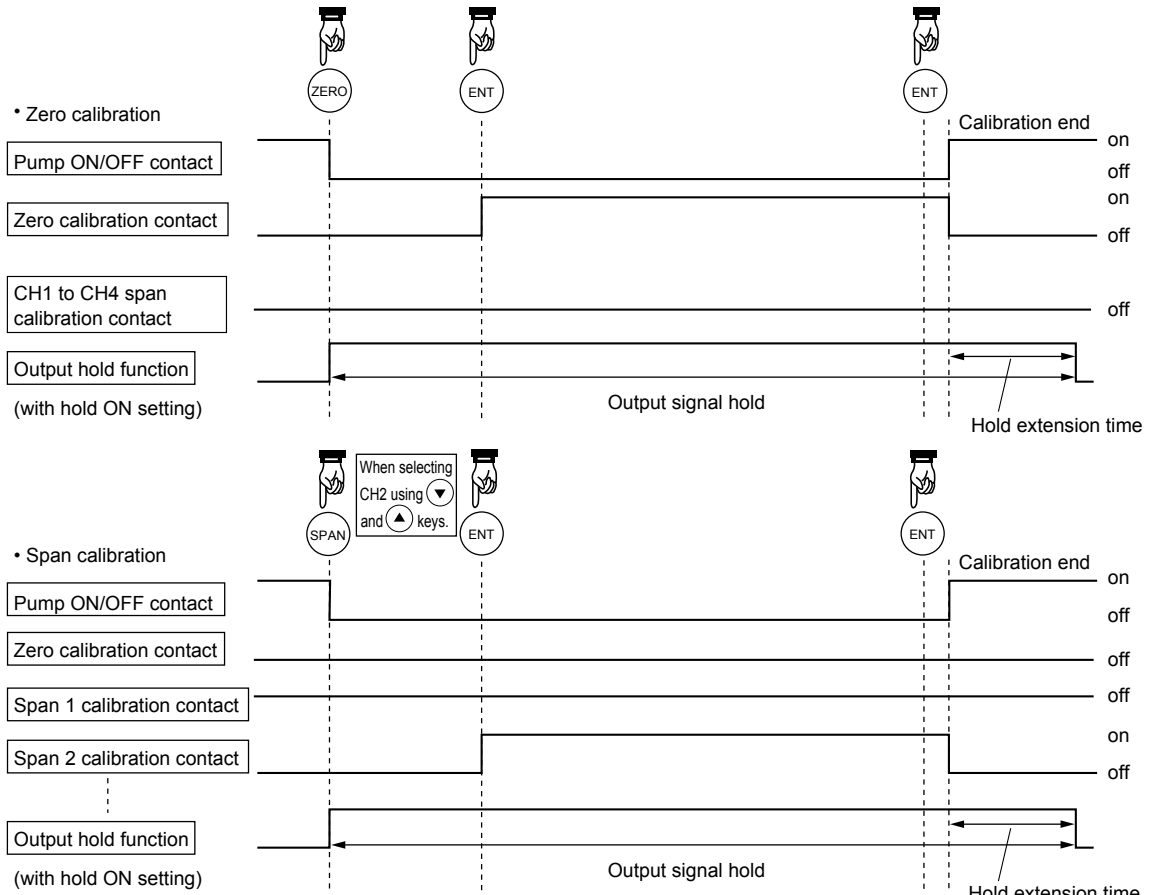

Note) The hold extension time depends on the gas flow time of the automatic calibration settings.

M-cala.ai

2. In case of automatic calibration (example shown in 6.4.1, Automatic calibration settings)

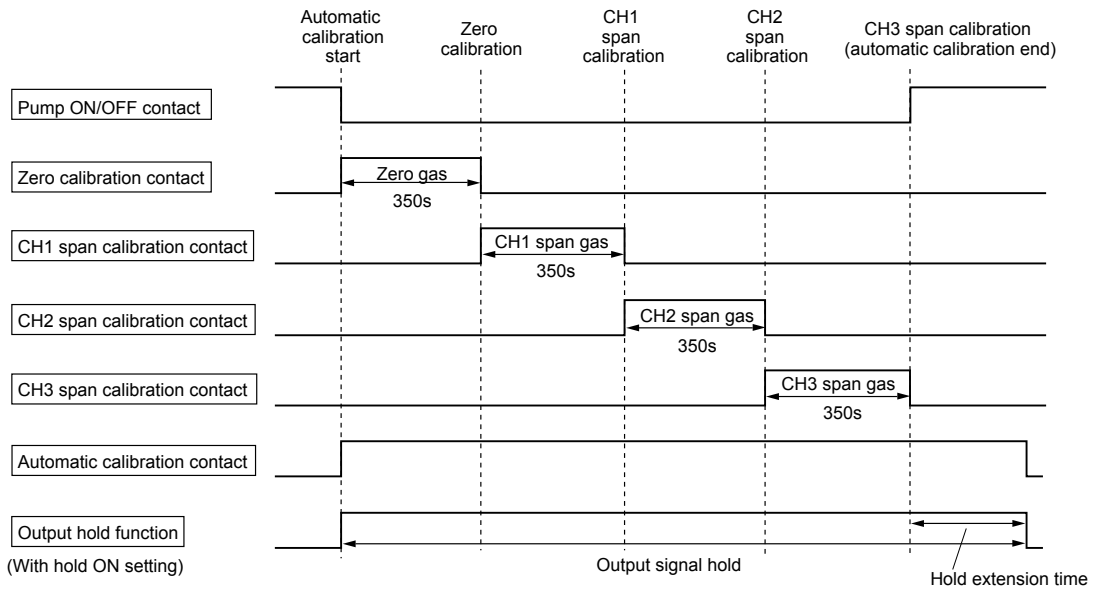

A-cala.ai

# 4. OPERATION

## 4.1 Preparation for operation

### (1) Check of gas sampling tube, exhaust tube and wiring

Check that the pipes are correctly connected to the gas sampling port and drain port. Check that the analyzer is correctly wired as specified.

## 4.2 Warm-up operation and regular operation

### (1) Operation procedure

1. Turn ON the power switch at the left of the front panel.  
In one or two seconds, the measurement screen will appear at the front panel.
2. About 2 hour warm-up operation  
About 2 hours are needed until the operating performance is stabilized. Warm-up operation should be continued with the power ON.
3. Setting of various set values  
Set required set values according to Chapter 6, "Setting and calibration".
4. Zero and span calibration  
Perform zero calibration and span calibration after warm-up operation. See Chapter 6.9, "Calibration".
5. Make moisture interference compensation adjustment (NO Analyzer and SO<sub>2</sub> Analyzer).  
(See "6.8 Maintenance mode" and "7.4 Moisture interference compensation adjustment" for details.)

Be sure to perform individual moisture interference compensation adjustment according to the system in the case of NO Analyzer and SO<sub>2</sub> Analyzer. Otherwise measurement is affected by moisture interference.

6. Introduction and measurement of measured gas Start measurement by introducing measured gas into the analyzer.

Note) While in warm-up operation, the concentration reading may be beyond the upper limit of the range (range-over)  or below the lower limit (range-under) . But this is not an error.



---

Blank Page

# 5. DESCRIPTION OF DISPLAY AND OPERATION PANELS

This section describes the display unit and operation panel of the analyzer unit. It also explains the name and description of function on the operation panel. See Fig. 5-1.

## 5.1 Name and description of operation panel

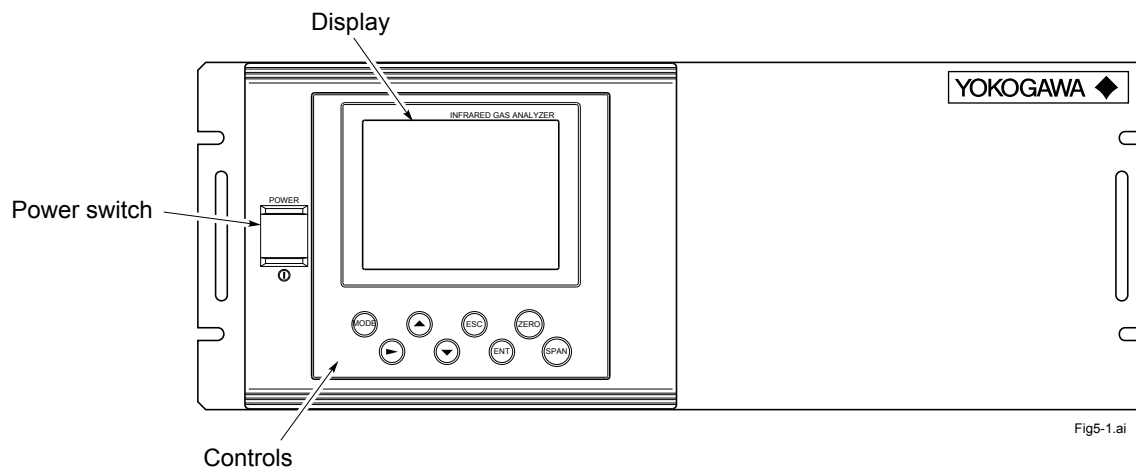

- Display : The measurement screen and the setting items are displayed.
- Controls : The configuration is as shown below.

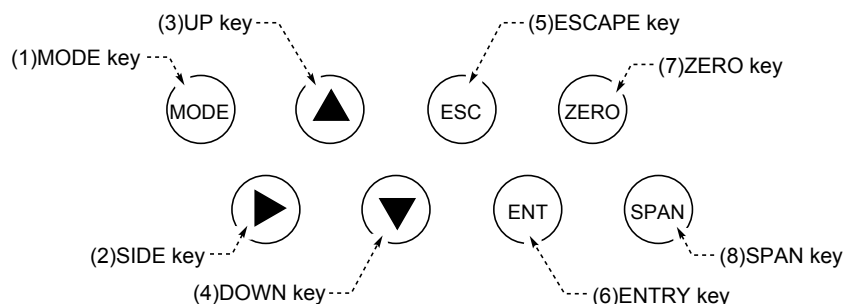

Name	Description	Name	Description
(1) MODE key	Used to switch the mode.	(5) ESCAPE key	Used to return to a previous screen or cancel the setting midway.
(2) SIDE key	Used to change the selected item (by moving the cursor) and numeral digit.	(6) ENTRY key	Used for confirmation of selected items or values, and for execution of calibration.
(3) UP key	Used to change the selected item (by moving the cursor) and to increase numeral value.	(7) ZERO key	Used for zero calibration.
(4) DOWN key	Used to change the selected item (by moving the cursor) and to decrease numeral value.	(8) SPAN key	Used for span calibration.

Fig. 5-1 Name and description of operation display and panel

## 5.2 Overview of display and operation panels

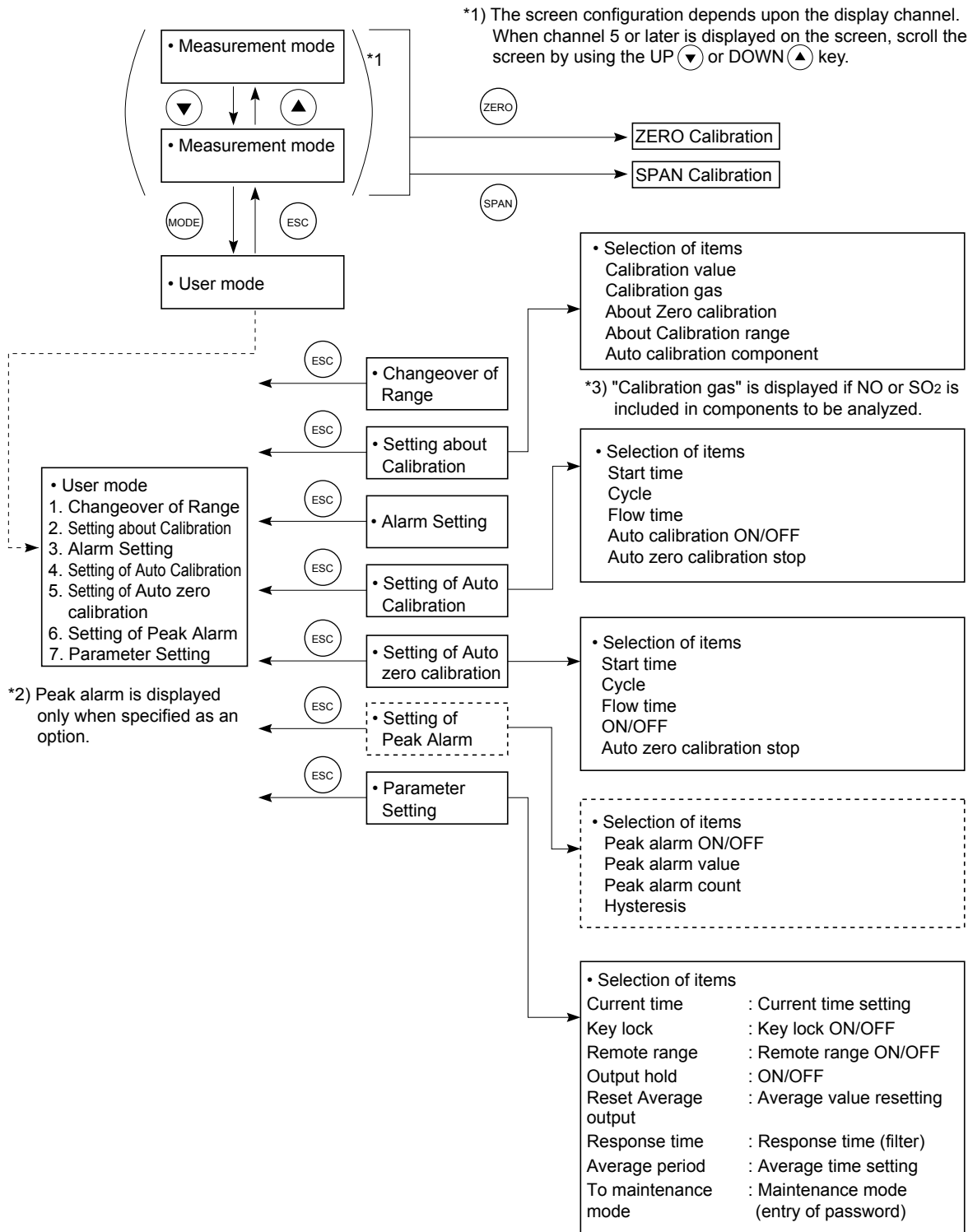

Fig5-2.ai

Fig. 5-2

## 5.3 Overview of display screen

### (1) Measurement mode screen

On turning on the power switch, the Measurement Mode screen will appear.

The measurement screen depends on the number of components. The following screen configuration as shown as an example is for CO<sub>2</sub>, CO and O<sub>2</sub> (output at channel 6). When channel 5 or later is displayed, scroll (▲) or (▼) key to view another configuration which is beyond the screen.

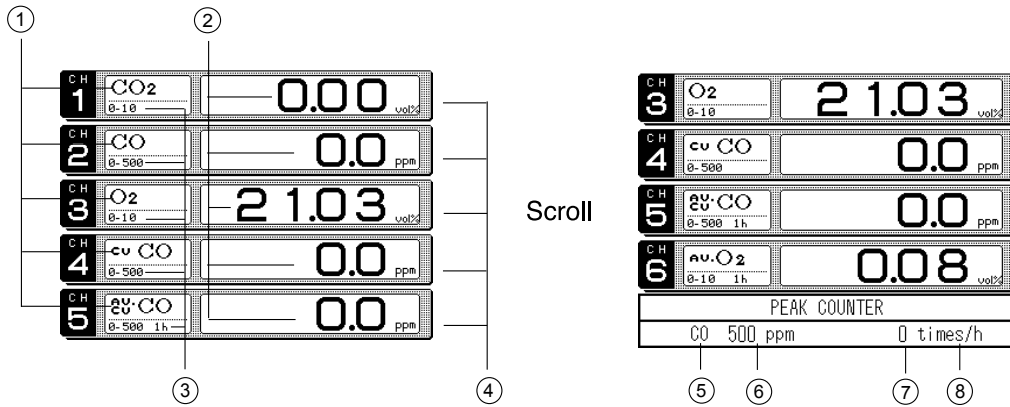

Fig5-3.ai

\* For outputs of more than 5 channels, scroll the arrow key (▲) or (▼) to view.

No.	Name	Function	No.	Name	Description
①	Component display	Displays component of instantaneous value, converted instantaneous value, converted average value, etc.	⑤	Peak alarm component display	Displays peak alarm component.
②	Concentration display	Displays measured value of concentration.	⑥	Peak alarm concentration display	Displays peak alarm concentration (Upper limit value).
③	Range display	Displays range values.	⑦	Peak alarm count	Displays the alarm times exceeding the peak value.
④	Unit display	Displays unit with ppm and vol%.	⑧	Peak alarm unit display	Displays unit of peak alarm with times/h.

Fig. 5-3 Name and function of measurement mode screen

#### • Instantaneous value and concentration value:

The concentration display of Ch (component) where sampling components such as “CO<sub>2</sub>”, “CO” or “O<sub>2</sub>” are displayed in the component display, indicates current concentration values of the measured components contained in gas that is now under measurement.

#### • O<sub>2</sub> correction concentration values:

CH (components) where “cv\*\*\*” is displayed as “cv CO” in the component display are calculated from the following equation, by setting sampling components, O<sub>2</sub> instantaneous/concentration values and O<sub>2</sub> correction reference value (see item 6.8).

$$\text{Correction output} = \frac{21 - O_n}{21 - O_s} \times C_s$$

On: The value of the O<sub>2</sub> correction reference value (Value set by application)

Os: Oxygen concentration (%)

Cs: Concentration of relevant measured component

K: The value of the fractional part is this equation.

where, K is When K ≥ 4, K=4. When K < 0, K=4.

When Cs < 0, K=0.

The correction components are CO and SO<sub>2</sub> only.

- **O<sub>2</sub> correction concentration average value:**

CH (component) where “ $\frac{AV}{CV}^{**}$ ” is displayed as “ $\frac{AV}{CV}CO$ ” in the component display and O<sub>2</sub> average value, a value obtained by averaging O<sub>2</sub> conversion concentration value or O<sub>2</sub> concentration value in a fixed time is output every 30 seconds.

Averaging time can be changed between 1 minute and 59 minutes or 1 hour and 4 hours according to the average time settings (See 6.7 Parameter setting).

(The set time is displayed as “1h”, for instance, in the Range display.)

\* The measurement ranges of O<sub>2</sub> correction concentration value and O<sub>2</sub> correction concentration average value are the same as that of the measuring components. Also, the measurement range of O<sub>2</sub> average value is the same as that of O<sub>2</sub>.

## (2) Setting/selection screen

The setting/selection screen is configured as shown below:

- In the status display area, the current status is displayed.
- In the message display area, messages associated with operation are displayed.
- In the setting item and selection item display area, items or values to be set are displayed, as required. To work on the area, move the cursor to any item by using  $\blacktriangle$ ,  $\blacktriangledown$  and  $\blacktriangleright$  keys.

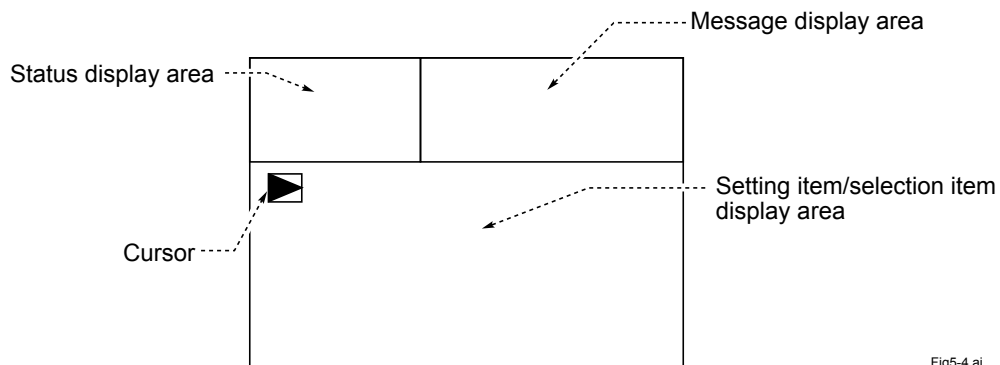

Fig5-4.ai

**Fig. 5-4 Display screen**

**(3) Contents of measured channel (CH)**

The contents in each measured CH corresponding to the type are given below:

Suffix/Option Code			Output and Corresponding Channel							
Measurable component	O <sub>2</sub> analyzer	O <sub>2</sub> correction	CH1	CH2	CH3	Ch4	CH5	CH6	CH7	CH8
-A	N	Not specified	SO <sub>2</sub>							
-B	N	Not specified	CO							
-C	N	Not specified	CO <sub>2</sub>							
-D	N	Not specified	CH <sub>4</sub>							
-E	N	Not specified	NO							
-F	N	Not specified	CO <sub>2</sub>	CO						
-G	N	Not specified	CH <sub>4</sub>	CO						
-H	N	Not specified	CO <sub>2</sub>	CH <sub>4</sub>						
-J	N	Not specified	CO <sub>2</sub>	CO	CH <sub>4</sub>					
-K	N	Not specified	NO	SO <sub>2</sub>						
-L	N	Not specified	NO	CO						
-M	N	Not specified	NO	SO <sub>2</sub>	CO					
-A	1, 2, 3	Not specified	SO <sub>2</sub>	O <sub>2</sub>						
-B	1, 2, 3	Not specified	CO	O <sub>2</sub>						
-C	1, 2, 3	Not specified	CO <sub>2</sub>	O <sub>2</sub>						
-D	1, 2, 3	Not specified	CH <sub>4</sub>	O <sub>2</sub>						
-E	1, 2, 3	Not specified	NO	O <sub>2</sub>						
-F	1, 2, 3	Not specified	CO <sub>2</sub>	CO	O <sub>2</sub>					
-G	1, 2, 3	Not specified	CH <sub>4</sub>	CO	O <sub>2</sub>					
-H	1, 2, 3	Not specified	CO <sub>2</sub>	CH <sub>4</sub>	O <sub>2</sub>					
-J	1, 2, 3	Not specified	CO <sub>2</sub>	CO	CH <sub>4</sub>	O <sub>2</sub>				
-K	1, 2, 3	Not specified	NO	SO <sub>2</sub>	O <sub>2</sub>					
-L	1, 2, 3	Not specified	NO	CO	O <sub>2</sub>					
-M	1, 2, 3	Not specified	NO	SO <sub>2</sub>	CO	O <sub>2</sub>				
-A	1, 2, 3	/K	SO <sub>2</sub>	O <sub>2</sub>	Correct SO <sub>2</sub> av.	Correct SO <sub>2</sub> av.	O <sub>2</sub> av.			
-B	1, 2, 3	/K	CO	O <sub>2</sub>	Correct CO	Correct CO av.	O <sub>2</sub> av.			
-E	1, 2, 3	/K	NOx	O <sub>2</sub>	Correct NOx	Correct CO av.	O <sub>2</sub> av.			
-F	1, 2, 3	/K	CO <sub>2</sub>	CO	O <sub>2</sub>	Correct CO	Correct CO av.	O <sub>2</sub> av.		
-G	1, 2, 3	/K	CH <sub>4</sub>	CO	O <sub>2</sub>	Correct CO	Correct CO av.	O <sub>2</sub> av.		
-J	1, 2, 3	/K	CO <sub>2</sub>	CO	CH <sub>4</sub>	O <sub>2</sub>	Correct CO	Correct CO av.	O <sub>2</sub> av.	
-K	1, 2, 3	/K	NOx	SO <sub>2</sub>	O <sub>2</sub>	Correct NOx	Correct SO <sub>2</sub> av.	Correct NOx av.	Correct SO <sub>2</sub> av.	O <sub>2</sub> av.
-L	1, 2, 3	/K	NOx	CO	O <sub>2</sub>	Correct NOx	Correct CO	Correct NOx av.	Correct CO av.	O <sub>2</sub> av.
-M	1, 2, 3	/K	NOx	SO <sub>2</sub>	CO	O <sub>2</sub>	Correct NOx	Correct SO <sub>2</sub>	Correct CO	O <sub>2</sub> av.

\* How to Read the Table

“SO<sub>2</sub>” in the CH1 column means that the display and output of CH1 correspond to SO<sub>2</sub> component.  
 “Correct XX” means an instantaneous XX value after O<sub>2</sub> correction, “Correct XX av.” an average XX value after O<sub>2</sub> correction, and “O<sub>2</sub> av.” an average O<sub>2</sub> value.

# 5.4 General operation

## • Measurement mode

The measurement mode can be displayed up to 5 channels in a single screen. When viewing a channel beyond the 5 channels, press the ▲ or ▼ key and the screen can be scrolled one by one channel at a time.

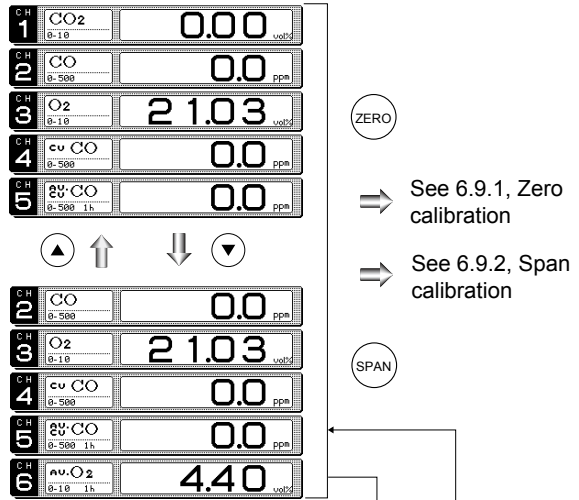

## • User mode displays the following settings.

- Changeover of range
- Calibration setting
- Alarm setting
- Setting of auto calibration
- Setting of auto zero calibration
- Peak alarm setting
- Parameter setting.

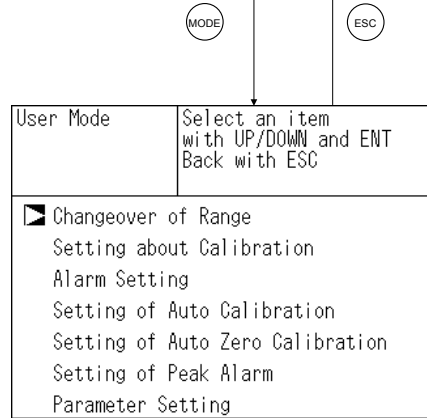

F5-4.ai

For the setting contents, refer to “Chapter 6. Setting and calibration”.

# 6. SETTING AND CALIBRATION

## 6.1 Changeover of range

This mode is used to select the ranges of measured components.

(1) During measurement, press the **MODE** key to display the User mode.

(2) Point the cursor to "Changeover of Range". Press the **ENT** key.

(3) The "Channel Selection" screen appears. Press the **▲** or **▼** key until the **▶** cursor moved selects a desired CH (component).

(4) After selection, press the **ENT** key.

Note) The range of O<sub>2</sub> correction instantaneous values and O<sub>2</sub> correction average values is automatically switched by changing the range of instantaneous value of each CH (component).

(5) In the Range Setting screen that appears, move the cursor by pressing the **▲** or **▼** key to select the range. (The range with a mark of **▶** is currently selected.).

(6) After selection, press the **ENT** key.

(7) Measurement is conducted within the selected range. The range identification signal (CO) is shorted with the low range (Range 1), and open with the high range (Range 2).

Note) If the Remote Range is set to ON, the changeover of range cannot be performed on the screen.

↓ **MODE**

User Mode	Select an item with UP/DOWN and ENT Back with ESC
▶ Changeover of Range	Setting about Calibration Alarm Setting Setting of Auto Calibration Setting of Auto Zero Calibration Setting of Peak Alarm Parameter Setting

↓ **ENT**

Range Change	Select CH No. with UP/DOWN and ENT Back with ESC
▶ CH 1 CO <sub>2</sub>	▶ Range1 0-10 vol% Range2 0-20 vol%
CH 2 CO	▶ Range1 0-500 ppm Range2 0-2000 ppm
CH 3 O <sub>2</sub>	▶ Range1 0-10 vol% Range2 0-25 vol%

↓ **▼** (**▲**) **ENT**

Range Change	Select range with UP/DOWN and ENT Back with ESC
CH 1 CO <sub>2</sub>	▶ Range1 0-10 vol% ▶ Range2 0-20 vol%
CH 2 CO	▶ Range1 0-500 ppm Range2 0-2000 ppm
CH 3 O <sub>2</sub>	▶ Range1 0-10 vol% Range2 0-25 vol%

↓ **▼** (**▲**) **ENT**

**End of Range Changeover**

F6\_1-1#

To close Changeover of range

To close Changeover of range, or cancel the command midway, press the **ESC** key. A previous screen will return.

F6\_1\_1note.ai







## 6.2 Calibration setting

This mode is used to set calibration concentration and actions. The calibration setting involves calibration concentration, calibration gas, zero calibration, calibration range and auto-calibration component.

“Calibration Gas” is displayed if NO or SO<sub>2</sub> is included in components to be analyzed.



### 6.2.1 Setting of calibration concentration





It allows you to set concentrations of the standard gas (zero and span) of each channel used for calibration.

- (1) During measurement, press the  key to display the User Mode.
- (2) Point the cursor to “Calibration Parameters” by pressing the  or  key. Press the  key.



↓ 





User Mode	Select an item with UP/DOWN and ENT Back with ESC
Changeover of Range <input checked="" type="checkbox"/> Setting about Calibration Alarm Setting Setting of Auto Calibration Setting of Auto Zero Calibration Setting of Peak Alarm Parameter Setting	

- (3) In the “Calibration Parameters” screen that appears, point the cursor to “Calibration Value” by pressing the  or  key. Press the  key.

↓   (  ) 

Cal. Settings	Select an item with UP/DOWN and ENT Back with ESC
<input checked="" type="checkbox"/> Calibration Value Calibration Gas About ZERO Calibration About Calibration Range Auto Calibration Components	

- (4) In the “Calibration Concentration Ch Selection” screen that appears, point the cursor to Ch you want to set by using the  or  key. Press the  key.

↓   (  ) 

Cal. Settings	Select CH No. for setting calibration value			
Cal. Value	CH	RANGE	ZERO	SPAN
	<input checked="" type="checkbox"/> CH1	0-10vol%	000.00	010.00
	CO <sub>2</sub>	0-20vol%	000.00	020.00
	CH2	0-500ppm	0000.0	0500.0
	CO	0-2000ppm	00000	02000
	CH3	0-10vol%	00.00	10.00
	O <sub>2</sub>	0-25vol%	00.00	25.00

↓   (  ) 

- (5) In the “Calibration Concentration Selection” screen that appears, select any concentration item you want to set by pressing the , key.

Cal. Settings		Select setting value	
CH	RANGE	ZERO	SPAN
CH1	0-10vol%	000.00	010.00
CO2	0-20vol%	000.00	020.00
CH2	0-500ppm	0000.0	0500.0
CO	0-2000ppm	00000	02000
CH3	0-10vol%	00.00	10.00
O2	0-25vol%	00.00	25.00



Note) Analyzers other than the zirconia O<sub>2</sub> instrument cannot perform zero setting.

- (6) In the “Calibration Concentration Value Setting” screen that appears, enter calibration gas concentration values (zero and span). For value entry, press the or key, and a 1-digit value increases or decreases. By pressing the , the digit moves. After setting, save the entry by pressing the key. The saved value becomes valid from the next calibration process.

Cursor for setting value

Cal. Settings		Set calibration value	
CH	RANGE	ZERO	SPAN
CH1	0-10vol%	000.00	010.00
CO2	0-20vol%	000.00	020.00
CH2	0-500ppm	0000.0	0500.0
CO	0-2000ppm	00000	02000
CH3	0-10vol%	00.00	10.00
O2	0-25vol%	00.00	25.00



Note) Enter the set values corresponding to each range. When the O<sub>2</sub> measurement uses atmospheric air for the zero gas, set the concentration value to 21.00. When the cylinder air is used, set to the concentration value as indicated on the cylinder.

**End of Calibration  
Concentration Setting**

F6\_2\_1\_1.ai

To close the setting  
To close the calibration concentration value setting process or cancel this mode midway, press the key.  
A previous screen will return.

F6\_2\_1note.ai

**Setting range of value**

Paramagnetic O<sub>2</sub>, CO<sub>2</sub>, CO,  
SO<sub>2</sub>, CH<sub>4</sub> and NO measurement

Zero gas : Fixed at 0  
Span gas : Minimum digit, 1 to 105% of full scale  
(Full scale (FS) is the same as each range value.)

Zirconia O<sub>2</sub> measurement

Zero gas : 5 to 25 vol%  
Span gas: 0.01 to 5 vol%



**The setting cannot be performed beyond the range.**



### 6.2.2 Setting of calibration gas



Whether moisture is contained in zero gas and span gas used for calibration can be set in advance as follows. Make the setting according to the sampling system created.

If sampling system controls the moisture content in the calibration gas (ZERO or SPAN) to become the same as that in the sample gas to be fed to the analyzer using an electronic cooler, etc., set "With" water vapor.

(1) Press the  key in the measurement state to display the User mode.



(2) Move the cursor to Setting about Calibration using the  or  key, and then press the  key.

(3) On the Setting about Calibration screen that appears, move the cursor to "Calibration Gas" using the  or  key, and then press the  key.



(4) On the "Gas Selection" screen that appears, move the cursor to the gas to be selected using the  or  key, and then press the  key.

↓ ↓ 



User Mode	Select an item with UP/DOWN and ENT Back with ESC
Changeover of Range <input checked="" type="checkbox"/> Setting about Calibration Alarm Setting Setting of Auto Calibration Setting of Auto Zero Calibration Setting of Peak Alarm Parameter Setting	

↓ ↓   

Cal. Settings	Select an item with UP/DOWN and ENT Back with ESC
Calibration Value <input checked="" type="checkbox"/> Calibration Gas About ZERO Calibration About Calibration Range Auto Calibration Components	

↓ ↓   

Cal. Settings Cal. Gas	Select calibration gas
	Water Vapor
<input checked="" type="checkbox"/> Zero Gas	without
Span Gas	without

↓ ↓   

F6\_2\_2.a

- (5) On the “Gas Selection” screen that appears, select “with” or “without” of moisture content in calibration gas using the ▲ or ▼ key.
- Select “with” to have the calibration gas contain a certain amount of moisture.
  - Select “without” to use dry gas (moisture content: saturated at 70°C or lower) such as cylinder gas as calibration gas.
  - When “without” is selected for zero gas, “with” cannot be selected for span gas.

After setting, press the ENT key.

Cal. Settings Cal. Gas	Set with or without water
	Water Vapor
Zero Gas	with
Span Gas	without

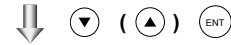

F6\_2\_2\_1.ai

**End of Calibration gas Setting**











To close the setting  
To terminate or cancel calibration gas setting, press the ESC key.  
The previous screen appears again.

F6\_2\_2note.ai

Note: Be sure to make the setting according to the sampling system created. We recommend you to select “with” moisture in zero gas for the measurement of NO and SO<sub>2</sub>. In this case, be sure to perform bubbling (humidification) of zero gas to make its moisture content kept at constant level before feeding the gas. (See “(7) Example of sampling system configuration” in “3.4 Sampling system.”)



### 6.2.3 Setting of manual zero calibration

If zero calibration is to be made manually, select whether to calibrate all components at once or each of them separately upon selection.



- (1) During measurement, press the  key to display the User mode.
- (2) Point the cursor to "Setting about Calibration" by pressing the  or  key. Press the  key.
- (3) In the "Setting about Calibration" screen that appears, point the cursor to "About ZERO Calibration" by pressing the  or  key. Press the  key.
- (4) In the "CH Selection" screen that appears, point the cursor to Ch you want to set by pressing the  or  key. Press the  key.

↓ 



User Mode	Select an item with UP/DOWN and ENT Back with ESC
Changeover of Range <input checked="" type="checkbox"/> Setting about Calibration Alarm Setting Setting of Auto Calibration Setting of Auto Zero Calibration Setting of Peak Alarm Parameter Setting	

↓   

Cal. Settings	Select an item with UP/DOWN and ENT Back with ESC
Calibration Value Calibration Gas <input checked="" type="checkbox"/> About ZERO Calibration About Calibration Range Auto Calibration Components	

↓   

Cal. Settings ZERO Cal.	Select CH No.
<input checked="" type="checkbox"/> CH1 CO <sub>2</sub>	Range1 0-10 vol% Range2 0-20 vol% each
CH2 CO	Range1 0-500 ppm Range2 0-2000ppm both
CH3 O <sub>2</sub>	Range1 0-10 vol% Range2 0-25 vol% each

↓   

FB\_2\_3.a1

- (5) In the “Zero Calibration Selection” screen that appears, select “at once” or “each” by pressing the ▲ or ▼ key. When selecting “at once”, the CH (components) to be set can be zero-calibrated at the same time. When selecting “each”, either of the CH (components) to be selected is zero-calibrated. After setting, press the ENT key, and the calibration you specified is carried out.

Cal. Settings ZERO Cal.		Set each or at once CH at ZERO Calibration	
CH1 CO <sub>2</sub>	Range1 0-10 vol% Range2 0-20 vol%		at once
CH2 CO	Range1 0-500 ppm Range2 0-2000ppm		at once
CH3 O <sub>2</sub>	Range1 0-10 vol% Range2 0-25 vol%		each

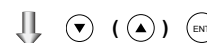

F6\_2\_3\_1.ai

End of Manual Zero Calibration Setting

To close “About ZERO Calibration”  
To close “About ZERO Calibration” setting or to cancel this mode midway, press the ESC key.  
A previous screen will return.

F6\_2\_3note.ai

Example

Whether upon selection “each” or “at once” can be determined for each CH (component).

- Setting “each”  
Select the CH (component) and then perform zero calibration on the manual zero calibration screen.
  - Setting “at once”  
At a manual zero calibration, CHs (components) for which “at once” was selected can simultaneously be calibrated.
- \* When the zirconia O<sub>2</sub> analyzer uses the cylinder air or atmospheric air for the zero gas, select “at once”.

Manual Calibration screen

When “each” is set for each CH

ZERO Cal.		Select CH No. with UP/DOWN and ENT Back with ESC	
▶CH1 CO <sub>2</sub>	▶Range1 0-10 vol% ▶Range2 0-20 vol%		20.03
CH2 CO	▶Range1 0-500 ppm ▶Range2 0-2000ppm		999.9
CH3 O <sub>2</sub>	▶Range1 0-10 vol% ▶Range2 0-25 vol%		40.95

F6\_2\_3\_gamen1.ai

A single cursor will appear.

When “at once” is set for CH1 and CH2  
(CH3 is set “each”)





ZERO Cal.		ENT:Go on calibration of selected CH ESC:Not calibration	
CH1 CO <sub>2</sub>	▶Range1 0-10 vol% ▶Range2 0-20 vol%	▶	19.92
CH2 CO	▶Range1 0-500 ppm ▶Range2 0-2000ppm	▶	999.9
CH3 O <sub>2</sub>	▶Range1 0-10 vol% ▶Range2 0-25 vol%		40.95

F6\_2\_3\_gamen2.ai

Cursors will appear on all components where “at once” is set.



### 6.2.4 Setting of calibration range



This mode is used to set if the range of each CH (component) at the zero and span calibration (manual calibration or auto calibration) should be calibrated with a single range or 2 ranges.

- (1) During measurement, press the  key to display the User Mode.
- (2) Point the cursor to "Setting about Calibration" by pressing the  or  key. Press the  key.



↓ 



User Mode	Select an item with UP/DOWN and ENT Back with ESC
Changeover of Range <input checked="" type="checkbox"/> Setting about Calibration Alarm Setting Setting of Auto Calibration Setting of Auto Zero Calibration Setting of Peak Alarm Parameter Setting	

- (3) In the "Setting about Calibration" screen that appears, point the cursor to "About Calibration Range" by pressing the  or  key. Press the  key.



↓   

Cal. Settings	Select an item with UP/DOWN and ENT Back with ESC
Calibration Value Calibration Gas About ZERO Calibration <input checked="" type="checkbox"/> About Calibration Range Auto Calibration Components	

- (4) In the "Calibration Range CH Selection" screen that appears, point the cursor to the CH you want to set by pressing the  or  key. Press the  key.

↓   

Cal. Settings	Select CH No.		
Cal. Range			
<input checked="" type="checkbox"/> CH1 CO2	Range1 0-10 vol%	Range2 0-20 vol%	current
CH2 CO	Range1 0-500 ppm	Range2 0-2000ppm	current
CH3 O2	Range1 0-10 vol%	Range2 0-25 vol%	current

↓   

FB\_2\_4.a1

- (5) In the “Calibration Range Selection” screen that appears, select “both” or “current” by pressing the or key.
- When selecting “both”, Range 1 and Range 2 of the set CH are calibrated together.
- When selecting “current”, the range alone displayed at the set CH is calibrated.

Cal. Settings		Set calibration range	
Cal. Range		current or both range	
CH1 CO <sub>2</sub>	Range1 0-10 vol% Range2 0-20 vol%		both
CH2 CO	Range1 0-500 ppm Range2 0-2000ppm		current
CH3 O <sub>2</sub>	Range1 0-10 vol% Range2 0-25 vol%		current

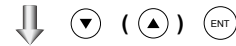

FB\_2\_4\_1.ai

End of Calibtation Range Setting

To close Setting of Calibration Range  
To close Setting of Calibration Range or to cancel this mode midway, press the key. A previous screen will return.

F6\_2\_4note.ai

Example

CH1 CO <sub>2</sub>	Range 1: 0 to 10 vol% Range 2: 0 to 20 vol%	both
CH2 CO	Range 1: 0 to 500 ppm Range 2: 0 to 2000 ppm	current

CH1: Range 1 and Range 2 are calibrated together, with zero or span calibration.  
CH2: Only currently displayed range is calibrated, with zero or span calibration.

Manual Calibration screen

In case of both setting

ZERO Cal.	ENT:Go on calibration of selected CH ESC:Not calibration		
CH1 CO <sub>2</sub>	▶Range1 0-10 vol% Range2 0-20 vol%		19.92
CH2 CO	▶Range1 0-500 ppm Range2 0-2000ppm		999.9
CH3 O <sub>2</sub>	▶Range1 0-10 vol% Range2 0-25 vol%		40.95

F6\_2\_4gamen.ai





Two cursors will appear in both ranges

The other range that is calibrated by “both” may result in some error (max. of ±5% of FS).





### 6.2.5 Setting of auto-calibration component



It sets the CH (component) to be calibrated in the auto-calibration.

- (1). During measurement, press the  key to display the User mode.
- (2). Point the cursor to "Setting about Calibration" by pressing the  or  key. Press the  key.



↓ 



User Mode	Select an item with UP/DOWN and ENT Back with ESC
Changeover of Range <input checked="" type="checkbox"/> Setting about Calibration Alarm Setting Setting of Auto Calibration Setting of Auto Zero Calibration Setting of Peak Alarm Parameter Setting	

- (3). In the "Setting about Calibration" screen that appears, point the cursor to "Auto Calibration Components" by pressing the  or  key. Press the  key.



↓  (  ) 

Cal. Settings	Select an item with UP/DOWN and ENT Back with ESC
Calibration Value Calibration Gas About ZERO Calibration About Calibration Range <input checked="" type="checkbox"/> Auto Calibration Components	



- (4). In the "Auto Calibration Components" selection screen that appears, point the cursor to the CH you want to set by pressing the  or  key. Press the  key.

↓  (  ) 

Cal. Settings	Select CH No.	
Auto Cal.		
<input checked="" type="checkbox"/> CH1 CO2	Range1 0-10 vol% Range2 0-20 vol%	enable
CH2 CO	Range1 0-500 ppm Range2 0-2000ppm	enable
CH3 O2	Range1 0-10 vol% Range2 0-25 vol%	enable

↓  (  ) 

F6\_2\_5.ai

- (5). In the “Auto Calibration component Selection” screen that appears, select “enable” or “disable” by pressing the  or  key. After setting, press the  key.

Cal. Settings Auto Cal.		Set enable or disable for auto calibration	
CH1 CO <sub>2</sub>	Range1 0-10 vol% Range2 0-20 vol%	enable	
CH2 CO	Range1 0-500 ppm Range2 0-2000ppm	enable	
CH3 O <sub>2</sub>	Range1 0-10 vol% Range2 0-25 vol%	disable	

To close Auto Calibration  
To close “Setting of Auto Calibration Component” or to cancel this mode midway, press the  key. A previous screen will return.

F6\_2\_5note.ai

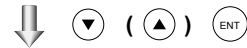

F6\_2\_5\_1.ai

**End of Auto Calibration Component Setting**

**Example**

Auto calibration is made in the following rules according to the setting.

1. Zero calibration at once of CHs (components) which were set to enable .
2. The span of CHs (components) which were set to enable is calibrated in the ascending order of CH number.

Example 1. In case all of CH1: CO<sub>2</sub>, CH2: CO, CH<sub>3</sub>: O<sub>2</sub>, were set to enable .  
Zero calibration (at once) of CH1 to CH3 → span calibration of CH1 (CO<sub>2</sub>)  
→ span calibration of CH2 (CO) → span calibration of CH3 (O<sub>2</sub>)

Example 2. In case, out of CH1: CO<sub>2</sub>, CH2: CO and CH3: O<sub>2</sub>, CH1 (CO<sub>2</sub>) was set to enable , CH2 (CO) was set to enable an CH3 (O<sub>2</sub>) was set to disable .  
Zero calibration (at once) of CH1 and 2 → span calibration of CH1 (CO<sub>2</sub>) → span calibration of CH2 (CO)





**Caution**

The components which were set to enable is calibrated to zero at once at the time of auto calibration regardless of setting in 6.2.3 Setting of manual zero calibration .

## 6.3 Alarm setting



### 6.3.1 Setting of alarm values



This mode is used to set the upper and lower limit value to provide an alarm output against measured concentration during measurement. Before changing the alarm setting, set the ON/OFF to OFF.

- (1) During measurement, press the  key to display the User mode.
- (2) Point the cursor to "Alarm Setting" by pressing the  or  key. Press the  key.



↓ 



User Mode	Select an item with UP/DOWN and ENT Back with ESC
Changeover of Range Setting about Calibration <input checked="" type="checkbox"/> Alarm Setting Setting of Auto Calibration Setting of Auto Zero Calibration Setting of Peak Alarm Parameter Setting	

- (3) After the alarm setting, CH selection screen has appeared, operate the  or  key until the cursor is aligned with a desired CH and press the  key.

↓  () 

Alarm Setting	Select CH No. or Hysteresis setting
<input checked="" type="checkbox"/> CH1 CO <sub>2</sub> CH2 CO CH3 O <sub>2</sub>	
Hysteresis	00 %FS



- (4) After the alarm item selection screen has appeared, operate the  or  key until the cursor is aligned with a desired item and press the  key.

↓  () 

Alarm Setting CH1 CO <sub>2</sub>	Select an item with UP/DOWN and ENT Back with ESC
<input checked="" type="checkbox"/> Upper Range 1 10.00 vol% Range 2 10.00 vol% Lower Range 1 00.00 vol% Range 2 00.00 vol% Kind of Alarm Upper ON/OFF 0 F F	

#### Caution

**Set the values so that upper limit value > lower limit value and that (upper limit value-lower limit value) > hysteresis error. The alarm is activated in each range independently from the settings of each range.**

↓  () 

FB\_3\_1-a

After setting, the alarm setting is now completed by pressing the **ENT** key.

Cursor for setting value

Alarm Setting CH1 CO <sub>2</sub>	Set value
Upper Range 1	00.00 vol%
Range 2	10.00 vol%
Lower Range 1	00.00 vol%
Range 2	00.00 vol%
Kind of Alarm	Upper
ON/OFF	OFF



**End of Alarm Setting**

**To close the Alarm Setting**

To close the "Alarm Setting" or to cancel this mode midway, press the **ESC** key. A previous screen will return.

**Setting range**

0% to 100%FS (Settable in each range).

**Description of setting items**

- Upper limit value: Sets the upper limit value (concentration) of alarm.
- Lower limit value: Sets the lower limit value (concentration) of alarm.
- Contact action: Selects one of upper limit alarm, lower limit alarm, and upper limit or lower limit alarm.
  - Upper limit alarm ... Alarm contact operates when above upper limit value.
  - Lower limit alarm ... Alarm contact operates when below lower limit value.
  - Upper limit alarm or lower limit alarm ...Alarm contact operates when above upper limit value or below lower limit value.

ON/OFF: Enables the alarm function if set at "ON", or disables the alarm function if set at "OFF".

\* The upper limit value cannot be set below the lower limit value, and the lower limit value cannot be set above the upper limit value.  
If it is desired to set the upper limit value below the lower limit value already stored in the memory, reduce the lower limit value beforehand, or vice versa.

**Typical on-screen display when an alarm occurs**

When an upper limit alarm has occurred, the "High alarm" message lights at CH (component) ("Low alarm" at lower limit alarm).

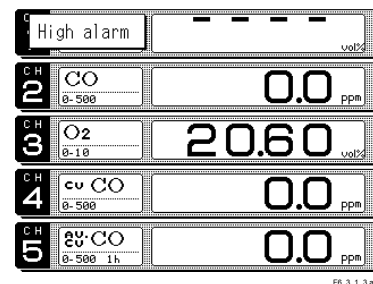

**Caution**

- For 10 minutes after turning on power, the alarm judgment is inactive.

### 6.3.2 Hysteresis setting

To prevent chattering of an alarm output near the alarm setting values, set hysteresis.

- (1) In the "Alarm Setting CH Selection" screen that appears, point the cursor to "Hysteresis" by pressing the  $\blacktriangle$  or  $\blacktriangledown$  key. Press the  $\text{ENT}$  key.

Alarm Setting	Select CH No. or Hysteresis setting
CH1	CO <sub>2</sub>
CH2	CO
CH3	O <sub>2</sub>
$\blacktriangledown$ Hysteresis      00 %FS	

$\blacktriangledown$   $\blacktriangledown$  ( $\blacktriangle$ )  $\text{ENT}$

- (2) In the "Hysteresis Value Setting" screen that appears, enter hysteresis values.

For the value entry, 1-digit value is increased or decreased by pressing the  $\blacktriangle$  or  $\blacktriangledown$  key, and pressing the  $\blacktriangleright$  key moves the digit. After setting, press the  $\text{ENT}$  key to carry out hysteresis.

Alarm Setting	Set Hysteresis 0 to 20%FS available
CH1	CO <sub>2</sub>
CH2	CO
CH3	O <sub>2</sub>
Hysteresis      00 %FS	

$\blacktriangledown$   $\blacktriangledown$   $\blacktriangle$   $\blacktriangleright$   $\text{ENT}$

F6\_3\_2.ai

**End of Hysteresis Setting**

To close Hysteresis Setting

To close the "Hysteresis Setting" or cancel the mode midway, press the  $\text{ESC}$  key. A previous screen will return.

Setting range

0 to 20% of full scale  
A full scale means each range provides a full scale of width.

Caution

The hysteresis is common to all CHs (components).

F6\_3\_2caution.ai

#### Hysteresis (In case of upper limit alarm)

If hysteresis values exceed the upper limit value as shown in graph, an alarm output is provided. Once the alarm output is turned "ON", it remains "ON" until the value falls below the set lower limit of the hysteresis indication.

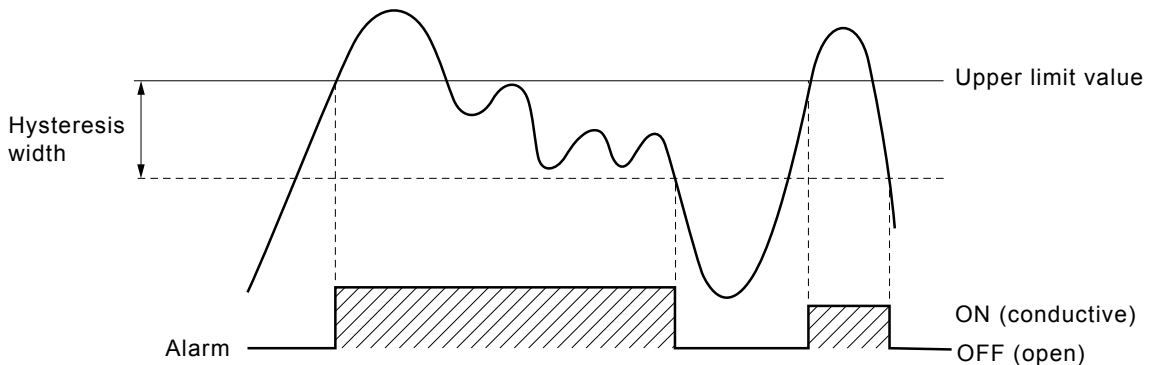

F6\_3\_2\_1.ai

## 6.4 Setting of auto calibration

### 6.4.1 Auto calibration

Auto calibration is automatically carried out at the time when zero calibration and span calibration are set.

Before changing the setting of auto calibration, set the ON/OFF to OFF.

- (1) During measurement, press the **(MODE)** key to display the User mode.
- (2) Point the cursor to “Setting of Auto Calibration” by pressing the **(▲)** or **(▼)** key. Press the **(ENT)** key.
- (3) In the “Setting of Auto Calibration” screen that appears, point the cursor to any item you want by pressing the **(▲)** or **(▼)** key. Press the **(ENT)** key.
- (4) In the “Auto Calibration Parameter Setting” screen that appears, perform the value entry or the setting. For the value entry or setting change, use the **(▲)** or **(▼)** key. To change the setting, use the **(▶)** key to move the cursor to the right.

After setting, press the **(ENT)** key, and auto calibration is carried out by the entered setting value.

#### Description of setting items

- Start Time : Setting at the first calibration (day of the week, hour, minute)
- Cycle : A period between the start time of one calibration and another (unit : hour/day)
- Flow Time : The time required for the calibration gas to be replaced in the cell
- ON/OFF : Auto zero calibration ON or OFF

#### To close Setting of Auto calibration

To close the “Setting of Auto calibration” or cancel this mode midway, press the **(ESC)** key. A previous screen will return.

↓ (MODE)

User Mode	Select an item with UP/DOWN and ENT Back with ESC
Changeover of Range Setting about Calibration Alarm Setting <input checked="" type="checkbox"/> Setting of Auto Calibration Setting of Auto Zero Calibration Setting of Peak Alarm Parameter Setting	

↓ (▼) (▲) (ENT)

About Auto Cal.	Select setting item
<input checked="" type="checkbox"/> Start Time WED 11:30 Cycle 07 day Flow Time 060 sec. ON/OFF ON  Time : WED 15:40	
Stop Auto Calibration	

↓ (▼) (▲) (ENT)

About Auto Cal.	Set Start Time
Start Time <b>WED</b> 11:30 Cycle 07 day Flow Time 060 sec. ON/OFF ON  Time : WED 15:41	
Stop Auto Calibration	

↓ (▼) (▲) (▶) (ENT) F6\_4\_1.ai

<b>End of Auto Calibration Setting</b>
--

The auto calibration status contact output is closed while auto calibration is in progress (hold extension time by the length of time the same as gas replacement time included if the hold setting is set to "ON"), and open in other cases.

**Example**

Start Time	SUN	12:00
Cycle	1	day
Flow Time	350	sec
ON/OFF	ON	

In case where auto zero calibration is carried out at the above setting.

(An example of "CH1: through CH3: enable", as given in Item 6.2.5 "Auto Calibration Components".)

F6\_4\_1\_2.ai

**Setting range**

Cycle : 1 to 99 hours or 1 to 40 days (initial value 7 days)  
 Flow time : 60 to 599 sec (initial value 300 sec)

**Caution**

- When an auto calibration starts, the measurement screen automatically appears.
- Any key operation other than key lock ON/OFF and forced stop of auto calibration (see Item 6.4.2) is not permitted during auto calibration. Auto Calibration Cancel cannot be performed with the key lock to ON . To cancel auto calibration forcedly, set the key lock to OFF and then execute Auto Calibration Cancel.
- Turn on the power again after it is turned off (including the case of power failure) at the time set as the next start time in auto calibration, and then repeat it in the set cycle.

**Remote start**

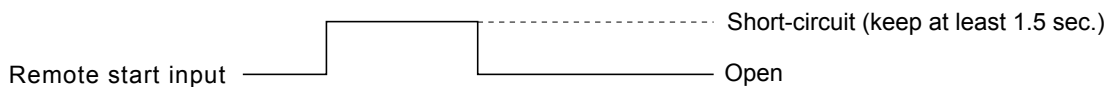

Whether the auto calibration is set at ON or OFF, an auto calibration is available by keeping the remote start input short-circuited for at least 1.5 seconds.



F6\_4\_1\_3.ai



### 6.4.2 Forced run/stop of auto calibration

This mode is used to cancel the auto calibration forcibly.

- (1) In the User mode that is displayed, point the cursor to "Setting of Auto Calibration" by pressing the  or  key. Press the  key.

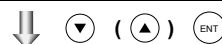

User Mode	Select an item with UP/DOWN and ENT Back with ESC
Changeover of Range Setting about Calibration Alarm Setting <input checked="" type="checkbox"/> Setting of Auto Calibration Setting of Auto Zero Calibration Setting of Peak Alarm Parameter Setting	

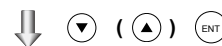

- (2) In the "Setting of Auto Calibration" item selection screen that appears, point the cursor to "Stop Auto Calibration" by pressing the  or  key. Press the  key.

About Auto Cal.	Select setting item
Start Time WED 16:07 Cycle 07 day Flow Time 060 sec. ON/OFF ON  Time : WED 16:19	
<input checked="" type="checkbox"/> Stop Auto Calibration	



- (3) "Stop Auto Calibration" is inverted. A message appears, prompting you to verify that you want to cancel or continue auto calibration. To cancel the auto calibration forcibly, press the  key. If you press the  key, auto calibration is cancel (not stopped).

About Auto Cal.	Stop auto calibration? Stop with ENT Not with ESC
Start Time WED 11:30 Cycle 07 day Flow Time 060 sec. ON/OFF ON  Time : WED 15:41	
Stop Auto Calibration	

FE\_4\_2.a1



“Auto Calibration” screen

Example

In case where setting the auto calibration components (see Item 6.2.5) to “CH1: enable” and “CH2: enable”.

- Zero calibration

A message, “Zero calibration” blinks at CH1 and CH2.

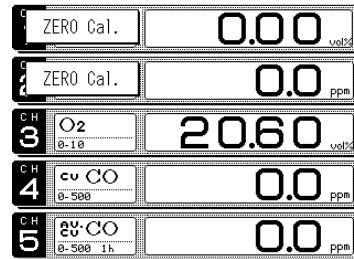

- CH1 span calibration

A message, “Span calibration” blinks at CH1.

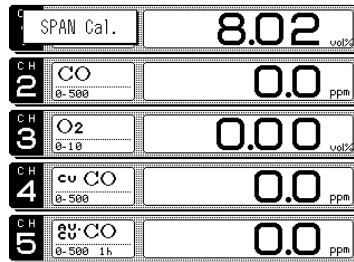

- CH2 span calibration

A message, “Span calibration” blinks at CH2.

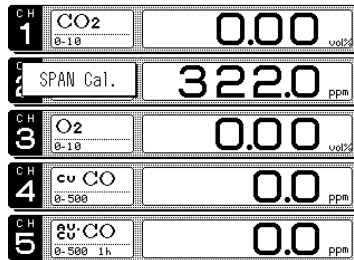

F6\_4\_2\_1.ai

Caution

During auto calibration, any key operation is not permitted other than operations such as key lock ON/OFF and “Forced Stop of Auto Calibration”.

When the key lock is set at “ON”, even the “Forced Stop of Auto Calibration” cannot be used.

To stop “Auto Calibration” forcedly, set the key lock to OFF and then execute “Stop Auto Calibration”.

## 6.5 Setting of auto zero calibration

### 6.5.1 Auto zero calibration

Auto zero calibration is automatically carried out when zero calibration are set. Components for which a calibration is to be made are determined by setting of auto calibration component in 6.2.5.

Before changing the setting of auto zero calibration, set the ON/OFF to “OFF”.

- (1) During measurement, press the **(MODE)** key to display the User Mode.
- (2) Point the cursor to “Setting of Auto Zero Calibration” by pressing the **(▲)** or **(▼)** key. Press the **(ENT)** key.
- (3) In the “Setting of Auto Zero Calibration” screen that appears, point the cursor to any item you want by pressing the **(▲)** or **(▼)** key. Press the **(ENT)** key.
- (4) In the “Auto Zero Calibration Parameter Setting” screen that appears, perform the value entry or the setting. For the value entry or setting change, use the **(▲)** or **(▼)** key. To change the setting, use the **(▶)** key to move the cursor to the right.

After setting, press the **(ENT)** key, and auto zero calibration is carried out by the entered setting value.

#### Description of setting items

- Start Time : Setting at the first calibration (day of the week, hour, minute)
- Cycle : A period between the start time of one calibration and another (unit : hour/day)
- Flow Time : The time required for the calibration gas to be replaced in the cell
- ON/OFF : Auto zero calibration ON or OFF

#### To close Setting of Auto calibration

To close the “Setting of Auto Zero calibration” or cancel this mode midway, press the **(ESC)** key. A previous screen will return.

↓ (MODE)

User Mode	Select an item with UP/DOWN and ENT Back with ESC
Changeover of Range Setting about Calibration Alarm Setting Setting of Auto Calibration <b>▶</b> Setting of Auto Zero Calibration Setting of Peak Alarm Parameter Setting	

↓ (▼) (▲) (ENT)

About Auto Zero Cal.	Select setting item
<b>▶</b> Start Time    SUN 12:00 Cycle            07 day Flow Time       300 sec. ON/OFF           OFF  Time : WED 15:42	
Stop Auto Zero Calibration	

↓ (▼) (▲) (ENT)

About Auto Zero Cal.	Set Start Time
Start Time <b>SUN</b> 12:00 Cycle            07 day Flow Time       300 sec. ON/OFF           OFF  Time : WED 15:42	
Stop Auto Zero Calibration	

↓ (▼) (▲) (▶) (ENT)

<b>End of Auto Zero Calibration Setting</b>
---

FE\_5\_1.ai

The auto calibration status contact output is closed while auto zero calibration is in progress (hold extension time by the length of time the same as gas replacement time included if the hold setting is set to ON), and open in other cases.

Example

Start Time	SUN	12:00
Cycle	12	hour
Flow Time	300	sec.
ON/OFF	ON	

In case where auto zero calibration is carried out at the above setting.

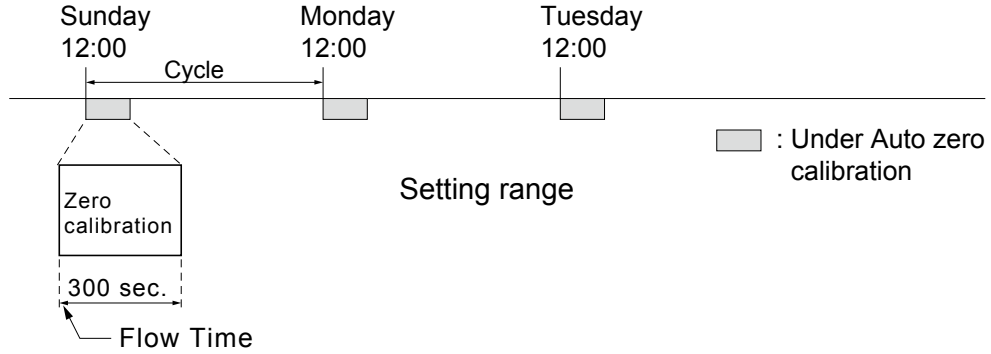

(An example of “CH1: through CH3: enable”, as given in Item 6.2.5 “Auto Calibration Components”.)

F6\_5\_1\_1.ai

Setting range



- Cycle : 1 to 99 hours or 1 to 40 days (initial value 7 days)
- Flow time : 60 to 599 sec (initial value 300 sec)

Caution

- When an auto zero calibration starts, the measurement screen automatically appears.
- Any key operation other than key lock ON/OFF and forced stop of auto zero calibration (see Item 6.5.2) is not permitted during auto zero calibration. Auto Zero Calibration Cancel cannot be performed with the key lock to ON. To cancel auto zero calibration forcibly, set the key lock to OFF and then execute Auto Zero Calibration Cancel.
- If the auto calibration period and auto zero calibration period have overlapped, the auto calibration is retained, ignoring the auto zero calibration of that period.
- Turn on the power again after it is turned off (including the case of power failure) at the time set as the next start time in auto zero calibration, and then repeat it in the set cycle.



### 6.5.2 Forced run/stop of auto zero calibration

This mode is used to cancel the auto zero calibration forcibly.

- (1) In the User mode that is displayed, point the cursor to “Setting of Auto Zero Calibration” by pressing the  or  key. Press the  key.

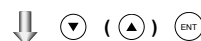

User Mode	Select an item with UP/DOWN and ENT Back with ESC
Changeover of Range Setting about Calibration Alarm Setting Setting of Auto Calibration <input checked="" type="checkbox"/> Setting of Auto Zero Calibration Setting of Peak Alarm Parameter Setting	

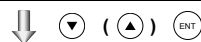

- (2) In the “Setting of Auto Zero Calibration” item selection screen that appears, point the cursor to “Stop Auto Zero Calibration” by pressing the  or  key. Press the key.

About Auto Zero Cal.	Select setting item
Start Time SUN 12:00 Cycle 07 day Flow Time 300 sec. ON/OFF OFF  Time : WED 16:19	
<input checked="" type="checkbox"/> Stop Auto Zero Calibration	



- (3) “Stop Auto Zero Calibration” is inverted. A message appears, prompting you to verify that you want to cancel or continue auto zero calibration. To cancel the auto zero calibration forcibly, press the  key. If you press the  key, auto zero calibration is cancel (not stopped).

About Auto Zero Cal.	Stop auto Zero calibration? Stop with ENT Not with ESC
Start Time SUN 12:00 Cycle 07 day Flow Time 300 sec. ON/OFF OFF  Time : WED 16:20	
Stop Auto Zero Calibration	

F6\_5\_2.ai

“Auto Zero Calibration” screen

Example

In case where setting the auto calibration components (see Item 6.2.5) to “CH1: enable” and “CH2: enable”.

- Zero calibration

A message, “Zero calibration” blinks at CH1 and CH2.

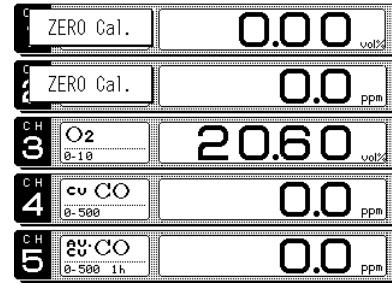

F6\_5\_2\_1.ai

### Caution

During auto zero calibration, any key operation is not permitted other than operations such as key lock ON/OFF and “Forced Stop of Auto Zero Calibration”.

When the key lock is set at “ON”, even the “Forced Stop of Auto Zero Calibration” cannot be used.





To stop “Auto Zero Calibration” forcedly, set the key lock to “OFF” and then execute “Stop Auto Zero Calibration”.

## 6.6 Peak alarm setting



When the number of peaks of which CO concentration exceeds the upper limit value exceeds the setting time, a peak alarm is outputted.

This section describes how to perform various settings of peak alarm.

Note) The setting is optional and is valid only when peak alarm function is provided.

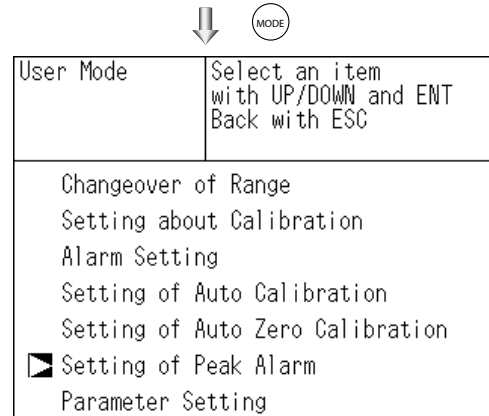

- (1) Press the  key in the Measurement mode, and the User mode appears.
- (2) Point the cursor to "Setting of Peak Alarm" by pressing the  or  key.  
Press the  key.

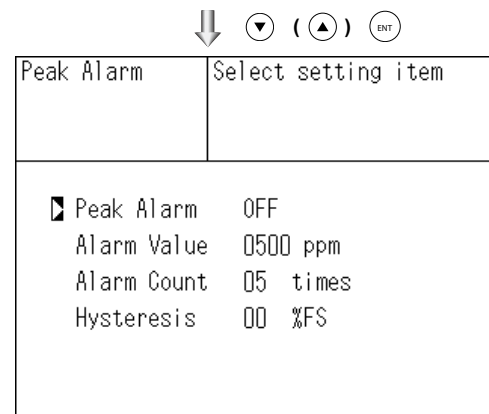

- (3) In the "Peak Alarm Setting" item selection screen that appears, point the cursor to any item you want to set by pressing the  or  key. Press the  key.



- (4) Then, enter numeric values and perform the setting.

Entering or setting the numeric values should be carried out by using the  or  key.

After setting, press the  key, and the set values you entered are saved.

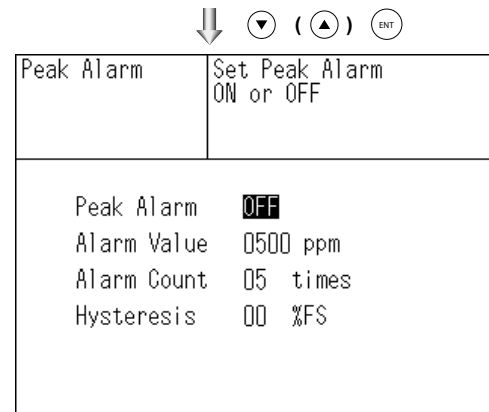

### Description of setting items

- Peak Alarm : Setting of peak alarm is performed with ON/OFF
- Alarm Value : If peak concentrations exceed the set alarm value, a peak counter counts 1 time.
- Alarm Count : When a peak in excess of the setting time occurs, a peak count alarm output is provided.
- Hysteresis : To prevent possible chattering when the peak value may exceed the set peak concentration by only 1 time, the peak count has an allowance in the hysteresis width.



## Setting range

- Alarm value : 0 to 1000 ppm → 5 ppm step (initial value: 500 ppm)
- Alarm count : 1 to 99 times (initial value: 5 times)
- Hysteresis : 0 to 20% of full scale (initial value: 0% of full scale)  
[% full scale] represents the percentage with the CO range regarded as 100%.

## Action of peak alarm

## Example

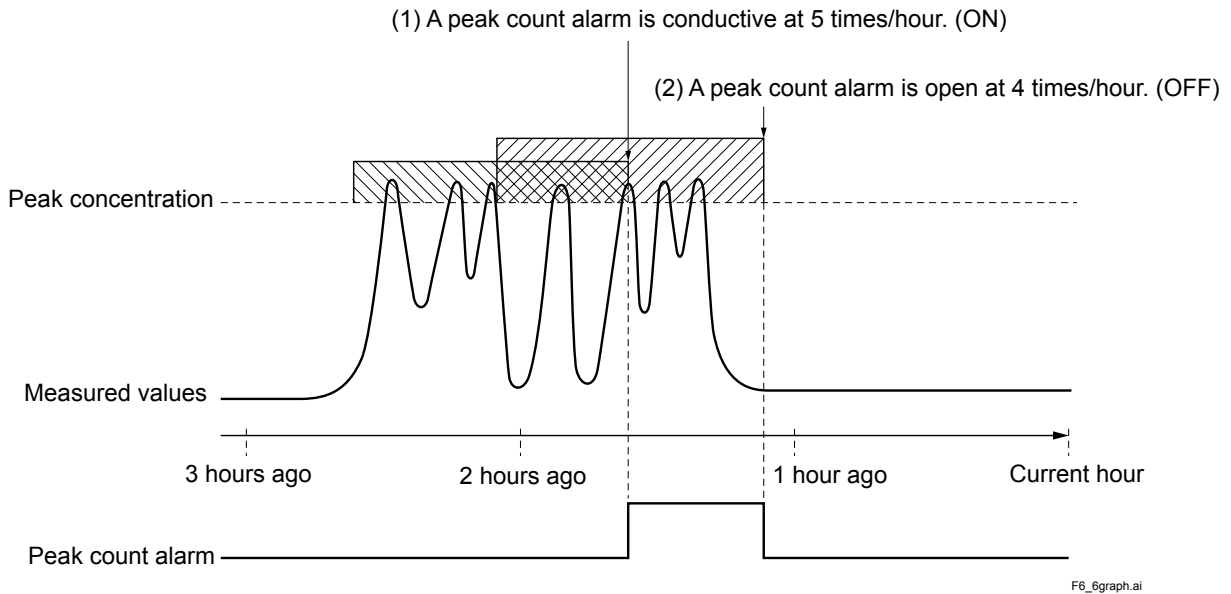

If CO concentration exceeds the alarm value, counting will begin. If the number of peaks is over the set times per hour, a peak alarm contact output becomes closed (ON). If it is less than the set times per hour, it is open (OFF). Since 5 times of peaks /hour is marked at (1) section from the above graph, the peak count alarm is turned ON. Since peaks of more than 5 times per 1 hour occur at the interval between (1) and (2) , the peak count alarm remains ON. Since at (2), peaks are reduced to 4 times per hour, it is turned OFF.

Like the hysteresis of the alarm setting, the hysteresis prevents possible chattering when measured gas is fluctuated near the alarm value.

\* For 10 minutes after the power is turned ON, a peak alarm counting is not carried out.

## Releasing peak count alarm

To release the peak count alarm, set the peak alarm to OFF.  
Turning on the peak alarm initiates counting from 0.

## 6.7 Parameter setting



It allows you to carry out the parameter setting such as time, key lock, etc., as required. Items to be set are as follows:

Description of setting items

- Current Time : Sets the current day of the week, hour and time.  
Note: The clock backup time is 2 days. If power is turned on after it is kept off for 2 days or longer, make the time setting again.
- Key Lock : Sets with ON/OFF so that any key operation except the key lock OFF cannot be performed.
- Remote Range : Sets with ON/OFF whether the Range Switching is made valid or invalid by external input.
- Output Hold : Sets whether Calibration Output is held or not.
- Reset Average Output : Resets the average value.
- Response time : Sets the response time of electrical system.
- Average Period : Sets the moving average time.
- Maintenance mode : Enters passwords to switch to the Maintenance mode.

\* For the maintenance mode, see Item 6.8.



(1) To display the User mode, press the  key in the measurement mode.

(2) Point the cursor to "Parameter Setting" by pressing the  or  key.



Press the  key.



User Mode	Select an item with UP/DOWN and ENT Back with ESC
Changeover of Range Setting about Calibration Alarm Setting Setting of Auto Calibration Setting of Auto Zero Calibration Setting of Peak Alarm  Parameter Setting	

(3) In the "Parameter Setting" screen that appears, point the cursor to any item you want to set by pressing the  or  key.

Press the  key.

Parameter Setting	Select setting item
 Current Time      WED 15:43 Key Lock            OFF Remote Range      OFF Output Hold        OFF Reset Av. Output    Reset Response Time Average Period To Maintenance Mode 0000	

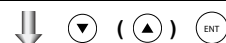

FE\_7-01



- (4). In the Parameter Setting screen that appears, enter the numeric values and set the items. Entering the numeric values or setting the items should be carried out by using the or key. To move the cursor to the right, press the key. After setting, press the key, that the parameter setting is carried out with the value you set.

Parameter Setting	Select setting item
Current Time	WED 15:43
Key Lock	OFF
Remote Range	OFF
Output Hold	OFF
Reset Av. Output	Reset
Response Time	
Average Period	
To Maintenance Mode	0000



F6\_7\_2.ai

End of Parameter Setting

To close Parameter Setting screen  
To close the "Parameter Setting" screen or cancel this mode midway, press the key. A previous screen will return.

- Setting Range**
- Response time : 1 to 60 sec. (initial value: 3 sec)
  - Average period : 1 to 59 min or 1 to 4 hours (initial value: 1 hour)  
When setting the unit of 1 to 59 minutes is terms of minute or 1 to 4 hours with hour
  - Maintenance mode : 0000 to 9999 (initial value: 0000)

**Remote Range**

A range can be switched via an external input by setting the Remote Range to ON. (The switching action affects all of instantaneous value, O<sub>2</sub> correction value, O<sub>2</sub> correction average value and O<sub>2</sub> average value). If the Remote Range is set to OFF, the external input becomes invalid. Opening the input gives the High range, or short-circuiting the input gives the Low range. For the terminal input, refer to 3.5, Wiring method. Switching the range cannot be performed by on-screen operation when the REMOTE RANGE is set to ON.  
Note) In case of 1 range system, this function is overridden.

**Output Hold**

By setting an output hold to ON, an output signal of each channel are held during the calibration (manual calibration and auto calibration) and for the gas flow time (refer to Item 6.4, Setting of Auto Calibration). Regardless of Hold ON/OFF setting, an output signal can be held via an external input.

**(1) Manual calibration**

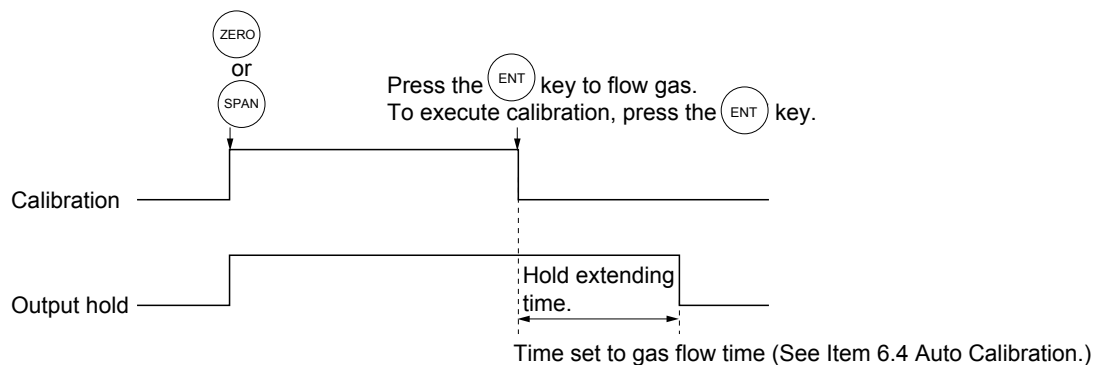

F6\_7\_1.ai

**(2) Auto calibration**

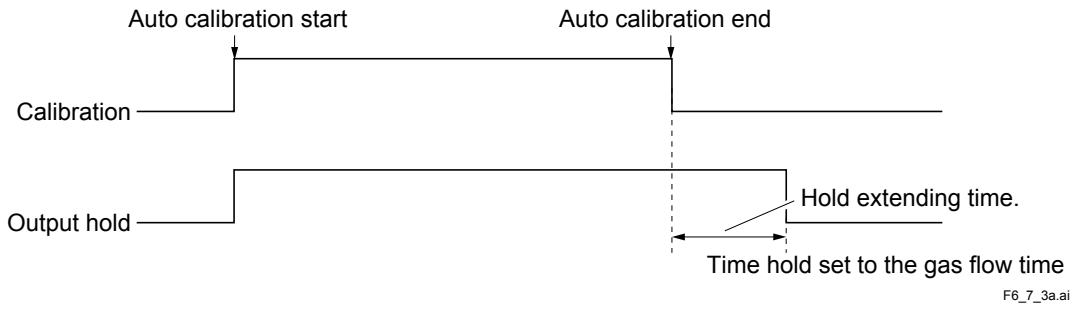

**(3) External hold**

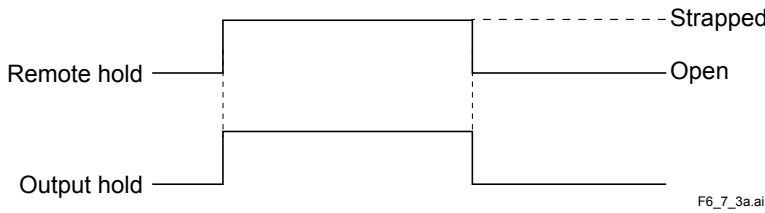

**(4) Screen display during Holding**

The "Holding" message blinks on the measuring screen.

Since the screen displays the process of calibration is displayed during the manual calibration, "Holding" is not displayed even if it is holding, but the screen is displayed with the hold extending time.

(5) If calibration is cancelled after the calibration gas is supplied regardless of manual calibration or auto calibration, an output hold will be performed during the holding extending time.

**Average value reset**

This mode is used to clear O<sub>2</sub> correction average value and O<sub>2</sub> average value, and restarts averaging. All average values are reset at a time. The indication value and output value is 0 ppm, vol% or so at the time of the reset input.

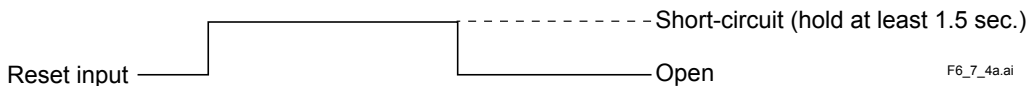

So long as short-circuited, resetting lasts.  
At the edge of changing from short circuit to opening, the average action restarts.

**Response time**

The response time of the electrical system can be changed.

Setting is available by components.

Note) It does not provide exact seconds for the setting time, but it gives a guide of the setting time.  
The setting value can be modified as requested by the customer.

Parameter Setting	Select CH No.
Response Time	
CH1 CO <sub>2</sub>	03 sec.
CH2 CO	03 sec.
CH3 O <sub>2</sub>	03 sec.

F6\_7\_5a.ai

### Average period

It allows you to set an average period of the average value of O<sub>2</sub> correction.

It enables you to set an average time of 1 to 59 minutes (1-minute step) or 1 to 4 hours (1-hour step).

Changing the setting resets the average value of O<sub>2</sub> correction and O<sub>2</sub> average value. (Pressing the ENT validates the resetting only for components whose setting was changed.)

Parameter Setting	Average Period	Set period of average output
CH5	AV:CO	01 hour
CH6	AV:O <sub>2</sub>	50 min

F6\_7\_6.ai

### Example of average action

Suppose the average period is 1 hour.

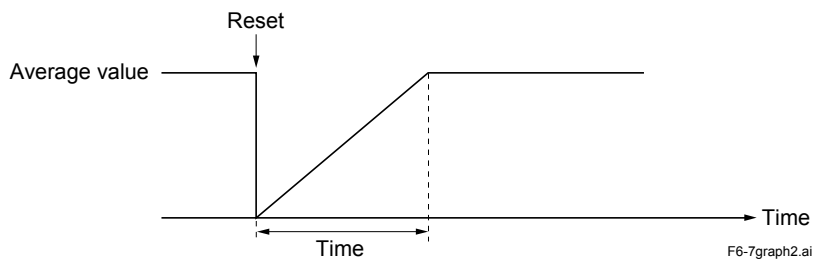

F6-7graph2.ai



- Sampling occurs every 30 seconds.
- Every 30 seconds, the average for last 1 hour (time setting) is output.
- At the instant of resetting, zero is assumed for all past values. It means that the average value will not be correct for 1 hour after resetting.

### Maintenance mode

To open the maintenance mode, enter a password. After entering the password, press the  key. The password can be used for the Password Setting in the Maintenance mode. A password is set to "0000" before factory-shipment. This value is available for the Maintenance mode.

## 6.8 Maintenance mode

Check of sensor input value, display of error log file, setting of O<sub>2</sub> correction reference value, adjustment of moisture interference, setting of auto off time of display backlight, and password setting can be performed as follows. A password is selected first. The password must be entered to perform measurement from next time onward. Select the maintenance mode in “6.7 Parameter setting,” and this screen is displayed. (Moisture interference adjustment is displayed only when NO of SO<sub>2</sub> is included in components to be analyzed.)

- (1) Select the Maintenance mode from the Parameter Setting screen to display the Password Setting screen.
  - (2) Enter the password, and the Maintenance Mode item selection screen will be displayed. Point the cursor to the item you want by pressing the  or  key and press the  key.
  - (3) Next, each Maintenance screen is displayed.
- Note) “To Factory Mode” is used for our service engineers only. Refrain from using this mode.

Maintenance Mode	Select operating item
<ul style="list-style-type: none"> <li>▣ 1. Sensor Input Value</li> <li>2. Error Log</li> <li>3. O<sub>2</sub> ref. Value 12%O<sub>2</sub></li> <li>4. Password Setting</li> <li>5. Station No.00</li> <li>6. Interference Compensation Adj.</li> <li>7. Backlight Timer OFF</li> <li>8. To Factory Mode</li> </ul>	

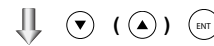

Each “Maintenance” screen

### • Sensor Input Value screen

Description of Sensor Input Value screen

- CO<sub>2</sub> : CO<sub>2</sub> sensor input value
- CO : CO sensor input value
- O<sub>2</sub> : O<sub>2</sub> sensor input value
- Temperature: Temperature sensor input value

Maintenance Sensor Input					
	sensor	input		sensor	input
	CO <sub>2</sub>	20291			
	CO	20433			
	O <sub>2</sub>	42471			
	TEMP	17906			

### • Error Log screen

Description of Error Log screen

Error history  
For error number, date and time (days, period) of occurrence, channel and other details of error, refer to “8 TROUBLESHOOTING”.

Maintenance Error Log	ENT:Clear Error Log ESC:Back
Error No.1 WED 14:38 Error No.10 WED 13:59 Error No.1 WED 13:59 Error No.10 WED 13:58 Error No.1 WED 13:58 Error No.10 WED 13:52 Error No.1 WED 13:52 ▼ Next page <span style="float: right;">Page. 1</span>	
<input checked="" type="checkbox"/> Clear Error Log	

F6\_8.ai

• O<sub>2</sub> correction reference value setting screen

Description of O<sub>2</sub> correction reference value setting screen

O<sub>2</sub> correction value is calculated from the following equation by values set herein:

O<sub>2</sub> correction concentration value

$$= \frac{21 - \text{set value}}{21 - \text{O}_2 \text{ concentration measured value}} \times \text{component concentration measured value}$$

↑

The value of the fractional part in this calculation is limited to 4.  
If it is 4 or more, it is fixed at 4.

Maintenance Mode	Set O <sub>2</sub> ref. Value
<ol style="list-style-type: none"> <li>1. Sensor Input Value</li> <li>2. Error Log</li> <li>3. O<sub>2</sub> ref. Value 12%O<sub>2</sub></li> <li>4. Password Setting</li> <li>5. Station No. 00</li> <li>6. Interference Compensation Adj.</li> <li>7. Backlight Timer OFF</li> <li>8. To Factory Mode</li> </ol>	

F6\_8gamen1.ai

Caution

- O<sub>2</sub> correction reference value : 00 to 19% in 1% step (initial value: 12%)

• Password Setting screen

Description of Password Setting screen

It enables you to set a password to be used when switching the parameter setting mode to the maintenance mode.

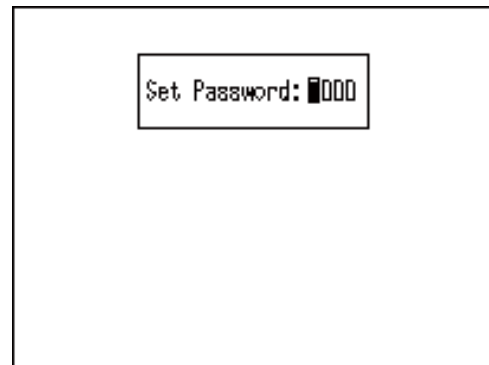

F6\_8gamen2.ai

Note) The password set herein must be managed for safety. Failure to enter the correct password will not open the Maintenance mode.

• Station No. setting screen (option)

Setting range

- Station No. : 00 to 31 (initial No.: 00).

Maintenance Mode	Set Station No. Allowable 00~31
<ol style="list-style-type: none"> <li>1. Sensor Input Value</li> <li>2. Error Log</li> <li>3. O<sub>2</sub> ref. Value 12%O<sub>2</sub></li> <li>4. Password Setting</li> <li>5. Station No. 00</li> <li>6. Interference Compensation Adj.</li> <li>7. Backlight Timer OFF</li> <li>8. To Factory Mode</li> </ol>	

F6\_8gamen3.ai

\* Please refer to another manual (IM 11G02P01-01E) about the communication function.

• **Moisture interference adjustment screen**

Description of moisture interference compensation adjustment screen

By setting the effect of moisture content in measured gas on this screen, the value of the effect is subtracted to find the measurement value. Adjustment is carried out by one of the following methods.

- Select a desired channel (CH) and change the value displayed at right.
- Select ALL and perform auto calculation for all the channels in batch.

Select RESET, and the interference compensation settings for all the channels are reset to 0.

\* See "7.4 Moisture interference compensation adjustment" for details of moisture interference compensation adjustment procedure.

Maintenance	Select CH No. ENT:Entry ESC:Back		
<input checked="" type="checkbox"/> CH1	NO	-7	+0532
<input type="checkbox"/> CH2	SO <sub>2</sub>	32	+0327
ALL			
RESET			

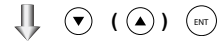

Maintenance	Adjust with UP/DOWN ENT:Memorized ESC:Back		
<input type="checkbox"/> CH1	NO	-7	+0532
<input type="checkbox"/> CH2	SO <sub>2</sub>	32	+0327
ALL			
RESET			

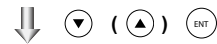

**End of moisture interference correction adjustment**

• **Backlight Timer setting screen**

Description of backlight timer setting screen

Automatic OFF of the backlight in the LCD can be selected. When the length of time set here elapses after the measurement screen appears, the backlight is automatically turned off.

Only when "ON" is selected, the time until automatic OFF is displayed. Press the key in this state, and you can change the time until auto backlight OFF. Press an arbitrary key while the backlight is kept off, and the backlight comes on again.

Maintenance Mode	Set ON or OFF
<ol style="list-style-type: none"> <li>1. Sensor Input Value</li> <li>2. Error Log</li> <li>3. O<sub>2</sub> ref. Value 12%O<sub>2</sub></li> <li>4. Password Setting</li> <li>5. Station No.00</li> <li>6. Interference Compensation Adj.</li> <li>7. Backlight Timer <input checked="" type="checkbox"/> 05 min.</li> <li>8. To Factory Mode</li> </ol>	

F6\_8\_2.ai

# 6.9 Calibration

## 6.9.1 Zero calibration

It is used for zero point adjustment. For zero calibration gas, see 3.4 (3), Preparation for standard gas in Sampling. Use a gas according to application.

- Press the **ZERO** key on the Measurement screen to display the Manual Zero Calibration screen.

- Select the CH (component) to be calibrated by pressing the **▲** or **▼** key. After selection, press the **ENT** key, and zero gas will be supplied.

**Caution**

For the Ch (components) that is set to “both” in the “Zero Calibration” of the Calibration Setting mode, zero calibration is also carried out at the same time.

- Wait until the indication is stabilized with the zero gas supplied. After the indication has been stabilized, press the **ENT** key. Zero calibration in Range selected by the cursor is carried out.

**To close Zero Calibration**

To close the “Zero Calibration “ or cancel this mode midway, press the **ESC** key. A previous screen will return.

↓ **ZERO**

ZERO Cal.		Select CH No. with UP/DOWN and ENT Back with ESC
CH1 CO <sub>2</sub>	▶Range1 0-10 vol% Range2 0-20 vol%	10.01
CH2 CO	▶Range1 0-500 ppm Range2 0-2000ppm	9.9
▶CH3 O <sub>2</sub>	▶Range1 0-10 vol% Range2 0-25 vol%	10.95

↓

ZERO Cal.		Select CH No. with UP/DOWN and ENT Back with ESC
▶CH1 CO <sub>2</sub>	▶Range1 0-10 vol% Range2 0-20 vol%	10.06
▶CH2 CO	▶Range1 0-500 ppm Range2 0-2000ppm	9.9
CH3 O <sub>2</sub>	▶Range1 0-10 vol% Range2 0-25 vol%	10.95

↓ **▼** (**▲**) **ENT**

ZERO Cal.		ENT:Go on calibration of selected CH ESC:Not calibration
CH1 CO <sub>2</sub>	▶Range1 0-10 vol% Range2 0-20 vol%	◀ 00.01
CH2 CO	▶Range1 0-500 ppm Range2 0-2000ppm	▶ 000.9
CH3 O <sub>2</sub>	▶Range1 0-10 vol% Range2 0-25 vol%	20.95

↓ **ENT**

**To Measurement screen after executing Manual Zero Calibration**

F6\_9\_1.ai

### 6.9.2 Span calibration

It is used to perform a span point adjustment. Supply calibration gas with concentration set to the span value to perform the span calibration. For the span calibration gas for the NO, SO<sub>2</sub>, CO<sub>2</sub>, CO, CH<sub>4</sub> measurement, use the standard gas with a concentration of 90% or more of the range value. For the calibration gas for the O<sub>2</sub> measurement, use the standard gas of 1 to 2 vol%.

- Press the **SPAN** key on the Measurement screen to display the Manual Span Calibration screen.

↓ **SPAN**

SPAN Cal.		Select CH No. with UP/DOWN and ENT Back with ESC
▶CH1 CO <sub>2</sub>	▶Range1 0-10 vol% Range2 0-20 vol%	10.06
CH2 CO	▶Range1 0-500 ppm Range2 0-2000ppm	9.9
CH3 O <sub>2</sub>	▶Range1 0-10 vol% Range2 0-25 vol%	10.95

- Press the **▲** or **▼** key to select CH (component) to be calibrated. After selection, press the **ENT** key, and the span calibration contact output on corresponding to CH is turned ON. And supply span gas.

↓

SPAN Cal.		Select CH No. with UP/DOWN and ENT Back with ESC
CH1 CO <sub>2</sub>	▶Range1 0-10 vol% Range2 0-20 vol%	10.06
▶CH2 CO	▶Range1 0-500 ppm Range2 0-2000ppm	9.9
CH3 O <sub>2</sub>	▶Range1 0-10 vol% Range2 0-25 vol%	10.95

**Caution**

When “both” from “Calibration Range” of the Calibration Setting mode is set, span calibration is performed together with 2 Ranges.

- Wait until the indication is stabilized in the state where the calibration gas is supplied. After the indication has been stabilized, press the **ENT** key. Span calibration of Range selected by the cursor is performed.

**To close Span Calibration**

To close the “Span Calibration” or cancel this mode midway, press the **ESC** key. A previous screen will return.

↓ **▼** (**▲**) **ENT**

SPAN Cal.		ENT:Go on calibration of selected CH ESC:Not calibration
CH1 CO <sub>2</sub>	▶Range1 0-10 vol% Range2 0-20 vol%	0.02
CH2 CO	▶Range1 0-500 ppm Range2 0-2000ppm	▶ 459.0
CH3 O <sub>2</sub>	▶Range1 0-10 vol% Range2 0-25 vol%	0.00

↓ **ENT**

**To Measurement screen after executing Manual Span Calibration**



---

Blank Page

# 7. MAINTENANCE

## 7.1 Daily check

### (1) Zero calibration and span calibration

1. It is used for zero point adjustment. For calibration, refer to 6.9.1, Zero calibration.
2. After zero calibration, perform span calibration. For calibration, refer to 6.9.2, Span calibration.
3. Zero calibration and span calibration should be performed once a week, if required.

### (2) Flow rate check

1. Sampling gas flow and purge gas flow are as follows:  
 Sampling gas flow:  $1.0 \pm 0.5$  L/min  
 Purge gas flow: About 1 L/min
2. Maintenance and check should be carried out every day, if required.

## 7.2 Daily check and maintenance procedures

Table 7.1 Maintenance and check list

	Parts to be checked	Phenomena	Causes	Remedy
Every day	Recorder indication	Indication values are lower. Indication values are higher.	(1) Dust is mixed in sampling cell	(1) Clean sampling cell and check for sampling device, especially gas filter.
			(2) Air is sucked in anywhere in the sampling tube.	(2) Check for leak of the sampling line and repair, if required.
	Check for purge gas flow if purging the sampling gas flow instrument.	Standard flow rate is 1 L/min. It is not within the range of the specified flow rate of 0.5 to 1.5 L/min.	_____	Adjust the flow rate with flow rater needle valve.
	Replacement of Monitor filter (membrane filter)	Much clogged	Primary filter is damaged.	(1) Replace primary filter. (2) Replace filter (filter paper).
Every week	Zero point of gas analyzer	Out of zero point	_____	Zero calibration
	Span point of gas analyzer	Out of the span point	_____	Span calibration
	Replacement of monitor filter (membrane filter)	Irrespective of phenomena	_____	Replace filter (paper).
Every year	Gas analyzer	Irrespective of phenomena	_____	Overhaul.

## 7.3 Replacement of power fuse

Note) Before fuse replacement, locate the probable cause of a blown fuse

- (1) Turn OFF the power switch.
- (2) Detach two mounting screws fastening to the top cover.

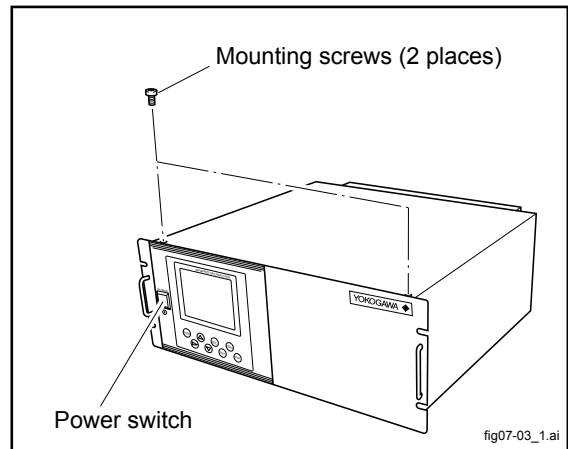

- (3) Slide the top cover backward, and pull it upward.

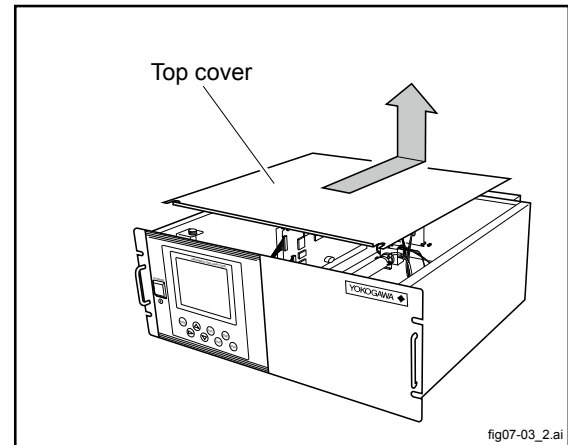

- (4) The fuse is arranged at the end of the left when viewing from the front panel. Pull the fuse upward while rotating the fuse holder cap counterclockwise to separate the cap and fuse from the fuse holder.
- (5) Replace the fuse with new one (fuse: 250 VAC/1 A delay type).
- (6) Screw the fuse holder cap in the fuse holder in the reverse procedure as the detachment of the top cover.

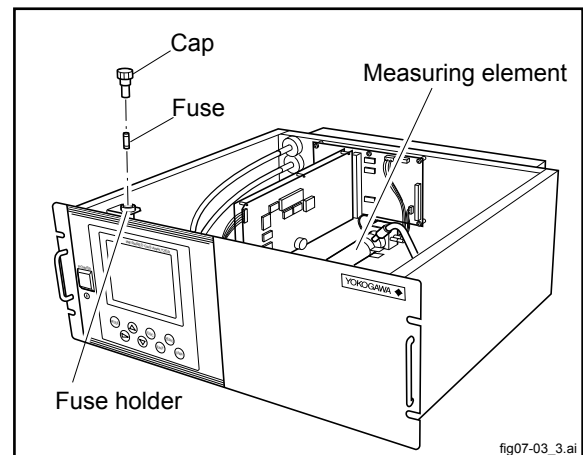

Part No. of fuse : K9218RB

## 7.4 Moisture interference compensation adjustment

(1) Be sure to carry out moisture interference compensation adjustment at the following timing when NO or SO<sub>2</sub> is included in components to be analyzed.

- 1) Before starting operation for the first time after the analyzer is incorporated into the system
- 2) At periodic inspection to be performed at 6 month to 1 year intervals
- 3) After the cell is cleaned

(2) Adjustment procedure (See “Moisture Interference Compensation Adjustment screen” in “6.8 Maintenance mode.”).

- 1) Set the moisture interference correction value to 0 in advance. (Press RESET on the moisture interference adjustment screen.)  
Select “Without” for moisture content in calibration gas. (See “6.2.2 Setting of calibration gas.”)
- 2) Perform zero/span calibration after warm-up operation of the main unit is completed.  
Calibrate zero gas and span gas also by feeding dry gas to the analyzer.
- 3) Perform bubbling (humidification) of zero gas, and feed it to the analyzer through the dehumidifier (such as electronic cooler) installed within the sampling system so that the moisture content becomes the same as that of the sample gas. (See the figure shown below.)
- 4) Select Moisture Interference Adjustment screen in “6.8 Maintenance mode”.
- 5) When the numeric value (measurement value) at left in the moisture interference adjustment screen (see figure at right) stabilizes, change the numeric value at right (interference correction value), adjusting so that the value falls within 0 ±10, and press the key to confirm the selection.

Maintenance	Adjust with UP/DOWN ENT:Memorized ESC:Back	
CH1 NO	-7	+0530
CH2 SO <sub>2</sub>	32	+0327
ALL		
RESET		

fig07-4\_1.ai

<How to feed gas for moisture interference adjustment>

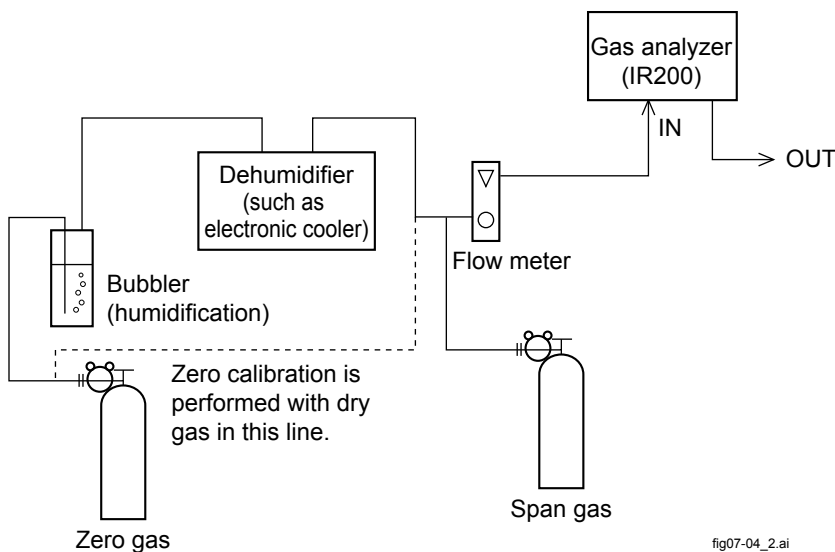

fig07-04\_2.ai

## 7.5 Cleaning of measuring cell

Entry of dust or water drops in the measuring cell contaminates the interior of the cell, thus resulting in a drift. Clean the inside if dirty. Then, check the sampling device, especially the filter, to prevent the cell from being contaminated by dust or mist.

### 7.5.1 Disassembly and assembly of measuring cell

There are two kinds of measuring cells, on block cells (cell length: 4 mm, 8 mm, 16 mm, 32 mm) and pipe cells (Cell length: 64 mm, 125 mm and 250 mm).

2-component analyzer may incorporate both measuring cells in optical unit. In such a case, detach the pipe cell and then block cell (See Fig. 7-1).

#### 1) How to remove pipe cell (See Fig. 7-1)

1. Stop measured gas. If it is harmful, purge in the measuring cell thoroughly with zero gas.
2. Turn OFF the power switch.
3. Detach the top cover.
4. Remove the pipe connected to the measuring cell.
5. Slide the infrared ray light source unit (No. 5) toward the front panel by loosening the screw (No. 1) fastened to the base plate to provide clearance between the pipe cell (No. 12) and light source unit.
6. Loosen and remove a screw (No. 7) from the cell retainer (No. 11) fastening the pipe cell.
7. Remove the cell from the measuring unit and unscrew the infrared transmission window (No.14) at the both ends in the right direction.

**Note) The reflection plate in the cell is not closely attached to the cell.**

8. For assembly, reverse the disassembly procedure. Provide 0.5 mm clearance between the infrared ray light source unit and cell, and the cell and detector, respectively.

No.	Name
1	Screw (for fixing light source unit)
2	Screw (for fixing detector)
3	Screw (for fixing base plate)
4	Base plate
5	Light source unit
6	Screw (for fixing support)
7	Screw (Fixing cell retainer)
8	Chopper motor connector
(9)	Filter
10	Support
11	Cell retainer
12	Pipe cell
13	O-ring
14	Infrared transmission window
15	Detector
16	Bridge PCB
17	Bridge resistance
(18)	Detector: Installed in 2-component analyzer only

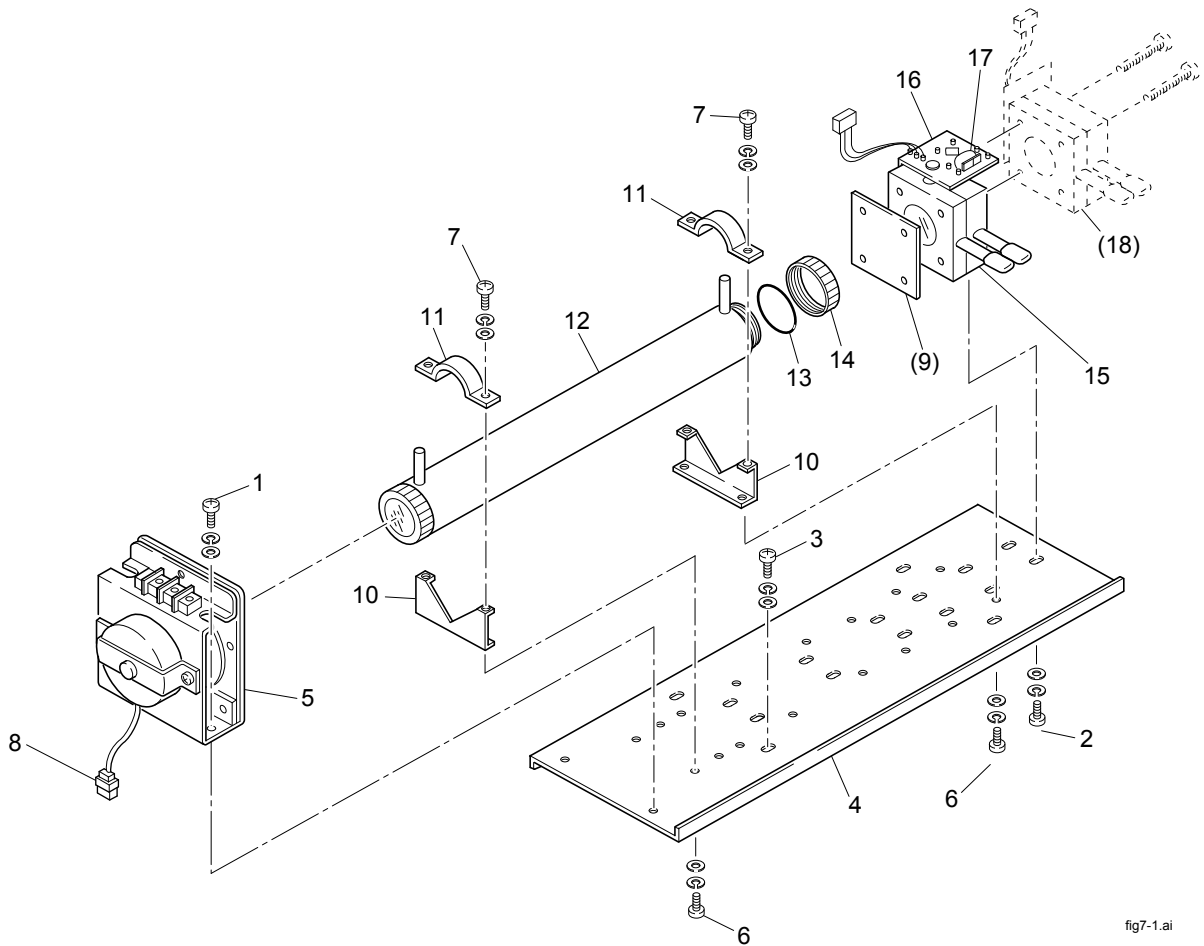

Fig. 7-1 Configuration of measuring unit (pipe cell)

fig7-1.ai

**2) How to remove block cell (See Fig. 7-2)**

1. For Step 1 to 4., see Item 7.5.1, (1) How to remove pipe cell.
5. Remove the connector to the detector output cord from the printed board. For the 2-component analyzer, remove the output cord connector of the 2-component analyzer detector (No.13) from the printed board, and then remove the 2-component detector by unscrewing two mounting screws (No. 14) fastening the 2-component detector.
6. Unscrew the two screws (No. 10) that hold the detector to the infrared ray light source unit to remove the detector from the measuring unit. The cell can be removed together with the detector.
7. To remove the cell, unscrew the two screws (No. 6) holding the cell to the detector. The infrared transmission window is just sandwiched (not fixed) between the detector and block cell. Keep the detector facing up, when removing this window.
8. For assembly, reverse the disassembly procedures.

**NOTE**

---

The O-ring is placed between the window holder and cell. Take care about the O-ring position. With 2-component analyzer, install 2-component detector last. Take care o that no space is left between the 1-component and 2-component detectors.

When inserting the detector output cord connector into the printed board, plug the connectors for 1-component detector and 2-component detector into position.

The 1-component connector should be plugged into CN11 and 2-component connector into CN1, respectively.

---

No.	Name
1	Screw (for fixing light source unit)
(2)	Filter
3	Screw (for fixing detector)
4	Base plate
5	Light source unit
6	Screw (for fixing support)
7	Block cell
8	Infrared transmission window (window holder)
9	Infrared transmission window (window holder)
10	Screw (for fixing base plate)
11	Chopper motors connector
12	Detector
(13)	Detector: Install in the 2-component analyzer
(14)	Screws: For mounting the 2-component detector

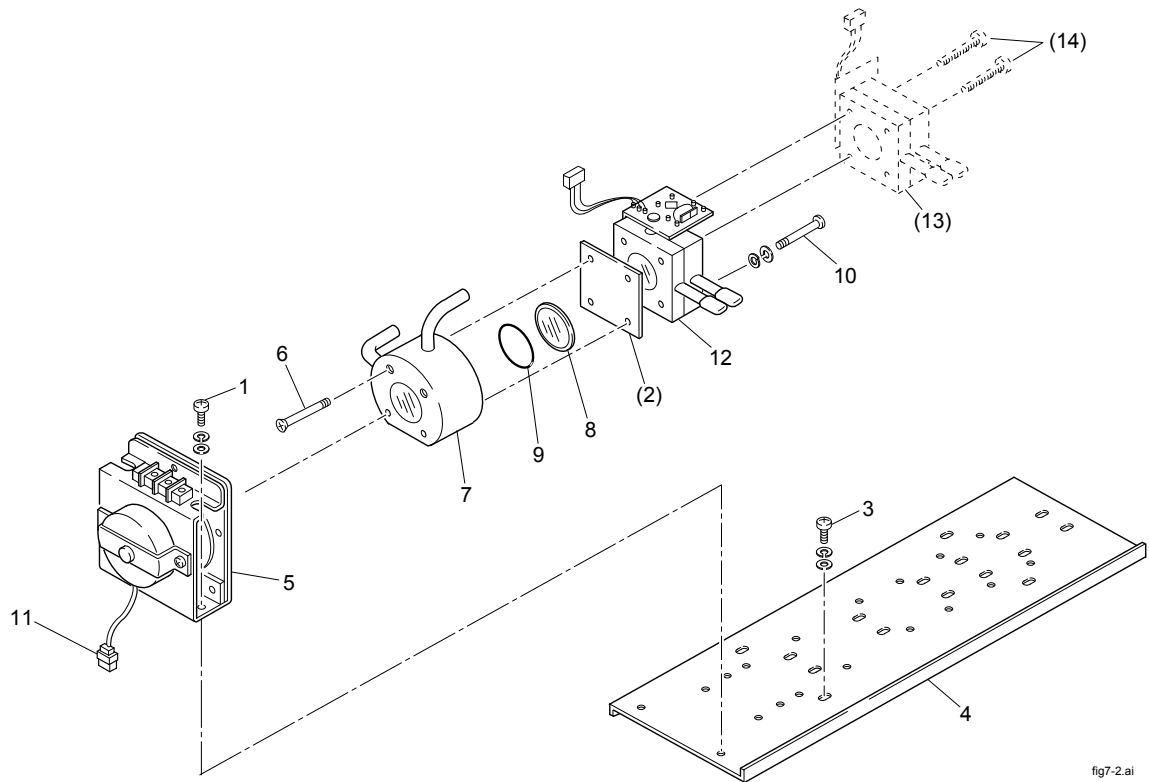

fig7-2.ai

**Fig. 7-2 Configuration of measuring unit (block cell)**



### 3) How to remove measuring unit (See Fig. 7-3)

1. For Step 1. to 4., see Item 7.5.1(1), How to remove pipe cell.5. Remove the detector output cord connector from the printed board.
6. Remove wiring to the 2-pin terminals of the infrared ray light source assembly and chopper motor pin connector (No. 8) from the printed board.
7. Detach the 4 screws (No. 3) fastening the base plate (No. 4) to remove the measuring unit.

**Note) Special care should be taken when assembling or disassembling the measuring cell to avoid the application of force to the detector pipe or infrared ray light source unit pipe. If the pipe is deformed or damaged by excessive force, there is a danger of gas leak, thus resulting in misoperation.**

No.	Name
1	Screw (for fixing light source unit)
2	Screw (for fixing detector)
3	Base plate
4	Light source unit
5	Screw (for fixing block cell)
6	Block cell
7	Infrared transmission window
8	O-ring
9	Detector
10	Detector
11	Support
12	Screw (Fixing cell retainer)
13	Cell retainer
14	Pipe cell
15	O-ring
16	Infrared transmission window
17	Screw (fixing detector)
18	Detector

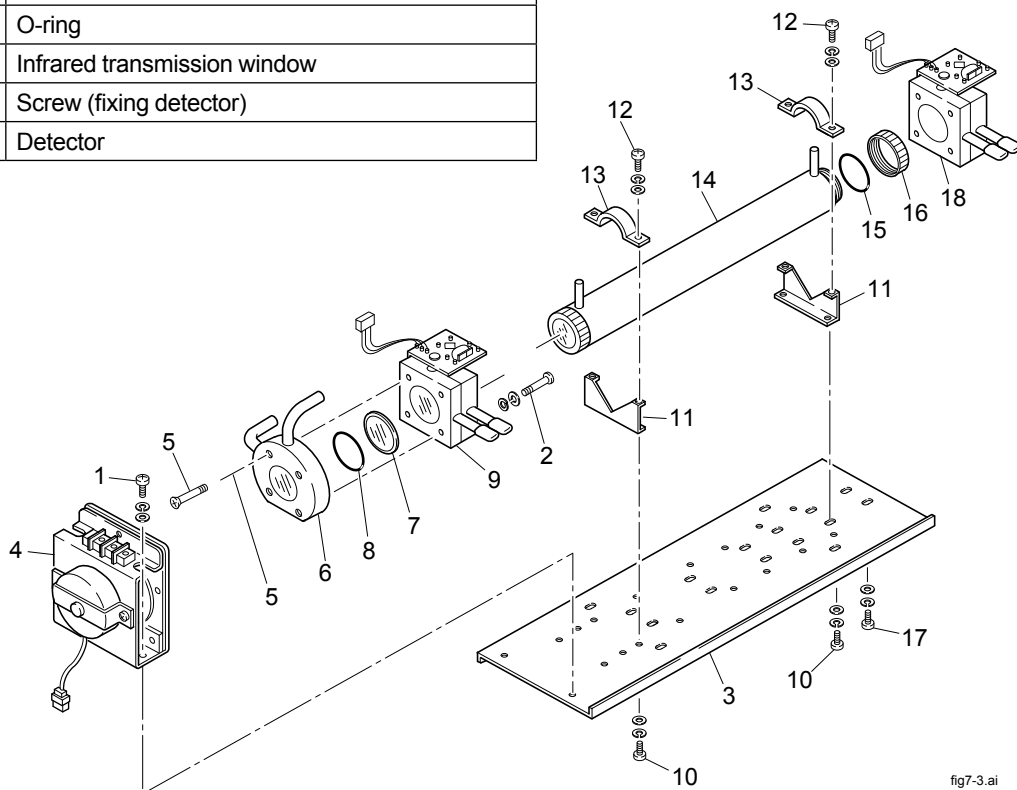

**Fig. 7-3 Configuration of measuring unit (2-component analyzer: block cell + pipe cell)**

### 7.5.2 How to clean cell

1. To clean the cell inside or infrared ray transmission window, first clear large dirt of it with a soft brush and then wipe with soft cloth lightly.  
Don't use hard cloth.

**Note) Handle the fragile window with care. Use care not to rub off the dirt from the window roughly.**

2. If the window or the cell interior is very dirty, use a soft cloth moistened with absolute alcohol.
3. If the window is corroded, rub off the scale from the window lightly with a soft cloth to which chrome oxide powder is applied. If it is excessively corroded, it should be replaced with new one.
4. When cell or window cleaning is completed, assemble according to the cell disassembly and assembly procedures. Especially, the pipe should be closely connected without gas leak, and repair if the pipe is bent.

## 7.6 Inspection and maintenance of limited service-life components

The analyzer uses limited-life components. The recommended replacement periods are listed in the below table.

1. Limited service-life components are those which wear out or for which failure is presumed within five years under normal operating or storage conditions. Components with more than five years of service life are the exception.
2. The previous table only involves the recommended periods for conducting preventive maintenance for limited service-life components; these periods do not guarantee that accidental failures will not occur.
3. The recommended replacement periods are tentative and depend on operating conditions.
4. The recommended replacement periods may vary depending on the field date.

Check point	Check and maintenance items	Procedure and criteria	Recommended check and maintenance periods							
			Routine	Once a week	Once a month	Every three months	Every six months	Once a year	Every two years	Every five years
Infrared gas analyzer	1. Light source	Recommended replacement period: Every five years (*1)								★
	2. Sector motor	Recommended replacement period: Every two years (*1)								★
	3. Detector without O <sub>2</sub> sensor	Recommended replacement period: Every five years (*1)								★
	4. O-ring	Recommended replacement period: Every two years, inspect it when cleaning of measuring cell. See Sec. 7.4						○		★
	5. LCD panel	Recommended replacement period: Every five years (*1)								★
	6. Power supply	Recommended replacement period: Every five years (*1)								★
	7. Measuring cell	Set up an appropriate maintenance period (by referring to the check results)				○				

(\*) In the check and maintenance columns, place a check mark (○) for check and confirmation work, a dark star (★) for replacement, and a white star (☆) for parts preparation for preventive maintenance.  
(\*1) These are work of service person, contact our service persons.

- **Precautions to be taken while checking**

- 1 When handling reference gas (during calibration), carefully read the reference-gas instruction manual to use the gas correctly. In particular, special attention must be taken in handling carbon monoxide gases; otherwise, you may suffer from gas poisoning.
- 2 During maintenance checks, be sure to keep the near fan on. If any gas leaks, you may suffer from gas poisoning.
- 3 When replacing the analyzer gas filter or conducting maintenance service of the washer, completely shut the calibration-gas valve. Otherwise, you may suffer from gas poisoning.

# 8. TROUBLE SHOOTING

## 8.1 Error message

If errors occur, the following contents are displayed.

Error display	Error contents	Probable causes
Error No.1	Sector motor rotation detector signal is faulty.	<ul style="list-style-type: none"> <li>Infrared ray light source is faulty.</li> <li>Sector motor rotation is faulty or stopped.</li> <li>Motor rotation detector circuit is faulty.</li> <li>Amplifier circuit is faulty.</li> </ul>
Error No.3	A/D conversion signal is faulty.	<ul style="list-style-type: none"> <li>Circuit is faulty.</li> </ul>
Error No.4	Zero calibration is not within the allowable range.	<ul style="list-style-type: none"> <li>Zero gas is not supplied.</li> <li>Zero point is deflected much due to dirty cell.</li> <li>Detector is faulty.</li> </ul>
Error No.5	A amount of zero calibration (indication value) is over 50% of full scale.	
Error No.6	Span calibration is not within the allowable range.	<ul style="list-style-type: none"> <li>Span gas is not supplied.</li> <li>Calibrated concentration setting does not match cylinder concentration.</li> <li>Zero calibration is not performed properly.</li> <li>Span is deflected much due to dirty cell.</li> <li>Detector sensitivity is deteriorated.</li> </ul>
Error No.7	A amount of span calibration (difference between indication value and calibrated concentration) is over 50% of full scale.	
Error No.8	Measured values fluctuate too much during zero and span calibration.	<ul style="list-style-type: none"> <li>Calibration gas is not supplied.</li> <li>Time for supplying calibration gas is short.</li> </ul>
Error No.9	Calibration is abnormal during auto calibration.	<ul style="list-style-type: none"> <li>Error corresponding to No. 4 to No. 8 occurred during auto calibration.</li> </ul>
Error No.10	Output cable connection is improper.	<ul style="list-style-type: none"> <li>Wiring is detached between analyzer and interface module.</li> <li>Wiring is disconnected between analyzer and interface module</li> </ul>



### NOTE

When errors No. 1 and No. 10 occur, instrument error output contacts are conductive.  
 When errors No. 4 to No. 9 occurs, calibration error output contacts are conductive.

### Screen display and operation at the occurrence of error

In case of Error No. 1 to No. 4, No. 6, No. 8 to No. 10

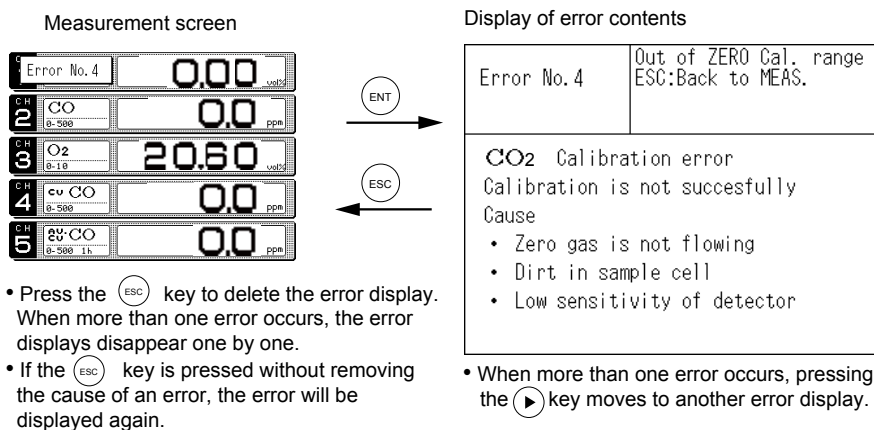

F08\_01.ai

In case of Error No. 5 and No. 7

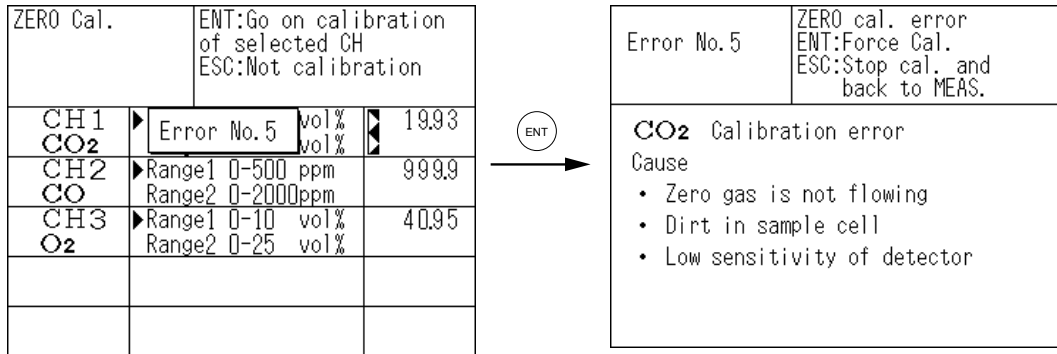

- Pressing **ESC** delete the error display.

Calibration is continued. Unless another calibration error occurs, calibration is carried out to the end, the Measurement screen returns.

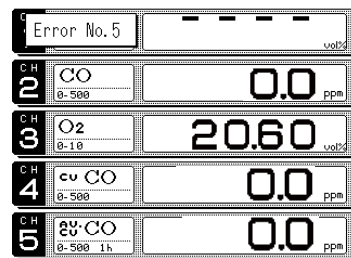

F8\_03.ai

**Error log file**

If error occurs, the history is saved in an error log file. The error log file exists in the maintenance mode.

**Error log screen**

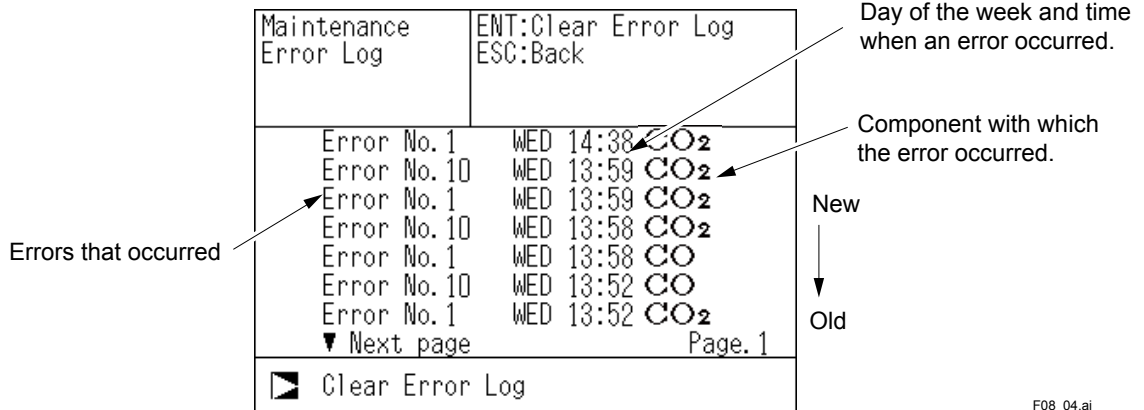

F08\_04.ai

\* Up to 14 errors can be saved in the error history; the oldest error will be deleted one by one every time a new occurs.  
 \* If the power supply is turned OFF, the contents in the error log file will not be lost or damaged.

**Deletion of error history**

Press the **ENT** key on the above screen, and the “Error Log Clear” will be inverted. Further pressing the key will clear the error history.

## 8.2 Other troubleshooting

The following table shows how to remedy other troubles, such as faulty readings.

Symptom	Checking Item	Remedy, etc.
Drift.	<ul style="list-style-type: none"> <li>• Check if the sample gas is supplied to the analyzer at the specified flow rate.</li> <li>• Check the optical system, e.g., the sample cell window, O-ring, detector window and inside of the cell for heavy dirt.</li> </ul>	<ul style="list-style-type: none"> <li>• Locate and check gas leaking points, and take the proper remedy. (See Section 3.3.)</li> <li>• Clean the cell and window. Replace the part. (See Section 7.5.)</li> </ul>
Readings are abnormally high	<ul style="list-style-type: none"> <li>• Check if the sample gas contains interfering components (water and CO<sub>2</sub>) in large quantities or not.</li> </ul>	<ul style="list-style-type: none"> <li>• Investigate the components of the sample gas and then contact our service person. See address information on the end cover.</li> </ul>
Readings do not increase	<ul style="list-style-type: none"> <li>• Check if the sample gas is supplied to the analyzer at the specified flow rate.</li> <li>• Check if the zero and span calibration is enabled.</li> </ul>	<ul style="list-style-type: none"> <li>• Locate and check gas leaking points, and take the proper remedy. (See Section 3.3.)</li> <li>• If enabled, sampling (check the points relating only to the sample gas and take the proper remedy.)</li> <li>• If not enabled, check the calibration related error items. (See Error Nos. 4 to 8 in Section 8.1.)</li> </ul>



# 9. SPECIFICATIONS

## 9.1 Specifications

### (1) Standard specifications

CO<sub>2</sub>, CO, CH<sub>4</sub>, SO<sub>2</sub>, NO: Non-dispersive infrared method Single light source-single beam  
 O<sub>2</sub>: Paramagnetic type (built-in), or zirconia type (external)

#### Measurable gas components and measuring range:

Component \ Range	Minimum range	Maximum range
CO <sub>2</sub>	0 – 500 ppm	0 – 100 vol%
CO	0 – 200 ppm	0 – 100 vol%
CH <sub>4</sub>	0 – 1000 ppm	0 – 100 vol%
SO <sub>2</sub>	0 – 500 ppm	0 – 5000 ppm
NO	0 – 50 ppm	0 – 5000 ppm
O <sub>2</sub> (paramagnetic)	0 – 5 vol%	0 – 100 vol%
O <sub>2</sub> (zirconia)	0 – 5 vol%	0 – 25 vol%

- Max. 4 components measurement including O<sub>2</sub>.
- 1 or 2 measuring range per component.
- Measuring range ratio ≤ 1:5 (except built in O<sub>2</sub>)  
 ≤ 1:20 (built in O<sub>2</sub>)

Max. 4 components and 2 ranges are selectable including an O<sub>2</sub> measurement.

For measurable components and possible combinations of measuring ranges, refer to Tables 1 to 8.

#### Measured value indication:

Digital indication in 4 digits (LCD with back light)

- Instantaneous value of each component
- Instantaneous value after O<sub>2</sub> correction (only in CO, SO<sub>2</sub>, NO measurement with O<sub>2</sub>)
- Average value after O<sub>2</sub> correction (only in CO, SO<sub>2</sub>, NO measurement with O<sub>2</sub>)
- O<sub>2</sub> average value

#### Analog output signals:

4 to 20 mA DC or 0 to 1 V DC, non-isolated output.

Analog output corresponds to measured value indication in 1:1.

Permissible load; 550 Ω max. for 4 to 20 mA DC 100 kΩ min. for 0 to 1 V DC

\* Refer to Table 6, for the channel No. of displayed values and analog output signals.

#### Analog input signal:

For signal input from externally installed O<sub>2</sub> sensor.

Signal requirement; (1) Signal from Yokogawa's Zirconia O<sub>2</sub> sensor  
 (Model: ZX8D\*C or ZX8D\*D)

(2) 0 to 1 V DC from an O<sub>2</sub> sensor.

Input section is not isolated. This feature is effective when an O<sub>2</sub> sensor is not built in.



## Relay Contact output:

1a contact (250 V AC/2 A, resistive load)

Instrument error, calibration error, range identification, auto calibration status and maintenance status, solenoid valve drive for auto calibration, pump ON/OFF.

1c contact (250 V AC/2 A, resistive load)

Upper/lower alarm contact output.

Peak count alarm contact output.

\* All relay contacts are isolated mutually and from the internal circuit.

Contact input: No-voltage contact (ON/0 V, OFF/5 V DC, 5 mA flowing at ON)

Remote range changeover, auto calibration remote start, remote holding, average value resetting

Isolated from the internal circuit with a photocoupler. Contact inputs are not isolated from one another.

\*Only M3.5 screw terminals are used for all signal inputs and outputs.

Power supply: Voltage rating ; 100 V to 240 V AC  
Allowable range ; 85 V to 264 V AC  
Frequency ; 50/60 Hz  
Power consumption; 700 VA max.  
Inlet ; Conform to EN60320, Protection Class I type

## Operation conditions:

Ambient temperature ; -5 to 45°C

Ambient humidity ; 90%RH max., non-condensing

## Storage conditions:

Ambient temperature ; -20 to 60°C

Ambient humidity ; 90%RH max., non-condensing

## Dimensions (H x W x D):

19-inch rack mounting type; 177 x 483 x 493 mm

Weight: Approx. 10 kg (only Analyzer)

Finish color: Front panel ; Off-white (Munsell 10Y7.5/0.5 or equivalent)  
Casing; Steel-blue (gray)

Enclosure: Steel casing, for indoor use

## Material of gas-contacting parts:

Gas inlet/outlet; SUS304

Sample cell; SUS304/neoprene rubber

Infrared-ray transmitting window; CaF<sub>2</sub>

Internal piping; Toaron, tube

Gas inlet/outlet: Rc1/4 or 1/4 NPT internal thread

Purge gas flow rate: 1 L/min ( when required)

Safety and EMC conforming standards:

Installation Altitude: 2000 m or less

Pollution degree: 2 (Note)

Installation category: II (Note)

Note: Installation category, called over-voltage category, specifies impulse withstanding voltage. Category II is for electrical equipment. Pollution degree indicates the degree of existence of solid, liquid, gas or other inclusions which may reduce dielectric strength. Degree 2 is the normal indoor environment.

Safety: EN61010-1

EMC: EN61326-1 Class A, Table 2,

EN61326-2-3, EN61000-3-2, EN61000-3-3

EMC Regulatory Arrangement in Australia and New Zealand (RCM)

EN61326-1 Class A

Note: The product mounted in a steel enclosure conforms to the requirements of EMC directive.

## CAUTION

---

This instrument is a Class A product, and it is designed for use in the industrial environment. Please use this instrument in the industrial environment only.

---

### (2) Standard functions

Output signal holding:

Output signals are held during manual and auto calibrations by activation of holding (turning on its setting).

The values to be held are the ones just before start calibration mode.

Indication of instantaneous values will not be held.

Remote output holding:

Output signal is held at the latest value or setting value by short-circuiting the remote output holding input terminals.

Holding is maintained while the terminals are short-circuited.

Indication of instantaneous values will not be held.

Remote range changeover:

Measuring range can be changed according to an external signal when remote range changeover input is received.

Changeover is effective only when remote range setting is turned on.

In this case, measuring range cannot be changed manually.

When the contact input terminals for each component are short-circuited, the first range is selected, and it is changed over to the second range when the terminals are open.

Range identification signal:

The present measuring range is identified by a contact signal.

The contact output terminals for each component are short-circuited when the first range is selected, and when the second range is selected, the terminals are open.

Auto calibration: Auto calibration is carried out periodically at the preset cycle.

When a standard gas cylinder for calibration and a solenoid valve for opening/closing the gas flow line are prepared externally by the customer, calibration will be carried out with the solenoid valve drive contacts for zero calibration and each span calibration turned on/off sequentially at the set auto calibration timing.

**Auto calibration cycle setting:**

Auto calibration cycle is set.

Setting is variable within 1 to 99 hours (in increments of 1 hour) or 1 to 40 days (in increments of 1 day).

**Gas flow time setting:**

The time for flowing each calibration gas in auto calibration is set.

Settable within 60 to 599 seconds (in increments of 1 second)

**Auto calibration remote start:**

Auto calibration is carried out only once according to an external input signal.

Calibration sequence is settable in the same way as the general auto calibration.

Calibration starts when a non-voltage rectangular wave is applied to the auto calibration remote start input terminals (opened after short-circuiting for 1.5 seconds or longer). Auto calibration is started when the contacts open.

**Auto zero calibration:**

Auto zero calibration is carried out periodically at the preset cycle.

This cycle is independent on "Auto calibration" cycle.

When zero calibration gas and solenoid valve for opening/closing the calibration gas flow line are prepared externally by the customer, zero calibration will be carried out with the solenoid valve drive contact for zero calibration turned on/off at the set auto zero calibration timing.

**Auto zero calibration cycle setting:**

Auto zero calibration cycle is set.

Setting is variable within 1 to 99 hours (in increments of 1 hour) or setting is variable within 1 to 40 days (in increments of 1 day)

**Gas flow time setting:**

The timing for flowing zero gas in auto zero calibration is set.

Settable 60 to 599 seconds (in increments of 1 second)

**Upper/lower limit alarm:**

Alarm contact output turns on when the preset upper or lower limit alarm value is reached.

Contacts close when the channel value of each channel becomes larger than the high alarm limit value or smaller than the low alarm limit value.

**Instrument error contact output:** Contacts close at occurrence of analyzer error No. 1, 3 or 10.

**Calibration error contact output:**

Contacts close at occurrence of manual or auto calibration error (any of errors No. 4 to 9).

**Auto calibration status contact outputs:** Contacts close during auto calibration.

**Pump ON/OFF contact output:**

During measurement, this contact close.

While calibration gas is flowing, this contact open. This contact is connected in power supply of pump, and stop the sample gas while calibration gas flowing.

**(3) Optional functions**

O<sub>2</sub> correction:

Correction of measured NO, SO<sub>2</sub> and CO gas concentrations into values at reference O<sub>2</sub> concentration

Correction formula:  $C = \frac{21-On}{21-Os} \times Cs$

C : Sample gas concentration after O<sub>2</sub> correction

Cs : Measured concentration of sample gas

Os : Measured O<sub>2</sub> concentration

On : Reference O<sub>2</sub> concentration (value changeable by setting)

\*The upper limit value of the fractional part in this calculation is 4.

The result of calculation is indicated and output in an analog output signal.

Average value after O<sub>2</sub> correction and O<sub>2</sub> average value calculation:

The result of O<sub>2</sub> correction or instantaneous O<sub>2</sub> value can be outputted as an average value in the preset period of time.

Used for averaging is the moving average method in which sampling is carried out at intervals of 30 seconds.

(Output is updated every 30 seconds. It is the average value in the determined period of time just before the latest updating.)

Averaging time is settable within 1 to 59 minutes (in increments of 1 minute) or 1 to 4 hours (in increments of 1 hour).

Average value resetting:

The above-mentioned output of average value is started from the initial state by applying a non-voltage rectangular wave to the average value resetting input terminals (opened after short-circuiting for 1.5 seconds or longer).

Output is reset by short-circuiting and restarted by opening.

CO concentration peak count alarm:

(added only for CO + O<sub>2</sub> measurement)

Alarm output turns on according to the preset concentration and count.

Whenever the instantaneous value of CO exceeds the preset concentration value, count increments. If the count exceeds the preset value in one hour, the alarm contacts close.

Communication function:

RS-232C (9 pins D-sub), Half-duplex bit serial, Start-stop synchronization, Modbus™ protocol

Contents : Read/Wright parameters, Read measurement concentration and instrument status

Remark : When connecting via RS-485 interface, an RS-232C ← →RS-485 converter should be used.

**(4) Performance**

Repeatability : ±0.5% of full scale

Linearity : ±1% of full scale

Zero drift : ±2% of full scale/week

Span drift : ±2% of full scale/week

Response time (for 90%FS response) :

1 or 2 component measurement;

Within 15 seconds including replacement time of sample gas

More than 2 component measurement;

Within 30 seconds including replacement time of sample gas

**Interference from other gases:**

Interference component	CO <sub>2</sub> analyzer	CO analyzer	CH <sub>4</sub> analyzer	SO <sub>2</sub> analyzer	NO analyzer	Built-in paramagnetic O <sub>2</sub> analyzer
CO 1000 ppm	≤ 1%FS	—	≤ 1%FS	≤ 1%FS	≤ 1%FS	—
CO <sub>2</sub> 15%	—	( ≤ 1%FS for 200 ppm analyzer, ≤ 2.5%FS )	≤ 1%FS	≤ 1%FS	≤ 1%FS	≤ 2%FS
H <sub>2</sub> O saturation at 20°C	≤ 1%FS	( ≤ 1%FS for 500 ppm analyzer, ≤ 2.5%FS )	≤ 1%FS	—	—	—
H <sub>2</sub> O saturation at 2°C	—	( ≤ 2.5%FS for 200 ppm analyzer )	—	( ≤ 50 ppm *≤ 2%FS with interference compensation )	( ≤ 60 ppm *≤ 2%FS with interference compensation )	—
CH <sub>4</sub> 1000 ppm	≤ 1%FS	≤ 1%FS	—	≤ 50 ppm	—	—

\* The H<sub>2</sub>O interference of NO and SO<sub>2</sub> analyzer can be reduced by the interference compensation.

**(5) Standard Requirements for Sample Gas**

Flow rate : 1 ± 0.5 L/min

Temperature : 0 to 50°C

Pressure : 10 kPa or less (Gas outlet side should be open to the atmospheric air.)

Dust : 100 µg/Nm<sup>3</sup> in particle size of 0.3 µm or less

Mist : Unallowable

Moisture : Below a level where saturation occurs at room temperature (condensation unallowable). Below a level to cause saturation at 2°C for CO measurement with 0 to 200 ppm range and SO<sub>2</sub> measurement.

Corrosive component: HCl, H<sub>2</sub>S, HF : 1 ppm or less

Standard gas for calibration:

Zero gas ; Dry N<sub>2</sub>

Span gas ; Each sample gas having concentration 90 to 100% of its measuring range (recommended).

Gas beyond concentration 100%FS is unusable.

In case a zirconia O<sub>2</sub> analyzer is installed externally and calibration is carried out on the same calibration gas line:

Zero gas ; Dry air or atmospheric air (provided without CO<sub>2</sub> sensor)

Span gas ; For other than O<sub>2</sub> measurement, each sample gas having concentration 90 to 100% of its measuring range.

For O<sub>2</sub> measurement, O<sub>2</sub> gas of 1 to 2 vol%.

It is understood that a large quantity of hydrogen, helium, or argon in sample gas affects the calibration model of an infrared gas analyzer (pressure broadening).

When measuring such sample gas, use a gas which has similar composition to the sample gas as a span gas.

---

**(6) Installation Requirements**

- Use this instrument .(Select a place where the equipment does not receive direct sunlight, draft/ rain or radiation from hot substances.)
- Avoid a place where receives heavy vibration.
- Select a place where atmospheric air is clean.

## 9.2 Model and Suffix codes

[Style: S3]

Model	Suffix code	Option code	Description
IR200			Infrared gas analyzer 19-inch rack mounting type with slide rail
Measurable components (note 8)	-A -B -C -D -E -F -G -H -J -K -L -M		SO <sub>2</sub> CO CO <sub>2</sub> CH <sub>4</sub> NO CO <sub>2</sub> +CO CH <sub>4</sub> +CO CO <sub>2</sub> +CH <sub>4</sub> CO <sub>2</sub> +CO+CH <sub>4</sub> NO+SO <sub>2</sub> NO+CO <sub>2</sub> NO+SO <sub>2</sub> +CO
O <sub>2</sub> Analyzer	N 1 2 3		Without O <sub>2</sub> analyzer External zirconia type O <sub>2</sub> sensor (purchase separately: ZX8D ) External O <sub>2</sub> analyzer (note 1) Built-in paramagnetic type O <sub>2</sub> sensor
1st Component 1st Range (note 2)	A B C D E F G H J K L M P Q R S T		0 - 200 ppm (note 3) 0 - 500 ppm (note 4) 0 - 1000 ppm 0 - 2000 ppm 0 - 2500 ppm 0 - 5000 ppm 0 - 1% 0 - 2% 0 - 3% 0 - 5% 0 - 10% 0 - 20% 0 - 25% 0 - 40% 0 - 50% 0 - 70% 0 - 100%
1st Component 2nd Range (note 2)	B C D E F G H K L M P R T N		0 - 500 ppm 0 - 1000 ppm 0 - 2000 ppm 0 - 2500 ppm 0 - 5000 ppm 0 - 1% 0 - 2% 0 - 5% 0 - 10% 0 - 20% 0 - 25% 0 - 50% 0 - 100% Not available
2nd Component 1st Range (note 2)	B C D E F G H J K L M P Q R S T N		0 - 500 ppm 0 - 1000 ppm 0 - 2000 ppm 0 - 2500 ppm 0 - 5000 ppm 0 - 1% 0 - 2% 0 - 3% 0 - 5% 0 - 10% 0 - 20% 0 - 25% 0 - 40% 0 - 50% 0 - 70% 0 - 100% Not available

continued to next page

Model	Suffix code	Option code	Description
IR200	-□□□□□		Infrared gas analyzer 19-inch rack mounting type with slide rail
2nd Component 2nd Range (note 2)	C D E F G H K L M P R T N		0 - 1000 ppm 0 - 2000 ppm 0 - 2500 ppm 0 - 5000 ppm 0 - 1% 0 - 2% 0 - 5% 0 - 10% 0 - 20% 0 - 25% 0 - 50% 0 - 100% Not Available
3rd Component 1st Range (note 2)	B C D E F G H J K L M P Q R S T N		0 - 500 ppm 0 - 1000 ppm 0 - 2000 ppm 0 - 2500 ppm 0 - 5000 ppm 0 - 1% 0 - 2% 0 - 3% 0 - 5% 0 - 10% 0 - 20% 0 - 25% 0 - 40% 0 - 50% 0 - 70% 0 - 100% Not available
3rd Component 2nd Range (note 2)	C D E F G H K L M P R T N		0 - 1000 ppm 0 - 2000 ppm 0 - 2500 ppm 0 - 5000 ppm 0 - 1% 0 - 2% 0 - 5% 0 - 10% 0 - 20% 0 - 25% 0 - 50% 0 - 100% Not available
O <sub>2</sub> Analyzer 1st Range (note 2)	1 2 3 4 5 N		0 - 5% 0 - 10% 0 - 25% 0 - 50% 0 - 100% Not available
O <sub>2</sub> Analyzer 2nd Range (note 2)	2 3 4 5 N		0 - 10% 0 - 25% 0 - 50% 0 - 100% Not available
Output	-4 -1		4 - 20 mA DC, non-isolation 0 - 1 V DC, non-isolation
Piping	R T		Rc 1/4 1/4 NPT
Indication, Power Cable (note 6)	J E U		Japanese, Power Cable; rated voltage 125 V AC English, Power Cable; rated voltage 125 V AC (UL) English, Power Cable; rated voltage 250 V AC (CEE)
Option	O <sub>2</sub> Correction and O <sub>2</sub> Average (note 5) Peak count alarm (note 5) Communication Internal Purge	/K /A /C /P	With O <sub>2</sub> correction and O <sub>2</sub> average value With peak count alarm (CO gas Only) RS2232C (note 7) Analyzer internal purging

Footnotes:

- 1: A signal from the external O<sub>2</sub> analyzer should be 0-1 V DC linear to full scale.
- 2: Possible combinations of ranges are specified in separate tables.
- 3: Only available for CO measurement.
- 4: Only available for CO<sub>2</sub>, CO, SO<sub>2</sub> or NO measurements.
- 5: O<sub>2</sub> correction is available only for CO, SO<sub>2</sub>, and NO. Both average value output after O<sub>2</sub> correction and average O<sub>2</sub> value output are provided at the same time.  
A peak count alarm can be provided only for CO measurement.
- 6: Suffix Codes "E" and "U" are power cables with different voltage rating and plug type. Select appropriate code according to the operating power supply voltage to be used in the field.  
Suffix Code "E" is of the North American plug type and "U" of the European type.
- 7: Should be specified when using Modbus™ communication.
- 8: For NOx measurement, a NO<sub>2</sub>/NO converter (P/N K9350LE or K9350LF) should be purchased separately.



Measurable component and range - availability check table -

Table 1 Single-component analyzer (CO<sub>2</sub>, CO, CH<sub>4</sub>, SO<sub>2</sub>, NO)

2nd range \ 1st range		B	C	D	E	F	G	H	K	L	M	R	T
		0-500 ppm	0-1000 ppm	0-2000 ppm	0-2500 ppm	0-5000 ppm	0-1%	0-2%	0-5%	0-10%	0-20%	0-50%	0-100%
<b>A</b>	0-2000 ppm	○	○	—	—	—	—	—	—	—	—	—	—
<b>B</b>	0-500 ppm	—	◎○□★	◎○□★	◎○□★	—	—	—	—	—	—	—	—
<b>C</b>	0-1000 ppm	—	—	◎○△□★	◎○△□★	◎○△□★	—	—	—	—	—	—	—
<b>D</b>	0-2000 ppm	—	—	—	◎○△□★	◎○△□★	◎○△	—	—	—	—	—	—
<b>E</b>	0-2500 ppm	—	—	—	—	◎○△□★	◎○△	—	—	—	—	—	—
<b>F</b>	0-5000 ppm	—	—	—	—	—	◎○△	◎○△	—	—	—	—	—
<b>G</b>	0-1%	—	—	—	—	—	—	◎○△	◎○△	—	—	—	—
<b>H</b>	0-2%	—	—	—	—	—	—	◎○△	◎○△	◎○△	—	—	—
<b>J</b>	0-3%	—	—	—	—	—	—	◎○△	◎○△	◎○△	—	—	—
<b>K</b>	0-5%	—	—	—	—	—	—	—	◎○△	◎○△	◎○△	—	—
<b>L</b>	0-10%	—	—	—	—	—	—	—	—	◎○△	◎○△	◎○△	—
<b>M</b>	0-20%	—	—	—	—	—	—	—	—	—	◎○△	◎○△	◎○
<b>P</b>	0-25%	—	—	—	—	—	—	—	—	—	—	◎○△	◎○
<b>Q</b>	0-40%	—	—	—	—	—	—	—	—	—	—	◎○△	◎○△
<b>R</b>	0-50%	—	—	—	—	—	—	—	—	—	—	—	◎○△
<b>S</b>	0-70%	—	—	—	—	—	—	—	—	—	—	—	◎○△
<b>T</b>	0-100%	—	—	—	—	—	—	—	—	—	—	—	◎○△

◎ : CO<sub>2</sub> analyzer measurable range    ○ : CO analyzer measurable range    △ : CH<sub>4</sub> analyzer measurable range  
 □ : SO<sub>2</sub> analyzer measurable range    ★ : NO analyzer measurable range  
 \* Note : Single range is also available.

Table 2 Two-component analyzer (CO<sub>2</sub> and CO)

1st component \ 2nd component (CO), 1st range →		CO													
		B	C	D	E	F	G	H	K	L	M	P	R	T	
↓ (CO <sub>2</sub> ), 1st range		0-500 ppm	0-1000 ppm	0-2000 ppm	0-2500 ppm	0-5000 ppm	0-1%	0-2%	0-5%	0-10%	0-20%	0-25%	0-50%	0-100%	
<b>CO<sub>2</sub></b>	<b>F</b>	0-5000 ppm	—	◎	◎	◎	◎	◎	◎	◎	◎	◎	◎	◎	○
	<b>G</b>	0-1%	◎	◎	◎	◎	◎	◎	◎	◎	◎	◎	◎	◎	○
	<b>H</b>	0-2%	◎	◎	◎	◎	◎	◎	◎	◎	◎	◎	◎	◎	○
	<b>K</b>	0-5%	◎	◎	◎	◎	◎	◎	◎	◎	◎	◎	◎	◎	○
	<b>L</b>	0-10%	◎	◎	◎	◎	◎	◎	◎	◎	◎	◎	◎	◎	○
	<b>M</b>	0-20%	◎	◎	◎	◎	◎	◎	◎	◎	◎	◎	◎	◎	○
	<b>R</b>	0-50%	—	◎	◎	◎	◎	◎	◎	◎	◎	◎	◎	◎	○
	<b>T</b>	0-100%	—	○	○	○	○	○	○	○	○	○	○	○	○

○ : Available as single range,    ◎ : 2 ranges of 2 or 2.5 times each range available

Table 3 Two-component analyzer (CH<sub>4</sub> and CO)

1st component \ 2nd component (CO), 1st range →		CO													
		B	C	D	E	F	G	H	K	L	M	P	R	T	
↓ (CH <sub>4</sub> ), 1st range		0-500 ppm	0-1000 ppm	0-2000 ppm	0-2500 ppm	0-5000 ppm	0-1%	0-2%	0-5%	0-10%	0-20%	0-25%	0-50%	0-100%	
<b>CH<sub>4</sub></b>	<b>F</b>	0-5000 ppm	—	◎	◎	◎	◎	◎	○	◎	◎	◎	◎	—	—
	<b>G</b>	0-1%	—	◎	◎	◎	◎	◎	○	◎	◎	◎	◎	○	○
	<b>H</b>	0-2%	◎	◎	◎	◎	◎	◎	◎	◎	◎	◎	◎	◎	○
	<b>K</b>	0-5%	◎	◎	◎	◎	◎	◎	◎	◎	◎	◎	◎	◎	○
	<b>L</b>	0-10%	◎	◎	◎	◎	◎	◎	◎	◎	◎	◎	◎	◎	○
	<b>M</b>	0-20%	—	—	◎	◎	◎	◎	◎	◎	◎	◎	◎	◎	○
	<b>R</b>	0-50%	—	—	—	—	◎	◎	◎	◎	◎	◎	◎	◎	○
	<b>T</b>	0-100%	—	—	—	—	—	○	○	○	○	○	○	○	○

○ : Available as single range,    ◎ : 2 ranges of 2 or 2.5 times each range available

**Table 4 Two-component analyzer (CO<sub>2</sub> and CH<sub>4</sub>)**

		2nd component (CH <sub>4</sub> ), 1st range → CH <sub>4</sub>												
		B	C	D	E	F	G	H	K	L	M	P	R	T
1st component ↓ (CO <sub>2</sub> ), 1st range		0-500 ppm	0-1000 ppm	0-2000 ppm	0-2500 ppm	0-5000 ppm	0-1%	0-2%	0-5%	0-10%	0-20%	0-25%	0-50%	0-100%
CO <sub>2</sub>	D 0-2000 ppm	—	—	—	⊙	⊙	⊙	⊙	⊙	⊙	—	—	—	—
	E 0-2500 ppm	—	—	—	⊙	⊙	⊙	⊙	⊙	⊙	—	—	—	—
	F 0-5000 ppm	—	—	—	⊙	⊙	⊙	⊙	⊙	⊙	⊙	—	—	—
	G 0-1%	⊙	⊙	⊙	⊙	⊙	⊙	⊙	⊙	⊙	⊙	⊙	—	—
	H 0-2%	⊙	⊙	⊙	⊙	⊙	⊙	⊙	⊙	⊙	⊙	⊙	⊙	—
	K 0-5%	⊙	⊙	⊙	⊙	⊙	⊙	⊙	⊙	⊙	⊙	⊙	⊙	○
	L 0-10%	⊙	⊙	⊙	⊙	⊙	⊙	⊙	⊙	⊙	⊙	⊙	⊙	○
	M 0-20%	⊙	⊙	⊙	⊙	⊙	⊙	⊙	⊙	⊙	⊙	⊙	⊙	○
	R 0-50%	—	⊙	⊙	⊙	⊙	⊙	⊙	⊙	⊙	⊙	⊙	⊙	○
	T 0-100%	—	○	○	○	○	○	○	○	○	○	○	○	○

○ : Available as single range, ⊙ : 2 ranges of 2 or 2.5 times each range available

**Table 5 Two-component analyzer (NO and SO<sub>2</sub>)**

		2nd component (SO <sub>2</sub> ), 1st range → SO <sub>2</sub>				
		B	C	D	E	F
1st component ↓ (NO), 1st range		0-500 ppm	0-1000 ppm	0-2000 ppm	0-2500 ppm	0-5000 ppm
NO	B 0-500 ppm	○	○	○	○	○
	C 0-1000 ppm	○	○	○	○	○
	D 0-2000 ppm	○	○	○	○	○
	E 0-2500 ppm	○	○	○	○	○
	F 0-5000 ppm	○	○	○	○	○

○ : Two components measurable range. 1st component ; NO, 2nd component ; SO<sub>2</sub>  
 \* 1st range (low range) must meet the combination in above table.  
 2nd range, both NO and SO<sub>2</sub> measurements are up to 5 times of the 1st range, and 2nd max. range is 0 to 5000 ppm.

**Table 6 Two-component analyzer (NO and CO)**

		2nd component (CO), 1st range → CO						
		A	B	C	D	E	F	G
1st component ↓ (NO), 1st range		0-200 ppm	0-500 ppm	0-1000 ppm	0-2000 ppm	0-2500 ppm	0-5000 ppm	0-1%
NO	B 0-500 ppm	○	○	○	○	○	○	○
	C 0-1000 ppm	○	○	○	○	○	○	○
	D 0-2000 ppm	○	○	○	○	○	○	○
	E 0-2500 ppm	○	○	○	○	○	○	○
	F 0-5000 ppm	—	○	○	○	○	○	○

○ : Two components measurable range. 1st component ; NO, 2nd component ; CO  
 \* 1st range (low range) must meet the combination in above table.  
 2nd range, both NO and CO measurements are up to 5 times of the 1st range.  
 2nd max. range of NO is 0 to 5000ppm.  
 2nd max. range of CO<sub>2</sub> is 0 to 1%.

**Table 7 Three-component analyzer (CO<sub>2</sub> + CO + CH<sub>4</sub> and NO + SO<sub>2</sub> + CO)**

See Table 4 for CO<sub>2</sub> + CH<sub>4</sub> measurement of three-component analyzer (CO<sub>2</sub> + CO + CH<sub>4</sub>) and Table 5 for NO + SO<sub>2</sub> measurement of three-component analyzer (NO + SO<sub>2</sub> + CO).  
 See Table 1 for CO measurement.

Table 8 O<sub>2</sub> analyzer

1st range \ 2nd range		2	3	4	5
		0-10%	0-25%	0-50%	0-100%
1	0-5%	○△	○△	○	—
2	0-10%	—	○△	○	○
3	0-25%	—	—	○	○
4	0-50%	—	—	—	○
5	0-100%	—	—	—	○

○ : Built-in O<sub>2</sub> analyzer measurable range,

△: External zirconia type O<sub>2</sub> analyzer (in this case, Yokogawa's ZX8D Style C)

\* O<sub>2</sub> analyzer is selectable indifferently to combination with other components.

Table 9. Measurable Components and Their Corresponding Channel Numbers

Suffix/Option Code			Output and Corresponding Channel							
Measurable component	O <sub>2</sub> analyzer	O <sub>2</sub> correction	CH1	CH2	CH3	CH4	CH5	CH6	CH7	CH8
-A	N	Not specified	SO <sub>2</sub>							
-B	N	Not specified	CO							
-C	N	Not specified	CO <sub>2</sub>							
-D	N	Not specified	CH <sub>4</sub>							
-E	N	Not specified	NO							
-F	N	Not specified	CO <sub>2</sub>	CO						
-G	N	Not specified	CH <sub>4</sub>	CO						
-H	N	Not specified	CO <sub>2</sub>	CH <sub>4</sub>						
-J	N	Not specified	CO <sub>2</sub>	CO	CH <sub>4</sub>					
-K	N	Not specified	NO	SO <sub>2</sub>						
-L	N	Not specified	NO	CO						
-M	N	Not specified	NO	SO <sub>2</sub>	CO					
-A	1,2,3	Not specified	SO <sub>2</sub>	O <sub>2</sub>						
-B	1,2,3	Not specified	CO	O <sub>2</sub>						
-C	1,2,3	Not specified	CO <sub>2</sub>	O <sub>2</sub>						
-D	1,2,3	Not specified	CH <sub>4</sub>	O <sub>2</sub>						
-E	1,2,3	Not specified	NO	O <sub>2</sub>						
-F	1,2,3	Not specified	CO <sub>2</sub>	CO	O <sub>2</sub>					
-G	1,2,3	Not specified	CH <sub>4</sub>	CO	O <sub>2</sub>					
-H	1,2,3	Not specified	CO <sub>2</sub>	CH <sub>4</sub>	O <sub>2</sub>					
-J	1,2,3	Not specified	CO <sub>2</sub>	CO	CH <sub>4</sub>	O <sub>2</sub>				
-K	1,2,3	Not specified	NO	SO <sub>2</sub>	O <sub>2</sub>					
-L	1,2,3	Not specified	NO	CO	O <sub>2</sub>					
-M	1,2,3	Not specified	NO	SO <sub>2</sub>	CO	O <sub>2</sub>				
-A	1,2,3	/K	SO <sub>2</sub>	O <sub>2</sub>	Correct SO <sub>2</sub>	Correct SO <sub>2</sub> av.	O <sub>2</sub> av.			
-B	1,2,3	/K	CO	O <sub>2</sub>	Correct CO	Correct CO av.	O <sub>2</sub> av.			
-E	1,2,3	/K	NOx	O <sub>2</sub>	Correct NOx	Correct NOx av.	O <sub>2</sub> av.			
-F	1,2,3	/K	CO <sub>2</sub>	CO	O <sub>2</sub>	Correct CO	Correct CO av.	O <sub>2</sub> av.		
-G	1,2,3	/K	CH <sub>4</sub>	CO	O <sub>2</sub>	Correct CO	Correct CO av.	O <sub>2</sub> av.		
-J	1,2,3	/K	CO <sub>2</sub>	CO	CH <sub>4</sub>	O <sub>2</sub>	Correct CO	Correct CO av.	O <sub>2</sub> av.	
-K	1,2,3	/K	NOx	SO <sub>2</sub>	O <sub>2</sub>	Correct NOx	Correct SO <sub>2</sub>	Correct NOx av.	Correct SO <sub>2</sub> av.	O <sub>2</sub> av.
-L	1,2,3	/K	NOx	CO	O <sub>2</sub>	Correct NOx	Correct CO	Correct NOx av.	Correct CO av.	O <sub>2</sub> av.
-M	1,2,3	/K	NOx	SO <sub>2</sub>	CO	O <sub>2</sub>	Correct NOx	Correct SO <sub>2</sub>	Correct CO	O <sub>2</sub> av.

\* How to Read the Table

"SO<sub>2</sub>" in the CH1 column means that the display and output of CH1 correspond to SO<sub>2</sub> component. "Correct XX" means an instantaneous XX value after O<sub>2</sub> correction, "Correct XX av." an average XX value after O<sub>2</sub> correction, and "O<sub>2</sub> av." an average O<sub>2</sub> value.

**STANDARD ACCESSORIES**

Item	Part No.	Description	Qty
Power cable	K9218SA	Standard inlet type (2.5 m)	1
Fuse	K9218RB	Replacement fuse (250 V AC, 1 A, delay type) x 1	2
Slide rail	K9218RC	Slide rail x 1	2

Note: Quantity in this table is the number of accessories supplied as standard.  
 For instance, two K9218RC parts, i.e., two slide rails, are supplied as standard.  
 When ordering separately, the required number of parts should be considered.

**9.3 External Dimensions**

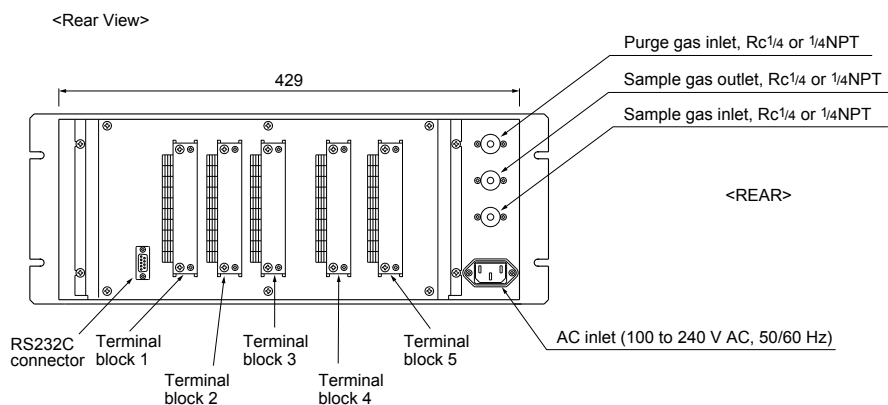
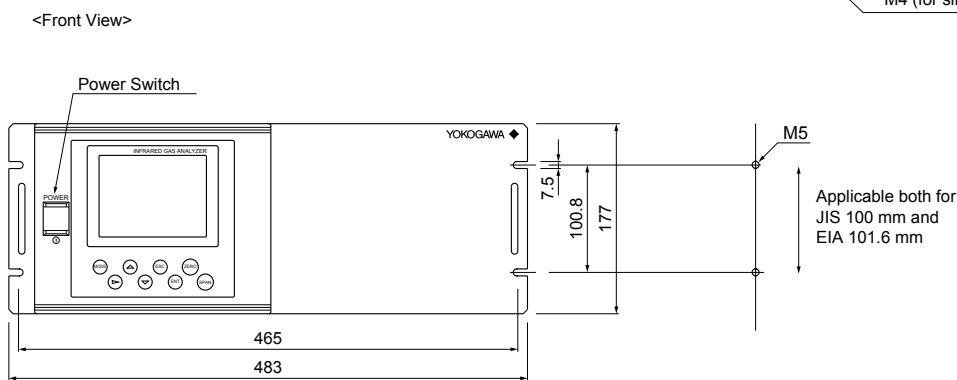
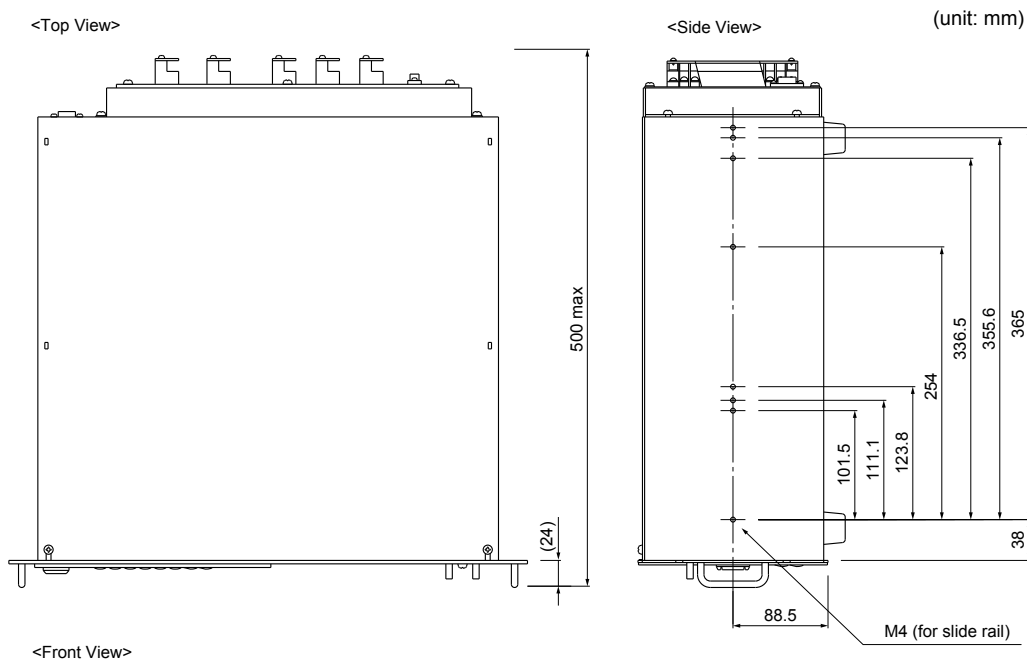

F04.ai

(2) Accessory slide rail

Model : 305A-20/Accuride International Inc.

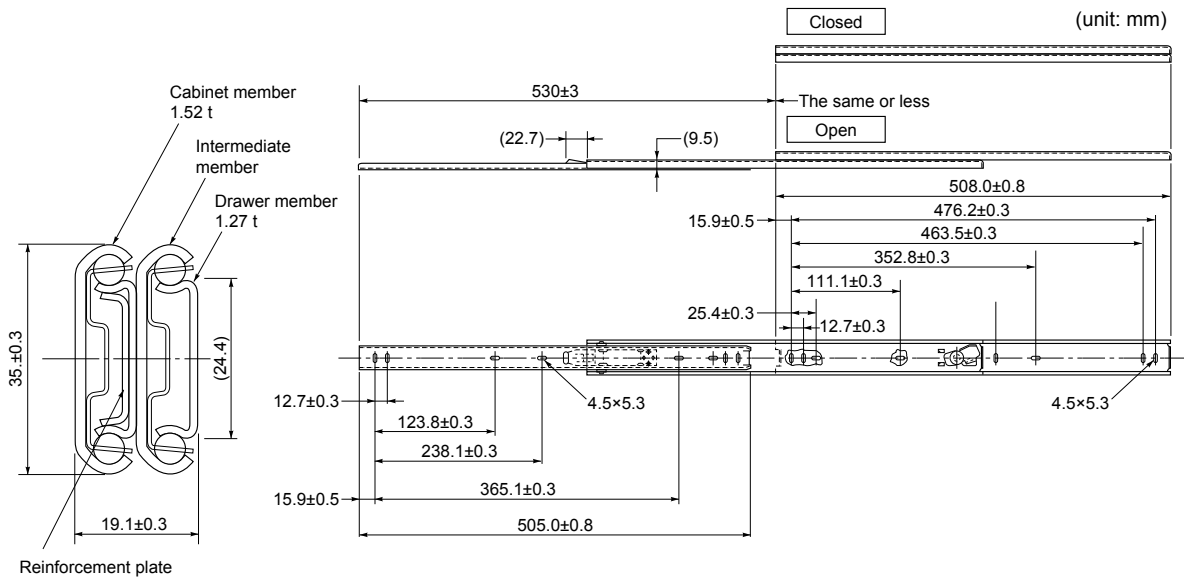

19-inch rack mounting method:

The mass of the instrument should be supported at the bottom of the unit (or the side of the unit when mounted with the slide rails).

Also, for facilitate maintenance, a structure which allows extraction of the main unit by using the slide rail is recommended.

Slide rail mounted type

Guide rail mounted type

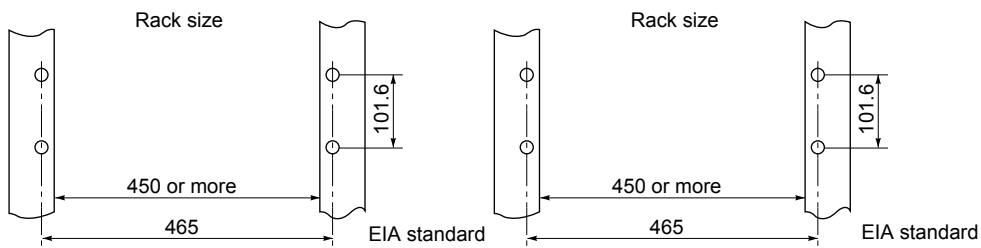

Mounting diagram

Mounting diagram

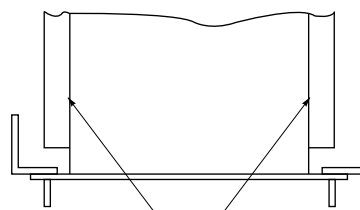
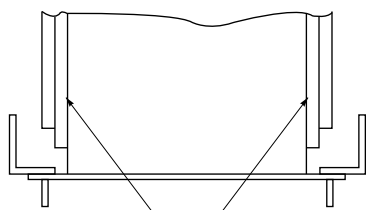

Slide rails

Guide rails

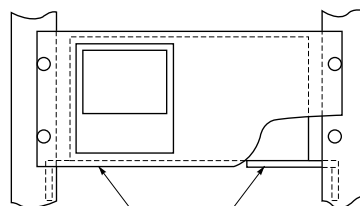
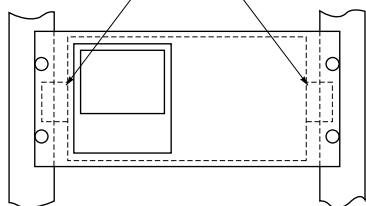

Guide rails

For the guide rail mounted type, a maintenance space (200 mm or more) should be provided on top of the main unit.

F06.ai

**Dedicated Zirconia O<sub>2</sub> Sensor (to be purchased separately)**

For O<sub>2</sub> correction, the IR200 can accept linealized 0 to 1 V DC signal coming from an analyzer calibrated to 0 to 25% O<sub>2</sub> of full scale. Dedicated zirconia O<sub>2</sub> sensor, Model ZX8D, is available from Yokogawa.

Measuring method: Zirconia system

Measurable component and measuring range:

Measurable component	Minimum range	Maximum range
Oxygen (O <sub>2</sub> )	0 - 5 vol%	0 - 25 vol%

Repeatability: Within ±0.5% of full scale

Linearity: Within ±1% of full scale

Zero drift: Within ±1% of full scale/week

Span drift: Within ±2% of full scale/week

Response time: Approx. 20 seconds (for 90% response)

Sample gas flow rate: 0.5 ±0.25 L/min

Note: The Zirconia system, due to its principle, may produce a measuring error depending on the relative concentration versus the combustible O<sub>2</sub> gas concentration. Also, a corrosive gas (SO<sub>2</sub> of 250 ppm or more, etc.) may affect the life of the sensor

Gas inlet/outlet size: Rc1/4

Power supply: 90 to 126 V AC or 200 to 240 V AC, 50/60 Hz

Enclosure: Steel casing, for indoor application

Indication: Temperature indication (LED)

Temperature alarm output:

Contact output 1a contact, Contact capacity 220 V AC, 1 A (resistive load)

Safety and EMC conforming standards:

Installation Altitude: 2000 m or less

Pollution degree: 2 (Note)

Installation category: II (Note)

Note: Installation category, called over-voltage category, specifies impulse withstanding voltage. Category II is for electrical equipment. Pollution degree indicates the degree of existence of solid, liquid, gas or other inclusions which may reduce dielectric strength. Degree 2 is the normal indoor environment.

Safety: EN61010-1

EMC: EN61326-1 Class A, Table 2 (For use in industrial locations), EN61326-2-3, EN61000-3-2, EN61000-3-3

 **CAUTION**

This instrument is a Class A product, and it is designed for use in the industrial environment. Please use this instrument in the industrial environment only.

Dimensions (H x W x D): 140 x 170 x 190 mm

Weight: Approx. 3 kg

Finish color: Munsell 5Y 7/1

**Model and MS Codes**

Model	Suffix code	Option code	Description
ZX8D	-----	-----	Dedicated zirconia O <sub>2</sub> sensor
Power supply	-5 -3	----- -----	90-126 V AC, 50/60 Hz 200-240 V AC, 50/60 Hz
Style code	*C *D	----- -----	Style C (Non-CE conformity) Style D (CE conformity)

**External Dimensions of ZX8D**

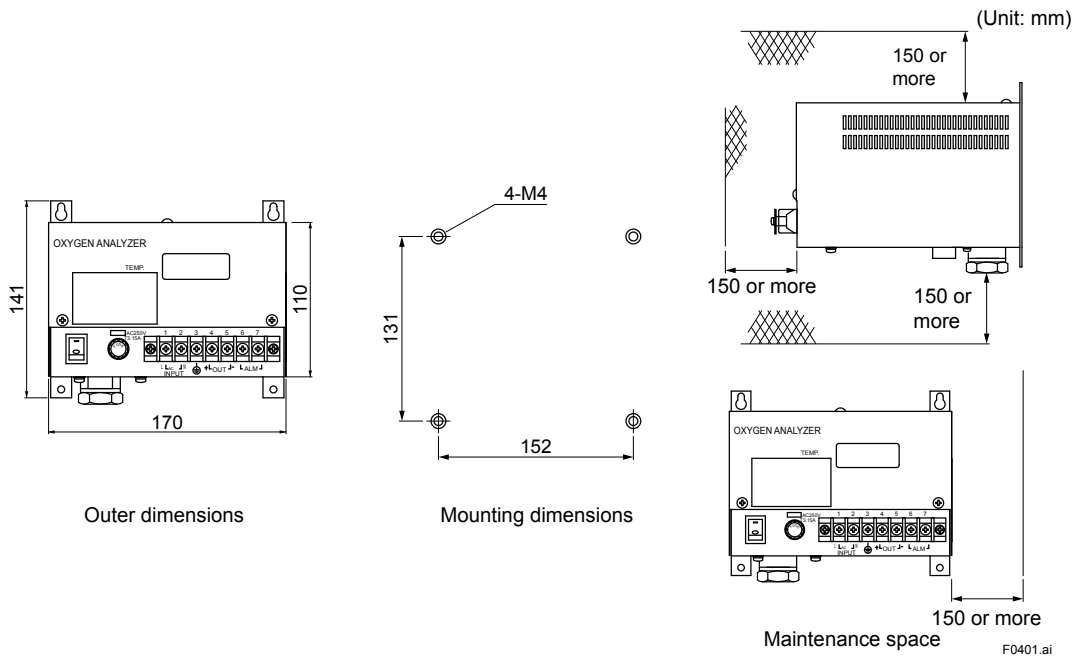

**External Connection Diagram**

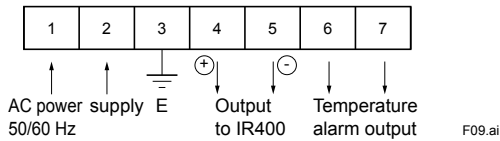

**Caution on Safety**  
 Before using this product, be sure to read its instruction manual in advance.

**NO<sub>2</sub>/NO Converter**

- Part number: K9350LE (Non-CE conformity), K9350LF (CE conformity)
- Mounting: Indoor surface mounting
- Target Gases: General boiler exhaust gas, atmosphere
- Catalyst: Amount; 2 cm<sup>3</sup>  
Replacement cycle; Approx. 12 months (at flow rate of 0.3 L/min with 5%O<sub>2</sub>, 10 ppm NO)  
Temperature set-point; 210 ± 10°C (Sensing tip: K thermocouple)
- Wetted materials: Ceramic, Viton, glass filter, SUS316
- Conversion efficiency: 90% or higher, conforms to JIS
- Gas Flow Rate: 0.5 L/min
- Ambient Temperature: -5 to 45°C
- Power Supply: 100 V AC , 50/60 Hz (K9350LE), 100 to 240 V AC , 50/60 Hz (K9350LF)
- Power Consumption: Approx. 85 VA

**Safety and EMC conforming standards:**

- Installation Altitude: 2000 m or less
- Pollution degree: 2 (Note)
- Installation category: II (Note)

Note: Installation category, called over-voltage category, specifies impulse withstanding voltage. Category II is for electrical equipment. Pollution degree indicates the degree of existence of solid, liquid, gas or other inclusions which may reduce dielectric strength. Degree 2 is the normal indoor environment.

Safety: EN61010-1

EMC: EN61326-1 Class A, Table 2 (For use in industrial locations), EN61326-2-3, EN61000-3-2, EN61000-3-3

 **CAUTION**

This instrument is a Class A product, and it is designed for use in the industrial environment. Please use this instrument in the industrial environment only.

Weight: Approx. 1.1 kg (K9350LE), Approx. 1.2 kg (K9350LF)

Sample gas requirements: Dust/drain removed, gas temperature at 150°C or less

**One-year-Use Spare Parts**

Item	Part No.	Qty
Catalyst for NO <sub>2</sub> /NO converter	K9350LP	2
Glass wool for NO <sub>2</sub> /NO converter	K9350LQ	2
Fitting for NO <sub>2</sub> /NO converter	K9350LV	2



External Dimensions

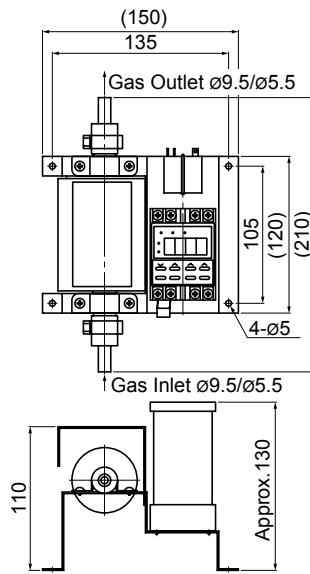

Unit: mm

Wiring Diagram

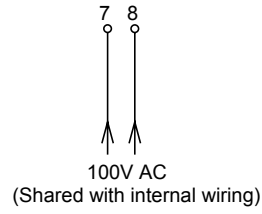

K9350LE

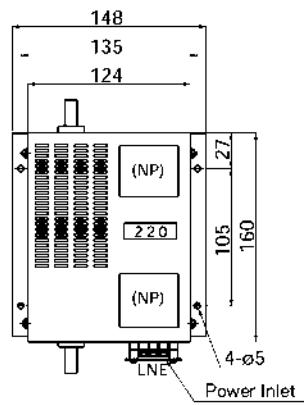

Unit: mm

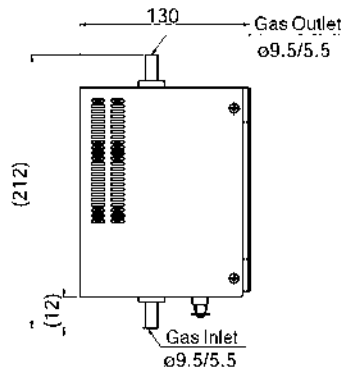

Front View

Side View

K9350LF

# Customer Maintenance Parts List

Model IR200  
Infrared Gas Analyzer

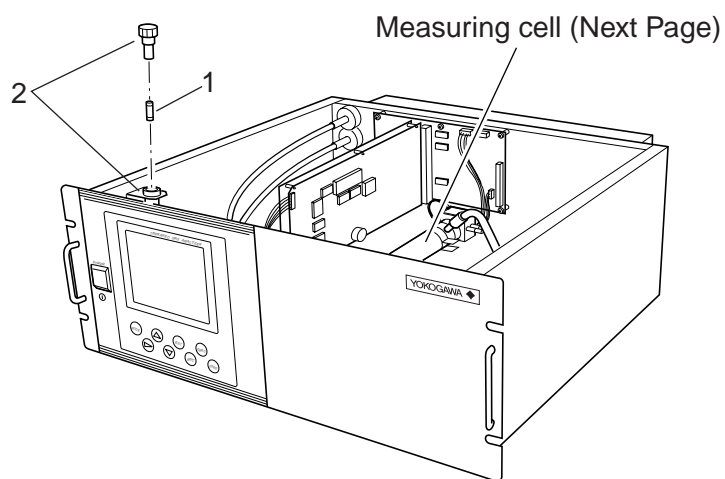

Item	Parts No.	Qty.	Description
1	K9218RB	1	Fuse (Time Lag Fuse)
2	K9358LM	1	Fuse holder

● Measuring Cell

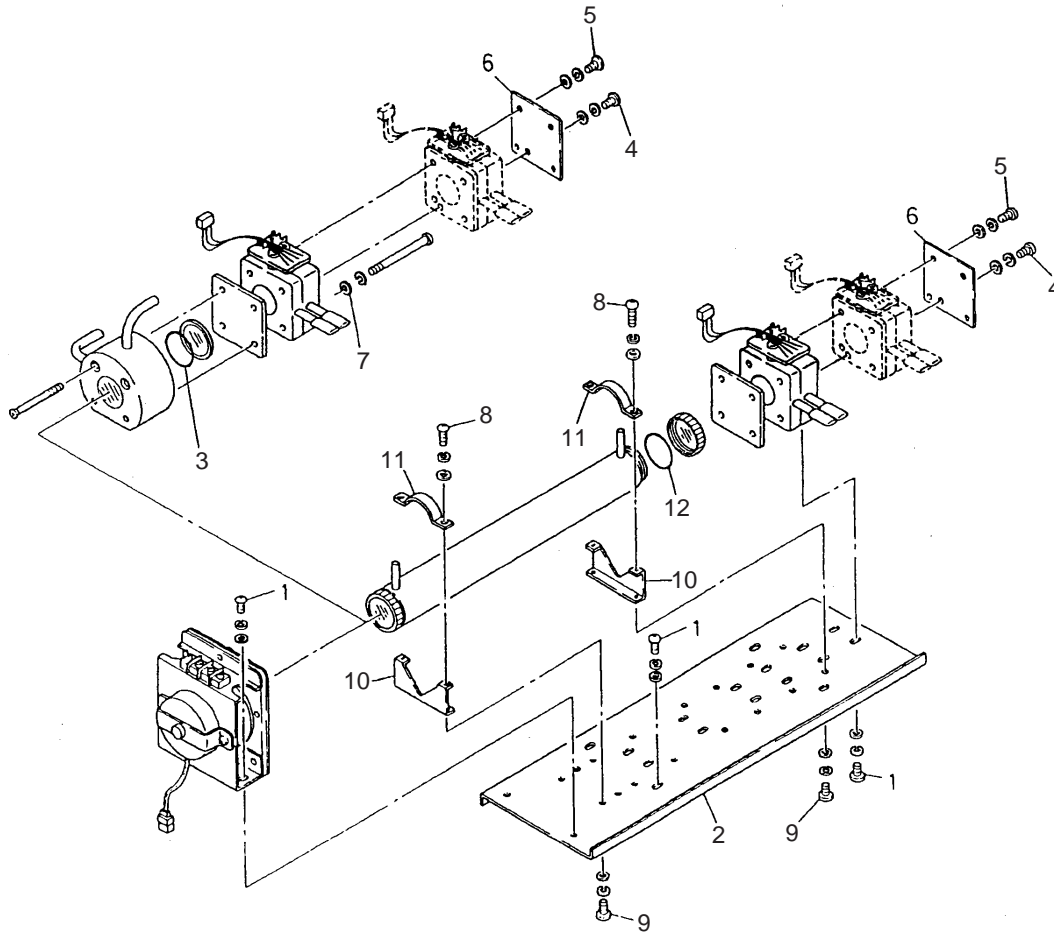

Item	Parts No.	Qty.	Description
1	K9358MG	8	Screw
2	K9358MH	1	Base plate
	K9358MJ	1	Base plate for 250 mm
3	K9358MW	1	O-ring for Block cell
4	K9358MX	1	Screw
5	K9358MY	2	Screw
6	K9358MZ	1	Cover
7	K9358NF	2	Washer
8	K9358NT	4	Screw
9	K9358NU	4	Screw
10	K9358NV	2	Support
11	K9358NW	2	Pushing for pipe cell
12	K9358PJ	2	O-ring for pipe cell

# Revision Information

- Title: Model IR200 Infrared Gas Analyzer
- Manual No.: IM 11G02M01-01E

Edition	Date	Remark (s)
<b>4th</b>	<b>Feb. 2016</b>	Revised and Corrected over all Section "CAUTION ON SAFETY" Others: Added the description, and "■ Notes on Use in Korea". Section 3.4, "Sampling" (7) Example of sampling system configuration: Change of figure. Section 9.1, "Specifications": Modify description of the safety and EMC conforming standards. Section 9.2, "Model and Suffix Code": Correction of erroneous description of table 2 and table 3. Section 9.2, "Model and Suffix Code": Correction of erroneous description of table 4. Section 9.3, "External Dimensions," Dedicated Zirconia O2 Sensor: Modify description of the safety and EMC conforming standards. Section 9.3, "External Dimensions," External Dimension of ZX8D: Change of figure "ZX8D". Section 9.3, "External Dimensions," NO <sub>2</sub> /NO Converter: Modify description of the safety and EMC conforming standards.
<b>3rd</b>	<b>Jul. 2007</b>	Section 3.4, "Sampling," (3) "Preparation for standard gas": Partially changed the table. Section 5.2, "Overview of display and operation panel": Partially changed the figure. Section 6.1, "Changeover of range": Partially changed the figure. Section 6.2, "Calibration setting": Added descriptions. Section 6.3.1, "Setting of alarm values": Changed descriptions. Section 6.4.1, "Auto calibration": Partially changed the figure. Section 6.6, "Peak alarm setting": Partially changed descriptions in the figure. Section 7.2, "Daily check and maintenance procedures": Partially changed Table 7-1, Maintenance and check list. Section 8.1, "Error message": Partially changed the figure. Section 9.1, "Specifications," Safety and EMC conforming standards: Changed descriptions and added Note. Section 9.2, "Model and Suffix codes": Deleted Footnote 7 and changed descriptions of Footnote 8 (former 9). Section 9.3, "External Dimensions," Dedicated Zirconia O2 Sensor (to be purchased separately): Added "Safety and EMC conforming standards" descriptions and revised "Model and Suffix code" table. Section 9.3, "External Dimensions," NO <sub>2</sub> /NO Converter: Changed "Part number" descriptions, added "Safety conforming standards" descriptions, deleted "CE Marking" descriptions, and changed "External Dimensions" drawings.
<b>2nd</b>	<b>Aug. 2006</b>	Fully revised due to style change to S3 Section 2.1, "Description of each unit": Changed Fig. 2-1. Section 3.4, (6), "Example of sampling system configuration": Changed Fig. 3-2 Section 5.1, "Name and description of operation panel": Changed Fig. 5-1. Section 5.3, (3), "Contents of measured channel (CH)": Changed the table. Section 6.2.2, Added Section "Setting of calibration gas". Section 9.1, (1), "Standard specifications": Changed table "Measurable gas components and measuring range". Section 9.1, (4), "Performance": Changed table "Interference from other gases". Section 9.2, "Model and Suffix codes": Changed table. Section 9.2, "Measurable component and range - availability check table-": Changed Tables 1, 5 and 6. Section 9.3, "External Dimensions": Changed drawing, and added NO <sub>2</sub> /NO converter's specifications and external dimensions.
<b>1st</b>	<b>Oct. 2002</b>	<b>Newly published</b>

- 
- If you want have more information about Yokogawa products, you can visit Yokogawa's home page at the following website.  
Home page: <http://www.yokogawa.com/an/>
  - Published by Yokogawa Electric Corporation  
2-9-32 Nakacho, Musashino-shi, Tokyo 180-8750, JAPAN
  - Printed by KOHOKU PUBLISHING & PRINTING INC.
-

---

Blank Page