

A detailed 3D rendering of the Veris Verabar flow sensor. It consists of a long, cylindrical probe with several small holes along its length, attached to a square-shaped base with a T-handle on top and a smaller handle on the side.

VERIS VERABAR[®]
VELOCITY AVERAGING FLOW SENSORS

TRUE PERFORMANCE IN FLOW MEASUREMENT



VERIS Verabar ...Advanced DP Flow Measurement

The Most Accurate and Reliable Technology for Measuring Gas, Liquid and Steam

Developed from aerospace technology, the Verabar averaging pitot flow sensor provides unsurpassed accuracy and reliability. With its solid one-piece construction and bullet shape, the Verabar makes flow measurement clog-free and precise.

The unique sensor shape reduces drag and flow induced vibration.

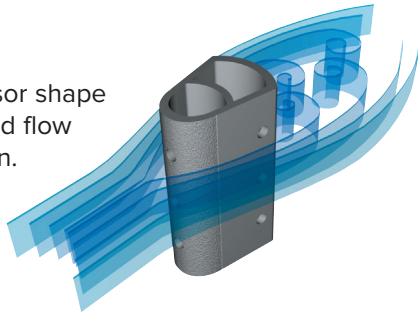

And the location of the low pressure ports eliminates the potential for clogging and improves signal stability.

Superior Signal Stability and Greater Resistance to Clogging

Clogging can occur in low pressure ports located in or near the partial vacuum at the rear of the sensor. The Verabar design locates the low pressure ports on the sides of the sensor, forward of the fluid separation point and turbulent wake area. This virtually eliminates clogging and produces an extremely stable signal.

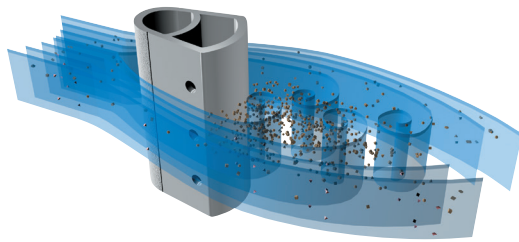

Lower Drag and Extended Turndown

Golf balls fly farther because they have a dimpled surface that lowers aerodynamic drag.

The grooves and roughness on the Verabar's frontal surface apply the same principle. This simple design feature relieves the partial vacuum at the rear of the sensor, reducing the pressure drag. This extends the accuracy and rangeability to very low velocities.

Accuracy You Can Trust And the Data to Back It Up

The unique and exclusive break-through in improved accuracy derived from the development of a **verified theoretical model** predicts the Verabar flow coefficients.

This eliminates the need for calibration tests to characterize the flow coefficients.

$$K = \frac{1}{\sqrt{\left(\frac{1}{1-C_b\beta_v}\right)^2 + C_\infty}}$$

Without such a model, the uncertainty of the flow coefficients is dramatically increased and expensive calibration may be required. Empirical test data from independent laboratories verified the theoretical model and flow coefficients as a constant,

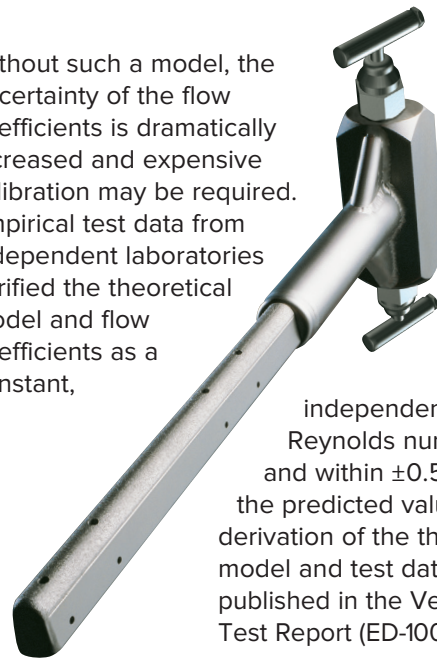

independent of Reynolds number and within ±0.5% of the predicted value. The derivation of the theoretical model and test data is published in the Verabar Flow Test Report (ED-100).

Test Data Summary

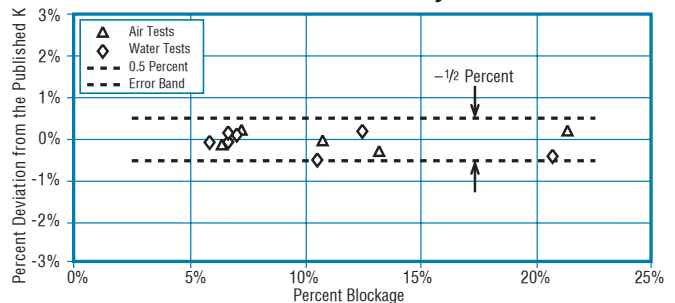

Lower Drag and Extended Turndown

Golf balls fly farther because they have a dimpled surface that lowers aerodynamic drag.

The grooves and roughness on the Verabar's frontal surface apply the same principle. This simple design feature relieves the partial vacuum at the rear of the sensor, reducing the pressure drag. This extends the accuracy and rangeability to very low velocities.

Rough Surface

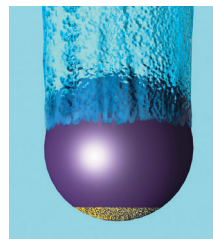

Smooth Surface



VERIS Verabar[®] ...New Ideas That Work

Unique Valve Head

Verabar offers a new concept... built-in valves in the head of the instrument.

This superior design:

- Simplifies installation and maintenance.
- Lowers the connecting hardware cost by reducing the number of fittings.



Spring-Lock...

Offers a Superior Mounting Method

This advanced, patented design ensures the sensor remains sealed, locked and pre-loaded to the opposite wall regardless of changes in pipe diameter due to pressure, temperature or mechanical force.

This design has important advantages:

- Fugitive emission and leak prevention...The Spring-Lock continually compensates for the differential in packing and body growth rates due to increased temperature.



Partial Insert

- Designed specifically for high velocity cooling water applications, large diameter pipes, large vertical stacks and buried water lines.
- Extends 1/3 into pipe to reduce procurement and installation costs — specifically useful when a hot tap is required.
- Partial Insert hot tap sensors can be inserted/retracted with no reduction in flow rate.

Spring-Lock

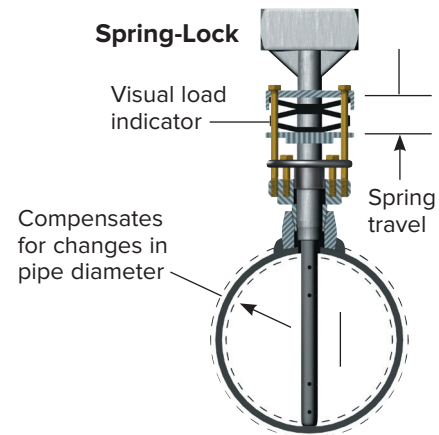

- Increases sensor strength, thereby eliminating the need for an opposite wall support. A locked, pre-loaded sensor is four times stronger than a non-preloaded, cantilevered sensor.
- Other mounting methods do not pre-load the sensor or the packing seal and are subject to increased sensor vibration, metal fatigue, breakage and leakage.

Transmount

A Transmount flow system is the first choice for all liquids; and for gas and steam applications, with slight variations in pressure and temperature.

Mass Transmount

A Mass Transmount flow system should be selected on steam and gas applications with variable temperature and pressure.



Field Flow Systems

Ready to install, the Verabar can be ordered with a manifold, transmitter or local indicating meter.

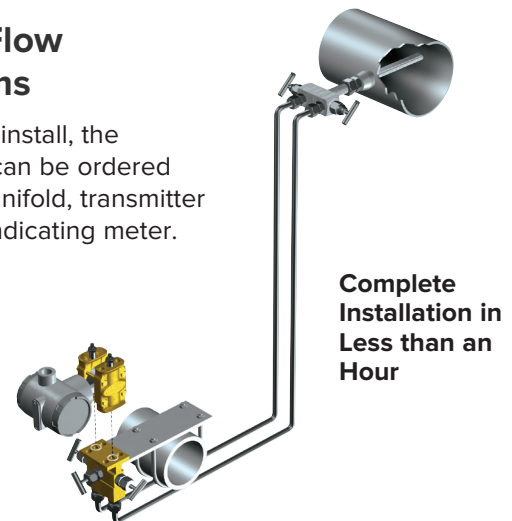



VERIS Verabar ...The Versatile Flow Sensor



Fast and Easy Model Selection

The easy-to-operate Veracalc computer program features:

- **Flow Calculations:** DP from flow rate, or flow rate from DP.
- **Model Selection:** Complete model selection from drop down menus.
- **Structural Analysis:** Verifies sensor strength at flowing conditions.
- **Temperature and Pressure Limits:** Error warnings if limits are exceeded.

Please contact the factory for the Veracalc PC program.

Verabar® Model Selector

Verabar® Applications

Regular Models — (Threaded Components)

Model Number	Type of Mounting
	Tube Fitting V100 (Single Support) V110 (Double Support)
	Spring-Lock V150 (No opposite support required)

The Verabar® offers the widest application range of any flow sensor. It accurately measures gas, liquid and steam.

Gas	Liquid	Steam
Natural Gas	Cooling/Chilled water	Saturated
Compressed Air	Boiler Feed Water	Superheated
Combustion Air	De-Mineralized Water	Main Header
Hydrocarbon Gas	Hydrocarbon Liquids	Custody Transfer
Hot Air	Cryogenic	Distribution
Blast Furnace Gas	Thermal Transfer Fluids	Energy Studies

Hot Tap Models — (Threaded or Flanged Components)

Model Number	Type of Mounting
	Threaded Screw Drive V200
	Flanged Screw Drive V400

Extended Range Applications

The Verabar's versatile design lends itself to a wide range of applications. Contact VERIS application engineering for your special requirements.

High Pressure Design

2500# ANSI Class
6000PSI and 1000°F

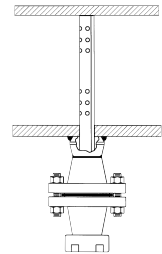

Square and Rectangular Ducts

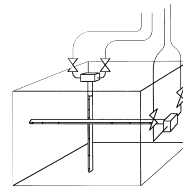

Large Stacks and Ducts

Up to 21 feet
(6 meters)

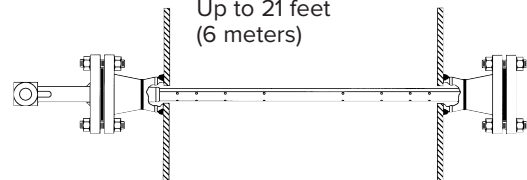

Specialized Mounting

- PVC
- FRP
- Concrete
- Cast Iron Pipe

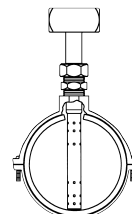

Flanged Models — (Flanged Components)

Model Number	Type of Mounting
	Flanged V500 (Single Support) V510 (Double Support)
	Flanged Spring-Lock V550 (No opposite support required)

VERIS Verabar ...Compared to Orifice Plates

Through Accuracy of Measurement, Low Installed and Operating Costs, Verabar Proves its Performance, Efficiency and Value.

Verabar Maintains Its Accuracy

Orifice plates show long term deterioration of accuracy.

The initial accuracy of the orifice plate is $\pm 1\%$. However, long term accuracy deteriorates unless the plate is periodically inspected. Senior, dual chamber fittings are available to check the plate without requiring system shutdown, but such fittings are very expensive.

Orifice Plate Test Results

Florida Gas Transmission Company conducted a test to quantify various conditions which can result in inaccurate measurement. A partial list of the results is shown:

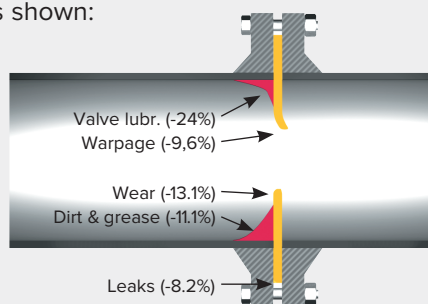

Condition % Deviation

Condition	% Deviation
Wear of knife edge:	
0.010"	-2.2
0.020"	-4.5
0.050"	-13.1
Dirt and grease deposits in pipe.....	-11.1
Valve lubrication upstream:	
one side of plate.....	-15.8
both sides	-24.0
Leaks around plate.....	-8.2
Plate warpaga	-9.6

Verabar Lowers Installed Costs

Verabar can save you more than 60% in installation costs over an orifice plate in a 10" pipe.

The graph shows the total installed cost by pipe size of the orifice plate, the Verabar, and the resultant Verabar savings. The most significant portion of the savings is the reduction in the linear inches of weld.

Savings in Weld Time

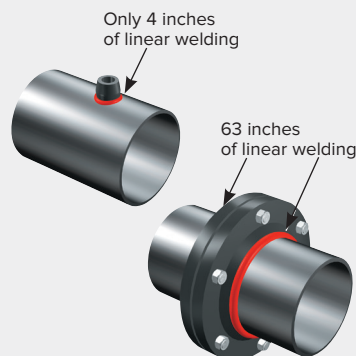

Installed Cost Savings

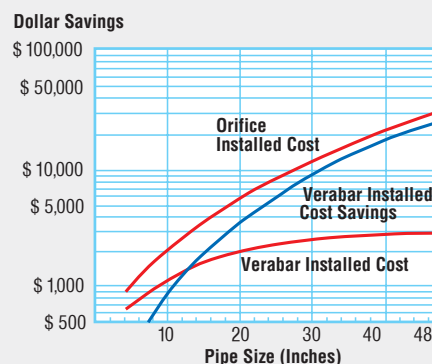

Verabar Has the Lowest Operating Costs

Verabar pays for itself in less than a year.

The graph shows the yearly operating cost savings and equivalent horsepower savings of the non-constricting, low permanent pressure loss Verabar compared to the extremely constricting, high permanent pressure loss orifice plate. Savings are shown for gases, liquids and steam—at typical design velocities, by pipe size.

Verabar vs. Orifice

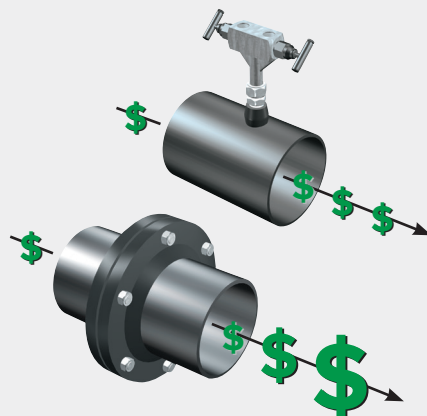

Operating Cost Savings

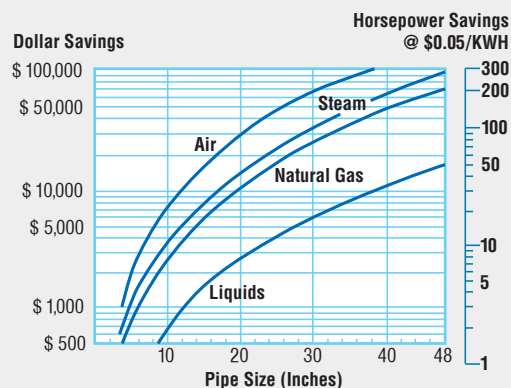



Quality Assurance

VERIS manufactures its own leak-proof, solid one-piece sensor. Our primary goal is to provide the highest quality and most accurate sensor in the industry.

Other manufacturers use a three-piece sensor design that has no positive mechanical method of maintaining a seal between the tubes. Therefore, temperature, pressure, vibration and even manufacturing variations can cause leakage between the chambers.

This can result in a significant undetectable loss in accuracy.

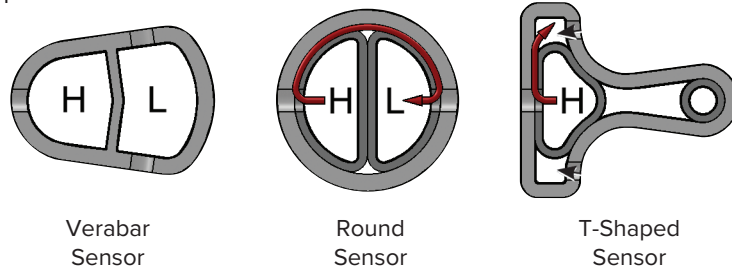

Verabar is designed to meet or exceed applicable ANSI and ASME codes. The Verabar is available to meet B31.1, B31.3, B31.8, NACE MR-01-75, etc.

Additional QA capabilities include code welding, hydrostatic and other non-destructive testing.

The Proof of Verabar Accuracy

Accurate Flow Coefficients

The true test of a flow measurement device is its ability to repeat its published flow coefficient within its accuracy band. Verabar has been thoroughly tested at independent flow laboratories (all sensor sizes, in multiple pipe sizes, in gas and liquids).

Actual Flow Test

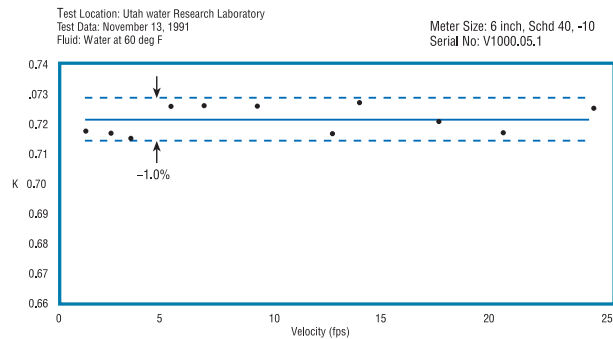

Why Average the Velocity Profile?

Verabar averages the velocity profile through multi-sensing ports which span the entire pipe diameter. Other types of non-averaging insert meters are SINGLE POINT INSERT METERS (turbine, vortex, magnetic, sonic, etc.). They assume a “textbook: turbulent velocity profile, and use a single “critical” point to infer an average velocity. In actual industrial applications, sensors are located downstream of disturbances, such as elbows or valves, which produce non-uniform velocity profiles. This makes it virtually impossible to locate a single point that represents the average velocity.

Result: Inaccuracy ranging from ±10% to ±20%.

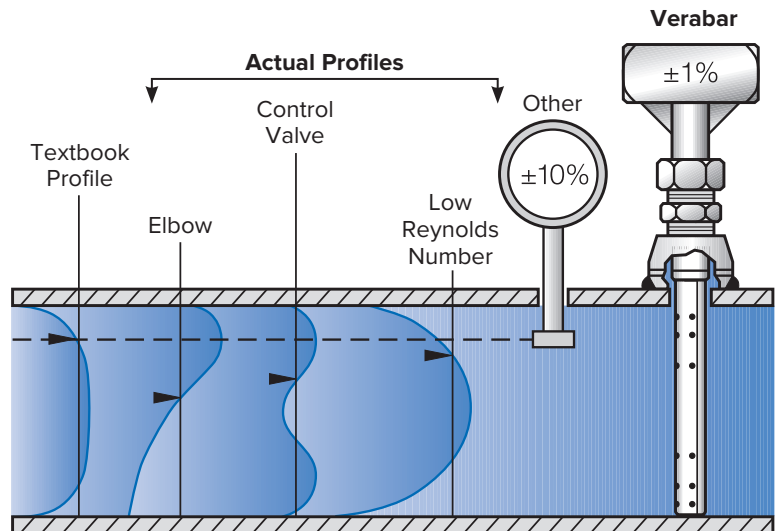

► Location of average velocity

VERIS Verabar[®] ...Problems With Other Sensor Shapes

Round Sensors

Round sensors produce unpredictable accuracy. The original round sensors were designed for economical fluid balancing and did not meet industrial demands for accuracy. Round sensors have a variable fluid separation point that causes an unstable low pressure distribution around the sensor.

Result:

Inaccuracy in excess of $\pm 5\%$ and as high as $\pm 10\%$.

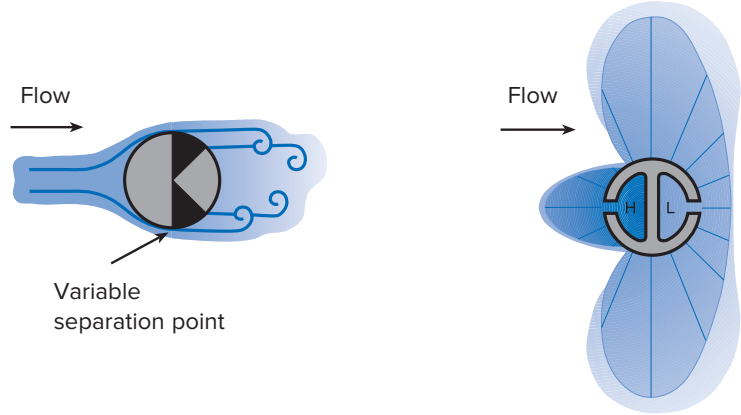

Diamond and T-Shaped Sensors

These sensors produce pulsating, noisy signals. They improved accuracy by use of a sharp edge to fix the fluid's separation point. However, this greatly amplified the vortex shedding forces.

Result:

The sharp edges generate extreme vortices, causing sensor vibration, pulsations and a noisy signal to the point that transmitter dampening and signal averaging are recommended.

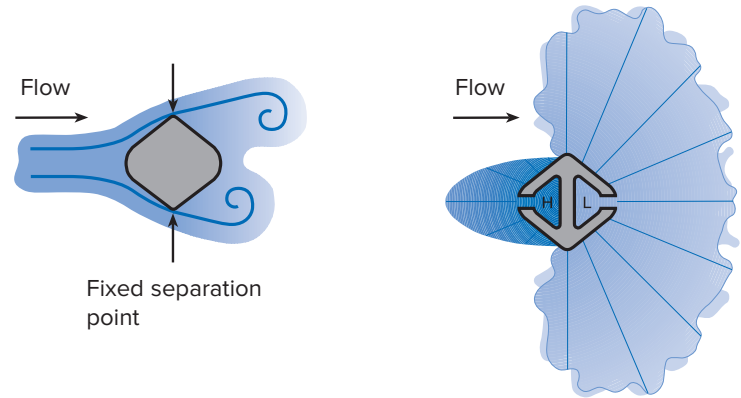

Aerodynamic-Shaped Sensors

Extreme aerodynamic shapes that permit the stream lines to reattach are subject to airfoil type lift forces. This occurs when the angle of attack varies due to sensor misalignment, or the direction of the fluid varies, as is common in industrial piping with upstream disturbances.

Result:

The lift forces can cause an unpredictable shift in the low pressure distribution, producing inaccurate measurement.

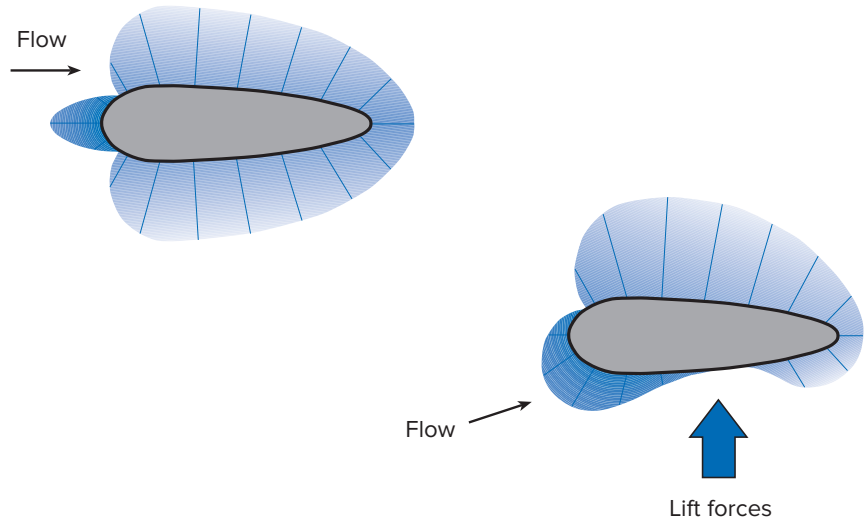

Verabar[®] ...True Performance in Flow Measurement

Designs, materials, weights and performance ratings are approximate and subject to change without notice. Visit armstronginternational.com/veris for up-to-date information.



INTELLIGENT SOLUTIONS IN STEAM, AIR AND HOT WATER

Armstrong International

North America • Latin America • India • Europe / Middle East / Africa • China • Pacific Rim

armstronginternational.com