

DLM4000 Series Mixed Signal Oscilloscope

U S E R ' S M A N U A L

Features Guide

Thank you for purchasing the DLM4000 Series Mixed Signal Oscilloscope. This manual contains useful information about the features of the DLM4000. To ensure correct use, please read this manual thoroughly before beginning operation. After reading the manual, keep it in a convenient location for quick reference whenever a question arises during operation.

List of Manuals

The following manuals, including this one, are provided as manuals for the DLM4000 series. Read them along with this manual.

Manual Title	Manual No.	Description
DLM4000 Series Mixed Signal Oscilloscope Features Guide	IM DLM4038-01EN	This manual. This manual explains all the DLM4000 features other than the communication interface features. (included in the accompanying manual CD)
DLM4000 Series Mixed Signal Oscilloscope User's Manual	IM DLM4038-02EN	The manual explains how to operate the DLM4000. (included in the accompanying manual CD)
DLM4000 Series Mixed Signal Oscilloscope Getting Started Guide	IM DLM4038-03EN	Provided as a printed manual. The guide explains the handling precautions, basic operations, and specifications of the DLM4000. (included in the accompanying manual CD)
DLM4000 Series Mixed Signal Oscilloscope Communication Interface User's Manual	IM DLM4038-17EN	The manual explains the DLM4000 communication interface features and instructions on how to use them. (included in the accompanying manual CD)
Model DLM4038, DLM4058 Mixed Signal Oscilloscope	IM DLM4038-92Z1	Document for China

The "EN" and "Z1" in the manual numbers are the language codes.

Contact information of Yokogawa offices worldwide is provided on the following sheet.

Document No.	Description
PIM 113-01Z2	List of worldwide contacts

Notes

- The contents of this manual are subject to change without prior notice as a result of continuing improvements to the instrument's performance and functions. The figures given in this manual may differ from the actual screen.
- Every effort has been made in the preparation of this manual to ensure the accuracy of its contents. However, should you have any questions or find any errors, please contact your nearest YOKOGAWA dealer.
- Copying or reproducing all or any part of the contents of this manual without the permission of YOKOGAWA is strictly prohibited.
- The TCP/IP software of this product and the documents concerning it have been developed/created by YOKOGAWA based on the BSD Networking Software, Release 1 that has been licensed from the Regents of the University of California.

Trademarks

- Microsoft, Internet Explorer, MS-DOS, Windows, Windows 7, Windows 8, Windows 8.1, and Windows 10 are either registered trademarks or trademarks of Microsoft Corporation in the United States and/or other countries.
- Adobe and Acrobat are either registered trademarks or trademarks of Adobe Systems Incorporated.
- DLM is a registered trademark of Yokogawa Electric Corporation.
- In this manual, the ® and TM symbols do not accompany their respective registered trademark or trademark names.
- Other company and product names are registered trademarks or trademarks of their respective holders.

Revisions

- 1st Edition: November 2012
- 2nd Edition: June 2013
- 3rd Edition: February 2015
- 4th Edition: May 2015
- 5th Edition: January 2016
- 6th Edition: October 2016
- 7th Edition: October 2017
- 8th Edition: July 2018

Contents

	List of Manuals.....	i
1	Vertical Axis (Analog Signal)	
	Turning the Display On and Off (Display)	1-1
	Vertical Scale (SCALE knob)	1-1
	Waveform Vertical Position (Vertical POSITION knob).....	1-2
	Input Coupling (Coupling)	1-3
	Probe (Probe)	1-3
	Inverted Waveform Display (Invert)	1-4
	Linear Scaling (Linear Scale).....	1-4
	Label Display (Label)	1-5
	Bandwidth (Bandwidth).....	1-5
	Offset (Offset)	1-5
	Channel Utility (CH UTIL)	1-7
2	Vertical Axis (Logic Signal)	
	Turning the Display On and Off (Display)	2-1
	Vertical Display Range (SCALE knob).....	2-1
	Vertical Position (Vertical POSITION knob)	2-1
	Setting the Bits (Bit Setup).....	2-1
	Bus Display (Bus, Bus2, and Bus3).....	2-3
	State Display (State).....	2-4
	Setting the Display Order of Bits and the Bus (Bit Order).....	2-5
	Deskew (Deskew).....	2-5
	Channel Utility (CH UTIL)	2-5
3	Horizontal Axis (Time Axis)	
	Time Axis Setting (TIME/DIV knob)	3-1
4	Triggering	
	Trigger Mode (Trigger Mode).....	4-1
	Trigger Type (Type).....	4-2
	Signal Type and Trigger Type Combinations	4-2
	Basic Trigger Settings	4-3
	Edge Trigger [EDGE]	4-3
	Edge OR Trigger [ENHANCED].....	4-8
	Edge Qualified Trigger [ENHANCED].....	4-9
	State Trigger [ENHANCED]	4-10
	Pulse Width Trigger [ENHANCED]	4-12
	State Width Trigger [ENHANCED].....	4-14
	Serial Bus Trigger [ENHANCED]	4-17
	FlexRay Bus Trigger [ENHANCED, option]	4-19
	CAN Bus Trigger [ENHANCED, option].....	4-24
	CAN FD Bus Trigger [ENHANCED, option]	4-31
	LIN Bus Trigger [ENHANCED, option].....	4-37
	SENT Trigger [ENHANCED, option]	4-41
	PSI5 Airbag Trigger [ENHANCED, option].....	4-47
	UART Trigger [ENHANCED, option]	4-49
	I ² C Bus Trigger [ENHANCED, option].....	4-51

	SPI Bus Trigger [ENHANCED, option].....	4-56
	User-Defined Serial Bus Trigger [User Define, ENHANCED]	4-59
	TV Trigger [ENHANCED].....	4-61
	Trigger B [B TRIG]	4-65
5	Executing Actions	
	Action Mode (Mode).....	5-1
	Action to Execute When Conditions Are Met (Action).....	5-1
	Number of Actions (Action Count/Nogo Count)	5-2
	Executing Action-on-Trigger or GO/NO-GO determination (Exec)	5-2
	GO/NO-GO Determination (Go/Nogo AND, Go/Nogo OR).....	5-2
	Notes about Action.....	5-6
6	Waveform Acquisition	
	Record Length (Record Length)	6-1
	Acquisition Mode (Mode)	6-2
	High Resolution Mode (Hi Resolution).....	6-3
	Interleave Mode (Interleave).....	6-3
	Sampling Mode (Sampling Mode).....	6-4
	Waveform Acquisition (RUN/STOP).....	6-5
	Acquiring the Waveform Once (SINGLE)	6-5
7	Display	
	Types of Windows.....	7-1
	Display Format (Format).....	7-1
	Display Interpolation (Dot Connect).....	7-2
	Graticule (Graticule).....	7-3
	Scale Value Display (Scale Value).....	7-3
	Accumulate (Accumulate).....	7-4
8	Displaying XY Waveforms	
	Turning the XY Waveform Display On and Off (Display)	8-1
	X-Axis and Y-Axis Source Waveforms (X Trace/Y Trace).....	8-1
	Configuring the Display (Display Setup)	8-1
	Display Area (T Range1/T Range2).....	8-2
	Measurement (Measure Setup)	8-2
9	Computed and Reference Waveforms	
	Computation Mode (Mode)	9-1
	Computation Source Waveforms (Source1/Source2).....	9-1
	Reference Waveforms	9-1
	Operators (Operation).....	9-2
	Initial Point (Initial Point)	9-5
	Setting Labels and Units (Label/Unit)	9-5
	Scaling (Ranging)	9-5
	User-Defined Computation (User Define, Option)	9-6

10	FFT	
	Turning the FFT On or Off (Display)	10-1
	Analysis Source Waveform (Trace)	10-1
	FFT Conditions (FFT Setup)	10-2
	Number of FFT Points (FFT Point)	10-3
	Analysis Range (Time Range)	10-3
	Scale Value (Display Setup)	10-4
	Cursor Measurement (Measure Setup)	10-4
11	Cursor Measurement	
	Turning Cursor Measurement On and Off (Display)	11-1
	Cursor Mode (Type)	11-1
	Measurement Source Waveform (Trace)	11-1
	ΔT Cursors (ΔT)	11-2
	ΔV Cursors (ΔV)	11-3
	ΔT & ΔV Cursors (ΔT & ΔV)	11-3
	Marker Cursors (Marker)	11-3
	Angle Cursors (Degree)	11-4
	Moving the Cursors (Cursor/Marker)	11-5
	Cursor Jumping (Cursor Jump)	11-5
12	Automated Measurement of Waveform Parameters	
	Turning Automated Measurement On or Off (Mode)	12-1
	Source Window (Time Range)	12-1
	Measurement Time Period (T Range1/T Range2)	12-1
	Automated Measurement of Waveform Parameters	12-2
	Statistics (Statistics)	12-7
	Enhanced Parameter Measurement (Enhanced)	12-12
	Notes about Automated Measurement of Waveform Parameters	12-13
13	Zooming in on Waveforms	
	Turning the Zoom Windows On or Off (Display)	13-1
	Display Format (Format)	13-1
	Displaying the Main Window (Main)	13-2
	Auto Scroll (Auto Scroll)	13-2
	Zoom Source Waveforms (Trace)	13-2
	Zoom Factor (ZOOM knob)	13-2
	Zoom Position (Z1 Position/Z2 Position)	13-3
	Vertical Zoom (Vertical Zoom)	13-3
14	Searching Waveforms	
	Search Source Waveform	14-1
	Search Type (Type)	14-1
	Search Conditions (Condition Setup)	14-3
	Displaying Detected Waveforms (Display Setup)	14-6
	Search Skip (Skip Mode)	14-6
	Search Range (Start/End Point)	14-7
	Executing a Search (Search)	14-7
	Detected Point number (Pattern No.)	14-7

15	Analyzing and Searching Serial Bus Signals	
	Turning the Analysis and Search Feature On or Off (Display)	15-1
	Serial Bus Signal Type (Type).....	15-2
	Bus Setup (Setup).....	15-2
	Search Setup (Search)	15-2
	Zoom Position (Z1 Position/Z2 Position).....	15-3
	Decoded Display (Decode).....	15-3
	List Setup	15-4
	Trend Display (Trend)	15-4
	Saving the Analysis Results.....	15-4
	Analyzing and Searching FlexRay Bus Signals (Option).....	15-5
	Analyzing and Searching CAN Bus Signals (Option).....	15-7
	Analyzing and Searching CAN FD Bus Signals (Option).....	15-9
	Analyzing and Searching LIN Bus Signals (Option).....	15-12
	Analyzing and Searching CXPI Bus Signals (Option).....	15-15
	Analyzing and Searching SENT Signals (Option).....	15-24
	Analyzing and Searching PSI5 Airbag Signals (Option)	15-28
	Analyzing and Searching UART Signals (Option).....	15-35
	Analyzing and Searching I ² C Bus Signals (Option)	15-38
	Analyzing and Searching SPI Bus Signals (Option)	15-40
	Analyzing and Searching User-Defined Serial Bus Signals (User Define)	15-42
16	Displaying the Frequency Distribution of a Waveform	
	Turning the Histograms On or Off (Display).....	16-1
	Source Waveform (Trace).....	16-1
	Source Axis (Type).....	16-1
	Range Setup (Range Setup).....	16-1
	Measurement (Measure Setup)	16-2
17	Power Supply Analysis Feature (Power Analysis & Power Measurement; Option)	
	Overview of the Power Supply Analysis Feature	17-1
	Switching Loss Analysis (SW Loss).....	17-2
	Safe Operating Area Analysis (SOA)	17-7
	Harmonic Analysis (Harmonics).....	17-8
	Joule Integral (I ² t).....	17-12
	Power Measurement (Power Measurement)	17-14
18	Displaying and Searching History Waveforms	
	Display Mode (Mode).....	18-2
	Average (Average).....	18-2
	Highlighting (Select No.)	18-2
	Display Range (Start/End No.).....	18-2
	List of Timestamps (List).....	18-2
	Searching History Waveforms (Search).....	18-3
	Replay (Replay)	18-4
	Notes about Using the History Feature.....	18-4

19	Printing and Saving Screen Captures	
	Destination Type (Print To).....	19-1
	Printing on the Built-in Printer (Built-in).....	19-2
	Printing on a Network Printer (Network).....	19-3
	Saving Screen Captures to Files (File).....	19-4
	Printing and Saving Screen Captures to Multiple Destinations (Multi).....	19-5
20	Saving and Loading Data	
	Storage Media You Can Save and Load From	20-1
	Saving Data (Save).....	20-2
	Saving Waveform Data (Waveform)	20-2
	Saving Setup Data (Setup)	20-5
	Saving Other Types of Data (Others).....	20-5
	Serial Bus Analysis Results (Others - Serial Bus (FlexRay/CAN/CAN FD/LIN/CXPI)).....	20-8
	Serial Bus Analysis Results (Others - Serial Bus (SENT/PSI5 Airbag/UART/I ² C/SPI)).....	20-11
	Loading Data (Load)	20-15
	File Operations (Utility)	20-17
21	Ethernet Communication (Network)	
	TCP/IP (TCP/IP)	21-2
	FTP Server (FTP/Web Server)	21-3
	Web Server (FTP/Web Server).....	21-4
	Mail (Mail)	21-5
	Network Drive (Net Drive).....	21-6
	Network Printer (Net Print).....	21-7
	SNTP (SNTP)	21-7
22	Other Features	
	Auto Setup (AUTO SETUP).....	22-1
	Returning to the Default Settings (DEFAULT SETUP).....	22-2
	Snapshot (SNAP SHOT).....	22-2
	Clear Trace (CLEAR TRACE).....	22-3
	Calibration (Calibration)	22-3
	Remote Control (Remote Control)	22-4
	System Configuration (System Configuration).....	22-6
	Overview (Overview).....	22-9
	Preferences (Preference).....	22-9
	Self-Test (Selftest).....	22-10
Appendix		
	Appendix 1 How to Calculate the Area of a Waveform.....	App-1
	Appendix 2 User-Defined Computation, Option	App-2
	FFT Function - user-defined	App-6
	Appendix 3 ASCII Data File Format	App-9
	Appendix 4 TCP and UDP Port Numbers.....	App-10
	Appendix 5 How Power Measurement Items Are Determined	App-11
	Appendix 6 Trigger and Detected Points of SENT Signals	App-12
	Appendix 7 Auto Setup Trigger Range in CXPI Bus Analysis	App-13
	Appendix 8 Firmware Versions and New Features	App-14

Index

1 Vertical Axis (Analog Signal)

You can configure the [vertical scale](#), [vertical position](#), [input coupling](#), [probe](#), [inverted waveform display](#), [linear scaling](#), [label display](#), [bandwidth limit](#), [offset](#), and [channel utility](#) settings of the CH1 through CH8 input signals. If you are using a probe that is compatible with the DLM4000 probe interface, the DLM4000 automatically configures the input impedance (50 Ω or 1 M Ω) and the probe attenuation.

Turning the Display On and Off (Display)

Select whether or not to display each channel's input signal waveform.

- ON: Displays the waveform
- OFF: Does not display the waveform

Vertical Scale (SCALE knob)

The vertical scale is used to adjust the displayed waveform amplitude so that you can easily view signals. Set the vertical scale by voltage per grid square (V/div) or current per grid square (A/div) on the screen.

Use the SCALE knob to set the vertical scale for each channel.

The same SCALE knob is used to adjust the scale of each channel. Press one of the CH1 to CH8 keys to select the channel that you want to set the vertical scale for. The LED between the SCALE and \blacklozenge POSITION knobs illuminates in the color assigned to the selected channel (the color enclosing the CH key).

Example

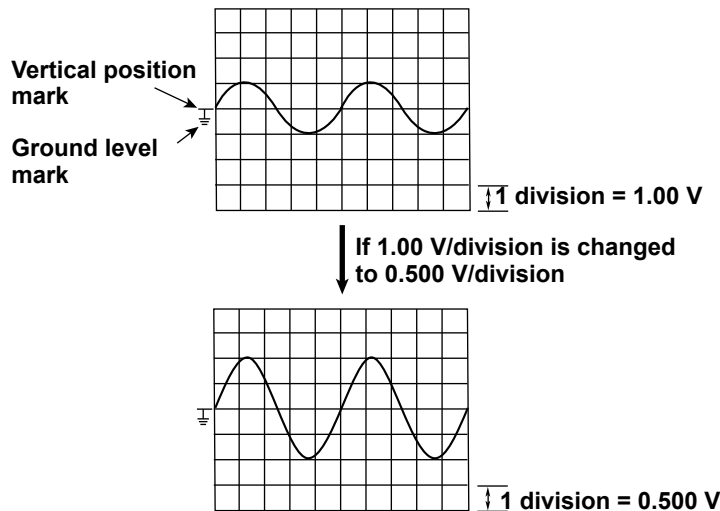

1 Vertical Axis (Analog Signal)



If you push the SCALE knob, the FINE indicator illuminates, and you can set the vertical scale with higher resolution.

Measurement Resolution and Effective Data Range

The DLM4000 samples input signals using an 8-bit A/D converter. The DLM4000's effective data range is 250 levels (LSB). The DLM4000 displays waveforms using 25 levels per division on the screen. The effective data range is ± 5 divisions from the center of the screen, but only ± 4 divisions can be displayed. If you move the vertical scale position after stopping waveform acquisition, you can change the display range of the effective data.

Vertical Scale Setting

To measure the voltage or current with high accuracy, set the vertical scale so that the input signal is measured with the largest possible amplitude.

If you display multiple waveforms without dividing the screen so that the waveforms do not overlap (by setting the vertical scale to a low value), then you cannot take advantage of the A/D converter's resolution. To make accurate measurements, divide the screen and set the waveforms' vertical scales to a high value.

Waveform Vertical Position (Vertical POSITION knob)

You can move each waveform's vertical display position within ± 4 divisions.

If you change the vertical scale, the location of the vertical position mark does not change.

Use the \blacklozenge POSITION knob to set the vertical position for each channel.

The \blacklozenge POSITION knob is used to adjust the position of each channel. Press one of the CH1 to CH8 keys to select the channel that you want to set the vertical position for. The LED between the SCALE and \blacklozenge POSITION knobs illuminates in the color assigned to the selected channel (the color enclosing the CH key).

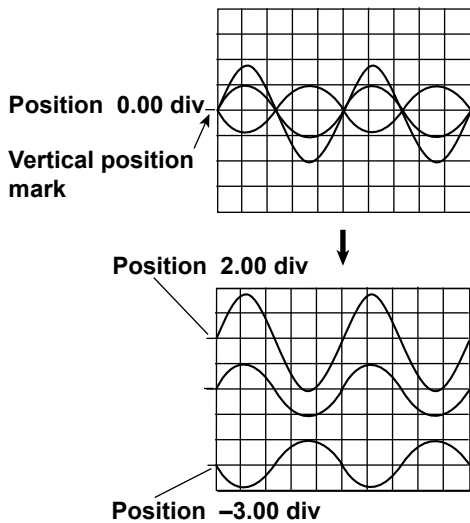

If you change the vertical position after stopping signal acquisition, the data that exceeds the measurement range is handled as overflow data. Overflow data will appear as a clipped waveform as shown below.

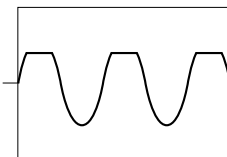

Input Coupling (Coupling)

You can choose how the vertical control circuit (voltage axis) is coupled to the analog signal. You can set the input coupling to one of the available settings below.

AC

Displays only the AC component of the input signal. The input impedance is 1 M Ω .

DC

Displays both the AC and DC components of the input signal. The input impedance is 1 M Ω .

DC50

Displays both the AC and DC components of the input signal. The input impedance is 50 Ω . Be careful because the maximum input voltage (current) is reduced.

GND

Displays the ground level, not the input signal.

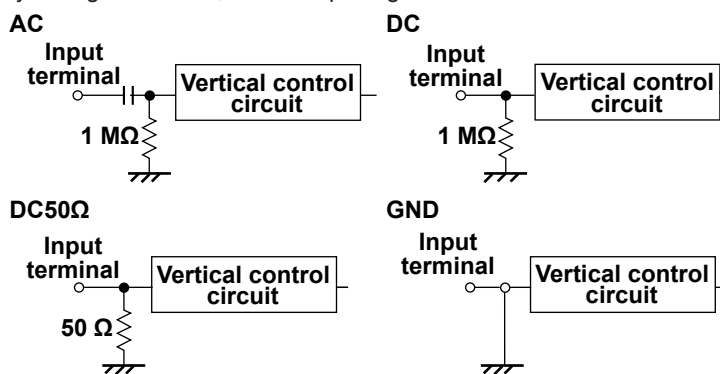

Probe (Probe)

To use a probe, you must align the DLM4000's attenuation setting with the probe attenuation so that voltage or current values and scale values are displayed correctly. Set an appropriate attenuation for the probe.

Probe Type (Type)

Select the type of probe that you want to set the attenuation of from one of the settings below.

- Voltage: Voltage probe
- Current: Current probe

Attenuation (Attenuation)

Set the attenuation to one of the settings below.

For voltage probes

0.001:1, 0.002:1, 0.005:1, 0.01:1, 0.02:1, 0.05:1, 0.1:1, 0.2:1, 0.5:1, 1:1, 2:1, 5:1, 10:1, 20:1, 50:1, 100:1, 200:1, 500:1, 1000:1, or 2000:1

For current probes

0.001A:1V, 0.002A:1V, 0.005A:1V, 0.01A:1V, 0.02A:1V, 0.05A:1V, 0.1A:1V, 0.2A:1V, 0.5A:1V, 1A:1V, 2A:1V, 5A:1V, 10A:1V, 20A:1V, 50A:1V, 100A:1V, 200A:1V, 500A:1V, 1000A:1V, or 2000A:1V



Using a probe has the following advantages.

- Prevents disturbing the voltage and current of the circuit being measured.
- Allows signals to be applied with no distortion.
- Expands the voltage range that the DLM4000 can measure.

1 Vertical Axis (Analog Signal)

Automatic Zero Adjustment of Current Probes (Probe Zero Cal)

You can perform automatic zero adjustment on a current probe when all of the following conditions are met.

- A current probe that is compatible with the DLM4000 probe interface is connected to the input terminal.
- The input coupling is set to DC.



An error may occur when automatic zero adjustment is executed if the current probe's residual offset is large. If this happens, adjust the current probe's residual offset to zero.

Demagnetization and Automatic Zero Adjustment of Current Probes (DEMAG and Zero Cal)

You can demagnetize and perform automatic zero adjustment on a current probe when all of the following conditions are met.

- A current probe with a YOKOGAWA probe interface (PBC100 or PBC050) is connected to the input terminal.
- The input coupling is set to DC.



When you demagnetize and perform automatic zero adjustment on a current probe, do not clamp the conductor. If you demagnetize a current probe while the conductor is clamped, the current that flows through the conductor as a result of demagnetization may damage components of the DUT circuitry.

Deskew (Deskew)

The deskew feature allows you to view signals by correcting the time offsets (skew) between the CH1 to CH8 signals, which is caused by the use of different types of probes. You can deskew each channel separately. Selectable range: -100.0 ns to 100.0 ns in 0.01-ns steps

Inverted Waveform Display (Invert)

This feature inverts the waveform display around the vertical position. Only the display is inverted. Cursor measurements, automated measurement of waveform parameters, and computation are performed on the original waveform. Triggers also operate based on the original waveform.

Linear Scaling (Linear Scale)

Using specified scaling coefficient A and offset B, the DLM4000 performs the following computation to scale cursor measurement values and automated measurement values of waveform parameters. You can assign units to the scaled values.

This feature can be used to multiply the measured value by an external voltage divider's voltage-divider ratio or to convert measured voltage into current values.

$$Y (\text{unit}) = AX + B$$

X: Value before scaling

Y: Value after scaling

Turning Linear Scaling On and Off (Mode)

Sets whether or not to use linear scaling.

- ON: Uses linear scaling
- OFF: Does not use linear scaling

Unit (Unit)

You can set the unit using up to four alphanumeric characters.

Scaling Coefficient A and Offset B

The selectable ranges for scaling coefficient A and offset B are as follows:

Selectable Range of A and B	-10.000E+30 to +10.000E+30	
Default Setting	A	1.0000E+00
	B	0.0000E+00

Label Display (Label)

You can assign labels to channels using up to eight characters.

Turning Labels On and Off (Display)

- ON: Displays labels
- OFF: Does not display labels

Label (Name)

You can set the label when the label display is turned on.

Bandwidth (Bandwidth)

You can set bandwidth limitations on the analog signals by specifying a cutoff frequency.

You can view signals with frequency components above the specified frequency removed.

Set the cutoff frequency to one of the settings below.

FULL (no bandwidth limit), 200 MHz, 100 MHz, 20 MHz, 10 MHz, 5 MHz, 2 MHz, 1 MHz, 500 kHz, 250 kHz, 125 kHz, 62.5 kHz, 32 kHz, 16 kHz, or 8 kHz



When high-resolution mode is ON, the bandwidth limit is set to 200 MHz even if you set the bandwidth limit to FULL.

Offset (Offset)

If you set an offset when measuring an analog signal that is riding on top of a given voltage (or current), the given voltage (or current) is subtracted from the input signal. This allows you to only view the changes in the signal at a higher vertical scale setting.

You can set the offset for each channel.

Selectable Range for Voltage

Voltage Scale (With probe = 1:1)	Selectable Offset Voltage Range
2 mV/division to 50 mV/division	-1.0 V to 1.0 V
0.1 V/division to 0.5 V/division	-10.0 V to 10.0 V (-5.0 V to 5.0 V when the input coupling is set to DC50)
1 V/division to 10 V/division	-100.0 V to 100.0 V

You can set the offset in 0.01-division steps. For 2 mV/division, you can set the offset in 0.02-mV steps.

Resetting the Offset

Press the RESET key to set the offset value to 0 V.

Offset Cancel (Offset Cancel)

You can set whether or not to apply the specified offset to various measured values. The offset-cancel feature ON/OFF setting applies to all channels. The default setting is off.

• **ON**

Applies the specified offset to the result of cursor measurements, computations, and automated measurement of waveform parameters. The offset is subtracted from the input signal, and various measurements are performed. The vertical position is set to zero.

• **OFF**

Does not apply the specified offset to the result of cursor measurements, computations, and automated measurement of waveform parameters. The offset is not subtracted from the input signal, and various measurements are performed. The vertical position on the screen corresponds to the offset.

When Offset Cancel is set OFF

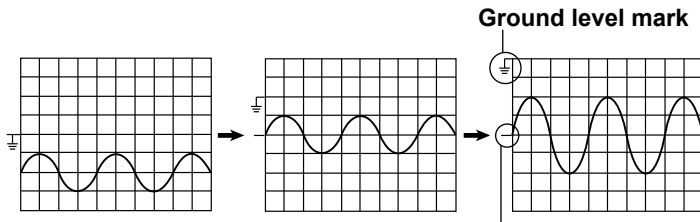

When Offset Cancel is set ON

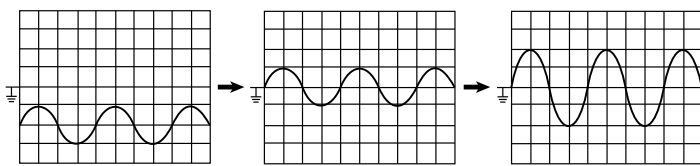

1.00 V/division	1.00 V/division	0.500 V/division
Offset 0.00 V	Offset -2.00 V	Offset -2.00 V
Position 0.00 divisions	Position 0.00 divisions	Position 0.00 divisions



- The offset setting applies to all input coupling settings (AC, DC, DC50, and GND).
- If you change the probe attenuation, the vertical scale settings change the values that have been scaled with the new attenuation ratio.
- The offset value does not change even if you change the voltage scale. However, if the offset value goes outside the selectable range, the offset is set to the maximum or minimum value in the vertical scale range. If you do not change the offset and set the vertical scale back to its original value, the offset returns to its original value.

Channel Utility (CH UTIL)

The channel utility includes useful features for configuring multiple channels, such as showing and hiding input channels at once and copying channel information.

All ON/All OFF (All ON/All OFF)

You can show or hide all analog signal input channels, CH1 to CH8, at once.

- **All ON (All ON)**

Shows all channels at once.

For logic signal input ports, see the channel utility explanation in chapter 2, “Vertical Axis (Logic Signal).”

▶ [See here.](#)



Analog signal input channel CH8 and logic signal input port LOGIC(L) cannot measure signals simultaneously. The signal that corresponds to the last key that you pressed, either CH8 or L, can be measured. Therefore, “All ON” will be applied to the channel or port that corresponds to the last key that you pressed.

- **All OFF (All OFF)**

Hides at once (1) all analog signal input channels, CH1 to CH8, and (2) the logic signals, LOGIC(L) and LOGIC(A|B).

* LOGIC(A|B) is available on models with the /L16 option.

Copying Channel Information (Copy CH)

You copy the setup information of an analog signal input channel to other analog signal input channels.

- **Source (Source)**

From one of the settings below, select the analog signal input channel to copy from.
CH1 to CH8

- **Copy Destination (Destination)**

From one of the settings below, select the analog signal input channels to copy to.
All or one or more channels from CH1 to CH8

- **Copy (Copy)**

Copies the setup information. Copy is not performed on the channel that is set as the copy source.

Setup Information That Is Copied

Vertical axis settings except the label along with the trigger level, coupling, rejection, and window comparator settings are copied.

2 Vertical Axis (Logic Signal)

You can configure the [vertical display range](#), [vertical position](#), [bit setup](#), [bus display](#), [state display](#), [display order](#), [deskew](#), and [channel utility](#) settings for the logic signals. Logic signals are applied through the logic signal input ports on the front panel.

Logic Signal Input Ports

The DLM4000 has two logic signal input ports: LOGIC(L) port and LOGIC(A|B) port.

- LOGIC(L): A standard equipped logic signal input port. It can receive 8-bit logic signals, L0 to L7.
- LOGIC(A|B): A logic signal input port equipped on models with the /L16 option. It can receive 8-bit logic signals on each port, A (A0 to A7) and B (B0 to B7). You can combine ports A and B and use them as a 16-bit logic signal port.

Turning the Display On and Off (Display)

Set whether or not to display the logic signal waveform. The waveform display area for the LOGIC(L) signals is the same as that for analog signal CH8. You can press L or CH8 to select the waveform to display. The selected key will illuminate.

- ON: Displays the waveform
- OFF: Does not display the waveform

Vertical Display Range (SCALE knob)

You can set the logic signal's vertical display range to one of three levels.

Press L or A|B (/L16 option) to select the waveform (the corresponding key illuminates), and turn the SCALE knob to set the display size.

Vertical Position (Vertical POSITION knob)

You can move the logic signal's vertical display position within ± 4 divisions.

Press L or A|B (/L16 option) to select the waveform (the corresponding key illuminates), and turn the \blacklozenge POSITION knob to set the vertical position.

Setting the Bits (Bit Setup)

For each bit, you can turn on or off the display, set the label (Name), and threshold level (Threshold, Level).

You can set whether to set the threshold level separately for each bit (ThresholdType) ► [See here](#), and noise rejection (Noise Rejection) ► [See here](#).

Turning the Display On or Off

For each bit, you can turn the display on or off. For each logic port, LOGIC(L), LOGIC(A), and LOGIC(B), you can also turn on or off the display of all bits at once. LOGIC(A) and LOGIC(B) are available on models with the /L16 option.

Label (Name)

Set the label that appears when the bit display is turned on using up to eight characters.

2 Vertical Axis (Logic Signal)

Threshold Level (Threshold, Level)

Set the level (threshold level) of the logic signal to detect, high or low.

Preset (Threshold)

Selecting from the following presets automatically sets the threshold level.

CMOS(5V)	2.5 V
CMOS(3.3V)	1.65 V
CMOS(2.5V)	1.25 V
CMOS(1.8V)	0.9 V
ECL	-1.3 V

Setting Specific Threshold Levels (Level)

The selectable range varies depending on the logic probe to use. If you specify a preset and then change the level, the preset column changes to "Userdef."

- Model 701988: ± 40 V (in 0.05 V steps)
- Model 701989: ± 6 V (in 0.05 V steps)

Setting Whether to Set the Threshold Level Separately for Each Bit (ThresholdType)

When the 701989 logic probe is connected, you can select whether to set the threshold level separately for each bit.

- All: Set the threshold of all bits to the same value
- Each: Set the threshold level for each bit





When you connect one of the following logic probes to the DLM4000, ThresholdType is set automatically.

- Model 701988: Fixed to All. The setup menu does not appear.
 - Model 701989: Each (select All or Each)
-

Noise Rejection (Noise Rejection)

When the 701989 logic probe is connected, you can apply hysteresis to the threshold so that the high and low states do not change as long as the signal level changes within that range.

Select the hysteresis from one of the following settings below.

	Hysteresis of approximately 100 mV around the threshold level
	Hysteresis of approximately 250mV around the threshold level

* The values above are rough values. They are not strictly guaranteed.

The hysteresis is fixed for the following logic probe, so the setup menu will not appear.

Model 701988: Approx. 80 mV

Bus Display (Bus, Bus2, and Bus3)

Logic bit signals can be displayed as a bus signal.

- LOGIC(L): Bit signals L0 to L7 are assigned to the MSB to LSB bits on the bus and displayed as a Bus signal.
- LOGIC(A|B): Bit signals A0 to A7 and B0 to B7 are assigned to the MSB to LSB bits on the buses and displayed as Bus2 and Bus3 signals. This is available on models with the /L16 option.

Display ON/OFF (Display)

You can turn the bus display on or off. If you turn it on, a bus display appears according to the specified bus bit assignments (Assignment), label (Name), and format (Format).

- ON: Shows the bus display
- OFF: Hides the bus display

LOGIC(L) Example

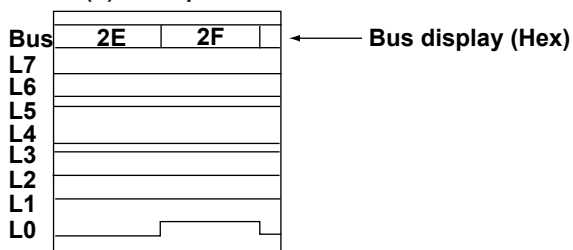

Bus Bit Assignments (Assignment)

Set which bits to assign to the bits on the bus (from the MSB to LSB). The bit assignments here are used to measure the bus value during cursor measurement.

Edit Menu

In the assignment edit menu, you can select a position in the bus to assign a bit, delete an assigned bit, reverse the MSB to LSB order of the bits (Reverse), and so on.

Bits

Select the bit to assign from the bits of LOGIC(L) or LOGIC(A|B). LOGIC(A|B) is available on models with the /L16 option.

Label (Name)

Set the label that appears when the bus display is turned on using up to eight characters.

Format (Format)

Select the format for displaying the bus.

- Bin: Binary notation
- Hex: Hexadecimal notation

State Display (State)

The state display shows logic signal data that has been sampled on the edge of the signal specified as the clock source. Even when the input signal changes, the state is retained until the clock source edge changes.

Display ON/OFF (State)

You can turn the state display on or off. If you turn it on, the state is shown according to the specified clock source (Clock), detection level (Threshold), and clock source polarity (Polarity).

- ON: Shows the state display
- OFF: Hides the state display

State Display Example

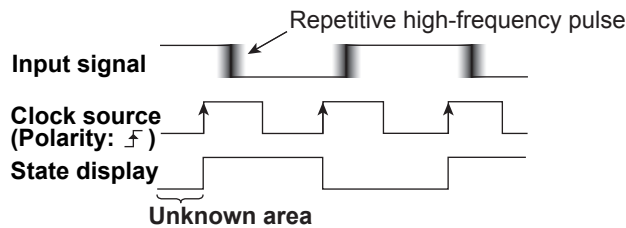

Clock Source (Clock)

You can select the clock source from the settings below.

- LOGIC(L): CH5 to CH7 and LOGIC(L0 to L7)
- LOGIC(A|B): A0 to A7 and B0 to B7; available on models with the /L16 option.

Clock Source Polarity (Polarity)

Select the clock source polarity.

	When the clock source changes from low to high
	When the clock source changes from high to low
	When the clock source changes from low to high or from high to low

Detection Level (Threshold)

Set the level for detecting edges. Set this when the clock source is set to CH5, CH6, or CH7.

Range: ± 5 div

Hysteresis (Hysteresis)

You can apply a hysteresis to the detection level so that edges are not detected on small changes. Set this when the clock source is set to CH5, CH6, or CH7.

Range: 0.0 div to 4.0 div

Resolution: 0.1 div



When the state display of the LOGIC(L) signal is on, Math/Ref4 cannot be used.

Assignment (Assignment)

You can set whether to apply the state display separately for the bus and each bit. For each logic port, LOGIC(L) and LOGIC(A|B), you can also set the bus and all bits at once. LOGIC(A|B) is available on models with the /L16 option.

Setting the Display Order of Bits and the Bus (Bit Order)

For each logic port, LOGIC(L) and LOGIC(A|B), set the vertical display order of bits and the bus on the screen. Select the bit or bus to move and then specify the destination. LOGIC(A|B) is available on models with the /L16 option.

Deskew (Deskew)

You can adjust for the time offsets (skew) between the logic signal and other signals, which are caused by the use of different types of probes, to measure signals. For each logic port, LOGIC(L), LOGIC(A), and LOGIC(B), set deskewing. LOGIC(A) and LOGIC(B) are available on models with the /L16 option.

Range: -100.0 ns to 100.0 ns (in steps of 0.01 ns)

Channel Utility (CH UTIL)

All ON/All OFF (All ON/All OFF)

You can show or hide at once the signals of the logic input port to which a logic probe is connected.

- **All ON (All ON)**

Shows all signals at once.

For analog signal input channels, see the channel utility explanation in chapter 1, “Vertical Axis (Analog Signal).”

▶ [See here.](#)



Analog signal input channel CH8 and logic signal input port LOGIC(L) cannot measure signals simultaneously. The signal that corresponds to the last key that you pressed, either CH8 or L, can be measured. Therefore, “All ON” will be applied to the channel or port that corresponds to the last key that you pressed. If a logic probe is not connected, the “All ON” function will not work.

- **All OFF (All OFF)**

Hides at once (1) all analog signal input channels, CH1 to CH8, and (2) the logic signals, LOGIC(L) and LOGIC(A|B). LOGIC(A|B) is available on models with the /L16 option.

3 Horizontal Axis (Time Axis)

Time Axis Setting (TIME/DIV knob)

The time axis scale is set as a length of time per grid division. You can adjust the amount of time that you want to display waveforms for by setting the time axis. Because the horizontal display range is 10 divisions, the amount of time displayed is equal to the TIME/DIV setting \times 10. The selectable range is 1 ns/division to 500 s/division.

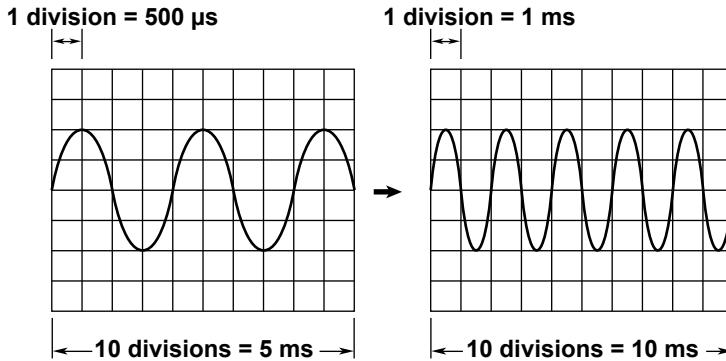

Relationship between the Time Axis Setting, Record Length, and Sample Rate

The relationship between the time axis setting, record length, and sample rate is as follows:

When the record length and the time axis are set so that the sample rate is at the maximum rate, if you decrease the time axis setting, the record length is reduced.

$$\text{Sample rate} = \text{Record length} / (\text{time axis setting [s/division]} \times 10 [\text{divisions}])$$

Time Axis Setting and Roll Mode Display

When the following conditions are true, if you set the time axis to one of the settings in the following table, the DLM4000 display switches to roll mode.

- The acquisition mode is not set to Average.
- The trigger mode is Auto, Auto Level, or Single.

Record Length	Time Axis Setting
1.25 Mpoints or less	100 ms/division to 500 s/division
6.25 Mpoints	500 ms/division to 500 s/division
12.5 Mpoints	500 ms/division to 500 s/division
25 Mpoints	1 s/division to 500 s/division
62.5 Mpoints	5 s/division to 500 s/division
125 Mpoints	5 s/division to 500 s/division
250 Mpoints	10 s/division to 500 s/division

3 Horizontal Axis (Time Axis)

Roll Mode Display

In roll mode, the displayed waveform is not updated using triggers. Rather, the oldest data is deleted as new data is acquired, and the waveform flows from the right to the left of the screen. This mode is useful for observing low-frequency signals or signals that change slowly.

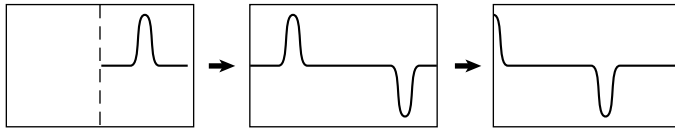

About the roll-mode display

- The display is set to roll mode when the waveform acquisition is set to single mode, but the roll mode display stops when the DLM4000 triggers.
 - If the record length is 1.25 Mpoints or longer, measured time values appear after you stop waveform acquisition using the RUN/STOP key.
 - If the record length is set such that waveform acquisition operates in single mode (6.25 Mpoints or longer for models without a memory option), automatically measured values of waveform parameters appear when the roll mode display stops.
 - When the waveform acquisition is set to single mode, the DLM4000 will not display computed waveforms (MATH waveforms) while it is acquiring waveforms. The DLM4000 will display computed waveforms after it triggers and the roll mode display stops.
 - The DLM4000 will not display computed waveforms (MATH waveforms) that have been generated through user-defined computation while it is acquiring waveforms. The DLM4000 will display the computed waveforms after it stops acquiring waveforms.
-

4 Triggering

A trigger is a cue used to display the waveform on the screen. A trigger occurs when the specified trigger condition is met, and a waveform is displayed on the screen.

Trigger Mode (Trigger Mode)

The trigger mode determines the conditions for updating the displayed waveforms. There are five trigger modes.

Auto Mode (Auto)

If the trigger conditions are met before a 100-ms timeout, the DLM4000 updates the displayed waveforms on each trigger occurrence. If not, the DLM4000 automatically updates the displayed waveforms.

If the time axis is set to a value that would cause the display to switch to roll mode, roll mode display will be enabled.

Auto Level Mode (Auto Level)

If a trigger occurs before a timeout, the DLM4000 updates the waveform in the same way as Auto mode.

If a trigger does not occur, the DLM4000 detects the center value of the trigger source amplitude, automatically changes the trigger level to the center value, triggers on that value, and updates the displayed waveform. Auto Level mode is valid when the trigger source is set to a channel from CH1 to CH8. For all other cases, Auto Level mode operates in the same way as Auto mode.

If the time axis is set to a value that would cause the display to switch to roll mode, roll mode display will be enabled.

Normal Mode (Normal)

The DLM4000 only updates the waveform display when the trigger conditions are met. If no triggers occur, the display is not updated. If you want to view waveforms that the DLM4000 cannot trigger on, or if you want to check the ground level, use Auto mode.

N Single Mode (N Single)

The DLM4000 acquires waveforms each time the trigger conditions are met until a specified number of waveforms have been acquired, and then displays all of the acquired waveforms. If no triggers occur, the display is not updated.

Single Mode

When the trigger conditions are met, the DLM4000 updates the displayed waveform once and stops waveform acquisition. When you press SINGLE on the front panel, the DLM4000 acquires waveforms in Single mode.

If the time axis is set to a value that would cause the display to switch to roll mode, roll mode is used until a trigger occurs. When the DLM4000 triggers, roll mode will stop when it acquires the record length's post-trigger data.

▶ [See here.](#)



-
- The trigger mode setting applies to all trigger types.
 - The trigger conditions that were used to acquire the displayed waveform appear at the upper right of the screen.
 - If you set the trigger mode to Auto when using a trigger combination, the timeout only applies to the trigger A trigger conditions.
-

Trigger Type (Type)

The following trigger types are available.

EDGE

- [Edge trigger](#): Triggers on the edges of a single trigger source (a simple trigger)

ENHANCED

- [Edge OR trigger](#): Triggers on the OR of multiple trigger source edges.
 - [Edge Qualified trigger](#): Triggers on trigger source edges while the qualifications are met.
 - [State trigger](#): Triggers when the trigger source matches or does not match the state condition.
 - [Pulse Width trigger](#): Triggers on a trigger source pulse-width condition (such as More than, Less than, and Between).
 - [State Width trigger](#): Triggers on the time-duration for which the trigger source matches or does not match the state condition.
 - [Serial trigger*](#) (FlexRay, CAN, CAN FD, LIN, SENT, PSI5 Airbag, UART, I2C, SPI, User Define): Triggers on various serial bus signal conditions.
 - [TV trigger](#) (NTSC, PAL, SDTV, HDTV, User Define): Triggers on various TV signal conditions.
- * The FlexRay, CAN, CAN FD, LIN, SENT, PSI5 Airbag, UART, I2C, and SPI bus triggers are available on models with any of the /F1 to /F11 options.



- The active trigger, EDGE or ENHANCED, is the one whose key is illuminated.
- You can also configure the DLM4000 to trigger on the combination of trigger A and trigger B, where trigger A is the trigger configured using the EDGE or ENHANCED key, and trigger B is the trigger configured using the B TRIG key. The combination trigger is active when the B TRIG key is illuminated.

▶ [See here.](#)

Forced Trigger [FORCE TRIG]

Pressing FORCE TRIG (SHIFT + B TRIG) on the front panel forces the DLM4000 to trigger even when trigger conditions are not met.

Signal Type and Trigger Type Combinations

The signal type (analog or logic) determines what trigger types you can use.

	CH1 to CH8	LOGIC	Mixed
Edge	Yes	Yes	-
Edge OR	Yes	No	No
Edge Qualified	Yes	Yes	Yes
State	Yes	Yes	Yes
Pulse Width	Yes	Yes	-
State Width	Yes	Yes	Yes
Serial			
FlexRay	Yes	No	-
CAN	Yes	No	-
CAN FD	Yes	No	-
LIN	Yes	No	-
SENT	Yes	Yes	-
PSI5 Airbag	Yes	No	-
UART	Yes	Yes	-
I2C	Yes	Yes	Yes
SPI	Yes	Yes	Yes
User Define	Yes	No	No
TV	Yes	No	-



- For all triggers except the serial trigger, you can set CH8 or LOGIC(L) as a trigger source, regardless of whether their corresponding keys (CH8 or L) are illuminated. CH8 or LOGIC(L), whichever is illuminated, can be selected for the waveform display, measurement, analysis, searching, and serial triggers whose trigger source can be set to LOGIC.
- When Interleave mode is on, the DLM4000 cannot acquire waveforms for the CH2, CH4, CH6, CH8, and LOGIC(L) inputs. However, these inputs can be used as trigger sources.

Basic Trigger Settings

- **Trigger source:** The trigger source signal.
- **Trigger slope:** Specifies which edge, rising or falling, the DLM4000 will trigger on.
- **Window comparator:**
Specifies whether the DLM4000 will trigger when the trigger source enters or leaves the specified window.
- **Trigger level:** The trigger determination level.
- **Trigger position:** The position where the trigger point will be displayed.
- **Trigger delay:** The delay from the trigger point.
- **Trigger hold-off:** The amount of time to hold off the next trigger detection.
- **Trigger coupling:** The trigger source coupling.
- **HF rejection:** For rejecting high-frequency components in the trigger source.
- **Noise rejection:**
The trigger level margin (the DLM4000 does not trigger on changes in the signal level within this margin).

Edge Trigger [EDGE]

The DLM4000 triggers on trigger source edges (rising or falling edges). An edge refers to a point where the trigger source passes through the trigger level.

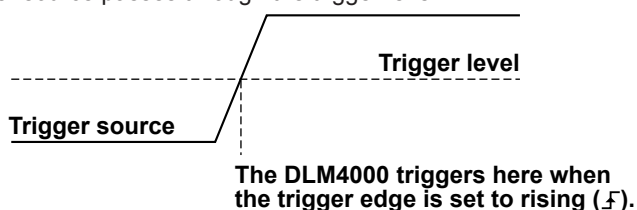

Trigger Source (Source)

Trigger source refers to the signal that is used to check the specified trigger conditions. You can set the trigger source to one of the settings below.

CH1 to CH8

A signal that is received through front-panel input terminals 1 to 8 (the number of input terminals varies depending on the model).

LOGIC: LOGIC(L) and LOGIC(A|B)

A signal that is received through a front-panel logic signal input port.

You need to select the source bit (Source: L0 to L7, A0 to A7, or B0 to B7).

* A0 to A7 and B0 to B7 are available on models with the /L16 options.

EXT (external trigger signal)

The external signal that is received through the rear-panel TRIGGER IN terminal.

4 Triggering

LINE (the DLM4000 power source)

The DLM4000 only triggers on the rising edge.

The settings that you need to configure vary depending on the selected trigger source as follows:

	CH1 to CH8	LOGIC	EXT	LINE
Slope	Yes	Yes	Yes	-
Coupling	Yes	-	-	-
HF Rejection	Yes	-	-	-
Noise Rejection	Yes	-	-	-
Probe	-	-	Yes	-
Window	Yes	-	-	-
Source Bit	-	Yes	-	-
Level	Yes	Yes	Yes	-

Trigger Level (Level)

Trigger level refers to the signal level used as a reference for detecting a signal's rising and falling edges or high and low states. With simple triggers such as the edge trigger, the DLM4000 triggers when the trigger source level passes through the specified trigger level.

The analog signals (CH1 to CH8) and the logic signal (LOGIC) have different selectable trigger level ranges.

Analog Signals

Range: 8 divisions within the screen

Resolution: 0.01 divisions (for example: 0.02 mV when the time axis is set to 2 mV/division)

Logic Signals

The selectable range varies depending on the logic probe that you use.

- Model 701988: ± 40 V (0.05 V resolution)
- Model 701989: ± 6 V (0.05 V resolution)







- The trigger level is set using the jog shuttle. If a single trigger source is used (Edge, Edge Qualified, Pulse Width, FlexRay, CAN, CAN FD, LIN, SENT, UART, or TV), you can also use the front-panel LEVEL knob to set the trigger level.
 - When the front-panel LEVEL knob is valid, you can press it to automatically set the trigger level.
 - If the jog shuttle is controlling the trigger level, you can press the RESET key to reset the trigger level to the current offset voltage.
 - The selectable range of threshold levels used to detect logic signal bit states is the same as the selectable range of the [source bit](#) trigger level. How you can set the bit levels varies depending on the logic probe that you are using.
 - Model 701988: The level setting applies to all bits.
 - Model 701989: Each bit level setting separately.
 - You can also set the level of each bit of the logic signal using Level on the bit setup menu of the L key or the A|B key (/L16 option) (the level is shared). If you change the level on the trigger menu, the level value on the bit setup menu of the L key or the A|B key (/L16 option) will also change.
-

Trigger Slope (Slope/Polarity)

Slope refers to the signal movement, such as from a low level to a high level (rising slope) or from a high level to a low level (falling slope). When a slope is used as one of the trigger conditions, it is called a trigger slope.

The following trigger slope settings are available for triggering the DLM4000.

	When the trigger source changes from a level below the trigger level to a level above the trigger level (rising) (Slope)
	When the trigger source changes from a level above the trigger level to a level below the trigger level (falling) (Slope)
	When the window comparator is ON and the trigger source level enters the specified voltage range (Polarity)
	When the window comparator is ON and the trigger source level goes outside of the specified voltage range (Polarity)

*  is only selectable when the trigger source is an analog signal.

Trigger Coupling (Coupling)

You can switch the trigger source coupling. Select the coupling appropriate for the trigger source. The input coupling is fixed to DC when the trigger source is set to LOGIC, EXT, or LINE.

- AC: The trigger source is used with the DC component removed.
- DC: The trigger source is used directly.

HF Rejection (HF Rejection)



Use HF rejection when you want to remove the high-frequency components (above approximately 15 kHz or 20 MHz) from the trigger signal. You can select from one of the settings below. You cannot use HF rejection when the trigger source is set to LOGIC, EXT, or LINE.

OFF, 15 kHz, or 20 MHz

Noise Rejection (Noise Rejection)

Noise rejection establishes a trigger level margin (hysteresis) so that the DLM4000 does not trigger if the signal level change is within the margin.

You can set the hysteresis to either of the two settings below. You cannot use noise rejection when the trigger source is set to LOGIC, EXT, or LINE.

	Approximately 0.3 divisions* of hysteresis around the trigger level
	Approximately 1 division* of hysteresis around the trigger level

* The above values are approximate values. They are not strictly warranted.

Probe Attenuation (Probe)

When you set the trigger source to EXT, set the probe attenuation (1:1 or 10:1).

4 Triggering

Window Comparator (Window)

When the window comparator is off, the DLM4000 determines whether the trigger condition, the Qualify condition, or the state condition is on the waveform's rising or falling edge or high or low point.

When the window comparator is turned on, the DLM4000 determines whether the trigger condition, the Qualify condition, or the state condition is inside or outside the window.

You can set the window comparator on and off separately for each channel.

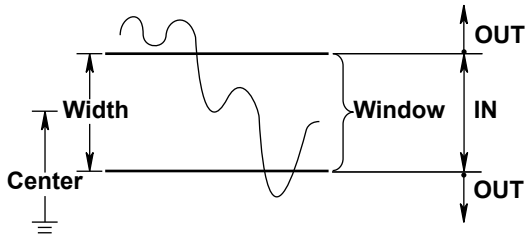

Selectable Range and Resolution

Setting	Selectable Range	Resolution
Center	± 4 divisions around the screen center	0.01 divisions
Width	± 4 divisions around the center	0.02 divisions



You can set the Width value to a value greater than ± 4 divisions from the screen center. However, if the high or low level goes outside the screen, the DLM4000 operation becomes unstable.

Trigger Position (◀POSITION▶ knob)

When you move the trigger position, the ratio of the displayed data before the trigger point (the pre-trigger section) and the data after the trigger point (the post-trigger point) changes.

When the trigger delay is 0 s, the trigger point and trigger position coincide.

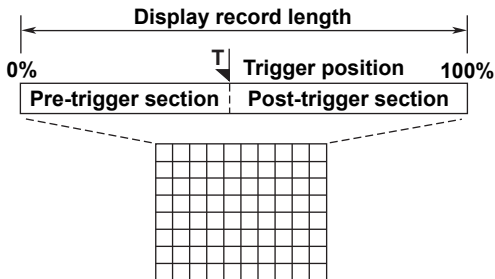

Selectable range: 0 to 100% of the display record length.

Resolution: 1%



- If you change the trigger position when waveform acquisition is stopped, the DLM4000 re-displays waveforms using the new position.
- The time values of cursor measurements are based on the trigger position. If you change the trigger position, the measured values will change (except during roll mode display).
- If you change the TIME/DIV setting, the location of the trigger position does not change.

Trigger Delay (DELAY)

The DLM4000 normally displays waveforms before and after the trigger point. You can set a trigger delay to display waveforms that the DLM4000 has acquired a specified amount of time after the trigger occurrence.

Selectable range: - (post-trigger time*) to 10 s

Resolution: $(1 \div \text{sample rate})/10$ or 10 ps, whichever is longer

* Post-trigger time: The time between the trigger position and the right edge of the main window

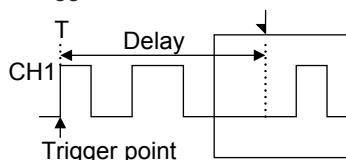

T: Mark that indicates the trigger point

↓: Mark that indicates the trigger position

Delay Cancel (Delay Cancel)

You can select whether or not to apply the specified delay to the time measurement values.

The default setting is ON.

- ON: Measures time values by setting the trigger position to 0 s (the delay is not applied to time measurement values).
- OFF: Measures time values by setting the trigger point to 0 s (the delay is applied to time measurement values).



- The delay value is retained even if you change the TIME/DIV setting.
- By setting the trigger position and trigger delay, you are actually setting the waveform's horizontal position (the display position of the waveform along the time (horizontal) axis in reference to the trigger point).

Trigger Hold-off (Holdoff)

The trigger hold-off feature temporarily stops the detection of the next trigger once a trigger has occurred. This feature is useful when you want to change the signal acquisition interval, such as when you are observing a PCM (Pulse Code Modulation) code or other pulse train signal or when you are using the history feature.

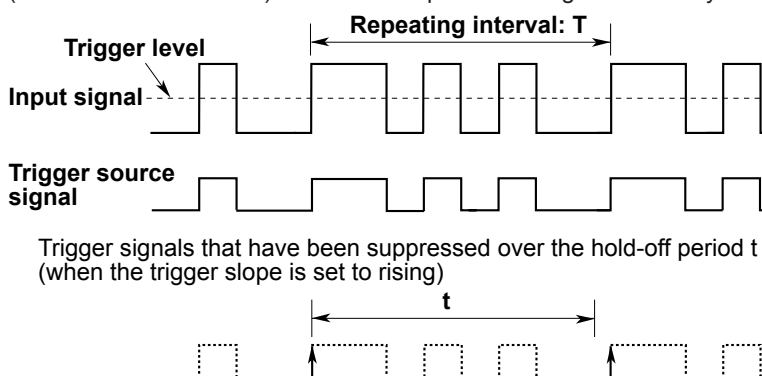

Selectable range: 20 ns to 10.0000 s (the default value is 20 ns)

Resolution: 5 ns



- In repetitive sampling mode, waveform updating may slow down. If this happens, reduce the hold-off time setting.
- To trigger with the hold-off time set to 100 ms or longer, set the trigger mode to Normal.

Edge OR Trigger [ENHANCED]

The DLM4000 triggers on multiple trigger source edges.

Example

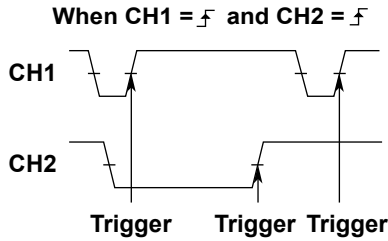

Trigger Source Pattern (Pattern)

Set the trigger slope for each channel from CH1 to CH8.

- On the Pattern menu, channels whose check boxes are selected become trigger sources.
- Selecting the All check box selects the check boxes of all channels at once, and all channels become trigger sources. Clearing the check box of any channel clears the All check box.

f	When the trigger source changes from a level below the trigger level to a level above the trigger level (rising) (Slope)
\bar{f}	When the trigger source changes from a level above the trigger level to a level below the trigger level (falling) (Slope)
$f\bar{f}$	Either rising or falling (Slope)
\overline{f}	When the window comparator is ON and the trigger source level enters the specified voltage range (Polarity)
f	When the window comparator is ON and the trigger source level goes outside of the specified voltage range (Polarity)
X	None



- When triggering using Edge OR, the trigger source frequency is limited to 50 MHz or less.
- LOGIC, EXT, and LINE signals cannot be used as the trigger source of Edge OR triggers.

Trigger Level (Level), Coupling (Coupling)

HF Rejection (HF Rejection), Noise Rejection (Noise Rejection)

Window Comparator (Window)

Set these items for each trigger source.

You can use the Set to All CH feature to configure items that apply to CH1 through CH8.

These items are the same as those of the edge trigger.

▶ [See here.](#)

Trigger Position (POSITION), Trigger Delay (DELAY), Trigger Hold-Off (Hold Off)

These items are the same as those of the edge trigger.

▶ [See here.](#)

Edge Qualified Trigger [ENHANCED]

While the conditions of the signals other than the trigger source meet the specified qualifications, the DLM4000 triggers on the trigger source edge.

Example

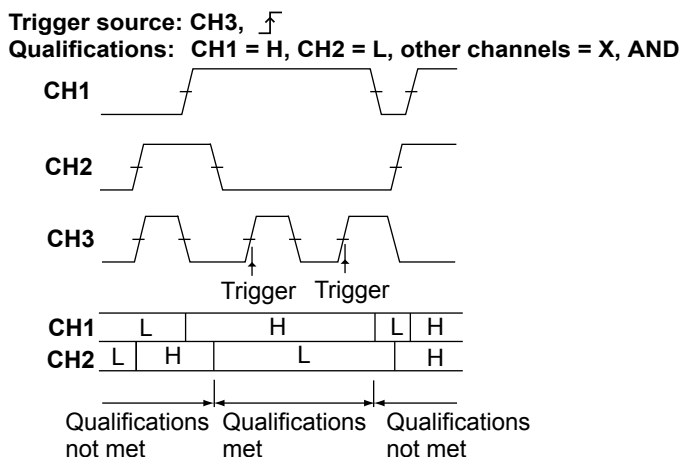

Trigger Source (Source)

Select the trigger source from the following: CH1 to CH8, to LOGIC, or to EXT.

For the selected trigger source, set the slope, window comparator, coupling, HF rejection, noise rejection, trigger level, [source bit](#) (only for LOGIC), and probe attenuation (only for EXT).

Trigger Slope (Slope/Polarity)

The trigger slope is the same as that of the edge trigger.

▶ [See here.](#)

Qualifications (Qualification)

To define a condition for enabling the trigger feature, set the state of a signal (CH1 to CH8, L0 to L7, A0 to A7, B0 to B7)¹ other than the trigger source.

H	When the signal level is high
L	When the signal level is low
IN ²	When the signal level is within the specified voltage range (when the window comparator is on)
OUT ²	When the signal level is outside the specified voltage range (when the window comparator is on)
X	Don't care

1 A0 to A7 and B0 to B7 are available on models with the /L16 options.

2 IN and OUT are only selectable when the trigger source is an analog signal (CH1 to CH8).

Combination (Logic)

Set the combination of signal states to AND or OR.

AND	Allows triggering when all of the signal conditions are met
OR	Allows triggering when any of the signal conditions is met

Trigger Condition (Condition)

Select the condition for triggering the DLM4000 from one of the settings below.

True	The DLM4000 triggers on the trigger source's edge when the qualifications are met.
False	The DLM4000 triggers on the trigger source's edge when the qualifications are not met.



For the trigger to work properly, the required conditions of the trigger source must not change for at least 3 ns before and after the trigger source edge.

**Trigger Level (Level), Coupling (Coupling)
HF Rejection (HF Rejection), Noise Rejection (Noise Rejection)
Window Comparator (Window)**

Set these items for the trigger source and qualification sources (CH1 to CH8 and LOGIC).
These items are the same as those of the edge trigger.

▶ [See here.](#)

Trigger Position (POSITION), Trigger Delay (DELAY), Trigger Hold-Off (Hold Off)

These items are the same as those of the edge trigger.

▶ [See here.](#)

State Trigger [ENHANCED]

The DLM4000 triggers when the result of comparing each signal state to the specified state condition changes from met to not met or from not met to met. If you specify a clock source, the DLM4000 samples the comparison results using the clock and detects the point of change in sync with the clock.

Example

Clock source: None
State: CH1 = H, CH2 = L, other channels = X, AND
Condition: Exit

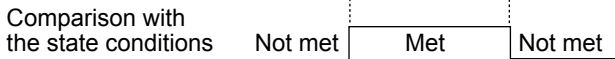
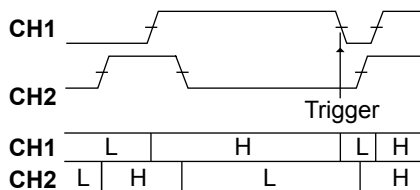

Clock source: CH3, \bar{F}
State: CH1 = H, CH2 = L, CH4 = X, AND
Condition: Exit

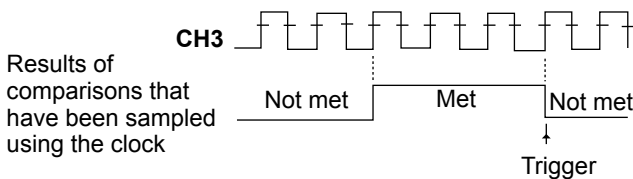
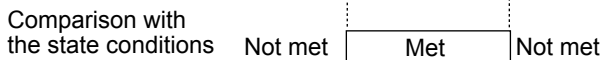
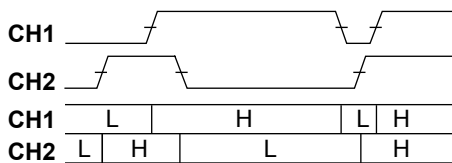

State Condition (State)

Set each signal's state and the clock source.

Pattern (Pattern)

Set the states of signals (CH1 to CH8 and LOGIC) other than the clock source.

H	When the signal level is high
L	When the signal level is low
IN	When the signal level is within the specified voltage range (when the window comparator is on)
OUT	When the signal level is outside the specified voltage range (when the window comparator is on)
X	Don't care

* IN and OUT are only selectable when the trigger source is an analog signal (CH1 to CH8).

Clock Source (Clock)





You can select from one of the settings below.

- CH1 to CH8
- LOGIC
- X (Do not specify the clock source)



Clock Source Slope or Polarity

Select the clock source slope or polarity.

- If the clock source is an analog signal (CH1 to CH8)

	When the clock source changes from a level below the specified level to a level above the specified level (rising)
	When the clock source changes from a level above the specified level to a level below the specified level (falling)
	When the clock source level enters the specified voltage range (when the window comparator is on)
	When the clock source level goes outside of the specified voltage range (when the window comparator is on)

- If the clock source is a logic signal

	When the source bit level changes from low to high.
	When the source bit level changes from high to low.



- You cannot set a state pattern to a signal that is set as the clock source.
- Checking the state patterns in sync with a clock source will work properly when the pattern does not change for at least 3 ns before and after the clock source edge.

Combination (Logic)

Set the combination of signal states to AND or OR.

AND	The comparison result is set to "True" when all of the signal conditions are met.
OR	The comparison result is set to "True" when any of the signal conditions is met.

Trigger Condition (Condition)

Select how the result of comparing each signal state to the state condition must change for the DLM4000 to trigger.

Enter	When the condition changes from not met to met
Exit	When the condition changes from met to not met

Level (Level, Threshold)

For each signal (CH1 to CH8 and LOGIC), set the reference level used to detect the signal state. This item is the same as the trigger level of the edge trigger.

▶ See here.

Coupling (Coupling)

HF Rejection (HF Rejection), Noise Rejection (Noise Rejection)

Window Comparator (Window)

Set these items for all signal sources including the clock source (CH1 to CH8 and LOGIC). These items are the same as those of the edge trigger.

▶ See here.

Trigger Position (POSITION), Trigger Delay (DELAY), Trigger Hold-Off (Hold Off)

These items are the same as those of the edge trigger.

▶ See here.

Pulse Width Trigger [ENHANCED]

The DLM4000 triggers when the relationship between the trigger source's pulse width and the specified reference times meets the condition of the selected time width mode.

Examples for different time width modes

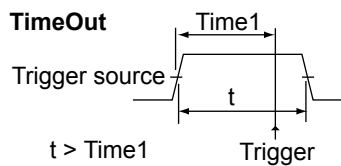
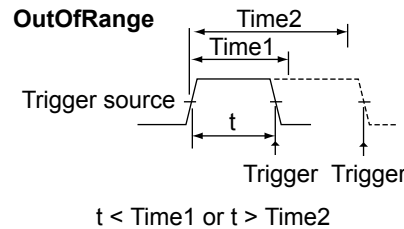
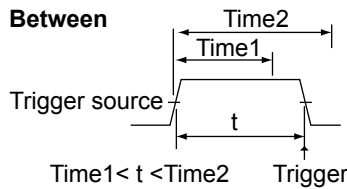
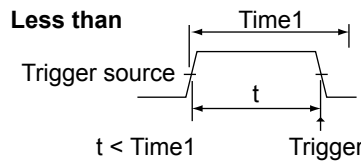
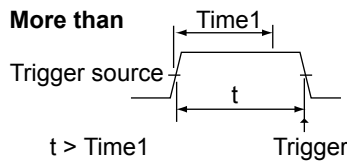

- * The trigger point when conditions are met is as follows:
 More than, Less than, Between, or OutOfRange:
 The DLM4000 triggers at the end of the trigger source pulse.
 TimeOut:
 The DLM4000 triggers when the specified amount of time elapses.



Trigger Source (Source)

Select the trigger source from the following: CH1 to CH8, to LOGIC, or to EXT. (The selectable settings vary depending on the model.) If you set the trigger source to LOGIC, set the [source bit](#). If you set the trigger source to EXT, set the probe attenuation.

Configure the polarity, window comparator, input coupling, HF rejection, noise rejection, and trigger level settings for the selected trigger source.

Polarity (Polarity)

Select which trigger source polarity will cause the comparison of the pulse width with the reference times. The trigger source polarity is based on the trigger level.

	When the signal level is high
	When the signal level is low
IN	When the trigger source level is within the specified voltage range (when the window comparator is on)
OUT	When the trigger source level is outside the specified voltage range (when the window comparator is on)

* IN and OUT are only selectable when the trigger source is an analog signal (CH1 to CH8).

Time Width Mode (Mode)

Set what kind of relationship must be established between the trigger source's pulse width and the specified reference times (Time1 and Time2) for the DLM4000 to trigger.

More than	When the pulse width is longer than the specified reference time
Less than	When the pulse width is shorter than the specified reference time
Between	When the pulse width is longer than Time1 but shorter than Time2
OutOfRange	When the pulse width is shorter than Time1 or longer than Time2
TimeOut	When the pulse width is longer than the specified reference time

Reference Times (Time1 and Time2)**Selectable Range**

The selectable range for Time1 and Time2 varies depending on the time width mode.

More than	Time1: 4 ns to 10 s
Less than	Time1: 6 ns to 10 s
Between	Time1: 4 ns to [10 s - 4 ns], Time2: 8 ns to 10 s The difference between Time1 and Time2 must be greater than or equal to 4 ns.
OutOfRange	Time1: 6 ns to [10 s - 4 ns], Time2: 8 ns to 10 s The difference between Time1 and Time2 must be greater than or equal to 4 ns. However, the following settings are allowed: Time1 = 6 ns and Time2 = 8 ns.
TimeOut	Time1: 4 ns to 10 s

Resolution: 2 ns

Trigger Level (Level), Coupling (Coupling)**HF Rejection (HF Rejection), Noise Rejection (Noise Rejection)****Window Comparator (Window)**

Set these items for the trigger source.

These items are the same as those of the edge trigger.

▶ [See here.](#)

Trigger Position (POSITION), Trigger Delay (DELAY), Trigger Hold-Off (Hold Off)

These items are the same as those of the edge trigger.

▶ [See here.](#)

4 Triggering



- The DLM4000 may not trigger properly if the spacing between signals or the signal pulse width is less than 2 ns.
- Under standard operating conditions, the pulse width accuracy is $\pm(0.5\% \text{ of setting} + 2 \text{ ns})$ immediately after a calibration. The “setting” in the above expression is the Time2 value when $\text{Time1} < \text{Pulse} < \text{Time2}$.
- If you set the trigger source to a signal whose window comparator is on, the DLM4000 can trigger based on the length of time the trigger source is within or outside the specified voltage width.

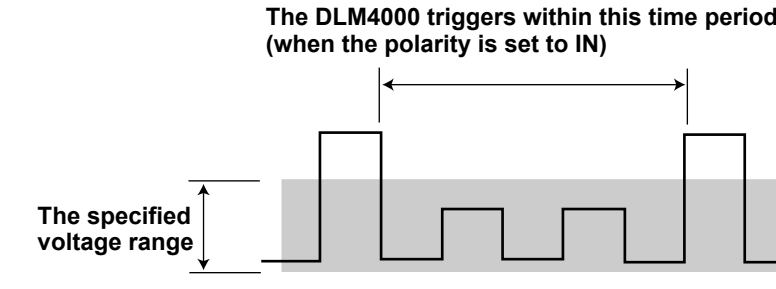

State Width Trigger [ENHANCED]

The DLM4000 triggers if the matched or not-matched condition changes after the time width mode condition has been met. Whether or not the time width mode condition is met is determined by the relationship between the reference time and the length of time for which each signal state matches or does not match the state condition. If you specify a clock source, the DLM4000 samples the comparison results using the clock and triggers on the point of change in sync with the clock.

* If the time width mode is set to TimeOut, the DLM4000 triggers when the specified amount of time elapses.

Example

Mode: More than; clock source: None
State: CH1 = H, CH2 = L, other channels = X, AND
Condition: False

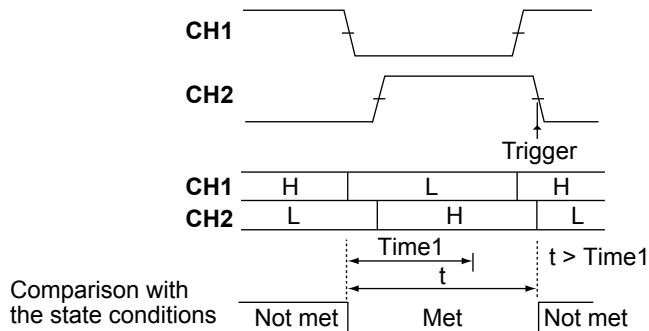

Mode: More than; **clock source:** CH3, \uparrow
State: CH1 = H, CH2 = L, other channels = X, AND
Condition: False

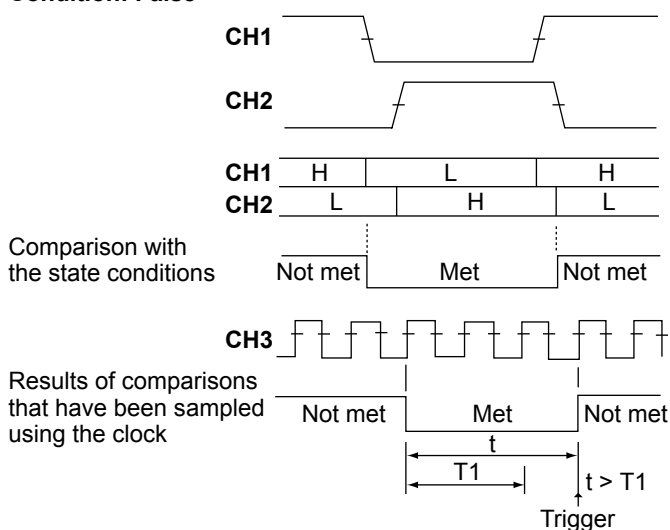

State Condition (State)

Set each signal's state and the clock source.

Pattern (Pattern)

Set the states of signals (CH1 to CH8 and LOGIC) other than the clock source.

H	When the signal level is high
L	When the signal level is low
IN	When the signal level is within the specified voltage range (when the window comparator is on)
OUT	When the signal level is outside the specified voltage range (when the window comparator is on)
X	Don't care

* IN and OUT are only selectable when the trigger source is an analog signal (CH1 to CH8).

Clock Source (Clock)

You can select from one of the settings below.

- CH1 to CH8
- LOGIC
- X (Do not specify the clock source)

Clock Source Slope or Polarity

Select the clock source slope or polarity.

- If the clock source is an analog signal (CH1 to CH8)

\uparrow	When the clock source changes from a level below the specified level to a level above the specified level (rising)
\downarrow	When the clock source changes from a level above the specified level to a level below the specified level (falling)
IN	When the clock source level enters the specified voltage range (when the window comparator is on)
OUT	When the clock source level goes outside of the specified voltage range (when the window comparator is on)

- If the clock source is a logic signal

\uparrow	When the source bit level changes from low to high.
\downarrow	When the source bit level changes from high to low.

4 Triggering



- You cannot set a state pattern to a signal that is set as the clock source.
 - Checking the state patterns in sync with a clock source will work properly when the pattern does not change for at least 3 ns before and after the clock source edge.
-

Combination (Logic)

Set the combination of signal states to AND or OR.

AND	The comparison result is set to "True" when all of the signal conditions are met.
OR	The comparison result is set to "True" when any of the signal conditions is met.

Trigger Condition (Condition)

Select whether to compare the length of time each signal state matches the state condition to the reference time or to compare the length of time each signal state does not match the state condition to the reference time.

True	When the condition is met.
False	When the condition is not met.

Time Width Mode (Mode)

Set what kind of relationship between the length of time the state condition is met or not met and the specified reference times (Time1 and Time2) will cause the DLM4000 to trigger.

More than	When the period during which the state condition is met or not met is longer than the specified reference time and the condition changes
Less than	When the period during which the state condition is met or not met is shorter than the specified reference time and the condition changes
Between	When the period during which the state condition is met or not met is longer than Time1 but shorter than Time2 and the condition changes.
OutOfRange	When the period during which the state condition is met or not met is shorter than Time1 or longer than Time2 and the condition changes.
TimeOut	When the period during which the state condition is met or not met is longer than the specified reference time

Reference Times (Time1 and Time2)

These are the same as the reference times for the Pulse Width trigger.

▶ [See here.](#)

Level (Level, Threshold)

For each signal (CH1 to CH8 and LOGIC), set the reference level used to detect the signal state.

The level is the same as the trigger level for the edge trigger.

▶ [See here.](#)

Coupling (Coupling)

HF Rejection (HF Rejection), Noise Rejection (Noise Rejection)

Window Comparator (Window)

Set these items for all signal sources including the clock source (CH1 to CH8).

These items are the same as those of the edge trigger.

▶ [See here.](#)

Trigger Position (POSITION), Trigger Delay (DELAY), Trigger Hold-Off (Hold Off)

These items are the same as those of the edge trigger.

▶ [See here.](#)



- The DLM4000 may not trigger properly if the spacing between signals or the signal pulse width is less than 2 ns.
- Under standard operating conditions, the time width accuracy is $\pm(0.5\% \text{ of setting} + 2 \text{ ns})$ immediately after a calibration. The “setting” in the above expression is the Time2 value when $\text{Time1} < \text{Pulse} < \text{Time2}$.

Serial Bus Trigger [ENHANCED]

The DLM4000 has trigger features that capture the following ten types of serial bus signals. The FlexRay, CAN, CAN FD, LIN, SENT, PSI5 Airbag, UART, I2C, and SPI bus triggers are available on models with any of the /F1 to /F11 options.

FlexRay Bus Trigger

The FlexRay bus trigger is used to capture FlexRay bus signals. FlexRay is an automotive LAN communication protocol established by the FlexRay Consortium.

CAN Bus Trigger

The CAN bus trigger is used to capture CAN bus signals.

Controller Area Network (CAN) is a serial communication protocol that has been standardized internationally by the ISO (International Organization for Standardization). The DLM4000 is equipped with a symbolic trigger function*.

* Using YOKOGAWA free software, you can convert a CANdb file (.dbc) to a physical value/symbol definition file, (.sbl), load the file into the DLM4000, and use it as a set of trigger conditions. You can obtain the free software “Symbol Editor” from the YOKOGAWA website (<http://www.yokogawa.com/yimi/>).

CANdb files (.dbc) are signal definition database files created using the CANdb or CANdb++ software produced by Vector Informatik.

CAN FD Bus Trigger

The CAN FD bus trigger is used to capture CAN FD bus signals.

CAN FD is an abbreviation for CAN with Flexible Data Rate. It is based on CAN and supports high-speed data-phase transfer rates. The length of data that can be embedded in a single Data Field is expanded to 64 bytes, and the CRC generator polynomial is also expanded. As with CAN, symbolic triggering is possible.

LIN Bus Trigger

The LIN bus trigger is used to capture LIN bus signals.

A Local Interconnect Network (LIN) is a serial communication protocol mainly used in automobiles.

SENT Trigger

The SENT bus trigger is used to capture SENT signals.

SENT is an abbreviation for Single Edge Nibble Transmission. It is a point-to-point unidirectional serial communication protocol. The DLM4000 supports SAE J2716 APR2016 and earlier versions.

PSI5 Airbag Trigger

The PSI5 Airbag trigger is used to capture PSI5 Airbag signals.

PSI is an acronym for Peripheral Sensor Interface. It is a bidirectional communication protocol developed for communication between on-vehicle sensors and control units. PSI5 Airbag is a substandard exclusive for airbags.

UART Trigger

The UART trigger is used to capture UART signals.

A Universal Asynchronous Receiver Transmitter (UART) is an integrated circuit that performs serial-to-parallel conversion and parallel-to-serial conversion. UART signals are generally used in inter-device communication such as with EIA RS-232.

I²C Bus Trigger

The I²C bus trigger is used to capture I²C bus signals.

An Inter Integrated Circuit (I²C) bus is a bi-directional bus for inter-IC communications.

SPI Bus Trigger

The SPI bus trigger is used to capture SPI bus signals.

A Serial Peripheral Interface (SPI) is a synchronous serial bus that is widely used for inter-IC communications and data communications.

User-Defined Trigger

The user-defined trigger is used to capture user-defined serial bus signals.

The DLM4000 synchronizes to the selected clock signal and detects a serial data pattern. You can specify up to 128 bits for the serial data pattern used for triggering. You can set the CS signal, which controls the period over which the data source is checked, and the latch source, which specifies when patterns are compared.

Auto Setup

If you specify the serial bus type and the trigger source, the DLM4000 can automatically configure the bit rate and source level settings and then trigger based on those settings. The auto setup feature will not work properly on some input signals. This feature is in the serial bus signal search feature.

FlexRay Bus Trigger [ENHANCED, option]

The DLM4000 triggers based on the trigger conditions of a particular frame or type of data in a FlexRay bus signal.

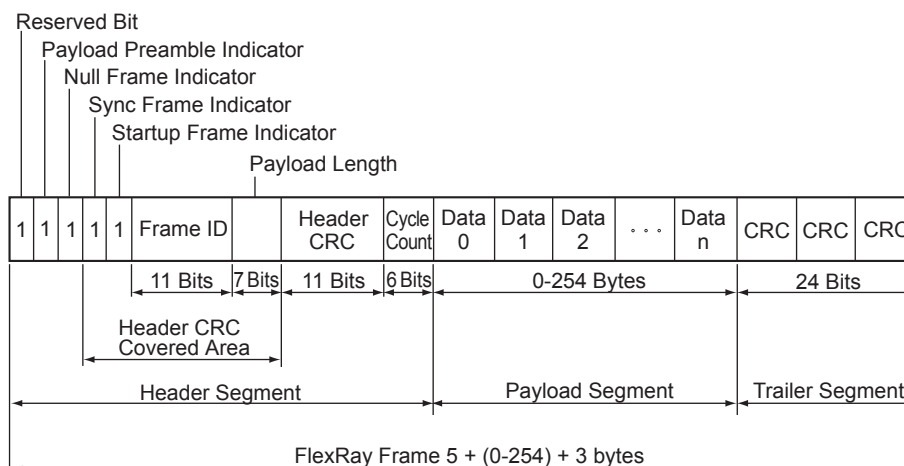

Trigger Mode (Mode)

Select the FlexRay trigger mode from one of the settings below.

Frame Start: Triggers on the start of a frame

Error: Triggers on errors

ID/Data: Triggers on the AND of the ID bit pattern and Data pattern

ID OR: Triggers on the OR of multiple ID bit patterns

Frame Start

The DLM4000 triggers on the start of FlexRay bus signal frames.

Error

The DLM4000 triggers when it detects various types of errors.

- **Error Type OR**

Select the types of errors to detect from the following. The DLM4000 triggers if any of the selected errors is detected.

CRC	When a Header CRC or Frame CRC error is detected
BSS	When a BSS error is detected (there is no BSS falling edge at the specified position)
FES	When an FES error is detected (there is no FES rising edge at the specified position)

ID/Data

The DLM4000 triggers on the AND of Indicator, ID, Cycle Count, Data1, and Data2.

- **Trigger Condition (Condition Setup)**

On the Condition Setup screen, set the Indicator, ID, Cycle Count, Data1, and Data2 trigger conditions.

Indicator

You can use the states of four indicators as trigger conditions. The Indicator trigger condition is met when the input-signal Indicator bit pattern matches the specified bit pattern.

Bit Pattern (Indicator Setup)

Select the bit patterns of the four indicators from one of the following settings.

Payload preamble	
X	Don't care.
0	There is no option header in the payload segment.
1	There is a network management vector in the payload segment (static segment).
	There is a message ID in the payload segment (dynamic segment).

4 Triggering

Null Frame	
X	Don't care.
0	There is invalid data included in the payload segment.
1	There is valid data included in the payload segment.
Sync Frame	
X	Don't care.
0	The frame is not a sync frame.
1	The frame is a sync frame.
Startup frame	
X	Don't care.
0	The frame is not a startup frame.
1	The frame is a startup frame.

ID

You can use an 11-bit ID value as a trigger condition.

Comparison Condition (Condition)

The frame ID trigger condition is met when the relationship between the reference value and the input-signal ID value matches the specified comparison condition.

$ID = a^1$	When the value is equal to the reference value
$ID \neq a^1$	When the value is not equal to the reference value
$ID \geq a^1$	When the value is greater than or equal to the reference value
$ID \leq b^1$	When the value is less than or equal to the reference value
$a \leq ID \leq b^2$	When the value is within the reference range (including the reference values)
$ID < a, b < ID^2$	When the value is outside the reference range (excluding the reference values)

- 1 Set one reference value
- 2 Set two reference values

Reference Values (a and b)

You can set the reference values within the range of 1 to 2047.

Cycle Count

You can use a 6-bit cycle-count value as a trigger condition.

Comparison Condition (Condition) and Reference Values (a and b)

The cycle-count trigger condition is met when the relationship between the reference values and the input-signal cycle-count value matches the specified comparison condition.

The comparison conditions are the same as those listed for Frame ID. You can set the reference values within the range of 0 to 63.

Data1/Data2

You can use the value of up to 8 consecutive bytes of data from Data 0 to Data 253 as a trigger condition.

Comparison Condition (Condition)

The data trigger condition is met when the relationship between the reference values and the input-signal data value matches the specified comparison condition.

True	When the value matches the data pattern
False	When the value does not match the data pattern
$Data = a^1$	When the value is equal to the reference value
$Data \neq a^1$	When the value is not equal to the reference value
$a \leq Data^1$	When the value is greater than or equal to the reference value
$Data \leq b^1$	When the value is less than or equal to the reference value
$a \leq Data \leq b^2$	When the value is within the reference range (including the reference values)
$Data < a, b < Data^2$	When the value is outside the reference range (excluding the reference values)

- 1 Set one reference value
- 2 Set two reference values

Comparison Start Position (Position)

Set the comparison start position. For example, to start from Data1 in the payload segment, set this value to 1.

Selectable range: 0 to 253 bytes

Data Length (Size)

Set how many consecutive data bytes of the payload segment will be compared.

Selectable range: 1 to 8 bytes

Data Pattern

If the comparison condition is set to True or False, set the data pattern for the specified data size in hexadecimal or binary notation.

If you specify X in the pattern, the condition is assumed to be met regardless of the corresponding bit status.

If a binary pattern contains any Xs, the corresponding hexadecimal display will be "\$."

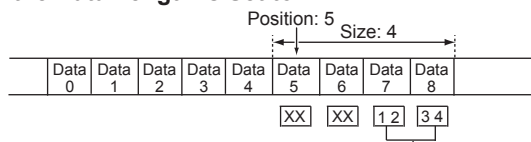
Example When the Comparison Start Position Is Set to 5 and the Data Length Is Set to 4

Example when out of the four bytes, the lower 2 bytes were set to 1234.

Reference Values (a and b)

If the comparison condition is set to Data = A, Data ≠ a, a ≤ Data, Data ≤ b, a ≤ Data ≤ b, or "Data < a or b < Data," set the reference values in decimal notation.

You must set the byte order (Endian), sign (Sign), and comparison range (MSB or LSB). The selectable ranges are as follows:

Unsigned	0 to 9E+18 The selectable maximum value is limited by the data length and bit position, which is determined by the DLC and MSB/LSB settings, respectively.
Signed	-9E+18 to 9E+18 The selectable minimum and maximum values are limited by the data length and bit position, which are determined by the DLC and MSB/LSB settings, respectively.

The value is displayed in scientific notation when the number of digits exceeds seven (example: 1234567E+10).

Byte Order (Endian)

Set the data byte order to big endian (Big) or little endian (Little).

Sign (Sign)

Set whether to use a signed (Sign) or unsigned (Unsign) data format.

The selectable range of data reference values varies depending on whether the data is signed or unsigned.

Comparison Range (MSB/LSB)

Set the MSB (MSB) or LSB (LSB) bit positions for the data that you will compare.

Selectable range: 0 to (the number of bytes of data × 8 - 1). The maximum value is 63.

▶ [See here.](#)

4 Triggering

ID OR

The DLM4000 triggers when ID or Cycle Count matches any of the patterns that you set in IDs 1 to 4. Out of IDs 1 to 4, IDs whose check boxes are selected are used as trigger conditions. The DLM4000 triggers when (1) the relationship between an ID reference value and the input-signal ID value matches the specified comparison condition and (2) the relationship between the cycle-count reference values and the input-signal cycle-count value matches the specified comparison condition.

The ID and cycle-count comparison conditions and reference values are the same as those for the ID/Data setting, except that for the cycle count, the comparison condition can be set to “Don’t care” (so that the cycle count is not used as a trigger condition).

▶ [See here.](#)

Source (Source)

Select the trigger source. After selecting the trigger source, configure the trigger level, bit rate, bus channel assignment, coupling, noise rejection, and other settings.

Trigger Level (Level)

You can set the FlexRay bus signal trigger level for each channel from CH1 to CH8.

Set the trigger level between the levels set for Idle and Data_0 so that the trigger circuit recognizes Data_1 and Idle as H and Data_0 as L.

- You can set the trigger level in 0.01 division steps to a value that fits within the 8 divisions of the screen. For example, when the voltage scale is 2 mV/division, you can set the trigger level in 0.02 mV steps.
- You can reset the trigger level to the current offset voltage by pressing RESET.

Bit Rate (Bit Rate)

Select the FlexRay bus signal’s transfer rate from one of the settings below.

2.5 Mbps, 5 Mbps, or 10 Mbps

Bus Channel Assignment (Channel)

Select whether to use channel A or B of the FlexRay bus signal.

Trigger Coupling (Coupling), HF Rejection (HF Rejection)

Noise Rejection (Noise Rejection), Level (Level)

Set these items for the trigger source.

These items are the same as those of the edge trigger.

▶ [See here.](#)

Hysteresis

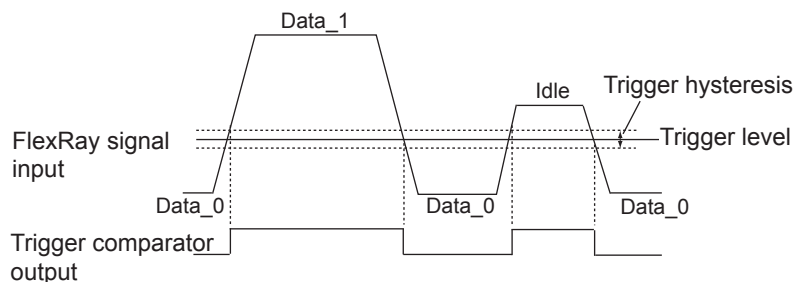

Trigger Point

The trigger occurs near the BSS falling edge immediately after all the trigger conditions are met. The only exception is that the trigger occurs near the FES rising edge when the trigger mode is set to Error, there is no CRC error in the FlexRay bus signal header, and there is only a CRC error in the frame.

Frame Start Mode

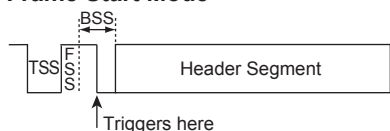

BSS: Byte Start Sequence
FES: Frame End Sequence

Error Mode

- When there is a CRC error in the header
- When there is a CRC error in the frame

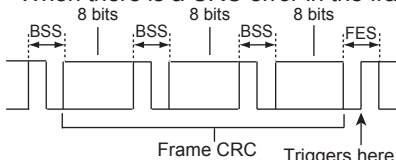
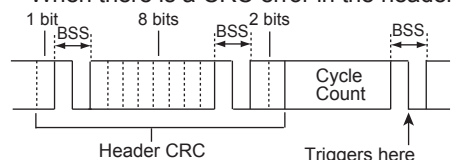

- When there is a BSS error
- When there is an FES error

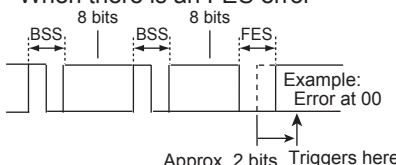
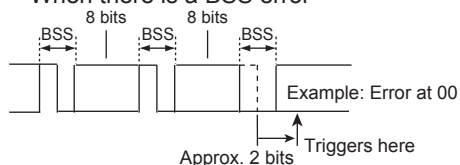

ID/Data mode

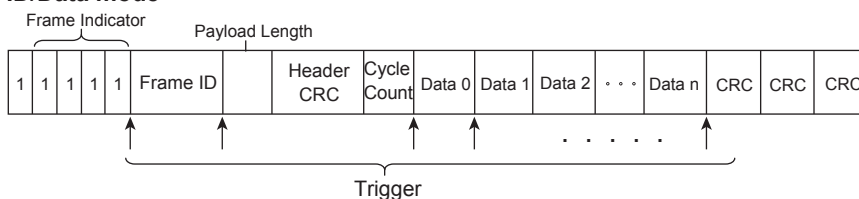

When the trigger mode is set to Error, the DLM4000 uses its internal sampling clock for sampling, so jitter equal to one period of the sampling clock arises. One period of the sampling clock is a period of time equal to 1/8 of the bit width at the specified bit rate. For example, when the bit rate is 5 Mbps, the jitter is 25 ns.

Digitalization in the Trigger Circuit

After the input signal from the FlexRay bus is digitized by the trigger comparator, the trigger circuit samples it using the internal clock. Then noise is removed by the majority filter in the Voting Window.

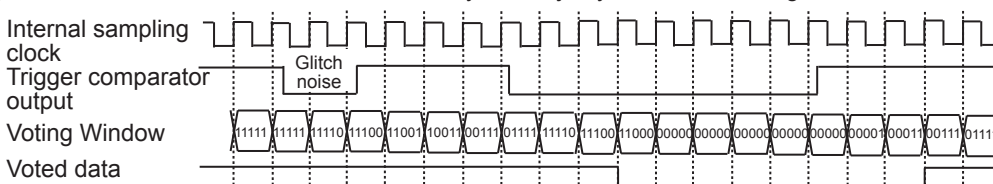

1 bit is equal to 8 sampling clock periods. The sampling counter is reset at the BSS falling edge of the voted data. The voted data value when the value of this sampling counter reaches 5 is used as the bit value for detecting the trigger conditions.

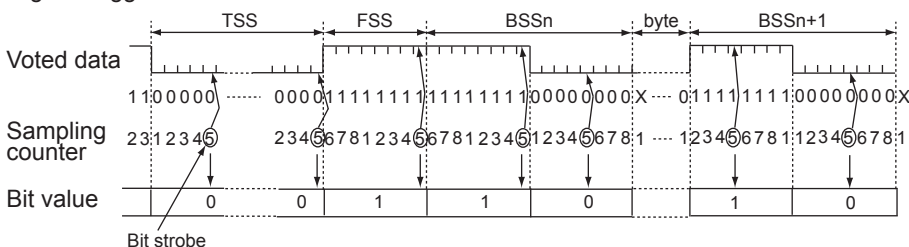

CAN Bus Trigger [ENHANCED, option]

The DLM4000 triggers based on the trigger conditions of a particular frame or type of data in a CAN bus signal.

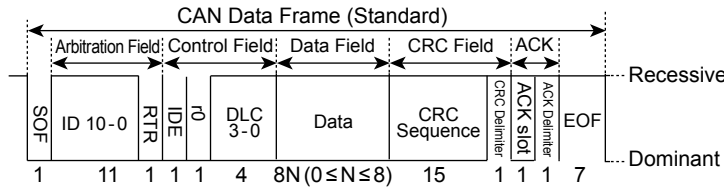

Trigger Mode (Mode)

Select the CAN bus trigger mode from one of the settings below.

SOF: Triggers on the start of a frame

Error: Triggers on errors

ID/Data: Triggers on the AND of the ID bit pattern and Data pattern

ID OR: Triggers on the OR of multiple ID bit patterns

SOF (Start of Frame)

The DLM4000 triggers on the start of CAN bus signal frames.

Error

The DLM4000 triggers on error frames (when the error flag is active) or when it detects various errors.

- **Error Type (Error Type OR)**

Select the types of errors to detect from the following. The DLM4000 triggers if any of the selected errors is detected.

Error Frame	When an active error flag (indicated by six consecutive dominant bits) is detected
Stuff	When stuff bits are not inserted properly
CRC	When a CRC error is detected

ID/Data

The DLM4000 triggers based on data frames and remote frames in the standard format (Standard) and the extended format (Extend).

The DLM4000 triggers on the AND of the SOF, ID, frame type (Remote Frame or Data Frame), Data, and ACK conditions.



- If you specify X in the ID bit pattern or data pattern, the condition is assumed to be met regardless of the corresponding bit status.
- In a bit pattern or data pattern setting, if a binary pattern contains any Xs, the corresponding hexadecimal display will be "\$."

- **Trigger Condition (Condition Setup)**

On the Condition Setup screen, set the trigger conditions such as the frame type (Remote Frame or Data Frame) and data.

Frame Format

Displays the frame format.

- Standard: Standard format
- Extend: Extended format

SOF

Triggers on the start of a CAN bus signal frame when the trigger condition is set to SOF only. SOF of ID/Data is always selected as a trigger condition.

ID**Input Format**

Select the ID input format from one of the settings below.

Bin: Select this setting to set the ID bit pattern in binary notation.

Hex: Select this setting to set the ID bit pattern in hexadecimal notation.

Message: Select this setting to set the ID or Data trigger conditions by using messages and signals that are defined in the symbol definition file (sbl).

Bit Pattern

Set the 11-bit standard format ID bit pattern or the 29-bit extended format ID bit pattern in hexadecimal or binary notation. The ID trigger condition is met when the input signal ID bit pattern matches the specified bit pattern.

Remote Frame or Data Frame

Set the trigger source frame to Remote Frame or Data Frame.

Data

You can set a trigger condition based on the data field value. Specify the DLC, Condition, and bit pattern settings. You can only set these items when you set the trigger source frame to Data Frame.

DLC (Data Length Code)

Set the data length of the data field. The DLC trigger condition is met when the specified value matches the input signal DLC value.

Selectable range: 0 to 8 bytes

Comparison Condition (Condition)

The data trigger condition is met when the relationship between the data pattern or the reference value and the input signal data field value meets the specified comparison condition.

True	When the value matches the data pattern
False	When the value does not match the data pattern
Data = a ¹	When the value is equal to the reference value
Data ≠ a ¹	When the value is not equal to the reference value
a ≤ Data ¹	When the value is greater than or equal to the reference value
Data ≤ b ¹	When the value is less than or equal to the reference value
a ≤ Data ≤ b ²	When the value is within the reference range (including the reference values)
Data < a, b < Data ²	When the value is outside the reference range (excluding the reference values)

1 Set one reference value

2 Set two reference values

Input Format

Set the data pattern input format to Bin (binary) or Hex (hexadecimal).

Data Pattern

If the comparison condition is set to True or False, set the data pattern in hexadecimal or binary notation.

The data pattern is compared to the data whose length was specified by DLC.

Reference values (a and b)

If the comparison condition is set to Data = A, Data ≠ a, a ≤ Data, Data ≤ b, a ≤ Data ≤ b, or "Data < a or b < Data," set the reference values in hexadecimal notation. You must set the byte order (Endian), sign (Sign), and comparison range (MSB or LSB). The selectable ranges are as follows:

Unsigned (Unsign)	0 to 9E+18 The selectable maximum value is limited by the data length and bit position, which is determined by the DLC and MSB/LSB settings, respectively.
Signed (Sign)	-9E+18 to 9E+18 The selectable minimum and maximum values are limited by the data length and bit position, which are determined by the DLC and MSB/LSB settings, respectively.

The value is displayed in scientific notation when the number of digits exceed seven (example: 1234567E+10).

4 Triggering



If the comparison condition is $a \leq \text{Data} \leq b$ or “Data < a or b < Data,” the two reference values are automatically adjusted so that the lower limit is less than or equal to the upper limit.

Byte Order (Endian)

Set the byte order of the data stream to Big Endian (Big) or Little Endian (Little). The following figure illustrates a 4-byte data stream on the bus. The data field value is 12345678 in hexadecimal notation.

Big endian

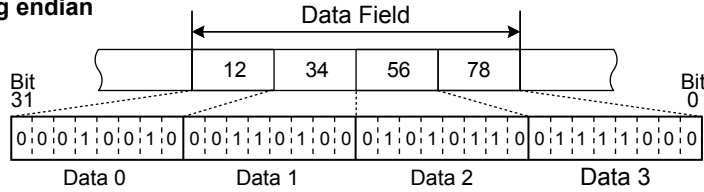

Little endian

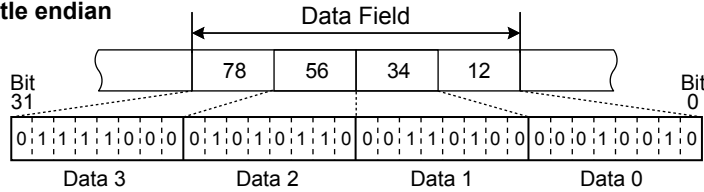

Sign (Sign)

Set whether to use a signed (Sign) or unsigned (Unsign) data format.

The selectable range of data reference values varies depending on whether the data is signed or unsigned.

Comparison Range (MSB/LSB)

Set the MSB (MSB) or LSB (LSB) bit positions for the data that you will compare. For example, if you want to compare bits 5 through 20 of a 4-byte data value, set the MSB to 20 and the LSB to 5. In this case, the bits that are compared are those that are shaded in the following figure.

Selectable range: 0 to (the number of bytes of data \times 8 - 1). The maximum value is 63.

Big endian

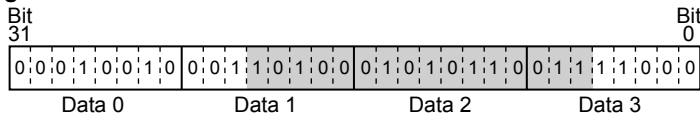

Little endian

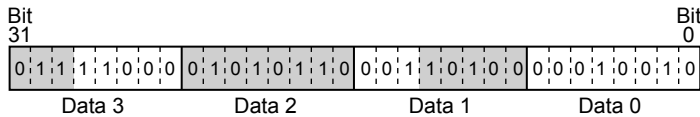

ACK Mode

You can set a trigger condition based on the ACK slot state. The ACK trigger condition is met when the specified state matches the input signal ACK slot state.

NON ACK	When the status is recessive
ACK	When the status is dominant
NON ACK or ACK	When the status is recessive or dominant

Message and Signal

The messages and symbols in the physical value/symbol definition file (.sbl) that has been loaded into the DLM4000 can be used to set the trigger condition.* Messages and signals can be used when the ID input format is set to Message.

* Physical value/symbol definition files (.sbl) are derived by converting CANdb files (.dbc).

Message

Select the ID from the Message list in the sbl file that has been loaded. The message trigger condition is met when the selected message matches the input signal ID.

Signal

Select the data from the Signal list in the sbl file that has been loaded. The signal trigger condition is met when the selected signal matches the input signal data.

Comparison Condition (Condition) and Reference Values

The signal trigger condition is met when the result of comparing the reference values to the input signal data meets the specified comparison condition.

The method of setting the comparison condition and reference values (a and b) is the same as with the ID/Data mode when the input format is set to Bin or Hex. However, you cannot set the comparison condition to True or False.



The values loaded from the sbl file are used for the Endian, Sign, MSB/LSB, and ACK items.

ID OR

The DLM4000 triggers based on data frames and remote frames in the standard format (Standard) and the extended format (Extend).

The DLM4000 triggers on the AND of the SOF, multiple IDs, frame type (Remote Frame or Data Frame), and ACK conditions.

The ID trigger condition is met when the ID matches any of the patterns that you set in IDs 1 to 4.

- **Trigger Condition (Condition Setup)**

On the Condition Setup screen, set the ID, ACK, and other trigger conditions.

Frame Format

Set the frame format. This setting applies to IDs 1 to 4.

- Standard: Standard format
- Extend: Extended format

SOF

Triggers on the start of a CAN bus signal frame when the trigger condition is set to SOF only. OF only. SOF of ID OR is always selected as a trigger condition.

ID**Input Format**

Select the ID input format from one of the settings below.

- Bin: Select this setting to set each ID bit pattern in binary notation.
- Hex: Select this setting to set each ID bit pattern in hexadecimal notation.
- Message: Select this setting to set the ID trigger conditions by using messages that are defined in the symbol definition file (sbl).

IDs 1 to 4

You can set up to four IDs. IDs whose check boxes are selected are used as trigger conditions.

The ID trigger condition is met when the input signal ID bit pattern matches any of the specified ID bit patterns. The method for setting the bit pattern of each ID is the same as with the ID/Data setting.

▶ [See here.](#)

Remote Frame or Data Frame

Set the trigger source frame to Remote Frame or Data Frame.

4 Triggering

ACK Mode

You can set a trigger condition based on the ACK slot state. The ACK trigger condition is met when the specified state matches the input signal ACK slot state.

NON ACK	When the status is recessive
ACK	When the status is dominant
NON ACK or ACK	When the status is recessive or dominant

Message

The messages and symbols in the physical value/symbol definition file (.sbl) that has been loaded into the DLM4000 can be used to set the trigger condition. Messages can be used when the ID input format is set to Message. The method for setting the message is the same as with the ID/Data setting.

▶ [See here.](#)

Source (Source)

Select the trigger source. After selecting the trigger source, configure the bit rate, recessive level, sample point, trigger level, noise rejection, and other settings.

Source (Source)

Set the trigger source to one of the settings below.

CH1 to CH8

Bit Rate (BitRate)

Select the CAN bus signal's transfer rate from one of the settings below.

33.3 kbps, 83.3 kbps, 125 kbps, 250 kbps, 500 kbps, 1 Mbps, or User Define

If you select User Define, set the transfer rate in the range of 10 kbps to 1 Mbps in 0.1-kbps steps.

Recessive Level (Recessive)

Select the recessive level from one of the settings below. In either setting, the logical value of the recessive level is 1, and the logical value of the dominant level is 0.

H	The recessive level is greater than the dominant level.
L	The recessive level is less than the dominant level.

Sample Point (Sample Point)

You can set the reference that will be used to determine the bus level (recessive or dominant) in the range of 18.8 to 90.6% in 3.1% steps.

The DLM4000 CAN bus signal trigger circuit samples the input CAN bus signal using the internal clock and detects the point of change from recessive to dominant. Set the sample point as a percentage, with the detected point of change equal to 0% and the point that is bit time after the point of change equal to 100%. The bit time is the inverse of the set bit rate.

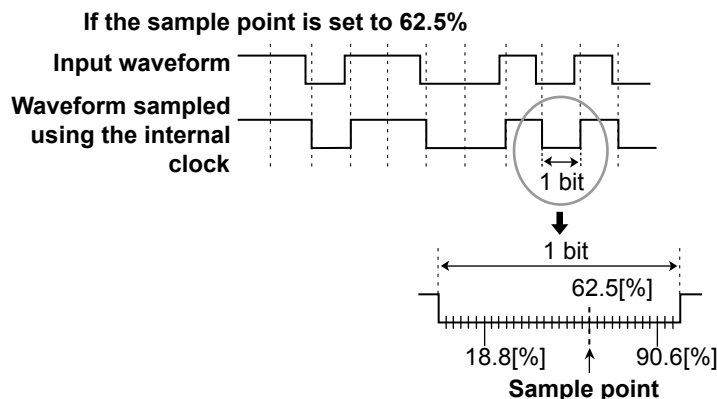

Trigger Coupling (Coupling), HF Rejection (HF Rejection)

Noise Rejection (Noise Rejection), Level (Level)

Set these items for the trigger source. These items are the same as those of the edge trigger.

▶ [See here.](#)

Frame Format and Trigger Point

The following figures illustrate the formats and trigger points of the various frames.

Data Frame (Data Frame)

• Standard format

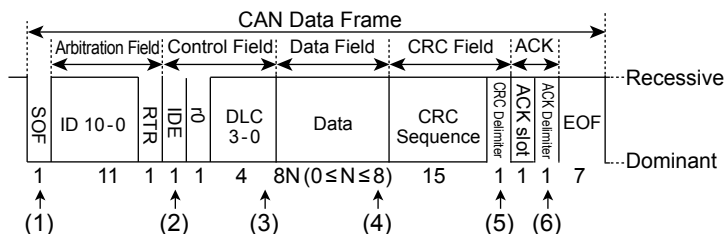

• Extended format

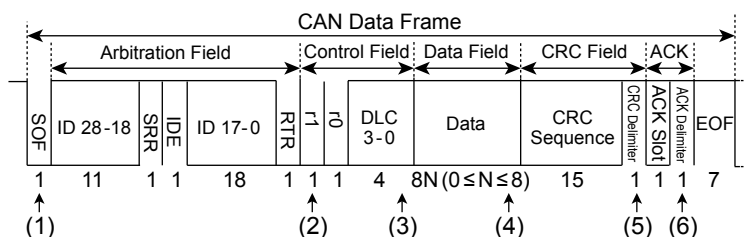

Positions (1) to (6) above are trigger points for the following conditions.

- (1) SOF
- (2) ID
- (3) Data Frame (when DLC = 0)
- (4) Data Frame (when DLC ≠ 0)
- (5) CRC Error
- (6) ACK

Remote Frame (Remote Frame)

• Standard format

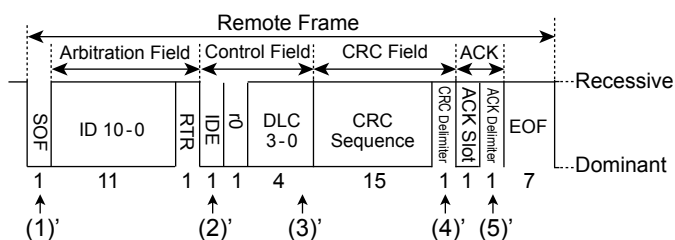

• Extended format

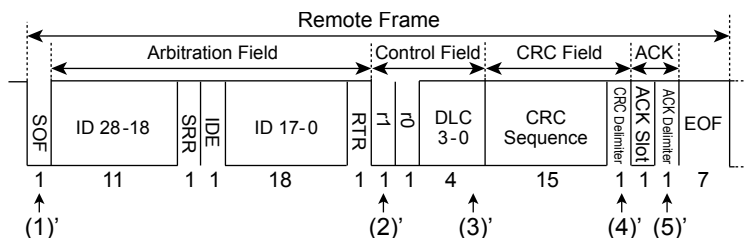

Positions (1)' to (5)' above are trigger points for the following conditions.

- (1)' SOF
- (2)' ID
- (3)' Remote Frame (when DLC = 0)
- (4)' CRC Error
- (5)' ACK

4 Triggering

Error Frame (Error Frame)

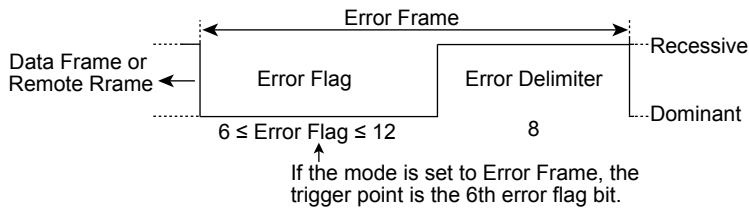

Stuff Error (Stuff Error)

The trigger point is the sample point of the bit that violates the bit stuffing rule.

CRC Error (CRC Error)

CRC errors are indicated in the data-frame and remote-frame figures.



If multiple field types and frame types are combined, the trigger point is the point where the last type appears on the time axis.

High speed CAN (ISO11898) and Low speed CAN (ISO11519-2)

The primary standards for the CAN physical layer are High-speed CAN (ISO11898) and Low-speed CAN (ISO11519-2).

As shown in the following figure, the bus level is determined by the potential difference between two buses, CAN_High and CAN_Low, in either standard.

High speed CAN (ISO11898)

Transfer rate: 1 Mbps or less

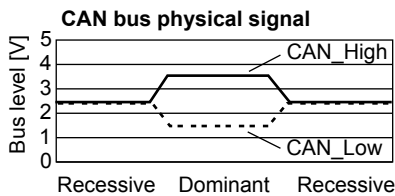
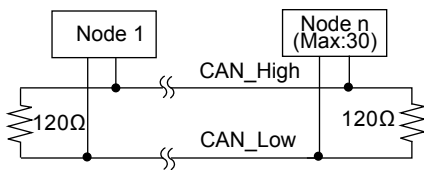

Low speed CAN (ISO11519-2)

Transfer rate: 125 kbps or less

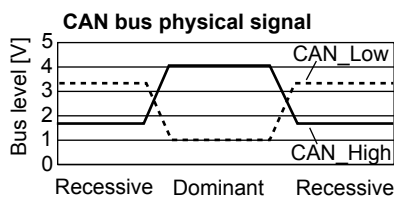
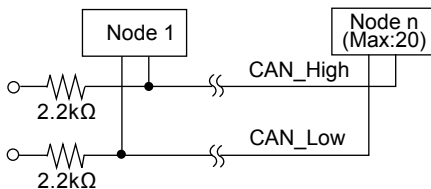

CAN FD Bus Trigger [ENHANCED, option]

The DLM4000 triggers based on the trigger conditions of a particular frame or type of data in a CAN FD bus signal (ISO 11898-1: 2015 or non-ISO).

CAN FD (ISO 11898-1: 2015)

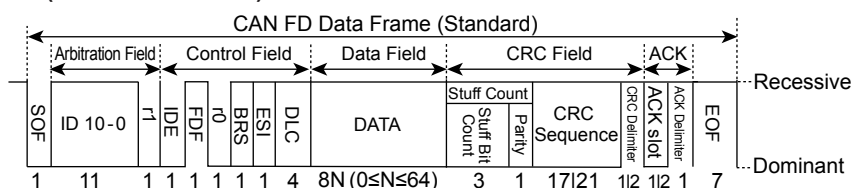

CAN FD (non-ISO)

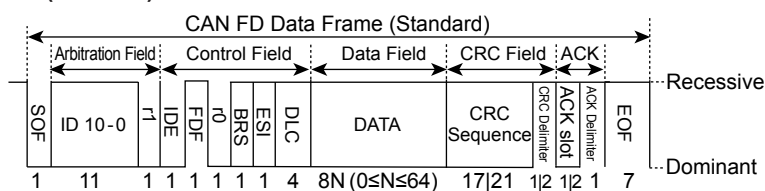

Trigger Mode (Mode)

Select the CAN FD bus trigger mode from one of the settings below.

SOF: Triggers on the start of a frame

Error: Triggers on errors

ID/Data: Triggers on the AND of the ID bit pattern and Data pattern

ID OR: Triggers on the OR of multiple ID bit patterns

FDF: Triggers on the FDF bit state

ESI (Error Passive): Triggers when the ESI bit is recessive (error passive)

SOF (Start of Frame)

The DLM4000 triggers on the start of CAN FD bus signal frames.

Error

The DLM4000 triggers on error frames (when the error flag is active) or when it detects various errors.

- **CAN FD Standard (FD Standard)**

Select the compliant standard for the CAN FD bus signal to be applied.

ISO: ISO 11898-1: Captured as a 2015-compliant CAN FD bus signal

non-ISO: ISO 11898-1: Captured as a CAN FD bus signal compliant to a standard before 2015.

- **Error Type (Error Type OR)**

Select the types of errors to detect from the following. The DLM4000 triggers if any of the selected errors is detected.

Error Frame	When an active error flag (indicated by six consecutive dominant bits) is detected
Stuff	When stuff bits are not inserted properly
Fixed Stuff	When fixed CRC stuff bits are not inserted properly
CRC	When a CRC error is detected If the aforementioned CAN FD standard is set to ISO, select the CRC error factor from one of the settings below. You can also select both. Stuff Count, CRC Sequence

4 Triggering

ID/Data

The DLM4000 triggers based on data frames and remote frames in the standard format (Standard) and the extended format (Extend).

The DLM4000 triggers on the AND of the SOF, ID, frame type (Remote Frame or Data Frame), Data, and ACK conditions.



- If you specify X in the ID bit pattern or data pattern, the condition is assumed to be met regardless of the corresponding bit status.
 - In a bit pattern or data pattern setting, if a binary pattern contains any Xs, the corresponding hexadecimal display will be “\$.”
-

- **Trigger Condition (Condition Setup)**

On the Condition Setup screen, set the trigger conditions such as the ID, frame type (Remote Frame or Data Frame) and data.

Frame Format

Select the frame format.

- Standard: Standard format
- Extend: Extended format

SOF

Triggers on the start of a CAN FD bus signal frame when the trigger condition is set to SOF only. SOF of ID/Data is always selected as a trigger condition.

ID

Input Format

Select the ID input format from one of the settings below.

- Bin: Select this setting to set the ID bit pattern in binary notation.
- Hex: Select this setting to set the ID bit pattern in hexadecimal notation.
- Message: Select this setting to set the ID or Data trigger conditions by using messages and signals that are defined in the symbol definition file (sbl).

Bit Pattern

Set the 11-bit standard format ID bit pattern or the 29-bit extended format ID bit pattern in hexadecimal or binary notation. The ID trigger condition is met when the input signal ID bit pattern matches the specified bit pattern.

Remote Frame/Data Frame

Set the trigger source frame to Remote Frame or Data Frame.

Data

You can set a trigger condition based on the data field value. Specify the size, position, condition, and data pattern settings. You can only set these items when you set the trigger source frame to Data Frame.

Comparison Size (Size)

Set the data length to be compared. The data pattern with the specified data length is compared to the input signal data pattern. If “0” is specified, the DLM4000 triggers regardless of the input signal’s data field value.

Selectable range: 0 to 8 bytes

Comparison Start Position (Position)

Set the position to start comparing the data pattern. The left end of the data field is position 0.

Selectable range: 0 to 63 bytes



- If the comparison size (Size) is set to 0, comparison start position (Position) cannot be set.
- The selectable range for position is limited so that Size + Position is less than or equal to 64.

Comparison Condition (Condition)

The data trigger condition is met when the result of comparing the data pattern or reference value to the input signal's data field meets the specified comparison condition.

True	When the value matches the data pattern
False	When the value does not match the data pattern
Data = a ¹	When the value is equal to the reference value
Data ≠ a ¹	When the value is not equal to the reference value
a ≤ Data ¹	When the value is greater than or equal to the reference value
Data ≤ b ¹	When the value is less than or equal to the reference value
a ≤ Data ≤ b ²	When the value is within the reference range (including the reference values)
Data < a, b < Data ²	When the value is outside the reference range (excluding the reference values)

- 1 Set one reference value
- 2 Set two reference values

Input Format

Set the data pattern input format to Bin (binary) or Hex (hexadecimal).

Data Pattern

If the comparison condition is set to True or False, set the data pattern for the specified data size in hexadecimal or binary notation.

Reference values (a and b)

If the comparison condition is set to Data = A, Data ≠ a, a ≤ Data, Data ≤ b, a ≤ Data ≤ b, or "Data < a or b < Data," set the reference values in decimal notation. You must set the byte order (Endian), sign (Sign), and comparison range (MSB or LSB).

The selectable ranges are as follows:

Unsigned (Unsign)	0 to 9E+18 The selectable maximum value is limited by the data length and bit position, which are determined by the Size and MSB/LSB settings, respectively.
Signed (Sign)	-9E+18 to 9E+18 The selectable minimum and maximum values are limited by the data length and bit position, which are determined by the Size and MSB/LSB settings, respectively.

The value is displayed in scientific notation when the number of digits exceed seven (example: 1234567E+10).



If the comparison condition is a ≤ Data ≤ b or "Data < a or b < Data," the two reference values are automatically adjusted so that the lower limit is less than or equal to the upper limit.

Byte Order (Endian), Sign (Sign), and Comparison Range (MSB/LSB)

These items are the same as those of the CAN bus trigger.

▶ [See here.](#)

ACK Mode

This item is the same as that of the CAN bus trigger.

▶ [See here.](#)

Message/Signal

This item is the same as that of the CAN bus trigger.

▶ [See here.](#)

4 Triggering

ID OR

This item is the same as that of the CAN bus trigger.

▶ [See here.](#)

FDF

Set the FDF bit state as a trigger condition.

0 (CAN): When the FDF bit is dominant, the DLM4000 assumes that the frame is a CAN bus signal frame and triggers.

1 (CAN FD): When the FDF bit is recessive, the DLM4000 assumes that the frame is a CAN FD bus signal frame and triggers.

ESI(Error Passive)

The DLM4000 triggers when the ESI bit is recessive (error passive).

Source (Source)

Select the trigger source. After selecting the trigger source, configure the bit rate, recessive level, sample point, trigger level, noise rejection, and other settings.

Source (Source)

Set the trigger source to one of the settings below.

CH1 to CH8

Bit Rate (Bit Rate)

Select the CAN FD bus signal's arbitration phase data transfer rate from one of the settings below.

250 kbps, 500 kbps, 1 Mbps, User Define

If you select User Define, set the transfer rate in the range of 20 kbps to 1 Mbps in 0.1-kbps steps.

Data Bit Rate (Data BitRate)

Select the CAN FD bus signal's data phase data transfer rate from one of the settings below.

500 kbps, 1 Mbps, 2 Mbps, 4 Mbps, 5 Mbps, 8 Mbps, User Define

If you select User Define, set the transfer rate in the range of 250 kbps to 10 Mbps in 0.1-kbps steps.

The data bit rate can be set as high as 16 times the arbitration phase bit rate.



If the data bit rate exceeds 16 times the bit rate, the rates are automatically adjusted according to the last set value so that the relationship "data bit rate \leq bit \times 16" is maintained.

Recessive Level (Recessive)

This item is the same as that of the CAN bus trigger.

▶ [See here.](#)

Sample Point (Sample Point)

You can set the reference that will be used to determine the bus level (recessive or dominant) in the range of 18.8 to 90.6% in 0.1% steps. The idea of sample point is the same as CAN bus signals.

▶ [See here.](#)

Trigger Coupling (Coupling) and HF Rejection (HF Rejection)

Noise rejection (Noise Rejection) and Level (Level)

Set these items for the trigger source.

These items are the same as the trigger coupling, HF rejection, noise rejection, and trigger level of edge triggers.

▶ [See here.](#)

Frame Format and Trigger Point

The following figures illustrate the formats and trigger points of the various frames.

Data Frame (Data Frame)

• Standard format

CAN FD (ISO 11898-1: 2015)

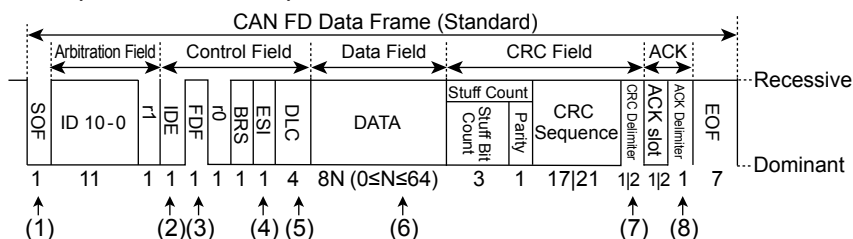

CAN FD (non-ISO)

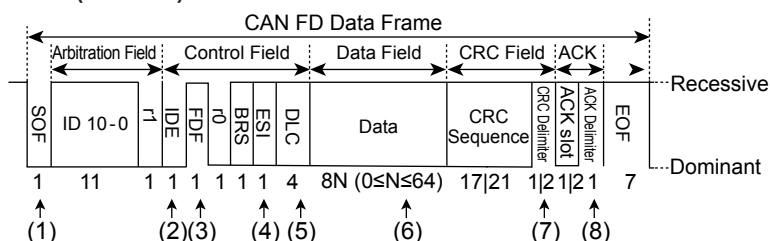

• Extended format

CAN FD (ISO 11898-1: 2015)

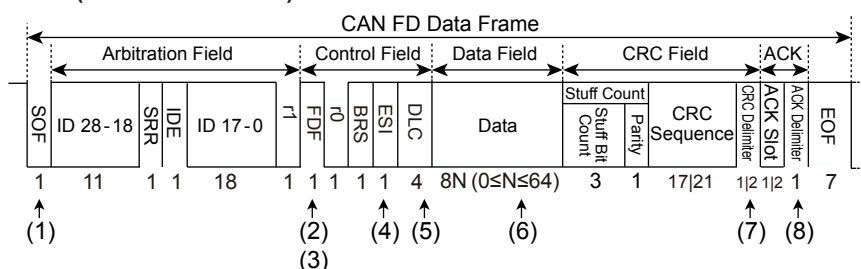

CAN FD (non-ISO)

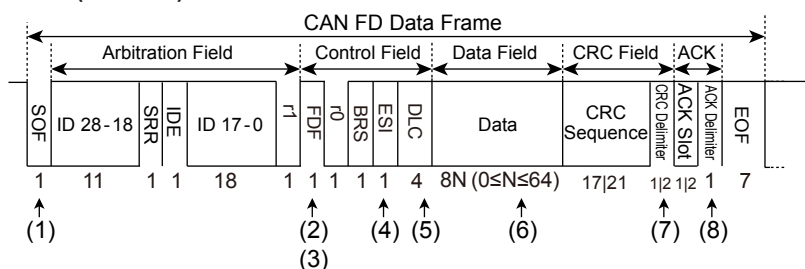

Positions (1) to (8) above are trigger points for the following conditions.

- | | |
|---------|---|
| (1) SOF | (5) Data Frame (when Size = 0) |
| (2) ID | (6) Data Frame (when Size≠0) ¹ |
| (3) FDF | (7) CRC Error ² |
| (4) ESI | (8) ACK ³ |

- Where the data patterns match.
- If the CAN FD standard (FD Standard) is set to ISO, the trigger point for both stuff count and CRC sequence errors are at the CRC Delimiter position.
- If both CRC Delimiter and ACK Slot are 2 bits long, the trigger point is the second bit of ACK Slot. The detected point when you use the search feature of the DLM4000 is the ACK Delimiter position regardless of the CRC Delimiter or ACK Slot condition.

4 Triggering

Remote Frame (Remote Frame)

This is the same as the CAN bus trigger.

▶ [See here.](#)

Error Frame (Error Frame)

This is the same as the CAN bus trigger.

▶ [See here.](#)

Stuff Error (Stuff Error, Fixed Stuff)

The trigger point is the sample point of the bit that violates the bit stuffing rule.

CRC Error (CRC Error)

CRC errors are indicated in the data-frame and remote-frame figures.



If multiple field types and frame types are combined, the trigger point is the point where the last type appears on the time axis.

LIN Bus Trigger [ENHANCED, option]

The DLM4000 triggers based on the conditions of a particular field or type of data in a LIN bus signal. The following figure shows the LIN bus signal frame format.

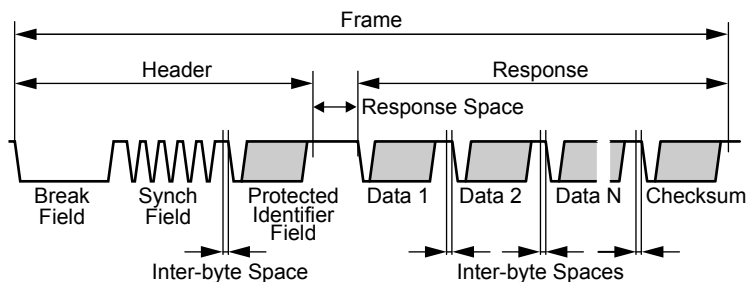

Trigger Mode (Mode)

Select the LIN bus trigger mode from one of the settings below.

Break Synch: Triggers on a break field or synch field

Error: Triggers on errors

ID/Data: Triggers on the AND of the ID bit pattern and Data pattern

ID OR: Triggers on the OR of multiple ID bit patterns

Break Synch

The DLM4000 triggers when it detects a break field and then a synch field (Break Field + Synch Field).

- **Break Length**

Select the low-pulse bit length that is used to detect breaks from one of the options below.

10 or longer, 11 or longer, 12 or longer, or 13 or longer



If the DLM4000 detects a break field and then a synch field (Break Field + Synch Field) in the middle of a LIN bus frame, it discards the frame and triggers the next time it detects a protected identifier field.

Error

The DLM4000 triggers when it detects various types of errors.

- **Error Type OR**

Select the types of errors to detect from the following. The DLM4000 triggers if any of the selected errors is detected.

Parity	The DLM4000 calculates the parity of the protected identifier field. If the result does not satisfy the following equations, the DLM4000 triggers on the protected identifier field's stop bit position. Even Parity Check : $ID0 \text{ xor } ID1 \text{ xor } ID2 \text{ xor } ID4 \text{ xor } P0 = 0$ $P0 = ID0 \text{ xor } ID1 \text{ xor } ID2 \text{ xor } ID4$ ODD Parity Check : $ID1 \text{ xor } ID3 \text{ xor } ID4 \text{ xor } ID5 \text{ xor } P1 = 1$ $P1 = \neg(ID1 \text{ xor } ID3 \text{ xor } ID4 \text{ xor } ID5)$
Synch	If the synch field is not 0x55, the DLM4000 triggers on the synch field's stop bit position.

4 Triggering

ID/Data

The DLM4000 triggers on the AND of ID and Data conditions.



- If you specify X in the ID bit pattern or data pattern, the condition is assumed to be met regardless of the corresponding bit status.
 - In a bit pattern or data pattern setting, if a binary pattern contains any Xs, the corresponding hexadecimal display will be "\$."
-

- **Trigger Condition (Condition Setup)**

On the Condition Setup screen, set the ID, data, and other trigger conditions.

Break Synch

Triggers on a synch field that comes after a break field when the trigger condition is set to Break Synch only.

ID

Input Format

Set the ID input format to Bin (binary) or Hex (hexadecimal).

Bit Pattern

Set the bit pattern for the 6-bit protection ID (ID0 to ID5) in the protected identifier field in hexadecimal or binary notation. The ID trigger condition is met when the input signal ID bit pattern matches the specified bit pattern.

Data

You can specify a value from Data 1 to Data 8 as a trigger condition.

Data Length (Size)

Set how many consecutive data bytes will be compared.

Selectable range: 1 to 8 bytes

Comparison Condition (Condition)

The data trigger condition is met when the relationship between the data pattern or the reference value and the input signal data value matches the specified comparison condition.

True	When the value matches the data pattern
False	When the value does not match the data pattern
Data = a ¹	When the value is equal to the reference value
Data ≠ a ¹	When the value is not equal to the reference value
a ≤ Data ¹	When the value is greater than or equal to the reference value
Data ≤ b ¹	When the value is less than or equal to the reference value
a ≤ Data ≤ b ²	When the value is within the reference range (including the reference values)
Data < a, b < Data ²	When the value is outside the reference range (excluding the reference values)

1 Set one reference value

2 Set two reference values

Input Format

Set the data pattern input format to Bin (binary) or Hex (hexadecimal).

Data Pattern

If the comparison condition is set to True or False, set the data pattern for the specified data size in hexadecimal or binary notation.

Reference values (a and b)

If the comparison condition is set to Data = A, Data ≠ a, $a \leq \text{Data}$, $\text{Data} \leq b$, $a \leq \text{Data} \leq b$, or “Data < a or b < Data,” set the reference values in hexadecimal notation. You must set the byte order (Endian), sign (Sign), and comparison range (MSB or LSB). The selectable ranges are as follows:

Unsigned (Unsign)	0 to 9E+18 The selectable maximum value is limited by the data length and bit position, which are determined by the Data Size and MSB/LSB settings, respectively.
Signed (Sign)	-9E+18 to 9E+18 The selectable minimum and maximum values are limited by the data length and bit position, which are determined by the Data Size and MSB/LSB settings, respectively.

The value is displayed in scientific notation when the number of digits exceed seven (example: 1234567E+10).



If the comparison condition is $a \leq \text{Data} \leq b$ or “Data < a or b < Data,” the two reference values are automatically adjusted so that the lower limit is less than or equal to the upper limit.

Byte Order (Endian)

Set the data byte order to big endian (Big) or little endian (Little).

Sign (Sign)

Set whether to use a signed (Sign) or unsigned (Unsign) data format.

The selectable range of data reference values varies depending on whether the data is signed or unsigned.

Comparison Range (MSB/LSB)

Set the MSB (MSB) or LSB (LSB) bit positions for the data that you will compare.

Selectable range: 0 to (the number of bytes of data × 8 – 1). The maximum value is 63.

▶ [See here.](#)

ID OR

The DLM4000 triggers when the ID matches any of the patterns that you set in IDs 1 to 4.

- **Trigger Condition (Condition Setup)**

On the Condition Setup screen, set the ID trigger conditions.

Break Synch

Triggers on a synch field that comes after a break field when the trigger condition is set to Break Synch only.

ID**Input Format**

Set the ID input format to Bin (binary) or Hex (hexadecimal).

IDs 1 to 4

You can set up to four IDs. IDs whose check boxes are selected are used as trigger conditions.

The ID trigger condition is met when the input signal ID bit pattern matches any of the specified ID bit patterns. The method for setting the bit pattern of each ID is the same as with the ID/Data setting.

▶ [See here.](#)

4 Triggering

Source (Source)

Select the trigger source. After selecting the trigger source, configure the bit rate, sample point, noise rejection, and other settings.

Source (Source)

Set the trigger source to one of the settings below.

CH1 to CH8

Bit Rate (BitRate)

Select the LIN bus signal's transfer rate from one of the settings below.

1200 bps, 2400 bps, 4800 bps, 9600 bps, 19200 bps, or User Define

If you select User Define, set the transfer rate in the range of 1000 bps to 20000 bps in 10-bps steps.

Sample Point (Sample Point)

You can set the reference that will be used to determine the bus level in the range of 18.8 to 90.6% in 3.1% steps.

The DLM4000 LIN bus signal trigger circuit samples the input LIN bus signal using the internal clock and detects the point of level change. Set the sample point as a percentage, with the detected point of change equal to 0% and the point that is bit time after the point of change equal to 100%. The bit time is the inverse of the set bit rate.

▶ [See here.](#)

Trigger Coupling (Coupling), HF Rejection (HF Rejection)

Noise Rejection (Noise Rejection), Level (Level)

Set these items for the trigger source.

These items are the same as those of the edge trigger.

▶ [See here.](#)

Trigger Point

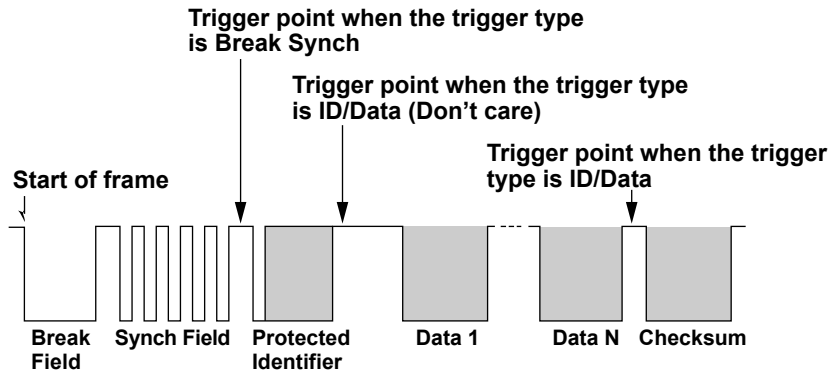

SENT Trigger [ENHANCED, option]

The DLM4000 triggers on a specific pulse or nibble (Nibble) in a SENT signal. The following figure shows the SENT signal frame format.

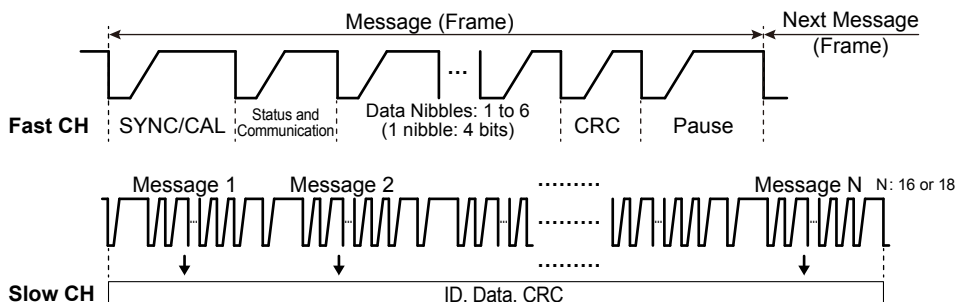

The DLM4000 SENT signal trigger circuit detects the section of the signal where the period between successive falling edges of the signal is 56 clock ticks* (including the specified clock tolerance) as SYNC/CAL. If consecutive 56-clock-tick signals occur, the last signal is detected as SYNC/CAL. The previous signals are handled as pause pulses or errors.

* In SENT signals, the reference clock period is expressed in *clock ticks*. The time between consecutive falling edges of the signal is counted using this period in order to detect SYNC/CAL and calculate nibble values.

Trigger Mode (Mode)

Select the SENT trigger mode from one of the settings below.

Every Fast CH: Triggers when a fast channel message is detected

Fast CH S&C: Triggers on the status and communication bit pattern

Fast CH Data: Triggers on the AND of the fast channel data

Every Slow CH: Triggers when a slow channel message is detected

Slow CH ID/Data: Triggers on the AND of the slow channel ID and data

Error: Triggers on errors

Every Fast CH

The DLM4000 triggers when it detects a fast channel message.

Fast CH S&C

The DLM4000 triggers on the fast channel status and communication bit pattern.



- If you specify X in the bit pattern or data pattern, the condition is assumed to be met regardless of the corresponding bit status.
- In a bit pattern or data pattern setting, if a binary pattern contains any Xs, the corresponding hexadecimal display will be "\$."

- **Trigger Condition (Condition Setup)**

Set the status and communication trigger conditions.

Input Format

Set the status and communication input format to Bin (binary) or Hex (hexadecimal).

4 Triggering

Bit Pattern

Set the 4-bit status and communication bit pattern in hexadecimal or binary notation. The trigger condition is met when the input signal status and communication bit pattern match the specified bit pattern.

Fast CH Data

The DLM4000 triggers on the AND of fast channel Data conditions.

- **Data Type (Data Type)**

Select the fast channel data type from one of the settings below.

Nibble: Set a 4 to 24 bit data pattern in unit of nibbles (4 bits).

User: Set the data sizes of Data1 to Data4 in the range of 0 to 24 bits.

- Select whether to use Data1 to Data4 as comparison conditions.
- The total number of bits for Data1 to Data4 is up to 24. If you try to exceed the total number of bits, the data size of other pieces of Data is reduced.
- Set the nibble order (Order) to Big or Little.
- When version is APR 2016 and Multiplexing is on, the data size of Data 1 is fixed to 4 bits to correspond to FC.

- **Trigger Condition (Condition Setup)**

Set the fast channel data trigger conditions.

When the data type is nibble

Comparison Condition (Condition)

The data trigger condition is met when the result of comparing the data pattern to the input signal's data value meets the specified comparison condition.

True	When the value matches the data pattern
False	When the value does not match the data pattern

Input Format

Set the data pattern input format to Bin (binary) or Hex (hexadecimal).

Data Pattern

Set the data pattern for the data nibble in hexadecimal or binary notation.

When the data type is User

Comparison Condition (Condition)

The data trigger condition is met when the result of comparing the user-specified Data1 to Data4 values to the input signal's data value meets the specified comparison condition. Only the data pieces that were selected to be comparison conditions can be specified.

Data = a ¹	When the value is equal to the reference value
Data ≠ a ¹	When the value is not equal to the reference value
a ≤ Data ¹	When the value is greater than or equal to the reference value
Data ≤ b ¹	When the value is less than or equal to the reference value
a ≤ Data ≤ b ²	When the value is within the reference range (including the reference values)
Data < a, b < Data ²	When the value is outside the reference range (excluding the reference values)

1 Set one reference value

2 Set two reference values

Reference Values (a and b)

Set the reference values in decimal notation.

Selectable range: 0 to 2N-1

N: Data size (bits) assigned in User settings



If the comparison condition is $a \leq \text{Data} \leq b$ or "Data < a or b < Data," the two reference values are automatically adjusted so that the lower limit is less than or equal to the upper limit.

Every Slow CH

The DLM4000 triggers when it detects a slow channel message. To trigger using Every Slow CH, select the slow channel message type from one of the settings below. This is selectable when the format version (explained later) is APR2016 or JAN2010.

- Short: Short message
- Enhanced: Enhanced message

Slow CH ID/Data

The DLM4000 triggers on the AND of the slow channel ID and Data conditions.

- **Slow CH Type (Slow CH Type)**

This item is the same as that of “Every Slow CH” explained earlier.

▶ [See here.](#)

- **Trigger Condition (Condition Setup)**

Set the slow channel id/data trigger conditions.

When the message type is Short**Input Format**

Set the ID and data pattern input format to Hex (hexadecimal) or Dec (decimal).

Comparison Condition (Condition)

The data trigger condition is met when the result of comparing the ID and data reference values to the input signal's ID and data values meets the specified comparison condition.

- Select whether to compare the ID or data. If you select both, the DLM4000 triggers on the AND condition.
- Set the comparison conditions for ID and data.

	True ¹	When the value matches the specified data pattern
Data	False ¹	When the value does not match the specified data pattern
ID = a ²		When the value is equal to the reference value
Data = a ²		When the value is equal to the reference value
ID ≠ a ²		When the value is not equal to the reference value
Data ≠ a ²		When the value is not equal to the reference value
a ≤ ID ²		When the value is greater than or equal to the reference value
a ≤ Data ²		When the value is greater than or equal to the reference value
ID ≤ b ²		When the value is less than or equal to the reference value
Data ≤ b ²		When the value is less than or equal to the reference value
a ≤ ID ≤ b ³		When the value is within the reference range (including the reference values)
a ≤ Data ≤ b ³		When the value is within the reference range (including the reference values)
ID < a, b < ID ³		When the value is outside the reference range (excluding the reference values)
Data < a, b < Data ³		When the value is outside the reference range (excluding the reference values)

1 Set the input format to Bin (binary) or Hex (hexadecimal), and set the data pattern. If the slow channel type is Short, set an 8 bit data pattern. If slow channel type is Enhanced and the ID and Data message format (explained later) ([Configuration bit](#)) is “12bit data, 8bit ID,” set a 12 bit data pattern. If the slow channel type Enhanced and the ID and Data message format is “16bit data, 4bit ID,” set a 16 bit data pattern.

2 Set one reference value

3 Set two reference values

Reference Values (a and b)

Set the reference values in Hex (hexadecimal) or Dec (decimal) according to the input format setting. The selectable ranges are as follows:

ID		Data	
Hex	Dec	Hex	Dec
0 to F	0 to 15	00 to FF	0 to 255



If the comparison condition is $a \leq ID \leq b$, $a \leq Data \leq b$, “ID < a or b < ID,” or “Data < a or b < Data,” the two reference values are automatically adjusted so that the lower limit is less than or equal to the upper limit.

4 Triggering

When the message type is Enhanced

Configuration bit

Select the ID and data input format from one of the settings below.

- 12bit data, 8bit ID: When the data field is 12 bits and the message ID is 8 bits
- 16bit data, 4bit ID: When the data field is 16 bits and the message ID is 4 bits

Input Format, Comparison Condition (Condition)

These are the same functions as when the message type is Short. ► [See here.](#)

Reference Values (a and b)

Set the reference values in Hex (hexadecimal) or Dec (decimal) according to the input format setting. The selectable ranges are as follows:

Message Format	ID		Data	
	Hex	Dec	Hex	Dec
12bit data, 8bit ID	00 to FF	0 to 255	000 to FFF	0 to 4095
16bit data, 4bit ID	0 to F	0 to 15	0000 to FFFF	0 to 65535

Error

The DLM4000 triggers when it detects various types of errors.

- **Error Type (Error Type OR)**

Select the types of errors to detect from the following. The DLM4000 triggers if any of the selected errors is detected.

Successive CAL Pulses	The DLM4000 triggers when successive SYNC/CAL pulses differ by 1/64 clock ticks or more. The comparison condition varies depending on the format setting (explained later).
Nibble Number	The DLM4000 triggers when the number of nibbles in the message does not match the specified number of nibbles.. The specified number of nibbles varies depending on the number of data nibbles and the presence or absence of a pause pulse.
Nibble Data Value	The DLM4000 triggers when any of the clock tick states of status and communication, Data, and CRC is outside the 12 to 27 clock tick range.
Fast CH CRC	The DLM4000 triggers when it detects a fast channel CRC error.
Status and Communication	The DLM4000 triggers when the status and communication bit 0 or bit 1 is 1. Specify the bit to detect in the format settings (explained later).
Slow CH CRC	The DLM4000 triggers when it detects a slow channel CRC error.

- **Slow CH Type (Slow CH Type)**

This item is the same as that of "Every Slow CH" explained earlier.

► [See here.](#)

Format (Format)

Set the version and signal properties of the SENT signal.

Version

Set the version of the SENT signal.

APR2016: SENT signal complying with the version released in April 2016

JAN2010: SENT signal complying with the version released in January 2010

FEB2008 and older: SENT signal complying with the version released in February 2008 and earlier

Clock Tick

Set the reference clock period of SENT signals. The time between consecutive falling edges of the signal is counted using this period.

Selectable range: 1.00 μ s to 100.00 μ s

Resolution: 0.01 μ s

Clock Tolerance

Set the clock tick tolerance.

Selectable range: \pm 1.0% to \pm 30.0%

Resolution: 0.1%

Data Nibbles

Set the number of data nibbles of fast channel messages.

Selectable range: 1 to 6

Pause Pulse

Select whether to include pause pulses in fast channel messages. Select this for version APR2016 and JAN2010. This is fixed to off for version FEB2008 and older.

ON: Pause pulses are included.

OFF: Pause pulses are not included.

CRC Type

Select the CRC method. Select this for version APR2016 and JAN2010. This is fixed to Legacy for version FEB2008 and older.

Recommended: CRC is added using the method recommended in version APR2016 and JAN2010.

Legacy: CRC is added using the method recommended in version FEB2008 and older.

Customize Error Factor

Select the method of detecting [error types](#) Successive CAL Pulses and Status and Communication.

- **Successive Calibration Pulses**

Select the method of detecting error type Successive CAL Pulses.

OFF: Errors are not detected.

Preferred Option: The calibration pulse of current frame is compared to the calibration pulse of the preceding frame to detect errors.

Option 2: The calibration pulse of current frame is compared to the calibration pulse of the last valid preceding frame to detect errors. However, if three consecutive errors are detected, the third calibration pulse is considered as valid.

- **Status and Communication**

Select the method of detecting error type Status and Communication. Select bit 0 or bit 1 or both. If you select both, errors are detected on the OR condition.

Bit 0: Bit 0 becoming 1 is detected as an error.

Bit 1: Bit 1 becoming 1 is detected as an error.

4 Triggering

Source (Source)

Source (Source)

Set the trigger source to one of the settings below. If you select LOGIC, select the [source bit](#).

CH1 to CH8/LOGIC(L), LOGIC(A|B)

* CH8 or LOGIC(L), whichever the corresponding key is illuminated (CH8 or L), can be selected. LOGIC(A|B) is available on models with the /L16 option.

Trigger Coupling (Coupling) and HF Rejection (HF Rejection)

Noise rejection (Noise Rejection) and Level (Level)

Set these items for the trigger source.

These items are the same as the trigger coupling, HF rejection, noise rejection, and trigger level of edge triggers.

► [See here.](#)

Trigger Point

The following figures illustrate the trigger points. For other trigger points, see appendix 6.

► [See here.](#)

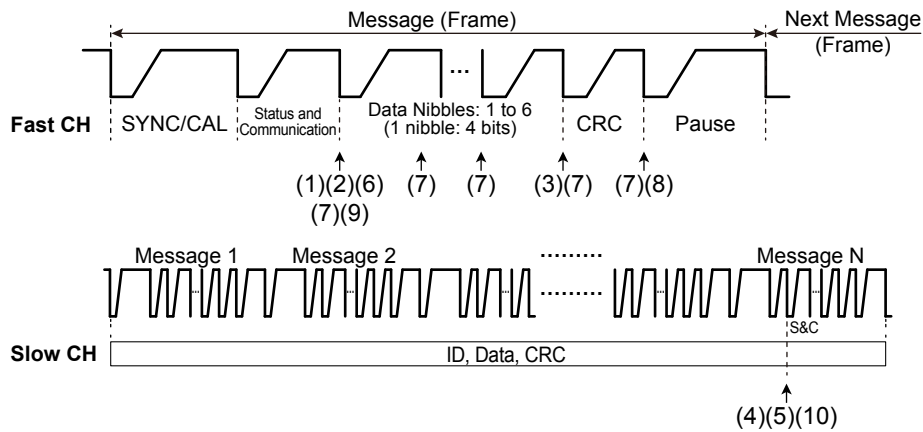

Positions (1) to (10) above are trigger points for the following conditions.

- (1) Every Fast CH
- (2) Fast CH S&C
- (3) Fast CH Data
- (4) Every Slow CH
- (5) Slow CH ID/Data
- (6) Successive CAL Pulses Error, detection method Option 2
- (7) Nibble Data Value Error
- (8) Fast CH CRC Error
- (9) Status and Communication Error
- (10) Slow CH CRC Error

PSI5 Airbag Trigger [ENHANCED, option]

The DLM4000 triggers using the sync pulse, start bit, and data pattern of PSI5 Airbag signals as trigger conditions. The following figure shows the PSI5 Airbag signal frame format.

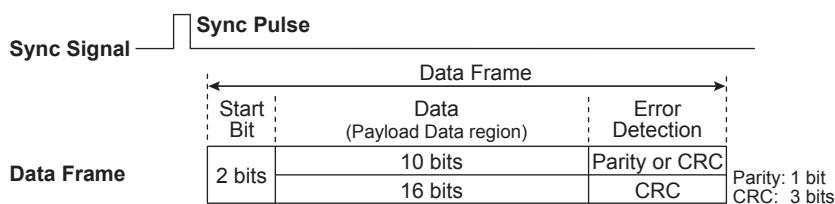

- * When the data length of Data is 10 bits, set the error detection method (Error Detection) to Parity or CRC.

Trigger Mode (Mode)

Set the PSI5 Airbag trigger mode to one of the settings below.

Sync: Triggers on sync pulses

Start Bit: Triggers on the start bit of data frames

Data: Triggers on a data pattern or a Data value

Sync

The DLM4000 triggers on the rising edge of sync pulses.

Start Bit

The DLM4000 triggers on start bits.

Data

The DLM4000 triggers on a data pattern or a Data value.

• Trigger Condition (Condition Setup)

Comparison Condition (Condition)

The data trigger condition is met when the result of comparing the specified data pattern or reference value to the input signal's Data value meets the specified comparison condition.

True	When the value matches the data pattern
Data = a	When the value is equal to the reference value

Input format

- When the comparison condition is True, set the data pattern input format to Bin (binary) or Hex (hexadecimal).
- When the comparison condition is Data = a, set the reference value input format to Hex (hexadecimal) or Dec (decimal).

Data Pattern

When the comparison condition is True, set the data pattern in hexadecimal or binary according to the input format setting. The data length of the data pattern is set using [Data Bits](#) explained later.



- If you specify X in the data pattern, the condition is assumed to be met regardless of the corresponding bit status.
- In a data pattern setting, if a binary pattern contains any Xs, the corresponding hexadecimal display will be "\$."

4 Triggering

Reference value (a)

When the comparison condition is Data = a, set the data pattern in Hex (hexadecimal) or Dec (decimal) according to the input format setting. The data length of the reference value is set using [Data Bits](#) explained later. The selectable ranges are as follows:

10 bit data		16 bit data	
Hex	Dec	Hex	Dec
200 to 1FF	-512 to 511	8000 to 7FFF	-32768 to 32767

Sync Signal (Sync)

Source (Source)

Set the sync signal source to one of the settings below.

CH1 to CH8, X

* If you select X, sync signal will not be detected. Therefore, Trigger mode Sync will not be available.

Data Frame (Data)

Source (Source)

Set the data frame source (data source) to one of the following settings below.

CH1 to CH8

Bit Rate (Bit Rate)

Set the data transfer rate of the data frame source to one of the following settings below.

125kbps, 189kbps, User Define

If you select User Define, set the transfer rate in the range of 10.0 kbps to 1000.0 kbps in 0.1-kbps steps.

Data Length (Data Bits)

Set the length of data area of the data frame (Payload Data Region) to one of the following settings below.

10bit, 16bit

The selectable range for [data patterns](#) and [reference value \(a\)](#) of the aforementioned trigger conditions varies depending on the data length setting.

Error Detection Method (ErrorDetection)

If the data frame's data length is 10 bits, set the error detection method to one of the following settings below.

When the data length is 16 bit, this is fixed to CRC.

Parity, CRC

Trigger Coupling (Coupling) and HF Rejection (HF Rejection)

Noise rejection (Noise Rejection) and Level (Level)

Set these for the sync signal and data source.

These items are the same as the trigger coupling, HF rejection, noise rejection, and trigger level of edge triggers.

▶ [See here.](#)

Trigger Point

The following figure shows the trigger point depending on the trigger mode (Mode).

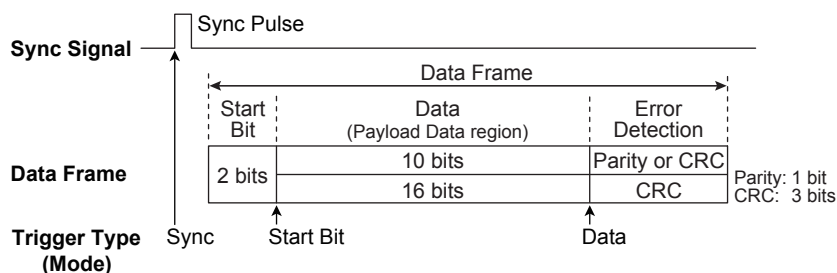

UART Trigger [ENHANCED, option]

The DLM4000 triggers on a UART signal. The following figure shows the UART signal data format for positive logic.

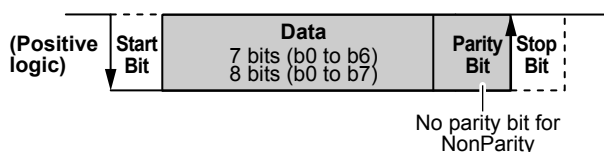

Trigger Mode (Mode)

Select the UART trigger mode from one of the settings below.

Every Data: Triggers on the data stop bit

Data: Triggers on a data pattern

Error: Triggers on errors

Every Data

The DLM4000 triggers on the stop bit positions of all data frames.

Data

The DLM4000 triggers on a specified data pattern.

- **Trigger Condition (Condition Setup)**

- **Data Length (Size)**

- Set how many consecutive data bytes will be compared.

- Selectable range: 1 to 4 bytes

- **Comparison Condition (Condition)**

- The DLM4000 triggers when the input signal data value matches the data pattern.

- **Data Pattern and Input Format (Input Format)**

- For the data whose length was specified by Data Size, set the data pattern using binary, hexadecimal, or ASCII character codes.

- If you use ASCII,

- Select whether uppercase and lowercase are considered when, as a trigger condition, the input signal data value is compared to the data pattern.
 - Set the data pattern with the keyboard that appears on the screen.
 - The special characters CR, LF, SP, and NUL are shown in single quotation marks. These special characters are counted as one character including the single quotation marks.
 - The case of the entered alphabet letters is retained even if the input format is changed to Bin or Hex. It is also retained when the format is changed from Bin or Hex to ASCII.
 - If a character code that does not exist on the keyboard is entered when the input format is Bin or Hex and then the input format is changed to ASCII, a white square is displayed in the corresponding position.



When using binary or hexadecimal, if you set Xs in the data pattern, the corresponding bits will be considered satisfying the condition. When a binary pattern contains any Xs, the corresponding hexadecimal will be displayed as "\$."

Error

The DLM4000 triggers when it detects various types of errors.

- **Error Type, Error Type OR**

- Select the types of errors to detect from the following. The DLM4000 triggers if any of the selected errors is detected.

Framing	The DLM4000 triggers when the logical stop bit value is zero.
Parity	When the DLM4000 detects a parity error in a received character, the DLM4000 triggers on the stop bit position. <ul style="list-style-type: none"> • You can select which parity to check, odd or even. • Errors will not occur if the parity bit is set to none.

4 Triggering

Source (Source)

Source (Source)

Set the trigger source to one of the settings below. If you set the trigger source to LOGIC, set the [source bit](#). CH1 to CH8/LOGIC(L) or LOGIC(A|B)

- * You can select CH8 or LOGIC(L), depending on which channel's corresponding key (CH8 or L) is illuminated. LOGIC(A|B) is available on models with the /L16 option.

Bit Rate (BitRate)

Select the UART signal's transfer rate from one of the settings below.

1200 bps, 2400 bps, 4800 bps, 9600 bps, 19200 bps, 38400 bps, 57600 bps, 115200 bps, or User Define
If you select User Define, set the transfer rate in the range of 1000 bps to 10000000 bps in 100-bps steps.

Bit Order (Bit Order)



Set the bit order that is appropriate for the data stream.

When setting the data pattern, set the pattern MSB first regardless of the bit order setting.

MSB	When the data stream starts with the MSB
LSB	When the data stream starts with the LSB

Polarity (Polarity)

Select which bit state will be considered logical 1.

	Positive logic
	Negative logic

Sample Point (Sample Point)

You can set the reference that will be used to determine the signal level in the range of 18.8 to 90.6% in 3.1% steps.

The DLM4000 UART signal trigger circuit samples the input UART signal using the internal clock and detects the point of level change. Set the sample point as a percentage, with the detected point of change equal to 0% and the point that is bit time after the point of change equal to 100%. The bit time is the inverse of the set bit rate.

▶ [See here](#).

Trigger Coupling (Coupling), HF Rejection (HF Rejection)

Noise Rejection (Noise Rejection), Level (Level)

Set these items for the trigger source.

These items are the same as those of the edge trigger.

▶ [See here](#).

Format (Format)

You can select the data format from one of the settings below.

8bit Parity	8-bit data + parity bit
7bit Parity	7-bit data + parity bit
8bit NonParity	8-bit data (no parity bit)

Trigger Point

For all formats, in all modes, the trigger point is the stop bit after the trigger condition is met. If multiple data frames are specified, the trigger point is the stop bit of the last data byte.

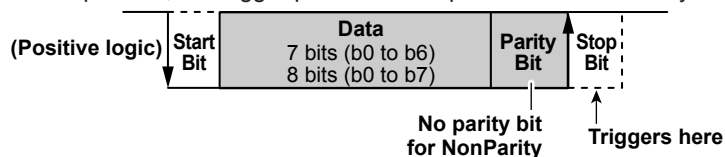

I²C Bus Trigger [ENHANCED, option]

The DLM4000 triggers based on the I²C bus signal's start condition or the address pattern or data pattern trigger conditions. The following figure shows the I²C bus signal data format.

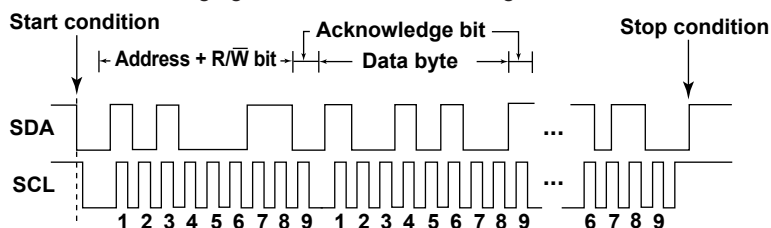

Serial Clock (SCL), Serial Data (SDA)

Source (Source)

Set the SCL and SDA source from one of the settings below. If you select LOGIC, select the [source bit](#).

Serial clock (SCL)	Serial data (SDA)
For CH1 to CH4	CH1 to CH4
For CH5 to CH8/LOGIC(L)	CH5 to CH8/LOGIC(L)
For LOGIC(A B)	LOGIC(A B)

* CH8 or LOGIC(L), whichever the corresponding key is illuminated (CH8 or L), can be selected.
LOGIC(A|B) is available on models with the /L16 option.

Trigger Coupling (Coupling), HF Rejection (HF Rejection)

Noise Rejection (Noise Rejection), Level (Level)

Set these items for the SDA and SCL sources.

These items are the same as those of the edge trigger.

▶ [See here](#).

Trigger Mode (Mode)

Select the I²C bus trigger mode from one of the settings below.

[Every Start](#): Triggers on start or restart condition

[Adr DATA](#): Triggers on the AND of address pattern and data pattern conditions

[NON ACK](#): Triggers when the acknowledge bit is Nack (SDA is H)

[General Call](#): Triggers on general call addresses

[Start Byte](#): Triggers on the start byte master code

[HS Mode](#): Triggers on the HS Mode master code

Every Start

When a start condition is detected, the DLM4000 triggers on the SDA signal's falling edge.

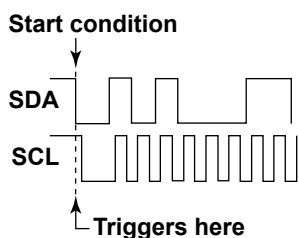

4 Triggering

Adr Data

When the address and data patterns match, the DLM4000 triggers on the falling edge of the 9th SCL signal clock.

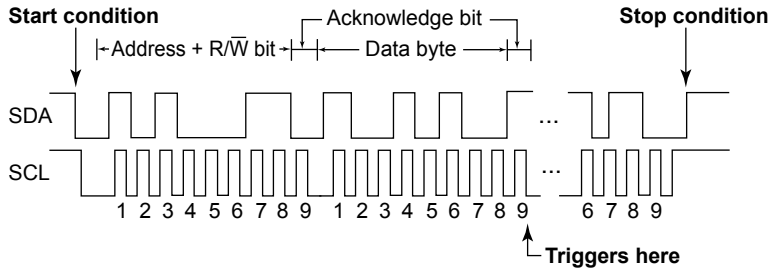

If you specify X in the address or data pattern, the condition is assumed to be met regardless of the corresponding bit status.

In a address pattern or data pattern setting, if a binary pattern contains any Xs, the corresponding hexadecimal display will be "\$."

- **Trigger Condition (Condition Setup)**

On the Condition Setup screen, set the trigger conditions. The DLM4000 triggers based on the Start (start condition), Address (address pattern), and Data (data pattern) items whose check box is selected.

Start (Start Condition)

If the only trigger condition is the start condition, when a start condition is detected, the DLM4000 triggers on the SDA signal's falling edge.

Address

Type

Set the address type to 7bit Address, 7bit + Sub Address, or 10bit Address.

Address Pattern and Input Format (Input Format)

Set the address pattern input format to hexadecimal to binary notation. The address trigger condition is met when the specified address pattern matches the input signal address pattern.

If you set the input format to hexadecimal, the trigger condition is affected by whether the R/W bit is on or off.

7-bit Address Example

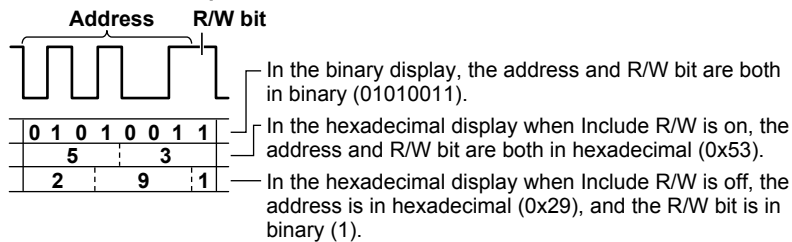

Data

You can use a data pattern as a trigger condition.

Data Length (Size)

Set how many consecutive data bytes will be compared.

Selectable range: 1 to 4 bytes

Comparison Start Position (Position)

Set the comparison start position. The DLM4000 skips the specified number of bytes and starts comparing from the next data byte. If you do not set the comparison start point, the data trigger condition is met when the input signal data pattern first matches the specified data pattern.

Selectable range: 0 to 9999 bytes

Comparison Condition (Condition)

The data trigger condition is met when the relationship between the specified pattern and the input signal pattern meets the specified comparison condition.

True	When the patterns match
False	When the patterns do not match

Data Pattern

Set the data pattern for the specified data size in hexadecimal or binary notation.

- **R/W Bit Inclusion (Include R/W)**

When you set the address pattern input format to hexadecimal, you can choose to include or omit the R/W bit when you set the address pattern.

- ON: Include the R/W bit. (The address and the R/W bit are displayed in hexadecimal.)
- OFF: Omit the R/W bit. (The address is displayed in hexadecimal and the R/W bit is displayed in binary.)



You can set R/W bit inclusion (Include R/W) under the conditions listed below. The setting is universal.

- When the I²C bus trigger type is set to Adr Data.
- When the I²C bus trigger type is set to General Call and the second byte address pattern is set to Master Adr.
- When the I²C bus signal is being analyzed or searched.

Example (Adr Data)

This example displays the data sequence at the byte level (hexadecimal notation) and indicates the trigger position. The following notations are used in the figure.

S: Start condition, P: Stop condition, Shading: Compared pattern

- **Trigger only on the address pattern**

Mode	Adr DATA
Address	7bit address, A4
Data	Don't care

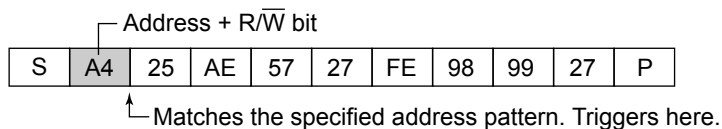

- **Trigger only on the data pattern**

Mode	Adr DATA
Address	Don't care
Data	Condition: True, Size: 2 bytes, Data pattern: 27 and AE

<When the position is not specified>

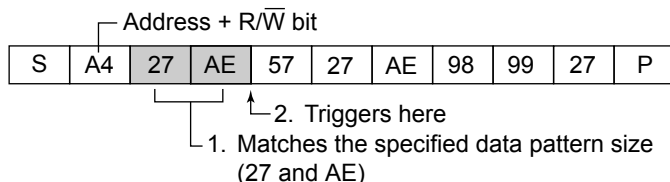

<When the position is set to 3>

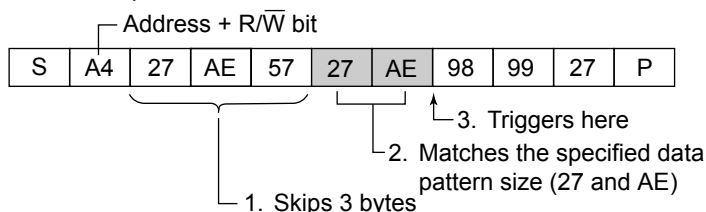

4 Triggering

NON ACK

The DLM4000 triggers when the acknowledge bit is Nack (when the SDA signal is high).

You can select whether to use (OFF) or ignore (ON) the acknowledge bits that belong to the start byte (Start Byte), HS mode master code (HS Mode), and read access byte (Read Access).

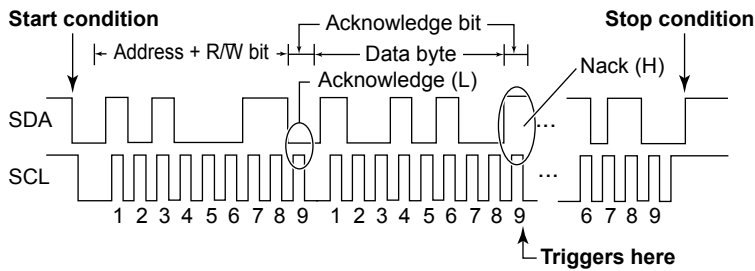

General Call

The DLM4000 triggers on the general call address (0000 0000).

• Second Byte

You can use the second byte address pattern (the byte after the general call address) as a trigger condition.

The second byte trigger condition is met when the input signal pattern matches the specified pattern. You can select the second byte address pattern from one of the settings below.

X	Not used as a trigger condition
0000 0100	When the input signal pattern matches the pattern 0000 0100 (0x04)
0000 0110	When the input signal pattern matches the pattern 0000 0110 (0x06)
Master Adr	When the input signal pattern matches the specified pattern If you select Master Adr, you can use the address or data pattern as a trigger condition.

• Trigger Condition (Condition Setup)

When the second byte is set to Master Adr, set the Adr Data mode trigger condition.

▶ [See here.](#)

• R/W Bit Inclusion (Include R/W)

When you set the second byte to Master Adr and the address pattern input format to hexadecimal, you can choose to include or omit the R/W bit when you set the address pattern.

▶ [See here.](#)

Example (General Call)

This example displays the data sequence at the byte level (hexadecimal notation) and indicates the trigger position. The following notations are used in the figure.

S: Start condition, P: Stop condition, Shading: Compared pattern

• Trigger only on the general call address

Mode	General Call
Second Byte	X

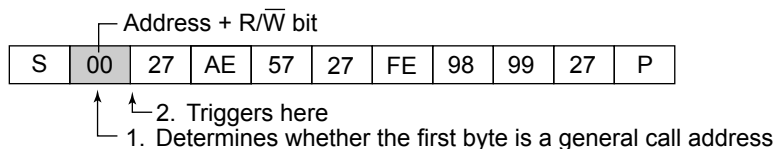

• Trigger on a pattern whose second byte address is 06

Mode	General Call
Second Byte	0000 0110

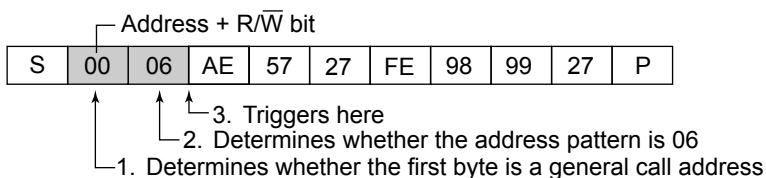

• Trigger when the second byte address matches the specified pattern

Mode	General Call
Second Byte	Master Adr, Address pattern: 1010 1011 (0xAB)
Data	Condition: True, Size: 2 bytes, Data pattern: 27 and AE

<When the position is not specified>

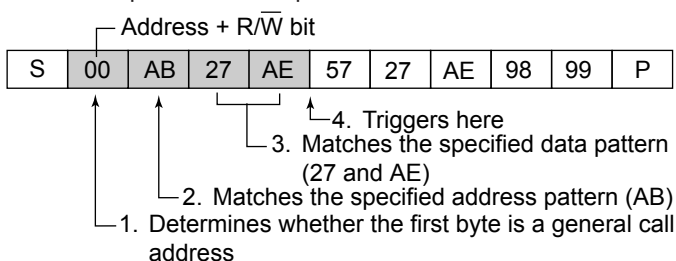

<When the position is set to 3>

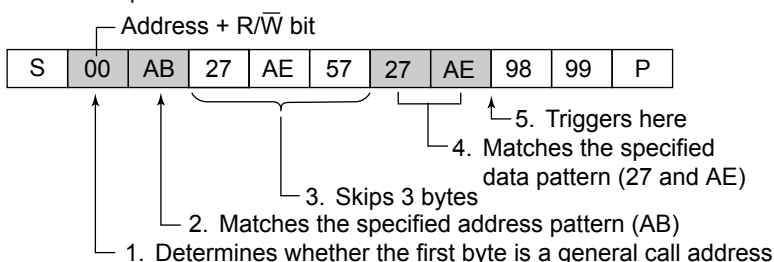

Start Byte

The DLM4000 triggers on a start byte master code (pattern: 0000 0001).

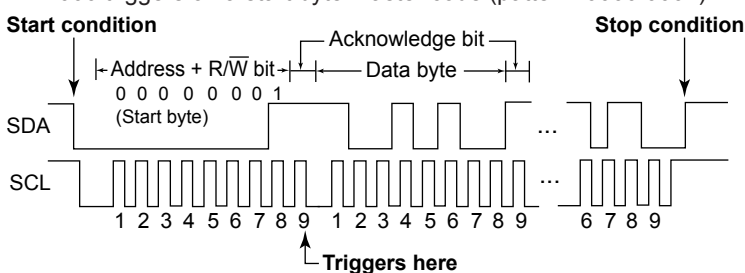

Example (Start Byte)

This example displays the data sequence at the byte level (hexadecimal notation) and indicates the trigger position. The following notations are used in the figure.

S: Start condition, Sr: Restart, P: Stop condition, Shading: Compared pattern

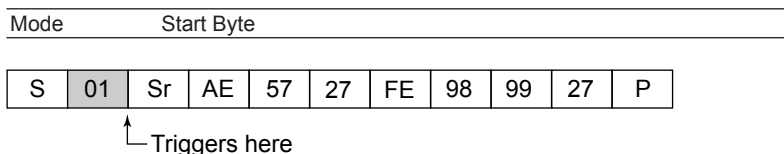

4 Triggering

HS Mode

The DLM4000 triggers on the HS (high-speed) mode master code (pattern: 0000 1XXX).

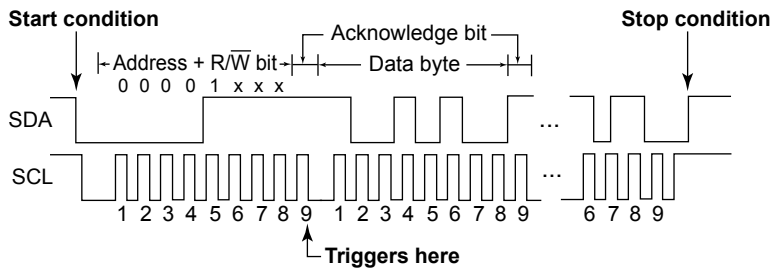

SPI Bus Trigger [ENHANCED, option]

The DLM4000 triggers based on the conditions of SPI bus signal data patterns. The following figure shows the SPI bus signal timing chart.

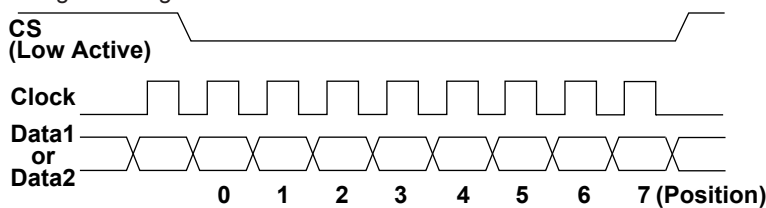

Wiring System (Mode)

You can select from one of the settings below.

3 wire	The DLM4000 triggers on the data pattern condition of one data line.
4 wire	The DLM4000 triggers on the data pattern conditions of Data1 and Data2 lines. You can also use one of the two data lines as a trigger condition.

Clock (Clock)

Source (Source)

Set the clock source to one of the settings below. If you select LOGIC, select the [source bit](#).

CH1 to CH8/LOGIC(L) or LOGIC(A|B)

* CH8 or LOGIC(L), whichever the corresponding key is illuminated (CH8 or L), can be selected.

Polarity (Polarity)

You can select which clock edge causes the data patterns to be compared.

\overline{f}	On the rising edge
f	On the falling edge

Data1 or 2 (Data1/Data2)

You can use a data pattern as a trigger condition. When the wiring system is 3wire, only set Data1. When the wiring system is 4wire, set Data1 and Data2.

Source (Source)

Set the Data1 and Data2 sources from one of the settings below. If you select LOGIC, select the [source bit](#).

Clock (Clock)	Data 1/2 (Data1/Data2)
For CH1 to CH4	CH1 to CH4
For CH5 to CH8/LOGIC(L)	CH5 to CH8/LOGIC(L)
For LOGIC(A B)	LOGIC(A B)

* CH8 or LOGIC(L), whichever the corresponding key is illuminated (CH8 or L), can be selected.
LOGIC(A|B) is available on models with the /L16 option.

Trigger Condition (Condition Setup)

Bit Order (Bit Order)

Set the bit order that is appropriate for the data stream.

When setting the data pattern, set the pattern MSB first regardless of the bit order setting.

MSB	When the data stream starts with the MSB
LSB	When the data stream starts with the LSB

Data Length (Size)

Set how many consecutive data bytes will be compared.

Selectable range: 1 to 4 bytes

Comparison Start Position (Position)

Set the comparison start position. For example, to start comparing from the first data byte after the chip select signal is activated, specify zero. If you do not set the comparison start point, the data trigger condition is met when the input signal data pattern first matches the specified data pattern.

Selectable range: 0 to 9999 bytes

Comparison Condition (Condition)

The data trigger condition is met when the relationship between the specified pattern and the input signal pattern meets the specified comparison condition.

True	When the patterns match
False	When the patterns do not match

Data Pattern and Format (Input Format)

Set the data pattern for the specified data size in hexadecimal or binary notation.



If you specify X in the pattern, the condition is assumed to be met regardless of the corresponding bit status. If a binary pattern contains any Xs, the corresponding hexadecimal display will be "\$."

CS (SS)

Source (Source)

Set the chip select source to one of the settings below. If you select LOGIC, select the [source bit](#).

Clock (Clock)	CS (SS)
For CH1 to CH4	CH1 to CH4
For CH5 to CH8/LOGIC(L)	CH5 to CH8/LOGIC(L)
For LOGIC(A B)	LOGIC(A B)

- * CH8 or LOGIC(L), whichever the corresponding key is illuminated (CH8 or L), can be selected. LOGIC(A|B) is available on models with the /L16 option.

Active

You can select the chip select level for activating the data.

H	When the signal level is high
L	When the signal level is low

Trigger Coupling (Coupling), HF Rejection (HF Rejection)

Noise Rejection (Noise Rejection), Level (Level)

Set these items for Clock, Data1, Data2, and CS.

These items are the same as those of the edge trigger.

▶ [See here.](#)

4 Triggering

Trigger Point

The trigger point is determined by the clock polarity setting as follows:

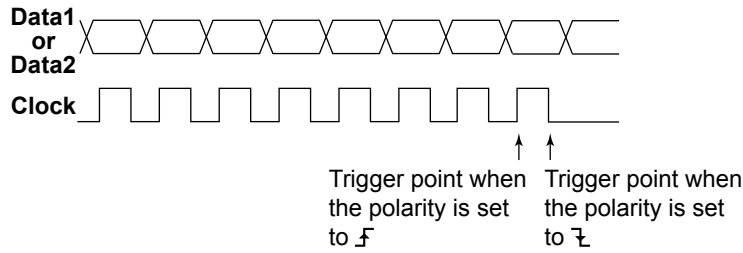

Example

This example displays the data sequence at the byte level and indicates the trigger position.

The Data1 and Data2 pattern references are set to A1 and A2, respectively.

Shading: Pattern to compare

CS	Active: L
Data1	Condition: True, Position: 0, Size: 2 bytes, Data pattern: A4 and 25
Data2	Condition: True, Position: 6, Size: 2 bytes, Data pattern: 85 and C8

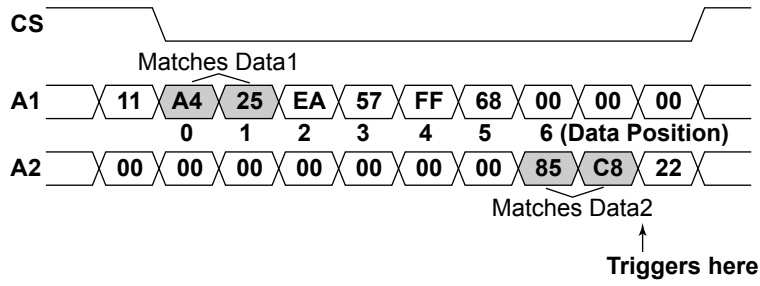

User-Defined Serial Bus Trigger [User Define, ENHANCED]

The DLM4000 triggers based on the trigger conditions of user-defined serial bus signal data patterns.

Data (Source)

Data Source (Source)

Set the data source to one of the settings below.

CH1 to CH8

Active

Select which signal level, high or low, will be detected as 1.

H	Detects high level as 1
L	Detects low level as 1

Clock On/Off

You can select whether or not to sample the data source in sync with the selected clock source.

ON	Samples in sync with the clock source
OFF	Does not synchronize to the clock source

Clock (Clock)

Set the clock that will be used to sample the data source.

Clock Source (Source)

Set the clock source to one of the settings below.

Data (Source)	Clock (Clock)
For CH1 to CH4	CH1 to CH4
For CH5 to CH8	CH5 to CH8

Polarity (Polarity)

You can select which clock source edge causes the data source to be sampled.

\uparrow	On the rising edge
\downarrow	On the falling edge

Chip Select (CS)

When the data source is sampled in sync with the clock source, the period that the DLM4000 tests the data source can be controlled using the chip select signal.

Chip Select Source (Source)

Set the chip select source to one of the settings below.

Data (Source)	Chip Select (CS)
For CH1 to CH4	CH1 to CH4, X
For CH5 to CH8	CH5 to CH8, X

* X: Chip select is not used. Data source is always detected.

Active

Select which signal level, high or low, will be used to test the data source.

H	Detects the data source when the signal level is high
L	Detects the data source when the signal level is low

4 Triggering

Latch (Latch)

You can specify the timing when the data source pattern sampled in sync with the clock source is compared with the specified pattern.

Latch Source (Source)

Set the latch source to one of the settings below.

Data (Source)	Latch (Latch)
For CH1 to CH4	CH1 to CH4, X
For CH5 to CH8	CH5 to CH8, X

* X: Latch is not used. Comparison is made for each clock.

Polarity (Polarity)

You can select which latch source edge causes the data patterns to be compared.

	On the rising edge
	On the falling edge

Trigger Condition (Condition Setup)

You can use a data pattern as a trigger condition. The data pattern trigger condition is met when the sampled data source pattern matches the specified pattern.

Data Length (Data Size)

Set the data pattern bit length.

Selectable range: 1 to 128 bits

Data Pattern and Format (Input Format)

Set the data pattern for the specified data size in hexadecimal or binary notation.

If you specify X in the pattern, the condition is assumed to be met regardless of the corresponding bit status.

If a binary pattern contains any Xs, the corresponding hexadecimal display will be "\$."

Bit Rate (Bit Rate)

If the clock is set to OFF, the DLM4000 samples the data source at the specified bit rate.

Selectable range	1000 bps to 50 Mbps
Resolution	0.001 kbps (for 1.000 kbps to 99.999 kbps)
	0.01 kbps (for 100.00 kbps to 999.99 kbps)
	0.1 kbps (for 1 Mbps to 9999.9 kbps)
	1 kbps (for 10 Mbps to 50 Mbps)

Trigger Coupling (Coupling), HF Rejection (HF Rejection)

Noise Rejection (Noise Rejection), Level (Level)

Set these items for data, Clock, CS, and Latch.

These items are the same as those of the edge trigger.

▶ [See here.](#)

Example

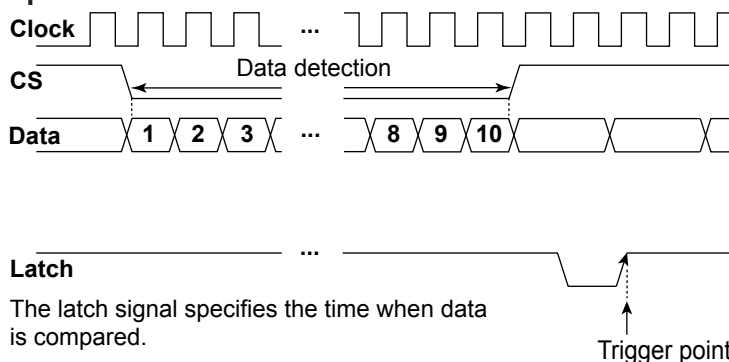

TV Trigger [ENHANCED]

The DLM4000 triggers based on the trigger conditions of a particular field or line in a TV signal.

Broadcasting System (Type)

Set the broadcasting system to one of the settings below.

NTSC (525/60/2)

PAL (625/50/2)

SDTV (480/60p)

HDTV (1080/60i, 1080/50i, 720/60p, 1080/25p, 1080/24p, 1080/24sF, or 1080/60p)

User Define: Specify appropriate settings such as the definition (SD or HD), horizontal sync frequency, and sync guard frequency.

Trigger Source (Source)

Set the trigger source to a channel from CH1 to CH8.

Polarity (Polarity)

Select which polarity the TV signal must be with respect to the trigger level for the DLM4000 to trigger.

Pos	Positive
Neg	Negative

Trigger Level (Level)

Set the trigger level in units of divisions with the peak value equal to 0 divisions.

Selectable range: 0.1 to 2.0 divisions

Resolution: 0.1 divisions

The default setting is 0.5 divisions.

Line Number (Line)

Set the trigger source line number.

- One: The DLM4000 triggers on the start of the selected line number.
- All: The DLM4000 triggers on all lines.

The selectable range for various broadcasting systems is as follows:

Broadcasting format	Selectable Range
NTSC	5 to 1054
PAL	2 to 1251
SDTV	8 to 2251
HDTV	2 to 2251
User Define	2 to 2251

Field Number (Field)

Select the field number to detect.

You can only set the field number for NTSC, PAL, or HDTV (1080/60i, 1080/50i, or 1080/24sF).

1	Detects fields whose vertical sync pulse starts at the same time as the start of a line
2	Detects fields whose vertical sync pulse starts 1/2H (where H is the horizontal scanning period) behind the start of a line
X	Detects both

4 Triggering

Frame Skip (Frame Skip)

This feature skips frames in cases such as when the color burst is inverted for every frame. You can select how many frames to skip.

1	The DLM4000 triggers on the specified field of every frame.
2	The DLM4000 skips 1 frame and triggers on the specified field on the subsequent frame. This operation is repeated every 2 frames.
4	The DLM4000 skips 3 frames and triggers on the specified field on the subsequent frame. This operation is repeated every 4 frames.
8	The DLM4000 skips 7 frames and triggers on the specified field on the subsequent frame. This operation is repeated every 8 frames.



Trigger coupling and HF rejection settings are ignored.

NTSC Example

The following line numbers are those when the field number is set to 1 (if the field number is set to 2, the numbers are assigned sequentially by setting 268 to 5).

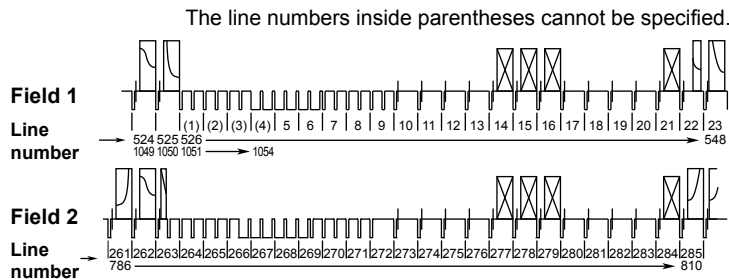

PAL Example

The following line numbers are those when the field number is set to 1 (if the field number is set to 2, the numbers are assigned sequentially by setting 315 to 2).

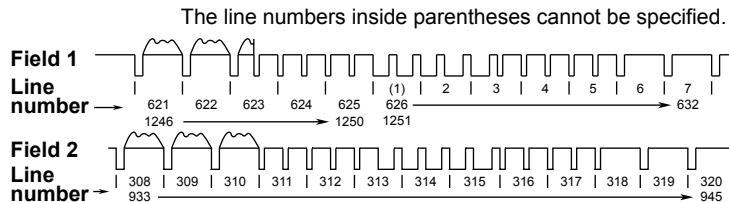

SDTV Example

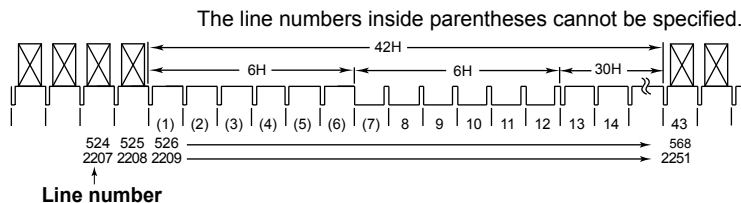

HDTV Example

- **Example for 1080/60i, 1080/50i, or 1080/24sF**

The following line numbers are those when the field number is set to 1 (if the field number is set to 2, the numbers are assigned sequentially by setting 565 to 2).

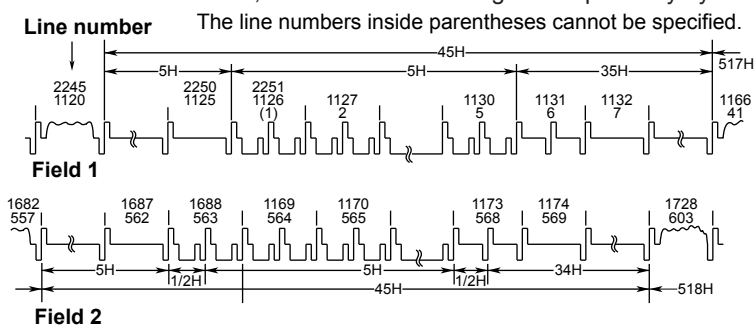

- **720/60p Example**

The line numbers inside parentheses cannot be specified.

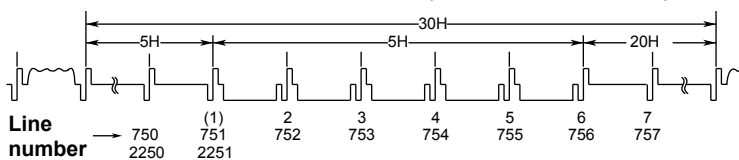

- **Example for 1080/25p, 1080/24p, and 1080/60p**

The line numbers inside parentheses cannot be specified.

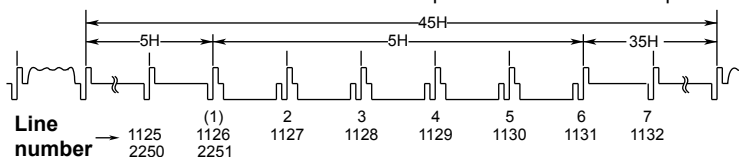

4 Triggering

User Defined (User Define)

Define appropriate values for definition, horizontal sync frequency, sync guard frequency, etc.

Trigger Source (Source), Polarity (Polarity), Trigger Level (Level)

Line Number (Line), Field Number (Field), Frame Skip (Frame Skip)

These items are the same as when a specific broadcasting system is specified.

▶ [See here.](#)

HF Rejection (HF Rejection)

Select whether or not to eliminate high-frequency components (300 kHz or higher) from the trigger source.

300kHz: Eliminates high-frequency components greater than or equal to 300 kHz

OFF: Does not eliminate high-frequency components



When the broadcasting system is not set to User Define, the HF rejection setting is as follows:

NTSC, PAL, or SDTV: Fixed at 300 kHz

HDTV: Fixed at OFF

Horizontal Sync Frequency (HSync)

Set the horizontal sync frequency. Pressing the RESET key sets the frequency to 31.5 kHz.

Sync Guard Frequency (Sync Guard)

Set the sync guard frequency as a percentage of the horizontal sync frequency.

Pressing the RESET key sets the frequency to 70%/Hsync.

Definition (Definition)

Set the definition to one of the settings below.

SD: Standard (bi-level sync signal)

HD: High definition (tri-level sync signal)

Trigger B [B TRIG]

Trigger B is the trigger you set using the B TRIG key.

The DLM4000 can trigger on the combination of trigger A (condition A) and trigger B (condition B).

The trigger conditions you set using the EDGE or ENHANCED key are the trigger A conditions. The trigger conditions you set using the B TRIG key are the trigger B conditions.

Trigger Combination (Combination)

Set how to combine trigger A and B conditions. If trigger condition A is set to serial bus trigger's PSI5 Airbag, the combination setting is fixed to OFF.

- OFF: The DLM4000 triggers only on the trigger A conditions (the trigger B conditions are not used).
- A Delay B: After the trigger A conditions are met and the specified amount of time elapses, the DLM4000 triggers when the trigger B conditions are met.
- A->B(N): After the trigger A conditions are met, the DLM4000 triggers when the trigger B conditions are met N times.
- Dual Bus: The DLM4000 triggers when the serial bus trigger A or B conditions are met.

Example

A Delay B Trigger

After the trigger A conditions are met and the specified amount of time elapses, the DLM4000 triggers when the trigger B conditions are first met.

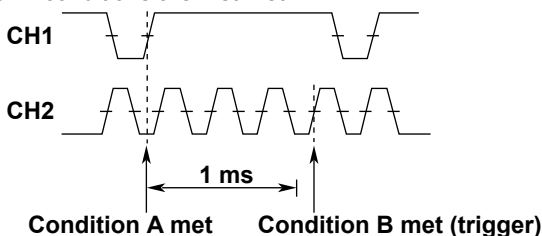

Condition A: Edge trigger, CH1 = \uparrow ,
Condition B: Edge trigger, CH2 = \uparrow , Delay = 1 ms

A->B(N) Trigger

After the trigger A conditions are met, the DLM4000 triggers when the trigger B conditions are met N times.

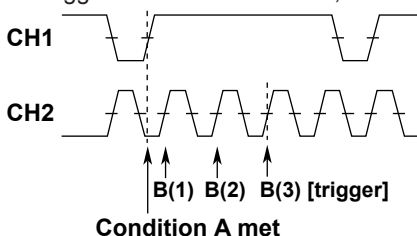

Condition A: Edge trigger, CH1 = \uparrow ,
Condition B: Edge trigger, CH2 = \uparrow , N = 3

Dual Bus Trigger

The DLM4000 triggers when condition A or condition B is met. This trigger can be used when both condition A and B are Serial Bus triggers.

Condition A (LIN bus trigger, Mode: Break Synch)

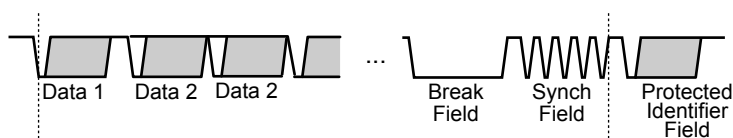

Condition B (CAN bus trigger, Mode: SOF)

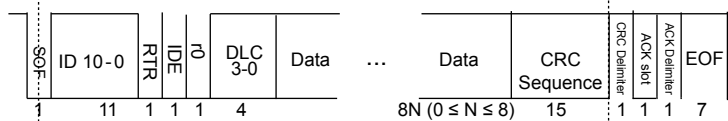

Trigger

4 Triggering



- If condition A is set to Serial Bus trigger (excluding PSI5 Airbag), you can select the Dual Bus trigger.
 - When condition A is set to Serial Bus trigger (excluding PSI5 Airbag), condition B is set to a different trigger, and the trigger combination is set to Dual Bus, condition B will change automatically to Serial Bus trigger. Of the Serial Bus triggers that can be used and displayed on the menu, condition B will change to the top most Serial Bus trigger.
-

Trigger A (A Trigger)

The trigger A conditions are set using the menu that corresponds to the EDGE or ENHANCED key, whichever is illuminated.

Trigger B (B Trigger)

Configure trigger B (condition B). You can use the following triggers.

Edge trigger, Edge Qualified trigger, State trigger, or Serial Bus trigger (excluding PSI5 Airbag)

When the A and B trigger types are set to Dual Bus, the only trigger that you can specify is Serial Bus (excluding PSI5 Airbag).

Configuring the Trigger B Conditions

The items that you can set vary depending on the A and B trigger types that you selected.

- **A Delay B Trigger**

Configure these items for trigger B: trigger type, trigger source, trigger level, delay, and other settings.

The trigger type, trigger source, and trigger level settings are the same as those in the menu for the EDGE or ENHANCED keys.

Delay (Delay)

Selectable range: 10 ns to 10 s

Resolution: 2 ns

- **A->B(N) Trigger**

Configure these items for trigger B: trigger type, trigger source, trigger level, the number of times condition B must be met, and other settings. The trigger type, trigger source, and trigger level settings are the same as those in the menu for the EDGE or ENHANCED keys.

Number of Times Condition B Must Be Met (N Count)

Selectable range: 1 to 10⁹



If you set trigger B to Edge Qualified when using an A->B(N) trigger, the trigger B interval must be at least 20 ns for triggering to operate properly.

- **Dual Bus Trigger**

Configure these items for trigger condition B: serial bus trigger type, trigger source, trigger level, and other settings.

The trigger type, trigger source, and trigger level settings are the same as the Serial Bus trigger settings in the menu for the ENHANCED key.

5 Executing Actions

A specific action can be executed when trigger conditions are met (this feature is called action-on-trigger) or when the GO/NO-GO determination result is no-go. You can set the number of times to execute the action in terms of the number of waveform acquisitions or the number of determinations.

Logic signals cannot be used as GO/NO-GO determination source waveforms.

Action Mode (Mode)

Select the action mode from one of the following three settings.

- Action on Trig (trigger): Executes the specified action each time the trigger condition is met
 - [Go/Nogo AND](#) (GO/NO-GO determination): Executes the specified action each time all of the reference conditions are no-go
 - [Go/Nogo OR](#) (GO/NO-GO determination): Executes the specified action each time any of the reference conditions are no-go
- * You can set up to four reference conditions.

Action to Execute When Conditions Are Met (Action)

The DLM4000 executes the specified action each time the conditions are met. You can specify any of the four actions below.

Buzzer (Buzzer)

Sounds an alarm.

Print or Save the Screen Image (Print)

Prints the screen image to the printer specified by "Print to" in the PRINT menu or stores the screen image data to the specified storage medium. The available printer is Built-in printer.

Save the Waveform Data (Save Wavefrm)

Stores the waveform data in binary or ASCII format to the destination specified using the FILE menu. The available destination options are internal memory and USB storage. Specify the file type using Data Type in the FILE menu.

▶ [See here.](#)

Send Mail (Send Mail)

Sends email to the specified address. Set the email address by pressing UTILITY and then selecting Network > Mail.

▶ [See here.](#)

- **Mail Count**

Sets the upper email transmission limit. When the number of transmitted emails reaches Mail Count, the DLM4000 stops sending emails.

- **Contents of Emails That the DLM4000 Sends (Action on Trig)**

<Subject>: The subject attached to the email. For example: "Action Triggered Report (nth action)"

[Comment]: Comment

[Trigger Date and Time]: The time of trigger occurrence

[Action Count]: The number of actions performed

- **Contents of Emails That the DLM4000 Sends (Go/Nogo OR, Go/Nogo AND)**

<Subject>: The subject attached to the email. For example: "GoNogo Triggered Report (Nth Nogo result)"

[Comment]: Comment

[Setup Information]: Information about reference conditions 1 through 4, Logic (AND or OR), Stop Nogo/
Action Count (the number of no-go results/the number of actions)

[Trigger Date and Time]: The time of trigger occurrence

[Nogo/Exec Count]: The number Nogo results/the number of judgments performed

[Nogo Factor]: Information, including measured values, about the conditions that returned no-go results*

* Measured values are only sent for GO/NO-GO determination based on waveform parameters.

Number of Actions (Action Count/Nogo Count)

When the number of waveform acquisitions reaches the specified action count or when the number of no-go results reaches the specified Nogo Count, the DLM4000 stops waveform acquisition.

Action Count

Set the number of waveform acquisitions.

1 to 1000000: The DLM4000 stops the action when it acquires the specified number of waveforms.

Infinite (0): The DLM4000 repeats the action until waveform acquisition is stopped using the Abort soft key or the RUN/STOP key.

Nogo Count

Set the number of no-go results.

- 1 to 1000: When the specified number of no-go results is reached, the DLM4000 stops GO/NO-GO determination.
- Infinite (0): The DLM4000 repeats GO/NO-GO determination until waveform acquisition is stopped using the Abort soft key or the RUN/STOP key.

Executing Action-on-Trigger or GO/NO-GO determination (Exec)

Press the Exec soft key. You cannot use the RUN/STOP key for this purpose. During execution, the Exec soft key changes to the Abort soft key. The trigger mode during action-on-trigger or GO/NO-GO determination is set to Normal (this setting is independent from the front-panel MODE key).

Press the Abort soft key to stop action-on-trigger or GO/NO-GO determination.

GO/NO-GO Determination (Go/Nogo AND, Go/Nogo OR)

The DLM4000 determines whether the acquired waveform meets the reference condition (no-go result) or not (go result). When the DLM4000 produces a no-go result, it executes the specified action.

You can specify up to four reference conditions. You can also apply AND or OR logic to the four reference conditions.

In the reference conditions, you can include a zone or values obtained from automated measurement of waveform parameters.

The determination result can be transmitted through the rear-panel GO/NO-GO output terminal.

- Go/Nogo AND: Executes the action when all reference conditions 1 to 4 are no-go
- Go/Nogo OR: Executes the action when any of the reference conditions (1 through 4) are no-go

Reference Conditions (1 to 4)

For reference conditions 1 to 4, set the source waveform, reference range (the zone or the waveform parameter upper and lower limits), and the reference criterion.

Reference Criterion (Condition)

Set whether the source waveform must be in or out of the reference range to produce a no-go result. You can also exclude the source waveform from the GO/NO-GO determination.

- IN: No-go when the source waveform is within the reference range
- OUT: No-go when the source waveform is outside the reference range
- X: The source waveform is not used for GO/NO-GO determination.

Source Waveform (Trace)

You can select from one of the settings below. If you select LOGIC, select the [source bit](#).

CH1 to CH8/LOGIC(L), LOGIC(A|B), Math1 to Math4, XY1 to XY4, FFT1, FFT2

- * You can select CH8 or LOGIC(L), depending on which channel's corresponding key (CH8 or L) is illuminated. LOGIC(A|B) is available on models with the /L16 option.

Selectable Reference Range Types for Various Source Waveforms

	Rect	Wave	Polygon	Parameter
CH1 to CH8	Yes	Yes	Yes	Yes
LOGIC(L)	No	No	No	Yes
LOGIC(A B)	No	No	No	Yes
Math1 to Math4				
Reference condition 1 and 3	Yes	Yes	Yes	Yes
Reference condition 2 and 4	No	No	No	Yes
XY1 to XY4	Yes	No	Yes	Yes
FFT1, FFT2	No	No	No	Yes

Reference Range Type (Mode)

You can set the reference range type to one of the settings below.

- [RectZone](#): Rectangular zone
- [WaveZone](#): Waveform zone
- [PolygonZone](#): Polygonal zone
- [Parameter](#): Sets upper and lower limits for one measured waveform parameter



Reference conditions 1 through 4 share their settings with history waveform search conditions 1 through 4.

Creating a Rectangular Zone (RectZone)

To create a rectangle, use the jog shuttle or the SET key to set the top, bottom, right, and left boundaries of the rectangle.

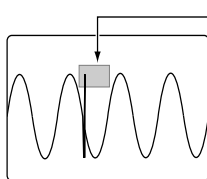

When the NO-GO determination condition is set to IN and the waveform enters the specified rectangular zone, a no-go judgment is made.

Creating a Rectangular Zone (Upper/Lower and Left/Right)

Create a rectangular zone.

- The selectable range for top and bottom boundaries is ± 4 divisions from the screen center in 0.01-division steps.
- The selectable range for left and right boundaries is ± 5 divisions from the screen center in 0.01-division steps.

Determination Source Window (Range)

If the source waveform is CH1 to CH8, Math1 to Math4, set the GO/NO-GO determination source window to one of the following options:

- Main: Main window
- Zoom1: Zoom1 window
- Zoom2: Zoom2 window



The rectangular zone is cleared if you set Condition to X or if you turn off the source waveform display.

Creating a Waveform Zone (Wave-Zone)

Create a zone based on the source waveform. You can also use other waveforms to create the zone. You can create up to four waveform zones. One of them is used for GO/NO-GO determination.

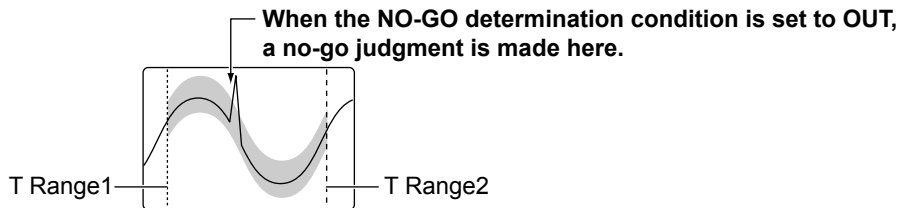

Determination Source Window (Time Range)

Select the GO/NO-GO determination source window. The selection process is the same as with the rectangular zone.

▶ See here.

Selecting the Waveform Zone (Zone No.)

Select the number of the waveform zone you want to edit. GO/NO-GO determination is performed using the waveform zone that you select here.

Editing a Waveform Zone (Edit1 to 4)

Create a vertical or horizontal zone on the entire waveform or on a portion of the waveform. The waveform zones that you create are stored in the internal memory even when the power is turned off. You can save and load waveform zones from the internal memory or an external storage medium using the FILE menu.

▶ See here.

Specifying the Editing Range (Edit)

You can specify which portion of the base waveform you want to edit.

- Whole: Edit the entire waveform
- Part: Edit a portion of the waveform

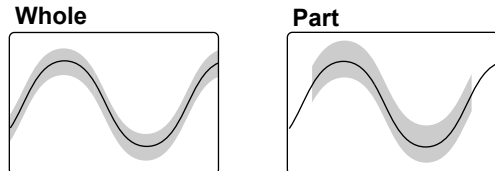

Setting Zones (Upper/Lower, Left/Right and T Range1/T Range2)

Set vertical or horizontal zones.

- Selectable vertical zone range: ± 8 divisions from the base waveform
- Selectable horizontal zone range[†]: ± 5 divisions from the screen center
- * When you select Whole, use Left and Right to set the zones. When you select Part, use T Range1 and T Range2 to set the zones.

Changing the Base Waveform (Trace)

You can select the base waveform for creating the waveform zone from one of the settings below. Change the base waveform when you want to use a waveform other than the determination source waveform or when you want to recreate the zone. You cannot select waveforms whose display is turned off. CH1 to CH8, Math1 to Math4

Starting Over the Editing (Exec)

To start over the editing of the waveform zones, press this soft key. If you press this key, all the zones that you have edited up to that point will be lost.



If you want to continue editing existing zones, do not press this soft key. Even if you press the Exec soft key and clear the zones, the original zones are stored if you have stored them in the past according to the procedure explained in "Confirming the Waveform Zones" on the next item. If you want to go back and edit the original zones, press the Quit soft key to finish editing once, and then press one of the Edit 1 to 4 soft keys to enter the edit menu again.

Confirming the Waveform Zone (Store)

Confirm and store the waveform zones that you have edited.

Finishing the Editing Operation (Quit)

Finish waveform zone editing. If you did not confirm and store the edited waveform zones by pressing the Store soft key, the changes that you have made will be lost.

Determination Area (T Range1/T Range2)

The DLM4000 performs GO/NO-GO determination on the waveform in the area specified by T Range1 and T Range2.

Selectable range: Within ± 5 divisions of the time axis

Creating a Polygonal Zone (PolygonZone)

You can use polygonal zones by using polygon images. You can create polygon images by using the Mask Editor Software on a PC. You can create up to four polygonal zones and use one of them for GO/NO-GO determination.

You can download the Mask Editor Software from the YOKOGAWA website.

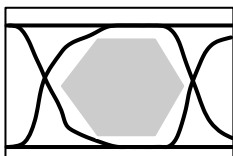
**Loading a Polygon Image**

Using the FILE Menu, load a polygon image into the specified zone (Zone No.1 to 4).

Determination Source Window (Time Range)

Select the GO/NO-GO determination source window. The selection process is the same as with the rectangular zone.

▶ [See here.](#)

Selecting the Polygonal Zone (Zone No.)

Select the zone number that contains the polygon image that you want to use for determination.

Moving the Polygonal Zone (V-Position, H-Position)

You can move the loaded polygon image vertically or horizontally.

Selectable V-Position range: ± 4 divisions

Selectable H-Position range: ± 5 divisions

Setting the Reference Range Using a Waveform Parameter (Parameter)

Set upper and lower limits on a measured item obtained through the automated measurement of waveform parameters.

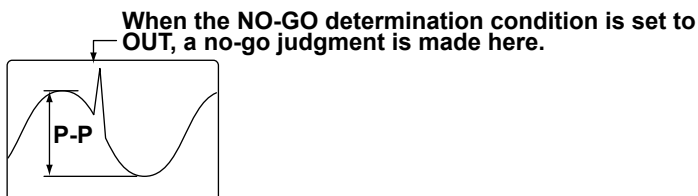
**Selecting the measured item to use for determination (Item)**

The selectable item varies depending on the determination source waveform (Trace) that you selected. If you select LOGIC, select the [source bit](#).

- CH1 to CH8/LOGIC(L), LOGIC(A|B), Math1 to Math4: All measurement items
 - * CH8 or LOGIC, whichever the corresponding key is illuminated (CH8 or L), can be selected. LOGIC(A|B) is available on models with the /L16 option.
- XY1 to XY4: Integ only
- FFT1 or FFT2: Peak cursor only

Reference Range (Upper/Lower)

Set the upper and lower limits of the reference range.

Notes about Action



How the DLM4000 operates when the action setting is Print or Save Waveform

- The DLM4000 operates based on the settings in the Print menu or FILE menu. If the auto naming feature in the FILE menu is off, files are saved using sequence numbers (Numbering). If it is not off, the files are saved using the specified method.
- If the DLM4000 internal memory is being accessed from a PC while an action is being executed, the PC may stop detecting the internal memory. If this happens, remove the USB cable connecting the PC to the DLM4000, wait a few seconds, and reconnect the cable.

Points to Consider When Configuring Action-on-Trigger

- You cannot change settings while the action-on-trigger feature is active.
- Exponential averaging is used.
- When repetitive sampling mode is ON, the DLM4000 performs GO/NO-GO determination on each history waveform.

Notes about GO/NO-GO Determination

- The DLM4000 displays the determination results on the screen (the total number of results and the number of no-go results).
- During GO/NO-GO determination, only the Abort soft key and RUN/STOP are valid.
- The DLM4000 automatically changes the trigger mode to Normal when it executes GO/NO-GO determination.

Points to Consider when Setting the Action Setting to Print

- If Print To is set to Multi on the PRINT menu, you cannot execute the action.

Points to Consider When Setting the Action Setting to Save Waveform

- Do not set the storage medium's root folder as the save destination.
- If you set sequential numbering as the automatic naming method (using the FILE menu), as the number of saved files increases, the amount of time required to save a file will also increase. Also, the maximum number of files that can be saved using sequential numbering is 1000. To save more than 1000 files, set the automatic naming function so that files are named by date.
- If you use the automatic naming function to save data to files, GO/NO-GO determination will stop if the same file name exists in the same folder. To prevent this from happening, you can either create a new empty folder before you start GO/NO-GO determination, or you can make sure that there are no files in the destination folder.
- Up to 2500 files and folders can be displayed in the file list. If there are more than a total of 2500 files and folders in a given folder, the file list for that folder will only display 2500 files and folders. There is no way to set which files and folders are displayed.

Points to Consider When Setting the Action Setting to Send Mail

- The DLM4000 operates based on the settings that you specified by pressing UTILITY and selecting Network > Mail. You can attach screen images to emails.
 - We recommend that you set a limit on the mail transmission number to avoid overloading the mail server. You can set the upper limit of mail transmissions using Mail Count.
 - If the specified number of mail transmissions is less than the number of specified actions, mail transmission will stop after the specified number of transmissions. If the specified number of mail transmissions is greater than the number of specified actions, mail transmission will stop after the specified number of actions.
-

6 Waveform Acquisition

Based on the data that has been stored in the acquisition memory, the DLM4000 performs various operations, such as displaying waveforms on the screen, computing, measuring cursors, and automatically measuring waveform parameters.

This chapter explains how to set the number of data points to store in the acquisition memory (the record length), how to enable or disable the sample data averaging feature, and so on.

Record Length (Record Length)

Record length refers to the number of data points that are stored to the acquisition memory for each channel. The DLM4000 allows you to set the record length to a value from 1.25 kpoints to 250 Mpoints (this range varies depending on the installed option).

If you want to observe a long-term phenomenon at a high time resolution (at a high sample rate), set the record length to a high value.

When the record length is set to a high value, computation and measurement processing take longer than when the record length is short.

The following limitations on waveform acquisition conditions and the number of waveforms that can be stored in the acquisition memory (the number of history waveforms) apply depending on the specified record length.

Record Length	Number of History Waveforms			
	No options (12.5 Mpoints)	/M1 Option (62.5 Mpoints)	/M2 Option (125 Mpoints)	/M3 Option (250 Mpoints)
1.25 kpoints	2500	10000	20000	50000
12.5 kpoints	250	1000	2500	5000
125 kpoints	20	100	250	500
1.25 Mpoints	1	10	20	50
6.25 Mpoints	1 ¹	1	–	10
12.5 Mpoints	1 ²	–	1	5
25 Mpoints	–	1 ¹	–	1
62.5 Mpoints	–	1 ²	1 ¹	1 ¹
125 Mpoints	–	–	1 ²	1 ¹
250 Mpoints	–	–	–	1 ²

- 1 Waveform acquisition operates in Single mode at this record length regardless of the trigger mode setting. You cannot specify Averaging, High Resolution, or Repetitive Sampling mode.
- 2 You can only specify this record length when the interleave mode is on. Waveform acquisition operates in Single mode regardless of the trigger mode setting. You cannot specify Averaging, High Resolution, or Repetitive Sampling mode.

Acquisition Mode (Mode)

You can set the acquisition mode to one of the settings below.

Normal Mode (Normal)

Displays waveforms without processing the sampled data.

Envelope Mode (Envelope)

The DLM4000 determines the maximum and minimum values among the data sampled at 1.25 GS/s (2.5 GS/s when the interleave mode is on) at the time interval that is 2 times of the sampling period (the inverse of the sample rate) of the Normal mode setting and displays the values as pairs to produce the waveform.

This mode is effective when you want to avoid aliasing, because the sample rate is essentially kept high regardless of the time axis setting. It is also effective when you want to detect glitches (narrow pulse signals) or when you want to display the envelope of a modulated signal. This mode can be used when the sample rate is 625 MS/s or less.*

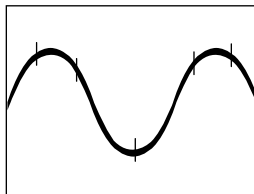

Normal mode

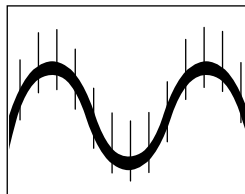

Envelope mode

- * The sample rate at which the acquisition mode changes to Envelope varies depending on the setting of Interleave mode.

Interleave Mode	
OFF	ON
312.5 MS/s or less	625 MS/s or less



If you set the acquisition mode to Envelope when the sample rate is set to 625 MS/s or higher, the DLM4000 actually operates in Normal mode. In envelope mode, [Envelope] appears in the upper right of the screen (except during high resolution mode).

Averaging Mode (Average)

In Averaging mode, the DLM4000 acquires waveforms numerous times, averages the same time points relative to the trigger point, and displays averaged waveforms. Averaging mode is useful when you want to remove random noise from waveforms.

You cannot use the history feature in Averaging mode.

The averaging method varies depending on the trigger mode.

- Auto, Auto Level, or Normal mode: Exponential averaging
- Single mode: Linear averaging
- N Single mode: Actually operates in Normal mode.



To average waveforms that have been acquired in N Single mode, set the acquisition mode to Normal, and turn on history feature's averaging.

Attenuation Constant and Average Count (Avg Count)

Sets the attenuation constant for exponential averaging or the average count for linear averaging.

Selectable range: 2 to 1024

Exponential averaging

$$A_n = \frac{1}{N} \{(N - 1)A_{n-1} + X_n\}$$

A_n: nth averaged value

X_n: nth measured value

N: Attenuation constant
(2 to 1024 in 2ⁿ steps)

Linear averaging

$$A_n = \frac{\sum_{n=1}^N X_n}{N}$$

X_n: nth measured value

N: Number of times to average
(2 to 1024 in 2ⁿ steps)



Logic waveforms are not averaged.

Number of Waveform Acquisitions (ACQ Count)

When the acquisition mode is set to Normal (Normal) or Envelope (Envelope), you can set the number of waveform acquisitions. If you select Infinite, the DLM4000 continues waveform acquisition until you stop it using the RUN/STOP key. The default setting is Infinite. You cannot change the number of acquisitions during waveform acquisition. If you want to change it, stop acquisition first.

Selectable range: 1 to 65536, or Infinite



The number of waveforms that have been stored to the acquisition memory appears at the upper left of the screen.

High Resolution Mode (Hi Resolution)

When High Resolution mode is turned on, the number of effective bits per data value is expanded by up to 12 bits through the digital and bandwidth filters (Band Width).

- ON: Enables High Resolution mode
- OFF: Disables High Resolution mode



- When High Resolution mode is turned on, the maximum sample rate of real-time sampling is set to 625 MS/s, half the ordinary value (1.25 GS/s when Interleave mode is on).
- High Resolution mode does not apply to logic waveforms.

Interleave Mode (Interleave)

Interleave mode is used to double the normal amount of memory by allocating the even-numbered channel's memory to the odd-numbered channel's memory. When Interleave mode is turned ON, the DLM4000 cannot acquire waveforms for the CH2, CH4, CH6, CH8, and LOGIC(L) inputs, but you can set the record length up to a value that is double the normal maximum value.

In real-time sampling mode, you can increase the sample rate up to 2.5 GS/s (double the normal sample rate) by sampling a single input signal using two A/D converters with offset phases.

- ON: Enables Interleave mode
- OFF: Disables Interleave mode



When Interleave mode is on, the DLM4000 cannot acquire waveforms for the CH2, CH4, CH6, CH8, and LOGIC(L) inputs. However, these inputs can be used as trigger sources.

Sampling Mode (Sampling Mode)

The DLM4000 samples data using a 1.25-GS/s A/D converter, so the maximum sample rate in normal sampling mode (real-time sampling mode) is 1.25 GS/s.

If you decrease the time axis setting when measuring fast phenomena, the sample rate will reach its maximum rate (1.25 GS/s) at a certain point. If you decrease the time axis setting further, the number of displayed points decreases (the display record length decreases).

The DLM4000 has two modes for interpolating between deficient data points. Set the sampling mode when you want to make measurements by setting a sample rate that is higher than the real-time sampling mode's maximum sample rate (1.25 GS/s).

- Interpolation mode: Interpolates between data points using the $(\sin x)/x$ function. This mode is effective for single-shot signals.
- Repetitive sampling mode: Interpolates through random sampling. This mode is effective for repeating signals.

Relationship between the Time Axis Setting, Record Length, and Sample Rate

The relationship between the time axis setting, record length, and sample rate is as follows:

When the record length and the time axis are set so that the sample rate is at the maximum rate, if you decrease the time axis setting further, the record length is reduced.

$$\text{Sample rate} = \text{Record length}/(\text{time axis setting [s/division]} \times 10 [\text{divisions}])$$

Real-Time Sampling Mode (Realtime)

When you change the time axis setting, the sample rate changes. You can sample data at a maximum sample rate of 1.25 GS/s (2.5 GS/s when Interleave mode is on).

In this mode, the DLM4000 can only display waveforms up to the frequency that corresponds to one-half the sample rate, in accordance with the sampling theorem.* Therefore, this mode is suitable for observing waveforms whose frequency is lower than one-half the sample rate.

- * If the sample rate is comparatively low with respect to the input signal frequency, the harmonics contained in the signal are lost. When this happens, some of the harmonics will be misread as low-frequency waves due to the effects described by the Nyquist sampling theorem. This phenomenon is called aliasing. You can avoid aliasing by acquiring waveforms with the acquisition mode set to Envelope.

Interpolation Mode (Interpolation)

In Interpolation mode, the DLM4000 interpolates the data sampled at 1.25 GS/s up to 100 times (200 times in High Resolution mode) using the $(\sin x)/x$ function.

This essentially increases the sample rate to up to 125 GS/s.

The interpolation mode is effective for single-shot signals. If the input signal frequency is high relative to the sample rate (1.25 GHz here), aliasing may occur.

You can use the history feature in Interpolation mode.

Repetitive Sampling Mode (Repetitive)

In this mode, one waveform is created from several cycles of a repeating signal. This is equivalent to sampling the signal at a higher sample rate than the actual sample rate. The equivalent sample rate is 125 GS/s maximum.

The DLM4000 uses random sampling, which takes advantage of the fact that the time difference between the trigger point and sampled points is random. The DLM4000 realigns the trigger point each time it acquires a waveform.

This mode is effective for repeating signals, and aliasing rarely occurs.

You cannot use the history feature in Repetitive Sampling mode.



- Even if Interpolation or Repetitive Sampling mode is selected, the DLM4000 runs in real-time sampling mode when the sample rate is less than or equal to 1.25 GS/s (2.5 GS/s when Interleave mode is on). When the DLM4000 is running in Interpolation or Repetitive Sampling mode, “IntP” or “Rep” appears at the upper right of the screen.
- When the sample rate is at its maximum rate (125 GS/s) in Interpolation or Repetitive Sampling mode, if you decrease the time axis setting, the display record length is reduced.
- If the trigger mode is set to Single or N Single, the acquisition mode is set to Averaging, and the sampling mode is set to Repetitive Sampling, the DLM4000 actually runs in Interpolation mode.
- If the trigger mode is set to N Single and the sampling mode is set to Repetitive Sampling, the DLM4000 actually runs in Interpolation mode.

Waveform Acquisition (RUN/STOP)

When you execute (RUN) waveform acquisition, the DLM4000 stores waveform data to the acquisition memory and updates the displayed waveforms each time the DLM4000 triggers. The acquisition memory is divided into many areas based on the specified record length, and the maximum number of acquirable waveforms are stored in the memory. You can recall past waveforms that are stored in the memory using the history feature when waveform acquisition is not running.

DLM4000 Operation When the Acquisition Mode Is Set to Averaging

- Averaging stops when you stop acquisition.
- If you execute acquisition again, averaging starts from the beginning.

RUN and STOP Operations during Accumulation

- Accumulation stops when you stop acquisition.
- When you execute acquisition again, the displayed waveforms up to that point are cleared, and accumulation restarts from the beginning.

The RUN/STOP Key Is Disabled:

- When the DLM4000 is in remote mode.
- When the DLM4000 is printing to a printer, when it is being set up automatically, or when it is accessing a storage medium.



- If you press HISTORY during waveform acquisition, waveform acquisition stops.
- If you change the waveform acquisition conditions and start waveform acquisition, the past data stored in the acquisition memory is cleared.
- You can use the snapshot feature to retain the displayed waveform on the screen. This feature allows you to update the display without having to stop waveform acquisition.
- To update the displayed waveform once when the trigger condition is met and then stop waveform acquisition, press SINGLE.

Acquiring the Waveform Once (SINGLE)

When you execute waveform acquisition (SINGLE) and trigger conditions are met, the DLM4000 updates the displayed waveform once and stops waveform acquisition. If no triggers occur, the display is not updated.

If TIME/DIV is set to a value that would cause the display to switch to roll mode (100 ms/div to 500 s/div), roll mode is used until a trigger occurs. When the DLM4000 triggers, roll mode will stop when it acquires the record length's post-trigger data. This mode is suitable for the observation of single-shot signals.

7 Display

Types of Windows

The DLM4000 has the following windows.

VT waveform display window

Main window	Displays normal waveforms, which are not magnified.
Zoom1 window	Displays zoomed waveforms according to the settings specified using the ZOOM1 key.
Zoom2 window	Displays zoomed waveforms according to the settings specified using the ZOOM2 key.

XY window

XY1 window	Displays the XY1 waveform according to the settings specified using the X-Y key.
XY2 window	Displays the XY2 waveform according to the settings specified using the X-Y key.

FFT window¹

Displays the FFT1 and FF2 waveforms according to the settings specified by the FFT key.

Trend/Histogram window^{1, 2}

Displays Trend1, Trend2, Hist1, and Hist2 according to the statistical processing settings specified using the MEASURE key.

- 1 The FFT window and the Trend/Histogram window are the same.
- 2 Two out of Trend1, Trend2, Hist1, and Hist2 can be displayed.

Display Example

<Main>		
<Zoom1>		<Zoom2>
<XY1>	<XY2>	<FFT, Trend, Histogram>

Display Format (Format)

You can evenly divide the VT waveform display window so that you can easily view input waveforms and computed waveforms. You can divide the window in the following ways.

Auto,* Single (one area), Dual (two areas), Triad (three areas), Quad (four areas), Hexa (six areas), or Octal (eight areas)

* The number of areas is automatically selected based on the number of displayed waveforms.



The number of displayed points per area varies depending on how many areas the window is divided into.

The vertical resolution does not change even if the number of displayed points is different.

The number of displayed points when only the Main window is displayed is as follows:

Single: 640 points, Dual: 320 points, Triad: 208 points, Quad: 160 points, Hexa: 104 points, Octal: 80 points

Waveform Mapping (Mapping)

You can specify how channels are mapped to the divided areas.

- **Auto**

The waveforms whose display is turned on are mapped in order starting with the top area.

- **Manual**

You can map each waveform to the area of your choice.

You can map all waveforms regardless of whether or not their displays are turned on.

Color (Color)

Intensity (Intensity Graticule)

You can set the intensity of the grid (Grid), zoom box (Zoom Box), cursor (Cursor), and marker (Marker).

Selectable range: 0 to 31

Waveform Color (Waveform)

You can select the waveform display color separately for CH1 to CH8/LOGIC(L)/State(L), Math1 to Math4, LOGIC(A|B), and State(A|B) from the available 16 colors.

- * The waveform display color for CH8 can be selected only when the CH8 key is illuminated, and the colors for LOGIC(L) and State(L) can be selected only when the L key is illuminated. For State(L) and State(A|B), set the color for when the logic signal state display is turned on. LOGIC(A|B) and State(A|B) are available on models with the /L16 option.

Serial Bus Trend Color (Serial Bus Trend)

The DLM4000 has a function that analyzes and decodes certain serial bus signals and displays the trend of the results. You can select the color of each trend from 16 colors.

For details on the analysis, decoding, and trend display of serial bus signals, see chapter 15, "Analyzing and Searching Serial Bus Signals." ► [See here.](#)

Initialization

Intensity and color can be reset to default values.

- To reset the intensity of the grid, zoom box, cursor, or marker to its default value, select the item that you want to reset, and then press RESET.
- To reset the colors of the waveform and serial bus trend, press DEFAULT SETUP. However, be careful as pressing DEFAULT SETUP will also reset other settings to their factory default values. ► [See here.](#)

Display Interpolation (Dot Connect)

When the number of data points is within the interpolation zone,* the DLM4000 displays waveforms by interpolating between sampled data points.

- * Interpolation zone refers to the condition in which a given number of data points are not contained in the 10 divisions along the time axis. The number of data points that define the interpolation zone varies depending on the display record length and zoom ratio.

You can set the interpolation method to one of the settings below.

- **Sine (Sine Interpolation)**

Interpolates a sine curve between two points using the $(\sin x)/x$ function. This method is suitable for the observation of sine waves.

- **Line (Linear Interpolation)**

Linearly interpolates between two points.

- **Pulse (Pulse Interpolation)**

Interpolates between two points in a staircase pattern.

- **OFF**

Displays the data using dots without interpolation.

When the Number of Displayed Waveform Data Points Is Not in the Interpolation Zone

If the interpolation method is set to Sine, Line, or Pulse, the dots are connected vertically.

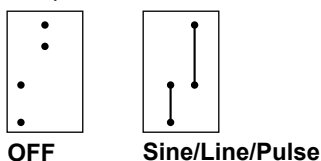

When the Number of Displayed Waveform Data Points Is in the Interpolation Zone

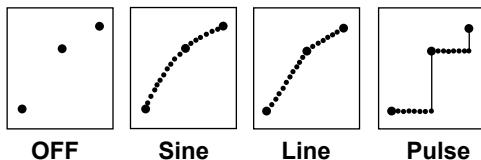

The interpolation method is set to Pulse when:

- The input signal is a logic signal.
- The acquisition mode is Envelope.
- The sampling mode is Repetitive Sampling.

Graticule (Graticule)

Set the window grid to one of the settings below.

- Dot Grid: Displays the grid using broken lines
- Line Grid: Displays the grid using solid lines
- Frame: Displays a frame
- Cross Hair: Displays the grid using crosshairs

Fine Grid Display (Fine Grid)

You can set whether or not to display the fine grid.

- ON: Displays the fine grid
- OFF: Does not display the fine grid

Scale Value Display (Scale Value)

You can display the upper and lower limits (scale values) of each waveform's vertical or horizontal axes.

- ON: Displays the scale values
- OFF: Does not display the scale values

Accumulate (Accumulate)

Normally, the DLM4000 acquires and displays waveforms at each screen update interval. The waveform update rate (acquisition rate) is up to 60 times per second.

When you turn the accumulate feature on, the DLM4000 acquires waveforms at a rate independent of the screen update interval and accumulates them on the screen. The waveform update rate in this case is up to 20000 times per second.

The accumulated waveforms are displayed with gradually decreasing intensity for the specified amount of time. The accumulated display can be used to increase the waveform acquisition rate and retain waveforms of infrequent phenomenon on the screen for a certain amount of time.

Gradation Mode

You can set the gradation mode to one of the settings below. Gradation is not applicable to logic signals.

- **Intensity**

Indicates frequency using different intensity levels. You can set the level in the range of 1 to 64.

- **Color**

Indicates frequency using different colors. Indicates 15 frequency levels using different colors that range from blue to green to yellow to red to white starting with the lowest frequency.

- **OFF**

Does not accumulate waveforms.

Accumulation Time (Accum Time)

Sets the amount of time to retain waveforms on the screen.

Selectable range

100 ms to 100 s, or Infinite (Infinite)



-
- If you press CLEAR TRACE, the accumulated waveforms are cleared.

Notes about Waveform Accumulation

- Automated measurement of waveform parameters and GO/NO-GO determination are performed on the most recent waveform.
- If you press RUN/STOP to stop waveform acquisition, accumulation stops. When you restart waveform acquisition, all the waveforms are cleared, and accumulation starts from the beginning.
- If the DLM4000 does not trigger when the trigger mode is set to Normal, the waveform intensity is retained until the next time the DLM4000 triggers.
- If you change the display format when accumulated waveforms are displayed, the DLM4000 operates in the following manner.

During accumulation: The DLM4000 clears the screen and restarts from the beginning.

When accumulation is stopped: The DLM4000 clears the waveforms and displays the most recent waveform.

8 Displaying XY Waveforms

You can view the correlation between two input signal levels by assigning the level of a waveform to the X-axis (horizontal axis) and assigning the level of another waveform to the Y-axis (vertical axis). XY waveforms appear in the XY window.

You can perform cursor measurements on and determine the area of the displayed XY waveform. You can view XY waveforms and normal VT waveforms simultaneously.

For example, you can use the XY waveform display to measure the area of safe operation (SOA) of switching elements.

You can set up to four XY waveforms (XY1 to XY4).

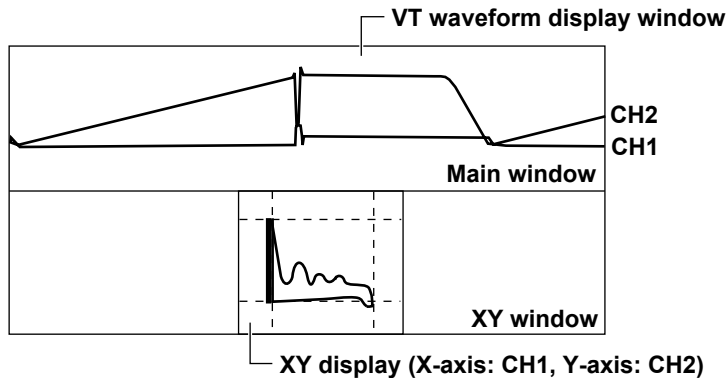

Turning the XY Waveform Display On and Off (Display)

Sets whether or not to measure and display XY waveforms. If you set this to ON, the XY window appears.

- ON: Displays and measures XY waveforms
- OFF: Does not display or measure XY waveforms

X-Axis and Y-Axis Source Waveforms (X Trace/Y Trace)

Select the waveforms to assign to the X-axis and Y-axis of XY1, XY2, XY3, and XY4 from the following:

- Waveforms to assign to XY1 and XY2: CH1 to CH4, Math1, Math2
- Waveforms to assign to XY3 and XY4: CH5 to CH8, Math3, Math4

Configuring the Display (Display Setup)

Displaying the VT Waveforms (VT Display)

Sets whether or not to display XY waveforms along with the VT waveforms.

- ON: Displays the VT waveform display window
- OFF: Does not display the VT waveform display window

Split Display (Split)

Set whether to display the four XY waveforms in two windows.

- ON: The four waveforms are displayed in two windows. XY1 to XY4 waveforms whose display is turned on are displayed in order starting with the left XY window, then the right XY window, then the left XY window, and so on.
- OFF: The four waveforms are not displayed in two windows. XY1 to XY4 waveforms are displayed in the same window.



If you press DISPLAY, ZOOM1, or ZOOM2 when the VT waveform display (VT Display) is OFF, the VT waveform display window turns on.

Display Area (T Range1/T Range2)

Sets the start point (T Range1) and the end point (T Range2) of the display and the measurement range.
Selectable range: ± 5 divisions with the center of the target window taken to be 0 divisions.

Measurement (Measure Setup)

Configures settings for cursor measurement and area calculation.

OFF

Disables measurement.

Cursor Measurement (Cursor)

You can display two cursors on both the X and Y axes and measure with them simultaneously.

- **Vertical cursor**

You can measure the X-axis values for Cursor1 and Cursor2. You can set the cursors in the range of ± 4 divisions in 0.01-division steps.

- **Horizontal cursor**

You can measure the Y-axis values for Cursor1 and Cursor2. You can set the cursors in the range of ± 4 divisions in 0.01-division steps.

- **Measurement Item (Item)**

The DLM4000 measures the values of the items listed below that you select.

X1: X axis value at Cursor1

Y1: Y axis value at Cursor1

X2: X axis value at Cursor2

Y2: Y axis value at Cursor2

ΔX : Difference between the X1 and X2 values

ΔY : Difference between the Y1 and Y2 values

Area (Integ)

Determines the total areas of the XY1 and XY2 waveforms. You can set the loop and polarity for each XY waveform.

- **Loop**

Sets the method of determining the area to Open (total trapezoidal area) or Close (total triangular area).

- **Polarity**

Selects which direction to make positive, CW (clockwise) or CCW (counterclockwise).

9 Computed and Reference Waveforms

The DLM4000 can display up to four computed or reference waveforms (Math/Ref1 to Math/Ref4).

Computation Mode (Mode)

Select the waveforms to display as Math/Ref1 to Math/Ref4 from the following:

- OFF: Does not display computed or reference waveforms
- Math: Displays computed waveforms
- Ref: Displays reference waveforms



When the state display of logic signal LOGIC(L) is on, Math4/Ref4 cannot be used.

Computation Source Waveforms (Source1/Source2)

If you set the computation mode to Math, you can select the computation source waveforms for Math/Ref1 to Math/Ref4 from one of the settings below. Depending on the operator, you may need to select only Source1 or Source1 and Source2.

- Math1 (Math/Ref1): CH1 to CH4
- Math2 (Math/Ref2): CH1 to CH4, Math1
- Math3 (Math/Ref3): CH5 to CH8
- Math4 (Math/Ref4): CH5 to CH8, Math3



-
- For Math1 to Math4 on the standard model, the maximum record length that computation can be performed over is 6.25 Mpoints. The record length is 25 Mpoints on models with the /M1 option, 62.5 Mpoints on models with the /M2 option, and 125 Mpoints on models with the /M3 option.
 - If Math2 includes Math1 in its equation, Math2 will be invalid under the following conditions.
 - When the computation mode of Math1 is OFF
 - When the Math1 operator is set to User Define but the Math2 operator is not
- Math4 and Math3 also have the same limitations as Math2 and Math1.
-

Reference Waveforms

If you set the computation mode to Ref, you can display reference waveforms. The following waveforms can be used as reference waveforms.

- Waveforms displayed on the screen: You can load waveforms using the Load from soft key.
- Waveforms saved in the past: You can load waveforms using the load feature of the FILE menu.

Loading the Reference Waveform (Load from)

If you set the computation mode to Ref, you can select the reference waveforms for Math/Ref1 to Math/Ref4 from one of the settings below. The maximum number of data points that can be loaded is 12.5 Mpoints. Data that exceeds 12.5 Mpoints are loaded through sampling.

- Ref1 (Math/Ref1): CH1 to CH4
- Ref2 (Math/Ref2): CH1 to CH4, Math1
- Ref3 (Math/Ref3): CH5 to CH8
- Ref4 (Math/Ref4): CH5 to CH8, Math3

9 Computed and Reference Waveforms

Measurement and Computation Using Reference Waveforms

- If a reference waveform is displayed and you set the measurement source of cursor measurement or automated measurement of waveform parameters to Math1 to Math4, you can perform cursor measurement or automated measurement of waveform parameters on the reference waveform.
- If reference waveform Ref1 is displayed and you set the computation source waveform of Math2 to Math1, you can perform computation using reference waveform Ref1. Likewise, if reference waveform Ref3 is displayed and you set the computation source waveform of Math4 to Math3, you can perform computation using reference waveform Ref3.

Vertical Position (Position)

You can move the reference waveform vertical position within ± 4 divisions.



- In computation where the time axis is different between the reference waveform and input waveform, the DLM4000 interpolates or compresses the reference waveform data so that the number of data points for both waveforms is the same.
 - You cannot change the reference waveform time axis.
 - During computation of the input waveform and reference waveform, if you stop waveform acquisition and change the TIME/DIV setting, the DLM4000 cannot display the computed waveform.
 - Reference waveforms whose record length is 1.25 Mpoints or less are backed up when they are loaded. However, if you turn on the DLM4000 while holding down the RESET key, the settings are set to their factory defaults, and the reference waveforms are cleared.
 - To load a file that contains waveform data of multiple channels as a reference waveform, use Load to Channels on the menu for loading waveform data from files into channels, and then load a waveform as a reference waveform.
 - The waveforms that have been acquired at the maximum record length and the waveform data that has been acquired at the maximum record length and saved to files cannot be loaded as a reference waveform.
 - If you change the reference waveform vertical position when the record length is set such that waveform acquisition operates in Single mode, the change does not take effect until the DLM4000 triggers.
-

Operators (Operation)

The following operators are available.

- $S1+S2$: Adds the waveforms assigned to Source1 and Source2
- $S1-S2$: Subtracts the waveform assigned to Source2 from the waveform assigned to Source1
- $S1 \times S2$: Multiplies the waveforms assigned to Source1 and Source2
- **Filter(S1)**: Performs phase shifting, moving average, or noise rejection on the waveform assigned to Source1
- **Integ(S1)**: Integrates the waveform assigned to Source1
- **Count(S1)**: Counts the number of edges of the waveform assigned to Source1 or the number of phase changes between the two waveforms assigned to Source 1 and Source2.
- **User Define**: User-defined expression (/G2 or /G4 option)

Addition, subtraction, and multiplication ($S1+S2$, $S1-S2$, $S1 \times S2$)

Performs addition, subtraction, or multiplication on the two waveforms assigned to Source1 and Source2.

IIR Filter, Smoothing (Filter(S1))

Performs phase shifting or moving average on the waveform assigned to Source1 or applies an IIR filter to the waveform.

Selecting the Filter Type (Filter Setup)

Set the filter type to one of the settings below.

- **Delay**: Displays a phase-shifted waveform
- **Moving Avg**: Displays a waveform whose noise has been eliminated through moving averaging
- **IIR Lowpass or IIR Highpass**: Displays a waveform whose noise has been eliminated through an IIR filter

Phase Shifting (Delay)

Displays a waveform that has been phase-shifted by the specified amount of time.

- **Delay (Delay)**

Set the amount of time to shift the phase.

Selectable range: Time corresponding to ± 5 divisions

The resolution is 1/sample rate.



The specified delay is retained even if you change the TIME/DIV setting, unless the change causes the specified delay to exceed the amount of time corresponding to ± 5 divisions.

Smoothing (Moving Avg)

The DLM4000 averages the waveforms according to the following equation. Set the number of points to use for moving averaging.

$$X_n = \left(\sum_{i=n-N}^{n+N-1} x_i + \sum_{i=n-N+1}^{n+N} x_i \right) / (2N \times 2)$$

(when the weight is set to 2N)

- **Weighted Points (Weight)**

Set the number of points to use for moving averaging.

Selectable range: 2 to 128 in 2^n steps

IIR Filter (IIR Lowpass/IIR Highpass)

Set the filter order and cutoff frequency for the low-pass filter or high-pass filter.

- IIR Lowpass: Rejects high-frequency noise
- IIR Highpass: Rejects low-frequency noise

- **Filter order (Order)**

Select 1st order or 2nd order. Depending on the filter type and filter order that you select, the phase change varies as follows:

Filter Type	Order	Phase Change
Low Pass	1	Phase lag
High Pass	1	Phase lead
High Pass/Low Pass	2	No phase change

- **Cutoff frequency (Cutoff1)**

You can set the cutoff frequency to a value up to 500 MHz.



- In the filter calculation (IIR filter), because the initial value is indeterminate, correct calculation is not possible immediately after the start of calculation. With a first-order filter the left end of the waveform is not shown, and with a second-order filter, both ends of the waveform are not shown.
- The lower cutoff frequency limit varies depending on the time-axis setting.

Integration (Integ(S1))

Integrates the waveform assigned to Source1.

The DLM4000 integrates with the initial point (Initial Point) set to zero.

Edge Count or Rotary Count (Count(S1))

The DLM4000 counts edges or rotations of the waveforms assigned to Source1 and Source2.

Count Setup (Count Setup)

Count Type (Type)

Select the count type from one of the settings below.

- Edge: Counts the number of edges of one waveform
- Rotary: Counts the number of phase changes between two waveforms.

Edge Count (Edge)

With the computation initial point (Initial Point) counted as zero, the DLM4000 counts the number of times the waveform specified as Source1 passes through the detection level.



- **Detection Level (Threshold)**

Set the level used to detect edges.

Selectable range: ± 10 divisions

- **Slope (Slope)**

Select which waveform slope the DLM4000 will detect edges on.

- | | |
|---|---|
|  | Detected when the waveform slope is rising |
|  | Detected when the waveform slope is falling |

- **Hysteresis (Hysteresis)**

Set a width to the detection level so that the DLM4000 does not detect edges on small fluctuations in the waveform.

Selectable range: 0.0 to 4.0 divisions

Resolution: 0.1 divisions

Rotary Count (Rotary)

The DLM4000 counts up or down depending on the phase change* in the waveforms assigned to Source1 (phase A) and Source2 (phase B). The DLM4000 counts phase changes with the computation initial point (Initial Point) counted as zero.

* When a source waveform goes above the specified threshold level, the state is considered to be 1; when it goes below the specified threshold level, the state is considered to be 0.

- **Relationship between State Transitions and Counting**

As shown in the figure below, the DLM4000 counts up (+1) or counts down (-1) depending on the phase change (change in state between 0 and 1) of phase A and phase B.

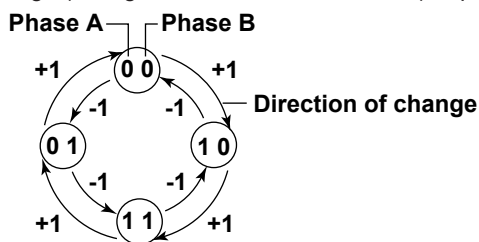

Counting Example

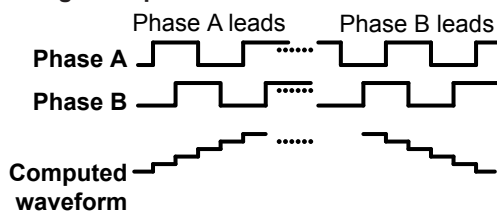

- **Threshold Level (Threshold1 and 2)**

Set the level used to determine waveform state changes separately for phase A and phase B.

Selectable range: ± 10 divisions

Initial Point (Initial Point)

Set the initial point when integrating, counting edges, or counting rotations. The DLM4000 integrates and counts by assuming the initial point to be zero.

You can set the initial point numerically or set it to a specific point such as the trigger position or 0 divisions.

Selectable range: -5.00 to 5.00 divisions

Resolution: 0.01 divisions

Setting a Specific Point (Set to)

You can set the initial point to any of the following points.

Trigger Pos (trigger position), -5.00 divisions, 0.00 divisions, Zoom1 (the center of Zoom1), or Zoom2 (the center of Zoom2)

Setting Labels and Units (Label/Unit)

Turning Labels On and Off (Display)

- ON: Displays labels
- OFF: Does not display labels

Label (Name)

You can set computation or reference waveform labels that appear when the label display is turned on. You can use up to eight characters for labels.

Unit

If the computation mode is Math, you can assign a unit to computation results.

• Auto

Uses the default unit. The unit varies depending on the type of computation.

Filter, addition, subtraction, multiplication, or division	V, A, VV, AA, and VA
Integration	Vs, As, VVs, AAs, and VAs
Edge count or rotary count	Blank
User-defined computation	EU

• User Define

You can assign a unit (User Unit) using up to four characters.

Scaling (Ranging)

If the computation mode is Math, you can select how to set the vertical display range of computed waveforms from one of the settings below.

When using user-defined computation (option), the method is set to Auto.

Auto (Auto Scaling)

From the computed waveform, the DLM4000 automatically determines the sensitivity (Sensitivity)² and the level¹ at the vertical center (Center) of the screen area.

Manual (Manual Scaling)

Set the sensitivity (Sensitivity)² and the level¹ at the vertical center (Center) of the screen area.

- 1 Voltage for a voltage waveform.
- 2 Voltage per division for a voltage waveform.



If you change the operator during manual scaling, the DLM4000 changes the display range to the auto display range that corresponds to the new operator. Ranging remains set to Manual.

User-Defined Computation (User Define, Option)

You can define four original expressions.

Expression (Expression)

Define an expression by combining computation source waveforms and operators.

You can enter up to 128 characters.

Computation Source Waveform

Menu Item	Description
C1 to C8	CH1 to CH8
M1	Math1 waveform (can be used in Math2, Math3, and Math4)
M2	Math2 waveform (can be used in Math3 and Math4)
M3	Math3 waveform (can be used in Math4)
Bus, Bus2, and Bus3	Can be used only with the DA operator.
T	Amount of time elapsed from the screen's left edge

* Bus2 and Bus3 are available on models with the /L16 option.

Operators

You can combine the following operators to define expressions.

Menu Item	Example	Description
Basic functions		
+, -, *, /	C1+C2-C3	Basic arithmetic of the input value
ABS	ABS(C1)	Absolute value of the input value
SQRT	SQRT(C2)	Square root of the input value
LOG	LOG(C1)	Logarithm of the input value
LN	LN(C1)	Natural logarithm of the input value
EXP	EXP(C1)	Exponent of the input value
P2	P2(C1)	Square of the input value
-	-(C1)	Inversion of the input value around level 0
Trigonometric functions		
SIN	SIN(C1)	Sine of the input value
ASIN	ASIN(C1)	Arc sine of the input value
COS	COS(C1)	Cosine of the input value
ACOS	ACOS(C1)	Arc cosine of the input value
TAN	TAN(C1)	Tangent of the input value
ATAN	ATAN(C1)	Arc tangent of the input value
PH	PH(C1,C2)	Phase difference between two input values
Differentiation and integration		
DIFF	DIFF(C1)	Derivative of the input waveform
INTEG	INTEG(C1)	Integral of the input waveform
Filter functions		
FILT1	FILT1(C1)	Application of a digital filter to the input waveform
FILT2	FILT2(C1)	Application of a digital filter to the input waveform
HLBT	HLBT(C1)	Hilbert function of the input waveform
MEAN	MEAN(C1,10)	Moving average of the input waveform
DELAY	DELAY(C1,0.001)	Phase shifting of the input waveform
BIN	BIN(CH1,1,-1)	Conversion of the input waveform into binary values
Pulse width functions		
PWHH	PWHH(C1,1,-1)	Pulse width computation of the input waveform from one rising edge to the next rising edge
PWHL	PWHL(C1,1,-1)	Pulse width computation of the input waveform from a rising edge to the next falling edge
PWLH	PWLH(C1,1,-1)	Pulse width computation of the input waveform from a falling edge to the next rising edge
PWLL	PWLL(C1,1,-1)	Pulse width computation of the input waveform from one falling edge to the next falling edge
PWXX	PWXX(C1,1,-1)	Pulse width computation of the input waveform from one rising or falling edge to the next rising or falling edge
FV	FV(C1,1,-1)	Inverse of the computed pulse width PWHH
DUTYH	DUTYH(C1,1,-1)	Duty ratio of the high side of each period of the input waveform
DUTYL	DUTYL(C1,1,-1)	Duty ratio of the low side of each period the input waveform
D/A conversion		
DA	DA(Bus)	D/A conversion of a logic waveform

9 Computed and Reference Waveforms

Constants

Menu Item	Description
K1 to K4	Constant
0 to 9	–
Exp	E notation Used to enter a number in scientific notation in expressions (1E+3 = 1000, 2.5E-3 = 0.0025) Displayed as “E” in expressions to distinguish this from the “EXP” operator.
PI	Pi (π)
e	Euler's constant (Napier's constant) Base of the natural logarithm ($e = 2.71828\dots$) Displayed as “eul” in expressions to distinguish this from the “E” that represents exponents.
fs	Sample rate DLM4000 sample rate when the computation was executed. The value changes according to the changes in the time axis or record length setting.
1/fs	Number of samples per second Computed based on the DLM4000 sample rate when the computation was executed. The value changes according to the changes in the time axis or record length setting.
Measure	A waveform parameter value can be used. Example: P.Max(C1)

Automated Measurement Values of Waveform Parameters (Measure)

You can use the automated measurement values of waveform parameters in expressions.

- “P.” precedes waveform parameters when waveform parameters are displayed in expressions.
- The DLM4000 cannot retrieve waveform parameter values when the measurement source waveform display is off.



D/A conversion can be specified only when the computation source waveform is Bus. The computation result will be the same as the bus display (Hex) value.

Computation Conditions (Setup)

Configure constants (K1 to K4) and the digital filter, and turn computation averaging on or off.

Constant Definitions (Const Setup)

Set a value for K1 to K4.

Selectable range: $-10E+30$ to $10E+30$

Digital Filter Definitions (Filter1/Filter2)

When using FILT1 or FILT2 in user-defined computation, set the digital filter's filter type, frequency band, and cutoff frequency.

- **Filter Type (Type)**

Select the filter from one of the settings below.

- IIR: Non-linear phase. Achieves adequate cutoff characteristics even at relatively low orders.
- FIR: Linear phase. Takes longer than IIR to process.

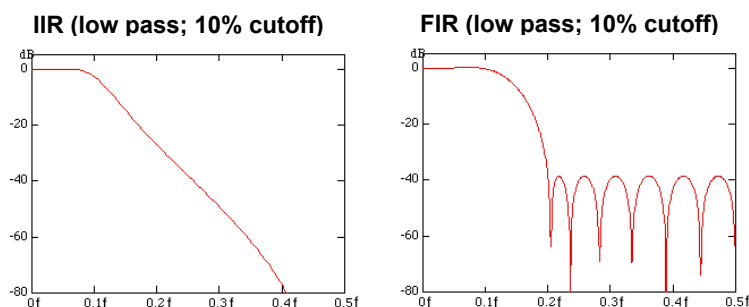

- **Frequency Band (Band)**

You can set the frequency band to one of the settings below.

- LowPass
- BandPass
- HighPass

- **Cutoff frequency (Cutoff1/Cutoff2)**

Set the cutoff frequency separately for Filter1 and Filter2.

Selectable range: 2.0% to 30.0% of the sampling frequency

Resolution: 0.2% of the sampling frequency

- **Averaging on Computation (Average)**

Set whether or not to linearly average the user-defined computation data. This setting applies to Math1 to Math4.

- ON: Averages computed data
- OFF: Does not average computed data

- **Average Count (Avg Count)**

Selectable range: 2 to 1024 in 2^n steps



- If you change the computation conditions while averaging on computation is on, the computed data up to that point is cleared.
 - Averaging on computation cannot be used if the trigger mode is set to N SINGLE.
 - You cannot average computations during waveform acquisition.
 - You cannot average computations that are recomputed after waveform acquisition.
-

Computation on History Waveforms (Math on History)

This feature performs computation on all history waveforms.

If waveform acquisition is stopped and you press the Math on History soft key, the DLM4000 performs user-defined computation on all of the source channel's history waveforms.

Auto Ranging (Auto Ranging)

Executes auto scaling. Use this feature when the computed waveform amplitude changes greatly and it is difficult to view the waveform.

You can also set the display range by specifying the vertical center (Center) of the display area and the value per division (Sensitivity).



- You cannot execute [Math on History] during waveform acquisition.
 - While [Math on History] is in progress, the “computing” icon and progress bar appear at the top of the screen. All operations except for that of the Abort soft key are invalid.
 - If you set the trigger mode to N Single and start waveform acquisition, the DLM4000 performs user-defined computation on the last waveform after waveform acquisition stops. To perform user-defined computation on all history waveforms, execute [Math on History].
 - If you change a setting that would affect the result of user-defined computation, the DLM4000 only recomputes on the selected history waveform.
 - If an error occurs in the average display or statistical processing of a history waveform, execute [Math on History].
-

Examples of Expressions

For each operator, correct expressions and easily mistaken expressions are listed. Examples of mistakes are shown with gray background.

DIFF and INTEG (differentiation and integration) Examples

Syntax: DIFF(parameter), INTEG(parameters)

Parameter: Enter a waveform or an expression that contains waveforms.

DIFF(C1/3)	Derivative of the C1/3 waveform
INTEG(INTEG(C3))	Double integral of the C3 waveform
DIFF(DIFF(C4))	Double derivative of the C4 waveform
DIFF(5)	Not allowed because the parameter is a constant
INTEG(K1+10)	Not allowed because the parameter is a constant expression

FILT1 and FILT2 (Digital Filter) Examples

Syntax: FILT1(parameter), FILT2(parameter)

Parameter: Enter a waveform or an expression that contains waveforms.

FILT1(C1+C2)	Digital filtering of the C1+C2 waveform
FILT1(C3+K1)	Digital filtering of the C1+K1 waveform
FILT1(5)	Not allowed because the parameter is a constant
FILT2(K1+10)	Not allowed because the parameter is a constant expression

* The digital filters must be defined. Set digital filters on the Setup menu that appears when you select user-defined computation. ► [See here.](#)

MEAN (Moving Average) Examples

Syntax: MEAN(parameter 1, parameter 2)

Parameter 1: Set the source waveform of the moving average. Enter a waveform or an expression that contains waveforms.

Parameter 2: Set the moving average coefficient. Enter a constant or a constant expression.

MEAN(C1,10)	Moving average of waveform C1 with the coefficient set to 10
MEAN(C2+C3,K1)	Moving average of the C2+C3 waveform with the coefficient set to K1
MEAN(5,10)	Not allowed because parameter 1 is not a waveform or an expression that contains waveforms
MEAN(C1,C2)	Not allowed because parameter 2 is not a constant or a constant expression

DELAY (Phase Shift) Examples

Syntax: DELAY(parameter 1, parameter 2)

Parameter 1: Set the waveform to phase-shift. Enter a single waveform.

Parameter 2: Set the amount of phase shift. Enter a constant or a constant expression.

DELAY(C1,5E-3)	Phase-shift waveform C1 by 0.005 s
DELAY(C2,P.Period(C2)*2)	Phase-shift waveform C2 by 2 periods of waveform C2
DELAY(C1,C2)	Not allowed because parameter 2 is not a constant or a constant expression
DELAY(C1+C2,5)	Not allowed because parameter 1 is not a single waveform

BIN (Conversion into Binary Values) Examples

Syntax: BIN(parameter 1, parameter 2, parameter 3)

Parameter 1: Set the waveform to convert into binary values. Enter a waveform or an expression that contains waveforms.

Parameter 2: Set the upper threshold level. Enter a constant or a constant expression.

Parameter 3: Set the lower threshold level. Enter a constant or a constant expression.

BIN(C1+C2,10+K1/2,10-K1/2)	Convert the C1+C2 waveform into binary values with Upper set to 10+K1/2 and Lower set to 10-K1/2
BIN(C2,P.High(C2),P.Low(C2))	Convert waveform C2 into binary values with Upper set to waveform C2's high value and Lower set to waveform C2's low value.
BIN(5,10,2)	Not allowed because parameter 1 is not a waveform or an expression that contains waveforms
BIN(C1,C2,-1)	Not allowed because parameter 2 is not a constant or a constant expression

PWHH to DUTYL (Pulse Width Computation) Examples

Syntax: PWHH(parameter 1, parameter 2, parameter 3)

Parameter 1: Set the waveform to compute the pulse width of. Enter a single waveform.

Parameter 2: Set the upper threshold level. Enter a constant or a constant expression.

Parameter 3: Set the lower threshold level. Enter a constant or a constant expression.

PWHH(C1,K1,K2)	Compute the pulse width of waveform C1 with Upper set to K1 and Lower set to K2
DUTYL(C2,P.High(C2),P.Low(C2))	Compute the pulse width of waveform C2 with Upper set to waveform C2's high value and Lower set to waveform C2's low value.
PWHH(5,10,2)	Not allowed because parameter 1 is not a waveform
PWHL(C1,C2,-1)	Not allowed because parameter 2 is not a constant or a constant expression
PWLL(C1+C2,1,-1)	Not allowed because parameter 1 is not a single waveform

DA (D/A Conversion) Examples

Syntax: DA(parameter 1)

Parameter 1: Set the source waveform for DA computation. Enter Bus. This can be executed only when the L key is illuminated.

DA(Bus)	D/A conversion of a logic waveform
---------	------------------------------------

Examples of Other Operators

Syntax: Operator(parameter)

Parameter: Specify a waveform, a constant, or an expression.

SIN(PI)	Example in which the parameter is set to a constant
COS(C1)	Example in which the parameter is set to a waveform
ABS(C1+C2*2)	Example in which the parameter is set to an expression that consists of waveforms and a constant
SQRT(ABS(C1+C2*2))	Example in which the parameter is set to an expression
SIN(2*PI*T+K1)	Example in which the parameters is set to an expression (that consists of elapsed time T and constants)

9 Computed and Reference Waveforms

Combinations of Operators That Are Not Allowed

Example: Math1=M2+C3

You cannot enter M2 (Math2) in the expression of Math1

Example: FILT1(C1)+FILT1(C2)+FILT1(C3)

An expression can only contain up to two FILT1 or FILT2 functions.

Example: PWHH(C1, 1, 0)+C2

Computation cannot be performed on a computed pulse width.

Example: PWHH(C1*C2, 0, 0)

When computing pulse width, the source waveform can only be a single waveform.



- Averaging cannot be performed on pulse width computation.
 - If you want to compute the pulse width on a computed result, such as C1+C2, set expressions in the following manner: Math1 = C1+C2, Math2 = PWHH(M1, 1, -1).
-

10 FFT

The DLM4000 can determine up to two input waveform power spectrums (FFT1 and FFT2). On models with the user-defined feature (option), the DLM4000 can determine the linear spectrum, rms power spectrum, power spectrum, cross spectrum, transfer function, and coherence function.

FFT waveforms appear in the FFT window.

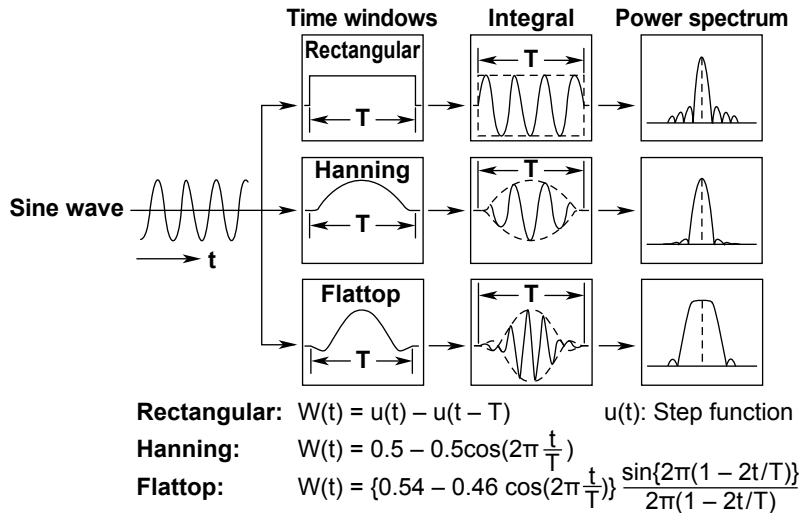

Turning the FFT On or Off (Display)

Set whether or not to perform FFT analysis. If you set this to ON, the FFT window appears.

- ON: Performs FFT analysis
- OFF: Does not perform FFT analysis

Analysis Source Waveform (Trace)

You can select from one of the settings below.

CH1 to CH8, Math1 to Math4

FFT Conditions (FFT Setup)

Configure the time window and how to display FFT waveforms (normal, peak hold, or average).
On models with user-defined computation (option), you can also select the spectrum to analyze.

Spectrum Type (Type/Sub Type)

On models with user-defined computation (option), you can also select the spectrum to analyze from the following:

Spectrum	Description	Unit (Default value)
LS-MAG	Magnitude of the specified waveform's linear spectrum	Source unit
LS-LOGMAG	Logarithmic magnitude of the specified waveform's linear spectrum	dB and source unit
LS-PHASE	Phase of the specified waveform's linear spectrum	Degrees
LS-REAL	Real part of the specified waveform's linear spectrum	Source unit
LS-IMAG	Imaginary part of the specified waveform's linear spectrum	Source unit
RS-MAG	Rms power spectrum magnitude	Source unit
RS-LOGMAG	Rms power spectrum logarithmic magnitude	dB and source unit
PS-MAG	Magnitude of the specified waveform's power spectrum	Enumeration of source units
PS-LOGMAG	Logarithmic magnitude of the specified waveform's power spectrum	dB and source unit
PSD-MAG	Magnitude of the specified waveform's power spectrum density	Enumeration of source units
PSD-LOGMAG	Logarithmic magnitude of the specified waveform's power spectrum density	dB and source unit
CS-MAG	Magnitude of the cross spectrum of the specified two waveforms	Enumeration of source units
CS-LOGMAG	Logarithmic magnitude of the cross spectrum of the specified two waveforms	<ul style="list-style-type: none"> • If the source units are the same: dB and source unit • If the source units are different: dB
CS-PHASE	Phase of the cross spectrum of the specified two waveforms	Degrees
CS-REAL	Real part of the cross spectrum of the specified two waveforms	Enumeration of source units
CS-IMAG	Imaginary part of the cross spectrum of the specified two waveforms	Enumeration of source units
TF-MAG	Magnitude of the transfer function of the specified two waveforms	None
TF-LOGMAG	Logarithmic magnitude of the transfer function of the specified two waveforms	dB
TF-PHASE	Phase of the transfer function of the specified two waveforms	Degrees
TF-REAL	Real part of the transfer function of the specified two waveforms	None
TF-IMAG	Imaginary part of the transfer function of the specified two waveforms	None
CH-MAG	Magnitude of the coherence function of the specified two waveforms	None

Source unit:

There is no source unit when the LinearScale unit or Math unit is not set.

When the source unit is up to two characters in length, the source unit is used.

When the source unit is more than two characters in length, "EU" is used.

Time Window (Window)

Set the time window to one of the settings below.

- Rectangle (rectangular window)
- Hanning (Hanning window)
- Flattop (flattop window)

Waveform Display Mode (Mode)

Select how to display FFT waveforms from one of the settings below.

- Normal: Displays FFT waveforms for each acquisition
- Max Hold: For each frequency, the DLM4000 holds the maximum value among the values acquired from the start of analysis up to the current acquisition and displays it.
- Average: For each frequency, the DLM4000 displays the average of the values acquired from the start of analysis up to the current point.

Analysis Source Waveform (Trace2)

When the spectrum type is CS, TF, or CH, you can choose from the following options.

CH1 to CH8, Math1 to Math4

Unit Setting (Unit)

Select the unit type from one of the settings below.

- AUTO: The default unit is used. The unit varies depending on the type spectrum.
- User Define: You can assign a unit (User Unit) using up to four characters.

Number of FFT Points (FFT Point)

You can set the number of FFT points to one of the settings below.

1.25 k, 2.5 k, 12.5 k, 25 k, 125 k, or 250 k



Relationship between the Number of FFT Points and Number of Displayed Points (Display Record Length)

Depending on the number of displayed points in the window that you select using the analysis range (Time Range) setting, the actual number of FFT points may be different from the number of FFT points that you selected.

If the number of FFT points is less than the number of displayed points, the displayed points are sampled to match the number of FFT points. The FFT may not cover the entire display range.

If the number of FFT points is greater than the number of displayed points, the number of FFT points is adjusted to an appropriate number less than or equal to the number of displayed points.

Analysis Range (Time Range)

Set the analysis range to any of the following windows below.

- Main: Main window
- Zoom1: Zoom1 window
- Zoom2: Zoom2 window

Scale Value (Display Setup)

Set the vertical and horizontal scale values.

Vertical Scale (Vert.Scale)

Set the vertical scale to one of the settings below.

- Auto: Sets the vertical scale values automatically
- Manual: For manually setting the center (Center) of the horizontal axis and the value per division (Sensitivity)

Horizontal Scale (Horiz.Scale)

Set the horizontal scale to one of the settings below.

- Auto: Sets the center point and span automatically
- Center/Span: You must set the center point and span manually
- Left/Right: You must set the left and right ends of the scale manually

Displaying the Source Waveform (VT Display)

Select whether or not to display the FFT source waveform.

- ON: Displays the source waveform
- OFF: Does not display the source waveform

Cursor Measurement (Measure Setup)

You can analyze values on an FFT waveform using marker cursors and peak cursors.

Cursor Type (Mode)

Set the cursor that you want to use for analyzing to one of the settings below.

- OFF: Disables cursor measurement.
- Marker: Using two marker cursors, you can display frequencies, levels, and the difference between the markers.
- Peak: Using two peak cursors, you can display peak values (Peak1 and Peak2) and the difference between the peaks.

Marker Cursor (Marker)

The DLM4000 displays the frequencies and levels at the two marker cursors (Marker1 and Marker2). It can also display the difference between the cursors. Marker cursors move on the waveform data points.

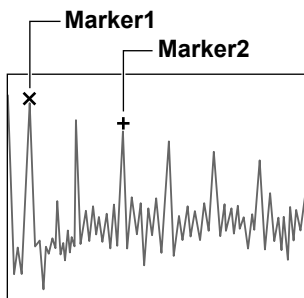

- **Measurement Item (Item)**

Set the measurement item to one of the settings below.

F1: Displays the Marker1 frequency

F2: Displays the Marker2 frequency

ΔF : Displays the frequency difference between Marker1 and Marker2

V1: Displays the Marker1 level

V2: Displays the Marker2 level

ΔV : Displays the level difference between Marker1 and Marker2

- **Marker Cursor Positions (Marker1/Marker2)**

Set the Marker1 and Marker2 positions.

Selectable range: ± 5.00 divisions

Peak Cursors (Peak)

Within each of the two frequency ranges (Peak1 Range1 to Range2 and Peak2 Range1 to Range2) that you specify, the DLM4000 determines the peak (Peak1 and Peak2) and displays the frequencies, levels, and the difference between the peak values.

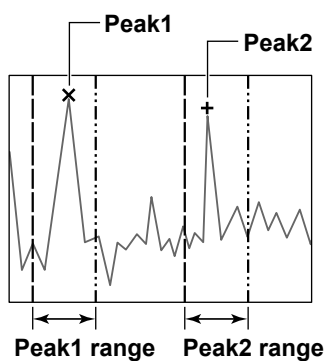

- **Measurement Item (Item)**

Set the measurement item to one of the settings below.

F(Peak1): Displays the Peak1 frequency

F(Peak2): Displays the Peak2 frequency

ΔF : Displays the frequency difference between Peak1 and Peak2

V(Peak1): Displays the Peak1 level

V(Peak2): Displays the Peak2 level

ΔV : Displays the level difference between Peak1 and Peak2

- **Measurement Range (Peak1 Range/Peak2 Range)**

Peak1 Range1 and Peak1 Range2: Set the Peak1 measurement range.

Peak2 Range1 and Peak2 Range2: Set the Peak2 measurement range.

Selectable range: ± 5.00 divisions

11 Cursor Measurement

You can move cursors on the waveforms displayed on the screen to view the measured values at the points where the cursors intersect the waveforms.

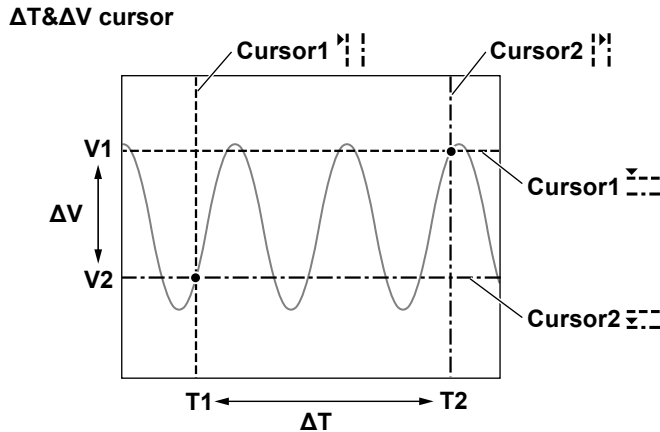

Turning Cursor Measurement On and Off (Display)

Sets whether or not to make measurements using cursors.

- ON: Turns cursor measurement on
- OFF: Turns cursor measurement off

Cursor Mode (Type)

There are five cursor modes.

- **ΔT cursors:** Two ΔT cursors are used to measure time values.
- **ΔV cursors:** Two ΔV cursors are used to measure vertical values.
- **ΔT & ΔV cursors:** Two ΔT cursors and two ΔV cursors are used to measure time-axis and vertical values.
- **Marker cursors (Marker):** Four marker cursors that move on the waveform are used to measure waveform values.
- **Angle cursors (Degree):** Two angle cursors are used to measure angles.

Measurement Source Waveform (Trace)

Set the measurement source waveform to one of the waveforms below.

CH1 to CH8/LOGIC(L), LOGIC(A|B), Math1 to Math4, or All

- * CH8 or LOGIC(L), whichever the corresponding key is illuminated (CH8 or L), can be selected. However, for ΔT , ΔT & ΔV , and marker cursors, CH8 can be selected even when the L key is illuminated.

If the source waveform is a logic signal (LOGIC), you can only use the ΔT cursors and angle cursors.

"All" specifies all channels. This setting is only available for ΔT cursors and angle cursors.



- Even when a waveform is selected as a measurement source waveform, if the source waveform is not displayed on the screen (the corresponding key is not illuminated), vertical cursor measurements are not performed.
- You cannot perform cursor measurement on snapshot waveforms or accumulated waveforms that have been acquired in the past. You can perform cursor measurement on the most recent accumulated waveform.
- For history waveforms, cursor measurement is performed on the waveform whose record number is selected.

ΔT Cursors (ΔT)

The ΔT cursors are two lines that are perpendicular to the time axis. You can use them to measure the time from the trigger position to each of the ΔT cursors, the time difference between the two cursors, and the inverse of the time difference between the two cursors. Cursor1 is a dashed line, and Cursor2 is a dot-dash line. You can also measure the vertical values at the points where the ΔT cursors intersect the waveforms.

Measurement Items (Item Setup)

You can measure the following time values at the cursor positions.

T1	Time value at Cursor1
T2	Time value at Cursor2
ΔT	Time difference between Cursor1 and Cursor2
1/ΔT	Inverse of the time difference between Cursor1 and Cursor2
V1	Vertical values at the points where Cursor1 intersects the waveforms*
V2	Vertical values at the points where Cursor2 intersects the waveforms*
ΔV	Difference in the vertical values at the points where Cursor1 and Cursor2 intersect the waveforms*

* If you set the measurement source waveform to All, values of all the measurement items are measured for CH1 through CH8 (or LOGIC(L)), LOGIC(A|B), and Math1 through Math4. LOGIC(A|B) is available on models with the /L16 option.

Example of Logic Signal Measurement

Measured values are displayed according to the settings on the LOGIC(L) or LOGIC(A|B) menu that appears when you press the L key or the A|B key (/L16 option).

- **Bus, Bus2, Bus3**

Bits are read according to the MSB-to-LSB order specified by bus bit assignments (Assignment). Measured values are displayed according to the format (Format) setting: binary (Bin) or hexadecimal (Hex).

- **L (L0 to L7), A|B(A0 to A7, B0 to B7)**

The measured values of bits (0 or 1) are displayed in order from the top of the screen according to the bit order (Bit Order) setting.

* Bus2, Bus3, and A|B are available on models with the /L16 option.

Bus (Bus) Bit Assignments (Assignment)

Consider the case when the L7, L6, L5, L4, L3, L2, L1, and L0 bits are assigned in order from the MSB to the LSB.

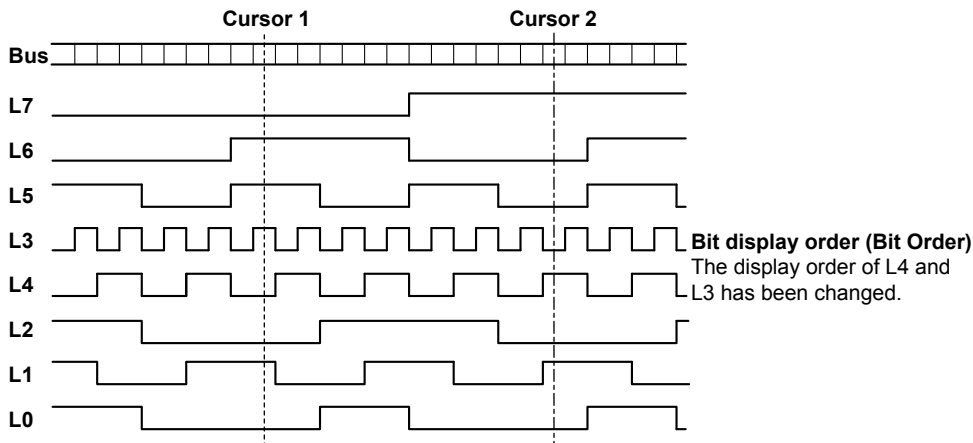

Measured values of Cursor1(V1) and Cursor2(V2)

When the format (Format) is binary (Bin):

V1(Bus) 01101010 [Bin] V2(Bus) 10010010 [Bin]
 V1(L) 01110010 [Bin] V2(L) 10001010 [Bin]

When the format (Format) is hexadecimal (Hex):

V1(Bus) 6A [Hex] V2(Bus) 92 [Hex]
 V1(L) 01110010 [Bin] V2(L) 10001010 [Bin]

(The order of the measured values above are different from what appears on the screen.)

ΔV Cursors (ΔV)

The ΔV cursors are two lines that are perpendicular to the vertical axis. You can use them to measure vertical values at the cursor positions. You can also measure the level difference between the two cursors. Cursor1 is a dashed line, and Cursor2 is a dot-dash line.

Measurement Items (Item Setup)

You can measure the following vertical values at the cursor positions.

V1	Vertical value at Cursor1
V2	Vertical value at Cursor2
ΔV	Difference in the vertical values at Cursor1 and Cursor2

ΔT & ΔV Cursors (ΔT & ΔV)

ΔT cursors and ΔV cursors are displayed at the same time.

Measurement Items (Item Setup)

You can measure the following time and vertical values at the cursor positions.

Time axis (ΔT cursors)	
T1	Time value at Cursor1
T2	Time value at Cursor2
ΔT	Time difference between Cursor1 and Cursor2
$1/\Delta T$	Inverse of the time difference between Cursor1 and Cursor2
Vertical axis (ΔV cursors)	
V1	Vertical value at Cursor1
V2	Vertical value at Cursor2
ΔV	Difference in the vertical values at Cursor1 and Cursor2

Marker Cursors (Marker)

Four markers are displayed on the selected waveform. You can measure the level at each marker, the amount of time from the trigger position to each marker, and the level and time differences between markers.

Marker Display Format (Marker Form)

Set the marker display format to one of the settings below.

- Mark: Displays the markers using dots
- Line: Displays markers using crosshairs

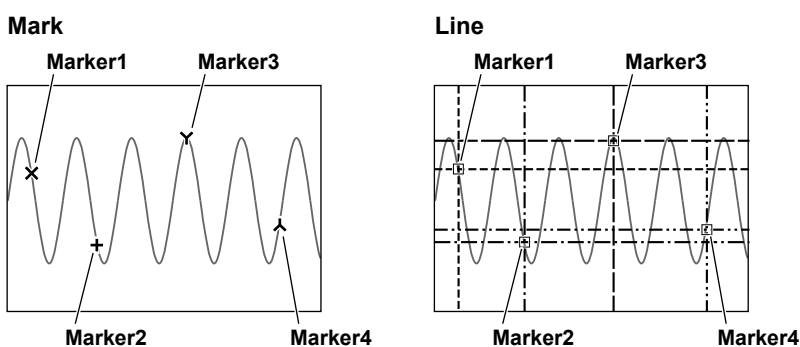

Markers (Marker1 through 4)

Enables or disables each of the markers. If you enable a marker, set the measurement source waveform and the measurement items.

You can assign each marker to separate waveforms.

- CH1 to CH8, Math1 to Math4: Sets the measurement source waveform
- OFF: Disables the marker

11 Cursor Measurement

Measurement Items (Item Setup)

Marker cursors move on the waveform data. You can measure the following values at Marker1.

T1	Time value at Marker1
T2-T1	Time difference between Marker1 and Marker2
T1-T3	Time difference between Marker1 and Marker3
T1-T4	Time difference between Marker1 and Marker4
V1	Vertical value at Marker1
V1-V2	Difference in the vertical values at Marker1 and Marker2
V1-V3	Difference in the vertical values at Marker1 and Marker3
V1-V4	Difference in the vertical values at Marker1 and Marker4

Angle Cursors (Degree)

You can measure time values and convert them to angles. On the time axis, set the zero point (Ref Cursor1 position), which will be the measurement reference, the end point (Ref Cursor2 position), and the reference angle that you want to assign to the difference between Ref Cursor1 and Ref Cursor2. Based on this reference angle, you can measure the angle between two angle cursors (Cursor1 and Cursor2).

Measurement Items (Item Setup)

The DLM4000 measures the angle cursor (Cursor1 and Cursor2) positions as angles.

D1	Angle of Cursor1 from Ref Cursor1
D2	Angle of Cursor2 from Ref Cursor1
ΔD	Angle difference between Cursor1 and Cursor2
V1	Vertical values at the points where Cursor1 intersects the waveforms*
V2	Vertical values at the points where Cursor2 intersects the waveforms*
ΔV	Difference in the vertical values at the points where Cursor1 and Cursor2 intersect the waveforms*

* If you set the measurement source waveform to All, values of all the measurement items are measured for CH1 through CH8 (or LOGIC(L)), Math1 to Math4.

Reference Setup (Reference Setup)

Set the zero point (Ref Cursor1 position), which will be the measurement reference, the end point (Ref Cursor2 position), and the reference angle.

Reference Angle (Ref Value)

Set the reference angle you want to assign to the range defined by Ref Cursor1 and Ref Cursor2.

Selectable range: 1 to 720

Angle Unit (Unit)

You can set the angle unit using any characters you like.

Reference Cursors (Ref Cursor)

Set the zero point (Ref Cursor1) and the end point (Ref Cursor2).

Selectable range: -5.00 to 5.00 divisions

Moving the Cursors (Cursor/Marker)

The cursor type determines the range of cursor movement.

- **ΔV and ΔV in $\Delta T \& \Delta V$ mode (Cursor1 = and Cursor2 =)**

You can move these cursors in the range of -4 to $+4$ divisions from the vertical center of the window in 0.01-division steps.

- **ΔT , ΔT in $\Delta T \& \Delta V$ mode, Marker, and Degree (Cursor1 II, Cursor2 II, and Marker1 to 4)**

You can move these cursors in the range of -5 to $+5$ divisions from the horizontal center of the window in 0.01-division steps. If a zoom window is displayed and a cursor moves into the zoom window, you can move the cursor by 0.01 divisions of the zoom window at a time.

- **Linking Cursor1 and Cursor2**

When the cursor type is ΔT , ΔV , $\Delta T \& \Delta V$, or Degree and you select Cursor1 and Cursor2 at the same time, you can move the cursors while maintaining the same space between them.



Notes about Cursor Measurement

- The measured time values are based on the trigger position.
- The measured value for data that cannot be measured appears as “***.”
- If the display record length is less than a given length (in the interpolation zone), the DLM4000 interpolates between sampled data if Dot Connect is not set to OFF. Therefore, it is possible for there to be no sampled data where the vertical cursor is.

Because marker cursors move on the sampled data, you can always read sampled data.

Cursor Jumping (Cursor Jump)

You can make Cursor1, Cursor2, or Marker1 to Marker4 jump to the center of the specified zoom window. The jump options are listed below.

For ΔT , ΔT in $\Delta T \& \Delta V$ mode, or Degree

Cursor1 to Zoom1: Cursor1 jumps to the Zoom1 window.

Cursor1 to Zoom2: Cursor1 jumps to the Zoom2 window.

Cursor2 to Zoom1: Cursor2 jumps to the Zoom1 window.

Cursor2 to Zoom2: Cursor2 jumps to the Zoom2 window.

For marker

Jump to Zoom1: The selected marker jumps to the Zoom1 window.

Jump to Zoom2: The selected marker jumps to the Zoom2 window.

12 Automated Measurement of Waveform Parameters

The DLM4000 can automatically measure various parameters of the displayed waveform, such as the maximum and minimum values. It can also compute statistics for the automatically measured data. The enhanced parameter measurement feature allows you to automatically measure parameters in two areas (defined as area 1 and area 2) and perform various calculations on the automated measurement values of waveform parameters.

Turning Automated Measurement On or Off (Mode)

Enables or disables the automated measurement of waveform parameters.

- ON: Enables automated measurement
- OFF: Disables automated measurement

Source Waveform

CH1 to CH8/LOGIC(L), LOGIC(A|B), and Math1 to Math4

- * CH8 or LOGIC(L), whichever the corresponding key is illuminated (CH8 or L), can be selected. LOGIC(A|B) is available on models with the /L16 option.



Measurements cannot be made on a snapshot waveform or an accumulated waveform that is not the most recent waveform.

Source Window (Time Range)

Selects the window on which to perform automated measurement of waveform parameters.

- Main: Main window
- Zoom1: Zoom1 window
- Zoom2: Zoom2 window

Measurement Time Period (T Range1/T Range2)

Sets the start point (T Range1) and the end point (T Range2) of the automated measurement time period.

The selectable range is ± 5 divisions from the center of the waveform area.

The resolution is 0.01 divisions.

Automated Measurement of Waveform Parameters

The DLM4000 automatically measures the specified measurement items on the source waveform.

Measurement Items (Item Setup)

Sets the measurement items for each source waveform.

Up to a total of 100000 data values can be saved for the entire area and all waveforms (CH1 to CH8/LOGIC(L), LOGIC(A|B), and Math1 to Math4). The DLM4000 can display a total of 30 measurement items on the screen.

* You cannot select CH8 and LOGIC(L) at the same time. LOGIC(A|B) is available on models with the /L16 option.

The source waveform type determines the measurement items that you can choose.

- **Analog Waveform (Trace): CH1 to CH8, Math1 to Math4**

All voltage and time items

- **Logic Waveform (Trace): LOGIC(L0 to L7), LOGIC(A0 to A7), LOGIC(B0 to B7)**

The following time measurement items

Freq, Period, Avg Freq, Duty, Pulse Count, and Delay



- You can read out the values of measurement items that are not displayed on the screen by using communication features.
- If you execute GO/NO-GO determination based on a waveform parameter, automated measurement turns on.
- If the power measurement mode of the power supply analysis feature (/G3 or /G4 option) is turned on, you will not be able to set the following measurement items. ▶ See here.

Max, Min, P-P, Rms, Mean, Sdev, Avg Freq

Voltage Measurement Items (Measure Item)

V1: Voltage at the point where the waveform intersects T Range1

V2: Voltage at the point where the waveform intersects T Range2

Max: Maximum voltage [V]

Min: Minimum voltage [V]

P-P: P-P value (Max – Min) [V]

High: High voltage [V]

Low: Low voltage [V]

Amplitude: Amplitude (High – Low) [V]

Rms: Rms voltage [V] $(1/\sqrt{n})(\sum(xN^2))^{1/2}$

Mean: Mean voltage [V] $(1/n) \sum xN$

Sdev: Standard deviation [V] $((\sum xN^2 - (\sum xN)^2/n)/n)^{1/2}$

IntegTY+: Area under the positive parts [Vs]

IntegTY: Area under the positive parts – area under the negative parts [Vs]

+Over: Overshoot [%]

$$(\text{Max} - \text{High}) / (\text{High} - \text{Low}) \times 100$$

-Over: Undershoot [%]

$$(\text{Low} - \text{Min}) / (\text{High} - \text{Low}) \times 100$$

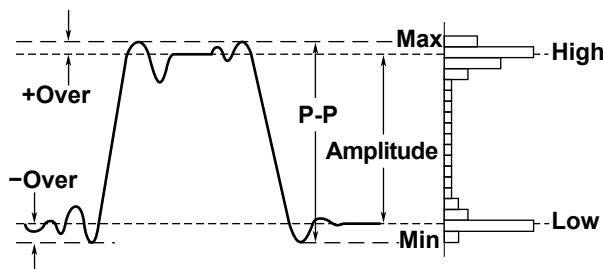



- The unit of measurement that is listed for voltage measurement items changes to amperes when current is measured. If you have specified a unit when measuring in linear-scaling mode, the DLM4000 displays the measured values using the specified unit.
- You can determine the area of XY waveforms by using the analysis features available in the X-Y menu.

Time Measurement Items (Measure Item)

ΔT : Time difference between T Range1 and T Range2

Freq: Frequency [Hz]

Period: Period [s]

+Width: Time span when the waveform is above the mesial reference line [s]

-Width: Time span when the waveform is below the mesial reference line [s]

Duty: Duty cycle ($+Width/Period \times 100$) [%]

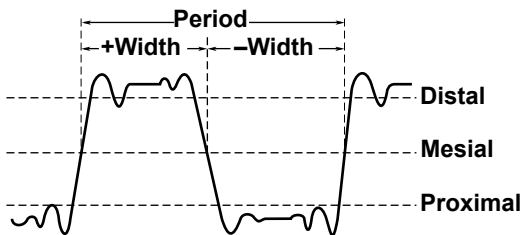

Rise: Rise time [s]

Fall: Fall time [s]

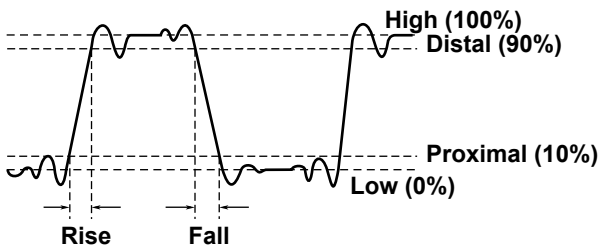

* Freq, Period, +Width, -Width, Rise, Fall, and Duty parameters are measured on the first period of the waveform.

Delay: Delay between waveforms [s]

Pulse Count: Pulse count [no unit]

Edge Count: Edge count [no unit]

Avg Freq: Average frequency in the time range [Hz]

Avg Period: Average period in the time range [s]

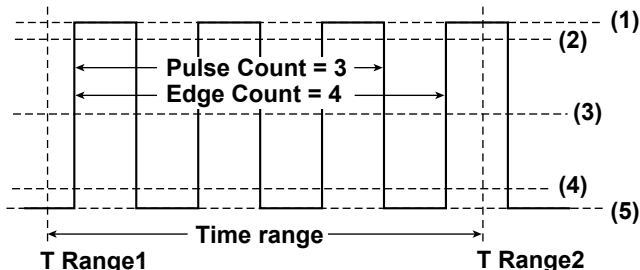

- (1) High
- (2) Distal
- (3) Mesial
- (4) Proximal
- (5) Low

12 Automated Measurement of Waveform Parameters

Burst: Burst period [s]

Set the time range (Time Range) to a value appropriate for the burst period that you want to measure.

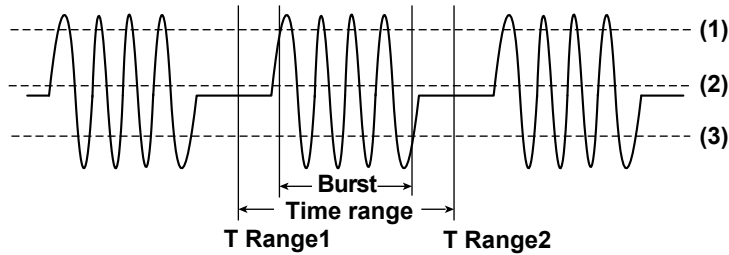

- (1) Distal
- (2) Mesial
- (3) Proximal

Measurement of Delay between Waveforms (Delay Setup)

Measures the time difference from the reference waveform (Reference) edge or the trigger point (TrigPos) to the source waveform (Trace) edge.

- Reference: Selects the reference waveform (CH1 to CH8/LOGIC(L), LOGIC(A|B), Math1 to Math4, or TrigPos)
 - * You can select CH8 or LOGIC(L), depending on which channel's corresponding key (CH8 or L) is illuminated. If the measurement source waveform (Trace) is set to a logic waveform, you can select LOGIC. If you select LOGIC, select the [source bit](#). LOGIC(A|B) is available on models with the /L16 option.
- Polarity: Selects the slope (rising \uparrow or falling \downarrow) of the edge you want to detect
- Count: Sets which edge counted from the start point (T Range1) of the time range to use as a detected point (reference point or measured point). The selectable range is 1 to 10.
- Unit: Sets the unit for displaying the delay between waveforms to Time or Degree when Reference is not set to TrigPos.

Time

Displays the delay between waveforms in time.

Degree

Displays the delay between waveforms as an angle.

Conversion formula: $\text{angle} = \text{delay (s)} / \text{period (s)} \times 360 \text{ (deg)}$ where the period is the period of the reference waveform.

Example

(When Reference is not set to TrigPos)

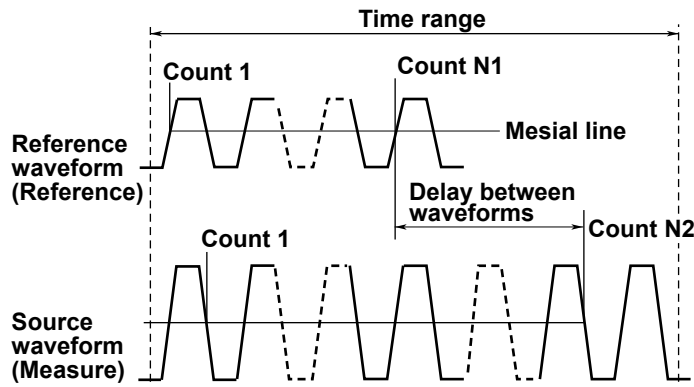

Reference waveform settings

- Polarity : \uparrow (rising edge)
- Count : N1 (an integer between 1 and 10)

Source waveform settings

- Polarity : \downarrow (falling edge)
- Count : N2 (an integer between 1 and 10)

Cycle Mode (Cycle Mode)

The time range for automated measurement is set to the period, not the time range specified by T Range1 and T Range2.

You can set how the DLM4000 determines the time range to one of the settings below.

1 Cycle: Sets the time range to the first period after T Range1

N Cycle: Sets the time range to the left end of the first period that is between T Range1 and T Range2 to the right end of the Nth period

OFF: Sets the time range to the duration between T Range1 and T Range2 (the same as normal automated measurement)

* The method of determining the period is the same as the method for determining the Period measurement item.

In cycle mode, the following measurement items are meaningful.

Max: Maximum voltage [V]

Min: Minimum voltage [V]

P-P: P-P value (Max - Min) [V]

High: High voltage [V]

Low: Low voltage [V]

Amplitude: Amplitude (High - Low) [V]

Rms: Rms voltage [V] $(1/\sqrt{n})(\sum(xN^2))^{1/2}$

Mean: Mean voltage [V] $(1/n) \sum xN$

Sdev: Standard deviation [V] $((\sum xN^2 - (\sum xN)^2/n)/n)^{1/2}$

IntegTY+: Area under the positive parts [Vs]

IntegTY: Area under the positive parts - area under the negative parts [Vs]

+Over: $(Max - High)/(High - Low) \times 100$

-Over: $(Low - Min)/(High - Low) \times 100$

Time range for each cycle mode

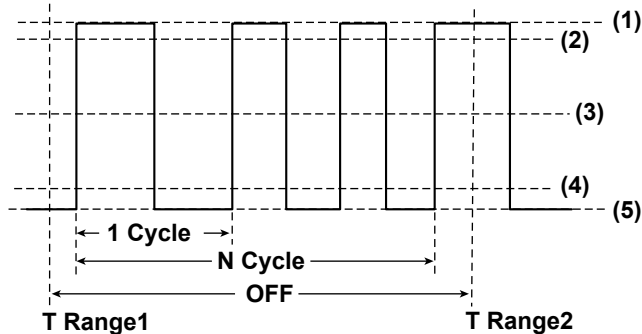

- (1) High
- (2) Distal
- (3) Mesial
- (4) Proximal
- (5) Low

Measurement Location Indicator (Indicator)

Indicates the measured location of a specified item using cursors. Measured locations can be displayed for the following items.

Max, Min, P-P, High, Low, Amplitude, Rms, Mean, +Over, -Over, V1, V2,

Avg Freq, Avg Period, Burst, Freq, Period, +Width, -Width,

Duty, Rise, Fall, and Delay

When set to Rise

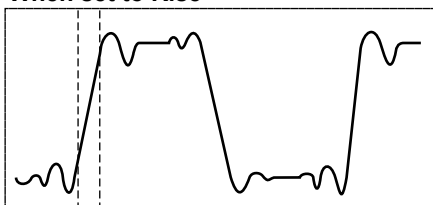

When set to Max

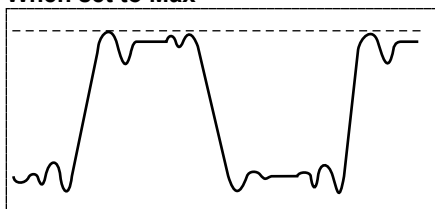

If the statistical processing mode is set to Cycle or History, the measurement location cannot be displayed.

Reference Level for Automated Measurement (Ref Levels)

Sets the reference level that is used to measure various parameter values such as High, Low, Hi-Low, Rise, and Fall for each source waveform.

Mode

Selects the unit used to set the reference level (Distal/Mesial/Proximal).

- **%**
Assuming the High and Low values to be 100% and 0%, respectively, you can set the distal, mesial, and proximal values to any percentage.
- **Unit**
You can set the distal, mesial, and proximal values to any voltage.

Distal, Mesial, and Proximal (Distal/Mesial/Proximal)

You can set the distal, mesial, and proximal values. If you set the reference level mode to Unit, specify values that are within the range of the voltage source waveform.

▶ [See here.](#)

How to Determine the High and Low Values

Selects how the DLM4000 determines the 100% (High) and 0% (Low) levels of the measurement source.

- **Auto**
Sets the high value to the high amplitude level and the low value to the low amplitude level based on the voltage level frequency of the source waveform in the time range taking into account the effects from ringing, spikes, etc. This method is suitable for measuring square waves and pulse waves.
- **Max-Min**
Sets high and low values to the maximum and minimum values in the time range. This method is suitable for measuring sinusoidal and saw waves. It is not suitable for waveforms that have ringing and spikes.
- **Histogram**
Sets the levels of the two highest frequencies on a histogram to high and low. This method is suitable for waveforms whose maximum frequency of a given level is extremely high compared to frequencies of other levels, such as in a rectangular waveform.

Statistics (Statistics)

Display the following statistics on the automated measurement values of waveform parameters. Statistics can be calculated on up to nine automatically measured items.

- Maximum (Max)
- Minimum (Min)
- Mean (Mean)
- Standard deviation (σ)
- The number of measured values used to calculate statistics (Count)

The following types of statistical processing are available.

- Normal statistical processing (Continuous)
- Statistical processing for each period (Cycle)
- Statistical processing of history waveforms (History)



If 10 or more automatically measured items are selected, the DLM4000 displays the first 9 items in ascending order by channel number and in the order that the items appear in the automated measurement item selection menu (Max, Min, ..., +Over, -Over, ..., Freq, Period, ..., and Delay).

Example:

When CH1: Max, Min, High, Low, CH2: Max, Min, High, CH3: Max, Min, High are selected, the following items are displayed: CH1: Max, Min, High, Low, CH2: Max, Min, High, CH3: Max, and Min

You can view the statistics of other items in the following way.

- Load the items into a PC using the communication feature.
- Save the items as automatically measured waveform statistics and load the data into a PC.

Statistical Processing Mode (Mode)

Set the statistical processing mode to one of the settings below.

- OFF: Disables statistical processing
- **Continuous**: Normal statistical processing
- **Cycle**: Statistical processing of measured values for each period (cyclic statistical processing)
- **History**: Statistical processing of history waveforms

Normal Statistical Processing (Continuous)

While acquiring waveforms, the DLM4000 calculates the statistics of the waveforms that it has acquired so far. The number of measured values used to calculate statistics (Count) is equal to the number of waveforms that have been acquired up to that point.

If you stop waveform acquisition and restart it, or if you add another automatically measured item during waveform acquisition, the Count value is reset to 1.

Restart (Restart)

Resets the statistics calculated up to that point. You can only use this feature when the mode is set to Continuous.

Statistical Processing Setting When the Trigger Level Changes (TrigLevelChange)

When the mode is set to Continuous, select whether statistical processing should be reset when the trigger level is changed during waveform acquisition.

- Restart: Count is reset to 1, and statistical processing restarts.
- Ignore: Statistical processing continues without being reset.

Cyclic Statistical Processing (Cycle)

In cyclic statistical processing, the DLM4000 divides the displayed waveform by the period that it automatically determines through calculation, and calculates statistics of the measured values in each period. The method of determining the period is the same as the method for determining the Period measurement item.

This mode is effective for items, such as Rms or Avg, that may result in errors depending on the time range setting.

The following measurement items cannot be selected.

Avg Freq, Avg Period, Pulse Count, Edge Count, Delta T, Delay, V1, and V2

Cycle Trace (Cycle Trace)

Selects the source waveform used to determine the period.

- **Own**

The period is determined for each source waveform.

- **CH1 to CH8/LOGIC(L), LOGIC(A|B), Math1 to Math4**

The period is determined for the selected waveform, and that period is used on all source waveforms. If you select LOGIC, select the [source bit](#).

* CH8 or LOGIC(L), whichever the corresponding key is illuminated (CH8 or L), can be selected. LOGIC(A|B) is available on models with the /L16 option.

Example in Which Cycle Trace Is Set to CH2

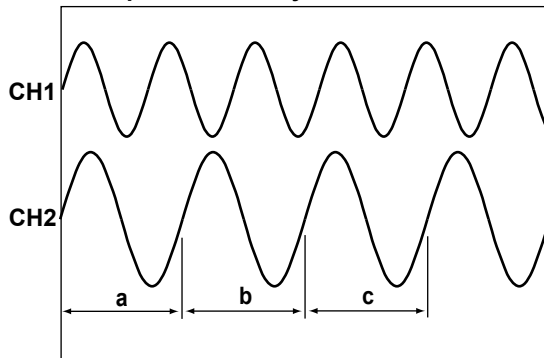

Measures the items in ranges a, b, and c, and calculates statistics on the items in the order a, b, and c. The items of other channels are also measured in ranges a, b, and c. If you select Own, the items are measured over each waveform's period.

Executing Statistical Processing (Exec)

Executes statistical processing. You can use this command when the statistical processing mode is set to Cycle or History.



- The number of cycles being used for the cyclic statistical processing is displayed in the statistical display's Count column.
- The number of cycles that can be used in cyclic statistical processing varies depending on the number of measured items that the DLM4000 is calculating the statistics of.
 $100000 / (\text{the number of measured items that the DLM4000 is calculating the statistics of})$
- Cyclic statistical processing is performed only on the main window.

Statistical Processing of History Waveforms (History)

The DLM4000 automatically measures items on the selected range of the history waveform and calculates statistics. The DLM4000 calculates statistics from the oldest waveform. The statistics of the waveforms displayed in Time Stamp are calculated.

Executing Statistical Processing (Exec)

Executes statistical processing. You can use this command when the statistical processing mode is set to Cycle or History.

List Display (List)

Displays a list of calculated statistics. You can display this list when the statistical processing mode is set to Cycle or History. You can highlight a measured value.

- **Search Mode**

Searches for the specified item and highlights the detected line.

OFF (disable), Statistics Max (maximum value), Statistics Min (minimum value), $a \leq \text{Data}$ (a value greater than or equal to the specified value), $\text{Data} \leq b$ (a value less than or equal to the specified value), $a \leq \text{Data} \leq b$ (a value between two specified values)

- **Jump (When Search Mode is set to OFF)**

Jumps to and highlights the specified destination.

Statistics Max (maximum value), Statistics Min (minimum value), Oldest, or Latest

- **Jump to Search Point (When Search Mode is not set to OFF)**

Jumps to and highlights the specified destination. You can specify any of the search results.

If multiple maximum and minimum values are available, the data with the newest number is highlighted.

Previous (previous data), Next (next data), Oldest, or Latest

- **Sort**

Sorts the list in the specified order.

Forward (from the oldest) or Reverse (from the latest)



-
- You can also use the jog shuttle or the SET key to specify the highlighted measured value.
 - In cyclic statistical processing, you can highlight a measured value and then press SET to display one period of the corresponding waveform on the zoom display.
 - In statistical processing of history data, you can highlight a measured value and then press SET to display the corresponding waveform.
-

Trend Display and Histogram Display (Trend/Histogram)

You can display up to two trends or histograms of the specified measurement items. You can also display values using the measurement feature. Mean, standard deviation, and other statistics can be displayed on the histogram display.

Display Example (Item = P-P)

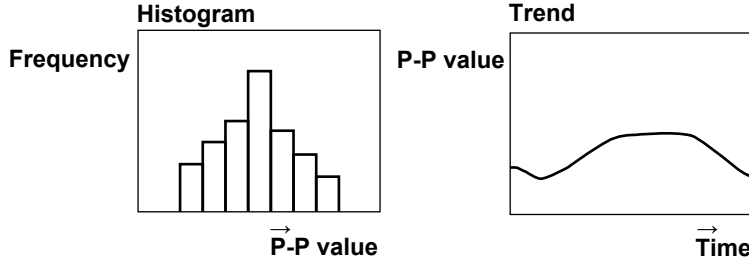

Displaying Trends and Histograms (Display)

Set whether or not to display trends or histograms. If you select ON, you can set the type of graph to display and the source. Trends and histograms are displayed in the Trend/Histogram window.

- **Display**

- ON: Displays trends or histograms
- OFF: Does not displays trends or histograms

- **Type of Graph to Display (Mode)**

You can set the type of graph you want to display to one of the settings below.

- Trend: Trend of the calculated statistics
- Histogram: Histogram of the calculated statistics

- **Display Source (Item)**

You can select the source waveform and the automatically measured item (you can only select one item) that will be shown in the trend or histogram display.

The measurement items that are turned on in the Item Setup screen for the automated measurement of waveform parameters appear in the list.

- **Configuring the Display (Display Setup)**

You can turn on and off the VT waveform display (shared with the trend and histogram display) and specify how to set the display scale (trend display only).

- Auto Scale Exec
Executes auto scaling of the trend display. Upper, Lower, and H-Span are set as follows:
Upper/Lower: Set so that the difference between the maximum and minimum values of the waveform parameter is 80% of the waveform area.
H-Span: Set so that all of the waveform parameter values that were measured before Auto Scale was executed are displayed.
- Upper/Lower
Set the vertical scale values of the trend display.
- H-Span
Set the horizontal scale values of the trend display.
- VT Display
Set whether to display the VT waveform along with the trend or histogram display.
ON: Displays the VT waveform display window
OFF: Does not display the VT waveform display window



If the statistical processing mode is set to Continuous and you execute Auto Scale, H-Span is set to 100 if the number of waveform parameters that had been measured is less than or equal to 100.

• **Measurement (Measure Setup)**

On histograms, you can measure parameters such as peak values and maximum values and measure values using cursors.

• **Mode (Mode)**

Param: Measures the value of the selected parameter.

OFF: Disables measurement.

• **Cursor Measurement (Cursor1 and Cursor2)**

Measurement items C1, C2, and ΔC are used to measure the Cursor1 value, the Cursor2 value, and the difference between the two cursor values.

• **Measurement Item (Item)**

The DLM4000 measures the values of the items listed below that you select.

Peak	Peak value
Max	Maximum value
Min	Minimum value
Mean	Mean value
σ	Standard deviation of the histogram
Median	Median*
Integ $\pm\sigma$	Percentage of values that fall within $\pm\sigma$ (%)
Integ $\pm2\sigma$	Percentage of values that fall within $\pm2\sigma$ (%)
Integ $\pm3\sigma$	Percentage of values that fall within $\pm3\sigma$ (%)
C1	Cursor1 value
C2	Cursor2 value
ΔC	Difference between Cursor1 and Cursor2

* Resorts the sampled points from the minimum to the maximum value and determines the value of the middle number.

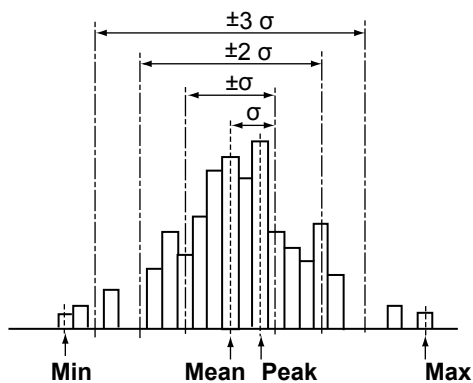

• **Cursor Measurement (Cursor)**

You can perform cursor measurements on trends.

ON: Measures the Cursor1 and Cursor2 values

OFF: Turns cursor measurement off

Enhanced Parameter Measurement (Enhanced)

The enhanced parameter measurement feature allows you to perform automated measurement of the waveform parameters of two areas. It also allows you to perform calculations using the automated measurement values of waveform parameters.

You cannot use the enhanced parameter measurement feature when the statistical processing mode is set to Cycle.

Configuring Area2 (Item Setup (Area2))

You can configure measurement items and other settings of the second area (Area2). The method used to configure the items is the same as the method described in “Automated Measurement of Waveform Parameters.”

▶ [See here.](#)

Source Window (Time Range (Area2))

Selects the source window for Area2. The method used to configure the items is the same as the method described in “Automated Measurement of Waveform Parameters.”

▶ [See here.](#)

Measurement Range (T Range1/T Range2)

Set the measurement range of Area2. The method to set the range is the same as that for the automated measurement of waveform parameters.

▶ [See here.](#)

Calculation Using Waveform Parameters (Calc Setup)

You can define four calculations (Calc1 through Calc4) that use the automated measurement values of waveform parameters.

Name (Name)

You can specify a name of up to eight characters in length for the computation that you have defined. The specified name is displayed on the screen.

Expression (Expression)

Be sure to include a waveform parameter in the expressions.

The available operators and how to use them are described below.

Menu Item	Example	Description
+, -, *, /	Max(C1)-Min(C1)	Basic arithmetic of the input value
ABS	ABS(High(C1))	Absolute value of the input value
SQRT	SQRT(Volt1(C1))	Square root of the input value
LOG	LOG(Max(C2))	Logarithm of the input value
LN	LN(Min(C2))	Natural logarithm of the input value
EXP	EXP(Volt2(C1))	Exponent of the input value
P2	P2(Min(C1))	Square of the input value
SIN	SIN(Low(C1))	Sine of the input value
ASIN	ASIN(High(C2))	Arc sine of the input value
COS	COS(Max(C1))	Cosine of the input value
ACOS	ACOS(Min(C1))	Arc cosine of the input value
TAN	TAN(Volt1(C2))	Tangent of the input value
ATAN	ATAN(Volt2(C1))	Arc tangent of the input value
0 to 9	-	-
Exp		E notation. Used to enter a number in scientific notation in expressions. (1E+3=1000, 2.5E-3=0.0025) Displayed as "E" in expressions to distinguish it from the "EXP" operator.
PI		Pi (π)
e		Euler's number, base of the natural logarithm (e=2.71828...) Displayed as "eul" in expressions to distinguish this from the "E" that represents exponents.
fs		Sample rate. DLM4000 sample rate when the computation was executed. The value changes according to the changes in the time axis or record length setting.
1/fs		Number of samples per second. Computed based on the DLM4000 sample rate when the computation was executed. The value changes according to the changes in the time axis or record length setting.
Measure Item	Max(C1)	Selects a waveform parameter.
A1, A2	PP(C1,A2)	Specifies the calculation source area. If you want to calculate on Area2, add ",A2" after the calculation source channel.

Unit (Unit)

You can set the unit, which is used when the computed results are displayed, using up to four characters.

Notes about Automated Measurement of Waveform Parameters

- If measurement is not possible, the measured value appears as "*****."
- The DLM4000 may not measure correctly if the waveform amplitude is small.
- To stop automated measurement, select OFF by pressing MEASURE > Mode soft key. Measurement stops immediately.

- **Notes about Statistical Processing**

If the statistical processing mode is set to Cycle or History, all keys and soft keys except the Abort soft key are invalid during statistical processing. In Continuous mode, the RUN/STOP key and TrigLevelChange Soft key are valid.

13 Zooming in on Waveforms

You can magnify the displayed waveforms vertically or horizontally.

The zoomed waveforms of two locations can be displayed simultaneously (the dual zoom feature). You can also specify which channel you want to zoom in on. You cannot zoom if the number of displayed points on the screen is less than or equal to 10.

Example of the Dual Zoom Display

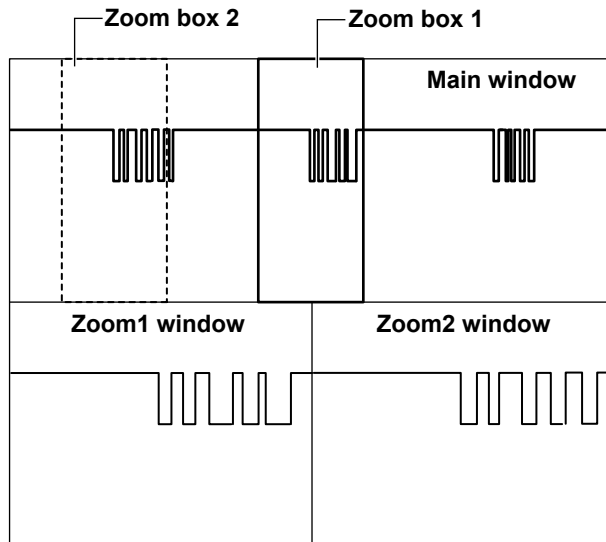

If the main window (which displays normal waveforms) and the Zoom1 or Zoom2 window are displayed at the same time, a zoom box appears in the Main window so that you can check the zoom position.

Turning the Zoom Windows On or Off (Display)

Sets whether or not to display zoom windows.

- ON: Displays the zoom windows
- OFF: Does not display the zoom windows



The ZOOM1 and ZOOM2 keys illuminate when the zoom feature is on. The ZOOM knob controls the waveforms in the window whose corresponding key is illuminated more brightly.

Display Format (Format)

Selects how to divide the zoom windows. Select from one of the settings below.

- Main: Same format as the Main window
- Single: No divisions
- Dual: Two divisions
- Triad: Three divisions
- Quad: Four divisions
- Hexa: Six divisions
- Octal: Eight divisions





Displaying the Main Window (Main)

Selects which area to display the main window in.

- OFF: Does not display the main window
- On 20%: Displays the main window in the top 20% area of the screen
- On 50%: Displays the main window in the top half (50%) of the screen

Auto Scroll (Auto Scroll)

Automatically moves the zoom position in the specified direction. You can view the waveform and stop scrolling at the appropriate position.

	Zooms in on the left edge of the Main window
	Starts scrolling to the left
	Stops auto scrolling
	Starts scrolling to the right
	Zooms in on the right edge of the Main window

Scroll Speed (Down/Up)

Six different auto scroll speeds are available.

- Down: Decreases the scroll speed by one level.
- Up: Increases the scroll speed by one level.

Zoom Source Waveforms (Trace)

You can select the zoom source waveforms from the waveforms below.

All, CH1 to CH8/LOGIC(L), LOGIC(A|B), Math1 to Math4

- * CH8 or LOGIC(L), whichever the corresponding key is illuminated (CH8 or L), can be selected. LOGIC(A|B) is available on models with the /L16 option.



If you select a waveform whose display is turned off in the main window, the zoom waveform does not appear.

Zoom Factor (ZOOM knob)

You can set separate horizontal zoom factor for ZOOM1 and ZOOM2. The zoom window time axis settings change automatically based on the specified zoom factor.

Use the ZOOM knob to set the zoom factor.

Selectable Range

From twice the TIME/DIV setting of the main window up to the ratio at which the number of data points in the zoom window is 2.5



-
- If you push the ZOOM knob, the FINE indicator illuminates, and you can set the zoom factor with higher resolution.
 - The horizontal zoom factor applies to all waveforms that are displayed in the zoom window.
-

Zoom Position (Z1 Position/Z2 Position)

Taking the horizontal center of the main window to be 0 divisions, set the center position of the zoom boxes in the range of -5 to +5 divisions. In the Main window, the zoom box with solid lines is Zoom1, and the zoom box with dashed lines is Zoom2.

Waveforms are magnified around Z1 Position and Z2 Position.

Zoom Link

If the Zoom1 and Zoom2 windows are both displayed, you can select whether or not to maintain the distance between the two zoom boxes when you set the zoom position.

<input type="radio"/> Z1 Position/ <input checked="" type="radio"/> Z2 Position	The jog shuttle sets the zoom box 1 position.
<input checked="" type="radio"/> Z1 Position/ <input type="radio"/> Z2 Position	The jog shuttle sets the zoom box 2 position.
<input type="radio"/> Z1 Position/ <input type="radio"/> Z2 Position	The jog shuttle sets the zoom box 1 and 2 positions while maintaining the same distance between the two zoom boxes.

Vertical Zoom (Vertical Zoom)

Zoom Source Waveform

Set the zoom source waveform to one of the waveforms below.

CH1 to CH8, Math1 to Math4

Zoom Position (V-Position)

Taking the vertical center of the main window to be 0 divisions, set the vertical center position of the zoom boxes in the range of -4 to 4 divisions. In the Main window, the zoom box with solid lines is Zoom1, and the zoom box with dashed lines is Zoom2.

Zoom Factor (V-Mag)

You can set separate vertical zoom factors for ZOOM1 and ZOOM2. The zoom window vertical axis settings change automatically based on the specified zoom factors.

Use the jog shuttle to set the zoom factors.

Selectable range: Up to 10 times

Initializing the Vertical Zoom

You can reset the vertical zoom factor and zoom position settings by pressing RESET.

14 Searching Waveforms

The search feature allows you to search the displayed waveforms for locations that match the specified conditions. You can zoom-in on the detected locations. You can search the waveforms within the specified search range over up to 50000 points.

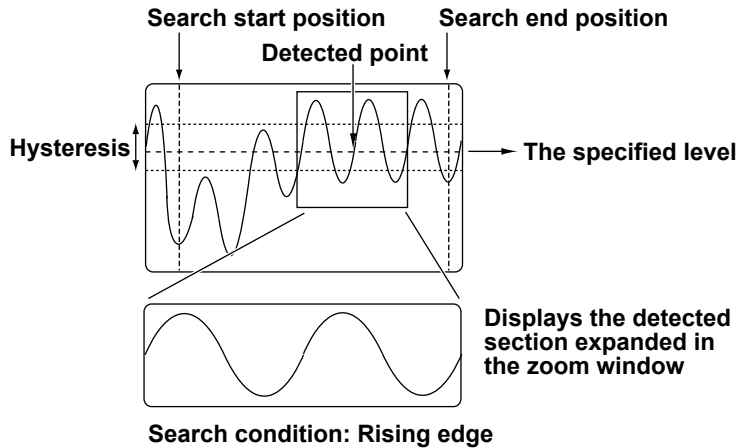

Search Source Waveform

You can search any of the following channel waveforms. If you select LOGIC, select the [source bit](#).
CH1 to CH8/LOGIC(L), LOGIC(A|B), Math1 to Math4

* CH8 or LOGIC(L), whichever the corresponding key is illuminated (CH8 or L), can be selected. LOGIC(A|B) is available on models with the /L16 option.



- If you select a channel that a reference waveform has been loaded into, you can search the reference waveform. ► [See here](#).
- If you set the source to a channel (CH1 to CH8) that a waveform has been loaded into, you can search the loaded waveform.

Search Type (Type)

Set the search method to one of the settings below. The search method of each search type is the same as the method of the corresponding trigger type.

Edge Search

Searches for positions where the rising or falling slope of the specified waveform passes through the specified level.

Search Example

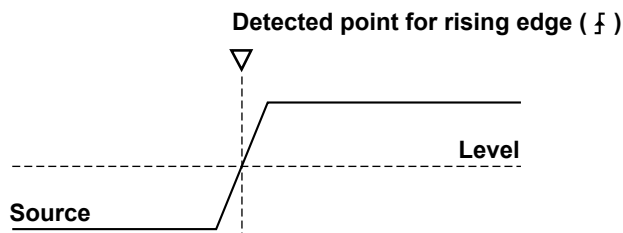

Edge Qualified Search

While the conditions of the waveforms other than the search source meet the specified qualifications, the DLM4000 searches for positions where the rising or falling slope of the search source passes through the specified level.

Search Example

Qualification: CH1 = H, CH2 = L, AND; Source: CH3, rising edge
 where L is low level and H is high level

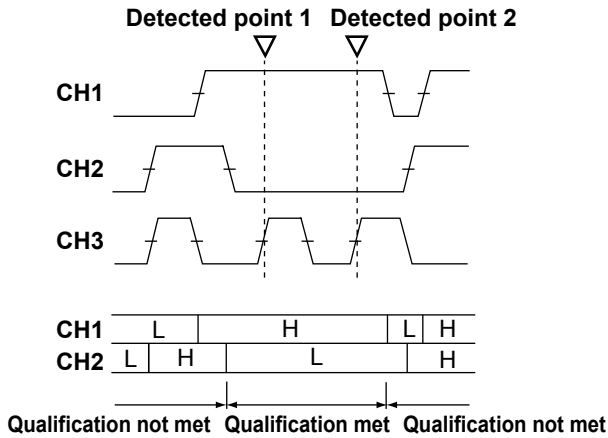

State Search

The DLM4000 searches for points where the result of comparing each signal state to the specified state condition changes from met to not met or from not met to met.

Search Example

Clock source: None
State: CH1 = H, CH2 = L, other channels = X, AND
Condition: Enter

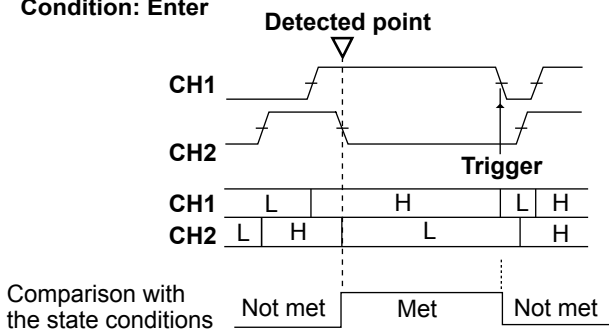

Pulse Width Search

The DLM4000 searches for positions where the specified waveform pulse width meets the conditions of the specified time width mode.

Search Example

Mode: Between
T1: Time1, T2: Time2

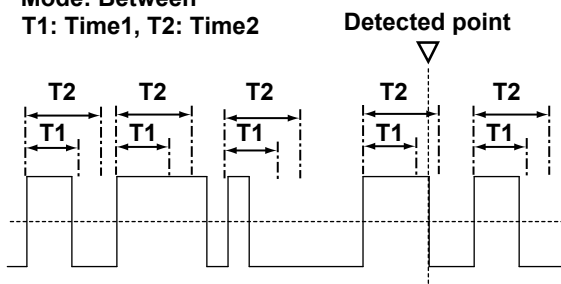

State Width Search

The DLM4000 searches for points where the matched or not-matched condition changes after the time width mode condition has been met. Whether or not the time width mode condition is met is determined by the relationship between the reference time and the length of time for which each signal state matches or does not match the state condition.

Search Example

Mode: More than; clock source: None
State: CH1 = H, CH2 = L, other channels = X, AND
Condition: False

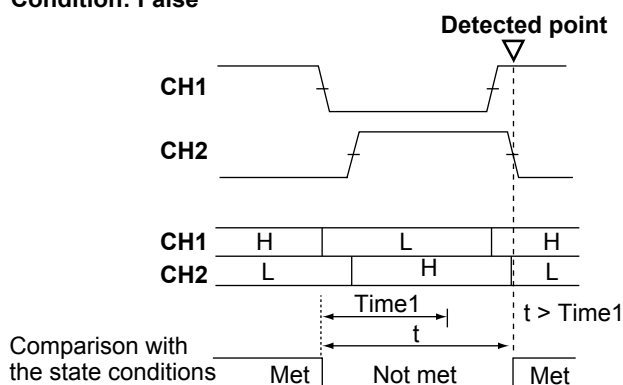

Search Conditions (Condition Setup)

Set the search source waveform, detection level, and other search conditions. The items that you need to set vary depending on the search type that you select.

Edge Search

Search Source Waveform (Source)

You can select from one of the settings below. If you select LOGIC, select the [source bit](#).

CH1 to CH8/LOGIC(L), LOGIC(A|B), Math1 to Math4

- * CH8 or LOGIC(L), whichever the corresponding key is illuminated (CH8 or L), can be selected. LOGIC(A|B) is available on models with the /L16 option.

Slope (Slope)

You can select which slope edge to detect in the search source waveform.

	Rising slope
	Falling slope
	Rising or falling slope

Level (Level)

When the search source waveform is CH1 to CH8 or Math1 to Math4, set the level used to detect the search source waveform's rising or falling edge.

Selectable range: ± 10 division

Resolution: 0.01 divisions

Hysteresis (Hysteresis)

When the search source waveform is CH1 to CH8 or Math1 to Math4, you can set a width (hysteresis) to the edge detection level so that the DLM4000 does not detect edges on level changes within the specified width.

Selectable range: 0.0 to 4.0 divisions

Resolution: 0.1 divisions

Edge Qualified Search

Search Source Waveform (Source)

You can select from one of the settings below. If you select LOGIC, select the [source bit](#).

CH1 to CH8/LOGIC(L), LOGIC(A|B), Math1 to Math4

* CH8 or LOGIC(L), whichever the corresponding key is illuminated (CH8 or L), can be selected. LOGIC(A|B) is available on models with the /L16 option.

Slope (Slope)

You can select which slope edge to detect in the search source waveform.

	Rising slope
	Falling slope

Qualifications (Qualification) and Combination (Logic)

These items are the same as those of the Edge Qualified trigger.

▶ [See here](#).

Search Requirement (Condition)

Set the edge to detect.

True	Edges that the DLM4000 detects while the qualifications are met
False	Edges that the DLM4000 detects while the qualifications are not met

Level (Level) and Hysteresis (Hysteresis)

You can set the edge detection level and hysteresis for each waveform (CH1 to CH8 and Math1 to Math4).

These items are the same as those of the edge search.

State Search

Clock Source (Clock)

You can select from one of the settings below. If you select LOGIC, select the [source bit](#).

CH1 to CH8/LOGIC(L), LOGIC(A|B), Math1 to Math4, X (not specify a clock source)

* CH8 or LOGIC(L), whichever the corresponding key is illuminated (CH8 or L), can be selected. LOGIC(A|B) is available on models with the /L16 option.

Pattern (Pattern)

You can set the clock source slope and polarity and the state of waveforms other than the clock source. You can set the states of the these waveforms: CH1 to CH8, L0 to L7, and Math1 to Math4. This item is the same as the pattern of the State trigger. However, unlike the trigger pattern and slope, they do not affect the window comparator settings.

▶ [See here](#).

Combination (Logic)

These items are the same as those of the state trigger.

▶ [See here](#).

Search Requirement (Condition)

You can select how the result of comparing the state and pattern of each waveform (met or not met) must change for it to be considered a detection point.

Enter	When the condition changes from met to not met
Exit	When the condition changes from not met to met

Level and Hysteresis (Level/Hys)

You can set the state detection level and hysteresis for each waveform (CH1 to CH8 and Math1 to Math4).

These items are the same as those of the edge search.

▶ [See here](#).

Pulse Width Search

Search Source Waveform (Source)

You can select from one of the settings below. If you select LOGIC, select the [source bit](#).

CH1 to CH8/LOGIC(L), LOGIC(A|B), Math1 to Math4

* CH8 or LOGIC(L), whichever the corresponding key is illuminated (CH8 or L), can be selected. LOGIC(A|B) is available on models with the /L16 option.

Polarity (Polarity), Time Width Mode (Mode), and Reference Time (Time)

These items are the same as those of the Pulse Width trigger. However, unlike the trigger polarity, they do not affect the window comparator settings.

▶ [See here.](#)

Level and Hysteresis (Level/Hys)

When the search source waveform is CH1 to CH8 or Math1 to Math4, you can set the state detection level and hysteresis. These items are the same as those of the edge search.

▶ [See here.](#)

State Width Search

Clock Source (Clock)

You can select from one of the settings below. If you select LOGIC, select the [source bit](#).

CH1 to CH8/LOGIC(L), LOGIC(A|B), Math1 to Math4, X (not specify a clock source)

* CH8 or LOGIC(L), whichever the corresponding key is illuminated (CH8 or L), can be selected. LOGIC(A|B) is available on models with the /L16 option.

Pattern (Pattern)

You can set the clock source slope and polarity and the state of waveforms other than the clock source. You can set the states of the these waveforms: CH1 to CH8, L0 to L7, and Math1 to Math4. This item is the same as the pattern of the State Width trigger. However, unlike the trigger pattern and slope, they do not affect the window comparator settings.

▶ [See here.](#)

Combination (Logic)

This item is the same as the that of the State Width trigger.

▶ [See here.](#)

Search Requirement (Condition)

You can select which condition (met or not met) after comparing the state and pattern of each waveform to compare against the reference time.

True	When the condition is met.
False	When the condition is not met.

Time Width Mode (Mode)

Set what kind of relationship between the length of time the pattern is met or not met and the specified reference times (Time1 and Time2) will be searched. The selectable time width modes are the same as those of the State Width trigger.

▶ [See here.](#)

Reference Time (Time)

This item is the same as that of the Pulse Width trigger.

▶ [See here.](#)

Level and Hysteresis (Level/Hys)

You can set the state detection level and hysteresis for each waveform (CH1 to CH8 and Math1 to Math4). These items are the same as those of the edge search.

▶ [See here.](#)

Displaying Detected Waveforms (Display Setup)

Displays the detected point of the detected point number specified by (Pattern No.) in the center of the zoom window.

When the pattern number is set to 2.

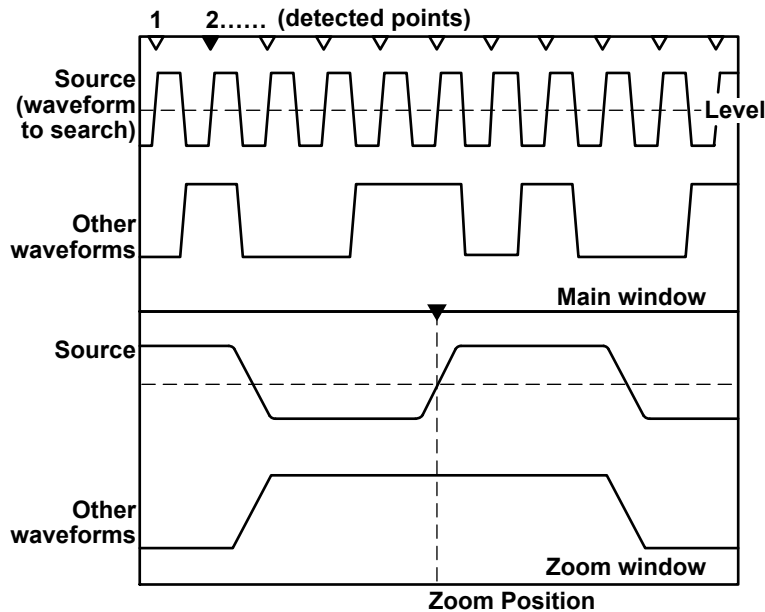

Mark (Mark)

Select whether or not to display marks on the detected points. When this feature is turned ON, detected point marks appear at the top section of the main window.

- ON: Displays the marks
- OFF: Does not display the marks

Specifying the Zoom Window (Result Window)

Select the Zoom1 or Zoom2 window to display an expanded view of the detected points.

You only need to make this selection when both the Zoom1 and Zoom2 displays are turned on.



If Zoom1 and Zoom2 displays are both off and you press SEARCH, the Zoom1 display turns on.

Zoom Position (Z1 Position/Z2 Position)

You can change the zoom position in the zoom window that is specified using Result Window.

Search Skip (Skip Mode)

After a search condition is met, you can skip the detection of search conditions for the specified amount of time or the specified number of counts. You can specify this setting when the search type is set to Edge or Pulse Width.

Set the skip method to one of the settings below.

- OFF: Searches for all points that meet the search conditions
- Hold Off: Skips the detection of search conditions for the specified amount of time (You can set the amount of time to a value from 0.1 ns to 1.00000 s in 0.1-ns steps.)
- Decimation: Skips the detection of search conditions for the specified number of counts. (The selectable range is 1 to 9999.)

Search Range (Start/End Point)

Set the search start and stop points (Start Point/End Point) in the range shown below. However, if the search type is not set to Edge or Pulse Width, End Point is fixed at +5 div.

Selectable range: -5 to +5 divisions

Executing a Search (Search)

The DLM4000 searches for positions where the specified search conditions are met. Then, the DLM4000 displays the waveform expanded in the zoom window with the detected point that corresponds to the number you specify at the center.

Detected Points

The detected points are the same as the trigger points.

Detected Point number (Pattern No.)

Specify the number of the detected point that you want to display in the zoom window.

Detected points are numbered in order. The first detected point is zero.

The maximum detected point number is 50000.



-
- You cannot search while waveform acquisition is in progress (RUN).
 - You cannot search accumulated waveforms.
-

15 Analyzing and Searching Serial Bus Signals

The DLM4000 can decode frames, fields, and other information from the waveform displayed on the screen. Then, it can display the decoded results along with the waveform on the screen or display a list of detailed decoded results. If you set search conditions and perform a search, you can display the waveform expanded with the beginning of the frame, field, or data that meets the search conditions in the center.

The DLM4000 can perform waveform analysis and searching on up to four serial bus signals (Serial Bus1(S1), Serial Bus2(S2), Serial Bus3(S3), and Serial Bus4(S4)). The DLM4000 can search up to 50000 points on the selected serial bus signal.

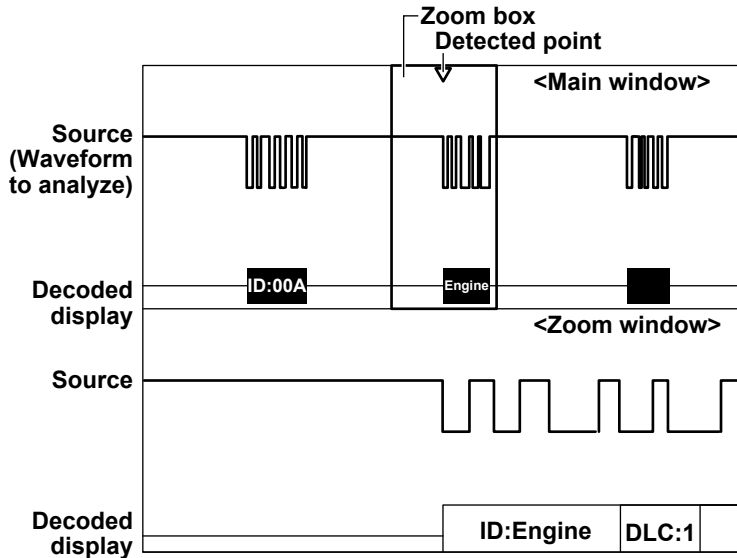

Turning the Analysis and Search Feature On or Off (Display)

Set whether or not to perform serial bus signal analysis and searching. If you turn this feature on, the DLM4000 displays the decoded field values at the bottom of the screen.

- ON: Performs serial bus signal analysis and searching
- OFF: Does not perform serial bus signal analysis and searching

Number of Analyzable and Searchable Frames or Data Bytes

The maximum number of analyzable and searchable frames or data bytes varies depending on the serial bus type as follows:

FlexRay	5000 frames
CXPI	10000 frames
CAN FD	50000 frames
CAN/LIN/SENT	100000 frames
UART/I ² C/SPI/User Define	300000 bytes
PSI5 Airbag	400000 frames

Analysis and Search Source Waveform

You can analyze and search any of the following channel waveforms.

CH1 to CH8/LOGIC(L), LOGIC(A|B), Math1 to Math4

- CH8 or LOGIC(L), whichever the corresponding key is illuminated (CH8 or L), can be selected. LOGIC(A|B) is available on models with the /L16 option.
- You can select LOGIC only for SENT, UART, I²C, and SPI serial bus signals. If you select LOGIC, select the [source bit](#).



- If you select a channel that a reference waveform has been loaded into, you can analyze and search through the reference waveform. ► [See here](#).
 - If you set the source to a channel (CH1 to CH8) that a waveform has been loaded into, you can analyze and search through the loaded waveform.
 - Set the time scale and record length so that the sample rate displayed in the upper right of the screen is at least 10 times the signal bit rate. The DLM4000 may not be able to analyze or search if the sample rate is low.
-

Serial Bus Signal Type (Type)

Select the serial bus signal type to analyze and search from one of the settings below. FlexRay, CAN, CAN FD, LIN, CXPI, SENT, PSI5 Airbag, UART, I²C, and SPI are options.

- [FlexRay](#): FlexRay bus signal
- [CAN](#): CAN bus signal
- [CAN FD](#): CAN FD bus signal
- [LIN](#): LIN bus signal
- [CXPI](#): CXPI bus signal
- [SENT](#): SENT signal
- [PSI5 Airbag](#): PSI5 Airbag signal
- [UART](#): UART signal
- [I2C](#): I²C bus signal
- [SPI](#): SPI bus signal
- [User Define](#): User-defined serial bus signal

Bus Setup (Setup)

Configure the settings necessary for serial bus signal analysis. The settings vary depending on the bus type.

Auto Setup (Auto Setup)

If you specify the serial bus type and source, the DLM4000 can automatically set the bit rate and source level.

The auto setup feature will not work properly on some input signals.

You can cancel auto setup by pressing the Abort soft key.

Search Setup (Search)

Set the serial bus signal search conditions. The conditions that you set vary depending on the bus type.

Specifying the Zoom Window (Result Window)

Select the Zoom1 or Zoom2 window to display an expanded view of the detected points.

You only need to make this selection when both the Zoom1 and Zoom2 displays are turned on.



If the Zoom1 and Zoom2 displays are both off and you press SERIAL BUS (SHIFT+SEARCH) and then set Display to ON, the Zoom1 display turns on.

Detected Point number (Pattern No.)

Specify the number of the detected point (the location where the search condition was met) you want to display in the zoom window.

Detected points are numbered in order. The first detected point is zero.

The maximum detected point number is 50000.

Zoom Position (Z1 Position/Z2 Position)

You can change the zoom position in the zoom window that is specified using Result Window. You can also link the analysis number (List No.) and zoom position settings.

▶ [See here.](#)

Decoded Display (Decode)

The DLM4000 decodes each field value and displays the decoded result using different colors for each field at the bottom of the screen.

The following table shows the available decode display formats.

	Decode Format	Hex	Dec	Bin	ASCII	Symbol
	FlexRay	Yes	No	Yes	No	No
	CAN	Yes	No	Yes	No	Yes*
	CAN FD	Yes	No	Yes	No	Yes*
	LIN	Yes	No	Yes	No	No
Serial Bus	CXPI	Yes	No	Yes	No	No
	SENT	Yes	Yes	No	No	No
	PSI5 Airbag	Yes	Yes	Yes	No	No
	UART	Yes	No	Yes	Yes	No
	I ² C	Yes	No	Yes	Yes	No
	SPI	Yes	No	Yes	Yes	No
	User Define	Yes	No	Yes	Yes	No

- * You can display the decoded results using symbols by converting a CANdb file (.dbc) to a physical value/symbol definition file (.sbl) using the free YOKOGAWA conversion software “Symbol Editor” and by loading the file into the DLM4000.

Display Example

When Bin display is used, a bit order that is appropriate for the displayed waveforms is used regardless of the bit order setting. The bit order setting varies depending on the bus type.

CRC of FlexRay, CAN, CAN FD, I2C, SENT (except when the data type is User), PSI5 Airbag	MSB
Data of LIN, CXPI, PSI5 Airbag	LSB
UART, SPI, SENT (when the data type is User)	LSB or MSB



0	1	0	1	0	0	1	1	Binary display
C		A						Hexadecimal display (bit order: LSB)
5		3						Hexadecimal display (bit order: MSB)

When I²C bus signals are being analyzed, the display of the decoded address pattern is affected by whether the R/W bit is on or off.

7-bit Address Example

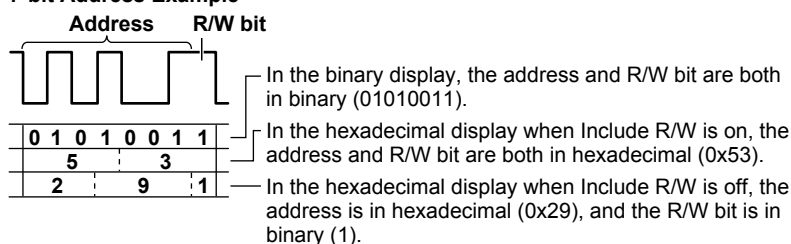

List Setup

You can configure various settings for listing the decoded results. Listing is not possible when the bus type is User Define.

Turning Zoom Linking On and Off (Zoom Link)

When Zoom Link is set to ON, the analysis number and zoom position settings are linked. When Zoom Link is set to OFF, the analysis number and zoom position settings are not linked. The default setting is ON.

List Size (List Size)

Select the list size and display position from one of the settings below.

- Full Screen: Displays the list in full-screen mode
- Half(Upper): Displays the list in the top half of the screen
- Half(Lower): Displays the list in the bottom half of the screen

Showing the List (Show List)

You can display a list of decoded results. You can list the decoded results of four serial bus signals. You can also display the waveform of a specified analysis number in the zoom window. The list display clears when you press ESC.

Detailed List Display

If the bus type is UART (only when Grouping is set to ON), I²C, or SPI, the DLM4000 displays all of the data for the specified analysis number in hexadecimal notation and ASCII codes.

- Pressing SET when the list is displayed shows a detailed list.
- If Data1 and Data2 are present, such as in the case of the four wire system (4wire) of an SPI bus, the detailed list of Data1 and Data2 toggles each time you press SET.
- Data after byte 16 can be displayed in a detailed list.

Analysis Number (List No)

The line on the list that corresponds to the number you select is highlighted. When Zoom Link is set to ON, the zoom window displays the waveform expanded with the start of the frame that corresponds to the selected analysis number at the center of the window.

Trend Display (Trend)

You can display the trend of decoded SENT and PSI5 Airbag signal data. For each analysis of serial bus signals (Serial Bus1 (S1), Serial Bus2 (S2), Serial Bus3 (S3), Serial Bus4 (S4)), up to four trends can be displayed.

Saving the Analysis Results

You can save the analysis results (the data list of the decoded results) in CSV format to a storage medium.

Trend data of SENT signals can also be saved (but not the trend data of PSI5 Airbag signals). The extension is .csv.

For details on saving the serial bus analysis results, see “Serial Bus Analysis Results (Serial Bus)” in chapter 20, “Saving and Loading Data.” ► [See here.](#)

You cannot save the results of analyzing a user-defined serial bus signal (User Define).

Analyzing and Searching FlexRay Bus Signals (Option)

Analysis Source Frame

You can analyze the following frames and patterns.

Frame Start, Error, and ID/Data

For the frame format, see “[FlexRay Bus Trigger](#)” in chapter 4, “Triggering.”

Bus Setup (Setup)

Source (Source)

Set the analysis source to one of the settings below.

CH1 to CH8, Math1 to Math4

* You can select CH8 when the key is illuminated.

Bit Rate (Bit Rate)

Select the FlexRay bus signal’s data transfer rate from one of the settings below.

2.5 Mbps, 5 Mbps, or 10 Mbps

Bus Channel (Channel)

Select A or B.

Sample Point (Sample Point)

The DLM4000 samples at a sample rate of eight times the bit rate. The DLM4000 uses filtering to remove the noise from the sampled data and then digitizes the data.

You can select the number of sample points in the digitized data (bit strobe points) from one of the settings below.

4, 5, or 6

Level and Hysteresis (Level/Hys)

These items are the same as those of the edge search.

▶ [See here.](#)

Auto Setup (Auto Setup)

Executes auto setup based on the specified sources.

The auto setup feature automatically configures the bit rate, bus channel, sample point, level, and hysteresis and triggers on the frame start of the FlexRay bus signal.

You cannot execute auto setup if the source is set to Math1 to Math4.

Jumping to the Specified Field (Field Jump)

You can move the zoom position to the start of the following fields in the frame corresponding to the specified detected point number.

ID, Payload Length, Header CRC, Cycle Count, or CRC

Decoded Display (Decode)

The colors that are used for the fields in the decoded display are as follows:

Indicator	Yellow (Yellow)
Frame ID	Light green (Light Green)
Payload	Pink (Pink)
Header CRC	Light blue (Light Blue)
Cycle Count	Orange (Orange)
Data	Cyan (Cyan)
CRC	Light blue (Light Blue)
BSS	Gray (Gray) fill
Error	Red (Red)
	BSS Error, FES Error:
	Displays the words “BSS Error” or “FES Error” in the field in which the error occurred using black characters on red background.
	Header CRC Error, CRC Error:
	Displays the characters of the field in which an error occurred using black characters on red background.

List Display (List - Show List)

The list displays the following items.

No.	Analysis number. Negative numbers are assigned to frames before the trigger position, and positive numbers are assigned to frames after the trigger position. The DLM4000 can display the analysis results for up to 5000 frames in the range of -5000 to 5000. Pressing RESET highlights frame number zero.
Time(ms)	Displays the time from the trigger position to the start of the byte in milliseconds.
S/D	Displays the frame type. S: Static Frame, D: Dynamic Frame
IND	Displays the states of the four header segment indicators in the following order using bit patterns. Payload preamble indicator, Null frame indicator, Sync frame indicator, Startup frame indicator
ID	Displays the 11-bit frame ID in decimal notation.
Len	Displays the data length of the payload segment in decimal notation.
CC	Displays the cycle-count value in decimal notation.
Data	Displays Data 0 to Data n of the payload segment (n = byte 0 to 253) in hexadecimal notation.
Information	Displays information about the next error. If multiple errors are detected in one frame, the DLM4000 displays the error with the highest precedence. The errors are listed below in order of precedence with the highest precedence error first. BSS Error: BSS not detected, FES Error: FES not detected, Header CRC Error: Incorrect header CRC, CRC Error: incorrect CRC

Search Setup (Search)

Search Type (Mode)

Select the FlexRay bus signal search type from one of the settings below.

- Frame Start: Searches for the starting position of the frame
 - Error: Searches for errors
 - ID/Data: Searches for the position where the AND condition of the ID bit pattern and Data pattern is met
- If you select Error, set the error type; if you select ID/Data, set the search conditions.

Error Type (Error Type OR)

If the search type is set to Error, you can select the error types to search for from one of the settings below.

Header CRC	Header CRC errors
CRC	Frame CRC errors
BSS	BSS errors (BSS falling edge not at the specified location)
FES	FES errors (FES rising edge not at the specified location)

Search Conditions (Condition Setup)

If you set the search type to ID/Data, you can set the Indicator, ID, Cycle Count, and Data1 search conditions. The method to set search conditions is the same as that for the trigger conditions of the FlexRay bus trigger.

▶ [See here.](#)

Executing a Search (Search)

The DLM4000 searches for locations where the specified search conditions are met. Then, the DLM4000 displays the frame corresponding to the specified detected point number (Pattern No.) expanded in the zoom window.

Detected Points

The detected points are the same as the trigger points.

▶ [See here.](#)

Analyzing and Searching CAN Bus Signals (Option)

Analysis Source Frame

The following frames can be analyzed.

Remote, data, error, and overload frames

For the CAN frame format, see “CAN Bus Trigger” in chapter 4, “Triggering.”

Bus Setup (Setup)

Source (Source)

Set the analysis source to one of the settings below.

CH1 to CH8, Math1 to Math4

* You can select CH8 when the key is illuminated.

Bit Rate (Bit Rate)

Select the CAN bus signal's data transfer rate from one of the settings below.

33.3 kbps, 83.3 kbps, 125 kbps, 250 kbps, 500 kbps, 1 Mbps, or User Define

If you select User Define, set the transfer rate in the range of 10 kbps to 1 Mbps in 0.1-kbps steps.

Recessive Level (Recessive)

Select the recessive level from one of the settings below. The logical value of the recessive level is 1, and that of the dominant level is 0 in either setting.

H	The recessive level is greater than the dominant level.
L	The recessive level is less than the dominant level.

Sample Point (Sample Point)

You can set the reference that will be used to determine the bus level (recessive or dominant) in the range of 18.8 to 90.6% in 3.1% steps.

Level and Hysteresis (Level/Hys)

These items are the same as those of the edge search.

▶ [See here.](#)

Auto Setup (Auto Setup)

Executes auto setup based on the specified sources.

The auto setup feature automatically configures the bit rate, recessive level, sample point, level, and hysteresis, and triggers on the start of frame (SOF) of the CAN bus signal.

You cannot execute auto setup if the source is set to Math1 to Math4.

Decoded Display (Decode)

The colors that are used for the fields in the decoded display are as follows:

Arbitration	Light green (Light Green)
Control	Pink (Pink)
Data	Cyan (Cyan)
CRC	Light blue (Light Blue)
Error bit, field in which the error occurred, frame, error frame	Red (Red)
Overload frame	Green (Green)
Frame background	Gray (Gray)
Stuff bits	Gray (Gray) fill

List Display (List - Show List)

The list displays the following items.

No.	Analysis number. Negative numbers are assigned to frames before the trigger position, and positive numbers are assigned to frames after the trigger position. The DLM4000 can display the analysis results for up to 100000 frames in the range of -99999 to 99999. Pressing the RESET key highlights frame number zero.
Time(ms)	Displays the time from the trigger position to the start of the frame in milliseconds.
Frame	Displays the frame type. The DLM4000 can analyze the following four frame types: data frame (Data), remote frame (Remote), error frame (Error), and overload frame (Over load).
ID	Displays the 11-bit standard format ID value or the 29-bit extended format ID value in hexadecimal notation. If decode (Decode) is set to Symbol, the ID is displayed with the message name.
DLC	Displays the number of significant digits in hexadecimal notation.
Data	Displays the data in hexadecimal notation when the frame type is data frame. If decode (Decode) is set to Symbol, Data is displayed with physical values.
CRC	Displays the sequence in hexadecimal notation. This is displayed when the frame type is data frame or remote frame.
Ack	Displays "Y" when an ACK bit is detected and "N" otherwise.
Information	Displays the following error information. If multiple errors are detected in one piece of data, the DLM4000 displays a single error in the following order of precedence. Stuff Error, CRC Error

Search Setup (Search)

Search Type (Mode)

Select the CAN bus signal search type from one of the settings below.

- SOF: Searches for the start-of-frame position
- Error: Searches for errors
- ID/Data: Searches for the position where the AND condition of the ID bit pattern and Data pattern is met

If you set the type to Error or ID/Data, set the search conditions.

The method of setting search conditions is the same as that of setting the CAN Bus trigger conditions.

▶ [See here.](#)

Executing a Search (Search)

The DLM4000 searches for locations where the specified search conditions are met. Then, the DLM4000 displays the frame corresponding to the specified detected point number (Pattern No.) expanded in the zoom window.

Detected Points

The detected points are the same as the trigger points.

▶ [See here.](#)

Jumping to the Specified Field (Field Jump)

You can move the zoom position to the start of the following fields in the frame corresponding to the specified detected point number.

SOF, ID, Control Field, Data Field, CRC, or ACK

Analyzing and Searching CAN FD Bus Signals (Option)

Analysis Source Frame

The following frames can be analyzed.

Remote, data, error, and overload frames

For the CAN FD frame format, see “[CAN FD Bus Trigger](#)” in chapter 4, “Triggering.”

Bus Setup (Setup)

Source (Source)

This item is the same as that of the CAN bus.

▶ [See here.](#)

Bit Rate (Bit Rate)

Select the CAN FD bus signal's arbitration phase data transfer rate from one of the settings below.

250 kbps, 500 kbps, 1 Mbps, User Define

If you select User Define, set the transfer rate in the range of 20 kbps to 1 Mbps in 0.1-kbps steps.

Data Bit Rate (Data BitRate)

Select the CAN FD bus signal's data phase data transfer rate from one of the settings below.

500 kbps, 1 Mbps, 2 Mbps, 4 Mbps, 5 Mbps, 8 Mbps, User Define

If you select User Define, set the transfer rate in the range of 250 kbps to 10 Mbps in 0.1-kbps steps.

The data bit rate can be set as high as 16 times the arbitration phase bit rate.



If the data bit rate exceeds 16 times the bit rate, the rates are automatically adjusted according to the last set value so that the relationship “data bit rate \leq bit \times 16” is maintained.

Sample Point (Sample Point)

Set the reference that will be used to determine the bus level (recessive or dominant) in the range of 18.8 to 90.6% in 0.1% steps.

Recessive Level (Recessive)

This item is the same as that of the CAN bus.

▶ [See here.](#)

CAN FD Standard (FD Standard)

Select the compliant standard for the CAN FD bus signal to be applied. This setting is linked to FD Standard of the trigger menu.

- ISO: ISO 11898-1: Analyzed as a 2015-compliant CAN FD bus signal.
- non-ISO: ISO 11898-1: Analyzed as a CAN FD bus signal compliant to a standard before 2015.

Level (Level) and Hysteresis (Hys)

These items are the same as those of the edge search.

▶ [See here.](#)

Auto Setup (Auto Setup)

Set the CAN FD standard for the specified source and then execute auto setup.

The auto setup feature automatically configures the bit rate, recessive level, sample point, level, and hysteresis, and triggers on the start of frame (SOF) of the CAN FD bus signal.

You cannot execute auto setup if the source is set to Math1 to Math4.

Decoded Display (Decode)

The colors that are used for the fields in the decoded display are as follows:

Arbitration	Light green (Light Green)
Control ¹	Pink (Pink)
Data	Cyan (Cyan)
Stuff Count ²	Light blue (Light Blue)
CRC	Light blue (Light Blue)
Error bit, field in which the error occurred, ³ frame, error frame	Red (Red)
Overload frame	Green (Green)
Frame background	Gray (Gray)
Stuff bits	Gray (Gray) fill
ESI bit and frame when the ESI bit is recessive ³	Orange (Orange)
FDF bit and frame when the FDF bit is recessive ³	Dark blue (Dark Blue)
Frame when the FDF bit is dominant ³	Light blue (Light Blue)

- 1 If the FDF bit is recessive and display space is available, FD is displayed in front of DLC.
- 2 This appears when the CAN FD standard (FD Standard) is set to ISO.
- 3 The order of precedence when these frames overlap is the frame in which the error occurred, frame when the ESI bit is recessive, the frame when the FDF bit is dominant, and the frame when the FDF bit is recessive.

List Display (List - Show List)

The list displays the following items.

No.	Analysis number. Negative numbers are assigned to frames before the trigger position, and positive numbers are assigned to frames after the trigger position. The DLM4000 can display the analysis results for up to 50000 frames in the range of -49999 to 49999. Pressing the RESET key highlights frame number zero.
Time(ms)	Displays the time from the trigger position to the start of the frame in milliseconds.
Frame	Displays the frame type. The DLM4000 can analyze the following four frame types: data frame (Data), remote frame (Remote), error frame (Error), and overload frame (Overload). If the FDF bit is recessive, FD is displayed in front of Data.
ID	Displays the 11-bit standard format ID value or the 29-bit extended format ID value in hexadecimal notation. If decode (Decode) is set to Symbol, the ID is displayed with the message name.
DLC	Displays the number of significant digits in hexadecimal notation.
Data	Displays the data in hexadecimal notation when the frame type is data frame. If decode (Decode) is set to Symbol, Data is displayed with physical values. If the number of bytes is 9 or higher, every 8 bytes of data is displayed in its own line.
SC	Displays the 4-bit value of the stuff bit count and parity in hexadecimal notation. This appears when the CAN FD standard (FD Standard) is set to ISO.
CRC	Displays the sequence in hexadecimal notation. This is displayed when the frame type is data frame or remote frame.
Ack	Displays "Y" when an ACK bit is detected and "N" otherwise.
Information	Displays the following error information. If multiple errors are detected in one piece of data, the DLM4000 displays a single error in the following order of precedence. Stuff Error, Fixed Stuff Error, CRC Error If the CAN FD standard (FD Standard) is set to ISO, the CRC error is displayed as follows according to the error type. CRC Error (SC): Stuff Count error, CRC Error (Seq): CRC Sequence error, CRC Error (SC,Seq): Both Stuff Count and CRC Sequence error In addition to error information, if the ESI bit is recessive (error passive), "ESI(Error Passive)" is displayed.

Search Setup (Search)

Search Type (Mode)

Select the CAN FD bus signal search type from one of the settings below.

- SOF: Searches for the start-of-frame position
- Error: Searches for errors
- ID/Data: Searches for the position where the AND condition of the ID bit pattern and Data pattern is met
- FDF: Searches for an FDF bit state
- ESI (Error Passive): Searches for when the ESI bit is recessive (error passive)

If you select Error, ID/Data, or FDF, set the search conditions.

The method to set search conditions is the same as that for the trigger conditions of the CAN FD bus trigger.

▶ [See here.](#)

Executing a Search (Search)

The DLM4000 searches for locations where the specified search conditions are met. Then, the DLM4000 displays the frame corresponding to the specified detected point number (Pattern No.) expanded in the zoom window.

Detected Points

The detected points are the same as the trigger points.

▶ [See here.](#)

Jumping to the Specified Field (Field Jump)

You can move the zoom position to the start of the following fields in the frame corresponding to the specified detected point number.

SOF, ID, Control Field, Data Field, CRC, or ACK

Analyzing and Searching LIN Bus Signals (Option)

Analysis Source Field

You can analyze the following fields and patterns.
Break, Synch, ID, Data, or Checksum

For the LIN frame format, see “[LIN Bus Trigger](#)” in chapter 4, “Triggering.”

Bus Setup (Setup)

Source (Source)

CH1 to CH8, Math1 to Math4

* You can select CH8 when the key is illuminated.

Bit Rate (Bit Rate)

Select the LIN bus signal’s data transfer rate from one of the settings below.

1200 bps, 2400 bps, 4800 bps, 9600 bps, 19200 bps, or User Define

If you select User Define, set the transfer rate in the range of 1000 bps to 20000 bps in 10-bps steps.

Revision (Revision)

Set the revision to one of the settings below.

- LIN 1.3: Only uses classic checksums, which only include the data field.
- LIN 2.1: Only uses enhanced checksums that include the protection ID.
However, classic checksums are used for ID = 60 (0x3c) to 63 (0x3f).
- Both: Uses both the enhanced check sum and the classic checksum.

Sample Point (Sample Point)

You can set the reference that will be used to determine the bus level in the range of 18.8 to 90.6% in 3.1% steps.

Level and Hysteresis (Level/Hys)

These items are the same as those of the edge search.

▶ [See here.](#)

Auto Setup (Auto Setup)

Executes auto setup based on the specified sources.

The auto setup feature automatically configures the bit rate, revision, sample point, level, and hysteresis, and triggers on the LIN bus signal’s Break Synch.

You cannot execute auto setup if the source is set to Math1 to Math4.

Decoded Display (Decode)

The colors that are used for the fields in the decoded display are as follows:

Break	Orange (Orange)
Synch	Pink (Pink)
ID	Light green (Light Green)
Data	Cyan (Cyan)
Checksum	Light blue (Light Blue)
WakeUp	Green (Green)
Start Bit	Gray (Gray) fill
Stop Bit	Gray (Gray) fill
Error	Red (Red)
	Timeout Error: Displays a thick red line in the area where an error has occurred.
	Framing Error: Displays the words “Framing Error” in the field in which an error occurred using black characters on red background. The DLM4000 displays this error with higher precedence than checksum, synch, and parity errors.
	Checksum Error, Synch Error, Parity Error: Displays the characters of the synch, ID, or checksum field in which an error occurred using black characters on red background.

List Display (List - Show List)

The list displays the following items.

No.	Analysis number. Negative numbers are assigned to frames before the trigger position, and positive numbers are assigned to frames after the trigger position. The DLM4000 can display the analysis results for up to 100000 frames in the range of -99999 to 99999. Pressing the RESET key highlights frame number zero.
Time(ms)	Displays the time from the trigger position to the start of the frame in milliseconds.
ID	Displays the ID value in hexadecimal notation.
ID-Field	Displays the ID value including the 2-bit parity in hexadecimal notation.
Data	Displays the data in hexadecimal notation.
Checksum	Displays the checksum value in hexadecimal notation.
Information	Detects and displays the following signals and errors. If a WakeUp signal is detected, the DLM4000 displays "WakeUp." If multiple errors are detected in one frame, the DLM4000 displays the error with the highest precedence. The errors are listed below in order of precedence with the highest precedence error first. Timeout-Error, Framing-Error, Checksum-Error, Synch-Field-Error, ID-Parity-Error

Search Setup (Search)

Search Type (Mode)

Select the LIN bus signal search type from one of the settings below.

- Break Synch: Searches for break and synch fields
- Error: Searches for errors
- ID/Data: Searches for both the ID bit pattern and Data pattern (AND)

The method of setting Break Sync and ID/Data is the same as that of setting the LIN bus trigger conditions.

However, you cannot specify the break length as a search condition.

▶ [See here.](#)

Error Type (Error Type)

If you set the search mode to Error, select the error types to search for from the following settings.

Parity	The DLM4000 calculates the parity of the protected identifier field. If the result does not satisfy the following equations, the DLM4000 triggers on the protected identifier field's stop bit position. Even Parity Check: $ID0 \text{ xor } ID1 \text{ xor } ID2 \text{ xor } ID4 \text{ xor } P0 = 0$ $P0 = ID0 \text{ xor } ID1 \text{ xor } ID2 \text{ xor } ID4$ ODD Parity Check: $ID1 \text{ xor } ID3 \text{ xor } ID4 \text{ xor } ID5 \text{ xor } P1 = 1$ $P1 = \neg(ID1 \text{ xor } ID3 \text{ xor } ID4 \text{ xor } ID5)$
Checksum	Revision LIN 1.3 (classic checksum): If the calculated result of all data fields and the checksum is not 0xFF, the DLM4000 triggers on the checksum field's stop bit position. Revision LIN 2.1 (enhanced checksum): If the total value ¹ of the protected identifier field, all data fields, and the checksum is not 0xFF, the DLM4000 triggers on the checksum field's stop bit position. However, if the protected identifier field ID is from 60 (0x3c) to 63 (0x3f), the DLM4000 triggers based on the calculated result of the classic checksum.
Synch	If the synch field is not 0x55, the DLM4000 triggers on the synch field's stop bit position.
Timeout	The DLM4000 triggers if any of the following three errors occurs. Slave Not Responding Error: After a break detection, if the frame is not finished before the time determined by the following equation elapses, the DLM4000 triggers. $1.4 \times (T_{\text{Header}}^2 + T_{\text{Response}}^3)$ Header Timeout Error: After a break detection, if the header is not finished before the time determined by the following equation elapses, the DLM4000 triggers. $1.4 \times T_{\text{Header}}^2$ Response Timeout Error: After a break detection, if the response is not finished before the time determined by the following equation elapses, the DLM4000 triggers. $1.4 \times T_{\text{Response}}^2$
Framing	When a low-level stop bit is detected in the field, data, or checksum, the DLM4000 triggers. The DLM4000 may trigger if it detects a break and synch field in the middle of a frame.

- 1 If the value exceeds 255, it is carried over.
- 2 Nominal header length $T_{\text{Header}} = 34 \times \text{TBIT}^4$
- 3 Nominal response length $T_{\text{Response}} = 10 \times (N+1) \times \text{TBIT}^4$ (where N is the data length)
- 4 Nominal time needed to transmit one bit defined in the physical layer.

Executing a Search (Search)

The DLM4000 searches for locations where the specified search conditions are met. Then, the DLM4000 displays the frame corresponding to the specified detected point number (Pattern No.) expanded in the zoom window.

Detected Points

The detected points are the same as the trigger points.

▶ [See here.](#)

Jumping to the Specified Field (Field Jump)

You can move the zoom position to the start of the following fields in the frame corresponding to the specified detected point number (Pattern No.).

Break, Synch, ID, Data, or Checksum

Analyzing and Searching CXPI Bus Signals (Option)

Analysis Source

Normal frames, long frames, sleep frames, wakeup pulses, wakeup state, sleep state

Normal Frame

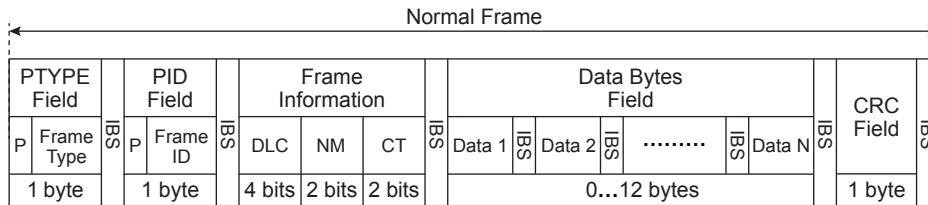

Long Frame

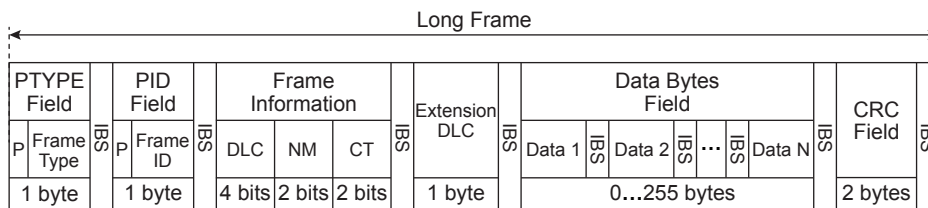

Bus Setup (Setup)

Source (Source)

Set the analysis source to one of the settings below.

CH1 to CH8, Math1 to Math4

* You can select CH8 when the key is illuminated.

Bit Rate (Bit Rate)

Select the CXPI bus signal's data transfer rate from one of the settings below.

4800bps, 9600bps, 19200bps, User Define

If you select User Define, set the transfer rate in the range of 4000 bps to 50000 bps in 10-bps steps.

T Sample (T Sample)

Set the sum value, T Sample, for determining the logical value of the current bit.

The value in which T Sample is added to the low width of logical value 1 detected with the last bit is used as the threshold to determine the value as follows:

- Logical value 1 when the low width of the current bit is less than or equal to the threshold
- Logical value 0 when the low width of the current bit is greater than the threshold

Selectable range: 0.010 Tbit to 0.300 Tbit

Resolution: 0.001 Tbit

* Tbit is the time width of a bit calculated from the bit rate.

Clock Tolerance (Clock Tolerance)

Set the tolerance of the clock width calculated from the bit rate.

Selectable range: $\pm 0.5\%$ to $\pm 10.0\%$

Resolution: 0.1%

Counter Error Detection (Counter Error Detection)

Set whether to detect counter errors.

- ON: Counter errors are detected.
- OFF: Counter errors are not detected.

Level (Level) and Hysteresis (Hys)

You can set the level and hysteresis for detecting the signal high and low states. These items are the same as those of the edge search.

▶ [See here.](#)

Auto Setup (Auto Setup)

Executes auto setup based on the specified sources.

The auto setup feature automatically configures the bit rate, level, and hysteresis and triggers on the start of frame (SOF) of the CXPI bus signal. [Appendix 7](#) shows the low width range of logical value 1 and 0 that cause triggers.

You cannot execute auto setup if the source is set to Math1 to Math4.

Decoded Display (Decode)

The colors that are used for the fields in the decoded display are as follows:

PTYPE	Pink (Pink)
ID	Light green (Light Green)
DLC, Extension DLC*	Pink (Pink)
CT	Orange (Orange)
NW(Sleep.ind/ Wakeup.ind)	Yellow (Yellow)
Data	Cyan (Cyan)
CRC	Light blue (Light Blue)
Parity	Yellow (Yellow)
Start Bit	Gray (Gray) fill
Stop Bit	Gray (Gray) fill
IBS	Gray (Gray) fill
Wakeup pulse	Green (Green)
Error	Red (Red)

Parity Error, CRC Error, Counter (CT) Error:
Characters in the parity, CRC, or CT field in which an error occurred are displayed in black on a red background.

Data Length Error:
When the data length is less than DLC, characters in the DLC field is displayed in black on a red background.
When the data length is greater than DLC, characters in the exceeded field is displayed in black on a red background.

Framing Error:
"Framing Error" is displayed in black on a red background in the field after the error occurrence.

IBS Error:
"IBS Error" is displayed in black on a red background in the IBS field.

Clock Error:
"•••" is displayed in black on a red background in the field that the error occurred in.

* Extension DLC applies to long frames.

List Display (List/Trend - Show List)

The list displays the following items.

No.	Analysis number. Negative numbers are assigned to frames before the trigger position, and positive numbers are assigned to frames after the trigger position. The DLM4000 can display the analysis results for up to 10000 frames in the range of -9999 to 9999. Pressing the RESET key highlights frame number zero.
Time(ms)	Displays the time from the trigger position to the start of the frame in milliseconds.
ID	Displays the ID value in hexadecimal notation. "SLEEP" is displayed for sleep frames. If there is a PTYPE Field, "P" is displayed in front of the ID value.
DLC	Displays the DLC value in decimal notation. For long frames, the character "L" is followed by the extension DLC value in decimal notation.
W/S	Displays the wakeup indicator and then the sleep indicator in binary notation.
CT	Displays the counter value in decimal notation.
Data	Displays the data in hexadecimal notation. 12 bytes of data is displayed in each row.
CRC	Displays the CRC value in hexadecimal notation.
Information	Displays the following information. Wakeup, wakeup pulse, sleep, various errors If multiple errors are detected in a frame, up to two errors are displayed in the following order. PTYPE-Parity error, ID-Parity error, CRC error, data length error, framing error, IBS error, clock error, counter error

Search Setup (Search)

Search Type (Mode)

Select the CXPI bus signal search type from one of the settings below.

- SOF: Searches for the start-of-frame position
- Error: Searches for errors
- **PTYPE**: Searches for PTYPE
- **ID/Data**: Searches for the position where the AND condition of the ID bit pattern, frame information, and data pattern is met
- **Wakeup/Sleep**: Searches for wakeup pulses, wakeup states, sleep frames, and sleep states

SOF(Start of Frame)

The DLM4000 searches for the start position of CXPI bus signal frames.

Error

The DLM4000 searches for various errors.

- **Error Type (Error Type OR)**

Parity	When a parity error is detected
CRC	When a CRC error is detected
Data Length	When the DLC value and the number of data pieces in the data field (data length) do not match
Framing	When the logical value of the stop bit of a field or the stop bit of data is 0
IBS	When the number of IBS bits is 10 or more
Counter	When a counter error is detected (can be set as a search item when the counter error detection is set to ON)
Clock	When the clock width exceeds the specified tolerance

PTYPE

The DLM4000 searches for PTYPE.

ID/Data

The DLM4000 searches normal, long, and sleep frames.

The DLM4000 searches on the AND of SOF, ID, frame information, and data conditions.



-
- If you specify X in the ID bit pattern, frame information, or data pattern, the condition is assumed to be met regardless of the corresponding bit or item status.
 - In a bit pattern or data pattern setting, if a binary pattern contains any Xs, the corresponding hexadecimal display will be "\$."
-

- **Search Conditions (Condition Setup)**

On the Condition Setup screen, set the search conditions such as the frame information and data.

SOF

When the start of a CXPI bus signal is detected when the search condition is set to SOF only, the DLM4000 detects it as a detected point. SOF of ID/Data is always selected as a search condition.

ID

with PTYPE

Whether the frame contains PTYPE is used as a search condition.

- Yes: Detects the ID of frames containing PTYPE
- No: Detects the ID of frames not containing PTYPE
- X: Detects the ID regardless of the presence of PTYPE

Input Format (Input format)

Set the ID input format to Bin (binary) or Hex (hexadecimal).

Bit Pattern

Set the 7-bit ID bit pattern in hexadecimal or binary notation. The ID search condition is met when the input signal ID bit pattern matches the specified bit pattern.

Frame Information

The wakeup and sleep indicators of frame information and CT bit value are used as search conditions.

- Wakeup: Set the wakeup indicator bit value to 0, 1, or X.
- Sleep: Set the sleep indicator bit value to 0, 1, or X.
- CT: Set the counter bit value to a value from 0 to 3 or X.

Data

You can set a search condition based on the data value. Specify the size, position, condition, and data pattern settings.

Comparison Size (Size)

Set the data length to be compared. The data pattern with the specified data length is compared to the input signal data pattern. If "0" is specified, the DLM4000 assumes that a point has been detected regardless of the input signal's data value.

Selectable range: 0 to 8 bytes

Comparison Start Position (Position)

Set the position to start comparing the data pattern. The left end of the data is position 0.

Selectable range: 0 to 254 bytes



- If the comparison size (Size) is set to 0, comparison start position (Position) cannot be set.
- The selectable range for position is limited so that Size + Position is less than or equal to 255.

Comparison Condition (Condition)

The data search condition is met when the result of comparing the data pattern or reference value to the input signal's data meets the specified comparison condition.

True	When the value matches the data pattern
False	When the value does not match the data pattern
Data = a ¹	When the value is equal to the reference value
Data ≠ a ¹	When the value is not equal to the reference value
a ≤ Data ¹	When the value is greater than or equal to the reference value
Data ≤ b ¹	When the value is less than or equal to the reference value
a ≤ Data ≤ b ²	When the value is within the reference range (including the reference values)
Data < a, b < Data ²	When the value is outside the reference range (excluding the reference values)

1 Set one reference value

2 Set two reference values

Input Format (Input format)

Set the data pattern input format to Bin (binary) or Hex (hexadecimal).

Data Pattern

If the comparison condition is set to True or False, set the data pattern for the specified data size in hexadecimal or binary notation.

Reference Values (a and b)

If the comparison condition is set to Data = A, Data ≠ a, a ≤ Data, Data ≤ b, a ≤ Data ≤ b, or "Data < a or b < Data," set the reference values in decimal notation. You must set the byte order (Endian), sign (Sign), and comparison range (MSB or LSB). The selectable ranges are as follows:

Unsigned (Unsign)	0 to 9E+18 The selectable maximum value is limited by the data length and bit position, which are determined by the Size and MSB/LSB settings, respectively.
Signed (Sign)	-9E+18 to 9E+18 The selectable minimum and maximum values are limited by the data length and bit position, which are determined by the Size and MSB/LSB settings, respectively.

The value is displayed in scientific notation when the number of digits exceed seven (example: 1234567E+10).



If the comparison condition is $a \leq \text{Data} \leq b$ or “Data < a or b < Data,” the two reference values are automatically adjusted so that the lower limit is less than or equal to the upper limit.

Byte Order (Endian), Sign (Sign), and Comparison Range (MSB/LSB)

These items are the same as those of the CAN bus trigger.

▶ [See here.](#)

Wakeup/Sleep

The DLM4000 searches for wakeup pulses, wakeup states, sleep frames, or sleep states.

- **Wakeup/Sleep Type OR**

Wakeup Pulse	When a pulse in the dominant period between 250 μs and 2500 μs is detected
Wakeup	When a transition is made from a state in which there is no clock to a state in which there is a clock
Sleep Frame	When the sleep frame ID value is 1F (hexadecimal)
Sleep	When a transition is made from a state in which there is a clock to a state in which there is no clock

Executing a Search (Search)

The DLM4000 searches for locations where the specified search conditions are met. Then, the DLM4000 displays the specified detected point number (Pattern No) expanded in the zoom window.

Detected Points

The following figures illustrate the detected points.

• **Normal Frame**

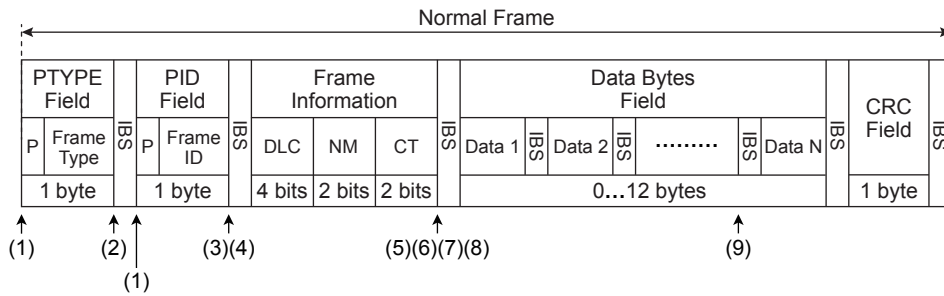

PTYPE is an option for the polling method.

Positions (1) to (9) above are detected points for the following conditions.

(1) SOF	End position of the start bit of a PTYPE or PID field
(2) PTYPE	End position of the stop bit of a PTYPE field
(3) ID	End position of the stop bit of a PID field
(4) Sleep frame	End position of the stop bit of a PID field
(5) Wakeup	End position of the stop bit of a frame information field
(6) Sleep	End position of the stop bit of a frame information field
(7) CT	End position of the stop bit of a frame information field
(8) Data (when Size = 0)	End position of the stop bit of a frame information field
(9) Data (when Size ≠ 0)	End position of the stop bit of a specified data bytes field

Error Detection Points

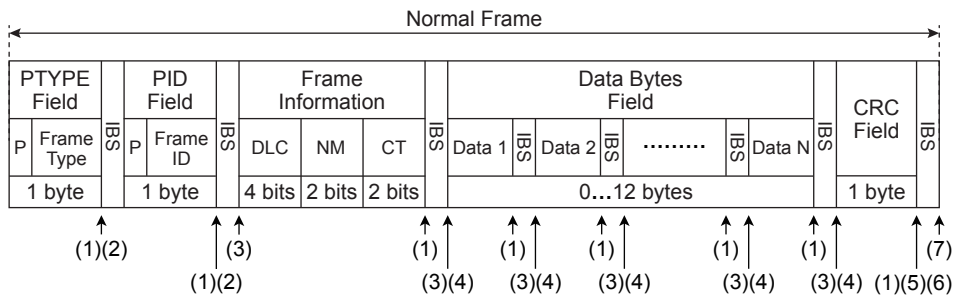

Positions (1) to (7) above are detected points for the following errors.

(1) Framing Error	End position of the bit corresponding to the stop bit of each field
(2) Parity Error	End position of a PTYPE or PID stop bit
(3) IBS Error	End position of the 10th consecutive logical value 1 bit from the end position of the stop bit of each field (excluding PTYPE)
(4) Data Length Error (When data length < DLC)	End position of the 10th consecutive bit with logical value 1 counted from the end position of the stop bit of the last data bytes field
(5) CRC Error	End position of the stop bit of a CRC field
(6) Counter Error	End position of the stop bit of a CRC field
(7) Data Length Error (When data length > DLC)	End position of the start bit of an exceeding byte field

• Long Frame

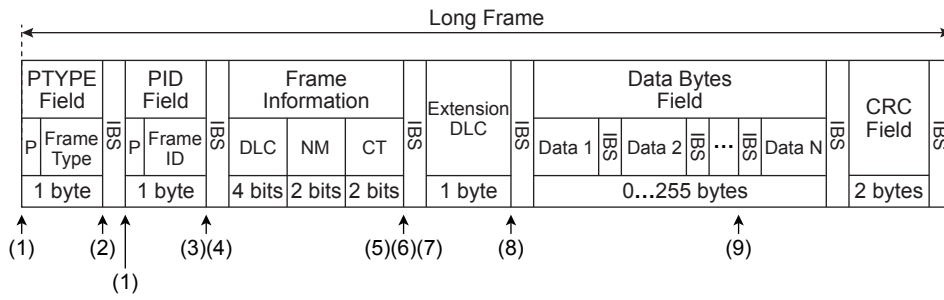

PTYPE is an option for the polling method.

Positions (1) to (9) above are detected points for the following conditions.

(1) SOF	End position of the start bit of a PTYPE or PID field
(2) PTYPE	End position of the stop bit of a PTYPE field
(3) ID	End position of the stop bit of a PID field
(4) Sleep frame	End position of the stop bit of a PID field
(5) Wakeup	End position of the stop bit of a frame information field
(6) Sleep	End position of the stop bit of a frame information field
(7) CT	End position of the stop bit of a frame information field
(8) Data (when Size = 0)	End position of the stop bit of a extension DLC field
(9) Data (when Size ≠ 0)	End position of a specified data stop bit

Error Detection Points

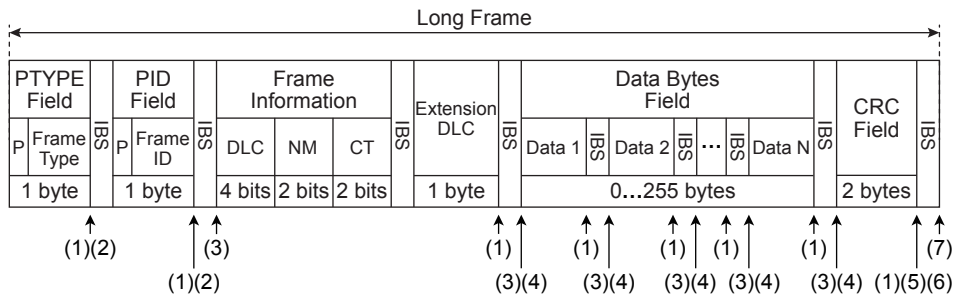

Positions (1) to (7) above are detected points for the following errors.

(1) Framing Error	End position of the bit corresponding to the stop bit of each field
(2) Parity Error	End position of a PTYPE or PID stop bit
(3) IBS Error	End position of the 10th consecutive logical value 1 bit from the end position of the stop bit of each field (excluding PTYPE)
(4) Data Length Error (When data length < DLC)	End position of the 10th consecutive bit with logical value 1 counted from the end position of the stop bit of the last data bytes field
(5) CRC Error	End position of the stop bit of a CRC field
(6) Counter Error	End position of the stop bit of a CRC field
(7) Data Length Error (When data length > DLC)	End position of the start bit of an exceeding byte field

• **Wakeup Pulse**

The detected point is the rising edge after a dominant period ranging from 250 μ s to 2500 μ s.

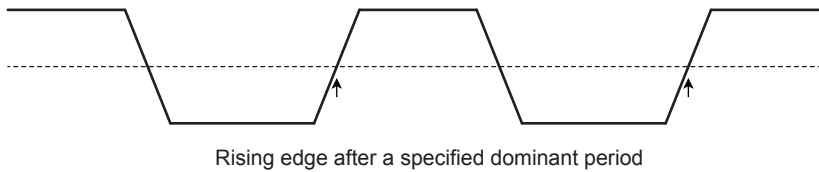

• **Wakeup/Sleep**

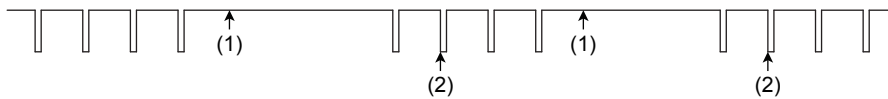

Positions (1) and (2) above are detected points for the following conditions.

(1) Sleep	Position at $1 \text{ Tbit} \times (1 + (\text{absolute value of clock tolerance})/100)$ from the last falling edge of the ending clock
(2) Wakeup	Clock detection position (where 1 clock is guaranteed)

• **Clock Error**

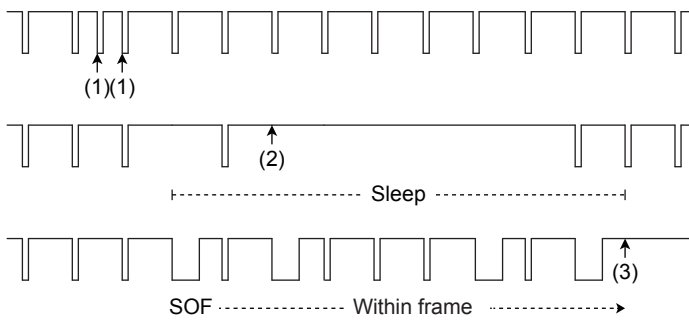

Positions (1) to (3) above are detected points for the following conditions.

(1) Clock Error	Position where a clock less than clock error $1 \text{ Tbit} \times (1 - (\text{absolute value of clock tolerance})/100)$
(2) Clock Error	Position at $1 \text{ Tbit} \times (1 + (\text{absolute value of clock tolerance})/100)$ from the falling edge detected during clock error sleep
(3) Clock Error	Position at $1 \text{ Tbit} \times (1 + (\text{absolute value of clock tolerance})/100)$ from the last falling edge of the ending clock in the frame or position at $1 \text{ Tbit} \times (1 - \text{absolute value of clock tolerance}/100)$ regardless of whether the position is in or outside the frame.

Analyzing and Searching SENT Signals (Option)

Analysis Source

Fast channel and slow channel of SENT signals

For the SENT frame format, see “[SENT Trigger](#)” in chapter 4, “Triggering.”

Bus Setup (Setup)

Source (Source)

Set the analysis source to one of the settings below. If you select LOGIC, select the [source bit](#).

CH1 to CH8/LOGIC(L), LOGIC(A|B), Math1 to Math4

* CH8 or LOGIC(L), whichever the corresponding key is illuminated (CH8 or L), can be selected. LOGIC(A|B) is available on models with the /L16 option.

Format (Format)

This item is the same as that of Version, Clock Tick, Clock Tolerance, Data Nibbles, Pause Pulse, CRC Type, and Customize Error Factor of the SENT signal trigger.

▶ [See here.](#)

Display Channel (Display)

Select the channel to be decoded and listed from one of the settings below.

- Both: Both fast channel and slow channel are displayed.
- Fast CH: Fast channel is displayed.
- Slow CH: Slow channel is displayed.

Fast Channel Data Type (Fast CH_Data Type)

Select the fast channel data display method from one of the settings below.

Nibble: Set a 4 to 24 bit data pattern in unit of nibbles (4 bits).

User: Set the data sizes of Data1 to Data4 in the range of 0 to 24 bits.

- Select whether or not to display Data1 to Data4.
- The total number of bits for Data1 to Data4 is up to 24. If you try to exceed the total number of bits, the data size of other pieces of Data is reduced. If as a result of executing auto setup (explained later), the number of data nibbles in the input SENT signal is less than six, the total number of bits that can be specified is up to (the number of data bits) × 4.
- Set the nibble order (Order) to Big or Little.

Slow CH Type (Slow CH Type)

Select the slow channel message type from one of the settings below. This is selectable when the format version (explained earlier) is APR2016 or JAN2010.

- Short: Short message
- Enhanced: Enhanced message

Level (Level) and Hysteresis (Hys)

These items are the same as those of the edge search.

▶ [See here.](#)

Auto Setup (Auto Setup)

Executes auto setup based on the specified sources.

The auto setup feature automatically configures the format, level, and hysteresis and then triggers at the end of S&C of the fast channel. You cannot execute auto setup when:

- The sources is set to Math1 to Math4.
- State display is applied to a LOGIC bit that is set as the source.

Decoded Display (Decode)

The colors that are used for the fields in the decoded display are as follows:

Fast CH

SYNC/CAL	Pink (Pink)
S&C	Yellow (Yellow)
Data	Cyan (Cyan)
CRC	Light blue (Light Blue)
Pause	Orange (Orange)
Error	Red (Red)

Depending on the error type, the red area is applied as follows:
 Successive CAL Pulses: SYNC/CAL field
 Nibble Number: Entire frame
 Nibble Data Value: Nibble of the relevant data
 Fast CH CRC: CRC field
 Status and Communication(S&C): S&C field

Slow CH

ID	Light green (Light Green)
Data	Cyan (Cyan)
CRC	Light blue (Light Blue)
Error	Red (Red)

Depending on the error type, the red area is applied as follows:
 Error present in the corresponding fast channel: Frame borders
 Slow CH CRC: CRC background and frame borders

List Display (List/Trend - Show List)

The list displays the following items.

Fast CH

No.	Analysis number. Negative numbers are assigned to frames before the trigger position, and positive numbers are assigned to frames after the trigger position. The DLM4000 can display the analysis results for up to 100000 frames in the range of -99999 to 99999. Pressing the RESET key highlights frame number zero.
Time(ms)	Displays the time from the trigger position to the start of the frame in milliseconds.
Sync(μ s)	Displays the time period of the SYNC/CAL field.
Tick(μ s)	Displays the time period of a clock tick.
S&C	Displays the time period of the S&C field.
Data	Displays data in hexadecimal or decimal notation.
CRC	Displays the CRC value in hexadecimal or decimal notation.
Length(tick)	Displays the frame length.
Information	Displays the following error information. If multiple errors are detected in a frame, the DLM4000 displays a single error in the following order of precedence. Successive CAL Pulses, Nibble Number, Nibble Data Value, Fast CH CRC, Status and Communication(S&C)
Slow CH	This item is displayed when the display channel (Display) is set to Both. It displays the slow channel information. The corresponding fast channel is enclosed with <START> and <END> tags.

Slow CH

No.	Analysis number. Negative numbers are assigned to frames before the trigger position, and positive numbers are assigned to frames after the trigger position. The DLM4000 can display the analysis results for up to 100000 frames in the range of -99999 to 99999. Pressing the RESET key highlights frame number zero.
Time(ms)	Displays the time from the trigger position to the start of the frame in milliseconds.
ID	Displays message ID in hexadecimal or decimal notation.
Data	Displays data in hexadecimal or decimal notation.
CRC	Displays the CRC value in hexadecimal or decimal notation.
Information	Displays the following error information. If multiple errors are detected in a frame, the DLM4000 displays a single error in the following order of precedence. Fast CH Error, CRC Error

Trend Display (List/Trend - Trend)

Up to four trends (Trend1 to Trend4) of decoded data can be displayed. You can also display the data values using the cursor measurement function.

Trend Display (Display)

Set whether or not to display the trend. The trend is displayed in the Trend window. The trend is not displayed for data of messages that contain errors. Such areas become blank.

- ON: The trend is displayed.
- OFF: The trend is not displayed.

Display Source (Source)

Select the channel to display the trend of from one of the settings below.

- Fast CH: The trend of the fast channel is displayed.
- Slow CH: The trend of the slow channel is displayed.

User Data(User Data)

When the display source is fast channel, select the user data you want to display the trend of. Set the size and order of user data using the fast channel data type menu in the bus setup menu (explained earlier). ► [See here.](#)
Selectable range: 1 to 4

(When version is APR 2016 and Multiplexing is on, the data size of Data 1 is fixed to 4 bits.)

Slow CH ID(Slow CH ID)

When the display source is slow channel, set the message ID of the data you want to display the trend of. The selectable range of ID varies depending on the type selected in the slow channel message type menu (► [See here.](#)) of the bus setup menu (explained earlier).

Message Type	Short		Enhanced	
	Hex	Dec	Hex	Dec
Selectable Range	0 to F	0 to 15	00 to FF	0 to 255

Configuring the Display (Display Setup)

Set the trend display scale, and turn the display of VT waveforms on or off.

- **Auto Scale Exec**
Executes auto scaling. The upper and lower limits are set so that the difference between the maximum data value and minimum data value in the window selected with H-Range covers 80% of the vertical scale of the Trend window.
- **H-Range**
Select the range to display the trend of from the following windows.
Main: Main window
Zoom1: Zoom1 window
Zoom2: Zoom2 window
- **VT Display**
Select whether to display the VT waveform along with the trend display.
ON: Displays the VT waveform display window
OFF: Does not display the VT waveform display window
- **Upper/Lower**
Set the vertical scale values of the trend display.
- **Cursor Measurement (Cursor)**
You can perform cursor measurement on the trend.
ON: Cursor1 and Cursor2 values are measured.
OFF: Cursor measurement is not performed.

T1	Time value of Cursor1 (time from the trigger position)
T2	Time value of Cursor2 (time from the trigger position)
ΔT	Difference between the time values of Cursor1 and Cursor2
V1(TRx)	Data value at the intersection of Cursor1 and trend (Trend) x
V2(TRx)	Data value at the intersection of Cursor2 and trend (Trend) x
$\Delta V(TRx)$	Difference between the data values at the intersection of Cursor1 and trend (Trend) x and the intersection of Cursor2 and trend (Trend)

x: 1 to 4

Search Setup (Search)

Search Type (Mode)

Select the SENT signal search type from one of the settings below.

- Every Fast CH: Searches for fast channel messages
- Fast CH S&C: Searches for the status and communication bit pattern
- Fast CH Data: Searches for the position where the AND condition of the fast channel data is met
- Every Slow CH: Searches for slow channel messages
- Slow CH ID/Data: Searches for the position where the AND condition of the slow channel ID and data is met
- Error: Searches for errors

The method to set search conditions is the same as that for the trigger conditions of the SENT trigger. Set the ID and data using the format selected in the decode menu.

▶ [See here.](#)

Executing a Search (Search)

The DLM4000 searches for locations where the specified search conditions are met. Then, the DLM4000 displays the specified detected point number (Pattern No.) expanded in the zoom window.

Detected Points

For the positions of detected points, see “Trigger and Detected Points of SENT Signals.”

▶ [See here.](#)

Analyzing and Searching PSI5 Airbag Signals (Option)

Analysis Source

Data frame is analyzed.

For the PSI5 Airbag frame format, see “[PSI5 Airbag Trigger](#)” in chapter 4, “Triggering.”

Bus Setup (Setup)

Sync Signal (Sync)

Set the sync signal source to one of the settings below.

CH1 to CH8, Math1 to Math4, X

- * When X is selected, sync signal is not detected. Therefore, sync noise rejection (explained later) is set to OFF.

Level (Level) and Hysteresis (Hys)

You can set the edge detection level and hysteresis for the sync signal. These items are the same as those of the edge search.

▶ [See here.](#)

Data Frame (Data)

- **Source (Source)**

Set the data frame source (data source) to one of the following settings below.

CH1 to CH8, Math1 to Math4

- **Bit Rate (Bit Rate)**

Set the data transfer rate of the data frame source to one of the following settings below.

125kbps, 189kbps, User Define

If you select User Define, set the transfer rate in the range of 10.0 kbps to 1000.0 kbps in 0.1-kbps steps.

- **Data Length (Data Bits)**

Set the length of data area of the data frame (Payload Data Region) to one of the following settings below.

10bit, 16bit

- **Error Detection Method (ErrorDetection)**

If the data length is 10 bits, set the error detection method to one of the following settings below. When the data length is 16 bit, this is fixed to CRC.

Parity, CRC

- **Sync Noise Rejection (Sync Noise Rejection)**

You can configure the DLM4000 so that current noise generated by sync pulses is not detected (is ignored) for a given time period. This prevents detecting the start bit of data frames by mistake.

Rejection Mode (Mode)

ON: Noise is rejected.

OFF: Noise is not rejected.

Rejection End (Rejection End)

Set the time period from the rising edge of the sync pulse to the end of noise rejection.

Selectable range: 0.0 μ s to 20000.0 μ s

Resolution: 01 μ s

- **Clock Tolerance(Clock Tolerance)**

Set the clock tolerance of the data frame source.

Selectable range: $\pm 0.5\%$ to $\pm 33.3\%$

Resolution: 0.1%

- **Level (Level) and Hysteresis (Hys)**

You can set the edge detection level and hysteresis for the data frame sources. These items are the same as those of the edge search.

▶ [See here.](#)

Auto Setup (Auto Setup)

Executes auto setup based on the specified sync signal and data frame source.

Bit rate, data length, error detection method, sync noise rejection, clock tolerance, number of slots, level, and hysteresis are set automatically.

- When the [sync signal \(Sync\)](#) source is CH1 to CH8, the DLM4000 triggers on the rising edge of the sync pulse.
- When the sync signal source is X, the DLM4000 triggers on the start bit of data frames.
- You cannot execute auto setup if the sync signal or data frame source is set to Math1 to Math4.

Setting the Number of Slots (Number of Slots)

When the aforementioned sync signal source is not X, a control menu appears, and you can set the number of slots. Set the same number of slots as the number of data frames between the applicable sync pulse and the next sync pulse.

Auto, 1 to 6

If set to Auto, slot numbers are assigned automatically to data frames in order from number 1. The data frame closest to the applicable sync pulse is assigned the number 1, and numbers up to 6 are assigned. You can view the slot numbers on the list display.



If you set the number of slots different from the number of data frames between the applicable sync pulse and the next sync pulse, Sync on the decode display (explained later) will be red. Under Information of the list display, [error type](#) Slot Boundary Error or Frame Number Error is displayed.

Setting the Time Range of Each Slot (Slot)

When the number of slots (Number of Slots) is not Auto, you can set the time range of each slot.

- Start position of slot N (Slot N Start)
 - Selectable range: 0.0 μs to 20000.0 μs
 - Resolution: 0.1 μs
 - However, Slot N Start \leq Slot N + 1 Start, where N is the slot number (1 to the specified number of slots)
- End position of slot N_{max} (Slot N_{max} END)
 - Selectable range: Slot N_{max} - 1 Start value to 20000.0 μs
 - Resolution: 0.1 μs
 - where N_{max} is the specified number of slots

15 Analyzing and Searching Serial Bus Signals

The following table shows the default slot settings depending on the data length and bit rate.

Data length	10bit		16bit	
Bit rate	125kbps	189kbps	125kbps	189kbps
Slot 1 Start (µs)	44.0	44.0	44.0	44.0
Slot 2 Start (µs)	181.3	139.5	257.3	179.3
Slot 3 Start (µs)	328.9	245.5	492.0	328.2
Slot 4 Start (µs)	492.0	362.5	750.1	492.0
Slot 5 Start (µs)	672.1	492.0	1034.1	672.1
Slot 6 Start (µs)	870.0	633.3	1346.4	870.3
Slot 6 End (µs)	1088.3	788.8	1690.0	1088.3

If the number of slots is less than 6, Slot N End = Slot N + 1 Start.



If the start (Start) position or end (End) position of a specified slot overlaps with a data frame, Sync on the decode display (explained in the next section) will be red. Under Information of the list display, **error type** Slot Boundary Error is displayed.

Decoded Display (Decode)

The colors that are used for the fields in the decoded display are as follows:

Sync	Light gray (Light Gray) It will appear in red in the following situations. When the number of slots (Number of Slots) is different from the number of data frames or when the start (Start) position or end (End) position of a slot overlaps with a data frame.
Start Bit	Pink (Pink) fill
Data	Cyan (Cyan)
Parity/CRC	Light blue (Light Blue)
Error	Red (Red) The field frame with the error is displayed in red, and a red block is displayed within the frame.

List Display (List/Trend - Show List)

The list displays the following items.

No.	Analysis number. Negative numbers are assigned to sync pulses or data frames before the trigger position, and positive numbers are assigned to sync pulses or data frames after the trigger position. The DLM4000 can display the analysis results for a total of up to 400000 sync pulses and data frames in the range of -399999 to 399999. Pressing the RESET key highlights sync pulse or data frame number zero.
Time(ms)	Displays the time from the trigger position to the start of the sync pulse or that of the data frame in milliseconds.
from Sync(µs)	Displays the time from the start of the previous sync pulse to the start of the applicable sync pulse or that of the data frame in microseconds. This will be blank if the aforementioned sync signal (Sync) source is X.
Slot No.	For sync pulses, the word "Sync" is displayed. For data frames, the corresponding slot number is displayed. This will be blank if the aforementioned sync signal (Sync) source is X.
Data	Displays data in hexadecimal or decimal notation.
Parity/CRC	Displays the parity or CRC value in hexadecimal notation.
Information	Displays the following error information. If multiple errors are detected in a frame, the DLM4000 displays up to three errors in the following order of precedence. Frame Error, Clock Error, Start Bit Error, Parity/CRC Error, Frame Number Error, Slot Boundary Error

Trend Display (List/Trend - Trend)

Up to four trends (Trend1 to Trend4) of decoded data can be displayed. You can also display the data values using the cursor measurement function.

Trend Display (Display)

Set whether or not to display the trend. The trend is displayed in the Trend window. The trend is not displayed for data that contains errors.* Such areas become blank.

- ON: The trend is displayed.
- OFF: The trend is not displayed.

* There are six [error types](#). If the error type is frame number, the trend is displayed.

Display Source (Source)

When the aforementioned [sync signal \(Sync\)](#) source is not X, a control menu appears, and you can select the slots to display the trend of. Depending on the aforementioned [number of slots \(Number of Slots\)](#), select from the following range.

- When the number of slots is set to a number from 1 to 6
Slot 1 to Slot N
where N is the specified number of slots
- When the number of slots is set to Auto
Slot 1 to Slot 6

If there is no data frame in the selected slot, the trend is not displayed.

Configuring the Display (Display Setup)

Set the trend display scale, and turn the display of VT waveforms on or off.

- **Auto Scale Exec**

Executes auto scaling. The upper and lower limits are set so that the difference between the maximum data value and minimum data value in the window selected with H-Range covers 80% of the vertical scale of the Trend window.

- **H-Range**

Select the range to display the trend of from the following windows.

Main: Main window

Zoom1: Zoom1 window

Zoom2: Zoom2 window

- **VT Display**

Select whether to display the VT waveform along with the trend display.

ON: Displays the VT waveform display window

OFF: Does not display the VT waveform display window

- **Upper/Lower**

Set the vertical scale values of the trend display.

15 Analyzing and Searching Serial Bus Signals

- **Cursor Measurement (Cursor)**

You can perform cursor measurement on the trend.

ON: Cursor1 and Cursor2 values are measured.

OFF: Cursor measurement is not performed.

T1	Time value of Cursor1 (time from the trigger position)
T2	Time value of Cursor2 (time from the trigger position)
ΔT	Difference between the time values of Cursor1 and Cursor2
V1(TRx)	Data value at the intersection of Cursor1 and trend (Trend) x
V2(TRx)	Data value at the intersection of Cursor2 and trend (Trend) x
$\Delta V(TRx)$	Difference between the data values at the intersection of Cursor1 and trend (Trend) x and the intersection of Cursor2 and trend (Trend)

x: 1 to 4

Search Setup (Search)

Search Type (Mode)

Select the PSI5 Airbag signal search type from one of the settings below.

- Sync: Searches for sync pulses This will not be available if the aforementioned [sync signal \(Sync\)](#) source is X.
- Start Bit: Searches for the start bit of data frames
- [Frame in Slot](#): Searches for data frames included in the specified slot This will not be available if the sync signal source is X.
- [Data](#): Searches for a data pattern or a data value You can also specify a slot.
- [Error](#): Searches for errors

Sync

The DLM4000 searches for the rising edge of sync pulses. Search type Sync will not be available if the sync signal source is X.

Start Bit

The DLM4000 searches for the start bit of data frames.

Frame in Slot

The DLM4000 searches for data frames included in the specified slot. Frame in Slot will not be available if the sync signal source is X.

- **Slot Number (Slot No.)**

Select the slot number to search for data frames. Depending on the aforementioned [number of slots \(Number of Slots\)](#), select from the following range.

- When the number of slots is set to a number from 1 to 6
1 to N
where N is the specified number of slots
- When the number of slots is set to Auto
1 to 6

Data

The DLM4000 searches for a data pattern or a data value.

- **Search Conditions (Condition Setup)**

On the Condition Setup screen, set the slot and data search conditions.

- **Slot (Slot)**

Select the slot number to search for a data pattern or a data value. Depending on the aforementioned [number of slots \(Number of Slots\)](#), select from the following range. Slot number will not be available if the [sync signal \(Sync\)](#) source is X or if slot is not used as a search condition.

- When the number of slots is set to a number from 1 to 6
1 to N
where N is the specified number of slots
- When the number of slots is set to Auto
1 to 6

- **Data (Data)**

Data (Data) is always selected as a search condition.

- **Comparison Condition (Condition)**

The data search condition is met when the result of comparing the specified data pattern or reference value to the input signal's data value meets the specified comparison condition.

True	When the value matches the data pattern
False	When the value does not match the data pattern
Data = a ¹	When the value is equal to the reference value
Data ≠ a ¹	When the value is not equal to the reference value
a ≤ Data ¹	When the value is greater than or equal to the reference value
Data ≤ b ¹	When the value is less than or equal to the reference value
a ≤ Data ≤ b ²	When the value is within the reference range (including the reference values)
Data < a, b < Data ²	When the value is outside the reference range (excluding the reference values)

- 1 Set one reference value
2 Set two reference values

- **Input Format (Input format)**

When the comparison condition is True or False, set the data pattern input format to Bin (binary) or Hex (hexadecimal).

- **Data Pattern**

If the comparison condition is set to True or False, set the data pattern in hexadecimal or binary notation.

- **Reference Values (a and b)**

Set the reference values in Hex (hexadecimal) or Dec (decimal) according to notation method selected in the decode menu. If Bin (binary) is selected on the decode menu, set the reference values in Hex (hexadecimal). Depending on the aforementioned [data length \(Data Bits\)](#), set the values in the following range.

Data length	10bit		16bit	
Decode format	Hex, Bin	Dec	Hex, Bin	Dec
Selectable Range	200 to 1FF	-512 to 511	8000 to 7FFF	-32768 to 32767



- If you specify X in the data pattern, the condition is assumed to be met regardless of the corresponding bit status.
- In a data pattern setting, if a binary pattern contains any Xs, the corresponding hexadecimal display will be “\$.”
- If the comparison condition is $a \leq \text{Data} \leq b$ or “Data < a or b < Data,” the two reference values are automatically adjusted so that the lower limit is less than or equal to the upper limit.

Error

The DLM4000 searches for various errors.

• **Error Type (Error Type OR)**

Frame	When the number of bits in a data frame is insufficient, excessive, or undefined.
Clock	<ul style="list-style-type: none"> • Decoding continues when the specified clock tolerance is exceeded. • Decoding ends when the maximum tolerance of $\pm 33.3\%$ is exceeded.
Start Bit	When the start bit state is not 00.
Parity/CRC	When a parity check error or CRC error is detected
Frame Number	<ul style="list-style-type: none"> • When the data frames are insufficient or excessive with respect to the specified number of slots. • When there is no data frame or there are more than seven data frames when the number of slots is set to Auto
Slot Boundary	<ul style="list-style-type: none"> • When a data frame exceeds the boundaries of the slot (slot start or end position) • When a sync pulse overlaps with a slot boundary

Executing a Search (Search)

The DLM4000 searches for locations where the specified search conditions are met. Then, the DLM4000 displays the specified detected point number (Pattern No.) expanded in the zoom window.

Detected Points

The following figures illustrate the detected points.

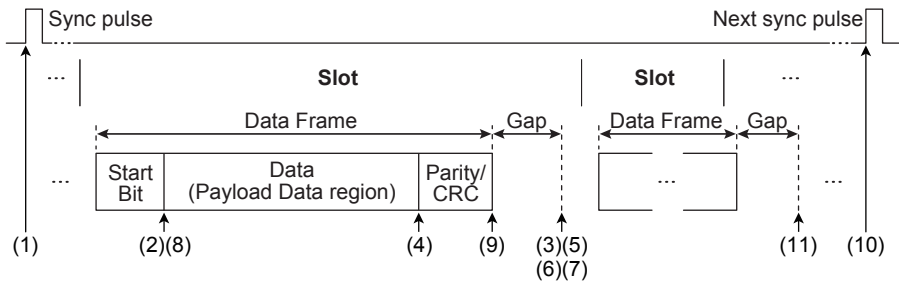

Positions (1) to (11) above are detected points for the following conditions.

- | | |
|---------------------------------------|--------------------------|
| (1) Sync | (7) Clock Error |
| (2) Start Bit | (8) Start Bit Error |
| (3) Frame in Slot | (9) Parity/CRC Error |
| (4) Data when a slot is not specified | (10) Frame Number Error |
| (5) Data when a slot is specified | (11) Slot Boundary Error |
| (6) Frame Error | |

Analyzing and Searching UART Signals (Option)

Analysis Source

Data: Searches for data patterns

For the UART data format, see “[UART Trigger](#)” in chapter 4, “Triggering.”

Bus Setup (Setup)

Source (Source)

Set the analysis source to one of the settings below. If you select LOGIC, select the [source bit](#).

CH1 to CH8/LOGIC(L), LOGIC(A|B), Math1 to Math4

* CH8 or LOGIC(L), whichever the corresponding key is illuminated (CH8 or L), can be selected. LOGIC(A|B) is available on models with the /L16 option.

Bit Rate (Bit Rate)

Select the UART signal's data transfer rate from one of the settings below.

1200 bps, 2400 bps, 4800 bps, 9600 bps, 19200 bps, 38400 bps, 57600 bps, 115200 bps, or User Define

If you select User Define, set the transfer rate to a value from 1000 bps to 10000000 bps in 100-bps steps.

Bit Order (Bit Order) and Polarity (Polarity)

These items are the same as those of the UART signal.

▶ [See here](#).

Sample Point (Sample Point)

You can set the reference that will be used to determine the signal level in the range of 18.8 to 90.6% in 3.1% steps.

Data Format (Format)

You can set the data type to one of the settings below.

- 8bit NonParity: 8-bit data (no parity bit)
- 7bit Parity: 7-bit data + parity bit
- 8bit Parity: 8-bit data + parity bit

Parity (Parity)

Set the parity bit to even (Even) or odd (Odd).

Grouping (Grouping)

Select whether or not to group data when displaying the list of decoded results. When you turn grouping on, data whose time is shorter than the specified byte space (Byte Space) is decoded and displayed in a single group.

- ON: Groups the list of decoded results
- OFF: Does not group the list of decoded results

15 Analyzing and Searching Serial Bus Signals

- **Byte Space (Byte Space)**

The DLM4000 displays data whose time length is less than the specified byte space (Byte Space) in a single group.

Selectable Range

The selectable range is from the time length that corresponds to the number of bits in the UART signal data format plus 2 bits, to 100 ms.

The “2 bits” that are added are the start and stop bits.

For example, if the data format is 8 bits with a parity bit, the time length is as follows:

Data (8) + parity bit (1) + start bit (1) + stop bit (1) = Time length for 11 bits

Resolution: 1 μ s

Default value: Time length that corresponds to the number of bits in the UART signal data format and 2 bits

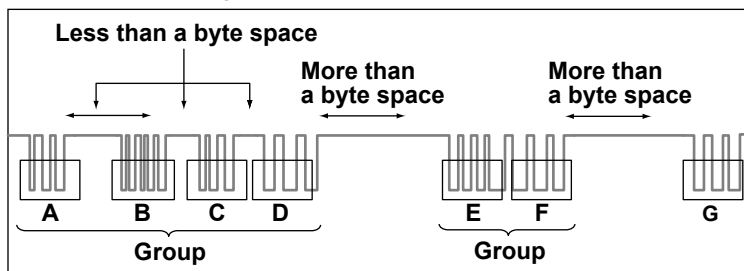

Level and Hysteresis (Level/Hys)

These items are the same as those of the edge search.

► [See here.](#)

Auto Setup (Auto Setup)

Executes auto setup based on the specified sources.

The auto setup feature automatically configures the bit rate, sample point, level, and hysteresis, and then triggers on the UART signal's stop bit.

You cannot execute auto setup when:

- The sources is set to Math1 to Math4.
- State display is applied to a LOGIC bit that is set as the source.

Decoded Display (Decode)

The colors that are used for the fields in the decoded display are as follows:

Data	Cyan (Cyan)
Parity	Yellow (Yellow)
Start Bit	Gray (Gray) fill
Stop Bit	Gray (Gray) fill
Error	Red (Red)
	Framing Error: Displays the words "Framing Error" in the field in which an error occurred using black characters on red background. It is displayed with higher precedence than a parity error.
	Parity Error: Displays the characters of the field in which an error occurred using black characters on red background.

List Display (List - Show List)

The list displays the following items.

When Grouping Is Set to ON

No.	Analysis number. Negative numbers are assigned to frames before the trigger position, and positive numbers are assigned to frames after the trigger position. The DLM4000 can display the analysis results for up to 300000 frames in the range of -299999 to 299999. Pressing the RESET key highlights data number zero.
Time(ms)	Displays the time from the trigger position to the start of the byte in milliseconds.
Data	Displays the first 16 bytes of data for each group in hexadecimal notation and ASCII codes. You can press the SET key to view all of the data of the specified group (analysis number).
Information	Displays information about the other error. If both a framing error and a parity error are detected in a data frame, the framing error is displayed.

When Grouping Is Set to OFF

Addr	Displays the address relative to the first data address.
Hex	Displays the data in hexadecimal notation. An asterisk is attached to the data if a framing error is detected. A letter "X" is attached to the data if a parity error is detected.
Ascii	Displays the data using ASCII codes.

Search Setup (Search)

Search Type (Mode)

Select the UART signal search type from one of the settings below.

- Every Data: Searches for data stop bits
- Data: Searches for data patterns
- Error: Searches for errors

The method of setting search conditions is the same as that of setting the UART trigger conditions.

▶ [See here.](#)

Executing a Search (Search)

The DLM4000 searches for locations where the specified search conditions are met. Then, the DLM4000 displays the waveform at the specified detected point number (Pattern No.) expanded in the zoom window.

Detected Points

The detected points are the same as the trigger points.

▶ [See here.](#)

Analyzing and Searching I²C Bus Signals (Option)

For the I²C data format, see “I²C Bus Trigger” in chapter 4, “Triggering.”

Bus Setup (Setup)

Serial Clock (SCL) and Serial Data (SDA)

Set the SCL and SDA sources to one of the settings below. If you select LOGIC, select the [source bit](#).

Serial clock (SCL)	Serial data (SDA)
For CH1 to CH4, Math1, or Math2	CH1 to CH4, Math1, or Math2
For CH5 to CH8/LOGIC(L), Math3, or Math4	CH5 to CH8/LOGIC(L), Math3, or Math4
For LOGIC(A B)	LOGIC(A B)

- * CH8 or LOGIC(L), whichever the corresponding key is illuminated (CH8 or L), can be selected.
LOGIC(A|B) is available on models with the /L16 option.

Level and Hysteresis (Level/Hys)

These items are the same as those of the edge search.

▶ [See here.](#)

Auto Setup (Auto Setup)

Executes auto setup based on the specified SCL and SDA sources.

The DLM4000 sets the level and hysteresis to values that are appropriate for the input signal and triggers on the start condition of the signal.

You cannot execute auto setup when:

- The SCL or SDA source is set to Math1 to Math4.
- State display is applied to a LOGIC bit set as the SCL or SDA source.

R/W Bit Inclusion (Include R/W)

When you set the address pattern input format to hexadecimal, you can choose to include or omit the R/W bit when you set the address pattern.

- ON: Include the R/W bit. (The address and the R/W bit are displayed in hexadecimal.)
- OFF: Omit the R/W bit. (The address is displayed in hexadecimal and the R/W bit is displayed in binary.)

▶ [See here.](#)

Decoded Display (Decode)

The colors that are used for the fields in the decoded display are as follows:

Start/Restart Condition	Light gray (Light Gray)
Adr	Light green (Light Green)
Data	Cyan (Cyan)
R/W	Pink (Pink)
Ack	Yellow (Yellow)
General Call	Green (Green)
Start Byte	Orange (Orange)
HS Mode	Orange (Orange)
Stop Condition	Light gray (Light Gray)

You can select whether to show or hide Start/Restart Condition and Stop Condition.

▶ [See here.](#)

List Display (List - Show List)

The list displays the following items.

No.	Analysis number. Negative numbers are assigned to frames before the trigger position, and positive numbers are assigned to frames after the trigger position. The DLM4000 can display the analysis results for up to 300000 frames in the range of -299999 to 299999. Pressing the RESET key highlights data number zero.
Time(ms)	Displays the time from the trigger position to the start of the byte in milliseconds.
1st ¹	Displays the first byte address in hexadecimal notation.
2nd ¹	Displays the second byte address in hexadecimal notation. R/W Displays the signal type. R stands for "Read" and W stands for "Write."
Data	Displays the first 16 bytes of the data in hexadecimal notation. You can press the SET key to view all of the data of the specified analysis numbers.
ACK	If an Acknowledge bit is detected, the DLM4000 displays an asterisk by the Data column.
Information	Displays the data type. General call, Start byte, Hs-mode, 10-bit, 7-bit, or CBus

- 1 You can use the R/W bit inclusion setting (Include R/W) to choose whether or not to include the R/W bit in the displayed address.

Search Setup (Search)

Search Type (Mode)

I²C bus signal search type from one of the settings below.

- Every Start: Searches for start and restart conditions
- Adr Data: Searches for address patterns and data patterns (AND condition)
- NON ACK: Searches for NACK (SDA is H) acknowledge bits
- General Call: Searches for general call addresses
- Start Byte: Searches for the master codes of start bytes
- HS Mode: Searches for the master codes of HS modes

The method of setting search conditions is the same as that of setting the I²C Bus trigger conditions.

▶ [See here.](#)

Executing a Search (Search)

The DLM4000 searches for locations where the specified search conditions are met. Then, the DLM4000 displays the waveform at the specified detected point number (Pattern No.) expanded in the zoom window.

Detected Points

The detected points are the same as the trigger points.

▶ [See here.](#)

Analyzing and Searching SPI Bus Signals (Option)

For the SPI time chart, see “[SPI Bus Trigger](#)” in chapter 4, “Triggering.”

Bus Setup (Setup)

Wiring System (Mode)

This item is the same as that of the SPI bus trigger.

▶ [See here.](#)

Data Setup (Data Setup)

Bit Order (Bit Order)

This item is the same as that of the SPI bus trigger.

▶ [See here.](#)

Field Size (Field Size)

You can set the field size to a value between 4 and 32 bits. This setting determines the bit length of the groups that the signal is decoded in.

Enabled Bit Range (Enable MSB/LSB)

You can specify the range of bits to enable within the field (0 to 31). The DLM4000 searches through the data in the enabled bit range.

Clock (Clock), Data1 (Data1), Data2 (Data2), and Chip Select (CS)

Set the clock, Data1, Data2, and chip select sources from the available waveforms below. If you select LOGIC, select the [source bit](#).

Clock (Clock)	Data 1 (Data1), Data 2 (Data2), chip select (CS)
For CH1 to CH4, Math1, or Math2	CH1 to CH4, Math1, Math2, X (don't care)
For CH5 to CH8/LOGIC(L), Math3, or Math4	CH5 to CH8/LOGIC(L), Math3, Math4, X (don't care)
For LOGIC(A B)	LOGIC(A B), X (don't care)

* CH8 or LOGIC(L), whichever the corresponding key is illuminated (CH8 or L), can be selected.
X is available only for chip select sources. If you select X, set grouping to ON or OFF and the idle time (Idle Time).

LOGIC(A|B) is available on models with the /L16 option.

Clock Idle Time and Grouping (Idle time/Grouping)

When Grouping is set to ON, the decoded results are displayed starting from the first rising or falling clock edge after the specified idle time. When Grouping is set to OFF, the data is decoded from the left of the screen, regardless of the idle time setting.

You can turn grouping on and off and set the idle time when CS is set to X (don't care).

Clock Polarity (Polarity) and Chip Select Active State (Active)

These items are the same as that of the SPI bus trigger.

▶ [See here.](#)

Level and Hysteresis (Level/Hys)

These items are the same as those of the edge search.

▶ [See here.](#)

Auto Setup (Auto Setup)

Executes auto setup based on the specified wiring system and the clock, Data1, Data2, and chip select sources. The auto setup feature automatically configures the level and hysteresis, and triggers on the SPI signal's first data byte.

You cannot execute auto setup when:

- Any of the sources (ie. clock, Data1, Data2, or chip select) is set to Math1 to Math4.
- State display is applied to any of the LOGIC bits set at the clock, Data1, Data2, or chip select.
- The chip select source is set to X (Don't care).

Decoded Display (Decode)

The colors that are used for the fields in the decoded display are as follows:

Data	Cyan (Cyan)
Group background	Gray (Gray)

List Display (List - Show List)

The list displays the following items.

No.	Analysis number. Negative numbers are assigned to frames before the trigger position (Reference Point), and positive numbers are assigned to frames after the trigger position. The DLM4000 can display the analysis results for up to 300000 frames in the range of -299999 to 299999. Pressing the RESET key highlights data number zero.
Time(ms)	Displays the time from the trigger position to the start of the byte in milliseconds.
Data1*	Displays Data1 in hexadecimal notation.
Data2*	Displays Data2 in hexadecimal notation. Only for four-wire systems.

- * The first 16 bytes are displayed. You can press the SET key to view all of the data of the specified analysis numbers.

Search Setup (Search)

When the wiring system is 3wire, the DLM4000 searches Data1 for the specified condition (data pattern). When the wiring system is 4wire, the DLM4000 searches Data1 and Data2 for the specified condition (data pattern).

Search Conditions (Condition Setup)

These conditions are the same as the SPI bus trigger conditions.

▶ [See here.](#)

Executing a Search (Search)

The DLM4000 searches for locations where the specified search conditions are met. Then, the DLM4000 displays the waveform at the specified detected point number (Pattern No.) expanded in the zoom window.

Detected Points

The detected points are the same as the trigger points.

▶ [See here.](#)

Analyzing and Searching User-Defined Serial Bus Signals (User Define)

Bus Setup (Setup)

You must set the following items to analyze user-defined serial bus signals.

Source (Source)

Set the analysis source to one of the settings below.

CH1 to CH8

Set the selected source's active state and level.

This item is the same as that of the user-defined serial bus trigger.

▶ [See here.](#)

Level (Level) and Hysteresis (Hysteresis)

Set the level and hysteresis used to detect the source state.

These items are the same as those of the edge search.

▶ [See here.](#)

Clock (Clock)

You can select whether or not to sample the data source in sync with the clock source.

- ON: Samples the data source in sync with the clock source
- OFF: Does not sample the data source in sync with the clock source.

If you select ON, set the clock source (Clock), chip select source (CS), and latch source (Latch).

This item is the same as that of the user-defined serial bus trigger.

▶ [See here.](#)

Bit Rate (Bit Rate)

The DLM4000 samples the data source at the specified bit rate. Set the bit rate when the clock is off.

Selectable range	1000 bps to 50 Mbps
Resolution	0.001 kbps (for 1.000 kbps to 99.999 kbps) 0.01 kbps (for 100.00 kbps to 999.99 kbps) 0.1 kbps (for 1 Mbps to 9999.9 kbps) 1 kbps (for 10 Mbps to 50 Mbps)

Decoding Start Point (Start Point)

Set the decoding start point.

Decoded Display (Decode)

The colors that are used for the fields in the decoded display are as follows: The decoded display can only be used when the clock is not used.

Data: Cyan (Cyan)

Search Setup (Search)

Search Condition (Condition Setup)

The method of setting search conditions is the same as that of setting the user-defined serial bus signal trigger conditions.

▶ [See here.](#)

Executing a Search (Search)

The DLM4000 searches for locations where the specified search conditions are met. Then, the DLM4000 displays the waveform at the specified detected point number (Pattern No.) expanded in the zoom window.

Detected Points

The detected points are the same as the trigger points.

▶ [See here.](#)

16 Displaying the Frequency Distribution of a Waveform

The DLM4000 can count the frequency of data occurrence in a specified area and display in a histogram. You can select whether to count the voltage data frequency or the time data frequency.

You can measure the mean, standard deviation, maximum value, minimum value, peak value, median, etc.

You can configure up to two histogram source waveforms (Histogram1, Histogram2).

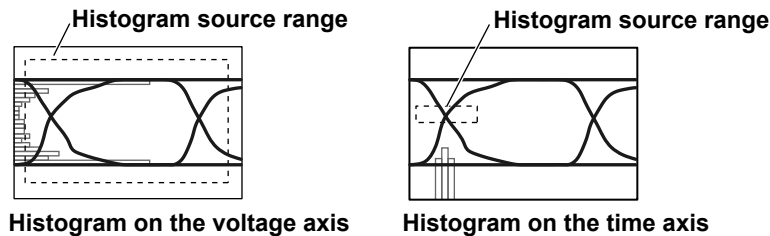

Turning the Histograms On or Off (Display)

Sets whether or not to display histograms for Histogram1 and Histogram2.

- ON: Displays the histograms
- OFF: Hides the histograms

Source Waveform (Trace)

Select the source waveform from the waveforms below. The available waveforms vary depending on the model. CH1 to CH8, Math1 to Math4

Source Axis (Type)

Selects the data axis that you want to count the frequency for.

- Vertical: Vertical axis
- Horizontal: Time axis

Range Setup (Range Setup)

Source Window (Range)

Selects the window that you want to count the frequency in.

- Main: Main window
- Zoom1: Zoom1 window
- Zoom2: Zoom2 window

Upper and Lower Range Limits (Upper/Lower)

Sets the upper and lower limits within which frequencies are counted in the range of ± 4 divisions.

Left and Right Range Values (Left/Right)

Sets the left and right boundaries within which frequencies are counted in the range of ± 4 divisions.

Histogram Frequency

The frequency of values is counted until the waveform display is updated. The frequency is reset when the waveform display is updated.

Measurement (Measure Setup)

Mode (Mode)

Param: Measures the value of the selected parameter and performs cursor measurement.

OFF: Disables measurement.

Cursor Measurement (Cursor1 and Cursor2)

Measurement items C1, C2, and ΔC are used to measure the Cursor1 value, the Cursor2 value, and the difference between the two cursor values. The selectable range varies depending on the source axis as follows:

- If the source axis is vertical (Cursor1 =, Cursor2 =): In the range of ± 4 divisions of the vertical axis
- If the source axis is horizontal (Cursor1 II, Cursor2 II): In the range of ± 4 divisions of the time axis

Measurement Items (Item Setup)

The DLM4000 measures the values of the items listed below that you select.

Peak	Peak value
Max	Maximum value
Min	Minimum value
Mean	Mean value
σ	Standard deviation of the histogram
Median	Median*
Integ $\pm\sigma$	Percentage of values that fall within $\pm\sigma$ (%)
Integ $\pm 2\sigma$	Percentage of values that fall within $\pm 2\sigma$ (%)
Integ $\pm 3\sigma$	Percentage of values that fall within $\pm 3\sigma$ (%)
C1	Cursor1 value
C2	Cursor2 value
ΔC	Difference between Cursor1 and Cursor2

- * Resorts the sampled points from the minimum to the maximum value and determines the value of the middle number.

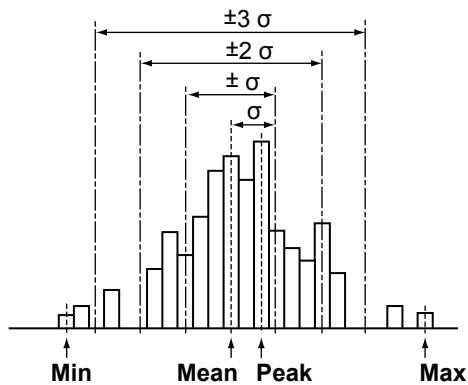

17 Power Supply Analysis Feature (Power Analysis & Power Measurement; Option)

Overview of the Power Supply Analysis Feature

The power supply analysis feature of the DLM4000 (/G4 option) consists of (1) analysis features such as switching loss analysis, safe operating area analysis, harmonic analysis, and Joule integral and (2) power measurement features for voltage, current, power, watt-hours and ampere-hours.

Power Supply Analysis Feature (Power Analysis)

Power Supply Analysis 1 and Power Supply Analysis 2 (Power Analysis1 and Power Analysis2)

You can assign different analysis items to Power Analysis1 and Power Analysis2 to perform two types of analysis simultaneously.

Type (Type)

Select the power supply analysis type from one of the settings below.

- OFF: Disables power supply analysis
- [SW Loss](#): Switching loss analysis
- [SOA](#): Safe operating area analysis
- [Harmonics](#): Harmonic analysis
- I^2t : Joule integral



If you set Power Analysis1 to SW Loss or I^2t , computation waveform feature Math1 will be used. As a result, the computation set in Math/Ref1 will not be performed. If you set Power Analysis1 to a different setting, the Math/Ref1 returns to its original setting. The same limitation applies for Power Analysis2 and Math2.

Power Measurement Feature (Power Measurement)

Power of up to four circuits (Power Measurement1 to Power Measurement4) can be measured simultaneously. For details, see the "[Power Measurement \(Power Measurement\)](#)" section.

Deskewing the Transfer Time Difference between Input Signals

To measure the analysis items and power items correctly from the voltage and current of input signals, you must apply the voltage and current signals to the DLM4000 signal input terminals with no transfer time difference between the signals. However, transfer time difference may occur between the two signals depending on the probe that you are using. The DLM4000 allows you to automatically or manually deskew the transfer time difference between the two signals and then measure power supply analysis items. To use this feature, you need to connect a deskew signal source along with the probe beforehand.

We recommend that you use the following YOKOGAWA products when you deskew the signals.

Deskew signal source	701936
Passive probe	701939
Differential probe	700924, 701921, 701926, or 701927
Current probe	701928, 701929, 701930, 701931, 701932, or 701933

Notes about Auto Deskewing

- Use the 701936 as the deskew signal source.
- Use a current probe whose attenuation is 10A:1V. When you use the 701936 deskew signal source, you can also use current probes whose attenuation is 100A:1V.
- There is a unique interval between the voltage and current output waveforms of the 701936 deskew signal source. This interval is a result of the electrical length and impedance of the signal output section. Because in auto deskew the unique value is corrected automatically, after auto deskew is performed, the voltage and current waveform values are off by the amount of the unique value. For information about the unique value and about manual skew correction, see the 701936 deskew signal source user's manual.



You need power supplies to use the deskew signal source and current and differential probes without the YOKOGAWA probe interface (differential probes can run on batteries). If the DLM4000 is not equipped with the probe power option (/P8), you need to use the probe power supply (701934), which is sold separately.

Example of Deskewing

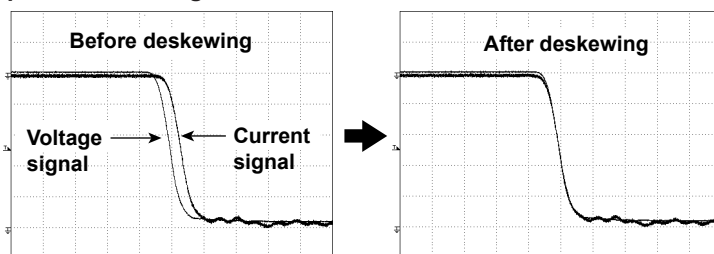

Switching Loss Analysis (SW Loss)

You can measure the device's total loss (power loss) and switching loss (power loss during switching). If you select SW Loss, you can calculate statistics and display power waveforms and measured values.

Probe Setup (Probe Setup)

Selecting Channels (Input Channels)

Select CH1 and CH2 or CH3 and CH4. You cannot change how these channels are paired. To measure power supply analysis items, apply the voltage signal to CH1 or CH3 and the current signal to CH2 or CH4.

Probe Attenuation Ratio and Voltage-to-Current Conversion Ratio (Probe CH1/CH2 or Probe CH3/CH4)

Select one of the probe attenuation ratios (CH1 or CH3) and one of the voltage-to-current conversion ratios (CH2 or CH4) listed below.

- CH1 or CH3
0.001:1, 0.002:1, 0.005:1, 0.01:1, 0.02:1, 0.05:1, 0.1:1, 0.2:1, 0.5:1, 1:1, 2:1, 5:1, 10:1, 20:1, 50:1, 100:1, 200:1, 500:1, 1000:1, or 2000:1
- CH2 or CH4
0.001A:1V, 0.002A:1V, 0.005A:1V, 0.01A:1V, 0.02A:1V, 0.05A:1V, 0.1A:1V, 0.2A:1V, 0.5A:1V, 1A:1V, 2A:1V, 5A:1V, 10A:1V, 20A:1V, 50A:1V, 100A:1V, 200A:1V, 500A:1V, 1000A:1V, or 2000A:1V



Changing the probe attenuation ratio or voltage-to-current conversion ratio here will change the same ratio in the CH key probe settings.

Deskewing Manually (Deskew CH1/CH2 and Deskew CH3/CH4)

You can set values for deskewing the transfer time difference between signals on each channel.

Auto Deskew Reference Waveform (Ref Trace)

Sets the reference waveform for auto deskewing. The DLM4000 deskews the input signals by using the specified waveform as its reference.

Auto Deskewing (Auto Deskew)

Executes auto deskewing.



You can also manually deskew the input signals by using the jog shuttle.

Measurement Setup (Measure Setup)

Cycle Mode (Cycle Mode)

If you turn cycle mode off, you can measure the power loss over the range specified by the T Range1 and T Range2 cursors. You can use the T Range1 and T Range2 cursors to specify the period over which to measure the switching loss and steady-state loss (the loss in the loss calculation period).

If you turn cycle mode on, the loss of one cycle or multiple cycles can be measured. The measurement time period is the range specified by the T Range1 and T Range2 cursors. The cycle is determined on the basis of the intersections of the mesial level and the voltage waveform. Then, the loss for one cycle or multiple cycles is measured. The total loss that is corrected depending on the device type (described later) can also be measured.

When cycle mode is off

$$\text{Loss} = \int_{T_1}^{T_2} u(t) \cdot i(t) dt \quad \text{Loss per unit time} = \frac{1}{T} \int_{T_1}^{T_2} u(t) \cdot i(t) dt$$

When cycle mode is on

$$\text{Loss} = \int_{T_{c1}}^{T_{c2}} u(t) \cdot i(t) dt \quad \text{Loss per unit time} = \frac{1}{T_c} \int_{T_{c1}}^{T_{c2}} u(t) \cdot i(t) dt$$

u(t): Sampled voltage data

i(t): Sampled current data

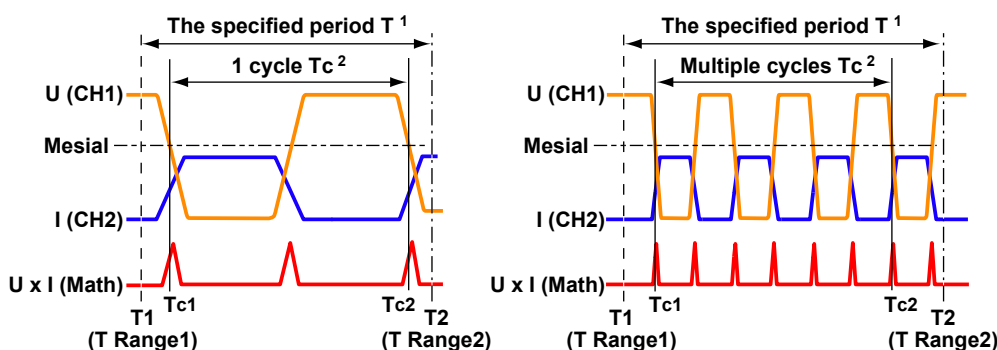

- 1 The measurement time period when cycle mode is off
- 2 The measurement time period when cycle mode is on



- If cycle mode is on, measurement is performed over the period that is determined by the specified range. If the specified period does not contain one cycle of waveform, the measured value is displayed as "*****".
- In switching loss analysis, statistical processing of Continuous, Cycle, or History, which are set in automated measurement of waveform parameters, can be executed.

17 Power Supply Analysis Feature (Power Analysis & Power Measurement; Option)

Device Type (Device)

If cycle mode is on, select the device type from the following:

MOSFET: The loss over the loss calculation period is measured on the basis of the device's on-resistance, RDS(on).

BJT/IGBT: The loss over the loss calculation period is measured on the basis of the device's collector-emitter saturation voltage, Vce(SAT).

OFF: The loss is measured according to the equation for "when cycle mode is on" described earlier.

If the device type is set to MOSFET or BJT/IGBT, the total loss is measured according to the following equation.

$$\text{Total loss} = \text{Loss in the loss calculation period} + \text{loss in the switching period}$$

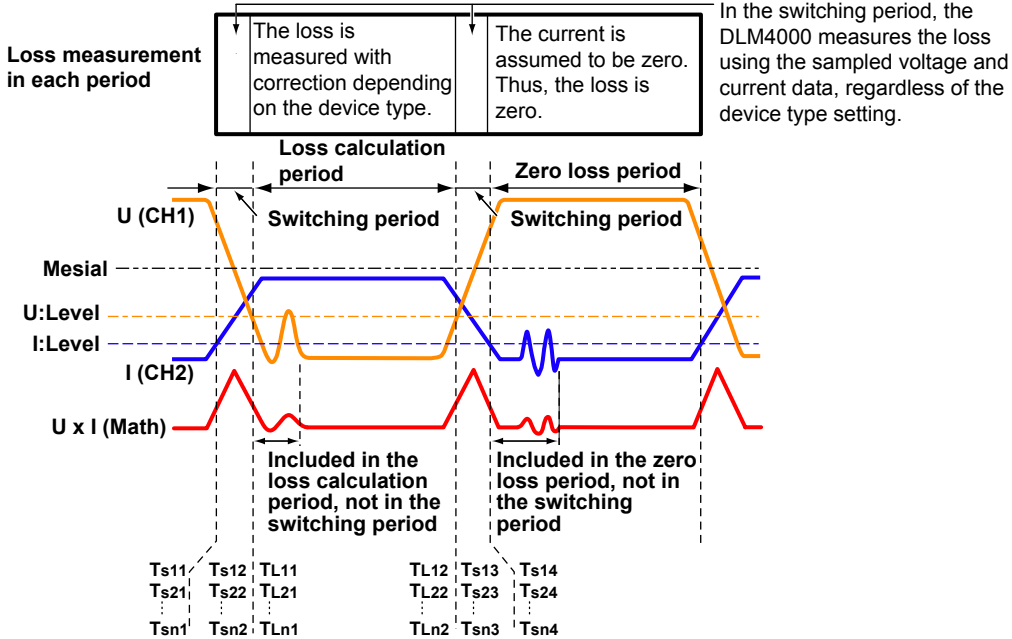

- **Loss calculation period:** The period from the point where the voltage waveform goes below the U:Level immediately after the waveform goes below the mesial level to the point where the waveform goes above the U:Level immediately before the waveform goes above the mesial level.

If there are n voltage waveform cycles between the T Range1 and T Range2 cursors

For device type MOSFET

Loss in the loss calculation period

$$= RDS(on) \left\{ \int_{TL11}^{TL12} i(t)^2 dt + \int_{TL21}^{TL22} i(t)^2 dt \dots + \int_{TLn1}^{TLn2} i(t)^2 dt \right\}$$

RDS(on): On-resistance

Vce(SAT): Collector-emitter saturation voltage

i(t): Sampled current data

TL11, TL12, TL21, TL22...TLn1, TLn2: Time values in the loss calculation period

For device type BJT/IGBT

Loss in the loss calculation period

$$= Vce(SAT) \left\{ \int_{TL11}^{TL12} i(t) dt + \int_{TL21}^{TL22} i(t) dt \dots + \int_{TLn1}^{TLn2} i(t) dt \right\}$$

- **Zero loss period:** The period from the point where the current waveform first goes below the I:Level after the waveform passes the middle point of the loss calculation period to the point where the waveform first goes above the I:Level after the waveform passes the middle point between the relevant loss calculation period and the next loss calculation period. The DLM4000 assumes that the current and loss are zero.
- **Switching period:** The period other than the loss calculation period or zero loss period described above.

If there are n voltage waveform cycles between the T Range1 and T Range2 cursors, there are 2n switching periods.

Loss in the switching period

$$= \int_{Ts11}^{Ts12} u(t) \cdot i(t) dt + \int_{Ts13}^{Ts14} u(t) \cdot i(t) dt + \int_{Ts21}^{Ts22} u(t) \cdot i(t) dt + \int_{Ts23}^{Ts24} u(t) \cdot i(t) dt \dots + \int_{Tsn1}^{Tsn2} u(t) \cdot i(t) dt + \int_{Tsn3}^{Tsn4} u(t) \cdot i(t) dt$$

u(t): Sampled voltage data

i(t): Sampled current data

Ts11, Ts12, Ts13, Ts14, Ts21, Ts22, Ts23, Ts24...Tsn1, Tsn2, Tsn3, Tsn4: Time values in the switching period

Level Setup (Level Setup)

Sets the voltage level (U:Level) and current level (I:Level) that are used to determine the loss period and cycle as well as the RDS(on) or Vce(SAT) values used to measure the loss over the loss calculation period. This setting is valid when cycle mode is on and the device is set to MOSFET or BJT/IGBT.



Set the voltage level (U:Level) and current level (I:Level) within the amplitude range of the source waveforms.

Reference Levels (Ref Levels(CH1) and Ref Levels(CH3))

Sets the reference levels (distal, mesial, and proximal) used to determine the total loss as percentages or as voltage values. This feature is the same as the reference level of the automated measurement of waveform parameters. This setting is valid when cycle mode is on.

▶ [See here.](#)



-
- Set the mesial value to a value greater than U:Level. If the mesial value is set to a value that is less than U:Level, the measured values will be displayed as "*****".
 - If you set the reference levels using percentages, the distal, mesial, and proximal voltage values are determined depending on the waveform.
 - If you want to set reference levels that do not change based on the waveform, set the levels as voltage values.
 - Changing the reference level settings here will also change the reference level settings for the automated measurement of waveform parameters.
-

Measurement Items (Item Setup)

You can select which items to measure from the list below.

- Loss:
Wp (the sum of both the positive and negative loss), Wp+ (positive loss), Wp-(negative loss), Abs.Wp (the sum of the absolute losses)
The definition of loss varies depending on the cycle mode and device type as follows:
 - When cycle mode is off
Power loss over the period (time T) specified by the T Range1 and T Range2 cursors ▶ [See here.](#)
 - When cycle mode is on and the device type is set to OFF
Loss over one cycle or multiple cycles (time Tc) within the period specified by the T Range1 and T Range2 cursors ▶ [See here.](#)
 - When cycle mode is on and the device type is set to MOSFET or BJT/IGBT
Device's total loss over one cycle or multiple cycles (time Tc) within the period specified by the T Range1 and T Range2 cursors ▶ [See here.](#)
- Loss per unit time: P, P+, P-, Abs.P
P, P+, P-, and Abs.P correspond respectively to Wp, Wp+, Wp-, and Abs.Wp described above.
The loss per unit time is determined by dividing the loss by time T or Tc. ▶ [See here.](#)
- Impedance: Z
The DLM4000 determines the impedance by measuring the rms voltage and rms current within time T or time Tc depending on the cycle mode on/off setting.



The maximum number of measurement items that can be displayed is 30 including the automatically measured waveform parameters. If the measured switching loss values are not displayed, reduce the number of automatically measured waveform parameters. ▶ [See here.](#)

17 Power Supply Analysis Feature (Power Analysis & Power Measurement; Option)

Unit (UNIT)

Select the unit to use when displaying the measured values for Wp, Wp+, Wp-, and Abs.Wp.

Wh: Watt-hours

J: Joules



The relationship between watt-hours and joules is given by $Wh = J/3600$.

Source Window (Time Range)

Specify the range over which to measure the loss by selecting one of the following windows.

Main: Main window

Zoom1: Zoom1 window

Zoom2: Zoom2 window

Measurement Time Period (T Range1 and T Range2)

Sets the measurement time period within the range of the measurement source window.

When cycle mode is OFF: The measurement time period is the entire range specified by T Range1 and T Range2.

When cycle mode is ON: The measurement time period is the range that can be extracted as a cycle within the range specified by T Range1 and T Range2.



The measurement range when Power Analysis1 is set to power supply analysis SW Loss is shared with the measurement range that is specified for the normal automated measurement of waveform parameters (Area1). For Power Analysis2, the measurement range is shared with that of enhanced parameter measurement (Area2).

Displaying Measured Results

When measurement results are displayed on the screen, symbols that indicate the measurement item, measurement channel, and enhanced parameter area are shown in front of the measured values as shown below.

Power Analysis1:

Example

P(C1)

P: Sum of active power

C1: Voltage channel

Power Analysis2:

Example

P(C1,A2)

P: Sum of active power

C1: Voltage channel

A2: Enhanced parameter area

* ",A2" is added only in the case of Power Analysis2, which uses enhanced parameter area Area2.

Power Waveform Display (Power(Math1 and Math2))

ON: The power waveform is displayed.

OFF: The power waveform is not displayed.



The DLM4000 computes the power value by multiplying the actual measured values for voltage and current. The power waveform display is not affected by the specified U:Level or I:Level, even when cycle mode is on.

Scaling (Ranging)

Specify the vertical display range of the power waveform.

Auto (Auto Scaling)

The vertical display range is determined automatically based on the computed results.

Manual (Manual Scaling)

Set the display range by specifying the center power value (Center) on the vertical axis and the power per division (Sensitivity).

Safe Operating Area Analysis (SOA)

You can plot the voltage input channel on the X-axis and the current input channel on the Y-axis, evaluate the operating range characteristics of a power device (or other device), and check whether or not the device operations fall within the safe operating area (SOA) indicated in gray in the figure below.

Selecting SOA automatically sets the DLM4000 to XY display mode.

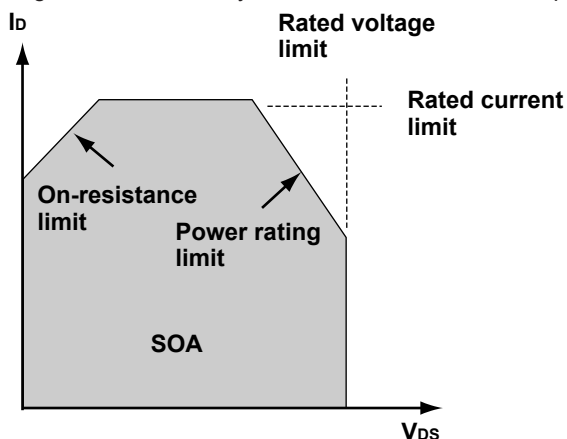

Probe Setup (Probe Setup)

The channel selection, probe attenuation, voltage-to-current conversion ratio, and deskew settings are the same as those for the switching loss analysis feature.

▶ [See here.](#)

Turning the VT Waveform Display On or Off (VT Display)

The SOA is displayed in the XY window. Use this setting to choose whether or not to display VT waveforms with the XY waveforms.

ON: The VT waveform display window appears.

OFF: The VT waveform display window does not appear.

Cursor Measurement (Cursor)

You can display two cursors on both the X and Y axes and measure with them simultaneously. The cursor setting range and measurement range are the same as those described in “Cursor Measurement (Cursor)” in chapter 8, “Displaying XY Waveforms.”

▶ [See here.](#)

Display Area (T Range1 and T Range2)

Set the start point (T Range1) and the end point (T Range2) of the display and of the measurement time period. Selectable range: ± 5 divisions from the center of the the main window of VT waveforms.

Harmonic Analysis (Harmonics)

You can measure and analyze harmonics. The harmonics display appears when you select Harmonics.

Harmonics

Harmonics are sine waves whose frequencies are integer multiples of the fundamental wave (normally a 50- or 60-Hz utility frequency sine wave). Harmonics do not include the fundamental wave. The input currents that flow through the power rectification circuits, phase control circuits, and other circuits used in various electrical and electronic equipment generate harmonic current or voltage on the power line. When the fundamental and harmonic waves are combined, waveforms become distorted, and interference sometimes occurs in equipment connected to the power line. The DLM4000 can analyze the harmonics generated by the applicable devices specified in the IEC standards according to their device class (A to D).^{1, 2} To take measurements accurately in accordance with IEC standards, we recommend that you use a digital power meter from the WT3000 series and harmonic measurement software (761922), both produced by YOKOGAWA. However, the harmonic analysis features on the DLM series are a good way of measuring general characteristics.

- 1 “The IEC standards” refers to: IEC 61000-3-2 Ed. 2.2, “Electromagnetic compatibility (EMC) - Part 3-2: Limits - Limits for harmonic current emissions (equipment input current ≤ 16 A per phase)” EN61000-3-2 (2000), IEC 61000-4-7 Ed. 2
- 2 “Applicable devices” refers to electrical and electronic devices that are connected to low voltage power distribution systems and that receive 16 A or less of current per cycle. The figure below provides a broad description of the applicable devices. However, while the DLM4000 can perform harmonic analysis on single-phase devices, it cannot perform analysis on three-phase devices.

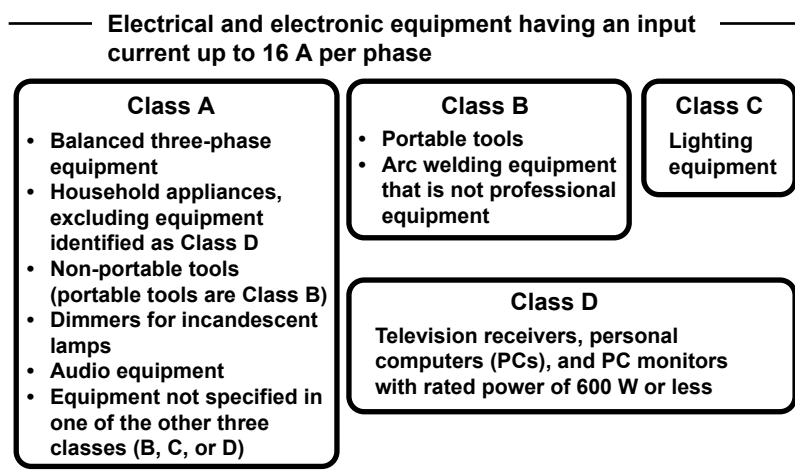

Fundamental Wave

The sine wave with the longest period among different sine waves derived from the periodic complex wave or the sine wave with the fundamental frequency among complex wave components.

Fundamental Frequency

In a periodic complex wave, this is the frequency corresponding to the longest period (the frequency of the fundamental wave).

Harmonic Order (harmonic order)

The ratio of the harmonic frequency to the fundamental frequency, expressed as an integer. The DLM4000 can analyze harmonic components up to the 40th harmonic.

Harmonic Component (harmonic component)

The components of waveforms whose frequency is an integer multiple of two or more of the fundamental frequency.

Interharmonics (interharmonics)

If the input signal is 50 Hz in IEC harmonic measurement, a Fourier transform is taken on 10 periods of the input signal to derive frequency components in 5-Hz resolution. As a result, the area between two harmonics is divided into 10 frequency components. Interharmonics is the term used to refer to these intermediate frequency components. If the input signal is 60 Hz, a Fourier transform is taken on 12 periods of the input signal to derive frequency components in 5-Hz resolution. As a result, the area between two harmonics is divided into 12 frequency components.

Measurement Conditions

To analyze harmonics, use the following measurement conditions.

Trigger Mode

To continuously analyze harmonics while acquiring waveforms, set the trigger mode to Normal.

▶ [See here.](#)

Time Window

Rectangle (rectangular window).

▶ [See here.](#)

Number of Waveforms and Number of Waveform Data Points

To perform analysis in accordance with harmonic current emission standards, you must configure the DLM4000 so that the number of data points and the number of periods meet the following conditions.

- Number of Data Points
9000 points or more in 200 ms of data
- Period
50-Hz power supply (45 Hz to 55 Hz): 10 periods of data
60-Hz power supply (55 Hz to 65 Hz): 12 periods of data

Probe Setup (Probe Setup)

The channel selection, probe attenuation, voltage-to-current conversion ratio, and deskew settings are the same as those for the switching loss analysis feature.

▶ [See here.](#)

Analysis Start Point (Start Point)

Set the analysis start point.

Power Supply Voltage of the EUT (System Voltage)

Set the power supply voltage of the device that you want to perform harmonic analysis on. The DLM4000 uses the power supply voltage to determine the harmonic limits set by the harmonic current emission standard and uses the limits as references (see below for more information). The default setting is 230 V.

Selectable range: 90 to 440 V

Resolution: 1 V

The harmonic current emission standard lists the limits for each harmonic when the (single-phase) power supply voltage is 220 V, 230 V, or 240 V. The limits for other power supply voltages must be determined through conversion. When the power supply voltage is outside of the range of 220 to 240 V, the DLM4000 power supply analysis feature uses the following equation to determine the limits for each class.

Converted limit = Limit for each class × 230/Equipment power supply voltage

Setting the Applicable Class (Class Setup)

Configure class-related settings.

Class (Class)

Sets the applicable class to A, B, C, or D.

- **Necessary Class C Settings**

- **EUT's active power (Over 25 watts)**

- Select whether the EUT's active power exceeds 25 W (True) or not (False). For class C, the reference values change depending on the EUT's active power.

17 Power Supply Analysis Feature (Power Analysis & Power Measurement; Option)

EUT's fundamental current (Fund Current)

Set the fundamental current when the EUT's load is at its maximum. To set the maximum current that is measured on the DLM4000, perform harmonic analysis with the maximum load, and then use the Max value that appears under the Order 1 column in the list.

For class C, evaluation is performed based on the ratio of harmonic components to the EUT's maximum fundamental current.

Power Factor (λ)

If the EUT's active (input) power exceeds 25 W (True), set the power factor that is observed when the EUT's load is at its maximum. You can acquire and use the currently measured power factor of the EUT (Get λ). For class C, if the EUT's active (input) power exceeds 25 W, the circuit power factor observed when the EUT's load is at its maximum is used to evaluate the ratio of the 3rd order harmonic component to the fundamental current.

Initial value: 0.80000

Selectable range: 0.01 to 1.000

Resolution: 0.001

- **Necessary Class D Settings**

EUT's active power (Power)

Set the EUT's active power. For class D, the harmonic current per watt (power ratio limit) is also used in the evaluation.

Harmonic Grouping (Grouping)

There are three types of IEC harmonic groupings. The method for calculating the magnitude of the harmonic rms values is different for each grouping.

- No grouping (OFF)

Only components whose frequencies are integer multiples of the fundamental wave are considered harmonics. Interharmonic components are not included.

- Grouping Type 1 (Type1)

A harmonic subgroup is treated as a component of the subgroup's harmonic. A harmonic subgroup includes a given harmonic and its two adjacent interharmonics. Therefore, if the input signal includes a harmonic subgroup, harmonic values will be greater than they are when grouping is turned off.

- Grouping Type 2 (Type2)

A harmonic group is treated as a component of the group's harmonic. A harmonic group includes a given harmonic and all of its adjacent interharmonics. Therefore, if the input signal includes a harmonic group, harmonic values will be greater than they are when grouping is turned off.

Configuring the Display (Display Setup)

Turn the display of VT waveforms on or off and set the bar graph display method.

VT Display

ON: The VT waveform display window appears.

OFF: The VT waveform display window does not appear.

Bar Graph Display Scale (Scale)

You can display a bar graph of the computed values and the standard limits of each harmonic up to the 40th order. You can set the scale to Linear or Log (logarithmic).

List Display (List)

You can display a list of the computed values and the standard limits of each harmonic up to the 40th order.

The contents of the list vary according to the class.

- When the class is A, B, or D
The list contains harmonic orders, their values and limits in amps, and information.
- When the class is C
The list contains harmonic orders, their values in amps, their limits (the standard limit ratio \times the fundamental current value in amps), their values as percentages (computed harmonic value in amps \div fundamental current value in amps), their limits as percentages (ratio of the harmonic to the fundamental current), and information.

List Size (List Size)

Select the list size and display position from one of the settings below.

Full Screen: The list is displayed in full-screen mode.

Half(Upper): The list is displayed in the top half of the screen.

Half(Lower): The list is displayed in the bottom half of the screen.

List Number (List No.)

The line corresponding to the number you select is highlighted.



-
- The DLM4000 can perform harmonic analysis on single-phase devices but not on three-phase devices.
 - IEC 61000-4-7 specifies that the measured data be smoothed using a first-order filter for 1.5 seconds, but the harmonics analysis results on the DLM4000 are instantaneous values. Therefore, the results do not fully comply with the standard. To take make proper measurements in accordance with the standard, you need to use a YOKOGAWA WT3000 series digital power meter and its harmonic measurement software (761922).
 - You can save the analysis results and the standard limits of each harmonic component to a CSV file. You cannot save the harmonic waveform data.
 - You can save the original waveform data that you used for harmonic analysis. If you save the waveform data, you can load it onto a DLM4000 with the power supply analysis feature (/G3 or /G4 option) and perform harmonic analysis.
 - You cannot perform harmonic analysis if 10 periods (for 45 Hz to 55 Hz) or 12 periods (for 55 Hz to 65 Hz) of a waveform correspond to less than 200 ms or if the number of data points is less than 9000 points. If this occurs, "-----" appears in the Measure (A) and Measure (%) columns in the list. "-----" also appears for harmonic limits (Limit(A)) that are not specified for a particular class.
-

Joule Integral (I²t)

You can measure Joule integrals I²t. This feature is useful when you are evaluating and comparing items such as device fuses. When you select I²t, you can display measured values and a waveform of the Joule integral and compute statistics.

$$\text{Joule integral } I^2t \text{ [A}^2\text{s]} = \int_0^T i(t)^2 dt$$

T: Measurement time period
i(t): Sampled current data

Probe Setup (Probe Setup)

The channel selection, probe attenuation, voltage-to-current conversion ratio, and deskew settings are the same as those for the switching loss analysis feature.

▶ [See here.](#)

Measurement Setup (Measure Setup)

Measurement Items (Item)

OFF: The Joule integral measured values are not displayed.

I²t: The Joule integral measured values are displayed.



The maximum number of measurement items that can be displayed is 30 including the automatically measured waveform parameters. If the measured joule integral values are not displayed, reduce the number of automatically measured waveform parameters. ▶ [See here.](#)

Source Window (Time Range)

Specify the range over which to measure the Joule integral by selecting one of the following windows.

Main: Main window

Zoom1: Zoom1 window

Zoom2: Zoom2 window

Measurement Time Period (T Range1 and T Range2)

Set the measurement time period in the source window.



The measurement range when Power Analysis1 is set to power supply analysis I²t is shared with the measurement range that is specified for the normal automated measurement of waveform parameters (Area1). For Power Analysis2, the measurement range is shared with that of enhanced parameter measurement (Area2).

Displaying Measured Results

When measurement results are displayed on the screen, symbols that indicate the measurement item, measurement channel, and enhanced parameter area are shown in front of the measured values as shown below.

Power Analysis1:

Example

I²t(C2)

I²t: Joule integral

C2: Current channel

Power Analysis2:

Example

I²t(C2,A2)

I²t: Joule integral

C2: Current channel

A2: Enhanced parameter area

* ",A2" is added only in the case of Power Analysis2, which uses enhanced parameter area Area2.

Joule Integral (I^2t) Waveform Display (I^2t (Math1 and Math2))

ON: The Joule integral (I^2t) waveform is displayed.

OFF: The Joule integral (I^2t) waveform is not displayed.

Auto Ranging (Auto Ranging)

You can execute auto ranging. Use this feature when the waveform amplitude changes greatly and the waveform is difficult to view.

You can also set the display range by specifying the vertical center I^2t value (Center) of the display area and the I^2t value per division (Sensitivity).



In Joule integral measurement, you can compute statistics in three different modes: Continuous, Cycle, and History. These modes can be specified when the automated measurement of waveform parameters is enabled.

Power Measurement (Power Measurement)

Power Measurement 1, Power Measurement 2, Power Measurement 3, and Power Measurement 4 (Power Measurement1, Power Measurement2, Power Measurement3, and Power Measurement4)

Power of up to four circuits (Power Measurement1 to Power Measurement4) can be measured simultaneously.

Turning Power Measurement ON or OFF (Mode)

Set whether to make power measurements.

- ON: Power measurement is enabled.
- OFF: Power measurement is disabled.



- [Power supply analysis](#) and power measurement of the power supply analysis feature cannot be executed simultaneously. If any of the power measurement items, Power Measurement1 to Power Measurement4, is set to ON, the power supply analysis is set to OFF. If power supply analysis is set to something other than OFF, all power measurements are set to OFF.
- For input channels that are assigned to power measurement and whose mode is set to ON, the following waveform parameters cannot be set: Max, Min, P-P, Rms, Mean, Sdev, Avg Freq. This is because these parameters overlap with those of the power measurement parameters, and the power measurement parameters are used in their place. [▶ See here.](#)
- If any of the power measurement modes is set to ON, cycle mode of automated measurement of waveform parameters is set to OFF.

Configuring the Probe (Probe Setup)

The pairs of voltage and current input channels assigned to Power Measurement1 to Power Measurement4 are fixed. Refer to the table below and apply the appropriate voltage and current signals. You cannot change these pairs.

Power Measurement	Voltage Input Channel	Current Input Channel
Power Measurement1	CH1	CH2
Power Measurement2	CH3	CH4
Power Measurement3	CH5	CH6
Power Measurement4	CH7	CH8

Probe Attenuation Ratio and Voltage-to-Current Conversion Ratio (Probe CH1/CH2, Probe CH3/CH4, Probe CH5/CH6, and Probe CH7/CH8)

Select the probe attenuation ratio (CH1, CH3, CH5, and CH7) and voltage-to-current conversion ratio (CH2, CH4, CH6, and CH8).

- CH1, CH3, CH5, CH7
0.001:1, 0.002:1, 0.005:1, 0.01:1, 0.02:1, 0.05:1, 0.1:1, 0.2:1, 0.5:1, 1:1, 2:1, 5:1, 10:1, 20:1, 50:1, 100:1, 200:1, 500:1, 1000:1, 2000:1
- CH2, CH4, CH6, CH8
0.001A:1V, 0.002A:1V, 0.005A:1V, 0.01A:1V, 0.02A:1V, 0.05A:1V, 0.1A:1V, 0.2A:1V, 0.5A:1V, 1A:1V, 2A:1V, 5A:1V, 10A:1V, 20A:1V, 50A:1V, 100A:1V, 200A:1V, 500A:1V, 1000A:1V, 2000A:1V



Changing the probe attenuation ratio or voltage-to-current conversion ratio here will change the same ratio in the CH key probe settings.

Deskewing Manually (Deskew CH1/CH2, Deskew CH3/CH4, Deskew CH5/CH6, and Deskew CH7/CH8)

You can set values for deskewing the transfer time difference between signals on each channel.

Auto Deskew Reference Waveform (Ref Trace)

Sets the reference waveform for auto deskewing. The DLM4000 deskews the input signals by using the specified waveform as its reference.

Auto Deskewing (Auto Deskew)

Executes auto deskewing.



You can also manually deskew the input signals by using the jog shuttle.

Measurement Setup (Measure Setup)

Like automated measurement of waveform parameters, items related to power can be measured automatically. Set the measurement item for each input channel.

Input channels and Measurement Items (Item Setup)

- **Measurement Items of Voltage Input Channels CH1, CH3, CH5, and CH7**

Voltage: U+pk, U-pk, Up-p, Urms, Udc, Uac, Umn, Urmn

Average frequency: Avg Freq

Power: S, P, Q

Impedance: Z

Power factor: λ

Watt-hours: Wp, Wp+, Wp-, Abs.Wp

For details on how each item is determined, see appendix 5, "How Power Measurement Items Are Determined."

▶ [See here.](#)

Unit (UNIT)

Select the unit to use when displaying the measured values for Wp, Wp+, Wp-, and Abs.Wp.

Wh: Watt-hours

J: Joules



The relationship between watt-hours and joules is given by $Wh = J/3600$.

17 Power Supply Analysis Feature (Power Analysis & Power Measurement; Option)

- **Measurement Items of Current Input Channels CH2, CH4, CH6, and CH8**

Current: I+pk, I-pk, Ip-p, Irms, Idc, Iac, Imn, Irmn

Average frequency: Avg Freq

Ampere-hours: q, q+, q-, Abs.q

For details on how each item is determined, see appendix 5.

▶ [See here.](#)



- The maximum number of measurement items that can be displayed is 30 including the automatically measured waveform parameters. If the measured power values are not displayed, reduce the number of automatically measured waveform parameters. ▶ [See here.](#)
 - For input channels that are assigned to power measurement and whose mode is set to ON, the following waveform parameters cannot be set: Max, Min, P-P, Rms, Mean, Sdev, Avg Freq. This is because these parameters overlap with those of the power measurement parameters, and the power measurement parameters are used in their place.
If you select any of the power measurement item U+pk, U-pk, Up-p, Urms, Udc, Uac, Avg Freq, I+pk, I-pk, Ip-p, Irms, Idc, Iac, and Avg Freq check boxes, the corresponding input channel waveform parameter Max, Min, P-P, Rms, Mean, Sdev, or Avg Freq check boxes will be selected.
 - In power measurement, statistical processing of Continuous, Cycle, or History, which are set in automated measurement of waveform parameters, can be executed.
-

Reference Levels (Ref Levels)

To determine the average frequency (Avg Freq), set the reference level for each of the Power Measurement1 to Power Measurement4 input channels as percentages or voltages. This feature is the same as the reference level of the automated measurement of waveform parameters.

▶ [See here.](#)



- If you set the reference levels using percentages, the distal, mesial, and proximal voltage values are determined based on the waveform.
 - If you want to set reference levels that do not change based on the waveform, set the levels as voltage values.
 - Changing the reference level settings here will also change the reference level settings for the automated measurement of waveform parameters.
-

Measurement Location Indicator (Indicator)

Indicates the measured location of a specified item using cursors. You can select one item from the power measurement items whose check boxes are selected.

Calculation (Calc Setup)

You can define four calculations (Calc1 through Calc4) that use the measured power values. This feature is the same as the calculation of the automated measurement of waveform parameters. However, the measurement items that you can select from the Measure menu of the displayed expression dialog box are power measurement items.

▶ [See here.](#)

Source Window (Time Range)

Specify the range over which to measure the power by selecting one of the following windows.

Main: Main window

Zoom1: Zoom1 window

Zoom2: Zoom2 window

Measurement Time Period (T Range1/T Range2)

Sets the measurement time period within the range of the measurement source window.

18 Displaying and Searching History Waveforms

Acquisition memory stores waveforms that are displayed on the screen and waveform data that have been acquired in the past. The history feature allows you to display or search past waveforms (history waveforms). You can perform the following operations on history waveforms:

- **Display**

You can display any single waveform or display all waveforms without gradation (and highlight only the specified waveform). You can also assign colors or intensities based on the frequency of occurrence of waveforms. You can list the timestamps (the trigger times) of all history waveforms.

Stores waveform data for the last N triggers

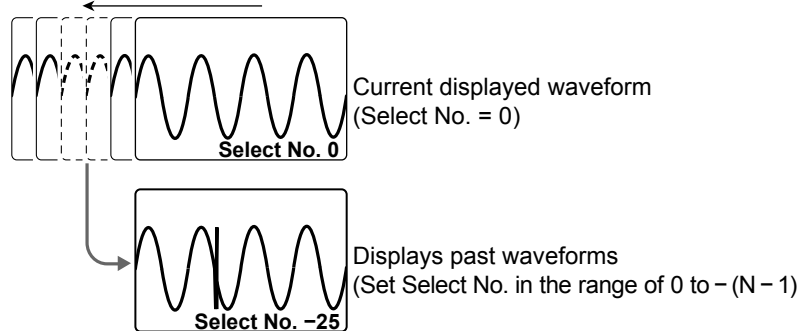

- **Search**

You can search for waveforms that meet the specified conditions, display the detected history waveforms, and list the timestamps of the waveforms.

Waveforms stored in the acquisition memory

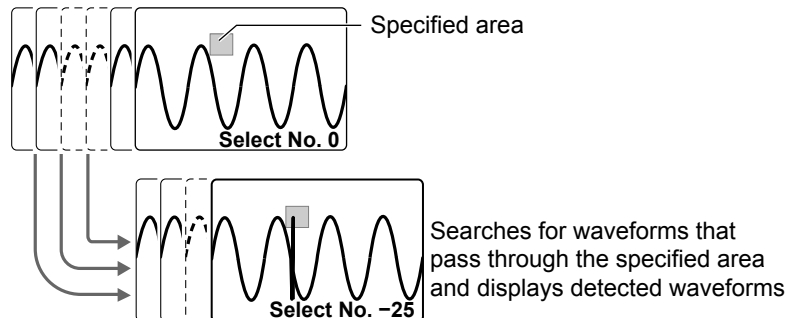

- **Average**

You can linearly average history waveforms in a specified range and display the averaged waveform.

- **Calculation, Cursor Measurement, Automated Measurement, Statistical Processing, and FFT**

You can perform calculations, cursor measurement, automated measurement of waveform parameters, or FFT analysis on the history waveform that you specified with Select No. You can also calculate statistics of automatically measured values on all history waveforms.

- **Displaying and Analyzing XY Waveforms**

You can display XY waveforms and perform analysis on the history waveform you specified with Select No. If the display mode is set to All, XY waveforms of all history waveforms are displayed.



- If you restart waveform acquisition by using the RUN/STOP key, all history waveforms that had been stored up to that point are cleared. However, if the trigger mode is set to Single (using the SINGLE key), the waveform that had been stored using the SINGLE key remains in the history memory unless you change the waveform acquisition conditions.
- If you change the waveform acquisition conditions, all history waveforms that had been stored in the memory are cleared.
- If you change user-defined computation settings while using the history feature, recomputation is not performed on the history waveforms. To recompute, execute Math on History.

Display Mode (Mode)

Selects how history waveforms are displayed.

- One: Displays only the waveform of the selected record number
- All: Displays all waveforms other than the highlighted waveform using an intermediate color and overlaps all selected history waveforms
- Accumulate: Displays the frequency of data occurrence by intensity (Intensity) or by color (Color) and overlaps all selected history waveforms.

Average (Average)

Highlights the waveform obtained by taking a linear average of the history waveforms in the range specified by Start No and End No. When the display mode is set All, all history waveforms that had been averaged are overlaid using an intermediate color.

Highlighting (Select No.)

The latest history waveform is assigned the record number zero, and older waveforms are assigned numbers in descending order (-1, -2, -3, and so on).

The waveform that correspond to the record number you specify here are highlighted.

Selectable range: 0 to -(the number of waveform acquisitions - 1)

You can use the jog shuttle to highlight history waveforms at high speeds. While you control the jog shuttle, history waveforms in the range corresponding to the speed of progression are collectively highlighted. Repeating this process, you can ultimately highlight all waveforms. When you stop controlling the jog shuttle, only the waveform of the record number indicated in Select No. will be highlighted.



In DLM4000 models with firmware version earlier than 3.00, highlighting history waveforms at high speeds highlighted waveforms at a given interval (not all the waveforms were highlighted). This meant that the waveform that you wanted to search for was sometimes not highlighted.

Maximum Number of Waveform Acquisitions

(Maximum number of history waveforms that can be stored in the acquisition memory)

The number of history waveforms that can be stored varies depending on the selected record length and the installed memory options as follows:

Record Length	Number of History Waveforms			
	No options (12.5 Mpoints)	/M1 Option (62.5 Mpoints)	/M2 Option (125 Mpoints)	/M3 Option (250 Mpoints)
1.25 kpoints	2500	10000	20000	50000
12.5 kpoints	250	1000	2500	5000
125 kpoints	20	100	250	500
1.25 Mpoints	1	10	20	50
6.25 Mpoints	1 ¹	1	-	10
12.5 Mpoints	1 ²	-	1	5
25 Mpoints	-	1 ¹	-	1
62.5 Mpoints	-	1 ²	1 ¹	1 ¹
125 Mpoints	-	-	1 ²	1 ¹
250 Mpoints	-	-	-	1 ²

1 Waveform acquisition is set to Single mode at this record length regardless of the trigger mode setting.

2 You can only specify this record length when interleave mode is on. Waveform acquisition is set to Single mode regardless of the trigger mode setting.

Display Range (Start/End No.)

Sets the range of history waveforms to display using record numbers when the display mode is set to All or Accumulate.

Selectable range: 0 to -(the number of waveform acquisitions - 1)

List of Timestamps (List)

Lists the history waveforms' record numbers, trigger timestamps, and time differences from the previous data triggers. The trigger timestamp resolution varies depending on the sample rate.

Searching the List

You can move to the following record number.

- Delta Min: Record number whose time difference between data triggers is lowest
- Delta Max: Record number whose time difference between data triggers is highest
- Oldest: The oldest record number
- Latest: The most recent record number



The data that the DLM4000 acquires 24 hours after starting waveform acquisition will not have time difference information in the timestamp list. Timestamps exceeding 1000 days since starting waveform acquisition are not displayed correctly.

Searching History Waveforms (Search)

Search Condition (Condition)

Select the search logic. If you select AND, history waveforms that meet the logical product of search conditions 1 to 4 (described later) will be searched for. If you select OR, those that meet the logical sum of will be searched for.

- Simple: Searches for history waveforms that enter a rectangular zone
- AND: Searches for history waveforms that meet all search conditions
- OR: Searches for history waveforms that meet any of the search conditions

Search Conditions (1 to 4)

For search conditions 1 to 4, set the source waveform, search range (the zone or the waveform parameter upper and lower limits), and the search criterion.



Search conditions 1 to 4 are shared with the reference conditions of GO/NO-GO determination.

Search Criterion (Condition)

Sets whether the source waveform must be in or out of the search range to be detected.

- IN: The source waveform is detected when it is in the search range.
- OUT: The source waveform is detected when it is out of the search range.
- X: Don't search

Source Waveform (Trace)

You can set the source waveform to one of the waveforms below. If you select LOGIC, select the [source bit](#). CH1 to CH8/LOGIC(L), LOGIC(A|B), Math1 to Math4, XY1 to XY4, FFT1, FFT2

- * CH8 or LOGIC(L), whichever the corresponding key is illuminated (CH8 or L), can be selected.

If you set search conditions 2 and 4 to Math, only waveform parameters can be specified.

Waveform zones cannot be specified for XY waveforms.

Only waveform parameters can be specified for LOGIC and FFT. If the search logic (Condition) is set to Simple, LOGIC and FFT waveforms cannot be selected.

LOGIC(A|B) is available on models with the /L16 option.

Search Range Mode (Mode)

You can set the method of setting the search range to one of the settings below.

- RectZone: Rectangular zone
- WaveZone: Waveform zone
- PolygonZone: Polygonal zone
- Parameter: Sets upper and lower limits for one measured waveform parameter

The methods for setting zones and the upper and lower limits of waveform parameters are the same as with GO/NO-GO determination (action).

▶ [See here.](#)

Executing a Search (Exec)

Searches for waveforms that meet the specified search conditions and displays only the waveforms and timestamps that are detected.

Finishing the Search (Reset)

Clears the history waveforms that were detected and displays all history waveforms.

Replay (Replay)

Displays the specified waveform first and then the older or newer data in order.

The following replay features are available.

Oldest ◀	Displays the oldest history waveform
◀	Replays waveforms toward older waveforms
■	Stops replay
▶	Replays waveforms toward newer waveforms
▶ Latest	Displays the latest history waveform

Start Waveform (Select No.)

Specifies the record number to start replaying.

Selectable range: 0 to -(the number of waveform acquisitions - 1)

Replay Speed (Speed, Down/Up)

There are seven replay speed levels (Speed): x1/60, x1/30, x1/10, x1/3, x1, x3, and x10.

- Down: Decreases the replay speed by one level.
- Up: Increases the replay speed by one level.

Notes about Using the History Feature

Notes about Configuring the History Feature

- When the acquisition mode is set to Average and the sampling mode is set to Repetitive, you cannot use the history feature.
- When the display is in roll-mode, you cannot use the history feature.
- If you stop waveform acquisition, the DLM4000 only displays waveforms that have been acquired completely.

Notes about Recalling Data Using the History Feature

- Waveform acquisition stops when you display the HISTORY menu. You cannot display history waveforms while waveform acquisition is in progress.
- You can start waveform acquisition when the HISTORY menu is displayed. However, you cannot change the history feature settings while waveform acquisition is in progress.
- The settings are restricted so that the following relationship is retained: Last record (End) \leq Select No \leq First record (Start).
- When you load waveform data from the specified storage medium, history waveforms up to that point are cleared. The loaded waveform data is placed in record number zero. If you load a file containing multiple waveforms, the latest waveform is placed in zero, and other waveforms are placed in order to record number -1, -2, and so on.
- Computation and automated measurement of waveform parameters are performed on the waveform of the record number specified by Select No. You can analyze old data as long as you do not overwrite the acquisition memory contents by restarting waveform acquisition. If Average is set to ON, analysis is performed on the averaged waveform.
- History waveforms are cleared when you turn the power off.

19 Printing and Saving Screen Captures

Destination Type (Print To)

You can save screen captures and print them on the following types of printers.

Built-in Printer (Built-in)

The optional built-in printer if it is installed.

▶ [See here.](#)

Network Printer (Network)

You can select a printer that is on the network that the DLM4000 is connected to. You must configure the network printer in advance.

▶ [See here.](#)

File (File)

You can save screen captures to files in PNG, BMP, and JPEG formats.

▶ [See here.](#)

Multiple Destinations (Multi)

You can perform the following operations at the same time.

- Print and save screen captures to multiple destinations
- Save waveform data to the output destination specified using the file list.

▶ [See here.](#)

Printing on the Built-in Printer (Built-in)

Print Mode (Mode)

On models with the optional built-in printer, you can print screen captures using one of three available modes.

Hard Copy (Hardcopy)

The entire DLM4000 screen is printed.

Normal (Normal)

The waveform area of the DLM4000 screen is printed. The menu is not printed. When the results of cursor measurements and automated measurement of waveform parameters are displayed, they are output below the waveform area.

Long (Long)

The same printout as Normal mode but with the waveform time axis magnified 2 to 10 times. The selectable magnification settings vary depending on the T/div and record length values. When the results of cursor measurements and automated measurement of waveform parameters are displayed, they are output below the waveform area.

Information (Information)

You can print the DLM4000 settings that were used at the time the waveform was acquired.

Comment (Comment)

You can print a comment up to 32 characters in length at the top section of the waveform.

Magnification (Mag)

If the print mode is set to Long, you can set the time-axis magnification. If you set the magnification to 2, the time axis will be twice as long as the printout in Normal mode.

Print Source Window (Time Range)

If the print mode is set to Long, you can set the window to print from one of the settings below.

- Main: Main window
- Zoom1: Zoom1 window
- Zoom2: Zoom2 window

Print Range (T Range1/T Range2)

If the print mode is set to Long, you can set the printout range within the print source window.

Printing on a Network Printer (Network)

You can select a printer that is on the network that the DLM4000 is connected to. You must configure the network printer in advance.

▶ [See here.](#)

Print Mode (Mode)

You can print the screen image in one of two modes.

Hardcopy (Hardcopy)

The entire DLM4000 screen is printed.

Normal (Normal)

The waveform area of the DLM4000 screen is printed. The menu is not printed. When the results of cursor measurements and automated measurement of waveform parameters are displayed, they are output below the waveform area.

Printer Type (Format)

The following printers can be used with the DLM4000.

- HP InkJetHP: inkjet printers
- HP Laser: HP laser printers
- EPSON InkJet: EPSON inkjet printers

Color (Color)

- ON: Prints using the same colors as the screen, excluding the background color. The grid is printed in black.
- OFF: Prints screen captures in the same way as when the DLM4000 prints on the built-in printer.

Comment (Comment)

You can print a comment up to 32 characters in length at the top section of the waveform.

Saving Screen Captures to Files (File)

You can save screen captures to files in PNG, BMP, and JPEG formats.

Save Mode (Mode)

Hard Copy (Hardcopy)

The entire DLM4000 screen is saved.

Normal (Normal)

The waveform area of the DLM4000 screen is saved. The menu area is not saved. When the results of cursor measurements and automated measurement of waveform parameters are displayed, they are output below the waveform area.

Wide (Wide)

The same screen capture as Normal mode but with the waveform time axis magnified 2 times. When the results of cursor measurements and automated measurement of waveform parameters are displayed, they are output below the waveform area.

Data Format (Format)

Select the data format for saving screen images from one of the settings below.

- PNG: The extension is .png. In Hard Copy mode, the file size is approximately 50 KB when you save a black and white screen capture, and approximately 200 KB when you save a color screen capture.
- BMP: The extension is .bmp. In Hard Copy mode, the file size is approximately 100 KB when you save a black and white screen capture, and approximately 1.6 MB when you save a color screen capture.
- JPEG: The extension is .jpg. In Hard Copy mode, the file size is approximately 300 KB for both black-and-white and color screen captures.



The file sizes listed here are for reference. Actual file sizes will vary depending on the image that is saved.

Color (Color)

- OFF: Saves data in black and white.
- ON: Saves data using 65536 colors.
- ON (Rev.): Saves data using 65536 colors. The image background is set to white.
- ON (Gray): Saves data using 32 grayscale levels.

Background Transparent or Opaque (Background)

For PNG format, you can save the waveform display area with a transparent background. This feature is convenient when you want to compare waveforms by overlaying screen captures on the PC.

- Normal: Saves data without changing the background (not made transparent).
- Transparent: Saves data by making the background transparent.

Including Setting Information (Information)

When save mode is set to Hardcopy or Normal, channels, triggers, waveform acquisition, and other setting information can be included in waveform screen captures.

- OFF: Setting information is not included.
- ON: Setting information is included.

Displaying the File List (File List)

Like the file feature, the DLM4000 lists the files on the specified drive.

▶ [See here.](#)

Assigning File Names (File Name)

Like the file feature, you can save files with automatically generated names using sequence numbers or dates, or save the files with specific file names.

▶ [See here.](#)

Printing and Saving Screen Captures to Multiple Destinations (Multi)

You can print and save screen-capture and waveform data to multiple output destinations at the same time. The DLM4000 outputs screen-capture and waveform data according to the PRINT menu or FILE menu settings.

Print screen captures on the built-in printer (Built-in)

▶ [See here.](#)

Print screen captures on a network printer (Network)

▶ [See here.](#)

Save screen captures to files (File)

▶ [See here.](#)

Save waveform data (Waveform)

▶ [See here.](#)



-
- If you are saving both screen-capture and waveform data at the same time, they are saved to the last destination specified using the file list.
 - When you are executing action-on-trigger or GO/NO-GO determination, if Print To is set to Multi, you cannot print or save screen captures.
-

20 Saving and Loading Data

You can save the following types of data to the internal memory, a USB storage device, or a network drive.

- Waveform data
- Setup data
- Screen image data
- Waveform zone data
- Snapshot waveform data
- Automated measurement data of waveform parameters
- Serial bus analysis results
- FFT waveform data
- Histogram data
- List of Timestamps data

You can load the following types of data from a storage medium into the DLM4000 internal memory.

- Waveform data
- Setup data
- Waveform zone and polygonal zone data
- Snapshot waveform data
- Physical value/symbol definition files

You can also rename and copy files and set or clear protection on files.

Storage Media You Can Save and Load From

The DLM4000 can access the following three types of storage media for saving and loading data.

Internal memory (Flash_Mem)

The internal memory is inside the DLM4000. For the memory size, see section 6.7 in the Getting Started Guide (IM DLM4038-03EN).

USB Storage Device (USB/USB1)

A USB storage device that is connected to the DLM4000 USB port. USB2.0 mass storage devices compatible with USB Mass Storage Class Ver. 1.1 can be connected to the DLM4000.

Network Drive (Network)

A storage device on a network. You can connect DLM4000 models to an Ethernet network and use a network drive.

▶ [See here.](#)



-
- Connect USB storage media directly, not through a USB hub.
 - Only connect a compatible USB keyboard, mouse, or storage device to the USB port for peripherals.
 - If you turn on the DLM4000 when there are USB devices connected to the USB ports for peripherals, the USB devices or the DLM4000 may not operate properly. In such cases, turn off the DLM4000, disconnect the USB devices, turn the DLM4000 back on, and then reconnect the USB devices. After turning off the power, wait at least 10 seconds before you turn it back on.
 - Do not connect and disconnect multiple USB devices repetitively. Provide a 10-second interval between removal and connection.
 - Do not connect or remove USB cables from the time when the DLM4000 is turned on until key operation becomes available (approximately 20 to 30 seconds).
 - You can use USB storage media that are compatible with USB Mass Storage Class Ver. 1.1.
 - The supported formats of USB storage media are FAT32 and FAT16.
 - The DLM4000 can identify up to four storage media. If the connected medium is partitioned, the DLM4000 treats each partition as a separate storage medium. As such, the DLM4000 can handle up to four partitions. On models with the /C8 option, if the USB storage media format is FAT32, the DLM4000 can identify only a single storage medium.
-

Saving Data (Save)

The DLM4000 saves data to the specified storage medium.

[Waveform data](#), [Setup data](#), [Other types of data](#)

Saving Waveform Data (Waveform)

You can save the waveform data that the DLM4000 has measured to a file in binary or ASCII format or to a file in ASCII format with time information.

Save Destination (File List)

Specify the data save destination.

File Name (File Name)

You can set a file name. You can also use the auto naming feature to automatically assign file names.

- **Auto Naming (Auto Naming)**

OFF

Disables the auto naming feature. The name that you specify using the File Name setting is used.

Numbering

The DLM4000 automatically adds a three-digit number between 000 to 999 after the common name specified using the File Name setting and saves files.

Date

An 8-character file name produced based on the date and time using base 36 numbers (0 to 9 and A to Z).

The file name specified using the File Name setting is not used.)

Y M D H : : :

Time in unit of 100 ms
0 ms = 0000, 100 ms = 0001, ..., 59 min 59 s 900 ms = ORRZ
Hour 0 = 0, ..., hour 9 = 9, hour 10 = A, ..., hour 23 = N
1st = 1, ..., 10th = A, ..., 31st = V
Jan. = 1, ..., Oct. = A, Nov. = B, Dec. = C
2000 = 0, ..., 2010 = A, ..., 2035 = Z

Date 2

The file name is the date and time (down to ms) when the file is saved. The file name specified using the File Name setting is not used.

20121130_121530_100 (2012/11/30 12:15:30.100)

Year Month Day Hour Minute Second ms

- **File Name (File Name)**

You can set the common file name that is used when the auto naming feature is turned off or when the auto naming feature is set to Numbering. The maximum number of characters that you can use for file names and folder names is 63 characters. The following restrictions apply.

- The following types of characters can be used: 0 to 9, A to Z, a to z, _, -, =, (,), {, }, [,], #, \$, %, &, ~, !, `, and @. @ cannot be entered consecutively.
- The following character strings cannot be used due to MS-DOS limitations.
AUX, CON, PRN, NUL, CLOCK, LPT1, LPT2, LPT3, LPT4, LPT5, LPT6, LPT7, LPT8, LPT9, COM1, COM2, COM3, COM4, COM5, COM6, COM7, COM8, or COM9
- Make sure that the full file path (absolute path from the root folder) is less than or equal to 255 characters in length. If it exceeds 255 characters, an error occurs when you perform a file operation (such as save, copy, rename, or create folder). When an operation is being performed on a folder, the full path is up to the name of the folder. When an operation is being performed on a file, the full path is up to the name of the file.

If you set auto naming to Date (date and time), the characters that you entered for the file name will not be used. File names will only consist of the date information.

- **Comment (Comment)**

You can add a comment that consists of up to 128 characters when saving files. You do not have to enter a comment. All characters, including spaces, can be used in a comment.

Data Type (Data Type)

Set the data type to binary, ASCII, or ASCII with time information.

- **Binary (Binary)**

- The data stored to the acquisition memory is saved to a file in binary format.
- You can load the data into the DLM4000, display the waveform of the data, and view the values that it contains. You can use the YOKOGAWA's Xviewer software application to analyze waveforms on your PC. For details, contact your nearest YOKOGAWA dealer. You can download a trial version from the YOKOGAWA website.
- Data size = Record length (Mpoint) × 2 (bytes/point) × the number of traces (from 1 to 12)
- The extension is .wdf.

- **ASCII (ASCII)**

- The data stored in the acquisition memory is converted using the specified range and saved to a file in ASCII format.
- You can use the file to analyze waveforms on your PC. You cannot load the file into the DLM4000. If the record length is less than or equal to 1.25 Mpoints, all of the waveform data can be saved.
- Data size = Record length (Mpoint) × 10 (bytes/point) × the number of traces (from 1 to 12)
If the record length exceeds 1.25 Mpoints, data will be compressed and saved.
- The extension is .csv.

- **ASCII with Time Information (ASCII with TimeInfo.)**

- The time information is attached to the data stored in the acquisition memory, and this data is converted using the specified range and saved to a file in ASCII format.
- Data size = Record length (Mpoint) × {10 (bytes/point) × the number of traces (from 1 to 12) + 16 (bytes/point)}
- The extension is .csv.

Waveform to Save (Trace)

- You can save all waveforms (All) or a selected waveform from CH1 to CH8/LOGIC(L), LOGIC(A|B), and Math1 to Math4.
 - * CH8 or LOGIC(L), whichever the corresponding key is illuminated (CH8 or L), can be selected. LOGIC(A|B) is available on models with the /L16 option.
- The vertical-axis, horizontal-axis, and trigger settings are also saved along with the waveforms.
- If you select all waveforms, only the waveforms that are displayed out of CH1 to CH8/LOGIC(L), LOGIC(A|B), and Math1 to Math4 are saved. However, in interleave mode, computed waveforms whose source is set to CH2, CH4, CH6, CH8, or LOGIC(L) cannot be saved.

Setting the History Range (History)

Of the waveforms that are selected to be saved, set which range of history waveforms to save.

- One: The single waveform that is specified with Select No. on the HISTORY menu* will be saved.
- All: All history waveforms within the range bounded by Start No. and End No. on the HISTORY menu* will be saved. If you search for history waveforms, and then select All, only the detected waveforms will be saved.
- * The menu that appears when HISTORY (√N) is pressed

History Range One and All Settings

The history range is fixed to One or All depending on the display mode (Mode) on the HISTORY menu and the type of data to be saved (Data Type).

Display Mode (Mode) on the HISTORY Menu		One	All	Accumulate
Type of data to be saved (Data Type)	Binary	One or All selectable	One or All selectable	Fixed to All
	ASCII	Fixed to One	Fixed to One	Fixed to One
	ASCII with TimeInfo.	Fixed to One	Fixed to One	Fixed to One



If Average on the HISTORY menu is set to ON, only a single set of averaged waveform data will be saved regardless of the display mode specified on the HISTORY menu, the type of data to be saved, and the history range.

▶ See here.

Window to Be Saved (Range)

Select the window to be saved from the following:

- Main: Main window
- Zoom1: Zoom1 window
- Zoom2: Zoom2 window

Data Compression (Compression)

If the window to be saved is set to Main, you can save the waveform data by compressing or sampling it. If you want to save waveform data whose record length is more than 1.25 Mpoints to a file in ASCII format, the data must be compressed.

- **OFF**
All of the data is saved without compression or sampling. Binary files can be loaded into the DLM4000. Data in ASCII format or Data with time information in ASCII format cannot be loaded.
- **Saving Data through Compression (p-p)**
The waveform data is P-P compressed so that the number of data points is equal to the specified number and then saved. Data that has been compressed and saved cannot be loaded into the DLM4000 regardless of the format (data in ASCII format, data with time information in ASCII format, or data in binary format).
- **Saving Data through Sampling (Decim)**
The data is sampled (decimated) so that the number of data points is equal to the specified number and then saved. Data that has been sampled and saved cannot be loaded into the DLM4000 regardless of the format (data in ASCII format, data with time information in ASCII format, or data in binary format).



- The accumulate setting is always off while waveform data is loaded.
- Compressed and sampled waveform data in binary format can be loaded into the DLM4000 as a reference waveform. For details, see the explanation under “Loading Data.”
- If you change the extension of the saved data file, by using a PC or some other device, the DLM4000 will no longer be able to load it.
- Up to 2500 files and folders can be displayed in the file list. If there are more than a total of 2500 files and folders in a given folder, the file list for that folder will only display 2500 files and folders. There is no way to set which files and folders are displayed.
- If the window to be saved is set to Zoom1 or Zoom2, data compression is not possible. Therefore, waveform data whose number of data points on the window to be saved exceeds 1.25 Mpoints cannot be saved to a file in ASCII format.

Saving Setup Data (Setup)

You can save setup data to a file or to any of the three internal memory locations.

Saving to a File

As with waveform data, you can save setup data to a specified storage medium.

You can specify file names and enter comments in the same way as with waveform data.

▶ [See here.](#)

Saving to Internal Memory

You can save up to three sets of setup data to internal memory areas #1 to #3. It is convenient to save setup data that you use frequently.

- **#1 to #3**

Setup data numbers. To save or load setup data, you can simply specify one of these numbers.

- **Detail Setting (Detail)**

On the detail setting screen, you can add comments to setup data for identification and protect setup data from overwriting. The detail setting screen also displays the date and time when the setup data is saved.

Saving Other Types of Data (Others)

You can save screen image data, waveform zone data, snapshot waveform data, automated measurement values of waveform parameters, serial bus analysis results, FFT computation results (FFT waveform data), histogram data, and list of timestamps.

For details on the serial bus analysis results, see “[Serial Bus Analysis Results \(Others - Serial Bus \(FlexRay/CAN/CAN FD/LIN/CXPI\)\)](#)” and “[Serial Bus Analysis Results \(Others - Serial Bus \(SENT/PSI5 Airbag/UART/I²C/SPI\)\)](#),” later in this manual.

You can specify file names in the same way as with waveform data.

▶ [See here.](#)

Screen Captures (Screen Image)

You can save screen captures to files in PNG, BMP, and JPEG formats.

Data Format (Format)

- PNG: The extension is .png. The file size is approximately 50 KB when you save a black and white screen capture, and approximately 200 KB when you save a color screen capture.
- BMP: The extension is .bmp. The file size is approximately 100 KB when you save a black and white screen capture, and approximately 1.6 MB when you save a color screen capture.
- JPEG: The extension is .jpg. The file size is approximately 300 KB for both black-and-white and color screen captures.



- The file sizes listed here are for reference. Actual file sizes will vary depending on the image that is saved.
- You can also save screen captures using the menu that you can access by pressing SHIFT+PRINT. The screen captures that you can save using the FILE menu explained here are the same as those that you can save by selecting Normal in the SHIFT+PRINT menu. If you want to save screen captures including the setup menu or if you want to save images whose time axis is magnified two times, use different options in the menu that you can access by pressing SHIFT+PRINT.

▶ [See here.](#)

Color (Color)

- OFF: Saves data in black and white.
- ON: Saves data using 65536 colors.
- On (Reverse): Saves data using 65536 colors. The image background is set to white.
- Gray: Saves data using 32 grayscale levels.

20 Saving and Loading Data

Background (Background)

For PNG format, the background of the waveform display area can be made transparent when the data is saved. This feature is convenient when you want to compare waveforms by overlaying screen captures on the PC.

- Normal: Saves data without changing the background (not made transparent).
- Transparent: Saves data by making the background transparent.

Including Setting Information (Information)

Setting information such as channels, triggers, and waveform acquisition can be included in waveform screen captures.

- OFF: Setting information is not included.
- ON: Setting information is included.

Waveform Zone (Wave-Zone)

You can save each waveform zone (Zone No. #1 to #4) that is used in GO/NO-GO determination and history waveform searching.

▶ [See here.](#)

The extension is .zwf.

Snapshot Waveform Data (Snap)

You can save snapshot waveforms.

Automated Measurement Values of Waveform Parameters (Measure)

You can save specific automatically measured values to a file in CSV format.

The extension is .csv.

CSV files are text files that contain data separated by commas. They are used to convert data between spreadsheet and database applications.

The number of previous values that you can save is equal to 100000/the number of items that are turned on.

Data size in bytes = The number of measured items × 15 × the number of history waveforms

Output Example

Analysis Type	WaveParameter					
Model Name	DLM4000					
Model Version	*.**					
	Rms(C1)	Mean(C1)	Sdev(C1)	ITY(C1)	Dly(C1)	Calc1(A2)
	V	V	V	Vs	s	
:Max	7.12E-01	5.05E-03	7.12E-01	5.05E-05	1.13E-03	1.13E+00
:Min	7.10E-01	-4.44E-03	7.10E-01	-4.44E-05	-8.99E-04	1.08E+00
:Mean	7.11E-01	1.07E-03	7.11E-01	1.07E-05	3.44E-04	1.10E+00
:Sigma	2.47E-04	2.04E-03	2.48E-04	2.04E-05	9.68E-04	8.23E-03
:Cnt	134	134	134	134	134	134
7021	7.11E-01	2.29E-03	7.11E-01	2.29E-05	1.11E-03	1.10E+00
7031	7.11E-01	1.43E-03	7.11E-01	1.43E-05	1.11E-03	1.11E+00
7040	7.11E-01	3.51E-03	7.11E-01	3.51E-05	1.11E-03	1.10E+00
7050	7.11E-01	1.73E-03	7.11E-01	1.73E-05	1.11E-03	1.11E+00
7059	7.11E-01	1.80E-03	7.11E-01	1.80E-05	-8.86E-04	1.11E+00
7069	7.11E-01	1.15E-03	7.11E-01	1.15E-05	1.11E-03	1.10E+00
7078	7.11E-01	1.45E-04	7.11E-01	1.45E-06	-8.82E-04	1.12E+00
7088	7.11E-01	2.98E-03	7.11E-01	2.98E-05	1.11E-03	1.10E+00
7098	7.11E-01	3.27E-03	7.11E-01	3.27E-05	-8.92E-04	1.09E+00
7107	7.11E-01	3.12E-03	7.11E-01	3.12E-05	-8.83E-04	1.12E+00

FFT computation Results (FFT)

You can save the results of FFT1 or FFT2 computation (FFT waveform data) to a file in CSV format. The extension is .csv. Up to 250 Kpoints of data can be saved.

- **Freq Info.**

ON: All data is saved with frequency information.

Data size in bytes = The number of data points × 30

OFF: The results are saved without frequency information.

Data size in bytes = The number of data points × 15

▶ [See here.](#)

Output Example

(When Freq Info. is set to OFF)		(When Freq Info. is set to ON)	
Header Size	10	Header Size	10
Model Name	DLM4000	Model Name	DLM4000
Commnet		Commnet	
TraceName	FFT1	TraceName	FFT1
BlockSize	6251	BlockSize	6251
VUnit	dBV	VUnit	dBV
HResolution	1.00E+02	HResolution	1.00E+02
HUnit	Hz	HUnit	Hz
Date	2012/9/13	Date	2012/9/13
Time	18:35:02	Time	18:35:02
-3.10E+01		0.00E+00	-5.48E+01
-5.43E+01		1.00E+02	-7.27E+01
-4.16E+01		2.00E+02	-5.84E+01
-6.69E+01		3.00E+02	-7.79E+01
-4.80E+01		4.00E+02	-6.12E+01
-5.26E+01		5.00E+02	-6.14E+01
-6.39E+01		6.00E+02	-6.02E+01
-5.11E+01		7.00E+02	-6.58E+01
-5.17E+01		8.00E+02	-6.18E+01
-5.87E+01		9.00E+02	-6.53E+01

Histogram (Histogram)

You can save the histogram of the waveform or the waveform parameter that was specified using Histogram1 or Histogram2.

▶ [See here.](#)

List of Timestamps (History List)

You can save the list of history waveform information—record number, trigger time, and the difference between the trigger times of the history waveform and its previous history waveform—in CSV format. The extension is .csv.

Data size in bytes = The number of history waveforms × 72

▶ [See here.](#)

Output Example

Data Type	HistoryList		
Model Name	DLM4000		
Model Version	* **		
Start No.	0		
End No.	-99		
No.	Trig'd Time	Delta	
	0 16:12:08.407 320	0.006 000	
	-1 16:12:08.401 320	0.008 000	
	-2 16:12:08.393 320	0.006 000	
	-3 16:12:08.387 320	0.006 000	
	-4 16:12:08.381 318	0.015 002	
	-5 16:12:08.366 318	0.006 000	
	-6 16:12:08.360 318	0.006 000	
	-7 16:12:08.354 318	0.006 000	
	-8 16:12:08.348 318	0.006 000	
	-9 16:12:08.342 318	0.036 000	
	-10 16:12:08.306 320	0.005 998	

CAN, CAN FD

You can save analysis results of CAN or CAN FD bus signals to a file in CSV format. The extension is .csv. Analysis results of up to 100000 frames (50000 frames for CAN FD) can be saved.

Data size*

CAN: (The number of frames in analysis results + 4) × 125 bytes

CAN FD: (The number of frames in analysis results + 4) × 300 bytes

* The data size is a reference value. It is not strictly warranted. Use it as a guideline when you save data.

CAN Output Example

Analysis Type	Model Name	Model Version	SerialBus(CAN)	DLC in hexadecimal		Data in hexadecimal		CRC sequence in hexadecimal		Ack	Information
				ID	DLC	Data	CRC				
No. -8	-17.5848		Data	00A	2	1		0			
-7	-17.2968		Error								
-6	-15.0728		Data	00A	2	01 02	4A24		Y		
-5	-12.5608		Data	12	1	FE	2263		Y		
-4	-10.1204		Data	100	3	FF 01 A4	6C6E		Y		
-3	-7.5364		Data	00A	2	01 02	4A24		Y		
-2	-5.0244		Data	12	1	FE	2263		Y		
-1	-2.5844		Data	100	3	FF 01 A4	6C6E		Y		
0	-0.0004		Data	00A	2	01 02	4A24		Y		
1	2.5116		Data	12	1	FE	2263		Y		
2	4.9516		Data	100	3	FF 01 A4	6C6E		Y		
3	7.5356		Data	00A	2	01 02	4A24		Y		

ID in hexadecimal
 Frame type
 Amount of time from the trigger position to the start of frame
 Analysis number
 ACK slot state
 Y: ACK present
 N: ACK not present

CAN FD Output Example

“CAN FD:ISO” is displayed when the CAN FD standard is set to ISO.
 “CAN FD:non-ISO” is displayed when the CAN FD standard is set to non-ISO.

Analysis Type	Model Name	Model Version	SerialBus(CAN FD:ISO)	DLC in hexadecimal		Data in hexadecimal		CRC sequence in hexadecimal		Ack	Information
				ID	DLC	Data	SC	CRC			
No. -5	-2.137288		FD Data	1FFFFFFF	4	FF FF FF FF		C	11606	Y	CRC Error(Seq)
-4	-2.034984		Error								
-3	-1.943288		FD Data	15555555	8	55 AA C3 0F 55 AA C3 0F	0	19B09F		Y	
-2	-1.71728		FD Data	0AAAAAAA	8	AA 55 3C F0 AA 55 3C F0	0	005ED1		Y	
-1	-1.00528		FD Data	78	2	0F 0F		A	00C18	Y	
0	-0.19673		FD Data	01E38000	1	7		9	1592F	Y	ESI(Error Passive)
1	1.050728		FD Data	101	0			3	1417A	Y	
2	1.200728		FD Data	102	0			C	0EADE	Y	
3	1.650736		FD Data	104	1	8		6	312	N	
4	2.006736		Data	0	8	00 00 00 00 00 00 00 00		145B		Y	

ID in hexadecimal
 Frame type (“Data” is displayed for CAN.)
 Amount of time from the trigger position to the start of frame
 Analysis number
 ACK slot state
 Y: ACK present
 N: ACK not present
 Error information
 Stuff Error
 Fixed Stuff Error
 CRC Error(SC;Seq)
 ESI(Error Passive)
 etc.

20 Saving and Loading Data

LIN

You can save analysis results of LIN bus signals to a file in CSV format. The extension is .csv. Analysis results of up to 100000 frames can be saved.

Data size* = (The number of frames in the analysis results + 4) × 125 bytes

* The data size is a reference value. It is not strictly warranted. Use it as a guideline when you save data.

Output Example

Analysis Type		SerialBus(LIN)		Checksum in hexadecimal	
Model Name		DLM4000			
Model Version		*..			
No.	Time(ms)	ID	ID-Field	Data	Checksum Information
-4	-208.116	3E 11	19 2A 3B 4C 5D 6E 7F 81	68	
-3	-156.036	3E 11	19 2A 3B 4C 5D 6E 7F 81	68	
-2	-103.952	3E 11	19 2A 3B 4C 5D 6E 7F 81	68	
-1	-51.868	3E 11	19 2A 3B 4C 5D 6E 7F 81	68	
0	0.216	3E 11	19 2A 3B 4C 5D 6E 7F 81	68	
1	52.3	3E 11	19 2A 3B 4C 5D 6E 7F 81	68	
2	104.384	3E 11	19 2A 3B 4C 5D 6E 7F 81	68	
3	156.464	3E 11	19 2A 3B 4C 5D 6E 7F 81	68	
4	208.548	3E 11	19 2A 3B 4C 5D 6E 7F 81	68	

Analysis number | Amount of time from the trigger position to the start of frame | ID in hexadecimal | ID-Field in hexadecimal | Data in hexadecimal | Checksum information | Error information: ID Parity error, Checksum error

CXPI

You can save analysis results of CXPI bus signals to a file in CSV format. The extension is .csv. Analysis results of up to 10000 frames can be saved.

Data size* = (The number of frames in analysis results + 4) × 900 bytes

* The data size is for reference. It is not strictly warranted. Use this as reference for saving data.

Output Example

Analysis Type		SerialBus(CXPI)		Data in hexadecimal		CRC in hexadecimal	
Model Name		DLM4000					
Model Version		*..					
No.	Time(ms)	ID	DLC	W/S	CT	Data	CRC Information
-3	-52.4732	3	L16	0	0	00 11 22 33 44 55 66 77 88 99 AA BB CC DD EE FF	2B30
-2	-32.4704	4	12	0	0	40 41 42 43 44 45 46 47 48 49 4A 4B	D0
-1	-12.4676	5	12	0	0	50 51 52 53 54 55 56 57 58 59 5A 5B	E0
0	-0.4864	P20	2	0	0	01 FF	A1
1	7.5356	6	12	0	1	60 61 62 63 64 65 66 67 68 69 6A 6B	7D
2	27.5384	7	12	0	1	70 71 72 73 74 75 76 77 78 79 7A 7B	4D
3	47.5412	8					ID-Parity Error
4	67.544	9	12	0	0	90 91 92 93 94 95 96 97 98 99 9A 9B	F4 CRC Error
5	87.5468	0A	12	0	1	A0 A1 A2 A3 A4 A5 A6 A7 A8 A9 AA AB	96 Data Length Error
6	107.5496	0B	12	0	1	B0 B1 B2 B3 B4 B5 B6 B7 B8 B9 BA BB	Framing Error
7	127.5524	0C					IBS Error

Analysis number | Amount of time from the trigger position to the start of frame | ID in hexadecimal | DLC in decimal | W/S indicator in binary | CT in decimal | Data | CRC information | Error information: PTYPE Parity Error, ID Parity Error, CRC Error, Data Length Error, Framing Error, IBS Error, Clock Error, Counter Error

Serial Bus Analysis Results (Others - Serial Bus (SENT/PSI5 Airbag/UART/I²C/SPI))

You can save analysis results for the buses that you specified with the Serial Bus1, Serial Bus2, Serial Bus3, and Serial Bus4 settings.

For details on FlexRay, CAN, CAN FD, LIN, and CXPI analysis results, see “[Serial Bus Analysis Results \(Others - Serial Bus \(FlexRay/CAN/CAN FD/LIN/CXPI\)\)](#).”

History Range (History)

The analysis results are saved according to the settings made on the HISTORY menu and the analysis result save menu. For details on the feature, see “Setting the History Range” for when saving waveform data. You can select the history range for saving analysis results from the same options that are available as when you save waveform data in binary format.

▶ [See here.](#)

You cannot save the results of analyzing a user-defined serial bus signal (User Define).

SENT

You can save analysis results of SENT signals to a file in CSV format. The extension is .csv. Analysis results of up to 100000 frames can be saved. Trend data can be saved in compressed form. For details on data compression, see “Data Compression” for when saving waveform data.

▶ [See here.](#)

Data size*

Fast CH or Both list: (The number of frames in analysis results + 4) × 100 bytes

Slow CH list: (The number of frames in analysis results + 4) × 30 bytes

Trend (without data compression): (Display record length × a) + 750 bytes

a = 25 for data with time information, a = 15 for data without

* The data size is a reference value. It is not strictly warranted. Use it as a guideline when you save data.

Output example of a Fast CH or Both List

Binary display of status and communication														
Hexadecimal or decimal display of data (according to data type (Nibble, User))														
Hexadecimal or decimal display of CRC														
Analysis Type	SerialBus(SENT)													
Model Name	DLM4000													
Model Version	*.**													
No.	Time(ms)	Sync(us)	Tick(us)	S&C	D1	D2	D3	D4	D5	D6	CRC	Length(tick)	Information	SlowCH
-1	-1.115384	167.92	3.00	0000	8 B	6 E	B	7 7	7 7	7 7	7 7	299.97		
0	-0.215884	167.91	3.00	0100	8 B	6 E	C	7 9	7 9	7 9	7 9	306.99		
1	0.704592	167.94	3.00	0000	8 B	6 E	D	7 B	7 B	7 B	7 B	305.96		
2	1.622156	167.91	3.00	0000	8 B	6 E	E	7 D	7 D	7 D	7 D	225.00		

Time duration of clock tick determined from the time duration of SYNC/CAL
 Time duration of SYNC/CAL
 Time from the trigger position to the start of frames
 Analysis number
 Error information
 Frame length
 Slow CH information (displayed when the analysis display channel (Display) is set to Both)

20 Saving and Loading Data

Output example of a Slow CH List

Analysis Type		SerialBus(SENT)		Hexadecimal or decimal display of CRC	
Model Name		DLM4000		Error information	
Model Version		*.**		Information	
No.	Time(ms)	ID	Data	CRC	Information
-3	-45.94672	6	3	0D	
-2	-30.6392	1	205	0B	
-1	-15.31336	2	900	28	
0	-0.01192	88	201	20	
1	15.48904	1	206	1A	
2	31.01336	2	930	30	

Hexadecimal or decimal display of data
 Hexadecimal or decimal display of ID
 Time from the trigger position to the start of frames
 Analysis number

Output example of a Trendt

Header Size	15	For the meanings of each header in trend data, see appendix 3. The following information is displayed in Trace Name. Fast CH Serial bus number (SENT):Fast:User Data number Slow CH Serial bus number (SENT):Slow:ID
Model Name	DLM4000	
Comment		
BlockNumber	1	
TraceName	SBus1(SENT):Fast:User2	
BlockSize	1250000	
VUnit		
SampleRate	1250000.0	
HResolution	8.000000E-07	
HOffset	-4.999992E-01	
HUnit	s	
DisplayBlockSize	1250000	
DisplayPointNo.	1	
Date	2015/05/02	
Time	08:54:13.000000	
-249.64400E-03		
-249.64000E-03		
-249.63600E-03	1290	
-249.63200E-03	1290	
...		
249.60400E-03	2458	
249.60800E-03	2458	
249.61200E-03		
249.61600E-03		

Trend value
 (Nothing is displayed for sections where the start or end of frames or data cannot be detected. "Nan" is displayed for sections where errors are detected.)
 Time from the trigger position to the trend data point
 (The column will be empty if the data type is set to not include time information (TimeInfo is set to OFF).)

PSI5 Airbag

You can save analysis results of PSI5 Airbag signals to a file in CSV format. The extension is .csv. Analysis results of up to 400000 frames can be saved.

Data size* = (The number of frames in analysis results + 4) × 30 bytes

* The data size is for reference. It is not strictly guaranteed. Use this as reference for saving data.

Output Example

Analysis Type		SerialBus(PSI5 Airbag)		Parity or CRC value in hexadecimal notation			
Model Name		DLM4000		Error information			
Model Version		* **					
No.	Time(ms)	from Sync(us)	Slot No.	Data	Parity/CRC	Information	Frame Error Clock Error Start Bit Error Parity/CRC Error Frame Number Error Slot Boundary Error
-4	-0.49844		Sync				
-3	-0.440456	57.98	1	383	1		
-2	-0.300864	197.58	2	3ED	0		
-1	-0.145344	353.1	3	301	1		
0	0.000056	498.5	Sync				
1	0.058032	57.98	1	384	0		
2	0.197592	197.54	2	3E7	0		
3	0.353104	353.05	3	302	1		
4	0.498472	498.42	Sync				

Hexadecimal or decimal display of data
For sync pulses, the word "Sync"
For data frames, the slot number
If sync signal is X, blank

Time from the start of the previous sync pulse to the start of the data frame or time from the start of the previous sync pulse to the start of the applicable sync pulse
If sync signal (Sync) is X or for the first sync signal, blank

Time from the trigger position to the start of sync pulses or time from the trigger position to the start of data frames

Analysis number

UART

You can save analysis results of UART signals to a file in CSV format. The extension is .csv. Analysis results of up to 300000 bytes can be saved.

Data size* = (The number of frames in the analysis results + 4) × 40 bytes

* The data size is a reference value. It is not strictly warranted. Use it as a guideline when you save data.

Output Example (when grouping is set to ON)

Analysis Type		SerialBus(UART)			
Model Name		DLM4000			
Model Version		* **			
No.	Time(ms)	Data(HEX)	Data(ASCII)	Information	
-4	-209.948	00 80 40 C0 20 04 84 44@. ..D\$.L,..B."		
-3	-157.864	00 80 40 C0 20 04 84 44@. ..D\$.L,..B."		
-2	-105.78	00 80 40 C0 20 04 84 44@. ..D\$.L,..B."		
-1	-53.696	00 80 40 C0 20 04 84 44@. ..D\$.L,..B."		
0	-1.612	00 80 40 C0 20 04 84 44@. ..D\$.L,..B."		
1	50.468	00 80 40 C0 20 04 84 44@. ..D\$.L,..B."		
2	102.552	00 80 40 C0 20 04 84 44@. ..D\$.L,..B."		
3	154.636	00 80 40 C0 20 04 84 44@. ..D\$.L,..B."		
4	206.72	00 80 40 C0 20 04 84 44@. ..D\$.L,..B."		

Data1 in hexadecimal Data1 in ASCII

Amount of time from the start point Error information
Framing error
Parity error

Analysis number

20 Saving and Loading Data

I²C

You can save analysis results of I²C bus signals to a file in CSV format. The extension is .csv. Analysis results of up to 300000 bytes can be saved.

Data size* = (The number of bytes in the analysis results + 4) × 125 bytes

* The data size is a reference value. It is not strictly warranted. Use it as a guideline when you save data.

Output Example

		Analysis result in hexadecimal			
Analysis Type	SerialBus(I2C)				
Model Name	DLM4000				
Model Version	**. **				
No.	Time(ms)	1st	2nd	R/W	Data Information
-4	-208.116	AA*		W	AE* 8B*
-3	-156.036	75*		R	BC* EF
-2	-103.952	38*		W	53* A9*
-1	-51.868	9D*		R	10* 4B

Read/Write bit state
(W stands for write; R stands for data request.)

Address type

Amount of time from the trigger position

Analysis number

* ACK present

SPI

You can save analysis results of SPI bus signals to a file in CSV format. The extension is .csv. Analysis results of up to 300000 bytes can be saved.

Data size* = (The number of bytes in the analysis results × 2 + 4) × 125 bytes

* The data size is a reference value. It is not strictly warranted. Use it as a guideline when you save data.

Output Example

Analysis	Type	SerialBus(SPI)
Model Name	DLM4000	
Model Version	**. **	
No.	Time(ms)	Data
-6	-0.65304	Data1 00 00 00 00 00 7F FF FF FF FF FF FF F8 00
-5	-0.63704	Data1 FF E0 00 3F FF FF FF FF FF FF FC 00 07 FF
-4	-0.60504	Data1 FF E0 00 00 00 7F FF 00 00 00 03 FF FF FF
-3	-0.25304	Data1 00 1F FF C0 00 7F FF 00 01 FF FF FF FF FF
-2	-0.23704	Data1 FF FF FF C0 00 00 00 00 00 00 03 FF F8 00
-1	-0.20504	Data1 00 1F FF FF FF 80 00 FF FE 00 03 FF F8 00
0	0.14696	Data1 00 00 00 3F FF FF FF FF FE 00 03 FF FF FF
1	0.16296	Data1 00 1F FF FF FF FF FF FF FF FC 00 07 FF
2	0.19496	Data1 FF FF FF C0 00 00 00 00 01 FF FC 00 00 00
3	0.54696	Data1 00 1F FF FF FF 80 00 FF FF FF FF FF F8 00

Data1 in hexadecimal

Amount of time from the start point

Analysis number

Loading Data (Load)

You can load waveform data, setup data, waveform zones, polygonal zones, and snapshot waveforms that have been saved by the DLM4000.

You can also view information about the saved data files using the File Property menu item.

File Properties (File Property)

You can display the file name (Name), data size (Size), save date (Date), attributes (Attr) and other file properties regarding the selected file.

Loading Waveform Data (Waveform)

You can load waveform data, including Math1 to Math4 waveforms. Waveform data in binary format (files with .wdf extension) can be loaded.

Loading Waveform Data into Channels (Load to Channels)

You can load the waveform data of the specified file along with the setup data into the acquisition memory. All the data in the file is loaded. You can display computed waveforms by setting the computation mode on the MATH/REF menu to Math.

This command is used to view or analyze waveform data that has been stored in the past on the DLM4000.

Because setup data is also loaded, the DLM4000 settings change when you load waveform data.

Load data is cleared when you start measurement.

Loading Waveform Data into Reference Waveforms (Load to Ref1(Math1) to Load to Ref4(Math4))

You can load the waveform data of the specified file as a reference waveform. Setup data is not loaded. You can display reference waveforms by setting the computation mode on the MATH/REF menu to Ref.

If the number of data points exceeds the specified record length, the DLM4000 samples the data so that the number of points is equal to the specified record length and displays the sampled data.

Reference waveforms are used to compare current waveforms to waveforms saved in the past and to perform computation.



-
- You may not be able to load waveform data if the memory size of the model that you used to save the waveform data with and that of the model that you are trying to load data into are different. If the waveform data record length is less than or equal to 1.25 Mpoints, the DLM4000 loads the data.
 - To load a file saved from the waveform data of multiple channels as a reference waveform, use Load to Channels to load the waveform into channels, and then load the waveform as a computation [reference waveform](#).
 - The waveforms that have been acquired at the maximum record length and the waveform data that has been acquired at the maximum record length and saved to files cannot be loaded as a reference waveform.
-

Loading Setup Data (Setup)

You can load setup data. There are two methods you can use to load setup data. One method is to load setup data that has been saved to a file. The other method is to load setup data that is saved in the internal memory.

Loading Setup Data That Has Been Saved to a File (Load Setup File)

You can load a .set file that contains setup data that you have saved.

Loading Setup Data That Has Been Save to an Internal Memory Location (#1 to #3)

You can load setup data that has been saved to internal memory locations #1 to #3.

Detail Display (Detail)

You can view the date and time when setup data was saved to internal memory areas #1 to #3 and the comments attached to the data.

You can change comments, or enable or disable file protection.

Loading Other Types of Data (Others)

You can load waveform zones, polygonal zones, snapshot waveforms, and serial bus signal symbols.

Waveform and Polygonal Zones (Wave Zone/Polygon Zone)

You can load waveform zones that you created on the DLM4000 into internal memory locations Zone1 to Zone4. You can load zones that have been saved to .zwf files and you can load polygonal zones that have been saved to .msk files using the dedicated software application.

These zones are used for GO/NO-GO determination and other purposes.

Snapshot Waveforms (Snap)

You can load .snp files that contain snapshot waveforms that you have saved.

Snapshot waveforms that you load are displayed in white on the screen.

Symbol Data (Symbol)

Character strings based on definitions in a CANdb file can be used to express bit patterns. You can load physical value/symbol definition files (.sbl extension) that you have edited using the Symbol Editor tool.

The bit patterns can be used as CAN bus signal trigger conditions or as analysis or search conditions.

- **Files with .sbl Extensions**

CANdb files (.dbc extension) must be converted into physical value/symbol definition files (.sbl extension) using the Symbol Editor before they can be loaded and used as trigger conditions or as analysis or search conditions on the DLM4000. You can obtain the free software "Symbol Editor" from the YOKOGAWA website (<http://www.yokogawa.com/ymi/>).

CANdb files (.dbc) are signal definition database files created using the CANdb or CANdb++ software produced by Vector Informatik.

File Operations (Utility)

You can create folders on the storage medium, delete and copy files, change file names, and so on.

Sorting the List (Sort To)

Sorts the file list by file name, data size, date, etc.

Display Format

Selects whether to display a list of files or to display thumbnails.

Selecting the Type of File to List (Filter)

You can limit the type of files that appear in the list by selecting the extension.

Changing the Storage Media (Change Drive)

You can select the storage medium that you want to access.

The DLM4000 displays various storage media as follows:

Flash_Mem: Internal memory

USB: The first detected USB storage device that is connected to a DLM4000's USB port (type A) for connecting peripheral devices.

USB1: The second detected USB storage device that is connected to a DLM4000's USB port (type A) for connecting peripheral devices.

Network: Network storage device

Deleting Files and Folders (Delete)

You can delete selected files and folders.

Renaming Files and Folders (Rename)

You can rename a selected file or folder.

Making Folders (Make Dir)

You can create folders.

▶ [See here.](#)

Copying and Moving Files and Folders (Copy, Move)

You can copy or move selected files and folders to other storage media or folders.

Turning Protection On or Off (Protect ON/OFF)

You can turn protection on or off for the selected file. The change is reflected in the file attributes, displayed under the Attr column in the file list.

Protection	File Attribute	Description
ON	r	File protection is on for the selected file. The file can be read from. Writing is not allowed. Deleting is also not allowed.
OFF	r/w	File protection is off for the selected file. The file can be read from and written to.

File Properties (File Property)

You can display the file name (Name), data size (Size), save date (Date), attributes (Attr) and other file properties regarding the selected file.

Selecting Files (All Set, All Reset, and Set/Reset)

You can select or deselect all the files and folders in the list at once.

You can also select or deselect files and folders that are highlighted.



- You can format the internal memory (Flash_Mem) by pressing UTILITY and then using Storage Manager on the System Configuration menu.
▶ [See here.](#)
- You can abort file copying and deleting. However, files that are already being processed are not applicable.

21 Ethernet Communication (Network)

You can configure TCP/IP parameters and use the Ethernet interface to perform the following tasks.



To use this feature, set the communication interface to Network (from the UTILITY menu, select Remote Control > Device > Network).

TCP/IP

TCP/IP settings for connecting to an Ethernet network.

Set the IP address, subnet mask, and default gateway.

▶ [See here.](#)

FTP Server (FTP/Web Server)

You can connect the DLM4000 to a network as an FTP server.

You can connect to the DLM4000 from a PC on the same network and retrieve waveform data.

▶ [See here.](#)

Web Server (FTP/Web Server)

You can connect the DLM4000 to a network as a Web server.

You can connect to the DLM4000 from a PC on the same network and monitor the DLM4000 display from the PC.

▶ [See here.](#)

Mail (Mail)

The action-on-trigger or GO/NO-GO action can be set to mail transmission.

▶ [See here.](#)

Network Drive (Net Drive)

You can save waveform data and setup data to a network drive.

▶ [See here.](#)

Network Printer (Net Print)

You can specify a network printer for printing screen images.

▶ [See here.](#)

SNTP

The DLM4000 clock can be set using SNTP. The DLM4000 can be configured to automatically adjust its clock when it is turned on.

▶ [See here.](#)



To connect a PC to the DLM4000, use a hub or router, and connect to a network. Do not connect a PC directly to the DLM4000.

TCP/IP (TCP/IP)

Configure the settings that the DLM4000 needs to connect to a network.

DHCP

DHCP is a protocol that temporarily allocates settings that a PC needs to connect to the Internet.

To connect to a network that has a DHCP server, turn the DHCP setting on. When DHCP is turned on, the IP address can be automatically obtained when the DLM4000 is connected to a network. (You do not have to set it manually.)

When DHCP is turned OFF, you must set the appropriate IP address, subnet mask, and default gateway for the network.

DNS

DNS is a system used to associate Internet host names and domain names with IP addresses. Given AAA.BBBBB.com, AAA is the host name and BBBBB.com is the domain name. You can use host names and domain names to access the network instead of using IP addresses, which are just numbers. The DLM4000 allows you to specify the host by name, instead of by IP address. Set the domain name and the DNS server address (0.0.0.0 by default). For details, consult your network administrator.

DNS Servers (DNS Server1/DNS Server2)

You can specify up to two DNS server addresses: primary and secondary. If querying fails with the primary DNS server, the secondary DNS server is automatically used to find the mapping of the host name and domain name to the IP address.

Domain Suffixes (Domain Suffix1/Domain Suffix2)

The domain suffix is a piece of information that is automatically added when a query is made to a DNS server using only a portion of the domain name. For example, if BBBBB.com is registered as a domain suffix and a query is made using "AAA," the name "AAA.BBBBB.com" is searched.

You can specify up to two domain suffixes: Domain Suffix1 and Domain Suffix 2.

You can use up to 30 characters. The characters that you can use are 0 to 9, A to Z, a to z, and -.

TCP/IP settings are applied when you press Bind or when you turn on the DLM4000 the next time.

FTP Server (FTP/Web Server)

You can connect the DLM4000 as an FTP server to a network.

Set the user name and password that will be used by devices on the network to access the DLM4000. Also, set the access timeout value.

FTP Server On and Off (FTP Server)

ON: The FTP server feature is enabled.

OFF: The FTP server feature is disabled.

User Name (User Name)

Set the user name that will be used to access the DLM4000 from a PC. The characters that you can use for the user name are all of the ASCII characters on the keyboard. You can use up to 30 characters. If you set the user name to "anonymous," you can connect to the DLM4000 without entering a password.

Password (Password)

Set the password that will be used to access the DLM4000 from a PC. The characters that you can use for the password are all of the ASCII characters on the keyboard. You can use up to 15 characters.

Timeout (Timeout)

If a connection cannot be established between the DLM4000 and the PC within the amount of time specified here, the DLM4000 aborts the connection process.



To apply the settings that you have entered, press Entry.

FTP Server Overview

When the DLM4000 is connected to the network as an FTP server, the following features become available.

FTP Server

From a PC, you can view a list of files that are stored in the DLM4000 storage medium (the internal memory or a storage medium that is connected to it) and retrieve files.

PC Environment

PC System Requirements

A PC running the English or Japanese version of Windows 7 (32 bit or 64 bit), Windows 8 (32 bit or 64 bit), Windows 8.1 (32 bit or 64 bit), or Windows 10 (32 bit or 64 bit)

Internal memory

512 MB or more recommended.

Communication ports

100BASE-TX or 1000BASE-T Ethernet port. Use this port to connect the PC to the network.

Display

A display compatible with any of the above operating systems and with a resolution of 1024×768 or higher.

Mouse or pointing device

Mouse or pointing device compatible with any of the above operating systems

Web Server (FTP/Web Server)

You can connect the DLM4000 as a Web server to a network.

Set the user name and password that will be used by devices on the network to access the DLM4000. Also, set the access timeout value.

Web Server On and Off (Web Server)

ON: The Web server feature is enabled.

OFF: The Web server feature is disabled.

User Name (User Name)

Set the user name that will be used to access the DLM4000 from a PC. The characters that you can use for the user name are all of the ASCII characters on the keyboard. You can use up to 30 characters. If you set the user name to "anonymous," you can connect to the DLM4000 without entering a password.

Password (Password)

Set the password that will be used to access the DLM4000 from a PC. The characters that you can use for the password are all of the ASCII characters on the keyboard. You can use up to 15 characters.

Timeout (Timeout)

If a connection cannot be established between the DLM4000 and the PC within the amount of time specified here, the DLM4000 aborts the connection process.



To apply the settings that you have entered, press Entry.

Web Server Overview

When the DLM4000 is connected to the network as an Web server, the following features become available.

Web Server

You can display the DLM4000 screen on the PC and start and stop measurement through the Ethernet network. You can refresh the DLM4000 screen that is displayed on the PC and take screen captures.

PC Operations

Setting the Screen Update Rate: You can set the update rate to 2, 5, 10, 30 or 60 s.

Screen Update Start: The display starts updating automatically at the rate that you specify.

Screen Update Stop: You can stop the updating of the display.

Manually Update the Screen: You can update the display manually.

START/STOP: You can start and stop measurement on the DLM4000.

Full Screen Capture: You can take full-screen screen captures.

PC Environment

The requirements are the same as for the FTP server.

▶ [See here.](#)

Web browser

Internet Explorer 10 (Windows 8), Internet Explorer 11 (Windows 7, Windows 8.1, Windows 10),
Edge (Windows 10)



-
- Flash Player by Adobe (version 8 or later) is required when using the Web server function. When visiting this Web site, the most recent Flash Player is automatically downloaded. If the download does not begin, please obtain the latest Flash Player from the Adobe Web site.
 - When using the full screen capture function, be sure to disable pop-up blockers on your browser.
 - The Web server function is unavailable when printing on the instrument or manipulating files.
 - The Web server function can also not be used if the instrument is connected to a PC while the Mass Storage setting is enabled on the PC. After disconnecting the PC or enabling the USBTMC setting, restart the DLM4000.
-

Mail (Mail)

You can send trigger times and other information in emails to a specific email address as an action in the action-on-trigger or GO/NO-GO determination feature.

Mail Server (Mail Server)

Specify the IP address of the mail server on the network that the DLM4000 will use. In a network with a DNS server, you can specify the host name and domain name instead of the IP address.

Mail Address (Mail Address)

You can specify multiple email recipient addresses. Separate each address with a comma.

Comment (Comment)

If necessary, you can enter a comment in the first line of emails.

Attaching Image Files (Attached Image File)

You can attach a capture of the screen that is displayed at the time the email is sent.

File format: PNG

File name: DLM_image[time].png

(Example: DLM Image1211171158.png is a screen capture taken at 11:58 on November 17, 2012.)

Resolution: XGA (1024×768 dots)

Approximate File Size

Normal screen: Approx. 50 KB

Maximum: Approx. 1.6 MB (when the screen contains many colors)

Timeout (Timeout)

If the DLM4000 cannot send an email for the amount of time specified here, it disconnects from the mail server.

User Authentication (POP3 before SMTP)

Before you send an e-mail, POP3 user authentication is performed.

- **User Authentication On and Off**

ON: Authentication is performed before e-mails are sent.

OFF: Authentication is not performed before e-mails are sent.

- **Encryption type**

U/P: The authentication data is sent in plaintext.

APOP: The authentication data is encrypted before it is sent.

- **Server name**

Set the POP3 server host name or IP address. The characters that you can use are all the ASCII characters on the keyboard. You can use up to 30 characters.

- **User name**

Set the user name that is required for accessing the POP3 server from the DLM4000. The characters that you can use are all the ASCII characters on the keyboard. You can use up to 30 characters.

- **Password**

Set the password that is required for accessing the POP3 server from the DLM4000. The characters that you can use are all the ASCII characters on the keyboard. You can use up to 30 characters.



The DLM4000 supports plaintext (U/P) and encrypted (APOP) POP3 user authentication.*

* APOP uses the MD5 algorithm (Message-Digest Algorithm 5 by RSA Data Security, Inc.).

Sending a Test Mail (Send Test Mail)

You can send a test mail to check whether emails can be sent properly.

Network Drive (Net Drive)

You can save waveform data and setup data to a network drive.

FTP Server (FTP Server)

Specify the IP address of the FTP server (network drive) for saving waveform and setup data. In a network with a DNS server, you can specify the host name and domain name instead of the IP address.

User name (User name)

Set the user name (login name) for logging in to the network drive. You can use up to 14 characters. The characters that you can use for the password are all of the ASCII characters on the keyboard. You can use up to 14 characters.

Password (Password)

Specify the password that corresponds to the login name. The characters that you can use for the password are all of the ASCII characters on the keyboard. You can use up to 14 characters.

Passive Mode (Passive)

Turn passive FTP on or off.

In passive mode, the FTP client sets the port number for data transfer. Enable passive mode when you have set an external FTP server as a network drive or when you are accessing an FTP server through a firewall.

Timeout (Time Out)

If the DLM4000 cannot transfer files for a certain amount of time, it disconnects from the FTP server.

Connecting to the Network Drive(Connect/Disconnect)

When you press the Connect button, the DLM4000 connects to the specified network drive, and the drive appears in the file list (File List). When you press the disconnect button, the network drive is disconnected and removed from the file list (File List).

Network Printer (Net Print)

You can print screen images on a network printer.

The DLM4000 can print to the following printers.

HP InkJet printers

HP Laser printers

EPSON InkJet printers

LPR servers (LPR Server)

Specify the IP address of the printer server that the DLM4000 will connect to. In a network with a DNS server, you can specify the host name and domain name instead of the IP address.



LPR is a protocol used to print over a TCP/IP network.

LPR Name (LPR Name)

The name of the shared printer that the DLM4000 will connect to.

Timeout (TimeOut)

If the DLM4000 cannot print for a certain amount of time, it disconnects from the network printer.

SNTP (SNTP)

The DLM4000 clock can be set using Simple Network Time Protocol (SNTP). The DLM4000 can be configured to automatically adjust its clock when it is turned on.

SNTP Server (SNTP Server)

Specify the IP address of the SNTP server that the DLM4000 will use. In a network with a DNS server, you can specify the host name and domain name instead of the IP address.

Timeout (Timeout)

If the DLM4000 cannot connect to the SNTP server for a certain amount of time, it aborts the operation.

Executing Time Adjustment (Adjust)

The DLM4000 clock is synchronized to the SNTP server clock.

Automatic Adjustment (Adjust at PowerON)

You can configure the DLM4000 so that its clock is automatically synchronized to the SNTP server clock when the DLM4000 is turned on when it is connected to the network.



-
- If the time difference from GMT (Greenwich Mean Time) is set in the date/time setting, the DLM4000 will make appropriate adjustments to the time information received from the SNTP server.
▶ [See here.](#)
 - If you do not want the DLM4000 to synchronize with an SNTP server, do not set the SNTP server IP address.
-

22 Other Features

Auto Setup (AUTO SETUP)

The auto setup feature automatically sets the SCALE, TIME/DIV, trigger level, and other settings to values that are most suitable for the input signals.

This feature is useful when you are not sure what type of signal will be applied to the DLM4000. The auto setup feature will not work properly on some input signals.

Center Position after the Execution of Auto Setup

The center position after you execute auto setup will be 0 V.

Source Channels

The DLM4000 executes auto setup based on the signals of all channels excluding LOGIC ports.

Waveforms Displayed before the Execution of Auto Setup

Waveforms that were displayed before you execute auto setup will be cleared.

Signals That Auto Setup Can Be Applied To

You can use auto setup for the following types of input signals.

- Simple, repeating signals whose frequency is 50 Hz or higher
- Signals whose maximum absolute input voltage is 20 mV or greater at 1:1 probe attenuation.



-
- The auto setup feature may not work properly for signals that include a DC component or high-frequency components.
 - The auto setup menu for analyzing serial bus signals is located in the setup menu of each serial bus analysis.

▶ [See here.](#)

Undoing Auto Setup (Undo)

You can revert to the settings that were used immediately before you executed auto setup.

Returning to the Default Settings (DEFAULT SETUP)

You can reset the DLM4000 settings to their factory default values. This feature is useful when you want to cancel all of the settings that you have entered or when you want to redo measurement from scratch. Default reset refers to the act of resetting the DLM4000 settings to their factory default values.

Items That Cannot Be Reset

The following settings cannot be reset.

- Date and time settings
- Communication settings
- Language setting (English or Japanese)
- Measured value font size setting

Undoing Default Reset (Undo)

If you perform default reset by mistake, you can undo it by pressing the Undo soft key.

To Reset All Settings to Their Default Values

While holding down the RESET key, turn the power switch on. All settings except the date and time settings (display on/off setting will be reset) and the setup data stored in internal memory will be reset to their factory default values. If you reset the settings in this manner, you will not be able to go back to the original settings.



Default Values of Legacy Models

You can initialize the settings according to the factory default values of the DL7400. Press UTILITY, the Preference soft key, and then the Legacy Mode soft key.

Doing so will initialize the following items to the default values of legacy models.

Item	Legacy Mode OFF		Legacy Mode ON
AcqLen	125k	→	12.5k
DispFormat	Single	→	Octal
AccumMode	Inten	→	Off
MeasDelayRef	TrigPos	→	A channel from CH1 to Math4

Snapshot (SNAP SHOT)

Retains the currently displayed waveforms on the screen. This feature allows you to update the display without having to stop waveform acquisition. It is a useful feature when you want to compare waveforms.

Snapshot waveforms are displayed in white and moves behind the normal waveforms.

You cannot perform the following operations on snapshot waveforms.

Cursor measurement, automated measurement of waveform parameters, zoom, or computation

You can save and load snapshot waveforms.

Clear Trace (CLEAR TRACE)

Clears all of the waveforms that are displayed on the screen.

If you change the display format or perform other similar operations, the DLM4000 redisplay the channel waveforms, computed waveforms, and loaded waveforms that were displayed before you executed the clear trace operation.

If you execute a clear trace operation during waveform acquisition, the DLM4000 restarts waveform acquisition (from the first acquisition). All history waveforms that have been stored up to that point are cleared.

Snapshot and clear trace features are disabled:

- When the DLM4000 is printing, when it is executing auto setup, or when it is accessing a storage medium.
- When go/no-go determination is in progress, when action-on-trigger is in progress, or when searching is in progress.

Calibration (Calibration)

Executing Calibration (Cal Exec)

Calibrates following items. Execute calibration when you want to make accurate measurements.

- Vertical axis ground level and gain
- Trigger level
- Measured time value for repetitive sampling

Calibration is performed automatically when the power switch is turned on.

Notes about Calibration

- Allow the DLM4000 to warm up for at least 30 minutes before you execute calibration. If you execute calibration immediately after power-on, the calibrated values may drift due to temperature changes or other environmental changes.
- Execute calibration in a stable temperature environment ranging from 5 to 40°C (23 ± 5° recommended).
- Do not apply signals when calibrating. Calibration may not be executed properly when input signals are being applied to the DLM4000.

Auto Calibration (Auto Cal)

The DLM4000 will automatically perform calibration when you perform one of the operations below if the following times have passed since the power was turned on.

3 minutes, 10 minutes, 30 minutes, 1 hour, and every hour after

- When you change TIME/DIV during waveform acquisition (when RUN/STOP is illuminated)
- When you start waveform acquisition when acquisition is stopped (when RUN/STOP is not illuminated)

If calibration occurs when signals are being received by the DLM4000, we recommend that you calibrate again without the signals.

Remote Control (Remote Control)

Communication interface for controlling the DLM4000 from a PC. For details, see the communication interface user's manual, IM DLM4038-17EN.

Types of Communication Interfaces (Device)

USB, GP-IB, and Network[VXI-11] are the available communication interfaces.



- Only use the selected communication interface. If you send commands simultaneously from another communication interface that has not been selected, the DLM4000 will not execute the commands properly.
 - REMOTE appears at the top of the screen slightly right of center when the DLM4000 is communicating with a PC in remote mode. All keys except SHIFT + CLEAR TRACE are disabled in Remote mode.
-

USB

Connects the DLM4000 to a PC using USB.

To remotely control the DLM4000 using communication commands through the USB port, select USBTMC and then carry out the following procedure.

- Install YOKOGAWA USB TMC (Test and Measurement Class) driver on your PC. For information about how to obtain the YOKOGAWA USB TMC driver, contact your nearest YOKOGAWA dealer. You can also access the YOKOGAWA USB driver download website and download the driver (<http://tmi.yokogawa.com/service-support/downloads/>).
- Do not use USB TMC drivers (or software) supplied by other companies.

GP-IB

Connects the DLM4000 to a PC using GP-IB.

Address (Address)

- You can set the address to a value from 0 to 30.
- Each device that is connected by GP-IB has its own unique address in the GP-IB system. This address is used to distinguish one device from other devices. Therefore, you must assign a unique address to the DLM4000 when connecting it to a PC or other device.



When the controller is communicating with the DLM4000 or with other devices through GP-IB, do not change the address.

Notes about Connections

- Several cables can be used to connect multiple devices. However, no more than 15 devices, including the controller, can be connected on a single bus.
- When connecting multiple devices, you must assign a unique address to each device.
- Use cables that are 2 m or shorter in length to connect devices.
- Keep the total length of the cables under 20 m.
- When devices are communicating, have at least two-thirds of the devices on the bus turned on.
- To connect multiple devices, use a star or daisy-chain configuration. Loop and parallel configurations are not allowed.

Network[VXI-11]

Connects the DLM4000 to a PC using Ethernet.

Access Mode (Mode)

Select whether a device on the network is allowed to access the DLM4000.

- ON: Allows access
- OFF: Denies access



You must set TCP/IP parameters to connect the DLM4000 to an Ethernet network.

▶ [See here.](#)

Notes about Connections

- To connect the DLM4000 to a PC, be sure to use straight cables through a hub. Correct operation is not guaranteed for a one-to-one connection using a cross cable.
- Use one of the following types of network cable that conforms to the transfer speed of your network.
 - A UTP (Unshielded Twisted-Pair) cable
 - An STP (Shielded Twisted-Pair) cable

System Configuration (System Configuration)

You can specify the following settings.

- DLM4000 date and time
- Click sound on/off
- Language
- Backlight adjustment
- Format Internal Memory
- USB Keyboard Language
- USB Communication

Date and Time (Date/Time)

The DLM4000 date and time.

Turning the Display On and Off (Display)

Sets whether or not to display the date and time on the DLM4000 screen.

Display Format (Format)

Select the display format from one of the settings below.

- Year/Month (numeric)/Day
- Day/Month (numeric)/Year
- Day-Month (English abbreviation)-Year (the lower two digits)
- Day Month (English abbreviation) Year

Date and Time (Date, Time)

Sets the date and time.

Time Difference from Greenwich Mean Time (Time Diff. GMT)

Set the time difference between the region where you are using the DLM4000 and Greenwich Mean Time.

Selectable range: Set the time difference in the range of -12 hours 00 minutes to 13 hours 00 minutes.

For example, Japan standard time is ahead of GMT by 9 hours. In this case, set Time Hour to 9 and Minute to 00.

• Checking the Standard Time

Using one of the methods below, check the standard time of the region where you are using the DLM4000.

- Check the Date, Time, Language, Regional Options on your PC.
- Check the standard time at the URL on the right.<http://www.worldtimeserver.com/>



- The DLM4000 does not support Daylight Savings Time. To set the Daylight Savings Time, reset the time difference from Greenwich Mean Time.
 - Date and time settings are backed up using the internal lithium battery. They are retained even if the power is turned off.
 - The DLM4000 has leap-year information.
-

Turning On or Off the Click Sound (Click Sound)

You can turn on or off the click sound that is generated when you operate the jog shuttle.

Language (Language)

Sets the language that is used in the setup menu and messages.

The available languages vary depending on the DLM4000 model that you are using.

Adjusting the Backlight (LCD)

You can turn off the LCD backlight or adjust the brightness.

Turning Off the Backlight (LCD Turn OFF)

You can turn off the backlight. When the backlight is off, you can turn the backlight back on by pressing any key.

Automatically Turning Off the Backlight (Auto OFF)

The backlight turns off automatically when there are no key operations for a given time period. The backlight turns back on when you press any key.

Adjusting the Brightness (Brightness)

You can adjust the brightness in the range of 1 (darkest) to 10 (brightest). You can prolong the backlight service life by decreasing the backlight brightness or by turning off the backlight when you do not need to view the screen.

Format Internal Memory (Storage Manager)

You can format the internal memory (Flash_Mem) of the DLM4000.



If you format the internal memory, all saved data is erased.

USB Keyboard Language (USBKeyboard)

Sets the USB keyboard language to English (ENG) or Japanese (JPN). The USB keyboard can be used to enter file names, comments, etc.

USB Communication (USB Function)

You can specify the communication features that are used when you connect the DLM4000 to a PC through USB.

USBTMC

You can use USB TMC (Test and Measurement Class) to control the DLM4000 from a PC.

To remotely control the DLM4000 using communication commands through the USB port, select USBTMC and then carry out the following procedure.

- Install YOKOGAWA USB driver (YKMUSB) on your PC.
- Do not use USB drivers (or software) supplied by other companies.

Mass Storage

You can access the DLM4000 from a Windows 7, Windows 8, Windows 8.1, or Windows 10 PC and read data from the DLM4000 internal memory.

- You cannot delete data or write data to the DLM4000 internal memory.
- You cannot format or defragment the DLM4000 internal memory.
- You cannot access the storage media connected to the USB ports of the DLM4000.
- You do not have to install a USB driver (YKMUSB) on your PC.
- If you operate the files from the DLM4000, the DLM4000 will temporarily disconnect the connection from the PC so that the screen displayed on the PC can be refreshed.



-
- For information about how to obtain the YOKOGAWA USB driver (YKMUSB), contact your nearest YOKOGAWA dealer. You can also access the YOKOGAWA USB driver (YKMUSB) download website and download the driver (<http://tmi.yokogawa.com/service-support/downloads/>).
 - On models with firmware version earlier than 2.00, the mass storage feature for Windows XP and Windows Vista PCs is different from that for Windows 7. On models with firmware version earlier than 2.00, if the DLM4000 is accessed from a Windows XP or Windows Vista PC, the files on the DLM4000 internal memory can be read, deleted, and saved.
-

Overview (Overview)

You can view the lists of DLM4000 information and settings.

System Information (System Overview)

You can view the DLM4000 model, memory size, and installed options.

Setup Information (Setup Information1, Setup Information2)

You can view a list of current settings.

Additional Option License (Option Installation)

On DLM4000s with firmware version 3.00 and later, you can add the following options after purchasing the DLM4000. Install the options after you have purchased the license keys for them.

Options That Can Be Added

/G2	User-defined computation
/G3	Power supply analysis
/G4	Power supply analysis (includes user-defined computation)
/F1	UART trigger & analysis
/F2	I ² C + SPI trigger & analysis
/F3	UART + I ² C + SPI trigger & analysis
/F4	CAN + LIN trigger & analysis
/F5	FlexRay trigger & analysis
/F6	CAN + LIN + FlexRay trigger & analysis
/F7	CAN + CAN FD + LIN trigger & analysis
/F8	CAN + CAN FD + LIN + FlexRay trigger & analysis
/F9	SENT trigger & analysis
/F10	PSI5 analysis
/F11	SENT + PSI5 trigger & analysis



The SUFFIX (suffix code) inscribed in the name plate on the DLM4000 case indicates the installed options at the time of factory shipment. After you add options through additional option licenses, check the options on the DLM4000 overview screen.

Preferences (Preference)

Trigger Output (Trigger Out)

Sets the output logic for the signal transmitted from the trigger output terminal.

Pos: Positive logic

Neg: Negative logic

Offset Cancel (Offset Cancel)

You can select whether to apply the offset that you specified for observing analog signals to the various measured values.

For details, see “[Offset \(Offset\)](#)” in chapter 1, “Vertical Axis (Analog Signal).”

Delay Cancel (Delay Cancel)

You can select whether to apply the specified trigger delay to time measurement values.

For details, see “[Trigger Delay \(DELAY\)](#)” in chapter 4, “Triggering.”

Font Size (Font Size)

You can set the size of text for displaying automated measurement values of waveform parameters and cursor measurements.

Small: Small font size

Large: Large font size

Default Values of Legacy Models (Legacy Mode)

You can reset the DLM4000 settings on the basis of the factory default settings of the DL7400. For details, see “[Returning to the Default Settings \(DEFAULT SETUP\)](#)” in this chapter.

Self-Test (Selftest)

You can test the keyboard and memory operations.

Test Type (Type)

You can perform the following tests.

Memory Test (Memory)

Tests whether or not the internal CPU board RAM and ROM are operating properly. If “Success” appears, they are operating properly. If “Fail” appears, an error occurred.

Key Board Test (KeyBoard)

Tests whether the front panel keys and knobs are operating correctly and whether the soft keyboard accepts input properly.

- The front panel keys are operating properly if the background color of the names of the keys that you press turns white or green.
- Knobs are operating properly if you turn them slowly, press them, or tilt them depending on the type of knob and the background color of the names or arrows changes to white or green.
- The soft keyboard is operating properly if you can enter the specified characters.

Printer Test (Printer)

Tests whether or not the optional built-in printer is operating properly. If the print density is correct, the built-in printer is operating properly. If an error occurs, the built-in printer does not print properly.



Accuracy is service test items. In normal circumstances, customers do not need to perform these tests.

Executing a Test (Test Exec)

The selected self-test starts.

If an Error Occurs during a Self-Test

If an error occurs even after you carry out the following procedure, contact your nearest YOKOGAWA dealer.

- Execute the self-test again several times.
- Check whether the media being tested is properly inserted.
- Check that the paper is set properly in the built-in printer and that paper is not jammed.

Appendix

Appendix 1 How to Calculate the Area of a Waveform

IntegTY+

Area under the positive parts: $S_1 + S_2$

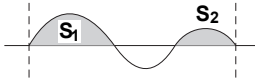

IntegTY

Area under the positive parts – area under the negative parts: $S_1 + S_3 - S_2$

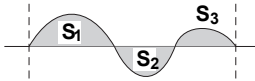

Integ for XY Display

Open

When Each Y Data Point Corresponds to a Single X Data Point

(1)

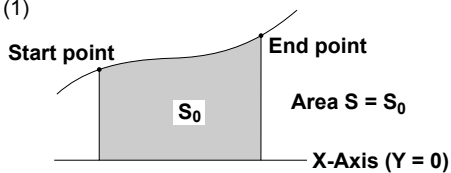

(3)

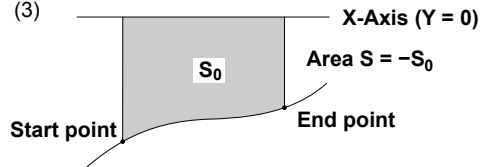

(2)

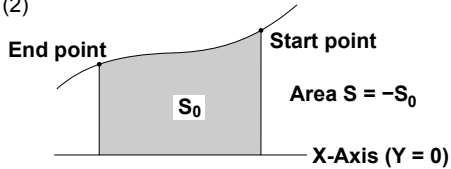

(4)

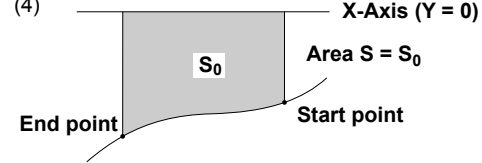

When the Waveform Extends into the Negative Side

Start point

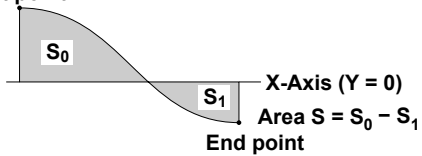

When Multiple Y Data Corresponds to X Data

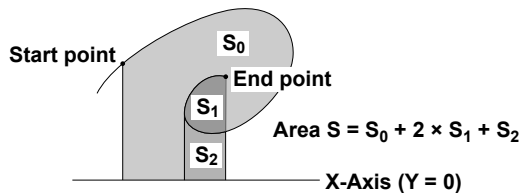
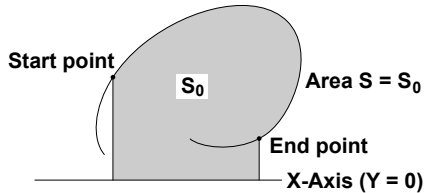

Close

Multiple Loops

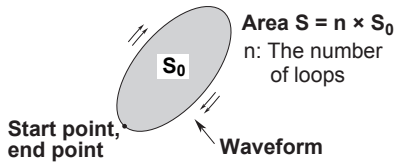

Non-Closed Curve

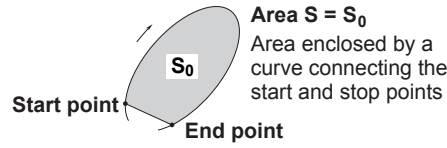

Loop Tracing a Figure-Eight

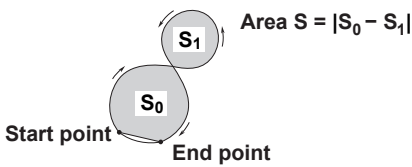

Loop Tracing a Spiral

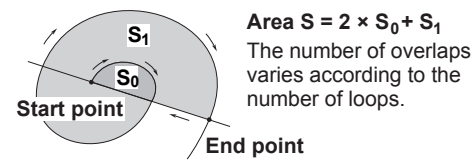

Appendix 2 User-Defined Computation, Option

Digital Filter

Type

Type	Bandwidth
FIR	Lowpass, highpass, or bandpass
IIR	Lowpass, highpass, or bandpass

Filter Order

See the following table for the filter orders.

Filter	Bandwidth	2%	5%	10%	20%	30% (Cutoff)
FIR	Lowpass	88	36	18	9	8
	Highpass	159	65	33	17	13
IIR	Lowpass	4	4	4	3	2
	Highpass	4	4	4	4	3

* The cutoff percentage is with respect to the sample rate.

Filter Response

Filter	Pass-band Ripple	Attenuation Slope	Attenuation at the Stop-band	Phase
FIR	± 0.3 dB	-40 dB at 1 oct (Lowpass), -40 dB at -1 oct (Highpass)	-40 dB -	Linear phase Linear phase
IIR	0 dB	-5 dB at 1/6 oct (Lowpass), -20 dB at -1 oct (Highpass)	- -	Non-linear phase Non-linear phase

Examples of Filter Frequency Response

f: Frequency (Hz)

FIR (low pass; 10% cutoff)

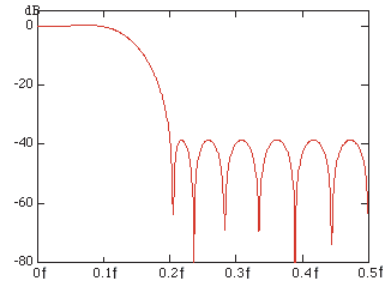

IIR (low pass; 10% cutoff)

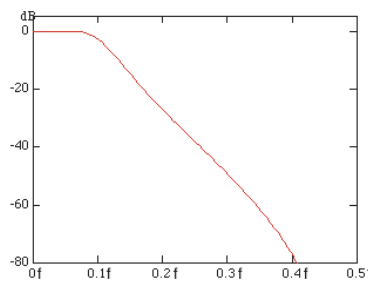

Computations take more time with higher filter orders.

Hilbert Function (HLBT)

Normally, when we analyze real-time signals, it is useful to think of these signals as the real part of functions of complex variables, and to carry out the actual signal analysis using such functions.

If the real-time signal is considered to be the real part of the function, the imaginary part can be determined with the Hilbert transform of the real part.

The Hilbert transform does not change the order of the individual variables. Hilbert transform of a time signal results in another time signal.

The Hilbert transform procedure is as follows.

When a time-domain signal is transformed, the signal is first transformed into the frequency domain through Fourier transform. Next, the phase of each frequency component is shifted by -90 degrees if the frequency is positive and $+90$ degrees if the frequency is negative. Lastly, taking the inverse Fourier transform completes the Hilbert transform.

Example

- The Hilbert transform can be used to analyze an envelope waveform.
 AM (amplitude modulation): $\text{SQRT}(C1 \times C1 + \text{HLBT}(C1) \times \text{HLBT}(C1))$
 Demodulation of an FM Signal: $\text{DIF}(\text{PH}(C1, \text{HLBT}(C1)))$

Phase Function (PH)

Phase function $\text{PH}(X1, Y1)$ computes $\tan^{-1}(X1/Y1)$.

The phase function takes the phase of the previous point into consideration and continues to sum even when the value exceeds $\pm\pi$ (the ATAN function reflects at $\pm\pi$).

The unit is radians.

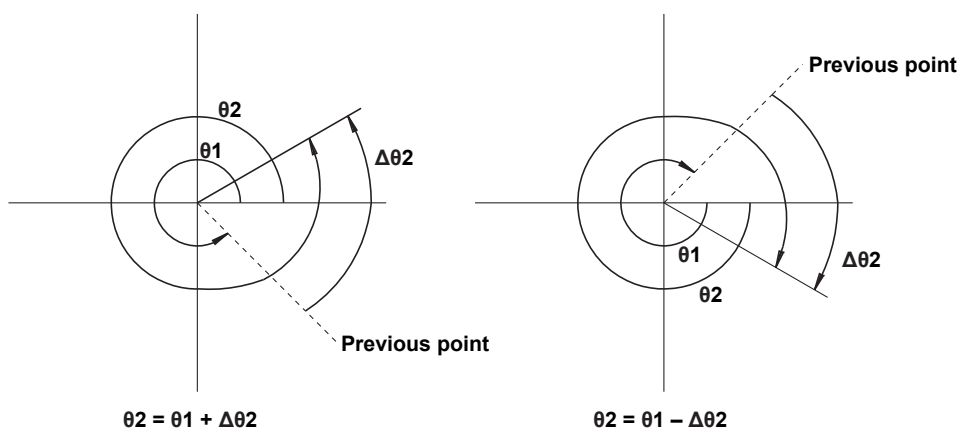

Differentiation and Integration

The computation of the differentiated value uses the 5th order Lagrange interpolation formula to derive a point of data from the five points of data before and after the target point.

The following equations use data f_0 to f_n with respect to sampling time x_0 to x_n . The derivative and integrated values corresponding to these data points are computed as follows:

Differentiation (DIFF)

$$\text{Point } x_k \quad f_k' = \frac{1}{12h} [f_{k-2} - 8f_{k-1} + 8f_{k+1} - f_{k+2}]$$

$h = \Delta x$ is the sampling interval (sec) (example: $h = 200 \times 10^{-6}$ at 5 kHz)

Integration (INTEG)

$$\text{Point } x_0 \quad I_0 = 0$$

$$\text{Point } x_1 \quad I_1 = \frac{1}{2} (f_0 + f_1)h$$

$$\text{Point } x_2 \quad I_2 = \frac{1}{2} (f_0 + f_1)h + \frac{1}{2} (f_1 + f_2)h = I_1 + \frac{1}{2} (f_1 + f_2)h$$

$$\text{Point } x_n \quad I_n = I_{n-1} + \frac{1}{2} (f_{n-1} + f_n)h$$

Binary Conversion(BIN)

Performs binary conversion using the specified threshold levels.

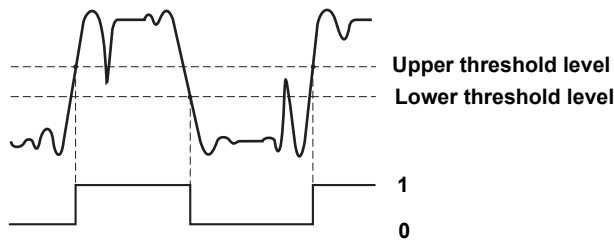

Pulse Width Computation

The signal is converted to binary values by comparing to the preset threshold level, and the time of the pulse width is plotted as the Y-axis value for that interval.

You can set the interval to one of the settings below.

- PWHH: From a rising edge to the next rising edge.
- PWHL: From a rising edge to the next falling edge.
- PWLH: From a falling edge to the next rising edge.
- PWLL: From a falling edge to the next falling edge.
- PWXX: From a rising or falling edge to the next rising or falling edge.
- FV: The inverse of PWHH.
- DUTYH: Duty ratio of the high side of each period of the specified waveform.
- DUTYL: Duty ratio of the low side of each period of the specified waveform.

Example 1, When the Interval Is Set to PWHH

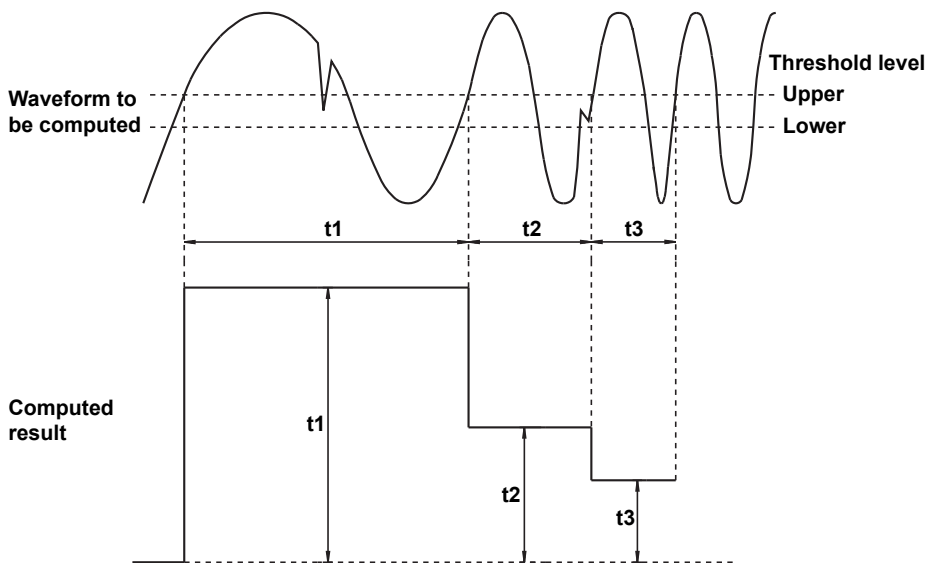

Example 2, When the Interval Is Set to DUTYH

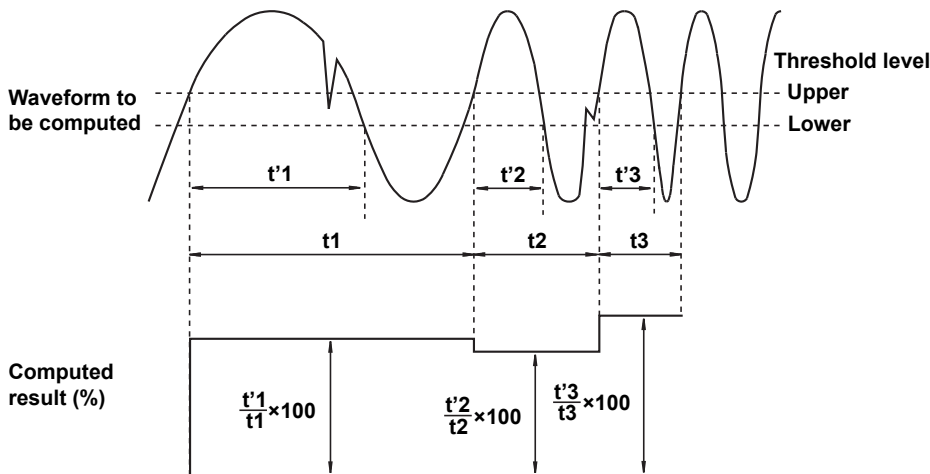

FFT Function - user-defined

Each frequency component G of a linear spectrum is represented by $G = R + jI$, where R is the real part and I is the imaginary part.

Linear Spectrum

The linear spectrum can be directly determined with the FFT. Through this spectrum, the magnitude and phase of each frequency component included in the measured waveform can be found. The power spectrum and cross spectrum can also be determined from one or two linear spectrums.

Because the FFT is a complex function, the linear spectrum produces the real part and imaginary part of the frequency components. The magnitude and phase of the linear spectrum can also be determined from this result.

The DLM4000 can determine the following spectrums.

Item	Equation	Computation
Real part	LS-REAL	R
Imaginary part	LS-IMAG	I
Magnitude	LS-MAG	$\sqrt{R^2 + I^2}$
Log magnitude	LS-LOGMAG	$20 \times \log\sqrt{R^2 + I^2}$
Phase	LS-PHASE	$\tan^{-1}(I/R)$

Log magnitude reference (0 dB): 1 Vpeak

Rms Value Spectrum

The rms value spectrum expresses the rms value of the magnitude of the linear spectrum. It does not contain phase information. The DLM4000 can determine the following spectrums.

Item	Equation	Computation
Magnitude	RS-MAG	$\sqrt{(R^2 + I^2)/2}$
Log magnitude	RS-LOGMAG	$20 \times \log\sqrt{(R^2 + I^2)/2}$

Log magnitude reference (0 dB): 1 Vrms

Power Spectrum

The power spectrum expresses the power (squared value) of each frequency component included in the measured signal. It is determined by taking the product of the linear spectrum and its complex conjugate. It does not contain phase information.

The DLM4000 can determine the following spectrums.

Item	Equation	Computation
Magnitude	PS-MAG	DC component $R^2 + I^2$
		AC component $(R^2 + I^2)/2$
Log magnitude	PS-LOGMAG	DC component $10 \times \log(R^2 + I^2)$
		AC component $10 \times \log\{(R^2 + I^2)/2\}$

Log magnitude reference (0 dB): 1 Vrms²

Power Spectrum Density

The power spectrum density expresses the power spectrum per unit frequency. It is determined by dividing the power spectrum by the frequency resolution Δf found during the analysis of the power spectrum. The computation varies depending on the window function.

Power spectrum density is used to compare power spectrums analyzed at different frequency bands. However, it is not necessary for signals having a line spectrum such as sine waves.

The DLM4000 can determine the following spectrums.

Item	Equation	Computation
Magnitude	PSD-MAG	$PS-MAG/\Delta f$: for Rectangular windows
		$PS-MAG/(1.5\Delta f)$: for Hanning windows
		$PS-MAG/(3.19693\Delta f)$: for Flattop windows
Log magnitude	PSD-LOGMAG	$10 \times \log PS-MAG/\Delta f$: for Rectangular windows
		$10 \times \log PS-MAG/(1.5\Delta f)$: for Hanning windows
		$10 \times \log PS-MAG/(3.19693\Delta f)$: for Flattop windows

Log magnitude reference (0 dB): 1 Vrms²

Cross Spectrum

The cross spectrum is determined from two signals. It is found by taking the product of the linear spectrum of one signal (G_y) and the complex conjugate (G_x^*) of the linear spectrum of the other signal (G_x).

If the linear spectrums of the two signals are represented by

$$G_x = R_x + jI_x$$

$$G_y = R_y + jI_y$$

then the cross spectrum G_{yx} is

$$G_{yx} = G_y \times G_x^* = (R_y + jI_y)(R_x - jI_x) = R_{yx} + jI_{yx}$$

$$\text{where } R_{yx} = R_y R_x + I_y I_x \text{ and } I_{yx} = R_x I_y - R_y I_x$$

The DLM4000 can determine the following spectrums.

Item	Equation	Computation	
Real part	CS-REAL	DC component	R_{yx}
		AC component	$R_{yx}/2$
Imaginary part	CS-IMAG	DC component	I_{yx}
		AC component	$I_{yx}/2$
Magnitude	CS-MAG	DC component	$\sqrt{(R_{yx}^2 + I_{yx}^2)}$
		AC component	$\sqrt{(R_{yx}^2 + I_{yx}^2)}/2$
Log magnitude	CS-LOGMAG	DC component	$10 \times \log \sqrt{(R_{yx}^2 + I_{yx}^2)}$
		AC component	$10 \times \log (\sqrt{(R_{yx}^2 + I_{yx}^2)}/2)$
Phase	CS-PHASE		$\tan^{-1}(I_{yx}/R_{yx})$

Transfer Function

The transfer function expresses the frequency response of the input to and the output from the transfer system.

The transfer function is determined by the ratio of the output linear spectrum (G_y) and the input spectrum (G_x) at each frequency. Also, as can be seen from the following equation, the transfer function can be defined as the ratio of the cross spectrum of the input and output (G_{yx}) and the input power spectrum (G_{xx}).

$$\text{Transfer function} = G_y/G_x = (G_y \times G_x^*)/(G_x \times G_x^*) = G_{yx}/G_{xx} = (R_{yx} + jI_{yx})/(R_x^2 + I_x^2)$$

The DLM4000 can determine the following items.

Item	Equation	Computation
Real part	TF-REAL	$R_{yx}/(R_x^2 + I_x^2)$
Imaginary part	TF-IMAG	$I_{yx}/(R_x^2 + I_x^2)$
Magnitude	TF-MAG	$\sqrt{(R_{yx}^2 + I_{yx}^2)}/(R_x^2 + I_x^2)$
Log magnitude	TF-LOGMAG	$20 \times \log \sqrt{(R_{yx}^2 + I_{yx}^2)}/(R_x^2 + I_x^2)$
Phase	TF-PHASE	$\tan^{-1}(I_{yx}/R_{yx})$

The magnitude of the transfer function shows the ratio of the magnitudes of the output linear spectrum and the input linear spectrum while the phase shows the phase difference of the two.

Coherence Function

The coherence function expresses the ratio of the output power generated by the input signal to the transfer system and the total output power.

$$\text{Coherence function} = G_{yx} \times G_{yx}^*/(G_{xx} \times G_{yy})$$

Item	Equation	Computation
Magnitude	CH-MAG	$(R_{yx}^2 + I_{yx}^2)/(G_{xx} \times G_{yy})$

If the output signal is due entirely to the input signal, the coherence function becomes 1. As the ratio decreases, it falls below 1. Thus, the coherence function always takes on a value between 0 and 1.



On one data acquisition, the coherence function becomes 1 across all frequencies. Make sure to take the frequency average of the computation.

Time Windows

You can select from rectangular, hanning, or flattop time windows.

The rectangular window is best suited to transient signals, such as impulse waves, which attenuate completely within the time window. The hanning and flattop windows allow continuity of the signal by gradually attenuating the parts of the signal located near the ends of the time window down to the 0 level. Hence, they are best suited to continuous signals. The hanning window provides a higher frequency resolution compared to the flattop window. However, the flattop window has a higher level of accuracy. When the waveform being analyzed is a continuous signal, consider the above characteristics in selecting the proper window to be applied.

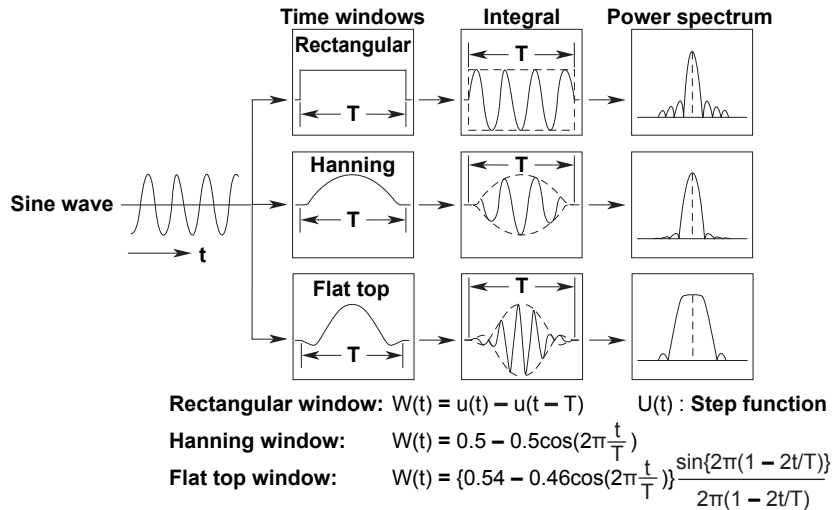

Notes When Executing the FFT Computation

Computation is normally performed on the sampled data in the acquisition memory. However, for waveforms that have been acquired in envelope mode, computation is performed on the maximum and minimum values per acquisition interval.

Appendix 3 ASCII Data File Format

The DLM4000 can save waveform data to ASCII files. The format of such files is given below.

	A	B	C	D	E
1	Header Size	15			
2	Model Name	DLM4000			
3	Comment				
4	BlockNumber	1	1	1	1
5	TraceName	CH1	CH2	CH3	CH4
6	BlockSize	12500	12500	12500	12500
7	VUnit	V	V	V	V
8	SampleRate	6250000	6250000	6250000	6250000
9	HResolution	1.60E-07	1.60E-07	1.60E-07	1.60E-07
10	HOffset	-1.00E-03	-1.00E-03	-1.00E-03	-1.00E-03
11	HUnit	s	s	s	s
12	DisplayBlockSize	12500	12500	12500	12500
13	DisplayPointNo.	1	1	1	1
14	Date	2008/9/25	2008/9/25	2008/9/25	2008/9/25
15	Time	20:52.3	20:52.3	20:52.3	20:52.3
16					
17	Data	6.30E-02	-1.00E-01	1.00E-01	1.00E-01
18		7.70E-02	-1.00E-01	1.00E-01	-2.00E-01
19		8.70E-02	0.00E+00	1.00E-01	1.00E-01
20		9.10E-02	-4.00E-01	2.00E-01	0.00E+00
21		9.40E-02	-2.00E-01	0.00E+00	-2.00E-01
22		9.60E-02	0.00E+00	1.00E-01	0.00E+00
23		9.70E-02	2.00E-01	1.00E-01	1.00E-01

Header Size	The number of header lines.
Model Name	Name of the instrument (DLM4000).
Comment	Comment attached at the time the data file was saved.
BlockNumber	Block number for this group. When the block numbers vary depending on the waveform, this is the maximum block number.
TraceName	Name of each waveform.
BlockSize	The number of data points in one block for each waveform.
VUnit	Each waveform's Y-axis unit (this has no effect on the data).
Sample Rate	The sample rate at the time of waveform acquisition.
HResolution	Each waveform's X-axis conversion coefficient, HResolution. $X\text{-axis value} = H\text{Resolution} \times (\text{Data No.} - 1) + H\text{Offset}$
HOffset	Each waveform's X-axis conversion coefficient, HOffset. $X\text{-axis value} = H\text{Resolution} \times (\text{Data No.} - 1) + H\text{Offset}$
HUnit	Each waveform's X-axis unit (this has no effect on the data).
DisplayBlockSize	The length of the data displayed on the screen (the display record length).
DisplayPointNo.	This number shows what point in memory is displayed on the left-most side of the display record length.
Date	Date when waveform acquisition completed.
Time	Time when waveform acquisition completed.

Appendix 4 TCP and UDP Port Numbers

The TCP and UDP port numbers that are used on the Ethernet interface of the DLM4000 are listed below.

TCP Port Numbers

Port Number	Description	Used For
20	File Transfer [Default Data]	FTP server, FTP client*
21	File Transfer [Control]	FTP server, FTP client
25	Simple Mail Transfer Protocol	SMTP client
80	World Wide Web HTTP	Web server
515	-	LPR client
111	-	-
1024	-	Instrument control through the Ethernet interface
1025	-	-

UDP Port Numbers

Port Number	Description	Used For
67	Bootstrap Protocol Server	DHCP client
68	Bootstrap Protocol Client	(listen port)
111	-	Instrument control through the Ethernet interface
123	Network Time Protocol	SNTP client

- * The port number when FTP passive mode is disabled. When FTP passive mode is enabled, you can set any port number. When FTP passive mode is disabled, connections are established from the server. If you are connecting the DLM4000 from behind a firewall, enable FTP passive mode.

Appendix 5 How Power Measurement Items Are Determined

The power measurement feature is available on models with the /G3 or /G4 option. The following table shows how the power measurement items are determined or the equations that are used.

Measurement Item	Methods of Determination and Equation					
	U+pk		U-pk		U-p-p	
Voltage U [V] Maximum U+pk Minimum U-pk Amplitude U-p-p True rms value Urms DC component Udc AC component Uac Rectified mean value calibrated to the rms value Umn Rectified mean value Urmn	Maximum (same as waveform parameter "Max")		Minimum (same as waveform parameter "Min")		Amplitude (same as waveform parameter "P-P")	
						Urms
	$\sqrt{\frac{1}{T} \int_0^T u(t)^2 dt}$		$\frac{1}{T} \int_0^T u(t) dt$	$\sqrt{U_{rms}^2 - U_{dc}^2}$	$\frac{\pi}{2\sqrt{2}} \frac{1}{T} \int_0^T u(t) dt$	$\frac{1}{T} \int_0^T u(t) dt$
Current I [A] Maximum I+pk Minimum I-pk Amplitude I-p-p True rms value Irms DC component Idc AC component Iac Rectified mean value calibrated to the rms value Imn Rectified mean value Irmn	Maximum (same as waveform parameter "Max")		Minimum (same as waveform parameter "Min")		Amplitude (same as waveform parameter "P-P")	
						Irms
	$\sqrt{\frac{1}{T} \int_0^T i(t)^2 dt}$		$\frac{1}{T} \int_0^T i(t) dt$	$\sqrt{I_{rms}^2 - I_{dc}^2}$	$\frac{\pi}{2\sqrt{2}} \frac{1}{T} \int_0^T i(t) dt$	$\frac{1}{T} \int_0^T i(t) dt$
Apparent power S [VA]	Urms • Irms					
Active power P [W]	$\frac{1}{T} \int_0^T u(t) \cdot i(t) dt$ u(t) • i(t): instantaneous power					
Reactive power Q [var]	$\sqrt{S^2 - P^2}$					
Load circuit impedance Z [W]	$\frac{U_{rms}}{I_{rms}}$					
Power factor λ	$\frac{P}{S}$					
Watt-hours [Wh] Wp Wp+ Wp- Abs.Wp	$\int_0^T u(t) \cdot i(t) dt$ Wp is the sum of positive and negative watt-hours. Wp+ is the sum of positive P (consumed watt-hours). Wp- is the sum of negative P (watt-hours returned to the power supply). Abs.Wp is the sum of Wp+ and Wp- (the sum of absolute watt-hours).					
	Ampere-hours [Ah] q+ q- Abs.q	$\int_0^T i(t) dt$ q is the sum of positive and negative Idc (ampere-hours). q+ is the sum of positive Idc (ampere-hours). q- is the sum of negative Idc (ampere-hours). Abs.q is the sum of q+ and q- (the sum of absolute ampere-hours).				
Average frequency Avg Freq [Hz]	Average frequency (same as waveform parameter "Avg Freq")					

T: measurement time period, u(t): sampled voltage data, i(t): sampled current data



For switching loss analysis, a cycle mode [▶ See here](#). feature is available. The measurement time period varies depending on whether cycle mode is ON or OFF. [▶ See here](#).

Appendix 6 Trigger and Detected Points of SENT Signals

The following table shows the trigger and detected points of SENT signals.

Trigger/search type	Trigger/detected point				
	Normal, with SYNC/CAL error, with S&C error	Nibble Number with error	NDV in S&C with error	NDV in DataNDV with error	NDV in CRC with error
Every Fast CH	End of S&C of the relevant frame				
Fast CH S&C	End of S&C of the relevant frame		Not triggered or searched	End of S&C of the relevant frame	
Fast CH Data	End of the last piece of data of the relevant frame			Not triggered when there is an NDV error in the data being compared	End of the last piece of data of the relevant frame
Every Slow CH	End of S&C of the last fast channel of the relevant slow channel				
Slow CH ID/Data					
Successive CAL Pulses (Preferred Option)	Trigger point: End of S&C of the succeeding frame Detected point: End of S&C of the relevant frame				
Successive CAL Pulses (Option 2)	End of S&C of the relevant frame				
Error Nibble Number	Trigger point: End of S&C of the succeeding frame Detected point: End of S&C of the relevant frame				
Nibble Data Value (NDV)	End of the relevant nibble				
Fast CH CRC	End of the relevant CRC				
Status and Communication (S&C)	End of the relevant S&C		Not triggered or searched	End of the relevant S&C	
Slow CH CRC	End of S&C of the last fast channel of the relevant slow channel				

For the figure of the SENT signal frame format, see the explanation of SENT trigger.

▶ [See here.](#)

Appendix 7 Auto Setup Trigger Range in CXPI Bus Analysis

The serial bus auto setup feature automatically configures the bit rate, level, and hysteresis for the specified source and executes bus analysis or triggers on the start of frame (SOF).

Because the CXPI trigger feature uses the user-defined serial bus trigger feature, there is a limit to the low width range of the source's logic values 1 and 0.

The following figure shows the low width range of the CXPI bus signal's logical value 1 and 0 that cause triggers. The range shown within the thick frame is where triggers occur.



If triggers no longer occur as a result of the low width changing due to the effects of the measurement environment, execute auto setup again.

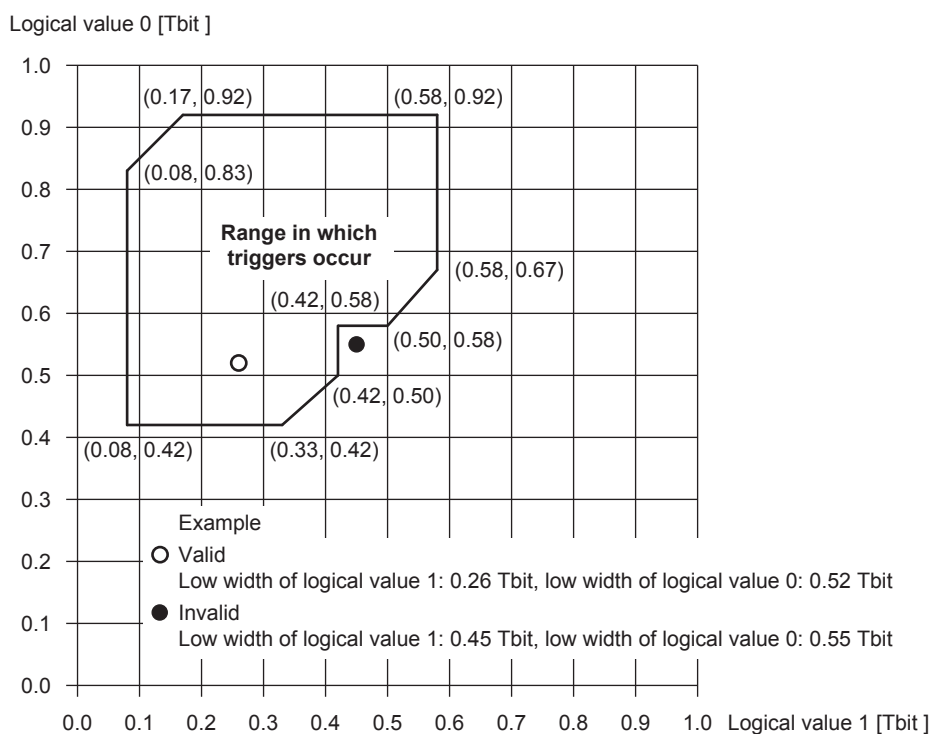

Appendix 8 Firmware Versions and New Features

This manual covers firmware versions 5.00 or later of the DLM4000. The following table contains new features that are available for each firmware version. If you are using an older version, you will not be able to use all the features described in this manual. To view the firmware version, press UTILITY and then the Overview soft key and check Firm Version on the Overview screen that is displayed.

Version	Suffix Code	New Features
2.00 and later	Standard	The number of serial buses that can be analyzed and searched simultaneously has been increased from two to four. The USB mass storage (Mass Storage) feature has been limited to only reading data even when the PC is running Windows XP or Windows Vista.
	/G4	A power measurement feature has been added to the power supply analysis feature.
	/L16	The /L16 option for 16-bit logic input has been added.
3.00 and later	Normal	Highlighting of history waveforms has been improved. Simple mode has been added to history search. Waveform data save menu has been improved. Additional option licenses
	/M3	Memory expansion to 25M/125M/250M points
	/G3	Power supply analysis
	/F1 or /F3	The UART data pattern can now be entered using ASCII codes.
	/F2 or /F3	Start Condition and Stop Condition have been added to I ² C decode display.
3.70 and later	/F7	CAN + CAN FD +LIN trigger & analysis
	/F8	CAN + CAN FD + LIN + FlexRay trigger & analysis
	/F9	SENT trigger and analysis. One trend can be set for each analysis.
4.03 and later	Normal	An option for triggering on either the rising or falling slope has been added to the Edge OR trigger pattern. An "All" item for setting all channels as trigger sources at once has been added to the Pattern menu of Edge OR trigger.. A function for including setting information in screen captures when screen captures are saved has been added.
	/F7 or /F8	A function compatible to ISO 11898-1: 2015 has been added to CAN FD.
	/F10	PSI5 analysis
	/F11	SENT+PSI5 trigger and analysis
4.60 and later	/F9, /F10, /F11	Serial bus trend color can now be selected.
	/F11	Up to four serial bus trends can be set for each analysis.
	/F4, /F6, /F7, /F8	CXPI bus analysis/search feature was added to the previous /F4, /F6, /F7, and /F8 options.

Index

Symbols

	Page
ΔT & ΔV cursors	11-3
ΔT cursor	11-2
ΔV cursor	11-3
λ	17-10

Numerics

	Page
3 wire	4-56
4 wire	4-56

A

	Page
A->B(N) trigger	4-65
accumulate	7-4
accumulation time	7-4
ACK mode	4-26
ACQ count	6-3
acquisition mode	6-2
action-on-trigger	5-2
action count	5-2
action mode	5-1
active (SPI)	4-57
active (user define)	4-59
active power	17-15
addition, subtraction, or multiplication	9-2
additional option	22-9
address (I2C)	4-52
A delay B trigger	4-65
adr data (I2C)	4-52
ampere-hours	17-16
analysis and search feature on or off	15-1
analysis result saving (serial bus)	15-4
analysis source waveform (FFT)	10-1
analyzing and searching (CAN)	15-7
analyzing and searching (CAN FD)	15-9
analyzing and searching (CXPI)	15-15
analyzing and searching (FlexRay)	15-5
analyzing and searching (I2C)	15-38
analyzing and searching (LIN)	15-12
analyzing and searching (PSI5)	15-28
analyzing and searching (SENT)	15-24
analyzing and searching (SPI)	15-40
analyzing and searching (UART)	15-35
analyzing and searching (user-define serial bus)	15-42
angle cursor	11-4
angle unit	11-4
apparent power	17-15
applicable class	17-9
area2	12-12
assignment	2-3, 2-4
A trigger	4-66
attach image file	21-5
attenuation	1-3
attenuation constant	6-3
attributes (file)	20-17
auto calibration	22-3
auto level mode	4-1
automated measurement of waveform parameters	12-2
automated measurement on or off	12-1
automatic zero adjustment on a current probe	1-4
auto mode	4-1
auto scale exec (trend display)	12-10
auto scaling	9-5

auto scroll (zoom)	13-2
auto setup	4-18, 22-1
auto setup (CAN)	15-7
auto setup (CAN FD)	15-9
auto setup (CXPI)	15-16
auto setup (FlexRay)	15-5
auto setup (I2C)	15-38
auto setup (LIN)	15-12
auto setup (PSI5)	15-29
auto setup (SENT)	15-24
auto setup (serial bus)	15-2
auto setup (SPI)	15-40
auto setup (UART)	15-36
average (history)	18-1, 18-2
average count	6-3
averaging mode	6-2

B

	Page
background transparent	19-4
backlight	22-7
bandwidth	1-5
bar graph display	17-10
BIN	App-4
binary conversion	App-4
bit and bus display order	2-5
bit assignments	2-3
bit order (SPI)	4-57
bit order (UART)	4-50
bit pattern (CAN)	4-25
bit pattern (LIN)	4-38
bit pattern (SENT)	4-42
bit rate (CAN)	4-28
bit rate (CAN FD)	4-34
bit rate (FlexRay)	4-22
bit rate (LIN)	4-40
bit rate (PSI5)	4-48
bit rate (UART)	4-50
bit setup	2-1
BJT/IGBT	17-4
break length	4-37
break synch	4-37, 4-38
broadcasting system	4-61
B trigger	4-66
B TRIG key	4-65
bus bit assignments	2-3
bus channel	4-22, 15-5
bus display	2-3
bus setup (CAN)	15-7
bus setup (CAN FD)	15-9
bus setup (CXPI)	15-15
bus setup (FlexRay)	15-5
bus setup (I2C)	15-38
bus setup (LIN)	15-12
bus setup (PSI5)	15-28
bus setup (SENT)	15-24
bus setup (serial bus)	15-2
bus setup (SPI)	15-40
bus setup (UART)	15-35
bus setup (user define)	15-42
bus type	15-2
buzzer	5-1
byte order	4-26
byte space	15-36

Index

C	Page
calc setup	12-12
calibration	22-3
CAN bus signal, analyzing and searching	15-7
CAN bus trigger	4-24
CAN FD bus signal, analyzing and searching	15-9
CAN FD bus trigger	4-31
CAN FD Standard	4-31, 15-9
center	9-5
change the base waveform	5-4
change the storage media	20-17
chip select signal (user define)	4-59
clear trace	22-3
click sound	22-7
Clock(CXPI)	15-17
clock on/off (user define)	4-59
clock tick	4-41
coherence function	App-7
collector-emitter saturation voltage	17-4
Color	7-2
color	7-2, 7-4
combination of signal states	4-9
combine trigger A and B	4-65
communication interface	22-4
comparison condition (CAN)	4-25
comparison condition (PSI5)	4-47
comparison condition (SENT_Fast CH Data)	4-42
comparison condition (SENT_Slow CH ID/Data)	4-43
comparison range	4-26
comparison start position (I2C)	4-52
comparison start position (SPI)	4-57
computation mode	9-1
computation on history waveforms	9-9
computation source waveform	9-1
confirming the waveform zone	5-5
continuous	12-7
copy (file)	20-17
count(S1)	9-4
Counter(CXPI)	15-17
count type	9-4
CRC (CAN)	4-24
CRC (CAN FD)	4-31
CRC(CXPI)	15-17
create folder	20-17
cross spectrum	App-7
CS (SPI)	4-57
current (rms)	17-16
cursor jumping	11-5
cursor measurement	11-1
cursor measurement (trend display)	12-11
cursor measurement (XY)	8-2
cursor movement	11-5
cursor type (FFT)	10-4
cutoff frequency	9-3
CXPI bus signal, analyzing and searching	15-15
cycle	12-8
cycle count (FlexRay)	4-20
cycle mode (automated measurement)	12-5
cycle mode (power supply analysis)	17-3
cycle trace	12-8
cyclic statistical processing	12-8
D	Page
Data (CAN)	4-25
Data (CAN FD)	4-32
Data(CXPI)	15-19
Data (I2C)	4-52
Data (LIN)	4-38
Data(PSI5)	4-48, 15-33
data (PSI5)	15-33
Data (UART)	4-49
Data1/Data2 (FlexRay)	4-20
Data1/Data2 (SPI)	4-56
data bit rate (CAN FD)	4-34
data format (UART)	4-50
Data Frame (CAN)	4-25
data frame (CAN)	4-29
Data Frame (CAN FD)	4-32
data frame (CAN FD)	4-35
data frame (PSI5)	4-48
Data Length(CXPI)	15-17
data pattern (CAN)	4-25
data pattern (CAN FD)	4-33
data pattern (CXPI)	15-19
data pattern (LIN)	4-38
data pattern (PSI5)	4-47
data pattern (SENT)	4-42
Data Type(SENT)	4-42
data type (SENT)	4-42
date and time	22-6
decoded display (CAN)	15-7
decoded display (CAN FD)	15-10
decoded display (CXPI)	15-16
decoded display (FlexRay)	15-5
decoded display (I2C)	15-38
decoded display (LIN)	15-12
decoded display (PSI5)	15-30
decoded display (SENT)	15-25
decoded display (serial bus)	15-3
decoded display (SPI)	15-41
decoded display (UART)	15-36
decoded display (user define)	15-42
default setting	22-2
definition	4-64
DELAY	4-7
delay	9-3
delay between waveforms	12-4
Delay Cancel	4-7
delay setup	12-4
delete file	20-17
DEMAG and Zero Cal	1-4
demagnetize	1-4
demagnetize and automatic zero adjustment	1-4
deskew	1-4
deskew (logic)	2-5
deskewing the transfer time difference	17-1
destination type	19-1
detailed list	15-4
detected point	14-7
detected point (serial bus)	15-3
detected point number	14-7
determine the high and low values	12-6
device	17-4
DHCP	21-2
DIFF	App-4
differentiation	App-4
digital filters	App-2
display (history)	18-1, 18-2
display area	8-2
display format	7-1
display format (zoom)	13-1
display interpolation	7-2
display order	2-5
displays the waveform	1-1
display the detected point	14-6
display the logic signal waveform	2-1

display the main window (zoom)	13-2
display VT waveform	8-1
display zoom window.....	13-1
distal/mesial/proximal	12-6
DLC	4-25
DNS	21-2
dual bus trigger.....	4-65

E	Page
EDGE	4-3
edge count.....	9-4
Edge OR trigger.....	4-8
edge qualified search	14-2, 14-4
Edge Qualified trigger.....	4-9
edge search.....	14-1, 14-3
enabled bit range.....	15-40
enable MSB/LSB	15-40
Endian	4-33, 15-20
endian.....	4-26
ENHANCED	4-2
enhanced (automated measurement)	12-12
enhanced parameter measurement	12-12
envelope mode.....	6-2
error (CAN).....	4-24
error (CAN FD).....	4-31
Error(CXPI).....	15-17
error (FlexRay)	4-19
error (LIN).....	4-37
Error(PSI5)	15-34
error (SENT).....	4-44
error (UART).....	4-49
error detection method	4-48, 15-28
Error Frame (CAN)	4-24
error frame (CAN).....	4-30
Error Frame (CAN FD)	4-31
error frame (CAN FD).....	4-36
error type (CXPI)	15-17
error type (LIN).....	15-14
error type (PSI5).....	15-34
error type (SENT)	4-44
ethernet interface.....	21-1
EUT's active power.....	17-9, 17-10
EUT's fundamental current.....	17-10
EUT's power supply voltage.....	17-9
every data (UART).....	4-49
Every Fast CH(SENT)	4-41
Every Slow CH(SENT)	4-43
every start (I2C).....	4-51
executing statistical processing.....	12-8
extended format (CAN).....	4-29
extended format (CAN FD).....	4-35
external trigger signal	4-3

F	Page
Fast CH Data(SENT).....	4-42
Fast CH S&C(SENT).....	4-41
FFT condition.....	10-2
FFT function	App-6
FFT on or off.....	10-1
FFT points	10-3
FFT window	7-1
field number.....	4-61
field size.....	15-40
file attributes	20-17
file operation.....	20-17
file properties.....	20-15, 20-17
filter order	9-3
filter type.....	9-2

fine grid display.....	7-3
Fixed Stuff (CAN FD).....	4-31
FlexRay bus trigger	4-19
format	2-3
format internal memory.....	22-7
Frame Format (CAN).....	4-24
Frame Format (CAN FD).....	4-32
Frame Information	15-18
Frame in Slot(PSI5).....	15-32
frame skip	4-62
frame start	4-19
Framing(CXPI).....	15-17
FTP server.....	21-3
fundamental frequency.....	17-8
fundamental wave	17-8
Fund Current	17-10

G	Page
general call	4-54
GO/NO-GO determination.....	5-2
GP-IB.....	22-4
gradation mode.....	7-4
graticule.....	7-3
grouping.....	15-35

H	Page
hard copy.....	19-2
harmonic analysis.....	17-8
harmonic component.....	17-8
harmonic grouping.....	17-10
harmonic order	17-8
harmonics.....	17-8
HF rejection	4-5, 4-64
highlighting (history)	18-2
high resolution mode.....	6-3
high speed CAN	4-30
Hilbert function.....	App-3
histogram frequency (waveform).....	16-1
histograms on or off (waveform).....	16-1
history	12-9
HLBT	App-3
holdoff.....	4-7
horizontal scale (FFT).....	10-4
horizontal sync frequency.....	4-64
HS mode.....	4-56

I	Page
I2C bus trigger	4-51
I2t.....	17-12
IBS(CXPI).....	15-17
ID (CAN).....	4-25
ID (CAN FD).....	4-32
ID(CXPI)	15-18
ID (LIN).....	4-38
ID/Data (CAN)	4-24
ID/Data (CAN FD).....	4-32
ID/Data(CXPI).....	15-18
ID/Data (FlexRay).....	4-19
ID/Data (LIN)	4-38
ID OR (CAN).....	4-27
ID OR (CAN FD).....	4-34
ID OR (FlexRay).....	4-22
ID OR (LIN).....	4-39
IIR filter	9-3
impedance	17-5, 17-15
indicate the measured location.....	12-5
indicator (FlexRay)	4-19

Index

indicator (measure).....	12-5, 17-16
Information.....	19-2, 19-4, 20-6
initial point.....	9-5
input coupling.....	1-3
INTEG.....	App-4
integ(S1).....	9-3
integ (XY).....	8-2
integration.....	9-3, App-4
intensity.....	7-2, 7-4
interharmonics.....	17-8
interleave mode.....	6-3
interpolation mode.....	6-4
inverted waveform display.....	1-4
ISO.....	4-31, 15-9

J

	Page
joule integral.....	17-12
joule integral (I2t) waveform display.....	17-13
jump to search point.....	12-9

L

	Page
label display.....	1-5
labels and units.....	9-5
language.....	22-7
latch source (user define).....	4-60
level setup.....	17-5
license.....	22-9
LIN bus trigger.....	4-37
linear interpolation.....	7-2
linear scale.....	1-4
line number.....	4-61
linking cursors.....	11-5
list (CAN).....	15-8
list (FlexRay).....	15-6
list (history).....	18-3
list (I2C).....	15-39
list (LIN).....	15-13
list (SPI).....	15-41
list (statistics).....	12-9
list (UART).....	15-37
list display (CAN FD).....	15-10
list display (CXPI).....	15-17
list display (harmonics).....	17-11
list display (PSI5).....	15-30
list display (SENT).....	15-25
list setup.....	15-4
list size.....	15-4
load data.....	20-15
load setup.....	20-16
load the reference waveform.....	9-1
load waveform.....	20-15
load waveform zone.....	20-16
logic signal's vertical display position.....	2-1
logic signal's vertical display range.....	2-1
long (print).....	19-2
loss calculation period.....	17-4
low speed CAN.....	4-30
LPR server.....	21-7

M

	Page
mail address.....	21-5
mail count.....	5-1
mail server.....	21-5
manuals.....	i
manual scaling.....	9-5
mapping.....	7-2

mark (search).....	14-6
marker cursor.....	11-3
marker cursor (FFT).....	10-4
marker display format.....	11-3
Math/Ref.....	9-1
max hold.....	10-3
maximum number of analyzable and searchable frames.....	15-1
maximum number of waveform acquisition.....	18-2
measurement location indicator.....	12-5
measurement source waveform (cursor).....	11-1
measurement time period.....	12-1
measure setup (FFT).....	10-4
measure setup (histogram display).....	12-11
measure setup (histogram of waveform).....	16-2
measure setup (XY).....	8-2
message and signal.....	4-27
MOSFET.....	17-4
MSB/LSB.....	4-26, 4-33, 15-20

N

	Page
network.....	22-5
network drive.....	21-6
network printer.....	21-7
nibble order.....	4-42, 15-24
nogo count.....	5-2
noise rejection.....	4-5
noise rejection (logic).....	2-2
non-ISO.....	4-31, 15-9
NON ACK.....	4-54
normal (print).....	19-2
normal mode.....	4-1, 6-2
normal statistical processing.....	12-7
notes about automated measurement.....	12-13
notes about cursor measurement.....	11-5
notes about go/no-go determination.....	5-6
notes about statistical processing.....	12-13
N single mode.....	4-1
number of action.....	5-2
number of slots (PSI5).....	15-29
number of waveform acquisitions.....	6-3

O

	Page
offset.....	1-5
offset-cancel.....	1-6
offset B.....	1-5
on-resistance.....	17-4
operator.....	9-2
Order(SENT).....	4-42, 15-24
Over 25 watts.....	17-9
overview.....	22-9

P

	Page
parameter (go/no-go).....	5-5
Parity(CXPI).....	15-17
Passive.....	21-6
passive mode.....	21-6
PC operations.....	21-4
peak cursor (FFT).....	10-5
PH.....	App-3
phase function.....	App-3
phase shifting.....	9-3
points to consider when configuring action-on-trigger.....	5-6
polarity.....	4-5
polarity (pulse width).....	4-13
polygonal zone.....	5-5
port numbers.....	App-10
POSITION knob (vertical).....	1-2, 2-1

POSITON (trigger position)	4-6
Power	17-10
power analysis1, power analysis2	17-1
power factor	17-10, 17-15
power source	4-4
power spectrum	App-6
power spectrum density	App-6
power supply analysis	17-1
power waveform display	17-6
preference	22-9
printer type (network)	19-3
print mode	19-2
print the screen image	5-1
probe attenuation	1-3, 4-5
probe setup	17-2
probe type	1-3
Probe Zero Cal	1-4
protection	20-17
PSI5, analyzing and searching	15-28
PSI5 Airbag signal, analyzing and searching	15-28
PSI5 Airbag Trigger	4-47
PTYPE(CXPI)	15-18
pulse interpolation	7-2
pulse width computation	App-5
pulse width search	14-2, 14-5
Pulse Width trigger	4-12

Q**Page**

qualification	4-9
---------------------	-----

R**Page**

R/W bit inclusion (I2C)	15-38
R/W bit inclusion (trigger)	4-53
ranging	9-5
RDS(on)	17-4
reactive power	17-15
real-time sampling mode	6-4
recessive level	4-28
record length	3-1, 6-1
rectangular zone	5-3
Ref	9-1
reference angle	11-4
reference condition	5-2
reference criterion	5-3
reference level	17-16
reference level (automated measurement)	12-6
reference levels	17-5
reference range type (go/no-go)	5-3
reference setup	11-4
reference times (pulse width)	4-13
reference values (a) (PSI5)	4-48
reference values (a, b) (CAN)	4-33
reference values (a, b) (CXPI)	15-19
reference values (a, b) (SENT_Fast CH Data)	4-42
reference values (a, b) (SENT_Slow CH ID/Data)	4-43, 4-44
reference values (a and b) (CAN)	4-25
reference values (a and b) (LIN)	4-39
Reference Waveform	9-1
rejection end (PSI5)	15-28
rejection mode (PSI5)	15-28
relationship between the time axis setting, record length, and sample rate	6-4
remote control	22-4
Remote Frame (CAN)	4-25
remote frame (CAN)	4-29
Remote Frame (CAN FD)	4-32
remote frame (CAN FD)	4-36
repetitive sampling mode	6-4

replay	18-4
resetting the offset	1-5
result window (search)	14-6
Reverse	2-3
revisions	ii
rms (voltage)	17-15
roll mode display	3-2
rotary count	9-4
RUN and STOP	6-5

S**Page**

safe operating area analysis	17-7
sample point (CAN)	4-28, 15-7
sample point (FlexRay)	15-5
sample point (LIN)	4-40, 15-12
sample point (UART)	4-50, 15-35
sample rate	3-1
sampling mode	6-4
save analysis result (serial bus)	20-8, 20-11
save automatically measured value	20-6
save data	20-2
save FFT result	20-7
save histogram	20-7
save mode	19-4
save screen capture	19-4
save screen image	20-5
save setup data	20-5
save snapshot waveform	20-6
save the screen image	5-1
save waveform data	20-2
save wavefrm	5-1
SCALE knob	1-1, 2-1
scale value display	7-3
scaling	9-5
scaling coefficient A	1-5
SCL	4-51
scroll speed	13-2
SDA	4-51
search (CXPI)	15-17
search (history)	18-1, 18-3
search (PSI5)	15-32
search condition	14-3
search mode (statistics)	12-9
search range	14-7
search setup (serial bus)	15-2
search skip	14-6
search source waveform	14-1
search type	14-1
second byte	4-54
self-test	22-10
send mail	5-1
sensitivity	9-5
SENT signal, analyzing and searching	15-24
SENT Trigger	4-41
serial bus trend color	7-2
Serial bus trigger	4-17
serial clock	4-51
serial data	4-51
setting information, including	19-4, 20-6
Show List	15-4
sign	4-26
sine interpolation	7-2
SINGLE	6-5
single mode	4-1
Size	4-32, 15-19
Sleep(CXPI)	15-20
slope	4-5
Slow CH ID/Data(SENT)	4-43

Index

Slow CH type (SENT).....	4-43, 4-44
smoothing.....	9-3
snapshot.....	22-2
SNTP server.....	21-7
SOA.....	17-7
SOF.....	4-24, 4-31
SOF(CXPI).....	15-17
sort.....	20-17
source waveform (analysis and search).....	15-2
source waveform (automated measurement).....	12-1
source waveform (go/no-go).....	5-3
spectrum type.....	10-2
speed.....	18-4
SPI bus trigger.....	4-56
standard format (CAN).....	4-29
standard format (CAN FD).....	4-35
start/end point.....	14-7
Start Bit(PSI5).....	15-32
start byte.....	4-55
start condition.....	4-52
state condition.....	4-11
State Condition (state width).....	4-15
state search.....	14-2, 14-4
State trigger.....	4-10
state width search.....	14-3, 14-5
State Width trigger.....	4-14
statistical processing mode.....	12-7
statistical processing of history waveforms.....	12-9
statistics.....	12-7
storage media.....	20-1
Stuff (CAN).....	4-24
Stuff (CAN FD).....	4-31
stuff error (CAN).....	4-30
stuff error (CAN FD).....	4-36
sub type.....	10-2
switching loss analysis.....	17-2
switching period.....	17-4
SW Loss.....	17-2
symbol data (load).....	20-16
Sync(PSI5).....	4-48, 15-32
sync guard frequency.....	4-64
sync noise rejection (PSI5).....	15-28
sync signal (PSI5).....	4-48
system configuration.....	22-6
System Voltage.....	17-9

T

Page

TCP/IP.....	21-2
TCP and UDP port numbers.....	App-10
test mail.....	21-5
threshold level (logic).....	2-2
threshold level (rotary count).....	9-4
TIME/DIV knob.....	3-1
time axis scale.....	3-1
time measurement items.....	12-3
timeout.....	21-5
time range (automated measurement).....	12-1
time range (FFT).....	10-3
timestamp.....	18-2
time width mode.....	4-13
time width mode (state width).....	4-16
time window.....	10-3
total loss.....	17-4
trademarks.....	i
T range1/T range2.....	12-1
transfer function.....	App-7
trend/histogram.....	12-10
trend/histogram window.....	7-1

trend display (PSI5).....	15-31
trend display (Trend).....	15-4
trigger A.....	4-66
trigger B.....	4-65, 4-66
trigger combination.....	4-65
trigger condition (edge qualified).....	4-9
trigger condition (state).....	4-11
trigger condition (state width).....	4-16
trigger coupling.....	4-5
trigger delay.....	4-7
trigger hold-off.....	4-7
trigger level.....	4-4
trigger mode.....	4-1
trigger mode (CAN).....	4-24
trigger mode (CAN FD).....	4-31
trigger mode (FlexRay).....	4-19
trigger mode (I2C).....	4-51
trigger mode (LIN).....	4-37
trigger mode (PSI5).....	4-47
trigger mode (SENT).....	4-41
trigger mode (UART).....	4-49
trigger output.....	22-9
trigger point (CAN).....	4-29
trigger point (CAN FD).....	4-35
trigger point (FlexRay).....	4-23
trigger point (LIN).....	4-40
trigger point (PSI5).....	4-48
trigger point (SENT).....	4-46
trigger point (SPI).....	4-58
trigger point (UART).....	4-50
trigger position.....	4-6
trigger slope.....	4-5
trigger source.....	4-3
trigger type.....	4-2
turning the display on and off.....	1-1
turning zoom linking on and off.....	15-4
TV trigger.....	4-61

U

Page

UART trigger.....	4-49
USB.....	22-4
USB communication.....	22-8
USB keyboard language.....	22-7
user-defined serial bus trigger.....	4-59
user-defined trigger.....	4-18

V

Page

V-Mag.....	13-3
V-position.....	13-3
Vce(SAT).....	17-4
vertical display position (logic).....	2-1
vertical display range (logic).....	2-1
vertical position.....	1-2
vertical position (reference waveform).....	9-2
vertical scale.....	1-1
vertical scale (FFT).....	10-4
vertical zoom.....	13-3
voltage (rms).....	17-15
voltage measurement items.....	12-2
VT display.....	8-1, 10-4
VT waveform display window.....	7-1

W

Page

Wakeup/Sleep(CXPI).....	15-20
watt-hours.....	17-15
waveform acquisition.....	6-5
waveform color.....	7-2

waveform display mode (FFT).....	10-3
waveform mapping	7-2
waveform vertical position	1-2
waveform zone	5-4
Web server	21-4
weighted point	9-3
window comparator	4-6
wiring system.....	4-56

X **Page**

X trace/Y trace.....	8-1
XY waveform display	8-1
XY window.....	7-1

Z **Page**

zero loss period	17-4
zone no.....	5-4
zoom factor.....	13-2
zoom link	13-3
zoom linking on and off (serial bus).....	15-4
zoom position	13-3
zoom position (search).....	14-6
zoom position (serial bus).....	15-3
zoom source waveform	13-2