

---

**User's  
Manual**

**DL850E/DL850EV  
ScopeCorder  
Getting Started Guide**

---

# Product Registration

Thank you for purchasing YOKOGAWA products.

YOKOGAWA provides registered users with a variety of information and services. Please allow us to serve you best by completing the product registration form accessible from our website.

**<http://tmi.yokogawa.com/>**

Thank you for purchasing the DL850E ScopeCorder or DL850EV ScopeCorder Vehicle Edition (hereinafter, "DL850E/DL850EV" will refer to both of these products).

This getting started guide primarily explains the handling precautions and basic operations of the DL850E/DL850EV. To ensure correct use, please read this manual thoroughly before operation. Keep this manual in a safe place for quick reference in the event that a question arises.

## List of Manuals

The following manuals, including this one, are provided as manuals for the DL850E/DL850EV. Please read all manuals.

| Manual Title   | Manual No.     | Description  |
|--|----------------|--|
| DL850E/DL850EV ScopeCorder Features Guide  | IM DL850E-01EN | The supplied CD contains the PDF file of this manual. The manual explains all the DL850E/DL850EV features other than the communication interface features. You can view the same information in the DL850E/DL850EV help files. |
| DL850E/DL850EV ScopeCorder User's Manual   | IM DL850E-02EN | The supplied CD contains the PDF file of this manual. The manual explains how to operate the DL850E/DL850EV.   |
| DL850E/DL850EV ScopeCorder Getting Started Guide   | IM DL850E-03EN | This guide. The guide explains the handling precautions and basic operations of the DL850E/DL850EV.  |
| DL850E/DL850EV ScopeCorder Communication Interface User's Manual   | IM DL850E-17EN | The supplied CD contains the PDF file of this manual. The manual explains the DL850E/DL850EV communication interface features and instructions on how to use them.   |
| DL850E/DL850EV ScopeCorder Real Time Math/Power Math User's Manual   | IM DL850E-51EN | The supplied CD contains the PDF file of this manual. The manual explains the features of the DL850E/DL850EV Real Time Math/Power Math option and how to use them.   |
| DL850E/DL850EV ScopeCorder Acquisition Software User's Manual  | IM DL850E-61EN | The supplied CD contains the PDF file of this manual. The manual explains all the features of the acquisition software, which records and displays data measured with the DL850E/DL850EV on a PC.                              |
| Model DL850E ScopeCorder, Model DL850EV ScopeCorder Vehicle Edition Radio Equipment Directive(RED) User's Manual | IM DL850E-04Z2 | Document for RE directive(for /C30 option).  |
| Precautions Concerning the Modules   | IM 701250-04E  | The manual explains the precautions concerning the modules. This manual is included if you ordered modules.  |
| Model DL850E ScopeCorder, Model DL850EV ScopeCorder Vehicle Edition, User's Manual                               | IM DL850E-92Z1 | Document for China   |

The "EN", "E", and "Z1" in the manual numbers are the language codes.

Refer to the "Optional Accessories (Sold Separately)" about the accessory's manual No..

Contact information of Yokogawa offices worldwide is provided on the following sheet.

| Document No. | Description                |
|--------------|----------------------------|
| PIM 113-01Z2 | List of worldwide contacts |

## Notes

- The contents of this manual are subject to change without prior notice as a result of continuing improvements to the instrument's performance and functions. The figures given in this manual may differ from those that actually appear on your screen.
- Every effort has been made in the preparation of this manual to ensure the accuracy of its contents. However, should you have any questions or find any errors, please contact your nearest YOKOGAWA dealer.
- Copying or reproducing all or any part of the contents of this manual without the permission of YOKOGAWA is strictly prohibited.
- The TCP/IP software of this product and the documents concerning it have been developed/created by YOKOGAWA based on the BSD Networking Software, Release 1 that has been licensed from the Regents of the University of California.

---

## Trademarks

- Microsoft, Internet Explorer, Windows, Windows 7, Windows 8, Windows 8.1, and Windows 10 are registered trademarks or trademarks of Microsoft Corporation in the United States and/or other countries.
- Adobe and Acrobat are either registered trademarks or trademarks of Adobe Systems Incorporated.
- PIEZOTRON is a registered Trademark of Kistler Instrumente AG.
- PCB and ICP are registered trademarks of PCB Group, Inc.
- Isotron is a registered trademark of Meggitt Group, PLC.
- VJE is a registered trademark of Yahoo Japan Corporation.
- MATLAB is a registered trademark of The MathWorks, Inc. in the United States.
- GIGAZoom ENGINE is a registered trademark of Yokogawa Electric Corporation.
- In this manual, the ® and TM symbols do not accompany their respective registered trademark or trademark names.
- Other company and product names are trademarks or registered trademarks of their respective holders.

## Revisions

- 1st Edition: December 2013
- 2nd Edition: July 2014
- 3rd Edition: March 2015
- 4th Edition: October 2015
- 5th Edition: February 2016
- 6th Edition: March 2016
- 7th Edition: July 2017
- 8th Edition: November 2017
- 9th Edition: April 2018
- 10th Edition: November 2018
- 11th Edition: July 2019



---

## Regarding the Conventional DL850 and DL850V

The DL850E/DL850EV manuals also cover how to use the conventional DL850/DL850V (firmware version 3.0 and later).

In the explanations, the model is indicated as DL850E/DL850EV, but if you are using the DL850/DL850V, read “DL850E” as “DL850” and “DL850EV” as “DL850V.” The following options are available only for the DL850E/DL850EV. They cannot be used with the DL850 or DL850V.

- Power math (/G5 option)
- GPS interface (/C30 option)

### **Note**

---

If modules that were released after the discontinuation of the DL850 and DL850V (December 31, 2013) are installed in the DL850 or DL850V, the compliance conditions of the standards that the DL850 and DL850V comply with will no longer be met. For details, see the Precautions Concerning the Modules (IM 701250-04E) included with the module.

---

# Checking the Contents of the Package

Unpack the box, and check the contents before operating the instrument. If the wrong items have been delivered, if items are missing, or if there is a problem with the appearance of the items, contact your nearest YOKOGAWA dealer.

## DL850E/DL850EV

Check that the product that you received is what you ordered by referring to the model name and suffix code given on the name plate on the left side panel.

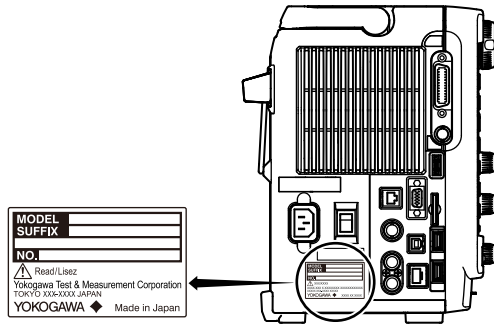

| MODEL                   | Suffix <sup>1</sup>              | Description   |
|-------------------------|----------------------------------|---|
| DL850E/DL850EV          |                                  | Main device, 8 slots, 250 Mpoint memory                     |
| Power cord <sup>2</sup> | -D                               | UL/CSA Standard power cord, Maximum rated voltage: 125 V    |
|                         | -F                               | VDE Standard power cord, Maximum rated voltage: 250 V       |
|                         | -Q                               | BS Standard power cord, Maximum rated voltage: 250 V        |
|                         | -R                               | AS Standard power cord, Maximum rated voltage: 250 V        |
|                         | -H                               | GB Standard power cord, Maximum rated voltage: 250 V        |
|                         | -N                               | NBR Standard power cord, Maximum rated voltage: 250 V       |
|                         | -T                               | Taiwanese Standard power cord, Maximum rated voltage: 125 V |
|                         | -B                               | Indian Standard power cord, Maximum rated voltage: 250 V    |
|                         | -U                               | IEC Plug Type B power cord, Maximum rated voltage: 250 V    |
|                         | -Y                               | No power cord included. <sup>3</sup>                        |
| Language                | -HJ                              | Japanese  |
|                         | -HE                              | English   |
|                         | -HC                              | Chinese   |
|                         | -HK                              | Korean  |
|                         | -HG                              | German  |
|                         | -HF                              | French  |
|                         | -HL                              | Italian   |
| Options                 | /B5                              | Built-in printer <sup>4</sup>                               |
|                         | /DC                              | 12 VDC Power (10 to 18 VDC) (DL850EV only) <sup>5</sup>     |
|                         | /M1                              | Memory expansion to 1 Gpoint <sup>6</sup>                   |
|                         | /M2                              | Memory expansion to 2 Gpoint <sup>6</sup>                   |
|                         | /HD0                             | External HDD interface <sup>7</sup>                         |
|                         | /HD1                             | 500 GB internal HDD <sup>7</sup>                            |
|                         | /C1                              | GP-IB interface <sup>8</sup>                                |
|                         | /C20                             | GP-IB interface + IRIG <sup>8</sup>                         |
|                         | /C30                             | GPS interface <sup>8</sup>                                  |
|                         | /G2                              | User-defined computation                                    |
| /G3                     | Real Time Math <sup>9</sup>      |   |
| /G5                     | Power math <sup>9</sup>          |   |
| /P4                     | Probe power supply, four outputs |   |

- 1 For products whose suffix code contains "Z," an exclusive manual may be included. Please read it along with the standard manual.
- 2 Make sure that the attached power cord meets the designated standards of the country and area that you are using it in.
- 3 Prepare a power cord that complies with the standard specified by the country or region that the instrument will be used in.
- 4 Includes one roll of paper (B9988AE)
- 5 The /DC option can only be installed on the DL850EV. The /DC and /B5 options cannot be installed on the same instrument.
- 6 The /M1 and /M2 options cannot be installed on the same instrument.
- 7 The /HD0 and /HD1 options cannot be installed on the same instrument.
- 8 The /C1, /C20, and /C30 options cannot be installed on the same instrument.
- 9 The /G3 and /G5 options cannot be installed on the same instrument.

## No. (Instrument Number)

When contacting the dealer from which you purchased the instrument, please give them the instrument number.

## Standard Accessories

The standard accessories below are supplied with the instrument. Check that all contents are present and undamaged.

| Item                            | Model or Part No. | Quantity | Specifications and Notes   |
|---------------------------------|-------------------|----------|--|
| Power cord <sup>1</sup>         | A1006WD           | 1        | UL, CSA, and PSE standard  |
|                                 | A1009WD           |          | VDE standard   |
|                                 | A1054WD           |          | BS standard  |
|                                 | A1024WD           |          | AS standard  |
|                                 | A1064WD           |          | GB standard  |
|                                 | A1088WD           |          | NBR standard   |
|                                 | A1100WD           |          | Taiwanese standard   |
|                                 | A1101WD           |          | Indian standard  |
|                                 | A1102WD           |          | IEC Plug Type B  |
| Front-panel protection cover    | B8074EA           | 1        | —  |
| Soft case                       | B8059GG           | 1        | —  |
| Printer roll paper <sup>2</sup> | B9988AE           | 1        | —  |
| Panel sheet                     | See below.        | 1        | Japanese, Chinese, Korean, German, French, Italian, or Spanish   |
| DC power connector <sup>3</sup> | B8023WZ           | 1        | —  |
| Cover panels                    | B8073CY           | 8        | —  |
| Rubber feet                     | B9989EX           | 1        | —  |
| GPS antenna <sup>4</sup>        | A1058ER           | 1        | —  |
| <b>Manuals</b>                  |                   |          |  |
| Printed manuals                 | IM DL850E-03EN    | 1        | Getting Started Guide (this guide)   |
|                                 | IM DL850E-04Z2    | 1        | Document for RE directive(for /C30 option).  |
|                                 | IM 701250-04E     | 1        | Precautions Concerning the Modules (This manual is included if you ordered modules.)   |
|                                 | IM DL850E-92Z1    | 1        | Document for China   |
|                                 | PIM 113-01Z2      | 1        | List of worldwide contacts   |
| Manual CD                       | B8074XT           | 1        | Contains PDFs of the user's manuals, Acquisition Software and USB driver (For the types of manuals that CD contains, see the next page.) |

Standard accessories are not covered by warranty of this instrument.

## Checking the Contents of the Package

Power cord (one cord that matches the suffix code is included)<sup>1</sup>

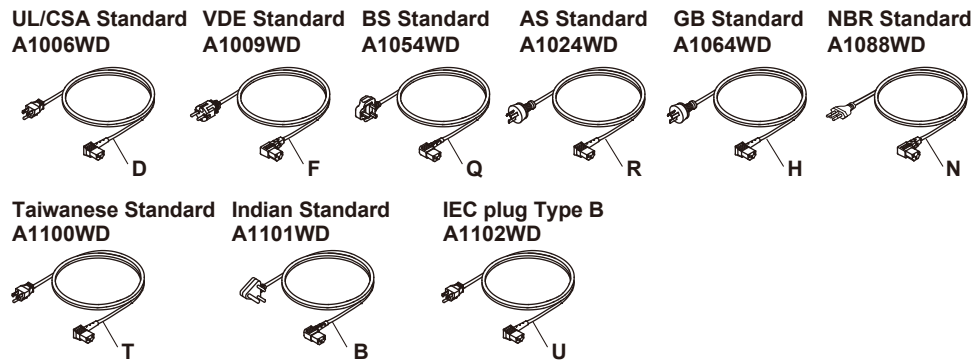

**Front-panel  
protection cover  
B8074EA**

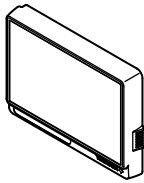

**Soft case  
B8059GG**

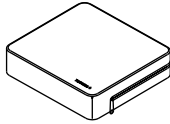

**Printer roll paper<sup>2</sup>  
B9988AE, 1 roll**



**DC power connector<sup>3</sup>  
B8023WZ**

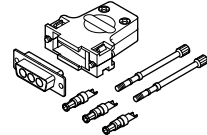

One of the following panel sheets:



**DL850E**  
 B8074GP (Japanese; -HJ)  
 B8074GQ (Chinese; -HC)  
 B8074GR (Korean; -HK)  
 B8074GS (German; -HG)  
 B8074GT (French; -HF)  
 B8074GV (Italian; -HL)  
 B8074GW (Spanish; -HS)

**DL850EV**  
 B8074HP (Japanese; -HJ)  
 B8074HQ (Chinese; -HC)  
 B8074HR (Korean; -HK)  
 B8074HS (German; -HG)  
 B8074HT (French; -HF)  
 B8074HV (Italian; -HL)  
 B8074HW (Spanish; -HS)

**Cover panels  
B8073CY,  
8 panels**

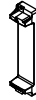

**Rubber feet  
B9989EX,  
1 sheet  
(4 feet)**



**GPS antenna<sup>4</sup>  
A1058ER**



**Manuals**

- Printed manuals
- Manual CD

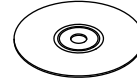
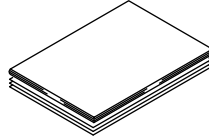

- 1 Make sure that the attached power cord meets the designated standards of the country and area that you are using it in. If the suffix code is -Y, a power cord is not included.
- 2 Only included with models that have a built-in printer (/B5)
- 3 Only included with DL850EVs that have the 12 VDC power supply (/DC option)
- 4 Only included with models that have a GPS interface (/C30)

## Manual CD

The English folder in the manual CD contains the PDF files shown below. The CD also contains Japanese manuals.

| File Name                         | Manual Title  | Manual No.     |
|-----------------------------------|---|----------------|
| Features Guide & Users Manual.pdf | DL850E/DL850EV ScopeCorder<br>Features Guide                          | IM DL850E-01EN |
|                                   | DL850E/DL850EV ScopeCorder<br>User's Manual                           | IM DL850E-02EN |
| Communication Interface.pdf       | DL850E/DL850EV ScopeCorder<br>Communication Interface User's Manual   | IM DL850E-17EN |
| Real Time Math & Power Math.pdf   | DL850E/DL850EV ScopeCorder<br>Real Time Math/Power Math User's Manual | IM DL850E-51EN |
| Acquisition Software.pdf          | DL850E/DL850EV ScopeCorder<br>Acquisition Software User's Manual      | IM DL850E-61EN |

To view the PDF data, you need Adobe Acrobat Reader or a software application that can open PDF data.

### WARNING

Never play this manual CD, which contains the user's manuals, in an audio CD player. Doing so may cause loss of hearing or speaker damage due to the large sounds that may be produced.

### French

### AVERTISSEMENT

Ce CD contient les manuels d'utilisation. Ne jamais insérer ce CD dans un lecteur de CD audio. Cela pourrait entraîner une perte d'audition ou l'endommagement des enceintes en raison du volume potentiellement élevé des sons produits.

## Input Modules (Sold Separately)

To make sure that an input module is the module that you ordered, check the module name written on it.

| MODEL  | Name   | Abbreviation   |
|--------|--|----------------|
| 701250 | High-Speed 10 MS/s, 12-Bit Isolation Module                      | HS10M12        |
| 720250 | High-Speed 10 MS/s, 12-Bit Isolation Module                      | HS10M12        |
| 701251 | High-Speed High-Resolution 1 MS/s, 16-Bit Isolation Module       | HS1M16         |
| 701255 | High-Speed 10 MS/s, 12-Bit Non-Isolation Module                  | NONISO_10M12   |
| 701267 | High-Voltage 100 kS/s, 16-Bit Isolation Module (with RMS)        | HV (with RMS)  |
| 720268 | High-Voltage 1 MS/s, 16-Bit Isolation Module (with AAF and RMS)  | HV (AAF, RMS)  |
| 701261 | Universal (Voltage/Temp.) Module                                 | UNIVERSAL      |
| 701262 | Universal (Voltage/Temp.) Module (with AAF)                      | UNIVERSAL(AAF) |
| 701265 | Temperature, High Precision Voltage Isolation Module             | TEMP/HPV       |
| 720266 | Temperature, High Precision Voltage Isolation Module (low noise) | TEMP/HPV       |
| 701270 | Strain Module (NDIS)   | STRAIN_NDIS    |
| 701271 | Strain Module (DSUB, Shunt-Cal)                                  | STRAIN_DSUB    |
| 701275 | Acceleration/Voltage Module (with AAF)                           | ACCL/VOLT      |
| 701281 | Frequency Module   | FREQ           |
| 720281 | Frequency Module   | FREQ           |
| 720210 | High-Speed 100 MS/s, 12-Bit Isolation Module                     | HS100M12       |
| 720211 | High-Speed 100 MS/s, 12-Bit Isolation Module                     | HS100M12       |
| 720220 | 16-CH Voltage Input Module                                       | 16CH VOLT      |
| 720221 | 16-CH Temperature/Voltage Input Module                           | 16CH TEMP/VOLT |
| 720230 | Logic Input Module   | LOGIC          |
| 720240 | CAN Bus Monitor Module*  | CAN MONITOR    |
| 720241 | CAN & LIN Bus Monitor Module*                                    | CAN & LIN      |
| 720242 | CAN/CAN FD Monitor Module*                                       | CAN/CAN FD     |
| 720243 | SENT Monitor Module*   | SENT           |
| 720254 | 4-CH 1 MS/s, 16-Bit Isolation Module                             | 4CH 1M16       |

\* The CAN bus monitor, CAN&LIN bus monitor, CAN/CAN FD monitor and SENT monitor modules can be used on the DL850EV. They cannot be used on the DL850E.

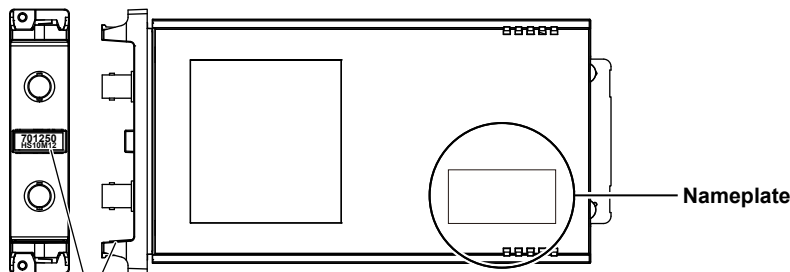

**Top line: Model**  
**Bottom line: Abbreviation**  
**The location varies depending on the module.**

In this manual, input modules are referred to by their model names and abbreviations. For example, the High-Speed 10 MS/s, 12-Bit Isolation Module is referred to as the 701250 (HS10M12). However, if a module has already been referred to previously, it may be referred to only by its model name (for example, 701250).

### Note

To use the DL850E/DL850EV with 701250 and 701255 modules shipped between August 2006 and June 2007, you must update the module firmware. If error code 916 appears when you turn on the DL850E/DL850EV, it may be necessary to update the firmware of the aforementioned modules. Prepare the module serial numbers, and contact your nearest YOKOGAWA dealer. The dealer will update the module firmware for a fee.

## Optional Accessories (Sold Separately)

The optional accessories below are available for purchase separately. Check that all contents are present and undamaged.

- Use the accessories specified in this manual. Moreover, use the accessories of this product only with Yokogawa products that specify them as accessories.
- Use the accessories of this product within the rated range of each accessory. When using several accessories together, use them within the specification range of the accessory with the lowest rating.











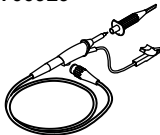
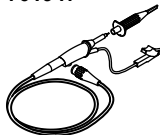
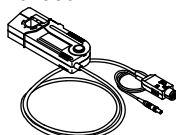
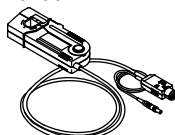

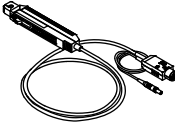
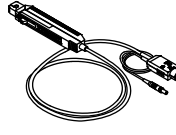
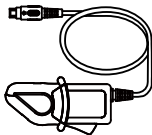
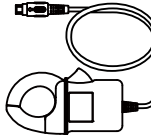
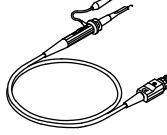
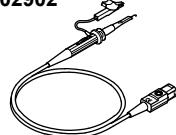
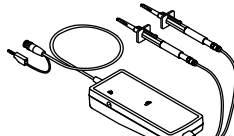
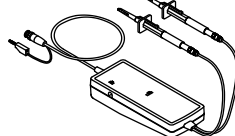
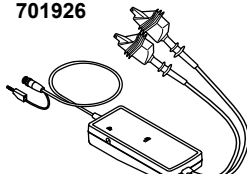
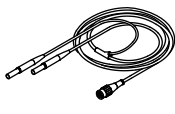
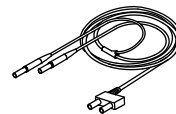
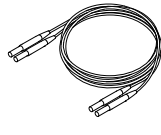

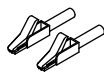
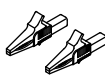
| Name                          | Model   | Safety standard                      | Note   | Manual No.     |
|-------------------------------|---------|--------------------------------------|--|----------------|
| Isolated probe                | 700929  | 1000 Vrms CAT II                     | 10:1 safety probe for the 701250, 720250, 701251, 701281, 720281, 720210, 720211, and 720254   | IM 700929-01E  |
|                               | 701947  | 1000 Vrms CAT II                     | 100:1 safety probe for the 701250, 720250, 701251, 720210, 720211, and 720254  | IM 701947-01E  |
| Current probe                 | 701930  | 300 Vrms CAT III                     | 150 Arms, DC to 10 MHz. Used by connecting to a probe power terminal (/P4 option) or a probe power supply (701934; sold separately).   | IM 701930-01E  |
|                               | 701931  | 300 Vrms CAT III                     | 500 Arms, DC to 2 MHz. Used by connecting to a probe power terminal (/P4 option) or a probe power supply (701934; sold separately).  | IM 701931-01E  |
|                               | 701932  | 300 Vrms                             | 30 Arms, DC to 100 MHz. Used by connecting to a probe power terminal (/P4 option) or a probe power supply (701934; sold separately).   | IM 701932-01E  |
|                               | 701933  | 300 Vrms                             | 30 Arms, DC to 50 MHz. Used by connecting to a probe power terminal (/P4 option) or a probe power supply (701934; sold separately).  | IM 701933-01E  |
|                               | 701917  | Vrms                                 | 5 Arms, DC to 50 MHz. Used by connecting to a probe power terminal (/P4 option) or a probe power supply (701934; sold separately).   | IM 701917-01EN |
|                               | 701918  | Vrms                                 | 5 Arms, DC to 120 MHz. Used by connecting to a probe power terminal (/P4 option) or a probe power supply (701934; sold separately).  | IM 701917-01EN |
| Clamp-on probe                | 720930  | 300 Vrms CAT III                     | AC 0 to 50 Arms, (10 mV/A)   | IM 720930-01EN |
|                               | 720931  | 600 Vrms CAT III                     | AC 0 to 200 Arms, (2.5 mV/A)   | IM 720930-01EN |
| 10:1 passive probe            | 701940  | —                                    | For non-isolated input on the 701255: 600 V or less<br>For isolated input other than above: 42 V or less   | IM 701940-01E  |
|                               | 702902  | 1000V (DC+ACpeak)<br>CAT II          | 10:1 safety probe, wide temperature range, for isolated BNC input, for the 701250, 720250, 701251, 720210, 720211, and 720254  | IM 702902-01EN |
| Differential probe            | 700924  | 1000 Vrms CAT III                    | Switchable between 1000:1 and 100:1<br>Measurable voltage: 1400 Vpeak (1000 Vrms)  | IM 700924-01E  |
|                               | 700925  | 1000V (DC+ACpeak)<br>CAT III         | Switchable between 100:1 and 10:1<br>Measurable voltage: 500 Vpeak (350 Vrms)  | IM 700925-01E  |
|                               | 701926  | 1000 Vrms CAT III                    | Switchable between 1000:1 and 100:1<br>Measurable voltage: 7000 Vpeak (5000 Vrms)  | IM 701926-01E  |
| 1:1 BNC safety adapter lead   | 701901  | 1000 Vrms CAT II                     | For use with the 701250, 720250, 701251, 720210, 720211, and 720254. Used with the following items (which are sold separately): the 701954, B9852MM, B9852MN, 758922, 758929, or 758921. | —              |
| 1:1 safety adapter lead       | 701904  | 1000 Vrms CAT II<br>600 Vrms CAT III | For use with the 701267 and 720268. Used with the following items (which are sold separately): the 701954, B9852MM, B9852MN, 758922, 758929, or 758921.                                  | —              |
| Measurement lead              | 758933  | 1000 Vrms CAT III                    | 1 m in length; for use with the 701267 or 720268. Used with the following items (which are sold separately): the 701954, B9852MM, B9852MN, 758922, 758929, or 758921.                    | —              |
| Alligator clip (dolphin type) | 701954  | 1000 Vrms CAT III                    | Two pieces in one set (red/black)  | —              |
| Safety mini-clip (hook type)  | B9852MM | 1000 Vrms CAT III                    | Black  | —              |
|                               | B9852MN | 1000 Vrms CAT III                    | Red  | —              |
| Alligator clip adapter        | 758922  | 300 Vrms CAT II                      | Two pieces in one set  | —              |
| Alligator clip adapter        | 758929  | 1000 Vrms CAT II                     | Two pieces in one set  | —              |

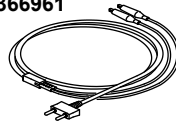
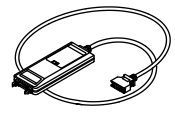
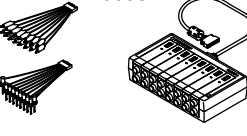
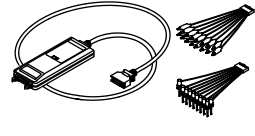
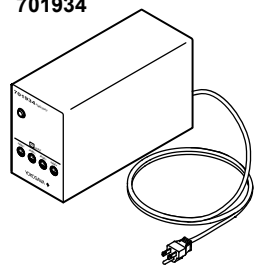
## Checking the Contents of the Package

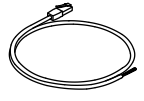
| Name  | Model   | Safety standard  | Note  | Manual No.    |
|---|---|------------------|---|---------------|
| Fork terminal adapter   | 758921  | 1000 Vrms CAT II | Two pieces in one set (red/black). For 4 mm screws.   | —             |
| Cable <sup>1</sup>  | 366926  | —                | For measuring low voltage of less than or equal to 42 V   | —             |
| Banana—alligator clip cable   | 366961  | —                | For measuring low voltage of less than or equal to 42 V for the 701261, 701262, 701265, or 720266 | —             |
| High-speed logic probe  | 700986  | —                | 42 V or less, 8 bits, non-isolated, response speed of 1 $\mu$ s                                   | —             |
| Isolated logic probe  | 700987  | 250 Vrms CAT II  | 8 bits, each channel isolated, response speed of 20 ms (for AC)                                   | IM 700987-01E |
| 1 m logic probe   | 702911  | —                | 8 bits, non-isolated  | —             |
| 3 m logic probe   | 702912  | —                | 8 bits, non-isolated  | —             |
| Isolated logic measurement lead   | 758917  | 1000 Vrms CAT II | Two pieces in one set. Used with the 758922 or 758929 adapter. The adapters are sold separately.  | —             |
| External I/O cable  | 720911  | —                | For external I/O  | —             |
| 1 m safety BNC cable  | 701902  | 1000 Vrms CAT II | —   | —             |
| 2 m safety BNC cable  | 701903  | 1000 Vrms CAT II | —   | —             |
| Safety BNC-to-banana adapter  | 758924  | 500 Vrms CAT II  | For the 701250, 720250, 701251, 701255, 720210, and 720211  | —             |
| Probe power supply  | 701934  | —                | High current output power supply for external probes (four outputs)                               | IM 701934-01E |
| Shunt resistor  | 438920  | —                | 250 $\Omega \pm 0.1\%$  | —             |
|   | 438921  | —                | 100 $\Omega \pm 0.1\%$  | —             |
|   | 438922  | —                | 10 $\Omega \pm 0.1\%$   | —             |
| 16-CH scanner box   | Accessory: Protection cover 1, Protection cover screw 1, Attaching plate 1, Binding screw 2 |                  |   |               |
|   | 701953-L1   | —                | For the 720221; cable length: 1 m   | —             |
|   | 701953-L3   | —                | For the 720221; cable length: 3 m   | —             |
| Cable   | 705926  | —                | 1 m in length; for connecting the 720221 and 701953   | —             |
|   | 705927  | —                | 3 m in length; for connecting the 720221 and 701953   | —             |
| Bridgehead  | 701955  | —                | NDIS, bridge resistance: 120 $\Omega$   | IM 701955-01E |
|   | 701956  | —                | NDIS, bridge resistance: 350 $\Omega$   | —             |
|   | 701957  | —                | DSUB, bridge resistance: 120 $\Omega$ , shunt-cal support   | IM 701957-01E |
|   | 701958  | —                | DSUB, bridge resistance: 350 $\Omega$ , shunt-cal support   | —             |
| Plug-on clip  | 701948  | 1000Vrms CAT II  | For the 700929/701947   | IM 701948-01E |
| Long test clip  | 701906  | 1000Vrms CAT II  | For the 700924/701926   | IM 701906-01E |
| Soft carrying case  | 701963  | —                | Has three pockets   | —             |
| DC power cord (Cigarette lighter plug type)   | 701970  | —                | For the DC power supply model (/DC)   | —             |
| DC power cord (Alligator clip type)   | 701971  | —                | For the DC power supply model (/DC)   | —             |
| GPS antenna   | A1058ER   | —                | GPS interface model (/C30)  | —             |
| Optional accessories (sold separately) are not covered by warranty of this instrument.  |   |                  |   |               |
| The minimum purchase quantity is 1 piece.   |   |                  |   |               |
| 1 Use cables (366926) that YOKOGAWA has been shipping since February 4, 1998. Cables (366926) shipped before this date cannot be used in combination with the DL850E/DL850EV input modules. |   |                  |   |               |

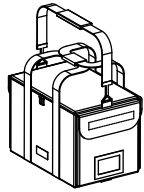

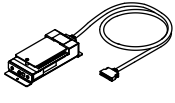
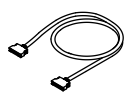
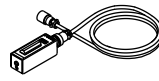
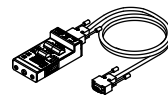
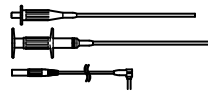
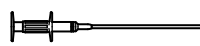
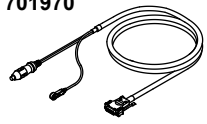
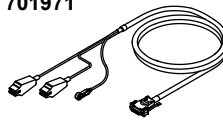
## Checking the Contents of the Package

|   |  |  |  |  |  |  |
|---|--|--|--|--|--|--|
| <b>Isolated probe</b><br>700929<br>                    | <b>Isolated probe</b><br>701947<br>                   | <b>Current probe</b><br>701930<br>                                  | <b>Current probe</b><br>701931<br>                                      | <b>Current probe</b><br>701932<br>                                      | <b>Current probe</b><br>701933<br>                                  |  |
| <b>Current probe</b><br>701917<br>                     | <b>Current probe</b><br>701918<br>                    | <b>Clamp-on probe</b><br>720930<br>                                 | <b>Clamp-on probe</b><br>720931<br>                                     | <b>10:1 passive probe</b><br>701940<br>                                  | <b>10:1 passive probe</b><br>(wide temperature range)<br>702902<br> |  |
| <b>Differential probe</b><br>700924<br>                | <b>Differential probe</b><br>700925<br>               | <b>Differential probe</b><br>701926<br>                             | <b>1:1 BNC safety adapter lead</b><br>701901 <sup>1</sup><br>         | <b>1:1 safety adapter lead</b><br>701904 <sup>1</sup><br>               |  |  |
| <b>Measurement lead</b><br>758933 <sup>1</sup><br>    | <b>Alligator clip (dolphin type)</b><br>701954<br>   | <b>Safety miniclip (hook type)</b><br>B9852MM<br>B9852MN<br>       | <b>Alligator clip adapter</b><br>758922<br>                            | <b>Alligator clip adapter</b><br>758929<br>                             | <b>Fork terminal adapter</b><br>758921<br>                         | <b>Cable</b><br>366926<br> |
| <b>Banana-alligator clip cable</b><br>366961<br>     | <b>High-speed logic probe</b><br>700986<br>         | <b>Isolated logic probe</b><br>700987<br>                         | <b>Logic probes</b><br>702911 (1 m)/702912 (3 m)<br>                 | <b>Probe power supply</b><br>701934<br>                               |  |  |
| <b>Isolated logic measurement lead</b><br>758917<br> | <b>External I/O cable</b><br>720911<br>             | <b>Safety BNC cable (1 m)</b><br>701902<br>                       | <b>Safety BNC cable (2 m)</b><br>701903<br>                           |  | <b>Soft carrying case</b><br>701963<br>                           |  |
| <b>Safety BNC-to-banana adapter</b><br>758924<br>    | <b>16-CH scanner box</b><br>701953 <sup>2</sup><br> | <b>Cable</b><br>705926 (1 m)<br>705927 (3m)<br>                   | <b>Bridgehead</b><br>701955 (NDIS, 120 Ω)<br>701956 (NDIS, 350 Ω)<br> | <b>Bridgehead</b><br>701957 (DSUB, 120 Ω)<br>701958 (DSUB, 350 Ω)<br> |  |  |
| <b>Plug-on clip</b><br>701948<br>                    | <b>Long test clip</b><br>701906<br>                 | <b>DC power cable (Cigarette lighter plug type)</b><br>701970<br> | <b>DC power cable (Alligator clip type)</b><br>701971<br>            | <b>GPS antenna</b><br>A1058ER<br>                                     |  |  |

1 The 1:1 BNC safety adapter lead (701901), the 1:1 safety adapter lead (701904), and the measurement lead (758933) must be used with one of the following accessories (which are sold separately): alligator clip (dolphin type: 701954), safety miniclip (hook type: B9852MM and B9852MN), alligator adapter (758922 or 758929), or fork terminal adapter (758921).

2 The length of the 16-CH scanner box (701953) cable varies depending on the 16-CH scanner box suffix code.

## Spare Parts (Sold Separately)

The spare parts below are available for purchase separately. Check that all contents are present and undamaged.

For information about ordering spare parts, contact your nearest YOKOGAWA dealer.

| Name               | Part No. | Minimum Q'ty | Note                                  |
|--------------------|----------|--------------|---------------------------------------|
| Printer roll paper | B9988AE  | 10           | Thermo-sensitive paper, 111 mm × 10 m |
| Terminal block     | A1800JD  | 1            | For the 720220 input module           |

# Safety Precautions

This product is designed to be used by a person with specialized knowledge.

This instrument is an IEC safety class I instrument (provided with a terminal for protective earth grounding).

The general safety precautions described herein must be observed during all phases of operation. If the instrument is used in a manner not specified in this manual, the protection provided by the instrument may be impaired. YOKOGAWA assumes no liability for the customer's failure to comply with these requirements.

This manual is part of the product and contains important information. Store this manual in a safe place close to the instrument so that you can refer to it immediately. Keep this manual until you dispose of the instrument.

## The following symbols are used on this instrument.



Handle with care. Refer to the user's manual or service manual. This symbol appears on dangerous locations on the instrument which require special instructions for proper handling or use. The same symbol appears in the corresponding place in the manual to identify those instructions.



Risk of electric shock



Protective ground or protective ground terminal



Ground or the functional ground terminal (do not use as the protective earth ground terminal)



Alternating current



ON (power)



OFF (power)

## French



À manipuler délicatement. Toujours se reporter aux manuels d'utilisation et d'entretien. Ce symbole a été apposé aux endroits dangereux de l'instrument pour lesquels des consignes spéciales d'utilisation ou de manipulation ont été émises. Le même symbole apparaît à l'endroit correspondant du manuel pour identifier les consignes qui s'y rapportent.



Risque de choc électrique



Mise à la terre de protection ou borne de mise à la terre de protection



Borne de terre ou borne de terre fonctionnelle (ne pas utiliser cette borne comme prise de terre.)



Courant alternatif



Marche (alimentation)



Arrêt (alimentation)

**Failure to comply with the precautions below could lead to injury or death or damage to the instrument.**

---

**WARNING**

**Use the Instrument Only for Its Intended Purpose**

This instrument is a waveform measuring device that monitors and measures electrical signals. Do not use this instrument for anything other than as a waveform measuring device.

**Check the Physical Appearance**

Do not use the instrument if there is a problem with its physical appearance.

**Use the Correct Power Supply**

Make sure that the power supply voltage matches the instrument's rated supply voltage and that it does not exceed the maximum voltage range of the power cord to use.

**Use the Correct Power Cord and Plug**

To prevent the possibility of electric shock or fire, be sure to use the power cord for the instrument. The main power plug must be plugged into an outlet with a protective earth terminal. Do not invalidate this protection by using an extension cord without protective earth grounding. Further, do not use this power cord with other instruments.

**Connect the Protective Grounding Terminal**

Make sure to connect the protective earth to prevent electric shock before turning on the power. The power cord that you can use for the instrument is a three-prong cord. Connect the power cord to a properly grounded three-prong outlet.

**Do Not Impair the Protective Grounding**

Never cut off the internal or external protective earth wire or disconnect the wiring of the protective earth terminal. Doing so may result in electric shock or damage to the instrument.

**Do Not Use When the Protection Functions Are Defective**

Before using this instrument, check that the protection functions, such as the protective grounding and fuse, are working properly. If you suspect a defect, do not use the instrument.

**Do Not Operate in an Explosive Atmosphere**

Do not operate the instrument in the presence of flammable gasses or vapors. Doing so is extremely dangerous.

**Do Not Remove the Covers or Disassemble or Alter the Instrument**

Only qualified YOKOGAWA personnel may remove the covers and disassemble or alter the instrument. The inside of the instrument is dangerous because parts of it have high voltages.

**Ground the Instrument before Making External Connections**

Securely connect the protective grounding before connecting to the item under measurement or to an external control unit. Before touching a circuit, turn off its power and check that it has no voltage.

**Precautions to Be Taken When Using the DC Power Supply (When using a DL850EV DC power supply model)**

- Make sure to perform protective earth grounding to prevent electric shock.
- Connect the DC power cord after checking that the power switch of the instrument is turned OFF. If you connect the power cord with the power switch turned ON, sparks may be emitted and can lead to fire.

**Precautions to Be Taken When Using the Modules**

- Do not apply input voltage exceeding the maximum input voltage, withstand voltage, or allowable surge voltage.
- To prevent the possibility of electric shock, be sure to furnish protective earth grounding of the DL850E/DL850EV.
- To prevent the possibility of electric shock, be sure to fasten the module screws. Otherwise, the electrical protection function and the mechanical protection function will not be activated.
- Avoid continuous connection under an environment in which the surge voltage may occur.

**Precautions to Be Taken When Using the Probes**

- To measure high voltage with the 701250 (HS10M12), 720250 (HS10M12), 701251 (HS1M16), 720210 (HS100M12), 720211 (HS100M12), or 720254 (4CH 1M16), use the isolated probes (700929, 701947), passive probes 702902, 1:1 safety cables (combination of 701901 and 701954), or differential probes (700924, 700925, 701926).
- Be sure to connect the ground lead of the differential probe (700924, 700925, 701926) to the functional grounding terminal on the right side panel of the DL850E/DL850EV before connecting to the measurement target. Not doing so may cause high voltage to appear in the BNC connector of the differential probe.
- When using the 701255 (NONISO\_10M12), be sure to fasten the module screws. Fastening the module screws activates the protection function and the non-isolation function. It is extremely dangerous if you do not fasten the screws. Also, when you measure high voltages above 42 V, be sure to use the passive probe 701940.
- The BNC portion of the passive probe 701940 is metal, so if you use it with isolated input (the 701250 (HS10M12), 701251 (HS1M16), etc.), for safety, be sure to only use it with voltages at or below 42 V. (Do not connect voltage above 42 V to both the High and Low sides.) For non-isolated inputs (701255 (NONISO\_10M12), etc.), fasten the module screws as described before.
- When you apply high voltages to the 701267 (HV (with RMS)), or 720268 (HV (AAF, RMS)), use the measurement leads (combination of 758933 and 701954) or 1:1 safety cables (combination of 701904 and 701954).
- The measurement category of the 701267 (HV (with RMS)) is 400V-CAT II on the low side and 700V-CAT II on the high side. Use caution because the overvoltage tolerance differs between the low and high sides.

**Measurement Category**

The measurement category of this instrument's signal input terminals varies depending on the modules that are installed. Use the instrument within the scope of the measurement category that corresponds to the module specifications. Do not use the instrument outside the scope of the measurement category that corresponds to the module specifications.

**Install or Use the Instrument in Appropriate Locations**

- Do not install or use the instrument outdoors or in locations subject to rain or water.
- Install the instrument so that you can immediately remove the power cord if an abnormal or dangerous condition occurs.

---

---

**CAUTION**

---

---

**Operating Environment Limitations**

This product is classified as Class A (for use in industrial environments). Operation of this product in a residential area may cause radio interference, in which case the user will be required to correct the interference.

---

## French

---

### AVERTISSEMENT

#### **Utiliser l'instrument aux seules fins pour lesquelles il est prévu**

Cet instrument est un appareil de mesure de forme d'onde pour le contrôle et la mesure des signaux électriques. Ne pas utiliser cet instrument à d'autres fins que celles de mesure de forme d'onde.

#### **Inspecter l'apparence physique**

Ne pas utiliser l'instrument si son intégrité physique semble être compromise.

#### **Vérifier l'alimentation**

Assurez-vous que la tension d'alimentation correspond à la tension d'alimentation nominale de l'appareil et qu'elle ne dépasse pas la plage de tension maximale du cordon d'alimentation à utiliser.

#### **Utiliser le cordon d'alimentation et la fiche adaptés**

Pour éviter tout risque de choc électrique, utiliser exclusivement le cordon d'alimentation prévu pour cet instrument. La fiche doit être branchée sur une prise secteur raccordée à la terre. En cas d'utilisation d'une rallonge, celle-ci doit être impérativement reliée à la terre. Par ailleurs, ne pas utiliser ce cordon d'alimentation avec d'autres instruments.

#### **Brancher la prise de terre**

Avant de mettre l'instrument sous tension, penser à brancher la prise de terre pour éviter tout choc électrique. Le cordon d'alimentation que vous utilisez pour l'instrument est un cordon à trois broches. Brancher le cordon d'alimentation sur une prise de courant à trois plots et mise à la terre.

#### **Ne pas entraver la mise à la terre de protection**

Ne jamais neutraliser le fil de terre interne ou externe, ni débrancher la borne de mise à la terre. Cela pourrait entraîner un choc électrique ou endommager l'instrument.

#### **Ne pas utiliser lorsque les fonctions de protection sont défectueuses**

Avant d'utiliser l'instrument, vérifier que les fonctions de protection, telles que le raccordement à la terre et le fusible, fonctionnent correctement. En cas de dysfonctionnement possible, ne pas utiliser l'instrument.

#### **Ne pas utiliser dans un environnement explosif**

Ne pas utiliser l'instrument en présence de gaz ou de vapeurs inflammables. Cela pourrait être extrêmement dangereux.

#### **Ne pas retirer le capot, ni démonter ou modifier l'instrument**

Seul le personnel YOKOGAWA qualifié est habilité à retirer le capot et à démonter ou modifier l'instrument. Certains composants à l'intérieur de l'instrument sont à haute tension et par conséquent, représentent un danger.

#### **Relier l'instrument à la terre avant de le brancher sur des connexions externes**

Connectez le conducteur de terre avant de raccorder le dispositif cible ou une unité de commande externe. Avant de toucher le dispositif cible, mettez l'instrument hors tension, et vérifiez qu'aucune tension ni aucun courant ne sont émis.

#### **Précautions à prendre avec l'alimentation en courant continu (lors de l'utilisation d'un DL850EV à alimentation en CC)**

- Veillez à raccorder l'instrument à la terre pour éviter tout risque de choc électrique.
- Branchez le cordon d'alimentation CC après avoir vérifié que l'interrupteur d'alimentation de l'instrument est sur OFF. Si vous reliez le cordon d'alimentation lorsque l'interrupteur électrique est sur ON, des étincelles peuvent jaillir et provoquer un incendie.

**Précautions à prendre lors de l'utilisation des modules**

- Ne pas dépasser les valeurs maximales de tension d'entrée, de tension de maintien ou de surtension admissible.
- Pour éviter tout risque de choc électrique, toujours relier le DL850E/DL850EV à la terre.
- Pour éviter tout risque de choc électrique, toujours serrer les vis des modules, à défaut de quoi les fonctions de protection électrique et de protection mécanique ne seront pas activées.
- Éviter les connexions continues dans les environnements pouvant être soumis à surtension.

**Précautions à prendre lors de l'utilisation de sondes**

- Lors de la mesure de tensions élevées à l'aide du 701250 (HS10M12), 720250 (HS10M12), 701251 (HS1M16), 720210 (HS100M12), 720211 (HS100M12) ou 720254 (4CH 1M16), utiliser une sonde isolée (700929 ou 701947), un câble de sécurité 1:1 (701901 et 701954 conjointement) ou une sonde différentielle (700924, 700925 ou 701926).
- Bien relier le fil de terre de la sonde différentielle (700924, 700925, 701926) à la borne de mise à la terre opérationnelle, sur le panneau droit de DL850E/DL850EV avant de le relier à la cible de la mesure. Le fait de ne pas respecter cette consigne risque d'entraîner l'apparition d'une tension élevée au niveau du connecteur BNC de la sonde différentielle.
- Lors de l'utilisation du 701255 (NONISO\_10M12), veillez à serrer les vis du module. Le serrage des vis de module active la fonction de protection et celle de non-isolation. La situation est extrêmement dangereuse lorsque les vis ne sont pas serrées. Lorsque vous mesurez des hautes tensions supérieures à 42 V, veillez également à utiliser la sonde passive 701940.
- La partie BNC de la sonde passive 701940 est en métal ; si vous l'utilisez avec l'entrée isolée (la 701250 (HS10M12), 720250 (HS10M12), 701251 (HS1M16), etc.), veillez à l'utiliser uniquement à des tensions inférieures ou égales à 42 V pour des raisons de sécurité (ne reliez pas une tension supérieure à 42 V sur les côtés Haut et Bas). Pour les entrées non isolées (701255 (NONISO\_10M12), etc.), serrez les vis du module comme décrit ci-dessus.
- Lorsque vous appliquez de hautes tensions au 701267 (HV (avec RMS)) ou 720268 (HV (AAF, RMS)), utilisez un cordon de mesure (758933 et 701954 conjointement) ou un câble de sécurité 1:1 (701904 et 701954 conjointement).
- La catégorie de mesure du 701267 (HV (avec RMS)) est 400 V-CAT II dans la partie basse et 700V-CAT II dans la partie haute. Faites attention car la tolérance de surtension diffère entre les côtés bas et haut.

**Catégorie de mesure**

La catégorie de mesure de ces bornes d'entrée de signal de l'instrument varie en fonction des modules installés. Utilisez l'instrument dans les limites de la catégorie de mesure qui correspondent aux spécifications du module. N'utilisez pas l'instrument en dehors des limites de la catégorie de mesure qui correspondent aux spécifications du module.

**Installer et utiliser l'instrument aux emplacements appropriés**

- Ne pas installer, ni utiliser l'instrument à l'extérieur ou dans des lieux exposés à la pluie ou à l'eau.
- Installer l'instrument de manière à pouvoir immédiatement le débrancher du secteur en cas de fonctionnement anormal ou dangereux.

---

---

**ATTENTION**

---

---

**Limitations relatives à l'environnement opérationnel**

Ce produit est classé dans classe A (pour utilisation dans des environnements industriels). L'utilisation de ce produit dans une zone résidentielle peut entraîner une interférence radio que l'utilisateur sera tenu de rectifier.

---

# Regulations and Sales in Each Country or Region

## Waste Electrical and Electronic Equipment



### Waste Electrical and Electronic Equipment (WEEE), Directive

(This directive is valid only in the EU.)

This product complies with the WEEE directive marking requirement. This marking indicates that you must not discard this electrical/electronic product in domestic household waste.

### Product Category

With reference to the equipment types in the WEEE directive, this product is classified as a “Monitoring and control instruments” product.

When disposing products in the EU, contact your local Yokogawa Europe B.V. office.

Do not dispose in domestic household waste.

## EU Battery Directive



### EU Battery Directive

(This directive is valid only in the EU.)

Batteries are included in this product. This marking indicates they shall be sorted out and collected as ordained in the EU battery directive.

Battery type: Lithium battery

You cannot replace batteries by yourself. When you need to replace batteries, contact your local Yokogawa Europe B.V. office.

## Authorized Representative in the EEA

Yokogawa Europe B.V. is the authorized representative of Yokogawa Test & Measurement Corporation for this product in the EEA. To contact Yokogawa Europe B.V., see the separate list of worldwide contacts, PIM 113-01Z2.

## 關於在台灣銷售

This section is valid only in Taiwan.

關於在台灣所販賣的符合其相關規定的電源線 A1100WD 的限用物質含量信息，請至下麵的網址進行查詢

<https://tmi.yokogawa.com/support/service-warranty-quality/product-compliance/>

## Disposal

When disposing of YOKOGWA products, follow the laws and ordinances of the country or region where the product will be disposed of.



---

# Symbols and Notation Used in This Manual

## Prefixes k and K

Prefixes k and K used before units are distinguished as follows:

k: Denotes 1000.

Example: 100 kS/s (sample rate)

K: Denotes 1024.

Example: 720 KB (file size)

## Displayed Characters

Bold characters in procedural explanations are used to indicate panel keys and soft keys that are used in the procedure and menu items that appear on the screen.

## Notes and Cautions

The notes and cautions in this manual are categorized using the following symbols.



*Improper handling or use can lead to injury to the user or damage to the instrument.* This symbol appears on the instrument to indicate that the user must refer to the user's manual for special instructions. The same symbol appears in the corresponding place in the user's manual to identify those instructions. In the manual, the symbol is used in conjunction with the word "WARNING" or "CAUTION."

### **WARNING**

Calls attention to actions or conditions that could cause serious or fatal injury to the user, and precautions that can be taken to prevent such occurrences.

### **CAUTION**

Calls attentions to actions or conditions that could cause light injury to the user or damage to the instrument or user's data, and precautions that can be taken to prevent such occurrences.

## French

### **AVERTISSEMENT**

Attire l'attention sur des gestes ou des conditions susceptibles de provoquer des blessures graves (voire mortelles), et sur les précautions de sécurité pouvant prévenir de tels accidents.

### **ATTENTION**

Attire l'attention sur des gestes ou des conditions susceptibles de provoquer des blessures légères ou d'endommager l'instrument ou les données de l'utilisateur, et sur les précautions de sécurité susceptibles de prévenir de tels accidents.

## **Note**

Calls attention to information that is important for proper operation of the instrument.

# Contents

|  |       |
|--|-------|
| List of Manuals.....                                 | i     |
| Regarding the Conventional DL850 and DL850V.....     | iii   |
| Checking the Contents of the Package.....            | iv    |
| Safety Precautions.....                              | xiii  |
| Regulations and Sales in Each Country or Region..... | xviii |
| Symbols and Notation Used in This Manual.....        | xix   |

## Chapter 1 Names and Functions of Parts

|  |      |
|--|------|
| 1.1 Top Panel, Front Panel, Right Side Panel, and Left Side Panel..... | 1-1  |
| 1.2 Panel Keys and Knobs.....  | 1-7  |
| 1.3 Screens.....   | 1-11 |
| 1.4 System Configuration.....  | 1-13 |

## Chapter 2 Main Features

|  |      |
|--|------|
| 2.1 Vertical and Horizontal Axes.....      | 2-1  |
| 2.2 Triggering.....                        | 2-4  |
| ▲ 2.3 Waveform Acquisition.....            | 2-7  |
| 2.4 Waveform Display.....                  | 2-10 |
| 2.5 Waveform Computation and Analysis..... | 2-11 |

## Chapter 3 Making Preparations for Measurements

|  |      |
|--|------|
| 3.1 Handling Precautions.....  | 3-1  |
| 3.2 Installing the Instrument.....   | 3-3  |
| ▲ 3.3 Installing Input Modules.....  | 3-6  |
| ▲ 3.4 Connecting to a Power Supply and Turning the Power Switch On and Off.....  | 3-11 |
| ▲ 3.5 Connecting Probes.....   | 3-17 |
| ▲ 3.6 Correcting the Probe Phase.....  | 3-28 |
| ▲ 3.7 Connecting Measurement Leads.....  | 3-30 |
| ▲ 3.8 Connecting Thermocouples.....  | 3-34 |
| ▲ 3.9 Connecting Bridgeheads.....  | 3-36 |
| ▲ 3.10 Connecting a Logic Probe to the Logic Input Module.....                   | 3-39 |
| ▲ 3.11 Connecting an Acceleration Sensor.....                                    | 3-42 |
| ▲ 3.12 Connecting Sensors to the Frequency Module.....                           | 3-45 |
| ▲ 3.13 Connecting Wires to the 16-CH Voltage Input Module.....                   | 3-47 |
| ▲ 3.14 Connecting Wires to the 16-CH Temperature/Voltage Input Module.....       | 3-50 |
| ▲ 3.15 Connecting a Cable to the CAN Bus Monitor, CAN/CAN FD Monitor Module..... | 3-54 |
| ▲ 3.16 Connecting a Cable to the CAN & LIN Bus Monitor Module.....               | 3-55 |
| 3.17 Attaching the Panel Sheet.....  | 3-56 |
| ▲ 3.18 Loading Roll Paper into the Built-In Printer (Option).....                | 3-57 |
| 3.19 Connecting an Antenna to the GPS Interface (Option).....                    | 3-59 |

## Chapter 4 Common Operations

|  |      |
|--|------|
| 4.1 Key and Jog Shuttle Operations.....        | 4-1  |
| 4.2 Entering Values and Strings.....           | 4-3  |
| 4.3 Using USB Keyboards and Mouse Devices..... | 4-5  |
| 4.4 Synchronizing the Clock.....               | 4-10 |
| 4.5 Performing Auto Setup.....                 | 4-11 |
| 4.6 Initializing Settings.....                 | 4-13 |
| 4.7 Calibrating the DL850E/DL850EV.....        | 4-14 |

|     |  |      |
|-----|--|------|
| 4.8 | Starting and Stopping Waveform Acquisition ..... | 4-15 |
| 4.9 | Displaying Help .....                            | 4-16 |

## Chapter 5 External Signal I/O

|       |  |      |
|-------|--|------|
| ▲ 5.1 | External Trigger Input (TRIGGER IN).....                                 | 5-1  |
| ▲ 5.2 | Trigger Output (TRIGGER OUT).....  | 5-2  |
| ▲ 5.3 | External Clock Input (EXT CLK IN) .....                                  | 5-4  |
| ▲ 5.4 | Video Signal Output (VIDEO OUT (XGA)) .....                              | 5-5  |
| ▲ 5.5 | GO/NO-GO Determination I/O and External Start/Stop Input (EXT I/O) ..... | 5-6  |
| ▲ 5.6 | IRIG Signal Input (IRIG option) .....                                    | 5-10 |
| 5.7   | GPS Signal Input (GPS option).....                                       | 5-11 |

## Chapter 6 Specifications

|      |   |      |
|------|---|------|
| 6.1  | Signal Input Section .....  | 6-1  |
| 6.2  | Triggering Section .....  | 6-1  |
| 6.3  | Time Axis .....   | 6-3  |
| 6.4  | Display.....  | 6-3  |
| 6.5  | Features .....  | 6-4  |
| 6.6  | FFT .....   | 6-12 |
| 6.7  | Built-in Printer.....   | 6-12 |
| 6.8  | Storage.....  | 6-13 |
| 6.9  | USB Ports for Peripherals .....   | 6-13 |
| 6.10 | Auxiliary I/O Section .....   | 6-14 |
| 6.11 | Computer Interface.....   | 6-16 |
| 6.12 | General Specifications .....  | 6-17 |
| 6.13 | Module Specifications .....   | 6-22 |
|      | High-Speed 10 MS/s, 12-Bit Isolation Module (701250) .....  | 6-22 |
|      | High-Speed 10 MS/s, 12-Bit Isolation Module (720250) .....  | 6-24 |
|      | High-Speed High-Resolution 1 MS/s, 16-Bit Isolation Module (701251) .....                             | 6-26 |
|      | High-Speed 10 MS/s, 12-Bit Non-Isolation Module (701255) .....  | 6-28 |
|      | High-Voltage 100 kS/s, 16-Bit Isolation Module (with RMS) (701267) .....                              | 6-29 |
|      | High-Voltage 1 MS/s, 16-Bit Isolation Module (with AAF, RMS) (720268) .....                           | 6-31 |
|      | Universal (Voltage/Temp.) Module (701261) /Universal (Voltage/Temp.) Module (with AAF) (701262) ..... | 6-33 |
|      | Temperature, High Precision Voltage Isolation Module (701265) .....                                   | 6-35 |
|      | Temperature, High Precision Voltage Isolation Module (low noise) (720266) .....                       | 6-37 |
|      | Strain Module (NDIS) (701270).....  | 6-39 |
|      | Acceleration/Voltage Module (with AAF) (701275).....  | 6-43 |
|      | Frequency Module (701281) .....   | 6-45 |
|      | Frequency Module (720281) .....   | 6-49 |
|      | High-Speed 100 MS/s, 12-Bit Isolation Module (720210 and 720211) .....                                | 6-53 |
|      | 16-CH Voltage Input Module (720220).....  | 6-55 |
|      | 16-CH Temperature/Voltage Input Module (720221).....  | 6-56 |
|      | Logic Input Module (720230).....  | 6-58 |
|      | CAN Bus Monitor Module (720240) .....   | 6-59 |
|      | CAN & LIN Bus Monitor Module (720241) .....   | 6-60 |
|      | CAN/CAN FD Monitor Module (720242) .....  | 6-61 |
|      | SENT Monitor Module (720243).....   | 6-62 |
|      | 4-CH 1 MS/s, 16-Bit Isolation Module (720254).....  | 6-63 |
| 6.14 | Logic Probe Specifications .....  | 6-65 |
| 6.15 | 16-CH Scanner Box Specifications .....  | 6-67 |
| 6.16 | External Dimensions .....   | 6-68 |



**Appendix**

Appendix 1 Relationship between the Time Axis Setting, Record Length, and Sample Rate..... App-1

Appendix 2 Relationship between the Main Channel Sample Rate, Sub Channel Data Update Rate, and Acquisition Memory Writing Rate ..... App-16

Appendix 3 Relationship between the Record Length and the Acquisition Mode ..... App-19

Appendix 4 Default Values ..... App-22

Appendix 5 USB Keyboard Key Assignments ..... App-28

Appendix 6 Block Diagrams ..... App-30

⚠ Appendix 7 High-Voltage 100 kS/s, 16-Bit Isolation Module (with RMS) (701260) Specifications ..... App-33

Appendix 8 Frequency Module (701280) Specifications ..... App-35

# 1.1 Top Panel, Front Panel, Right Side Panel, and Left Side Panel

## Top Panel

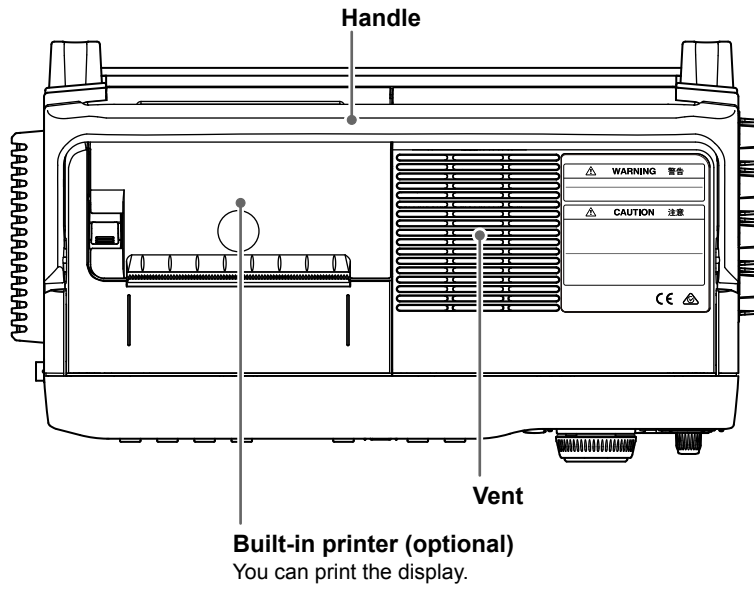

## Front Panel

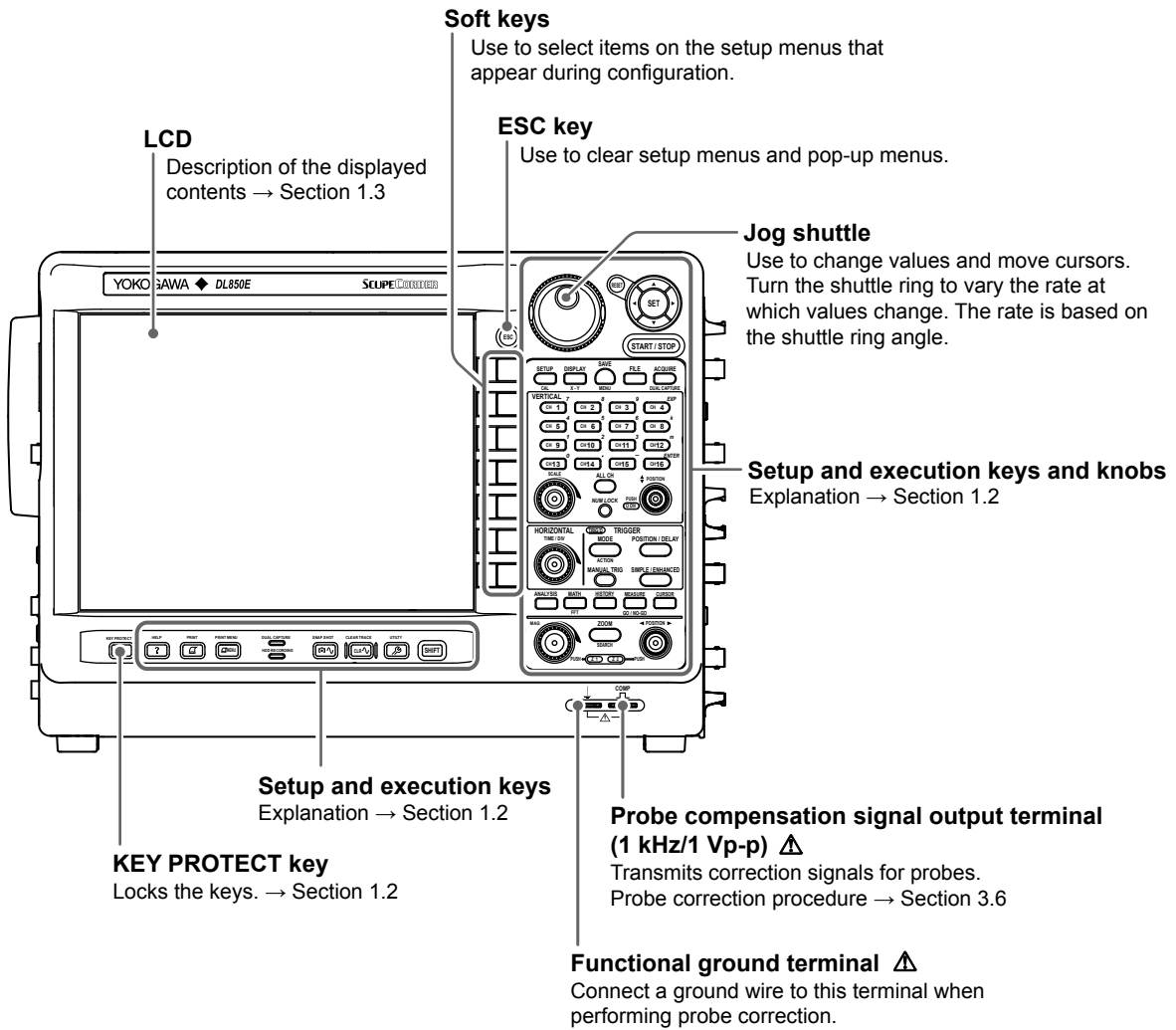

## Right Side Panel

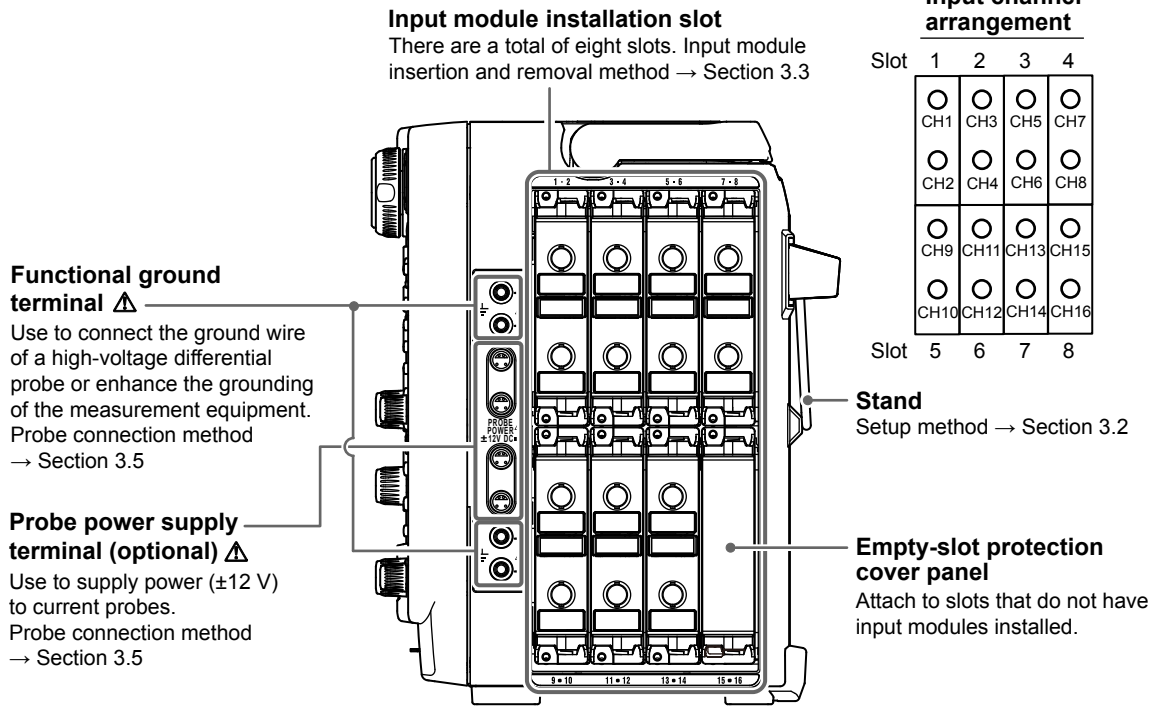

## Input Modules

The following input modules are available.

High-Speed 10 MS/s,  
12-Bit Isolation Module  
HS10M12 (model: 701250)

High-Speed High-Resolution  
1 MS/s, 16-Bit Isolation Module  
HS1M16 (model: 701251)

High-Speed 10 MS/s,  
12-Bit Non-Isolation Module  
NONISO\_10M12 (model: 701255)

Acceleration/Voltage Module  
(with AAF)  
ACCL/VOLT (model: 701275)

High-Speed 100 MS/s,  
12-Bit Isolation Module  
HS100M12 (model: 720210 and 720211)

Frequency Module  
FREQ (model: 701281)

Universal (Voltage/Temp.)  
Module  
UNIVERSAL (model: 701261)

Universal (Voltage/Temp.)  
Module (with AAF)  
UNIVERSAL (AAF) (model: 701262)

Temperature, High Precision  
Voltage Isolation Module  
TEMP/HPV  
(model: 701265 and 720266)

High-Speed 10 MS/s,  
12-Bit Isolation Module  
HS10M12 (model: 720250)

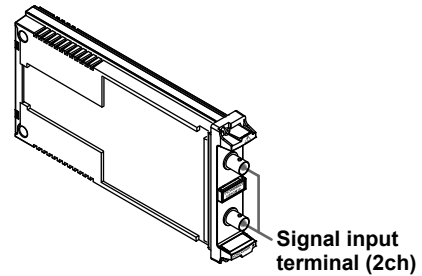

High-Voltage 100 kS/s,  
16-Bit Isolation Module  
(with RMS)  
HV (with RMS) (model: 701267)

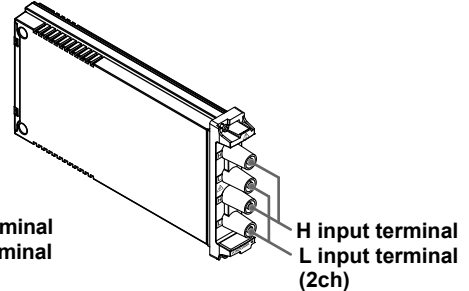
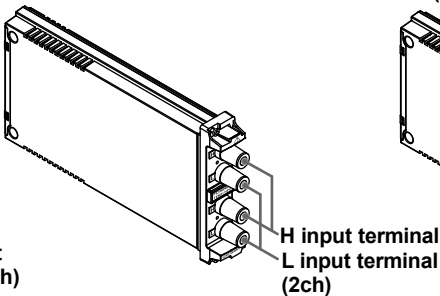
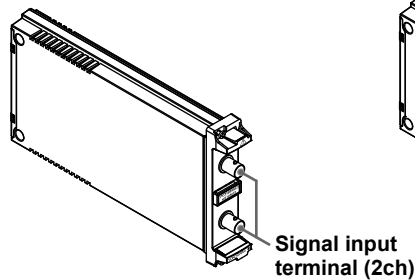

1.1 Top Panel, Front Panel, Right Side Panel, and Left Side Panel

High-Voltage 1 MS/s,  
16-Bit Isolation Module  
(with AAF and RMS)  
HV (AAF RMS) (model: 720268)

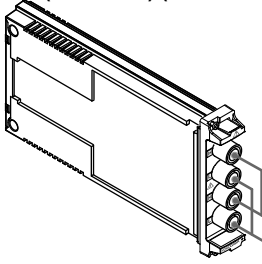

H input terminal  
L input terminal  
(2ch)

Strain Module (NDIS)  
STRAIN\_NDIS (model: 701270)

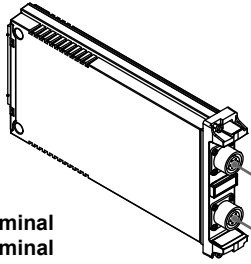

Signal input  
terminal (2ch)

Strain Module (DSUB, Shunt-Cal)  
STRAIN\_DSUB (model: 701271)

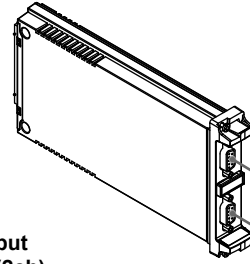

Signal input  
terminal (2ch)

Frequency Module  
FREQ (model: 720281)

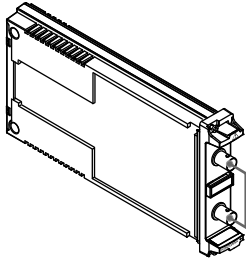

Signal input  
terminal (2ch)

16-CH Voltage Input Module  
16CH VOLT (model: 720220)

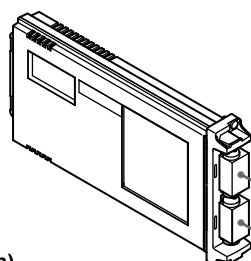

Signal input  
terminal (16ch)

16-CH Temperature/Voltage  
Input Module  
16CH TEMP/VOLT (model: 720221)

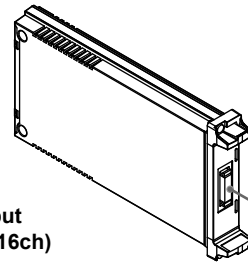

Signal input  
terminal (16ch)

Logic Input Module  
LOGIC (model: 720230)

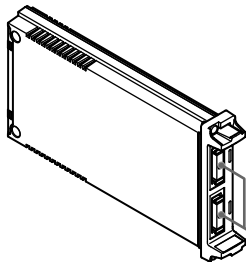

Logic probe  
terminals

CAN Bus Monitor Module  
CAN MONITOR (model: 720240)

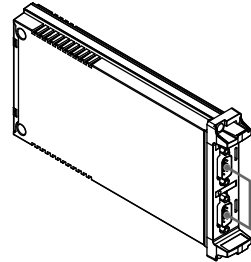

CAN bus signal  
input terminal

CAN & LIN Bus Monitor Module  
CAN & LIN (model: 720241)

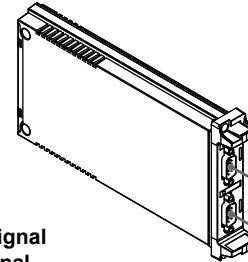

CAN bus signal  
input terminal  
LIN bus signal  
input terminal

SENT Monitor Module  
SENT (model: 720243)

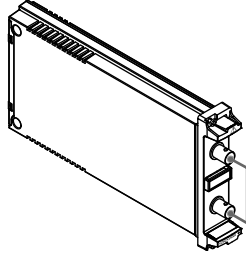

SENT signal  
input terminal

4-CH 1 MS/s, 16-Bit Isolation  
Module  
4CH 1M16 (model: 720254)

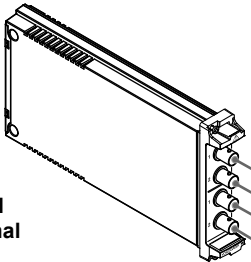

Signal input  
terminal (4ch)

CAN/CAN FD Monitor Module  
CAN/CAN FD (model: 720242)

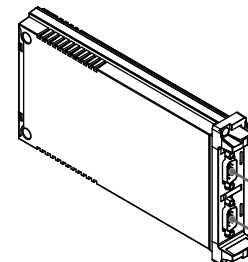

CAN bus/  
CAN FD bus  
signal input  
terminal



### Left Side Panel

**Video signal output terminal**

You can output the displayed image in an XGA RGB signal.  
Explanation about how to use → Section 5.4

**GO/NO-GO and external start/stop I/O connector** ⚠

Transmits GO/NO-GO determination I/O signals. Can also be used to start and stop the DL850E/DL850EV through external control.  
Explanation about how to use → Section 5.5

**Vent**

**External-clock input terminal** ⚠

Use when applying an external clock signal.  
Explanation about how to use → Section 5.3

**Power switch**

Turning the power on and off  
→ Section 3.4

**Power inlet** ⚠

Power connection  
→ Section 3.4

**Name plate**

**Trigger input terminal** ⚠

Use when applying an external trigger signal.  
Explanation about how to use → Section 5.1

**Trigger output terminal** ⚠

Use to transmit trigger signals.  
Explanation about how to use → Section 5.2

**GP-IB connector (optional)**

Use to communicate with the DL850E /DL850EV through the GP-IB interface. For information about the DL's communication features, see the communications interface user's manual.

**IRIG input terminal (option)** ⚠

Use this terminal to apply external sync signals.  
Explanation about how to use → Section 5.6 (C20)

**External HDD connector (optional)** ⚠

Use to connect an external hard disk.  
Explanation about how to use → User's manual

**SD memory card slot** ⚠

Use to connect an SD memory card.  
Explanation about how to use → User's manual

**USB port for PCs**

Use to connect the DL850E/DL850EV to a PC that has a USB port.  
Explanation about how to use → Communication interface user's manual

**USB ports for peripherals**

Use to connect a USB keyboard, mouse, printer, or storage device.  
Explanation about how to use → Section 4.3 and User's manual

**Ethernet port (100BASE-T/100BASE-TX)**

Use to connect the DL850E/DL850EV to a LAN. Explanation about how to use → Feature's guide and communication interface user's manual

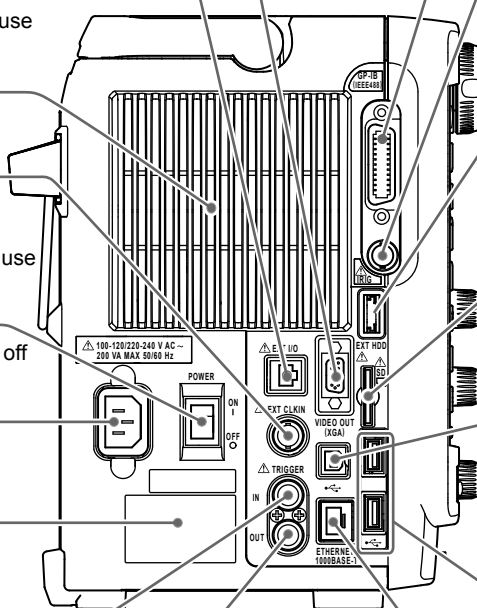

**DC Power Supply Model (DL850EV)**

Only the parts that are different from the standard model are shown below.

**Power supply status LED**

Displays the status of the AC power supply or DC power supply. The status indicator  
→ Section 3.4

**Power switch (AC)**

Turning the power on and off  
→ Section 3.4

**Power switch (DC)**

Turning the power on and off  
→ Section 3.4

**AC power connector** ⚠

Power connection  
→ Section 3.4

**DC power connector** ⚠

Power connection  
→ Section 3.4

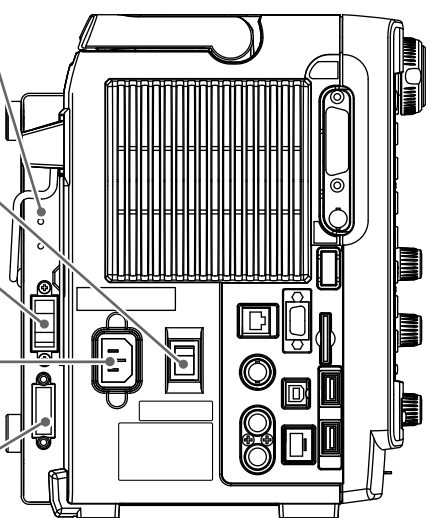

## 1.1 Top Panel, Front Panel, Right Side Panel, and Left Side Panel

---

### GPS Interface Model

Only the parts that are different from the standard model are shown below.

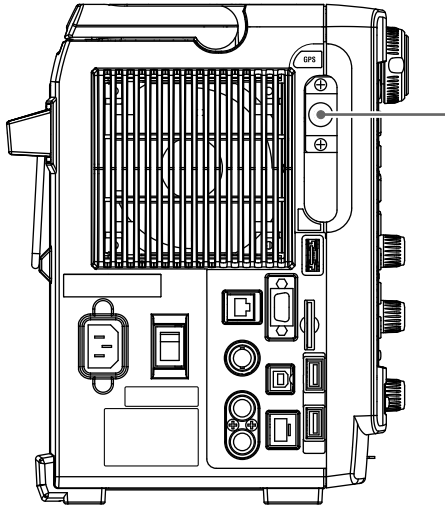

#### GPS input terminal (optional)

Use this terminal to apply external sync signals.

Explanation about how to use → Section 3.19 (/C30)

## 1.2 Panel Keys and Knobs

### Vertical Axis

#### CH1 to CH16 Keys

These keys display menus for turning the display of each channel on and off and configuring settings such as display label settings, input coupling settings, the probe attenuation or the current-to-voltage conversion ratio, the bandwidth limit, the vertical position, vertical zoom settings, the offset value, and linear scaling. Also, you can press a key to select the channel that the SCALE knob will control. Channel keys illuminate when their corresponding channel is on.

After you press NUM LOCK (see below), you can press a channel key to enter the number displayed to the upper right of the key in white.

#### ALL CH Key

Press this key to display a window in which you can configure all the settings from the menus that appear when you press CH1 to CH16. The settings appear in a list.

#### NUM LOCK Key

Press this key to use the CH1 to CH16 keys to enter numbers.

#### SCALE Knob

Use this knob to set the vertical scale. Before you turn this knob, select the target waveform by pressing a key from CH1 to CH16. If you change the scale while waveform acquisition is stopped, the setting actually takes effect when you restart waveform acquisition.

#### ◆ POSITION Knob (Vertical POSITION Knob)

Use this knob to adjust the vertical display position (vertical position) of an input waveform. Before you turn this knob, select the target waveform by pressing a key from CH1 to CH16. This knob has a push switch. You can press the knob to reset the position to 0.00 div.

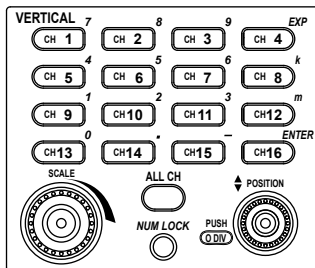

### Horizontal Axis

#### TIME/DIV knob

Use this knob to set the time-axis scale. If you change the scale while waveform acquisition is stopped, the scale change actually takes effect when you restart waveform acquisition.



## TRIGGER Group Keys

### (SHIFT+) MODE Key

Displays a menu for selecting the trigger mode. Press SHIFT and then MODE to display a menu for configuring action-on settings.

### POSITION/DELAY Key

Press this key to set the trigger position and the trigger delay.

### MANUAL TRIG Key

Press this key to make the DL850E/DL850EV trigger regardless of the trigger settings.

### SIMPLE/ENHANCED Key

Displays a trigger setup menu.

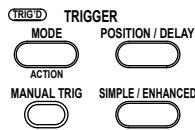

## Other Keys

### ANALYSIS Key

Displays a menu for performing power math. This key is valid on models with the /G5 option.

### (SHIFT+) MATH Key

Displays a menu for waveform computation. Press SHIFT and then MATH to display a menu for configuring FFT computation.

### HISTORY Key

Displays a menu for using the history feature to recall data.

### (SHIFT+) MEASURE Key

Displays a menu for automated measurement of waveform parameters. Press SHIFT and then MEASURE to display a menu for GO/NO-GO determination.

### CURSOR Key

Displays a menu used when performing cursor measurements.

### (SHIFT+) ZOOM Key

Displays a waveform zoom display menu. Press SHIFT and then ZOOM to display a menu for data searching (the search & zoom function).

### MAG Knob

Use this knob to set the zoom factors for the Zoom1 and Zoom2 zoom boxes. This knob has a push switch. Press the MAG knob to switch the zoom box whose zoom factor is set by it.

### ◀POSITION▶ Knob (Zoom POSITION knob)

Use this knob to set the zoom position. This knob has a push switch. Press the POSITION knob to switch the zoom box whose zoom position is set by it.

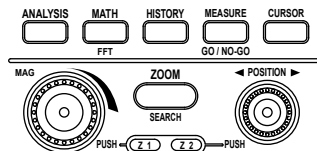

## RESET Key

Resets the value to its default value.

## SET Key

Press this key to select the menu item that you have moved the cursor to using the jog shuttle. You can also press the SET key to start entering a value or characters.

## Arrow Keys (▲▼▶◀ keys)

Use the ▶◀ keys to move the cursor between numeric digits. Use the ▲▼ keys to increment or decrement the value of a digit. You can also use the ▲▼ keys to select setup items.

## START/STOP Key

Starts and stops waveform acquisition according to the trigger mode. The key is illuminated while the DL850E/DL850EV is acquiring waveforms.

## (SHIFT+) SETUP Key

Displays a menu for initializing the settings to their factory defaults; performing auto setup, which automatically sets the DL850E/DL850EV according to the input signal; storing and recalling setup information; and so on. Press SHIFT and then SETUP to display a calibration menu.

## (SHIFT+) DISPLAY Key

Use this key to configure the display. Press SHIFT and then DISPLAY to display an X-Y display menu.

## (SHIFT+) SAVE Key

Press this key to save waveform or screen capture data to a storage medium. Press SHIFT and then SAVE to display a menu for configuring the save operation.

## FILE Key

Press this key to save or load data from a storage medium or to display a menu for file manipulation.

## (SHIFT+) ACQUIRE Key

Displays a menu used to set the waveform acquisition mode. Press SHIFT and then ACQUIRE to display a menu for configuring the dual capture feature.

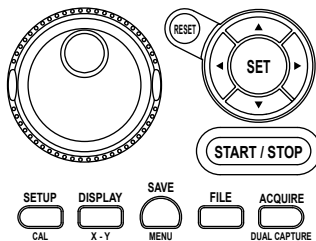

## 1.2 Panel Keys and Knobs

---

### KEY PROTECT Key

When you press this key, it illuminates, and the keys on the front panel are locked. Press the key again to unlock the keys.

### HELP Key

Turns on and off the help window, which explains various features.

### PRINT Key

Use this key to save and print screen capture data.

### PRINT MENU Key

Displays a menu for printing screen captures to the built-in printer or a network printer or displays a menu for saving screen capture data to a storage medium.



### SNAPSHOT Key

Retains the currently displayed waveforms on the screen in white. Snapshot waveforms can be saved and loaded.

### CLEAR TRACE Key

Clears the waveform acquired using the snapshot function and accumulated waveforms.

### UTILITY Key

Displays a menu for configuring system, communication, network, and environment settings; for performing self tests; and for displaying system information (information about installed modules, installed options, and the firmware version).

### SHIFT Key

Press this key once to access the features that are written in purple below each key. The shift key illuminates when the keys are shifted. Pressing the key again clears the shifted condition.



---

#### Note

Press SHIFT and then CLEAR TRACE to switch from remote mode to local mode. For details, see the communication interface user's manual.

---

## Notes about Using of Knobs

The vertical POSITION, ZOOM MAG, and ZOOM POSITION knobs have push switches. Push the knobs straight. If you push a knob at an angle, it may not operate properly. If this happens, push the knob straight one more time.

---

### CAUTION

---

Do not push the knob sideways with strong force. Doing so may break the knobs.

---

#### French

---

### ATTENTION

---

Ne pas enfoncer les boutons latéralement en employant une force excessive. Cela pourrait les endommager, voire les casser.

---

## 1.3 Screens

### Normal Waveform Display

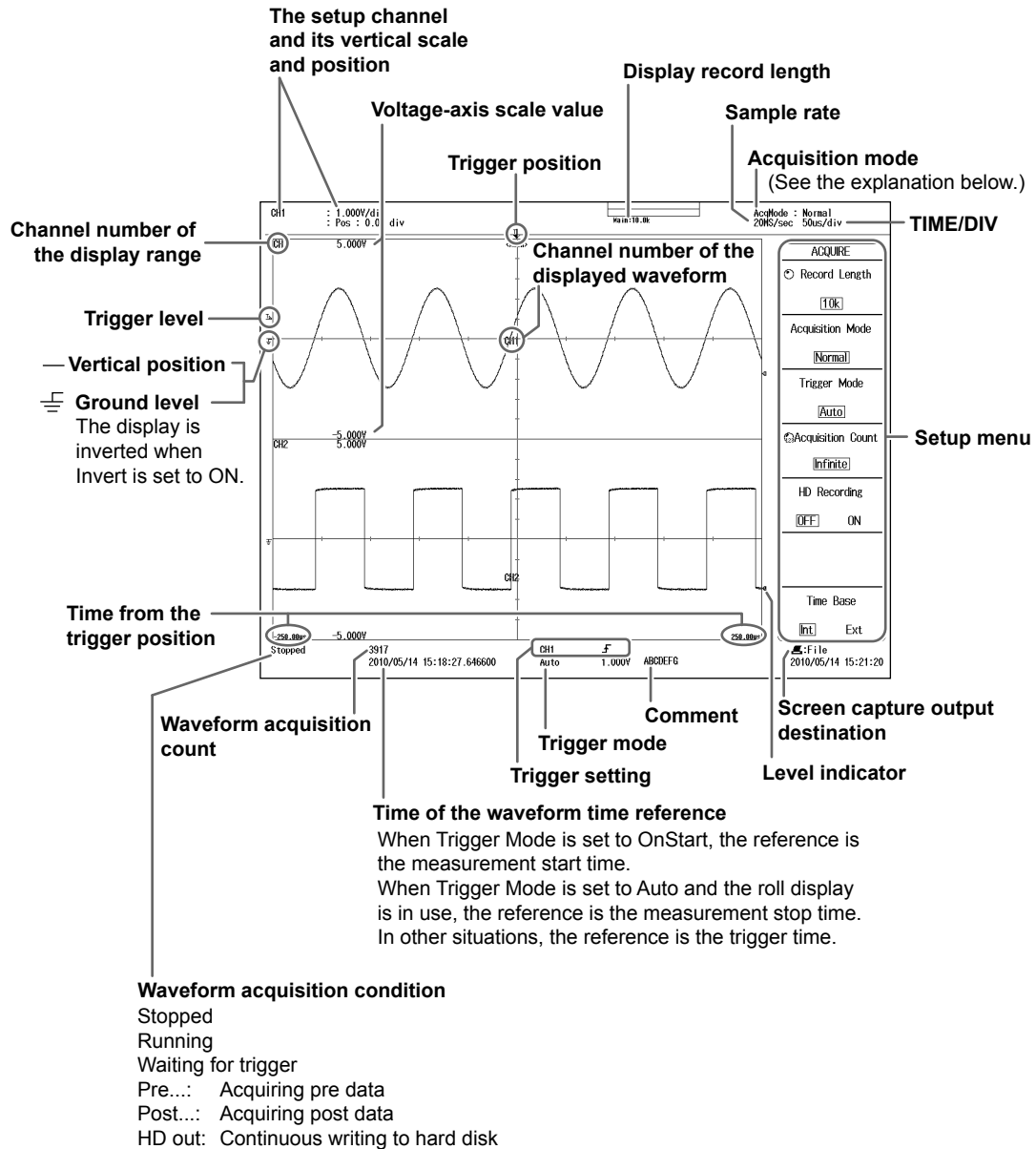

### Acquisition Mode Indication

Normal: Normal mode  
Env: Envelope mode  
Avg: Average mode  
BoxAvg: Box average mode

#### Note

The DL850E/DL850EV LCD may include a few defective pixels. For details, see section 6.4, "Display."

## Zoom Waveform Display

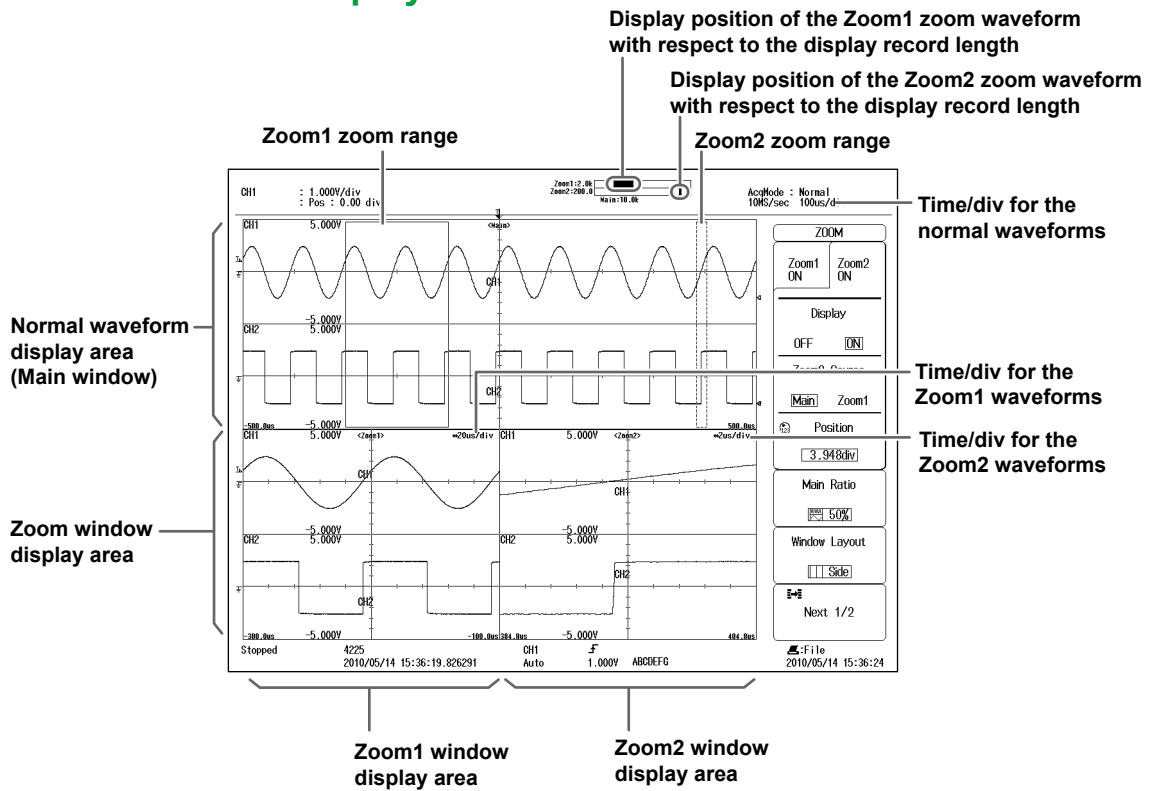

## Dual Capture Display

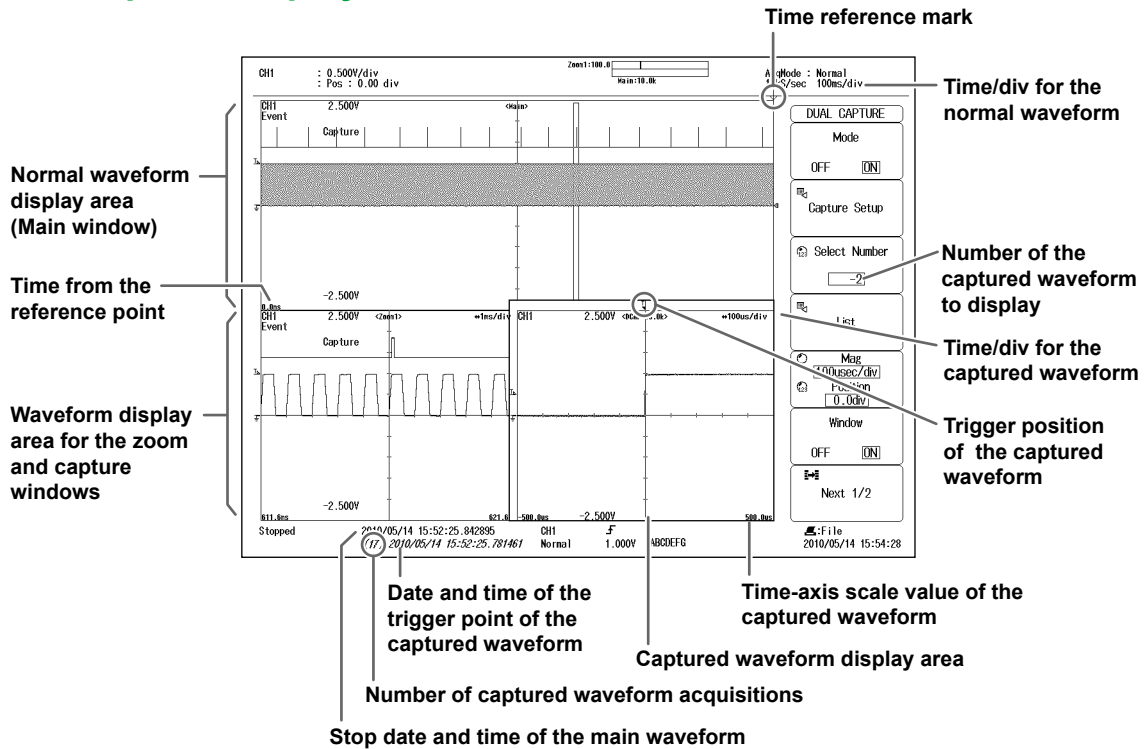



# 1.4 System Configuration

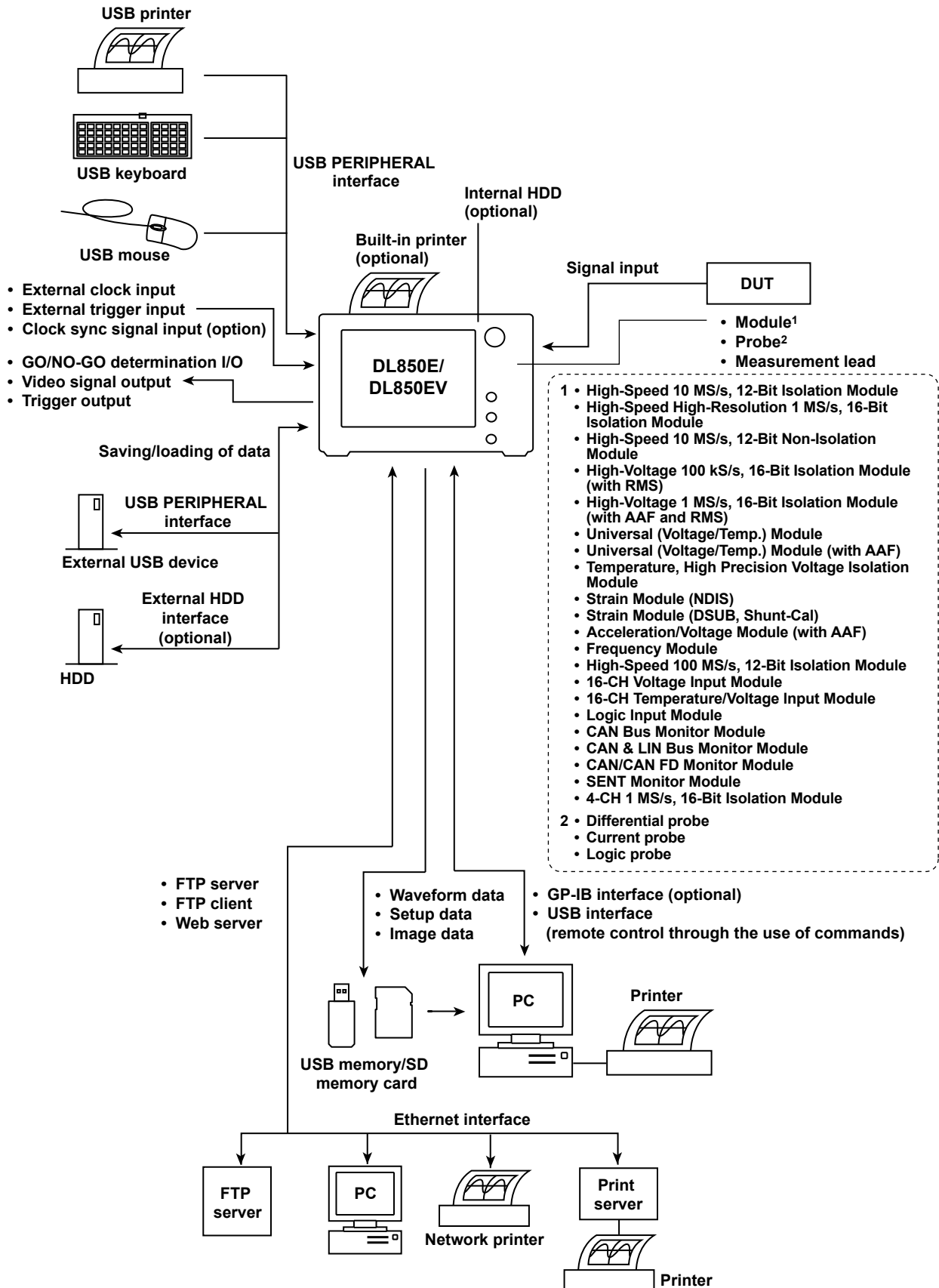

## 2.1 Vertical and Horizontal Axes

### Vertical Axis

This section explains how to configure the signal input settings and the amplitude-direction display settings. The items that can be set vary depending on the installed modules. The channel menu that corresponds to the key you pressed (CH1 to CH16) appears. You can set the various vertical axis settings for each channel. Press ALL CH to display a screen in which you can configure the settings of all channels while viewing the settings in a list.

### DL850E/DL850EV Measurement Items

When the DL850E/DL850EV is equipped with the modules listed below, it can measure voltage, temperature, strain, acceleration, frequency, logic, CAN bus signals, LIN bus signals, SENT signals, and so on.

#### Voltage

701250 (HS10M12), 720250 (HS10M12), 701251 (HS1M16), 701255 (NONISO\_10M12), 701267 (HV (with RMS)), 720268 (HV (AAF, RMS)), 720210 (HS100M12), 720211 (HS100M12), 701261 (UNIVERSAL), 701262 (UNIVERSAL (AAF)), 701265 (TEMP/HPV), 720266 (TEMP/HPV), 701275 (ACCL/VOLT), 720254 (4CH 1M16)

#### Voltage (For the 16-CH Voltage Input Module)

720220 (16CH VOLT)

#### Temperature

701261 (UNIVERSAL), 701262 (UNIVERSAL (AAF)), 701265 (TEMP/HPV), 720266 (TEMP/HPV)

#### Temperature (For the 16-CH Temperature/Voltage Input Module)

720221 (16CH TEMP/VOLT)

#### Strain

701270 (STRAIN\_NDIS), 701271 (STRAIN\_DSUB)

#### Acceleration

701275 (ACCL/VOLT)

#### Frequency

701281 (FREQ), 720281 (FREQ)

#### Logic

720230 (LOGIC)

#### CAN Bus Signal Monitoring

720240 (CAN MONITOR), 720241 (CAN & LIN), 720242 (CAN/CAN FD)

This module can only be used with the DL850EV.

#### LIN Bus Signal Monitoring

720241 (CAN & LIN)

This module can only be used with the DL850EV.

#### CAN FD Bus Signal Monitoring

720242 (CAN/CAN FD)

This module can only be used with the DL850EV.

#### SENT Signal Monitoring

720243 (SENT)

This module can only be used with the DL850EV.

### Vertical Scale

The vertical scale is used to adjust the displayed waveform amplitude so that you can easily view signals. You can set the vertical scale to determine the value per grid square (1 div) displayed on the screen and to set the measurement range.

Use the SCALE knob to set the vertical scale for each channel.

### Vertical Position

Because the DL850E/DL850EV can display many waveforms, the waveforms may overlap and be difficult to view. If this happens, you can adjust the vertical display position to make waveforms easier to view (vertical position).

Use the POSITION knob to set the vertical position for each channel.

### Input Coupling

You can change the input coupling setting to match the signal that you are measuring. By changing the setting, you can choose how the vertical-axis (voltage-axis) control circuit is coupled to the input signal. The following types of input coupling are available: DC, AC, GND, TC, DC-RMS, AC-RMS, ACCEL, and OFF.\* Set the appropriate input coupling for each input module.

- \* You can only select OFF for sub channels on the 16-CH voltage input module or the 16-CH temperature/voltage input module. Sub channels set to OFF are not measured.

### Vertical Zoom

You can zoom the waveform vertically. You can zoom the waveform by setting the vertical magnification or by setting upper and lower display limits.

### Linear Scaling

Linear scaling is a function that converts measured values into physical values and reads them directly. There two types of linear scaling:

#### AX + B

Using scaling coefficient A and offset B, the DL850E/DL850EV scales values according to the equation below.

$Y = AX + B$  (where X is the measured value and Y is the physical value)

#### P1-P2

The DL850E/DL850EV determines the scale conversion equation ( $y = ax + b$ ) using four values that you specify: two measured values (P1:X, P2:X) and the value that each one should be converted to (P1:Y, P2:Y).

The DL850E/DL850EV scales values using the scale conversion equation that it determines.

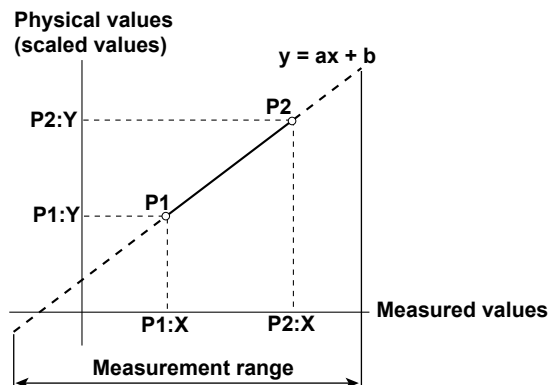

## Horizontal Axis (Time Axis)

### Time Axis Setting

Normally, under the initial settings, the time axis scale is set as a length of time per grid division (1 div). The selectable range is 100 ns/div to 20 days/div. As you adjust the value, the unit changes between seconds, minutes, hours, and days automatically. Because the horizontal display range is 10 div, the amount of time on the waveform that is displayed is equal to the time axis setting  $\times$  10.

\* If a 720210 (HS100M12) or 720211 (HS100M12) module is installed, the lowest setting is 100 ns/div. Otherwise, it is 1  $\mu$ s/div.

### Internal and External Clocks (Time base selection)

Under the initial settings, the DL850E/DL850EV samples the measured signal using the internal clock signal produced by its internal time-base circuit.

You can also use an external clock signal to control sampling. Apply the external clock signal to the external clock input terminal. This external clock input is useful for synchronizing to the clock signal of the waveform that is being measured.

### Relationship between the Time Axis Setting, Record Length, and Sample Rate

If you change the time axis setting, the sample rate and the acquisition-memory record length also change. For details, see appendix 1.

#### Sample Rate

If you change the time axis setting, the sample rate also changes. The sample rate is the number of samples-per-second (S/s). When the sample rate is low compared to the frequency of the input signal, the high-frequency components of the waveform are misread as low-frequency components. To prevent the high-frequency components from being misread, sample the signal at the highest sample rate possible, or set the waveform acquisition mode to Envelope.

#### Roll Mode Display

When the trigger mode is Auto, Auto Level, Single, or On Start and the time axis setting is 100 ms/div or longer, instead of updating waveforms through triggering (update mode), the DL850E/DL850EV displays the waveforms in roll mode. In roll mode, waveforms scroll from right to left as new data is captured and the oldest values are deleted from the screen.

## 2.2 Triggering

A trigger is a cue used to display the waveform on the screen. A trigger occurs when the specified trigger condition is met, and a waveform is displayed on the screen.

### Trigger Modes

The trigger mode determines the conditions for updating the displayed waveforms. There are six trigger modes: Auto, Auto Level, Normal, Single, N Single, and On Start. The trigger mode setting applies to all trigger types.

### Trigger Types

Triggers can be broadly divided into “simple triggers” and “enhanced triggers.”

#### Simple Triggers

##### Input Signal Trigger

The DL850E/DL850EV triggers when the trigger source passes through the specified trigger level in the specified way (rising edge, falling edge, or rising or falling edge).

##### Time Trigger

The DL850E/DL850EV triggers at the specified date and time and at specified intervals afterwards.

##### External Signal Trigger

The DL850E/DL850EV triggers when the signal applied to the TRIG IN terminal passes through the specified trigger level in the specified way (rising or falling edge).

##### Power Line Signal Trigger

The DL850E/DL850EV triggers on the rising edge of the power supply signal that it is receiving. This trigger enables you to observe waveforms in synchronization with the power supply frequency.

#### Enhanced Triggers

##### A -> B(N) Trigger

After state condition A is met, the DL850E/DL850EV triggers when state condition B is met N times.

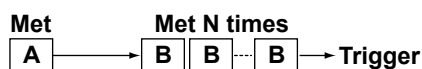

##### A Delay B Trigger

After state condition A is met and the specified amount of time elapses, the DL850E/DL850EV triggers when state condition B is first met.



**Edge On A Trigger (Enhanced)**

While state condition A is met, the DL850E/DL850EV triggers on the OR of multiple trigger source edges.

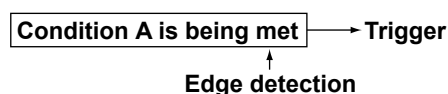
**OR Trigger**

The DL850E/DL850EV triggers on the OR of multiple trigger source edges.

**AND Trigger**

The DL850E/DL850EV triggers on the AND of multiple trigger source conditions. The DL850E/DL850EV triggers when all the specified conditions are met at a single point.

**Period Trigger**

The DL850E/DL850EV triggers on a specified period of occurrence of state condition B. The DL850E/DL850EV triggers when state condition B occurs again.

**Pulse Width Trigger**

The DL850E/DL850EV triggers according to the relationship between the state condition B achievement time and the specified reference times (Time or T1 and T2).

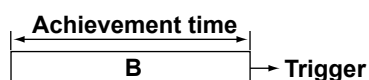
**Wave Window Trigger**

The DL850E/DL850EV creates real-time templates (Wave Window) using a number of cycles directly preceding the current waveforms. The DL850E/DL850EV compares the current waveforms to the real-time templates and triggers if one of the current waveforms falls outside of its real-time template.

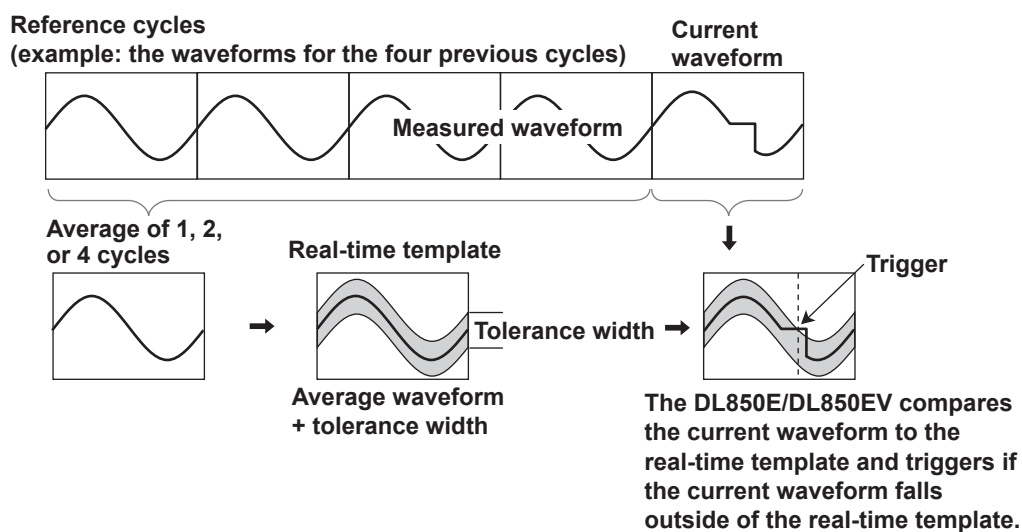

### Trigger Source

*Trigger source* refers to the signal that is used to check the specified trigger conditions. You can set the trigger source to an analog signal, logic signal, realtime math signal, time, external signal, or power line signal. Select the appropriate trigger source for the trigger type.

### Trigger Level

*Trigger level* refers to the signal level used as a reference for detecting a signal's rising and falling edges or high and low states. With simple triggers such as the edge trigger, the DL850E/DL850EV triggers when the trigger source level passes through the specified trigger level. The range and resolutions that you can use to set the trigger level vary depending on the type of signal being measured.

### Trigger Slope

*Slope* refers to the movement of the signal from a low level to a high level (rising edge) or from a high level to a low level (falling edge). When a slope is used as one of the trigger conditions, it is called a trigger slope.

### Trigger Hysteresis

When the trigger source is an analog signal, you can set a width (hysteresis) to the trigger level so that the DL850E/DL850EV does not detect edges when the signal level changes within the specified width. You can set the hysteresis around the trigger level for each type of measured signal.

### Trigger Hold-off

The trigger hold-off feature temporarily stops the detection of the next trigger once a trigger has occurred. This feature is useful in cases when you want to change the waveform acquisition interval, such as when you are observing a PCM (pulse code modulation) code or other pulse train signal or when you are using the history feature.

### Trigger Position

When you move the trigger position, the ratio of the displayed data before the trigger point (pre-data) to the data after the trigger point (post-data) changes. When the trigger delay is 0 s, the trigger point and trigger positions coincide.

### Trigger Delay

The DL850E/DL850EV normally displays waveforms before and after the trigger point. You can set a trigger delay to display waveforms at a specified amount of time after the trigger occurrence.

## 2.3 Waveform Acquisition

Based on the data that has been stored in the acquisition memory, the DL850E/DL850EV performs various operations, such as displaying waveforms on the screen, computing, measuring cursors, and automatically measuring waveform parameters.

You can set the number of data points to store in the acquisition memory (the record length), enable or disable the sample data averaging feature, and so on.

### Record Length

*Record length* refers to the number of data points that are stored to the acquisition memory for each channel. *Display record length* refers to the data points from the data stored in the acquisition memory that are displayed on the screen. Normally, the acquisition-memory record length and display record length are the same, but the time axis setting may cause them to differ. When you change the time axis setting, the sample rate and record length also change.

On the standard model of the DL850E/DL850EV, you can set the record length to a value between 1 kpoint and 250 Mpoint. Depending on the model, you can set the record length to a value of up to 2 Gpoint.

### Acquisition Mode

Specify how the DL850E/DL850EV processes the sampled data, stores it in the acquisition memory, and uses it to display waveforms. There are four acquisition modes: Normal, Envelope, Averaging, and BoxAverage.



## Hard Disk Recording

When measurement starts, you can record data to an external hard disk that supports eSATA (external Serial ATA; /HD0 option\*) or to an internal hard disk (/HD1 option). The recorded data is saved to files automatically.

- \* Models with the /HD0 option are equipped with eSATA connectors. You need to purchase a hard disk that supports eSATA separately. Note that hard disks that can be used are those whose disk partition style is MBR and the format is FAT32.

### Hard disk recording

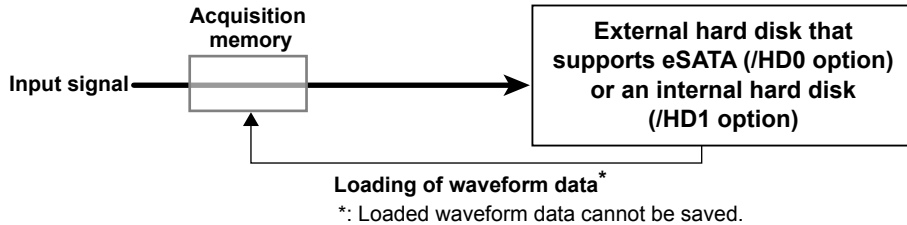

### Normal measurement



### CAUTION

Do not store more than 512 files in the root directory of the internal hard disk. Doing so will slow the file access operations to all files. In addition, we cannot guarantee the operation of the hard disk recording feature when the DL850E/DL850EV is in this state.

### French



### ATTENTION

Ne pas stocker plus de 512 fichiers dans le répertoire racine du disque dur interne. Ceci ralentit les opérations d'accès à tous les fichiers. En outre, nous ne pouvons pas garantir le fonctionnement de la fonction d'enregistrement sur disque dur lorsque le DL850E/DL850EV est dans cet état.

## History

When waveforms are being measured, the waveform data stored in the acquisition memory as a result of a trigger occurrence is displayed as a waveform on the DL850E/DL850EV screen and can be viewed. When waveform acquisition is being triggered in succession and an abnormal waveform appears, it is impossible to stop acquisition before a new waveform appears on the screen. Normally, it would be impossible to view the abnormal waveform. However, with the history feature, you can view the past waveform data (history waveforms) stored in the acquisition memory when waveform acquisition is stopped. You can select specific history waveforms and display them.

You can also search through the history waveforms for waveforms that meet specified conditions.

- **Zone Search**  
The DL850E/DL850EV searches for history waveforms that passed (or did not pass) through a specified search zone.
- **Waveform Parameter Search**  
The DL850E/DL850EV searches for waveforms whose measured waveform parameter values meet (or do not meet) specified conditions.

### Zone Search

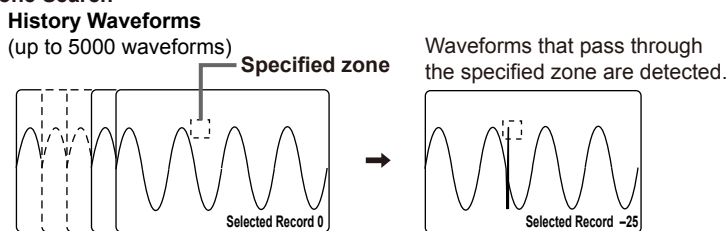

### Waveform parameter search

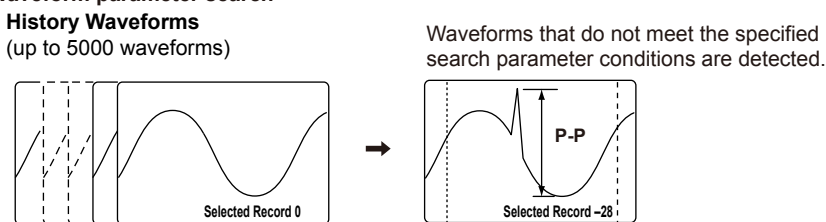

## Dual Capturing

You can use dual capturing to simultaneously record a trend at a low sampling speed in roll mode and at a high sampling rate. This is useful for capturing fast phenomenon while observing a trend over a long period of time.

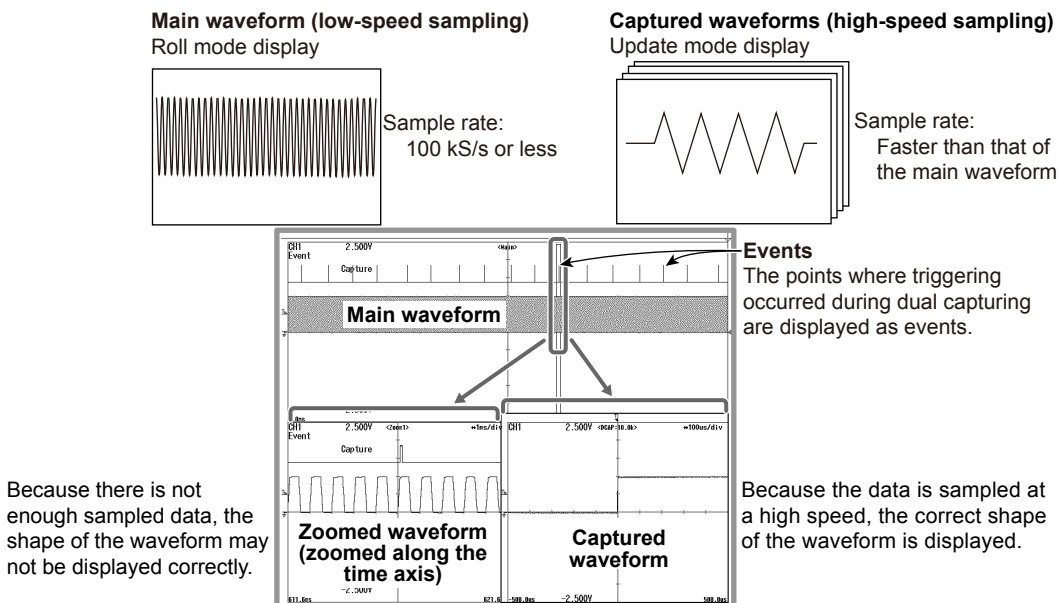

## 2.4 Waveform Display

The DL850E/DL850EV has a main window for displaying normal time-domain waveforms, zoom windows for displaying zoomed time-axis waveforms, and X-Y windows for displaying X-Y waveforms. In addition, you can split screens and change the sizes of waveform display areas so that waveforms and measured values are easier to see and display an FFT window that shows the results of FFT analysis.

### Zooming along the Time Axis (GIGAZoom)

You can magnify displayed waveforms along the time axis. The zoomed waveforms of two locations can be displayed simultaneously (the dual zoom feature). This feature is useful when you set a long acquisition time and want to observe a portion of the waveform closely.

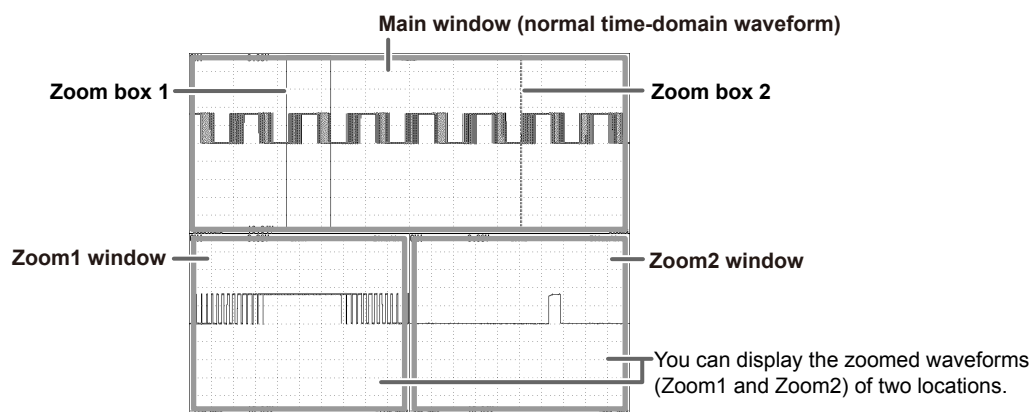

### Displaying X-Y Waveforms

You can observe the correlation between two waveform signal levels by displaying one signal level on the X-axis (horizontal axis) and a second signal level on the Y-axis (vertical axis). You can display X-Y waveforms at the same time as normal T-Y (time and signal level) waveforms. You can display up to four overlapping X-Y waveforms in both Window1 and Window2. Because multiple X-Y waveforms can be displayed, it is easy to compare the relationships between phases. You can use this feature to evaluate DC motors using Lissajous waveforms.

### Snapshot

You can continue displaying a waveform on the screen as a snapshot waveform after the screen has been updated and the waveform has been cleared in update mode or after the waveform has left the screen in roll mode. Snapshot waveforms appear in white. You can compare them with new waveforms. You can also save and print snapshot waveforms as screen captures.

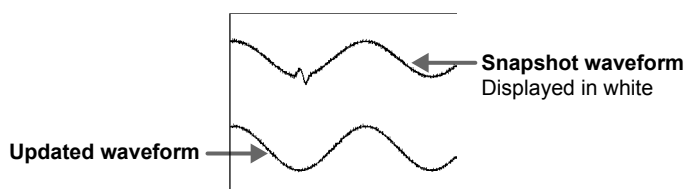

## 2.5 Waveform Computation and Analysis

### Waveform Computation

You can perform basic arithmetic, binarization, FFT (power spectrum), and phase shifting (display the waveform with its phase shifted). On models with the /G2 option, you can use a rich variety of functions (square root, trigonometric functions, differentiation, integration, digital filtering, six types of FFT functions, and so on) to define up to eight equations.

**Expression configuration dialog box**  
Use the soft keyboard on the screen to enter an expression.

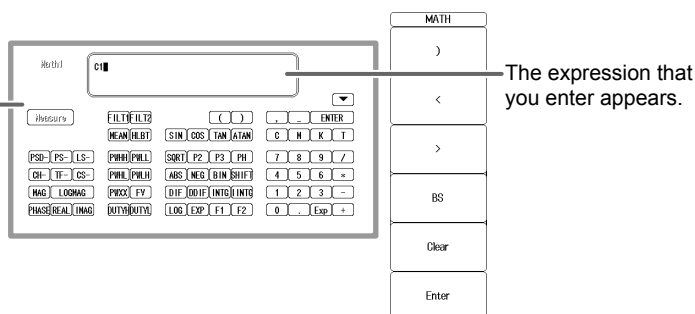

### Cursor Measurement

There are cursors for T-Y (time-axis), X-Y, and FFT waveforms. You can position a cursor over a waveform to view the various measured values at the intersection of the cursor and the waveform.

### Automated Measurement of Waveform Parameters

You can use this feature to automatically measure waveform levels, maximum values, frequencies, and other values. For waveform data, you can measure 29 waveform parameters (including the delay between channels) that relate to the voltage axis, time axis, and waveform area.

- You can display a total of 32 measured values for all the waveforms.
- You can save a total of 64000 items of data for all the waveforms.
- You can also perform computations on measured waveform parameter values.
- You can display the following statistics for the specified waveform parameter.

The maximum value (Maximum), minimum value (Minimum), average value (Average), standard deviation (SDev), and number of measured values used to calculate statistics (Count)

Setup Dialog Box

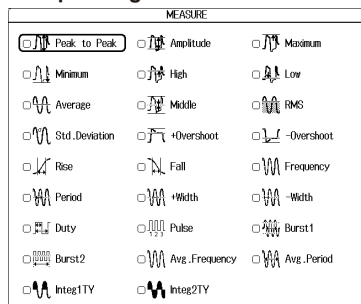

Example of Displayed Statistical Values

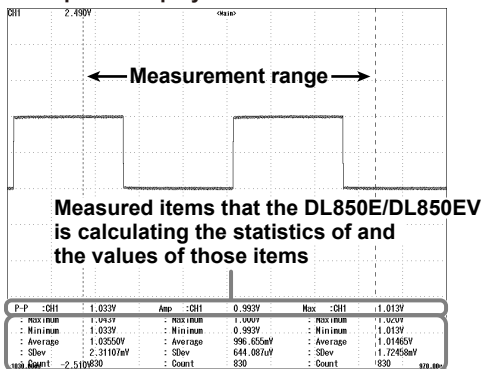

Maximum: Maximum value      Minimum: Minimum value  
Average: Average value      SDev: Standard deviation  
Count: Number of measured values used to calculate statistics

## 2.5 Waveform Computation and Analysis

---

There are three statistical processing methods:

- Normal statistical processing  
While acquiring waveforms, the DL850E/DL850EV measures the measurement items and calculates the statistics of the waveforms that it has acquired so far.
- Cyclic statistical processing (measurement and statistical processing are performed for each period)  
The DL850E/DL850EV divides the waveform into periods starting at the left side of the screen (the oldest waveform) and moving to the right side of the screen, measures the selected measurement items within each period, and performs statistical processing on the measurement items.
- Statistical processing of history waveforms  
The DL850E/DL850EV measures the measurement items and calculates the statistics of history waveforms. Measurement and statistical processing begin with the oldest waveform.

### GO/NO-GO Determination

This feature is useful for signal testing on production lines and for tracking down abnormal phenomena. The DL850E/DL850EV determines whether the waveform enters the specified range. When the DL850E/DL850EV returns a GO (or NO-GO) result, specified actions are performed.

#### Determination Methods

- Waveform Zone  
The DL850E/DL850EV returns GO/NO-GO results based on whether waveforms leave or enter the zone that you create using a base waveform.

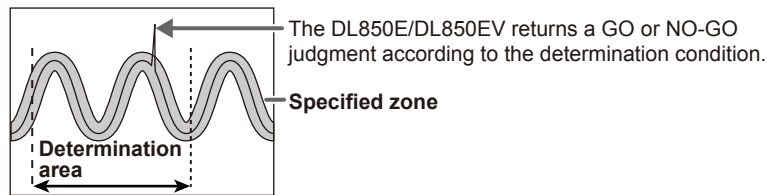

- Waveform Parameter  
Set the upper and lower limits for automated measurement values of waveform parameters. The DL850E/DL850EV performs GO/NO-GO determination based on whether the values are within or outside of the limits.

#### Actions Performed according to Determination Results

The DL850E/DL850EV can print and save screen captures, save waveform data, beep, and send e-mails according to the results of GO/NO-GO determination.

## 3.1 Handling Precautions

### Safety Precautions

If you are using this instrument for the first time, make sure to thoroughly read the safety precautions given on page xiii.

#### Do Not Remove the Case

Do not remove the case from the instrument. Some sections inside the instrument have high voltages and are extremely dangerous. For internal inspection and adjustment, contact your nearest YOKOGAWA dealer.

#### Unplug If Abnormal Behavior Occurs

If you notice smoke or unusual odors coming from the instrument, immediately turn off the power and unplug the power cord. If such an irregularity occurs, contact your dealer.

#### Do Not Damage the Power Cord

Nothing should be placed on the power cord. The cord should be kept away from any heat sources. When unplugging the power cord from the outlet, never pull by the cord itself. Always hold and pull by the plug. If the power cord is damaged or if you are using the instrument in a location where the power supply specifications are different, purchase a power cord that matches the specifications of the region that the instrument will be used in.

#### Operating Environment and Conditions

This instrument complies with the EMC standard under specific operating environment and operating conditions. If the installation, wiring, and so on are not appropriate, the compliance conditions of the EMC standard may not be met. In such cases, the user will be required to take appropriate measures.

### General Handling Precautions

#### Do Not Place Objects on Top of the Instrument

Never place other instruments or objects containing water on top of the instrument, otherwise a breakdown may occur.

#### Do Not Apply Shock or Vibration

Do not apply shock or vibration. Doing so may damage the instrument. Extra caution is needed for the optional internal hard disk, because it is sensitive to vibration and shock. Shocks to the input connectors or probes may turn into electrical noise and enter the instrument via the signal lines.

#### Do Not Damage the LCD

Since the LCD screen is very vulnerable and can be easily scratched, do not allow any sharp objects near it. Also it should not be exposed to vibrations and shocks.

#### Unplug during Extended Non-Use

Unplug the power cord from the outlet.

### 3.1 Handling Precautions

---

#### When Carrying the Instrument

Remove the power cord and connecting cables. When moving the instrument, use the handle as shown below, or carry it with both hands.

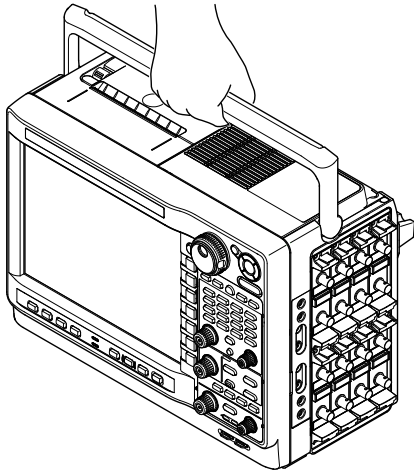

---

#### WARNING

- When you hold or put away the handle, be careful not to get your hand caught between the handle and the case.
- When you carry the instrument, be careful not to get your hand caught between the wall, installation surface, or other objects and the instrument.

---

#### French

---

#### AVERTISSEMENT

- Lorsque vous attrapez ou rabattez la poignée, veillez à ne pas vous coincer la main entre la poignée et l'instrument.
- Lorsque vous déplacez l'instrument, veillez à ne pas vous coincer la main entre l'instrument et le mur, la surface d'installation ou tout autre objet.

#### Cleaning

When cleaning the case or the operation panel, first remove the power cord from the AC outlet. Then, wipe with a dry, soft, clean cloth. Do not use chemical such as benzene or thinner. These can cause discoloring and deformation.

## 3.2 Installing the Instrument

### WARNING

- Do not install the instrument outdoors or in locations subject to rain or water.
- Install the instrument so that you can immediately remove the power cord if an abnormal or dangerous condition occurs.

### CAUTION

If you block the inlet or outlet holes on the instrument, the instrument will become hot and may break down.

### French

### AVERTISSEMENT

- Ne pas installer l'instrument à l'extérieur ou dans des lieux exposés à la pluie ou à l'eau.
- Installer l'instrument de manière à pouvoir immédiatement le débrancher du secteur en cas de fonctionnement anormal ou dangereux.

### ATTENTION

Ne pas boucher les orifices d'entrée ou de sortie de l'instrument pour éviter toute surchauffe et panne éventuelle.

## Installation Conditions

Install the instrument in a place that meets the following conditions.

### Flat, Even Surface

Install the instrument in the correct orientation (see page 3-5) in a safe place, with no tilting from front to back or left to right. When you install the instrument with the rear panel facing down, you can tilt it on its stand. The recording quality of the printer may be hindered when the instrument is placed in an unstable or inclined place.



## 3.2 Installing the Instrument

---

### Well-Ventilated Location

There are inlet holes on the bottom side of the instrument. There are also vent holes for the cooling fan on the left side panel and the top panel. To prevent internal overheating, allow for enough space around the instrument (see the figure below) and do not block the inlet and exhaust holes.

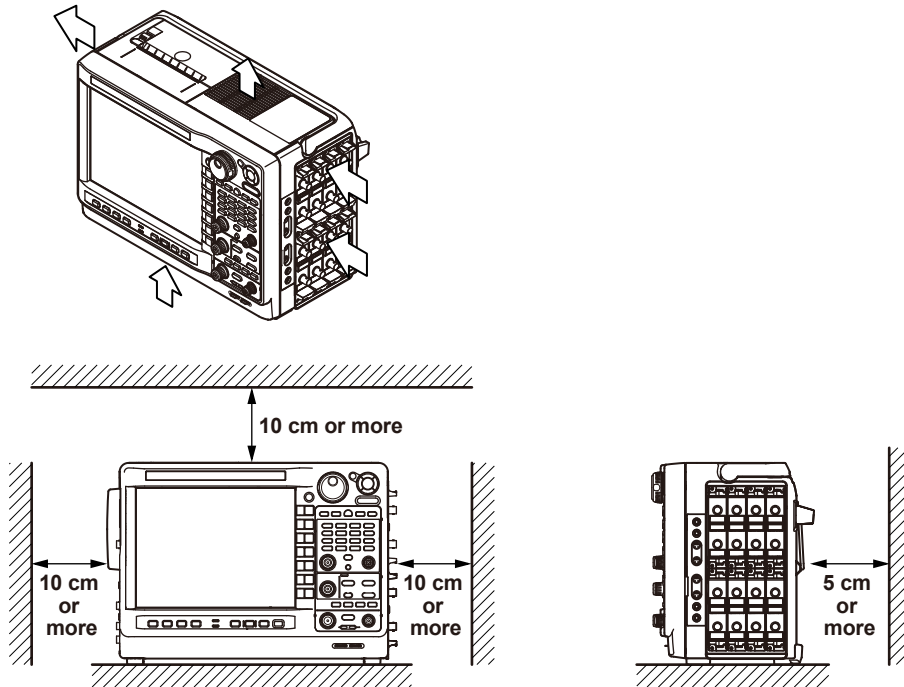

When connecting cables and opening and closing the cover of the built-in printer, provide extra operating space in addition to the space in the figure shown above.

### Ambient Temperature and Humidity

Ambient temperature: 5 to 40°C

Ambient humidity: 20 to 80% RH (when the printer is not used; no condensation)

35 to 80% RH (when the printer is used)

#### Note

- To ensure high measurement accuracy, operate the instrument in the 23 ±5°C temperature range and 20 to 80% RH.
  - Condensation may occur if the instrument is moved to another place where the ambient temperature is higher, or if the temperature changes rapidly. In such cases, allow the instrument adjust to the new environment for at least an hour before using the instrument.
- 

### Do not install the instrument in the following places.

- Outdoors.
- In direct sunlight or near heat sources.
- Where the instrument is exposed to water or other liquids.
- Where an excessive amount of soot, steam, dust, or corrosive gas is present.
- Near strong magnetic field sources.
- Near high voltage equipment or power lines.
- Where the level of mechanical vibration is high.
- On an unstable surface.

## Installation Position

Install the instrument so that it is flat or with the rear panel facing down. When using the stand as shown in the bottom right figure, push it out until it locks into place. Push the stand back in when you store the instrument.

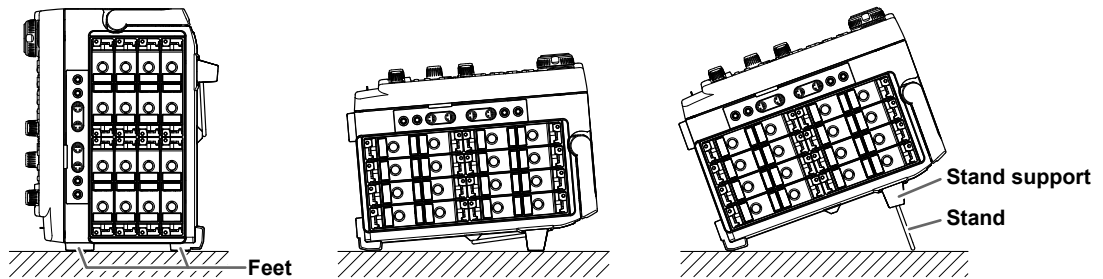

### WARNING

- When you put away the stand, be careful not to get your hand caught between the stand and the instrument.
- Handling the stand without firmly supporting the instrument can be dangerous. Please take the following precautions.
  - Only handle the stand when the instrument is on a stable surface.
  - Do not handle the stand when the instrument is tilted.
- Do not place the instrument in any position other than those shown in the above figures. Also, do not stack the instrument.

### CAUTION

Do not apply excessive force or shock to the stand. Doing so may break the stand support.

### French

### AVERTISSEMENT

- Lorsque vous rabattez le support, veillez à ne pas vous coincer la main entre le support et l'instrument.
- Lorsque vous manipulez le support, soutenez toujours l'instrument fermement. Prenez les précautions suivantes.
  - Ne manipulez le support que lorsque l'instrument est placé sur une surface stable.
  - Ne manipulez pas le support lorsque l'instrument est incliné.
- Ne pas placer l'instrument dans des positions autres celles indiquées ci-dessus. Ne pas empiler l'instrument.

### ATTENTION

Évitez d'appliquer une force excessive ou des chocs sur le support. Le système de soutien du support peut se casser.

## Rubber Stoppers

The supplied rubber stoppers can be attached to the feet of the instrument to prevent the instrument from sliding.

## 3.3 Installing Input Modules



### WARNING

- To prevent electric shock and damage to the instrument, be sure to turn the power off before you install or remove input modules.
- Check that the input cable is not connected to the input terminals before installing or removing the input module.
- To prevent electric shock and to satisfy the specifications, make sure to put the accessory cover panel on the slots that are not being used.  
Using the instrument without the cover panel allows the dust to enter the instrument and may cause malfunction due to the rise in temperature inside the instrument.
- If the input module happens to come out of the slot while it is in use, it may cause electric shock or cause damage to the instrument as well as the input module. Make sure to screw the input module in place at the two locations (top and bottom).
- There are protrusions in the slot. Do not put your hand in the slot. If you put your hand in the slot, the protrusions may cut your hand.
- Use the accessories of this product within the rated range of each accessory (see page ix). When using several accessories together, use them within the specification range of the accessory with the lowest rating.

#### Precautions to Be Taken When Using the Modules

- Do not apply input voltage exceeding the maximum input voltage or maximum rated voltage to earth.
- To avoid electric shock, be sure to ground the instrument.
- To prevent the possibility of electric shock, be sure to fasten the module screws. Failing to do so is extremely dangerous, because the electrical and mechanical protection functions will not be activated.
- Avoid continuous connection under an environment in which the surge voltage may occur.
- To measure high voltage with the 720210 (HS100M12), 720211 (HS100M12), 701250 (HS10M12), 720250 (HS10M12), 701251 (HS1M16), or 720254 (4CH 1M16), use the isolated probes (700929, 701947), passive probes 702902, 1:1 safety cables (combination of 701901 and 701954), or differential probes (700924, 700925, 701926).
- Be sure to connect the GND lead of the differential probe (the 700924, 700925 and 701926) to the functional ground terminal of the DL850E/DL850EV before you connect to the device under measurement. High voltage may appear at the BNC connector of the differential probe.
- The protection functions and non-isolation functions of the 701255 (NONISO\_10M12) are enabled when the module screws are tightened. It is extremely dangerous if you do not fasten the screws. Also, when you measure high voltages above 42 V, be sure to use the passive probe for the DL850E/DL850EV (the 701940).
- The BNC portion of the 10 MHz passive probe 701940 is metal, so if you use it with isolated input (the 720210 (HS100M12), 720211 (HS100M12), 701250 (HS10M12), 720250 (HS10M12), 701251 (HS1M16), 701275 (ACCL/VOLT), 701281(FREQ), 720281(FREQ)), or 720254 (4CH 1M16), for safety, be sure to only use it with voltages at or below 42 V. (Do not connect voltage above 42 V to both the High and Low sides.)
- When measuring high voltages using the 701267 (HV (with RMS)) or 720268 (HV (AAF, RMS)) use a measurement lead (combination of 758933 and 701954) or 1:1 safety cable (combination of 701904 and 701954).
- The measurement category of 701267 (HV (with RMS)) when used with 758933 measurement leads and 701954 alligator clips or 1:1 safety cable 701904 and 701954 alligator clips is 400V-CAT II on the low side and 700V-CAT II on the high side. Be careful because the overvoltage tolerance between the low and high sides is different.
- To measure high voltage with the 701281 (FREQ) or 720281 (FREQ), use an isolated probe (700929, 701947) or passive probe 702902.
- The protection functions and non-isolation functions of the 720230 (LOGIC) are enabled when the module screws are tightened. It is extremely dangerous if you do not fasten the screws. Also, be sure to only use a recommended YOKOGAWA logic probe (700986, 700987, 702911, or 702912) with the logic module.

## French

**AVERTISSEMENT**

- Pour éviter tout risque de choc électrique et d'endommagement de l'instrument, veiller à mettre l'instrument hors tension avant d'installer ou de retirer des modules d'entrée.
- Avant d'installer ou de retirer des modules d'entrée, vérifier que le câble d'entrée n'est pas connecté aux bornes d'entrée.
- Pour éviter tout risque de choc électrique et respecter les spécifications, penser à recouvrir les slots qui ne sont pas utilisés à l'aide du cache de recouvrement prévu à cet effet. L'utilisation de l'instrument sans le cache de recouvrement favorise l'introduction de poussière dans l'instrument et peut entraîner un dysfonctionnement due à une température excessive à l'intérieur de l'instrument.
- Si le module d'entrée venait à sortir de son slot pendant son utilisation, cela pourrait entraîner un choc électrique ou endommager l'instrument et le module d'entrée. Veiller à bien visser le module d'entrée aux deux emplacements prévus (haut et bas).
- Les sots présentent des rebords en saillie. Ne pas insérer les doigts dans les slots, car les saillies pourraient vous blesser.
- Utilisez les accessoires de ce produit en fonction des valeurs nominales de chacun (reportez-vous à la page ix). Lorsque vous employez plusieurs accessoires en même temps, utilisez les valeurs de l'accessoire ayant les valeurs nominales les plus faibles.

**Précautions à prendre lors de l'utilisation des modules**

- Ne pas dépasser les valeurs maximales de tension d'entrée, de tension nominale maximale à la terre.
- Pour éviter tout risque de choc électrique, l'instrument doit impérativement être relié à la terre.
- Pour éviter tout risque de choc électrique, toujours serrer les vis des modules, à défaut de quoi les fonctions de protection électrique et de protection mécanique ne seront pas activées.
- Éviter les connexions continues dans les environnements pouvant être soumis à surtension.
- Pour mesurer la tension élevée avec 720210 (HS100M12), 720211 (HS100M12), 701250 (HS10M12), 720250 (HS10M12), 701251 (HS1M16) ou 720254 (4CH 1M16), utiliser des sondes isolées (700929, 701947), des sondes passives 702902, des câbles de sécurité 1:1 (combinaison de 701901 et 701954) ou des sondes différentielles (700924, 700925, 701926).
- Bien relier le fil de terre de la sonde différentielle (700924, 700925, 701926) à la borne de mise à la terre opérationnelle, sur le panneau droit de DL850E/DL850EV avant de le relier à la cible de la mesure. Le fait de ne pas respecter cette consigne risque d'entraîner l'apparition d'une tension élevée au niveau du connecteur BNC de la sonde différentielle.
- Lors de l'utilisation du 701255 (NONISO\_10M12), veillez à serrer les vis du module. Le serrage des vis de module active la fonction de protection et celle de non-isolation. La situation est extrêmement dangereuse lorsque les vis ne sont pas serrées. Lorsque vous mesurez des hautes tensions supérieures à 42 V, veillez également à utiliser la sonde passive 701940.
- La partie BNC de la sonde passive 701940 est en métal ; si vous l'utilisez avec l'entrée isolée (la 720210 (HS100M12), 720211 (HS100M12), 701250 (HS10M12), 720250 (HS10M12), 701251 (HS1M16), 701275 (ACCL/VOLT), 701281 (FREQ), 720281 (FREQ) ou 720254 (4CH 1M16)), veillez à l'utiliser uniquement à des tensions inférieures ou égales à 42 V pour des raisons de sécurité (ne reliez pas une tension supérieure à 42 V sur les côtés Haut et Bas).
- Lorsque vous appliquez de hautes tensions au 701267 (HV (avec RMS)) ou 720268 (HV (AAF, RMS)), utilisez un cordon de mesure (combinaison de 758933 et 701954) ou des câbles de sécurité 1:1 (combinaison de 701904 et 701954).
- La catégorie de mesure du 701267 (HV (avec RMS)) lorsqu'il est utilisé avec les fils de mesure 758933 et les pinces crocodiles 701954 ou le câble de sécurité 1:1 701904 et les pinces crocodiles 701954 est CAT II - 400 V pour le bas et CAT II - 700 V pour le haut. Procéder avec soin, car la tolérance de surtension diffère entre le bas et le haut. • Pour mesurer la tension élevée avec 701281 (FREQ) ou 720281(FREQ), utiliser une sonde isolée (700929, 701947) ou une sonde passive 702902.
- Les fonctions de protection et les fonctions de non-isolation de 720230 (LOGIC) sont activées lorsque les vis du module sont serrées. Il est extrêmement dangereux de ne pas serrer les vis. S'assurer également de bien utiliser uniquement une sonde logique YOKOGAWA recommandée (700986, 700987, 702911 ou 702912) avec le module logique.

## Types of Input Modules

The following types of input modules are available.

| Name  | Model                    |
|---|--------------------------|
| High-Speed 10 MS/s, 12-Bit Isolation Module                           | 701250 (HS10M12)         |
| High-Speed 10 MS/s, 12-Bit Isolation Module                           | 720250 (HS10M12)         |
| High-Speed High-Resolution 1 MS/s, 16-Bit Isolation Module            | 701251 (HS1M16)          |
| High-Speed 10 MS/s, 12-Bit Non-Isolation Module                       | 701255 (NONISO_10M12)    |
| High-Voltage 100 kS/s, 16-Bit Isolation Module (with RMS)             | 701267 (HV (with RMS))   |
| High-Voltage 1 MS/s, 16-Bit Isolation Module (with AAF and RMS)       | 720268 (HV (AAF, RMS))   |
| Universal (Voltage/Temp.) Module                                      | 701261 (UNIVERSAL)       |
| Universal (Voltage/Temp.) Module (with AAF)                           | 701262 (UNIVERSAL (AAF)) |
| Temperature, High Precision Voltage Isolation Module                  | 701265 (TEMP/HPV)        |
| Temperature, High Precision Voltage Isolation Module (low noise type) | 720266 (TEMP/HPV)        |
| Strain Module (NDIS)  | 701270 (STRAIN_NDIS)     |
| Strain Module (DSUB, Shunt-Cal)                                       | 701271 (STRAIN_DSUB)     |
| Acceleration/Voltage Module (with AAF)                                | 701275 (ACCL/VOLT)       |
| Frequency Module  | 701281 (FREQ)            |
| Frequency Module  | 720281 (FREQ)            |
| High-Speed 100 MS/s, 12-Bit Isolation Module                          | 720210 (HS100M12)        |
| High-Speed 100 MS/s, 12-Bit Isolation Module                          | 720211 (HS100M12)        |
| 16-CH Voltage Input Module  | 720220 (16CH VOLT)       |
| 16-CH Temperature/Voltage Input Module                                | 720221 (16CH TEMP/VOLT)  |
| Logic Input Module  | 720230 (LOGIC)           |
| CAN Bus Monitor Module*   | 720240 (CAN MONITOR)     |
| CAN & LIN Bus Monitor Module*   | 720241 (CAN & LIN)       |
| CAN/CAN FD Monitor Module*  | 720242 (CAN/CAN FD)      |
| SENT Monitor Module*  | 720243 (SENT)            |
| 4-CH 1 MS/s, 16-Bit Isolation Module                                  | 720254 (4CH 1M16)        |

\* The CAN bus monitor, CAN & LIN bus monitor, CAN/CAN FD monitor, and SENT monitor modules can be used on the DL850EV. They cannot be used on the DL850E.

## Precautions to Be Taken When Installing or Removing Input Modules

If you replace one installed input module with another, the settings for the channel will be reset to their defaults when the power is turned on. If you want to keep the settings, specify a save destination and save them.

## Installation Procedure of Modules

1. Make sure that the power switch on the left side panel of the instrument is turned off.
2. Check the channel number displayed on the input module installation slot on the right side panel of the instrument, and then install the input module along the guide.  
Holding the handles on the top and bottom of the input module, press hard until it clicks in place. If there is a cover panel on the slot in which to install the module, remove the cover panel, first.
3. Firmly fasten the screws that came with the instrument in two places: the top and bottom of the input module.  
Screw tightening torque: 0.6 N•m
4. Turn the instrument's power switch on.
5. In the overview screen, check that the name of the module that you installed is displayed correctly at the appropriate slot. If it is not correct, remove the module according to the steps in "Removal" shown below, and reinstall the module according to steps 1 to 3 shown above. To display the overview screen, see section 19.6, "Viewing System Information (Overview)," in the user's manual.

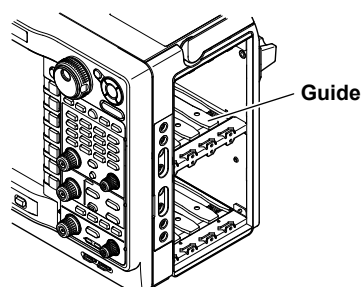

**Note**

- You can install up to four 720210 modules, and these modules must be installed in the top slots.
- You can install up to four 720234 SENT monitor modules (SENT), and these modules must be installed in the bottom slots.
- You can install a total of two 720240 CAN bus monitor modules (CAN MONITOR), 720242 CAN/CAN FD monitor modules (CAN/CAN FD), and 720241 CAN & LIN bus monitor modules (CAN & LIN). These monitor modules can only be installed in slots 7 and 8.

**Removal**

1. Make sure that the instrument's power switch is off.
2. Loosen the two screws that are fastened to the input module.
3. Hold the two handles at the top and bottom of the input module, and pull it out.

**About the High-speed, 100 MS/s, 12-bit Isolated Module****Safety Precautions for Laser Products**

The High-Speed 100 MS/s, 12-Bit Isolation Module (720210 (HS100M12) and 720211 (HS100M12)) uses an internal laser light source. The 720210 (HS100M12) and 720211 (HS100M12) are a class 1 laser product as defined by IEC/EN 60825-1 Safety of Laser Products—Part 1: Equipment Classification. In addition, this instrument complies with 21 CFR 1040.10 and 1040.11 except for deviations pursuant to Laser Notice No. 50, dated June 24, 2007.

**High-Speed 100 MS/s, 12-Bit Isolation Module (720210 (HS100M12) and 720211 (HS100M12))**

The following information is printed on the side.

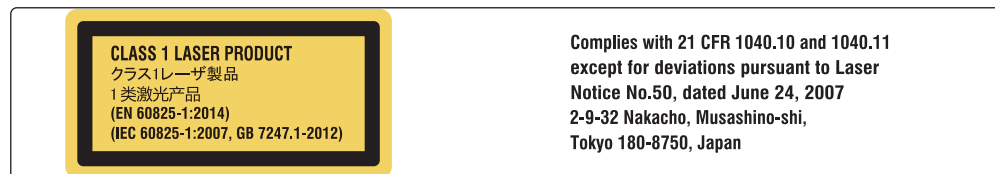
**DL850E/DL850EV**

The following information is printed on the rear.

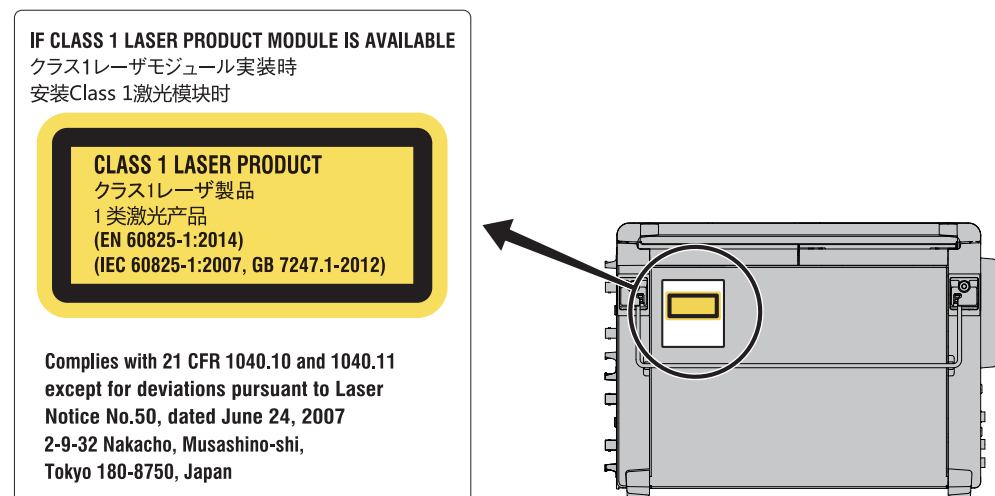





## 3.4 Connecting to a Power Supply and Turning the Power Switch On and Off

### Before Connecting the Power

Make sure that you observe the following points before connecting the power. Failure to do so may cause electric shock or damage to the instrument.



#### WARNING

- Make sure that the power supply voltage matches the instrument's rated supply voltage and that it does not exceed the maximum voltage range of the power cord to use.
- Connect the power cord after checking that the power switch of the instrument is turned off.
- To prevent electric shock or fire, use the power cord for the instrument.
- Make sure to connect protective earth grounding to prevent electric shock. Connect the power cord to a three-prong power outlet with a protective earth terminal.
- Do not use an extension cord without a protective earth ground. Otherwise, the protection function will be compromised.
- If there is no AC outlet that is compatible with the power cord that you will be using and you cannot ground the instrument, do not use the instrument.

#### French



#### AVERTISSEMENT

- Assurez-vous que la tension d'alimentation correspond à la tension d'alimentation nominale de l'appareil et qu'elle ne dépasse pas la plage de tension maximale du cordon d'alimentation à utiliser.
- Brancher le cordon d'alimentation après avoir vérifié que l'interrupteur d'alimentation de l'instrument est sur OFF.
- Pour éviter tout risque de choc électrique, utiliser exclusivement le cordon d'alimentation prévu pour cet instrument.
- Relier l'instrument à la terre pour éviter tout risque de choc électrique. Brancher le cordon d'alimentation sur une prise de courant à trois plots reliée à la terre.
- Toujours utiliser une rallonge avec broche de mise à la terre, à défaut de quoi l'instrument ne serait pas relié à la terre.
- Si une sortie CA conforme au câble d'alimentation fourni n'est pas disponible et que vous ne pouvez pas relier l'instrument à la terre, ne l'utilisez pas.



## Connecting the Power Cord

1. Check that the power switch is off.
2. Connect the power cord plug to the power inlet on the left side panel.
3. Connect the other end of the cord to an outlet that meets the conditions below. Use the three-prong power outlet equipped with a protective earth terminal.

|  |  |
|--|--|
| Rated supply voltage*                    | 100 to 120 VAC/200 to 240 VAC  |
| Permitted supply voltage range           | 90 to 132 VAC/198 to 264 VAC   |
| Rated supply voltage frequency           | 50/60 Hz   |
| Permitted supply voltage frequency range | 48 to 63 Hz  |
| Maximum power consumption                | Approx. 200 VA max.<br>(This value is for reference. When the built-in printer is not being used and there are 16 active channels provided by eight high-speed 10 MS/s 12-bit isolation modules, the maximum power consumption is 135 VA.) |

\* The instrument can use a 100 V or a 200 V power supply. The maximum rated voltage differs according to the type of power cord. Check that the voltage supplied to the instrument is less than or equal to the maximum rated voltage of the power cord that you will be using before use.

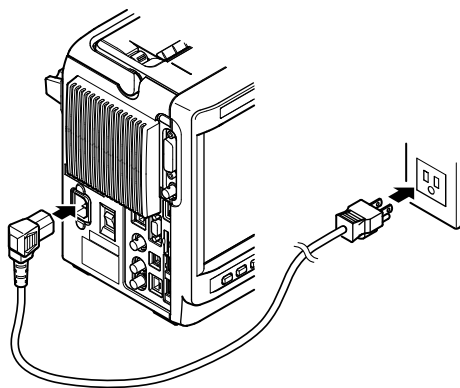

## Connecting the DC Power Supply to the DC Power Supply Model (/DC)



### WARNING

- Connect the DC power cord after checking that the power switch of the instrument is turned OFF. If you connect the power cord with the power switch turned ON, sparks may be emitted and can lead to fire.
- To prevent the possibility of electric shock or fire, be sure to use a power cord and power connector that YOKOGAWA specifies.
- Make sure to perform protective earth grounding to prevent electric shock.



### CAUTION

- There is a polarity to the DC power connector. Check the polarity when making a connection. If you have trouble connecting it, do not force it; check the connector direction.
- To prevent shorting the power supply, remove the power cord from the power supply when the power supply is not in use.

## French

**AVERTISSEMENT**

- Branchez le cordon d'alimentation CC après avoir vérifié que l'interrupteur d'alimentation de l'instrument est sur OFF. Si vous reliez le cordon d'alimentation lorsque l'interrupteur électrique est sur ON, des étincelles peuvent jaillir et provoquer un incendie.
- Pour éviter les risques de choc électrique ou d'incendie, utilisez le cordon d'alimentation et le connecteur électrique fourni par YOKOGAWA.
- Relier l'instrument à la terre pour éviter tout risque de choc électrique.

**ATTENTION**

- Il y a une polarité vers le connecteur d'alimentation en courant continu. Contrôlez la polarité lorsque vous effectuez une connexion. Si vous avez des problèmes lors de la connexion, ne forcez pas ; contrôlez le sens du connecteur.
- Pour prévenir toute coupure d'alimentation, débranchez le cordon électrique de la prise de courant lorsque l'alimentation électrique n'est pas nécessaire.

**Creating the Power Cord**

Create a power cord using the power connector that comes with the package. For the power cord, use a cable that is between AWG12 (conductive cross-sectional area of 3.3 mm<sup>2</sup>) and AWG14 (conductive cross-sectional area of 2.1 mm<sup>2</sup>) with an outer diameter less than or equal to 3.6 mm.

There are two types of terminal tips. Use the tip with a small diameter for the protective grounding terminal.

1. Remove the two screws from the DC power connector.
2. Press the latch pawl in the direction of the arrow as shown and remove the connector case. Take out the cable cover that is stored in the connector.

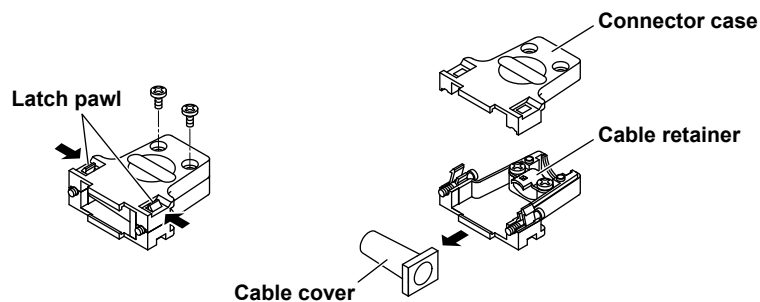

3. Remove the two cable retainer screws.
4. Run the cable through the cable cover.
5. Solder the power cable to the three terminal tips provided. Solder the protective grounding cable to the tip with the small diameter.

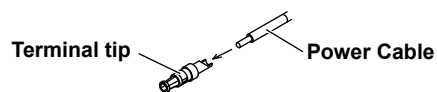

### 3.4 Connecting to a Power Supply and Turning the Power Switch On and Off

6. Insert the terminal tips into the terminal block as shown in the figure. The connector numbers and power polarities are listed below.

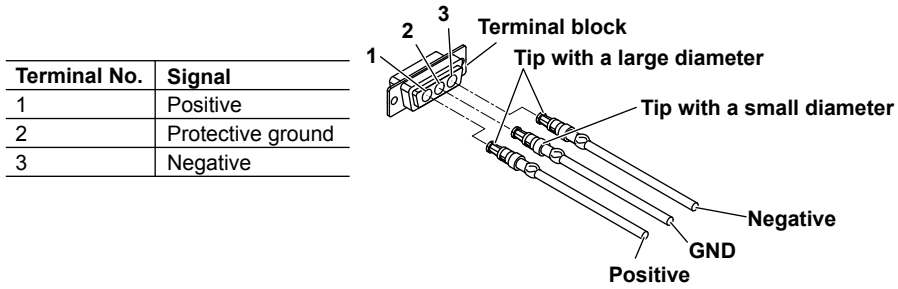

7. Replace the attachment screws with the supplied long screws as necessary. You can remove the attachment screws by pulling the screws in the direction of the arrow.
8. Attach the cable to the connector. Set the chip mount flange and cable cover flange in the connector case grooves. Secure the cable in place using the cable retainer.

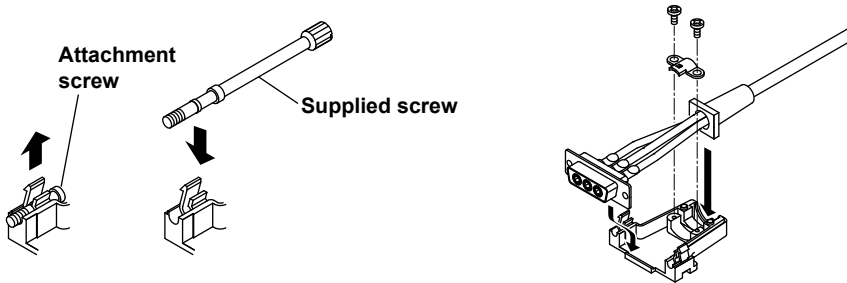

9. Put the connector case on and fasten it with screws.

### Connecting to the Power Supply

Connect the power cord as shown in the figure below. The power supply must meet the following conditions:

| Item                           | Description   |
|--------------------------------|---|
| Rated supply voltage           | 12 VDC  |
| Permitted supply voltage range | 10 to 18 VDC (at the DL850EV connector end)   |
| Maximum power consumption      | Approx. 150 VA Max.<br>(135 VA when driving 16 channels with four High-Speed 100 MS/s, 12-Bit Isolation Modules and four High-Speed 10 MS/s 12-Bit Isolation Modules) |

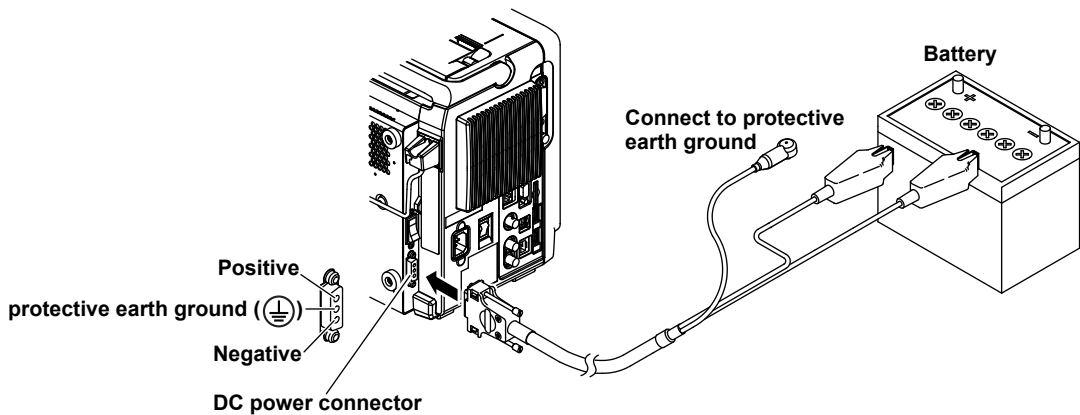

#### Note

- If both AC power and DC power are supplied, AC power takes precedence.
- If both AC power and DC power are supplied and AC power is cut off, the power instantaneously switches to DC power.

## Turning the Power Switch On and Off

### Before Turning On the Power, Check That:

- The instrument is installed properly (see section 3.2, “Installing the Instrument”).
- The power cord is connected properly (see page 3-12).

### Turning the Power Switch On and Off

Flip the power switch on the left side panel to ON (|) to turn the instrument on, and to OFF (○) to turn the instrument off.

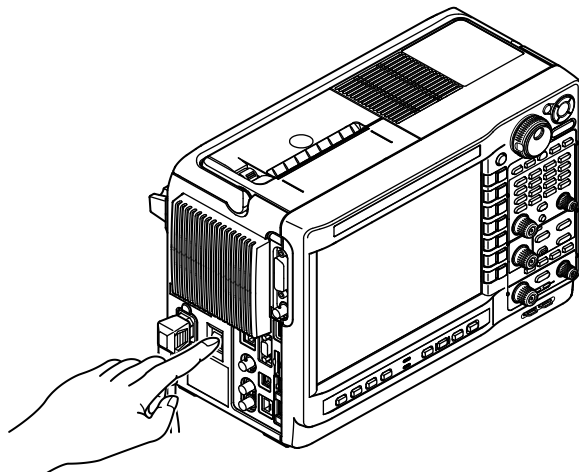

## Turning ON/OFF the DC Power (/DC)

### Before Turning On the Power, Check That:

- The instrument is installed properly (see section 3.2, “Installing the Instrument”).
- The power cord is connected properly (see page 3-12).

### Turning the Power Switch On and Off

Flip the power switch on the left side panel to ON (|) to turn the instrument on, and to OFF (○) to turn the instrument off.

#### Note

If AC power is supplied and the main power switch to the AC power is ON, AC power is used.

## Status Display of the DC Power Supply

The power supply status is indicated on the LED on the left side panel.

#### AC LED

| LED Status           | Description           |
|----------------------|-----------------------|
| Illuminated in green | Operating on AC power |

#### DC LED

| LED Status            | Description   |
|-----------------------|---|
| Illuminated in green  | Operating on DC power (AC power is not connected)   |
| Illuminated in red    | Operating on AC power, and the DC supply voltage is within the operating range (10 to 18 VDC)                                 |
| Illuminated in orange | Operating on DC power, and the DC supply voltage is outside the operating range   |
|                       | DC power is turning ON/OFF repeatedly (internal protection circuit is tripping)   |
|                       | Power is not supplied in this condition. This status is automatically cleared after 10 to 20 seconds.                         |
| Blinked in red        | Internal circuit operation failure. Repair is necessary.  |
| Off                   | Operating on AC power, and the DC supply voltage is within the operating range (10 to 18 VDC) or the DC power is not supplied |

---

#### CAUTION

Abruptly turning off the power switch or unplugging the power cord while data is being saved or the internal printer is printing may corrupt the media on which data is being saved or damage the built-in printer. Also, the data being saved is not guaranteed. Always turn the power switch off after data has been saved.

---

#### French

---

---

#### ATTENTION

Mettre brutalement l'instrument hors tension ou débrancher le cordon d'alimentation pendant l'enregistrement de données ou le fonctionnement de l'imprimante interne peut corrompre le support d'enregistrement des données ou endommager l'imprimante intégrée. Les données en cours d'enregistrement pourront également être perdues. Toujours mettre l'instrument hors tension après que les données ont été enregistrées.

---

## Operations Performed When the Power Is Turned On

When the power switch is turned on, self testing and calibration start automatically. This lasts for approximately 30 seconds. When the DL850E/DL850EV starts normally, the waveform display screen appears. Check that the DL850E/DL850EV has started normally before you use it.

#### If the DL850E/DL850EV Does Not Start Normally When the Power Is Turned On

Turn off the power switch, and check the following items.

- Check that the power cord is securely connected.
  - Check that the correct voltage is coming to the power outlet. → See page 3-12
  - Initialize the settings to their factory defaults by turning on the power switch while holding down the RESET key. For details about initializing the settings, see section 4.6, "Initializing Settings."
- If the instrument still does not work properly, contact your nearest YOKOGAWA dealer for repairs.

#### Note

---

- After turning the power off, wait at least 10 seconds before you turn it on again.
  - On the DC power supply option, repeatedly turning the power switch on and off will stop the power from being supplied because the internal protection will be activated. If you refrain from turning the power on or off for 10 to 20 seconds, the internal protection will be released, and power supply will be restored. The DC power supply LED lights in orange while power is not being supplied.
  - It takes several seconds for the startup screen to appear.
- 

## Operations Performed When the Power Is Turned Off

When the power switch is turned off (or the power plug is removed), the instrument stores the current settings in its memory. This means that if you turn the power switch on and begin measurement, the instrument will perform measurements using the settings from immediately before the instrument was last turned off.

#### Note

---

The instrument stores the settings using an internal lithium battery. The battery lasts for approximately five years when the ambient temperature is 23°C. When the lithium battery voltage falls below a specified value and you turn on the power, a message (error 901) appears on the screen. If this message appears frequently, you need to replace the battery soon. Do not try to replace the battery yourself. Contact your nearest YOKOGAWA dealer to have the battery replaced.

---

## To Make Accurate Measurements

- After turning on the power switch, wait at least 30 minutes to allow the instrument to warm up.
- Perform calibration after the instrument has warmed up (see section 4.7 for details). If auto calibration is turned on, auto calibration is executed when you change the Time/div setting or start waveform acquisition.

## 3.5 Connecting Probes

### Connecting Probes

Connect the probes (or other input cables such as BNC cables) to any of the input terminals of the following modules. The input impedance is  $1\text{ M}\Omega \pm 1\%$  and approximately 35 pF.

- High-Speed 100 MS/s, 12-Bit Isolation Module: 720210 (HS100M12) and 720211 (HS100M12)
- High-Speed 10 MS/s, 12-Bit Isolation Module: 701250 (HS10M12) and 720250 (HS10M12)
- High-Speed High-Resolution 1 MS/s, 16-Bit Isolation Module: 701251 (HS1M16)
- High-Speed 10 MS/s, 12-Bit Non-Isolation Module: 701255 (NONISO\_10M12)
- Acceleration/Voltage Module (with AAF): 701275 (ACCL/VOLT)
- Frequency Module: 701281 (FREQ) and 720281 (FREQ)
- SENT Monitor Module: 720243 (SENT)
- 4-CH 1 MS/s, 16-Bit Isolation Module: 720254 (4CH 1M16)

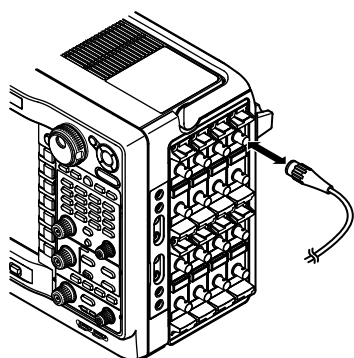

### WARNING

When connecting a device under measurement to the instrument, be sure to turn off the device. It is extremely dangerous to connect or remove measurement leads while the device under measurement is on.

#### Precautions to Be Taken When Using the Modules

- Do not apply input voltage exceeding the maximum input voltage or maximum rated voltage to earth.
- To avoid electric shock, be sure to ground the instrument.
- To prevent the possibility of electric shock, be sure to fasten the module screws. Otherwise, the electrical protection function and the mechanical protection function will not be activated.
- Avoid continuous connection under an environment in which the surge voltage may occur.
- Use only specified cables. It is extremely dangerous to use cables that do not meet the safety standards. (Especially when you are handling high voltages of 42 V or more.)
- To measure high voltage with the 720210 (HS100M12), 720211 (HS100M12), 701250 (HS10M12), 720250 (HS10M12), 701251 (HS1M16), or 720254 (4CH 1M16), use the isolated probes (700929, 701947), passive probes 702902, 1:1 safety cables (combination of 701901 and 701954), or differential probes (700924, 700925, 701926).
- The BNC portion of the 10 MHz passive probe (701940) is metal, so if you use it with isolated input (the 720210 (HS100M12), 720211 (HS100M12), 701250 (HS10M12), 720250 (HS10M12), 701251 (HS1M16), 701275 (ACCL/VOLT), 701281 (FREQ), 720281 (FREQ)), or 720254 (4CH 1M16), for safety, be sure to only use it with voltages at or below 42 V. (Do not connect voltage above 42 V to both the High and Low sides.) For non-isolated inputs (701255 (NONISO\_10M12), etc.), fasten the module screws.
- To measure high voltage with the 701281 (FREQ) or, 720281 (FREQ) use an isolated probe (700929, 701947) or passive probe 702902.

### 3.5 Connecting Probes

---

#### In Using the High Voltage Differential Probes

Be sure to connect the ground lead of the differential probe (700924, 700925, 701926) to the functional grounding terminal on the right side panel of the DL850E/DL850EV before connecting to the measurement target. Not doing so may cause high voltage to appear in the BNC connector of the differential probe.

#### Maximum Input Voltages and Maximum rated voltage to earth for the Modules

Applying a voltage exceeding the value indicated below may damage the input section. If the frequency is above 1 kHz, damage may occur even when the voltage is below this value.

- **For the 720210 (HS100M12) and 720211 (HS100M12)**

Maximum input voltage (at a frequency of 1 kHz or less)

- In combination with an isolated probe (10:1) 700929 or (100:1) 701947, or a passive probe (10:1) 702902<sup>1</sup>  
1000 V (DC + ACpeak) CAT II
- In combination with a safety cable (1:1) (701901+701954)<sup>3</sup>  
200 V (DC + ACpeak)
- Direct input (cable that does not comply with the safety standards)<sup>5</sup>  
42V (DC + ACpeak)

Maximum rated voltage to earth (at a frequency of 1 kHz or less)

- In combination with an isolated probe (10:1) 700929 or (100:1) 701947,<sup>2</sup> or a safety cable (1:1) (701901+701954)<sup>4</sup>  
1000 Vrms (CAT II)
- In combination with a passive probe (10:1) 702902<sup>2</sup>  
1000 V (DC + ACpeak)
- Direct input (cable that does not comply with the safety standards)<sup>6</sup>  
42V (DC + ACpeak) (CAT II, 30 Vrms)

- **For the 701250 (HS10M12) and 720250 (HS10M12)**

Maximum input voltage (at a frequency of 1 kHz or less)

- In combination with an isolated probe (10:1) 700929 or (100:1) 701947, or a passive probe (10:1) 702902<sup>1</sup>  
701250: 600 V (DC + ACpeak)  
720250: 800 V (DC + ACpeak)
- In combination with a safety cable (1:1) (701901+701954)<sup>3</sup>  
200 V (DC + ACpeak) (as a value that meets the safety standard)  
250 V (DC + ACpeak) (maximum allowable voltage, as a value that does not damage the instrument when applied)
- Direct input (cable that does not comply with the safety standards)<sup>5</sup>  
42V (DC + ACpeak)

Maximum rated voltage to earth (at a frequency of 1 kHz or less)

- In combination with an isolated probe (10:1) 700929 or (100:1) 701947, or a passive probe (10:1) 702902<sup>2</sup>, or a safety cable (1:1) (701901+701954)<sup>4</sup>  
701250: 400 Vrms (measurement category Other (O)), 300 Vrms (CAT II)  
720250: 400 Vrms (CAT II)
- Direct input (cable that does not comply with the safety standards)<sup>6</sup>  
42 V (DC + ACpeak) (CAT II, 30 Vrms)

- **For the 701251 (HS1M16)**

Maximum input voltage (at a frequency of 1 kHz or less)

- In combination with an isolated probe (10:1) 700929 or (100:1) 701947, or a passive probe (10:1) 702902<sup>1</sup>  
600 V (DC + ACpeak)
- In combination with a safety cable (1:1) (701901+701954)<sup>3</sup>  
140 V (DC + ACpeak)
- Direct input (cable that does not comply with the safety standards)<sup>5</sup>  
42V (DC + ACpeak)

Maximum rated voltage to earth (at a frequency of 1 kHz or less)

- In combination with an isolated probe (10:1) 700929 or (100:1) 701947, or a passive probe (10:1) 702902<sup>2</sup>, or a safety cable (1:1) (701901+701954)<sup>4</sup>  
400 Vrms (measurement category Other (O)), 300 Vrms (CAT II)



- Direct input (cable that does not comply with the safety standards)<sup>6</sup>  
42 V (DC + ACpeak) (CAT II, 30 Vrms)
- **For the 701255 (NONISO\_10M12)**  
This module is non-isolated. Be sure to fasten the module screws when measuring a voltage above 42 V on this module. In addition, use the 701940 (10:1) dedicated non-isolated passive probe.  
Maximum input voltage (at a frequency of 1 kHz or less)
  - Combined with the 701940 (10:1) passive probe<sup>7</sup>  
600 V (DC + ACpeak)
  - Direct input (cable that does not comply with the safety standards)<sup>5</sup>  
200 V (DC + ACpeak) (as a value that meets the safety standard)  
250 V (DC + ACpeak) (maximum allowable voltage, as a value that does not damage the instrument when applied)
- **For the 701275 (ACCL/VOLT)**  
Maximum input voltage (at a frequency of 1 kHz or less)
  - Combined with the 701940 (10:1) passive probe<sup>7</sup> or direct input (cable that does not comply with the safety standards)<sup>5</sup>  
42 V (DC + ACpeak)
 Maximum rated voltage to earth (at a frequency of 1 kHz or less)
  - Combined with the 701940 (10:1) passive probe<sup>8</sup> or direct input (cable that does not comply with the safety standards)<sup>6</sup>  
42 V (DC + ACpeak) (CAT II, 30 Vrms)
- **For the 701281 (FREQ) and 720281 (FREQ)**  
Maximum input voltage (at a frequency of 1 kHz or less)
  - In combination with an isolated probe (10:1) 700929 or (100:1) 701947, or a passive probe (10:1) 702902<sup>1</sup>  
420 V (DC + ACpeak)
  - Safety cable (1:1) (combined with 701901+701954)<sup>3</sup> or direct input (cable that does not comply with the safety standards)<sup>5</sup>  
42 V (DC + ACpeak)
 Maximum rated voltage to earth (at a frequency of 1 kHz or less)
  - In combination with an isolated probe (10:1) 700929 or (100:1) 701947, or a passive probe (10:1) 702902<sup>2</sup>  
701281: 300 Vrms (CAT II)  
720281: 400 Vrms (CAT II)
  - Safety cable (1:1) (combined with 701901+701954)<sup>4</sup> or direct input (cable that does not comply with the safety standards)<sup>6</sup>  
42 V (DC + ACpeak) (CAT II, 30 Vrms)
- **For the 720243 (SENT)**  
Maximum input voltage (at a frequency of 1 kHz or less)
  - In combination with an isolated probe (10:1) 700929 or a passive probe (10:1) 702902<sup>1</sup>  
420 V (DC + ACpeak)
  - Safety cable (1:1) (combined with 701901+701954)<sup>3</sup> or direct input (cable that does not comply with the safety standards)<sup>5</sup>  
42 V (DC + ACpeak)
 Maximum rated voltage to earth (at a frequency of 1 kHz or less)
  - In combination with an isolated probe (10:1) 700929 or a passive probe (10:1) 702902<sup>2</sup>  
300 Vrms (CAT II)
  - Safety cable (1:1) (combined with 701901+701954)<sup>4</sup> or direct input (cable that does not comply with the safety standards)<sup>6</sup>  
42 V (DC + ACpeak) (CAT II, 30 Vrms)



### 3.5 Connecting Probes

- **For the 720254 (4CH 1M16)**

Maximum input voltage (at a frequency of 1 kHz or less)

- In combination with an isolated probe (10:1) 700929 or (100:1) 701947, or a passive probe (10:1) 702902<sup>1</sup>  
600 V (DC + ACpeak)
- In combination with a safety cable (1:1) (701901+701954)<sup>3</sup>  
200 V (DC + ACpeak) (as a value that meets the safety standard)  
400 V (DC + ACpeak) (maximum allowable voltage, as a value that does not damage the instrument when applied)
- Direct input (cable that does not comply with the safety standards)<sup>5</sup>  
42V (DC + ACpeak)

Maximum rated voltage to earth (at a frequency of 1 kHz or less)

- In combination with an isolated probe (10:1) 700929 or (100:1) 701947, or a passive probe (10:1) 702902<sup>2</sup>, or a safety cable (1:1) (701901+701954)<sup>4</sup>  
400 Vrms (measurement category Other (O)), 300 Vrms (CAT II)
- Direct input (cable that does not comply with the safety standards)<sup>6</sup>  
42 V (DC + ACpeak) (CAT II, 30 Vrms)

With the 700929, 701947, or 702902

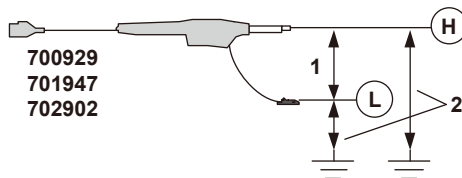

With the 701901 and 701954

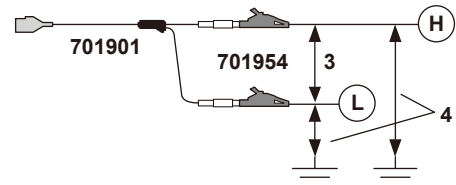

Direct input (cable that does not comply with the safety standards)

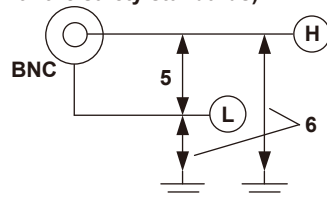

With the 10:1 passive probe (701940)

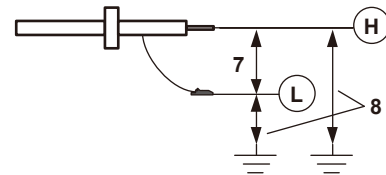

#### Over-Range Indication

If over-range is indicated, the DL850E/DL850EV may be receiving a voltage higher than the observed waveform or measured waveform values. To prevent electric shock, change the vertical scale with the SCALE knob so that the entire amplitude of the waveform is displayed within the waveform display area, and check the input voltage level.

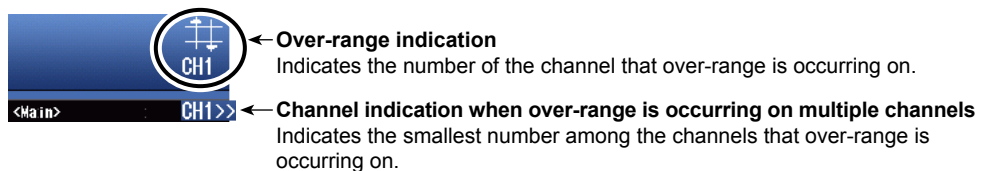

#### French



### AVERTISSEMENT

Au moment de brancher l'appareil à mesurer sur l'instrument, veiller à ce que l'appareil soit hors tension. Il est extrêmement dangereux de brancher ou de débrancher des câbles lorsque l'appareil à mesurer est sous tension.

**Précautions à prendre lors de l'utilisation des modules**

- Ne pas dépasser les valeurs maximales de tension d'entrée, de tension nominale maximale à la terre.
- Pour éviter tout risque de choc électrique, l'instrument doit impérativement être relié à la terre.
- Pour éviter tout risque de choc électrique, toujours serrer les vis des modules, à défaut de quoi les fonctions de protection électrique et de protection mécanique ne seront pas activées.
- Éviter les connexions continues dans les environnements pouvant être soumis à surtension.
- Utilisez uniquement les câbles préconisés. Il est extrêmement dangereux d'utiliser des câbles n'étant pas conformes aux normes de sécurité. (notamment lorsque vous travaillez avec de hautes tensions de 42 V, voire supérieures).
- Pour mesurer la tension élevée avec 720210 (HS100M12), 720211 (HS100M12), 701250 (HS10M12), 720250 (HS10M12), 701251 (HS1M16) ou 720254 (4CH 1M16), utiliser des sondes isolées (700929, 701947), 701251 (HS1M16) ou 720254 (4CH 1M16), utiliser des sondes isolées (700929, 701947), des sondes passives 702902, des câbles de sécurité 1:1 (combinaison de 701901 et 701954) ou des sondes différentielles (700924, 700925, 701926).
- La partie BNC de la sonde passive de 10 MHz 701940 est en métal ; si vous l'utilisez avec l'entrée isolée (720210 (HS100M12), 720211 (HS100M12), 701250 (HS10M12), 701251 (HS1M16), 701275 (ACCL/VOLT), 701281 (FREQ), 720281 (FREQ) ou 720254 (4CH 1M16)), veillez à l'utiliser uniquement avec des tensions inférieures ou égales à 42 V pour des raisons de sécurité (ne reliez pas une tension supérieure à 42 V aux côtés Haut et Bas). Pour les entrées non isolées (701255 (NONISO\_10M12), etc.), serrez les vis du module.
- Pour mesurer la tension élevée avec 701281 (FREQ) ou 720281 (FREQ), utiliser une sonde isolée (700929, 701947) ou une sonde passive 702902.

**Utilisation de sondes différentielles haute tension**

Bien relier le fil de terre de la sonde différentielle (700924, 700925, 701926) à la borne de mise à la terre opérationnelle, sur le panneau droit de DL850E/DL850EV avant de le relier à la cible de la mesure. Le fait de ne pas respecter cette consigne risque d'entraîner l'apparition d'une tension élevée au niveau du connecteur BNC de la sonde différentielle.

**Tensions d'entrée maximales et tension nominale maximale à la terre les modules**

L'application d'une tension supérieure à la valeur indiquée ci-dessous pourrait endommager la section d'entrée. Si la fréquence est supérieure à 1 kHz, une tension inférieure à cette valeur pourra tout de même endommager la section d'entrée.

**• Pour 720210 (HS100M12) et 720211 (HS100M12)**

Tension d'entrée maximale (à une fréquence de 1 kHz ou moins)

- En combinaison avec une sonde isolée (10:1) 700929 ou (100:1) 701947 ou une sonde passive (10:1) 702902<sup>1</sup>  
1000 V (c.c. + crête c.a.) CAT II
- Avec le câble de sécurité (1:1; 701901 et 701954 conjointement)<sup>3</sup>  
200 V (c.c. + crête c.a.)
- Entrée directe (câble non conforme aux normes de sécurité)<sup>5</sup>  
42 V (c.c. + crête c.a.)

Tension nominale maximale à la terre (à une fréquence 1 kHz ou inférieure)

- Si utilisé avec la sonde isolée 700929 (10:1) ou 701947 (100:1).<sup>2</sup> Ou si utilisé avec le câble de sécurité (1:1; 701901 et 701954 conjointement).<sup>4</sup>  
1000 Vrms (CAT II)
- En combinaison avec une sonde passive (10:1) 702902<sup>2</sup>  
1000 V (c.c. + crête c.a.)
- Entrée directe (câble non conforme aux normes de sécurité)<sup>6</sup>  
42 V (c.c. + crête c.a.) (CAT II, 30 Vrms)

### 3.5 Connecting Probes

---

- **Pour 701250 (HS10M12) et 720250 (HS10M12)**

Tension d'entrée maximale (à une fréquence de 1 kHz ou moins)

- En combinaison avec une sonde isolée (10:1) 700929 ou (100:1) 701947 ou une sonde passive (10:1) 702902<sup>1</sup>  
701250: 600 V (c.c. + crête c.a.)  
720250: 800 V (c.c. + crête c.a.)
- Câble de sécurité (1:1) (associé à 701901+701954)<sup>3</sup>  
200 V (c.c. + crête c.a.) (comme valeur conforme à la norme de sécurité)  
250 V (c.c. + crête c.a.) (tension maximale admise, comme valeur qui n'endommage pas l'instrument lorsqu'elle est appliquée)
- Entrée directe (câble non conforme aux normes de sécurité)<sup>5</sup>  
42 V (c.c. + crête c.a.)

Tension nominale maximale à la terre (à une fréquence 1 kHz ou inférieure)

- En combinaison avec une sonde isolée (10:1) 700929 ou (100:1) 701947 ou une sonde passive (10:1) 702902.<sup>2</sup> Ou si utilisé avec le câble de sécurité (1:1; 701901 et 701954 conjointement).<sup>4</sup>  
701250: 400 Vrms (catégorie de mesure Autre (O)), 300 Vrms (CAT II)  
720250: 400 Vrms (CAT II)
- Entrée directe (câble non conforme aux normes de sécurité)<sup>6</sup>  
42 V (c.c. + crête c.a.)(CAT II 30 Vrms)

- **Pour 701251 (HS1M16)**

Tension d'entrée maximale (à une fréquence de 1 kHz ou moins)

- En combinaison avec une sonde isolée (10:1) 700929 ou (100:1) 701947 ou une sonde passive (10:1) 702902<sup>1</sup>  
600 V (c.c. + crête c.a.)
- Câble de sécurité (1:1) (associé à 701901 + 701954)<sup>3</sup>  
140 V (c.c. + crête c.a.)
- Entrée directe (câble non conforme aux normes de sécurité)<sup>5</sup>  
42 V (c.c. + crête c.a.)

Tension nominale maximale à la terre (à une fréquence 1 kHz ou inférieure)

- En combinaison avec une sonde isolée (10:1) 700929 ou (100:1) 701947 ou une sonde passive (10:1) 702902.<sup>2</sup> Ou si utilisé avec le câble de sécurité (1:1; 701901 et 701954 conjointement).<sup>4</sup>  
400 Vrms (catégorie de mesure Autre (O)), 300 Vrms (CAT II)
- Entrée directe (câble non conforme aux normes de sécurité)<sup>6</sup>  
42 V (c.c. + crête c.a.) (CAT II 30 Vrms)

- **Pour 701255 (NONISO\_10M12)**

Ce module n'est pas isolé. Veuillez à serrer les vis du module lors de la mesure d'une tension supérieure à 42 V sur ce module. En outre, utilisez la sonde passive isolée et non isolée 701940 (10:1).

Tension d'entrée maximale (à une fréquence de 1 kHz ou moins)

- Associé à la sonde passive 701940 (10:1)  
600 V (c.c. + crête c.a.)
- Entrée directe (câble non conforme aux normes de sécurité)<sup>5</sup>  
200 V (c.c. + crête c.a.) (comme valeur conforme à la norme de sécurité)  
250 V (c.c. + crête c.a.) (tension maximale admise, comme valeur qui n'endommage pas l'instrument lorsqu'elle est appliquée)

- **Pour 701275 (ACCL/VOLT)**

Tension d'entrée maximale (à une fréquence de 1 kHz ou moins)

- Associé à la sonde passive 701940 (10:1)<sup>7</sup> ou à l'entrée directe (câble non conforme aux normes de sécurité)<sup>5</sup>  
42 V (c.c. + crête c.a.)

Tension nominale maximale à la terre (à une fréquence 1 kHz ou inférieure)

- Associé à la sonde passive 701940 (10:1)<sup>8</sup> ou à l'entrée directe (câble non conforme aux normes de sécurité)<sup>6</sup>  
42 V (c.c. + crête c.a.) (CAT II, 30 Vrms)

- **Pour 701281 (FREQ) et 720281 (FREQ)**

Tension d'entrée maximale (à une fréquence de 1 kHz ou moins)

- En cas d'utilisation avec la sonde isolée 700929 (10:1) ou (100:1) 701947 ou la sonde passive 702902 (10:1).<sup>1</sup>  
420 V (c.c. + crête c.a.)
- Câble de sécurité (1:1) (associé à 701901 + 701954)<sup>3</sup> ou entrée directe (câble non conforme aux normes de sécurité)<sup>5</sup>  
42 V (c.c. + crête c.a.)

Tension nominale maximale à la terre (à une fréquence 1 kHz ou inférieure)

- En cas d'utilisation avec la sonde isolée 700929 (10:1) ou (100:1) 701947 ou la sonde passive 702902 (10:1).<sup>2</sup>  
701281: 300 Vrms (CAT II)  
720281: 400 Vrms (CAT II)
- Câble de sécurité (1:1) (associé à 701901 + 701954)<sup>4</sup> ou entrée directe (câble non conforme aux normes de sécurité)<sup>6</sup>  
42 V (c.c. + crête c.a.) (CAT II, 30 Vrms)

- **Pour 720243 (SENT)**

Tension d'entrée maximale (à une fréquence de 1 kHz ou moins)

- En cas d'utilisation avec la sonde isolée 700929 (10:1) ou la sonde passive 702902 (10:1).<sup>1</sup>  
420 V (c.c. + crête c.a.)
- Câble de sécurité (1:1) (associé à 701901 + 701954)<sup>3</sup> ou entrée directe (câble non conforme aux normes de sécurité)<sup>5</sup>  
42 V (c.c. + crête c.a.)

Tension nominale maximale à la terre (à une fréquence 1 kHz ou inférieure)

- En cas d'utilisation avec la sonde isolée 700929 (10:1) ou la sonde passive 702902 (10:1).<sup>2</sup>  
300 Vrms (CAT II)
- Câble de sécurité (1:1) (associé à 701901 + 701954)<sup>4</sup> ou entrée directe (câble non conforme aux normes de sécurité)<sup>6</sup>  
42 V (c.c. + crête c.a.) (CAT II, 30 Vrms)

- **Pour 720254 (4CH 1M16)**

Tension d'entrée maximale (à une fréquence de 1 kHz ou moins)

- En combinaison avec une sonde isolée (10:1) 700929 ou (100:1) 701947 ou une sonde passive (10:1) 702902<sup>1</sup>  
600 V (c.c. + crête c.a.)
- Câble de sécurité (1:1) (associé à 701901 + 701954)<sup>3</sup>  
200 V (c.c. + crête c.a.) (comme valeur conforme à la norme de sécurité)  
400 V (c.c. + crête c.a.) (tension maximale admise, comme valeur qui n'endommage pas l'instrument lorsqu'elle est appliquée)
- Entrée directe (câble non conforme aux normes de sécurité)<sup>5</sup>  
42 V (c.c. + crête c.a.)

Tension nominale maximale à la terre (à une fréquence 1 kHz ou inférieure)

- En combinaison avec une sonde isolée (10:1) 700929 ou (100:1) 701947 ou une sonde passive (10:1) 702902.<sup>2</sup> Ou si utilisé avec le câble de sécurité (1:1; 701901 et 701954 conjointement).<sup>4</sup>  
400 Vrms (catégorie de mesure Autre (O)), 300 Vrms (CAT II)
- Entrée directe (câble non conforme aux normes de sécurité)<sup>5</sup>  
42 V (c.c. + crête c.a.) (CAT II 30 Vrms)

### 3.5 Connecting Probes

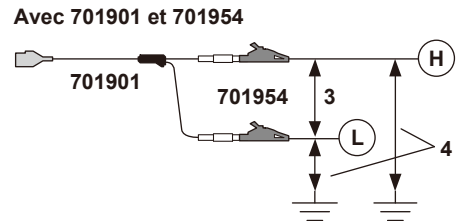
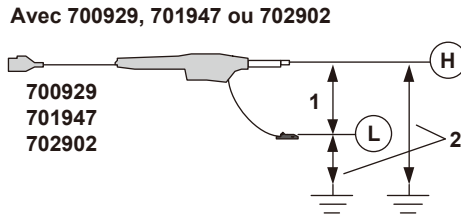

**Entrée directe (câble non conforme aux normes de sécurité)**

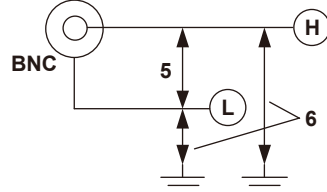

**Avec la sonde passive 10:1 (701940)**

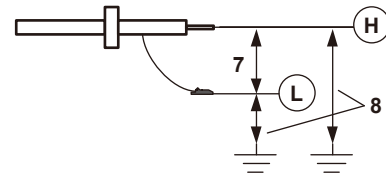

#### Dépassement de plage

En cas de dépassement de plage, le DL850E/DL850EV risque de recevoir une tension supérieure à la forme d'onde observée ou aux valeurs de forme d'onde mesurées. Pour éviter tout risque de choc électrique, modifier l'échelle de gain vertical à l'aide du bouton SCALE, de sorte que l'amplitude entière de la forme d'onde s'affiche sur l'afficheur, et vérifier le niveau de tension d'entrée.



← **Dépassement de plage**

Indique le numéro de canal sur lequel le dépassement de plage a lieu.

← **L'indication du canal en cas de dépassement de plage sur des canaux multiples**

Indique le numéro le plus petit parmi les canaux sur lequel le dépassement a lieu.

### Precautions to Be Taken When Connecting Probes

- When connecting a probe to the instrument for the first time, perform phase correction of the probe as described in section 3.6, "Compensating the Probe (Phase Correction)." Make the phase correction on each channel to which the probe is to be connected.
- You cannot perform phase correction of the probe on the frequency module (701281 (FREQ) and 720281 (FREQ)) and SENT monitor module (720243 (SENT)). When connecting a probe to the 701281 (FREQ), 720281 (FREQ), or 720243 (SENT), first perform phase correction on the probe using another module.
- If the object to be measured is connected to the instrument directly, without using a probe, a correct measurement cannot be performed due to the input impedance. Please be aware of this.
- Note that if you use a voltage probe other than an isolated probe (700929 or 701947) or passive probe (702902), correct measurements cannot be displayed when the attenuation is not 1:1, 10:1, 100:1, or 1000:1.
- Follow the instructions given in section 1.1, "Configuring Voltage Measurements," in the user's manual to set the probe attenuation or the current-to-voltage conversion ratio to match the actual value using the setup menu. If they do not match, measured values cannot be read correctly.

## Connecting Current Probes

When using current probes made by YOKOGAWA,\* use the probe power supply (optional) on the right side panel of the DL850E/DL850EV.

\* YOKOGAWA current probes: the 701930, 701931, 701932, 701933, 701917, and 701918

For details on the connection procedure, see the manual that came with the current probe.

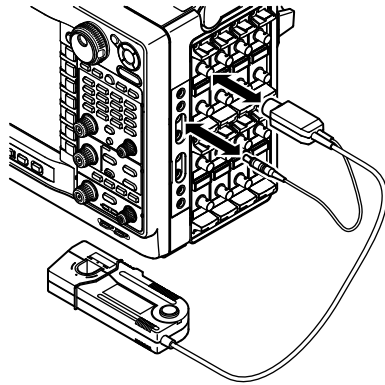

### CAUTION

Do not use the probe power supply terminals (optional) on the right side panel of the DL850E/DL850EV for purposes other than supplying power to the current probes. Also, be sure to use only the number of probes allowed. Otherwise, the DL850E/DL850EV or the devices connected to them may get damaged.

#### French



### ATTENTION

N'utilisez pas les bornes d'alimentation de sonde (option) sur le volet droit du DL850E/DL850EV à des fins autres que l'alimentation des sondes. Veillez également à n'utiliser que le nombre de sondes préconisé. Faute de quoi, le DL850E/DL850EV ou tout appareil connecté pourrait être endommagé.

## Precautions to Be Taken When Using Current Probes

When connecting the current probe to the probe power supply terminal on the right side panel, make sure that the current does not exceed the range shown below. Otherwise, the DL850E/DL850EV operation may become unstable due to the activation of the excessive current protection circuit of the power supply.

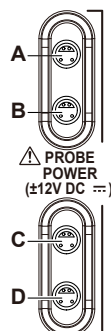

If the terminals are named A through D

(Total current consumption for A through D)  $\leq 1$  A

## Specifications of the Probe Power Supply Terminals (Optional)

| Item                                      |  |
|---|--|
| Number of probes that can be used         | 4  |
| Probes that can be used                   | Current probe (701930, 701931, 701932, and 701933)   |
| Number of current probes that can be used | 701917 (5 A): Up to 2<br>701918 (5 A): Up to 2<br>701930 (150 A): Up to 2<br>701931 (500 A): Up to 1<br>701932 (30 A): Up to 2<br>701933 (30 A): Up to 2 |
| Supply voltage                            | ±12 V, four outputs (up to 1 A total current)  |

\* Up to four 700937 current probes can be used, but this probe is a discontinued product.

When using the current probe, the number of probes that can be used is limited by the current generated by the device under measurement (current measured by the current probe). The measured versus consumed current characteristics of current probes that can be connected to the instrument are indicated below.

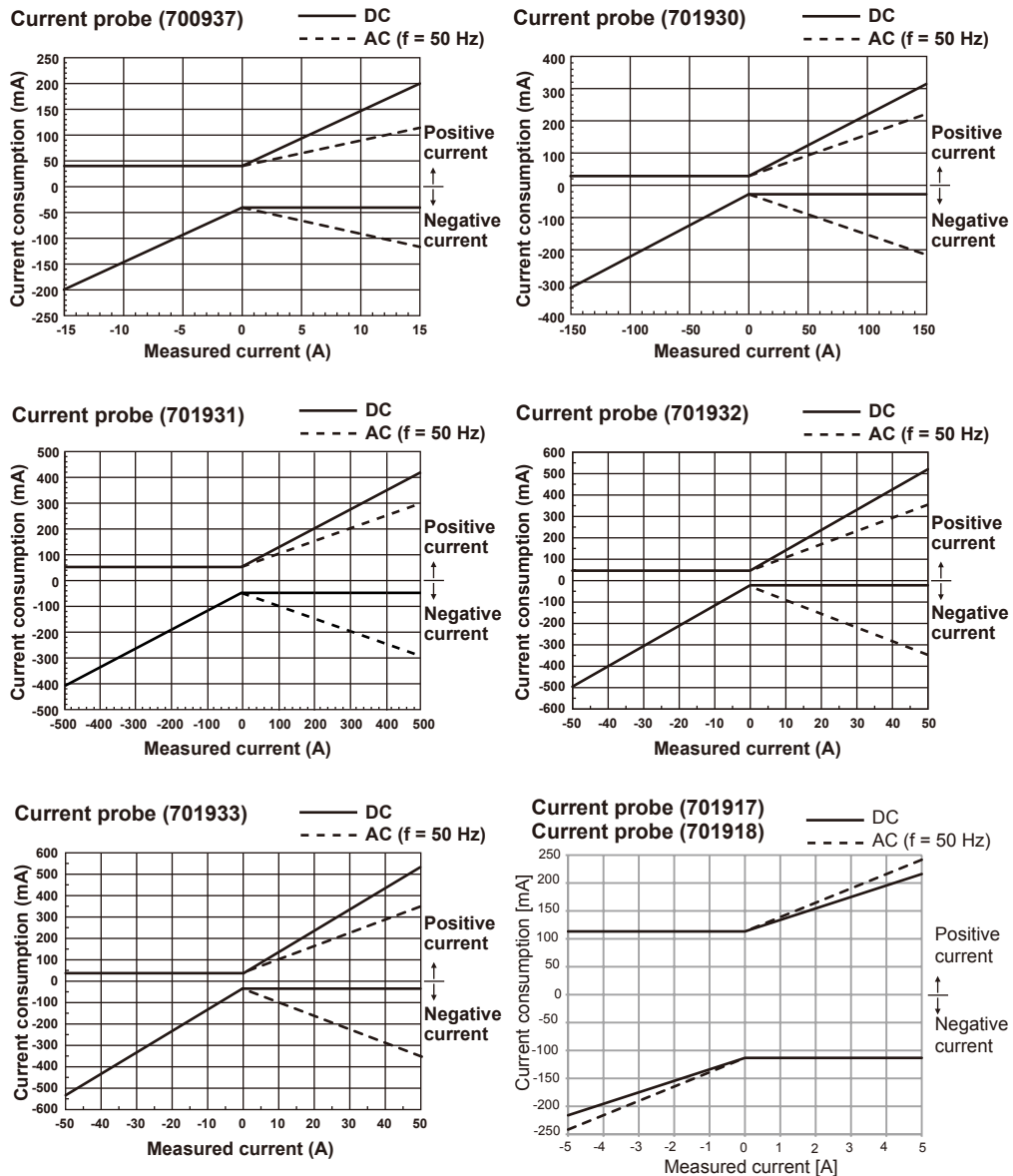

For details about each current probe, contact your nearest YOKOGAWA dealer.

## Connecting Differential Probes

When using Yokogawa differential probes (700924, 700925, 701926), connect the BNC output connector to the oscilloscope's input terminal. Also, be sure to connect the GND lead to the functional ground terminal of the DL850E/DL850EV. If necessary, use the auxiliary grounding lead extension. For details on the connection procedure, see the manual that came with the differential probe.

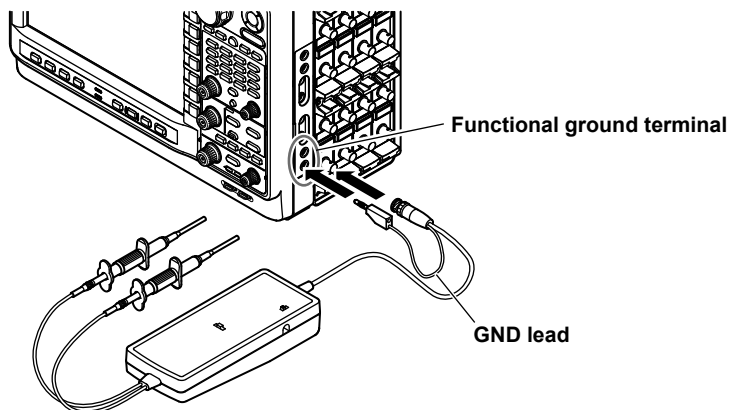

### WARNING

#### In Using the High Voltage Differential Probes

Be sure to connect the ground lead of the differential probe (700924, 700925, 701926) to the functional grounding terminal on the right side panel of the DL850E/DL850EV before connecting to the measurement target. Not doing so may cause high voltage to appear in the BNC connector of the differential probe.

#### French



### AVERTISSEMENT

#### Utilisation de sondes différentielles haute tension

Bien relier le fil de terre de la sonde différentielle (700924, 700925, 701926) à la borne de mise à la terre opérationnelle, sur le panneau droit de DL850E/DL850EV avant de le relier à la cible de la mesure. Le fait de ne pas respecter cette consigne risque d'entraîner l'apparition d'une tension élevée au niveau du connecteur BNC de la sonde différentielle.



## 3.6 Correcting the Probe Phase

For the following modules, always correct the probe phase before you use a probe for measurement.

- High-Speed 100 MS/s, 12-Bit Isolation Module: 720210 (HS100M12) and 720211 (HS100M12)
- High-Speed 10 MS/s, 12-Bit Isolation Module: 701250 (HS10M12) and 720250 (HS10M12)
- High-Speed High-Resolution 1 MS/s, 16-Bit Isolation Module: 701251 (HS1M16)
- High-Speed 10 MS/s, 12-Bit Non-Isolation Module: 701255 (NONISO\_10M12)
- Acceleration/Voltage Module (with AAF): 701275 (ACCL/VOLT)
- Frequency Module: 701281 (FREQ) and 720281 (FREQ)
- SENT Monitor Module: 720243 (SENT)
- 4-CH 1 MS/s, 16-Bit Isolation Module: 720254 (4CH 1M16)



### CAUTION

Do not apply external voltage to the probe compensation signal output terminal. This may cause damage to the internal circuitry.

### French



### ATTENTION

Ne pas appliquer de tension externe sur la borne de sortie de signal afin d'ajuster la compensation de sonde. Cela pourrait endommager le circuit interne.

1. Turn on the power switch.
2. Connect the probe to a signal input terminal (the terminal that you will actually apply the signal to measure to).
3. Connect the tip of the probe to the probe compensation signal output terminal on the front panel of the instrument, and connect the ground wire to the functional ground terminal.
4. Follow the instructions in section 4.5, "Performing Auto Setup," to perform auto setup on the probe.
5. Insert a screwdriver into the phase adjustment hole, and turn the variable capacitor so that the displayed waveform is an appropriate square wave.

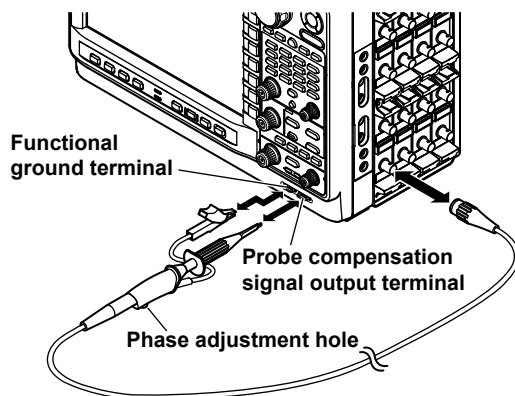

## Necessity of Phase Correction of the Probe

If the probe's input capacitance is not within the appropriate range, the gain will not be steady in relation to the frequency, and waveforms will not be displayed correctly. Also, because the input capacitance is not the same for each probe, the probe's have variable capacitors (trimmers) that need to be adjusted. This adjustment is referred to as phase correction.

Always correct the phase of a probe that you are using for the first time.

Also, because the appropriate input capacitance range is different for each channel, you need to perform phase correction when you change the channel that a probe is connected to.

## Phase Compensation Signal

The instrument generates the following square wave signal from the COMP signal output terminal.

Frequency: 1 kHz  $\pm$  1%

Computation: 1 V  $\pm$  10 %

## Differences in the Waveform due to the Phase Correction of the Probe

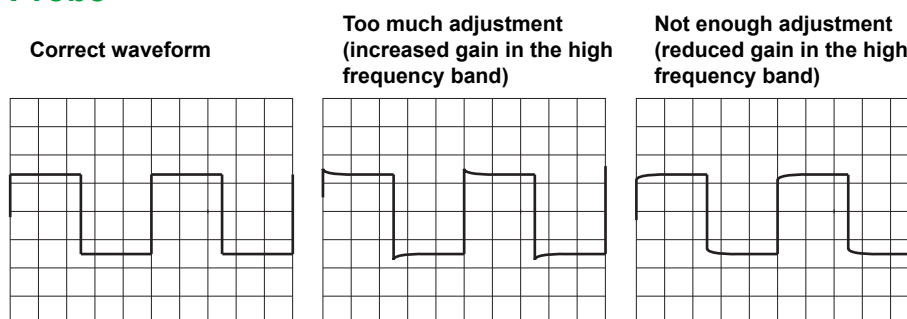

## Notes about Using Probes with the Frequency Module or SENT Monitor Module

You cannot perform phase correction on a probe connected to the frequency module and SENT monitor module. To use a probe with the frequency module or SENT monitor module, first perform phase correction on the probe using another module.

## 3.7 Connecting Measurement Leads

### Connecting Measurement Leads

When you measure voltage using the 701261 (UNIVERSAL), 701262 (UNIVERSAL (AAF)), 701267 (HV (with RMS)), 720268 (HV (AAF, RMS)), 701265 (TEMP/HPV), and 720266 (TEMP/HPV), connect the measurement leads of a plug-in type terminal to the input terminal.

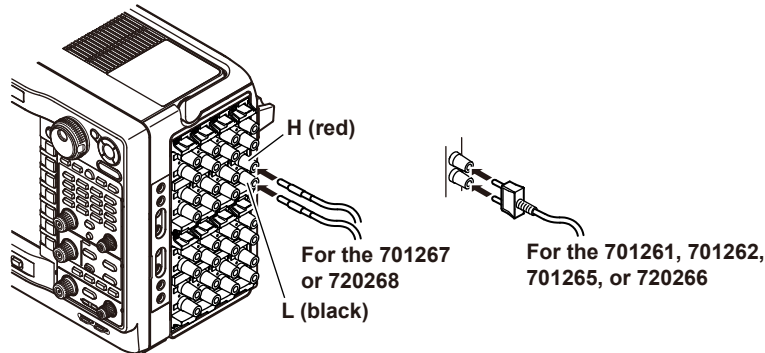

### WARNING

- When connecting a device under measurement to the instrument, be sure to turn off the device. It is extremely dangerous to connect or remove measurement leads while the device under measurement is on.
- When measuring high voltages, do not connect a plug-in type terminal with exposed conducting parts to the input terminal to be used as a measurement lead. It is very dangerous, if the connector comes loose.

#### Precautions to Be Taken When Using the Modules

- To prevent the possibility of electric shock, always connect measurement leads that match the voltage range that you are measuring to the signal input terminals of the 701261 (UNIVERSAL), 701262 (UNIVERSAL (AAF)), 701267 (HV (with RMS)), 720268 (HV (AAF, RMS)), 701265 (TEMP/HPV), and 720266 (TEMP/HPV).
- When measuring high voltages using the 701267 (HV (with RMS)) or 720268 (HV (AAF, RMS)), use a measurement lead (combination of 758933 and 701954) or 1:1 safety cables (combination of 701904 and 701954).

#### Maximum Input Voltage and Maximum rated voltage to earth for the Modules

Applying a voltage exceeding the value indicated below may damage the input section. If the frequency is above 1 kHz, damage may occur even when the voltage is below this value.

- **For the 701261, 701262, 701265, and 720266**  
Maximum input voltage (across the input terminals, H and L,<sup>1</sup> at a frequency of 1 kHz or less)  
42 V (DC+ACpeak)  
Maximum rated voltage to earth (across the input terminals, H or L, and earth,<sup>2</sup> at a frequency of 1 kHz or less)  
42 V (DC + ACpeak) (CAT II, 30 Vrms)

- **For the 701267 (HV (with RMS)) and 720268 (HV (AAF, RMS))**

Maximum input voltage (at a frequency of 1 kHz or less)

- Combination of 758933 measurement leads and 701954 alligator clips or combination of 701904 1:1 safety cables and 701954 alligator clips<sup>3</sup>  
850 V (DC + ACpeak)
- Direct input (cable that does not comply with the safety standards)<sup>6</sup>  
42 V (DC + ACpeak)

Maximum rated voltage to earth (at a frequency of 1 kHz or less)

- Combination of 758933 measurement leads and 701954 alligator clips or combination of 701904 1:1 safety cables and 701954 alligator clips<sup>5</sup>  
(Use caution because the overvoltage tolerance of 701267 differs between the low and high sides.)  
701267: 700 Vrms (CAT II) on the H side,<sup>4</sup> 400 Vrms (CAT II)<sup>5</sup> on the L side  
720268: 1000 Vrms (CAT II)<sup>4,5</sup>, 600 Vrms (CAT III)<sup>4,5</sup>
- Direct input (cable that does not comply with the safety standards)<sup>7</sup>  
42 V (DC + ACpeak) (CAT II, 30 Vrms)

**For the 701261, 701262, 701265, or 720266**

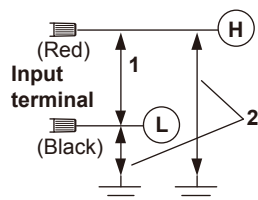

**For the 701267 or 720268**

With the 758933 and 701954, or 701904 and 701954

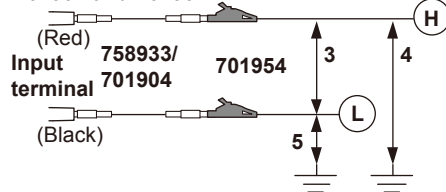

Direct input (cable that does not comply with the safety standards)

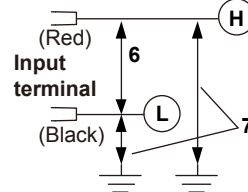

**Over-Range Indication**

If over-range is indicated, the DL850E/DL850EV may be receiving a voltage higher than the observed waveform or measured waveform values. To prevent electric shock, change the vertical scale with the SCALE knob so that the entire amplitude of the waveform is displayed within the waveform display area, and check the input voltage level.



← **Over-range indication**

Indicates the number of the channel that over-range is occurring on.

← **Channel indication when over-range is occurring on multiple channels**

Indicates the smallest number among the channels that over-range is occurring on.

**French**



**AVERTISSEMENT**

- Toujours mettre l'appareil à mesurer hors tension avant de le brancher sur l'instrument. Il est extrêmement dangereux de brancher un câble de mesure lorsque l'appareil à mesurer est sous tension.
- Lors de la mesure de tension élevées, ne pas relier une borne de type enfichable, avec des parties conductrices exposées, à la borne d'entrée à utiliser comme un fil de mesure. Il est très dangereux que le connecteur se détache.

### 3.7 Connecting Measurement Leads

#### Précautions à prendre lors de l'utilisation des modules

- Afin d'éviter le risque de choc électrique, toujours connecter les fils de mesure correspondant à la plage de tensions en cours de mesure aux bornes d'entrée de signal de 701261 (UNIVERSAL), 701262 (UNIVERSAL (AAF)), 701267 (HV (avec RMS)), 720268 (HV (AAF, RMS)), 701265 (TEMP/HPV) et 720266 (TEMP/HPV)
- Lorsque vous appliquez de hautes tensions au 701267 (HV (avec RMS)) et 720268 (HV (AAF, RMS)) utilisez un cordon de mesure (combinaison de 758933 et 701954) ou des câbles de sécurité 1:1 (combinaison de 701904 et 701954).

#### Tensions d'entrée maximales et tension nominale maximale à la terre les modules

L'application d'une tension supérieure à la valeur indiquée ci-dessous pourrait endommager la section d'entrée. Si la fréquence est supérieure à 1 kHz, une tension inférieure à cette valeur pourra tout de même endommager la section d'entrée.

##### • Pour 701261, 701262, 701265 et 720266

Tension d'entrée maximale (via les bornes d'entrée, H et L,<sup>1</sup> à une fréquence d'1 kHz ou moins)

42 V (c.c. + crête c.a.)

Tension nominale maximale à la terre (via les bornes d'entrée, H ou L, et la terre,<sup>2</sup> à une fréquence d'1 kHz ou moins)

42 V (c.c. + crête c.a.) (CAT II, 30 Vrms)

##### • Pour 701267 (HV (avec RMS)) et 720268 (HV (AAF, RMS))

Tension d'entrée maximale (à une fréquence de 1 kHz ou moins)

- Combinaison de fils de mesure 758933 et de pinces alligator 701954 ou combinaison de câble de sécurité 1:1 701904 et de pinces alligator 701954.<sup>3</sup>

850 V (c.c. + crête c.a.)

- Entrée directe (câble non conforme aux normes de sécurité<sup>6</sup>)

42 V (c.c. + crête c.a.)

Tension nominale maximale à la terre (à une fréquence 1 kHz ou inférieure)

- Combinaison de fils de mesure 758933 et de pinces alligator 701954 ou combinaison de câble de sécurité 1:1 701904 et de pinces alligator 701954.<sup>5</sup>

(Procéder avec soin, car la tolérance de surtension de 701267 diffère entre le bas et le haut.)

701267: 700 Vrms (CAT II) sur le côté H, <sup>4</sup> 400 Vrms (CAT II) <sup>5</sup> sur le côté L

720268: 1000 Vrms (CAT II) <sup>4</sup>

- Entrée directe (câble non conforme aux normes de sécurité<sup>7</sup>)

42 V (c.c. + crête c.a.) (CAT II, 30 Vrms)

#### Pour 701261, 701262 et 701265

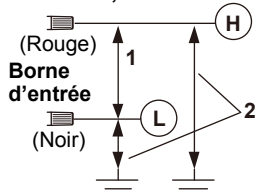

#### Pour 701267

Avec 758933 et 701954

Avec 701904 et 701954

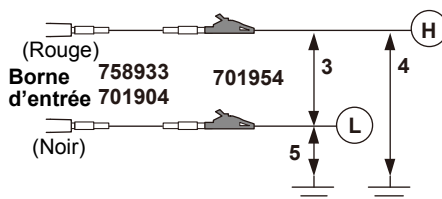

Entrée directe (câble non conforme aux normes de sécurité)

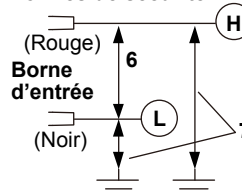

**Dépassement de plage**

En cas de dépassement de plage, le DL850E/DL850EV risque de recevoir une tension supérieure à la forme d'onde observée ou aux valeurs de forme d'onde mesurées. Pour éviter tout risque de choc électrique, modifier l'échelle de gain vertical à l'aide du bouton SCALE, de sorte que l'amplitude entière de la forme d'onde s'affiche sur l'afficheur, et vérifier le niveau de tension d'entrée.

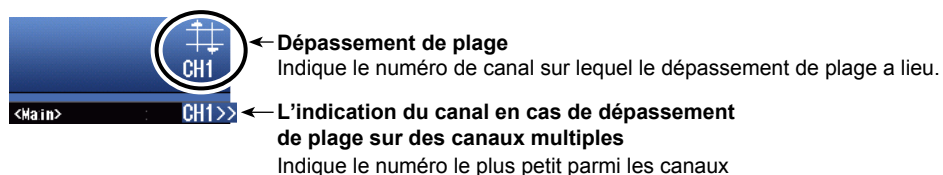

## 3.8 Connecting Thermocouples

### Connecting Thermocouples

If you are connecting the compensation lead of the thermocouple to the input terminal (binding post terminal) of the 701261 (UNIVERSAL), 701262 (UNIVERSAL (AAF)), 701265 (TEMP/HPV), or 720266 (TEMP/HPV), loosen the terminal knob, pass the lead through the terminal, and tighten the knob.

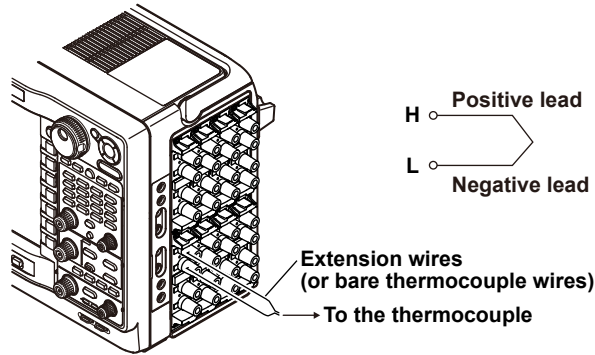

### WARNING

If over-range is indicated, the DL850E/DL850EV may be receiving a voltage higher than the observed waveform or measured waveform values. To prevent electric shock, check the input voltage level.

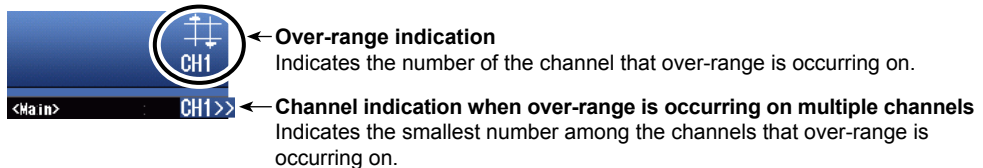

### CAUTION

- The 701261 (UNIVERSAL), 701262 (UNIVERSAL (AAF)), 701265 (TEMP/HPV), or 720266 (TEMP/HPV) is isolated from the DL850E/DL850EV. However, applying a voltage exceeding the value below may damage the input section. If the frequency is above 1 kHz, damage may occur even when the voltage is below this value.  
Maximum input voltage (across the input terminals, H and L, at a frequency of 1 kHz or less)  
42 V (DC + ACpeak)  
Maximum rated voltage to earth (across the input terminal L and earth at a frequency of 1 kHz or less)  
42 V (DC + ACpeak) (CAT II, 30 Vrms)
- Correct measurements cannot be obtained when the positive and negative thermocouple leads are connected in reverse.
- Immediately after connecting the thermocouple, the heat balance may be disturbed at the input terminal section and may cause measurement errors. Therefore, wait about ten minutes before making a measurement.
- In an environment where the air from the air conditioning is directly applied to the input terminals or where there are effects from a heat source, the heat balance may be disturbed at the input terminal section and cause measurement errors.  
When making measurements in this type of environment, take preventive measures such as changing the position.

## French

**AVERTISSEMENT**

En cas de dépassement de plage, le DL850E/DL850EV risque de recevoir une tension supérieure à la forme d'onde observée ou aux valeurs de forme d'onde mesurées. Pour éviter tout risque de choc électrique, vérifier le niveau de tension d'entrée.

← **Dépassement de plage**

Indique le numéro de canal sur lequel le dépassement de plage a lieu.

← **L'indication du canal en cas de dépassement de plage sur des canaux multiples**

Indique le numéro le plus petit parmi les canaux

**ATTENTION**

- 701261 (UNIVERSAL), 701262 (UNIVERSAL (AAF)), 701265 (TEMP/HPV) ou 720266 (TEMP/HPV) est isolé de DL850E/DL850EV. Cependant, le fait d'appliquer une tension dépassant la valeur inférieure risque d'endommager la section d'entrée. Si la fréquence est supérieure à 1 kHz, cela risque d'entraîner des dégâts, même si la tension est inférieure à cette valeur.

Tension d'entrée maximale (via les bornes d'entrée, H et L, à une fréquence d'1 kHz ou moins)

42 V (c.c. + crête c.a.)

Tension nominale maximale à la terre (via la borne d'entrée L et la terre à une fréquence d'1 kHz ou moins)

42 V (c.c. + crête c.a.) (CAT II, 30 Vrms)

- Il est impossible d'obtenir des mesures correctes si les fils de thermocouple positifs et négatifs sont branchés à l'envers.
  - Immédiatement après avoir branché le thermocouple, l'équilibreur thermique risque d'être perturbé dans la zone de la borne d'entrée, ce qui risque de causer des erreurs de mesure. C'est pourquoi, il faut attendre environ dix minutes avant d'effectuer une mesure.
  - Dans un environnement dans lequel l'air provenant de la climatisation est directement appliqué sur les bornes d'entrée ou dans lequel il existe des effets provenant de la source de chaleur, l'équilibreur de chaleur risque d'être perturbé dans la zone de la borne d'entrée, ce qui risque de causer des erreurs de mesure.
- Si des mesures sont réalisées dans ce type d'environnement, prendre des mesures préventives telles que le changement de position.



---

## 3.9 Connecting Bridgeheads

Strain is measured by connecting a strain gauge bridge (bridge head) or a strain gauge transducer to the strain module.

This section will mainly describe the procedures and precautions related to the connection of the bridge head (Model 701955, 701956, 701957, and 701958). For the connection of other strain gauge bridges or strain gauge transducers, see the respective manuals.

---

### CAUTION

Only connect a strain gauge bridge (bridge head) or a strain gauge transducer to the strain module. Connecting other devices or applying a voltage that exceeds the values indicated below to the strain module may damage the input section.

- Maximum input voltage (between Input+ and Input–)  
10 V (DC + AC<sub>peak</sub>)
- Maximum rated voltage to earth (between each terminal and earth ground)  
42 V (DC + AC<sub>peak</sub>) (CAT II, 30 V<sub>rms</sub>)

---

### French

---

### ATTENTION

Brancher seulement un pont de jauge de contrainte (tête de pont) ou un transducteur de jauge de contrainte au module de contrainte. Le fait de brancher d'autres appareils ou d'appliquer une tension dépassant les valeurs indiquées ci-dessous sur le module de contrainte risque d'endommager la zone d'entrée.

- Tension d'entrée maximale (entre l'entrée + et l'entrée –)  
10 V (c.c. + crête c.a.)
- Tension nominale maximale à la terre (entre chaque borne et mise à la terre)  
42 V (c.c. + crête c.a.) (CAT II, 30 V<sub>rms</sub>)

## Connecting the Strain Gauge

The bridge head (701955, 701956, 701957, and 701958) supports six types of connection methods: single-gauge method, single-gauge three-wire method, adjacent-side two-gauge method, opposite-side two-gauge method, opposite-side two-gauge three-wire method, and four-gauge method. For details, see the manual that came with the bridge head (701955, 701956, 701957, or 701958).

If you are using a strain gauge bridge or a strain gauge transducer other than the bridge head (701955, 701956, 701957, and 701958), see the respective manuals.

## Connecting the Strain Module and the Bridge Head

### When Using the Strain Module (701270) and the Bridge Head (701955 or 701956)

Using the cable that came with the bridge head (701955 or 701956), connect the Strain Module (701270) and the bridge head.

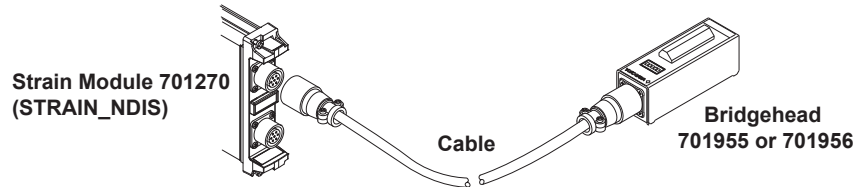

### When Using the Strain Module (701271) and the Bridge Head (701957 or 701958)

Using the cable that came with the bridge head (701957 or 701958), connect the Strain Module (701271) and the bridge head.

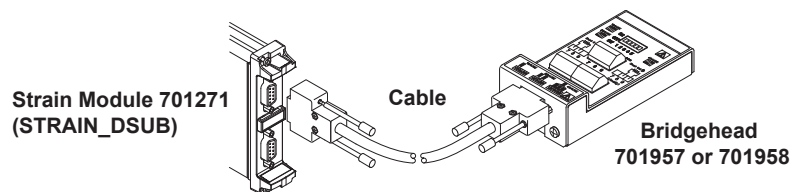

### When Using a Bridge Head with a MIL Standard (MIL-C-26482) Connector Wiring

The connector on the Strain Module (701270) is a NDIS connector.\* Use a connector adapter cable (700935) by YOKOGAWA to make a MIL-NDIS conversion and connect to the Strain Module (701270).

\* Connector recommended by JSNDI (Japanese Society for Non-Destructive Inspection)

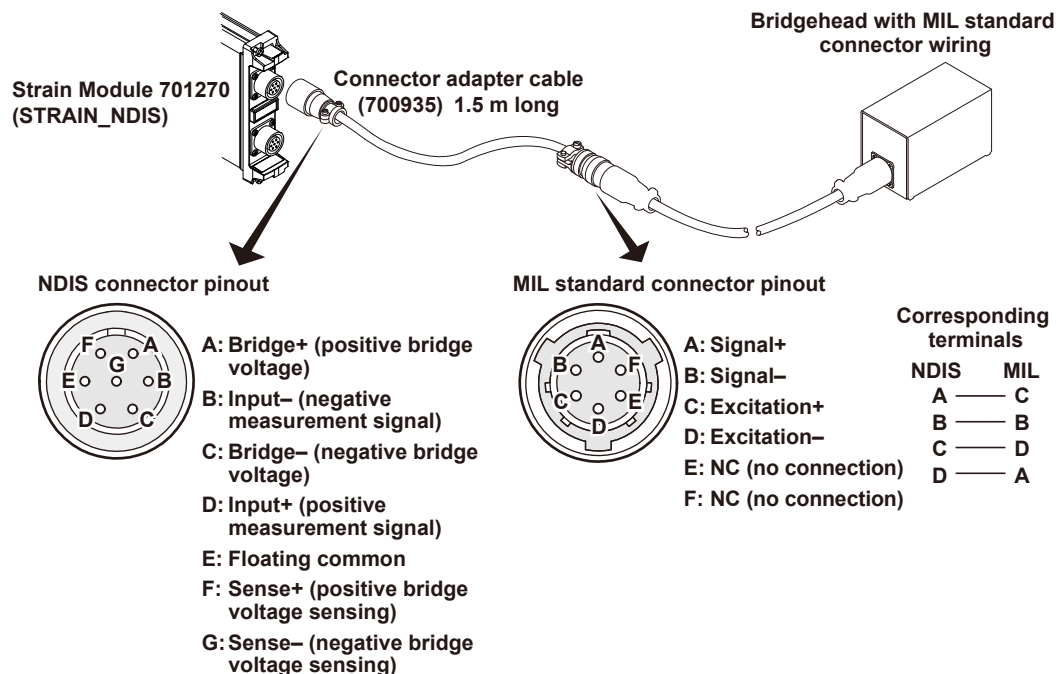

### 3.9 Connecting Bridgeheads

#### When Using the A1002JC Connector by YOKOGAWA

You can create your own cable by using the YOKOGAWA A1002JC connector that is compatible with the strain module and use the cable to connect a strain gauge bridge or a strain gage transducer to the strain module.

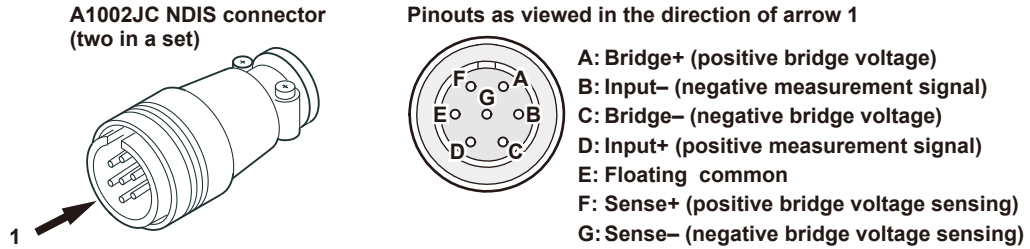

#### Note

- The connector shell is connected to the case potential of the DL850E/DL850EV.
- Each of the signals from A to G is isolated within the module.
- When creating your own cable, we recommend that you use a shielded cable in order to shut out external noise.



#### CAUTION

Take extra care when wiring the connectors. If the wiring is shorted or incorrect, it can damage the DL850E/DL850EV or other instruments that are connected to the DL850E/DL850EV.

#### French



#### ATTENTION

Redoubler de vigilance lors du câblage des connecteurs. Si le câblage est shunté ou incorrect, il risque d'endommager le dispositif DL850E/DL850EV ou d'autres instruments reliés à DL850E/DL850EV.

#### Pinout of the D-Sub Connector

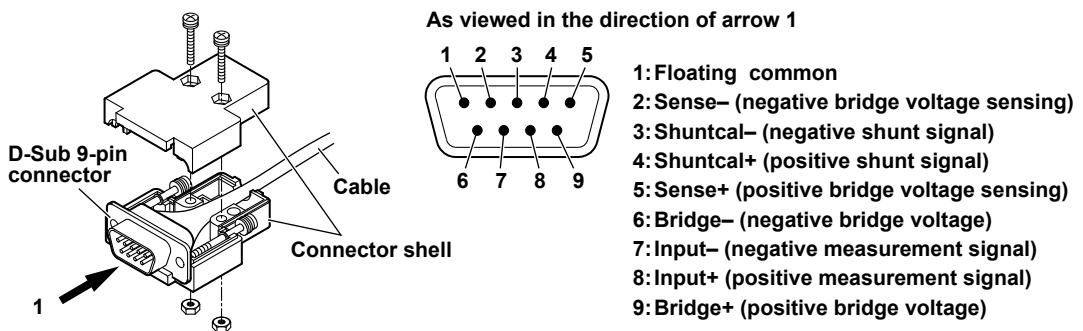

## 3.10 Connecting a Logic Probe to the Logic Input Module

To measure logic signals, connect a logic probe (the 702911, 702912, 700986, or 700987) to a logic input module (the 720230).



### CAUTION

- Applying a voltage greater than the limits listed below may damage the logic probe or the instrument. For frequencies above 1 kHz, damage may occur even if the voltage is less than the limits listed below.  
Maximum input voltage (at a frequency of 1 kHz or less)
  - Logic probes (702911 and 702912): 35 V
  - High-speed logic probe 700986: 42 V (DC + ACpeak)
  - Isolated logic probe 700987: 250 Vrms (however, ACpeak must be less than 350 V, and DC must be less than 250 V)
- For logic probes (702911 and 702912), and high-speed logic probe 700986, the eight input lines of a single pod share the same ground. Also, the instrument's ground and the grounds of each pod are connected. Do not apply signals with different common voltages to each input line. Doing so may damage the instrument, connected logic probes, and connected devices.
- The input terminals of an isolated logic probe are isolated from each other and from the DL850E/DL850EV.
- Turn off the DL850E/DL850EV before you connect or remove a 26-pin connector from the logic signal input connector.
- Do not stack the isolated logic probes during use. Also, allow enough space around the probes to avoid a temperature increase inside the probes.
- Do not use the YOKOGAWA 700985 logic probe with the DL850E/DL850EV. The 700985 is shaped so that it can be connected to the logic signal input connector of the DL850E/DL850EV, but it is not electrically compatible with the DL850E/DL850EV, so connecting the two could damage the DL850E/DL850EV or the 700985.

### French



### ATTENTION

- Le fait d'appliquer une tension supérieure aux limites mentionnées ci-dessous risque d'endommager la sonde logique ou l'instrument. Si la fréquence est supérieure à 1 kHz, une tension inférieure à cette valeur pourra tout de même endommager la section d'entrée.  
Tension d'entrée maximale (à une fréquence de 1 kHz ou moins)
  - Sondes logiques 702911 et 702912 : 35 V
  - Sonde logique à grande vitesse 700986 : 42 V (c.c. + crête c.a.)
  - Sonde logique isolée 700987 : 250 Vrms (cependant, la valeur crête c.a. doit être inférieure à 350 V et c.c. à 250 V)
- Pour les sondes logiques 702911, 702912 et la sonde logique à grande vitesse 700986, les huit lignes d'entrée d'une cosse unique partagent la même terre. De plus, la terre de l'instrument et celles de chaque cosse sont reliées. Ne pas émettre de signaux de tensions communes différentes vers chaque ligne d'entrée. Cela risquerait d'endommager l'instrument, les sondes logiques reliées et les appareils reliés.
- Les bornes d'entrée d'une sonde logique isolée sont isolées les unes des autres et de DL850E/DL850EV.

### 3.10 Connecting a Logic Probe to the Logic Input Module

---

- Éteindre DL850E/DL850EV avant de brancher un connecteur de 26 broches au connecteur d'entrée du signal logique ou de l'en retirer.
  - Ne pas empiler les sondes logiques isolées lors de leur utilisation. Laisser également suffisamment d'espace autour des sondes pour éviter une augmentation de température à l'intérieur des sondes.
  - Ne pas utiliser la sonde logique YOKOGAWA 700985 avec DL850E/DL850EV. Le dispositif 700985 est conçu pour pouvoir être branché au connecteur d'entrée de signal logique de DL850E/DL850EV, mais il n'est pas électriquement compatible au dispositif DL850E/DL850EV. Par conséquent, le fait de brancher les deux ensemble risque d'endommager DL850E/DL850EV ou 700985.
- 

## About the Logic Probe

### Types of Logic Probes

YOKOGAWA provides the following four types of probes (as accessories) for connecting to the logic signal input connector of the DL850E/DL850EV.

- 1 m Logic Probe 702911
- 3 m Logic Probe 702912
- High-Speed Logic Probe 700986
- Isolated Logic Probe 700987

### Types of Measurement Leads That Can Be Used

Use the following leads to connect to the point of measurement.

#### Types of Connection Leads That Can Be Used with Logic Probes (702911, 702912) and High-Speed Logic Probe 700986

The following two types are available.

- Connecting lead (alligator clip, parts No. B9879PX)  
This lead is primarily for connecting to contact circuits. The lead consists of 8 signal lines (red) and 8 earth lines (black).
- Connecting lead (IC clip, parts No. B9879KX)  
This lead is primarily for connecting to electronic circuits. The lead consists of 8 signal lines (red) and 2 earth lines (black).

#### Types of Measurement Leads That Can Be Used on the Isolated Logic Probe 700987

Use the following measurement lead.

- For measuring voltages of 42 V or more: Measurement lead for isolation logic 758917  
An alligator adapter (758922), alligator adapter (758929), or alligator clip (dolphin type, 701954) is needed to make measurements.

#### Note

---

Do not modify the connecting leads. Doing so may degrade their specifications.

---

## Connecting Logic Probes

### Logic Probes (702911, 702912) and High-Speed Logic Probe 700986

1. Attach the connecting lead (IC clip or alligator clip) that came with the logic probe, and push the logic probe levers inwards to lock the connector into place. To remove the connecting leads from the logic probe, push both of the levers outwards. Proceed to step 3.

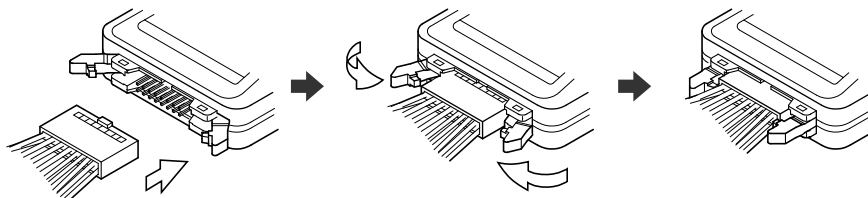

### Connecting the Isolated Logic Probe 700987

1. Connect the measurement leads to the logic probe's input terminal.
2. Set the input switch. When you set it to AC, the threshold levels are 50 VAC  $\pm$  50% (Hi: 80 to 250 VAC, Lo: 0 to 20 VAC); when you set it to DC, the threshold levels are 6 V  $\pm$  50% (Hi: 10 to 250 VDC, Lo: 0 to 3 VDC).

### Connecting the Logic Probe to a Logic Input Module

3. Turn the instrument's power switch off.
4. Connect to the logic signal input connector of the logic input module (720230) the end of the logic probe's 26-pin connector that has a clamp filter (ferrite core; part number: A1190MN).
5. Turn on the DL850E/DL850EV.

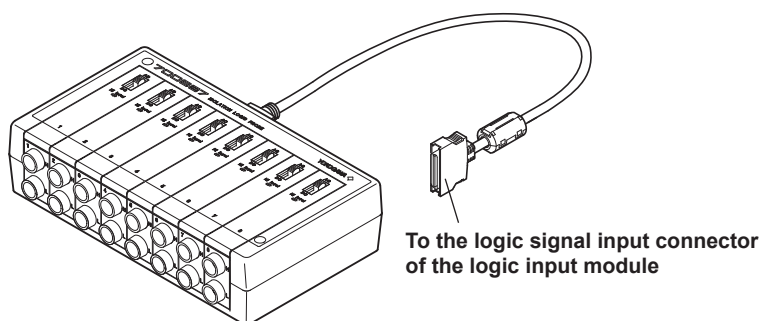

### Note

- When a logic probe is not connected to the DL850E/DL850EV, each bit is indicated as being at the high level.
- For the logic probe specifications, see section 6.14, "Logic Probe Specifications."
- The logic input display is turned off by default. For information about turning the display on and off, see chapter 1, "Vertical and Horizontal Control," in the user's manual.
- Before using logic probes (702911, 702912) or isolated logic probe 700987, flip the attenuation switch back and forth several times. The switch's electrical contacts can weaken if not used for long periods of time.

## 3.11 Connecting an Acceleration Sensor

An acceleration sensor is connected when measuring acceleration on the acceleration/voltage module (with AAF) (701275 (ACCL/VOLT)). For a details on acceleration sensors, see the respective manuals.



### WARNING

If over-range is indicated, the DL850E/DL850EV may be receiving a voltage higher than the observed waveform or measured waveform values. To prevent electric shock, change the vertical scale with the SCALE knob so that the entire amplitude of the waveform is displayed within the waveform display area, and check the input voltage level.

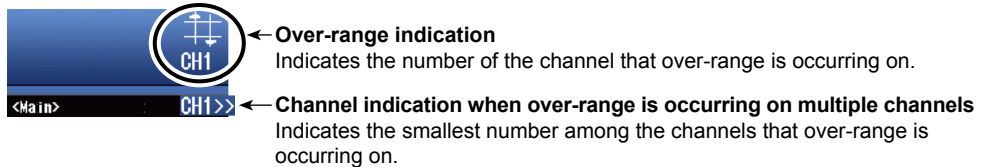

### CAUTION

- Applying a voltage that exceeds the values indicated below to the 701275 (ACCL/VOLT) may damage the input section.  
Maximum input voltage: 42 V (DC + AC<sub>peak</sub>)
- When connecting acceleration sensors, do it without the bias current being supplied to the sensor. Otherwise, damage to the internal circuitry of the acceleration sensors may result.
- The DL850E/DL850EV only supports acceleration sensors that are driven by constant current with driving current of 4 mA and driving voltage of 22 V.

### French



### AVERTISSEMENT

En cas de dépassement de plage, le DL850E/DL850EV risque de recevoir une tension supérieure à la forme d'onde observée ou aux valeurs de forme d'onde mesurées. Pour éviter tout risque de choc électrique, modifier l'échelle de gain vertical à l'aide du bouton SCALE, de sorte que l'amplitude entière de la forme d'onde s'affiche sur l'afficheur, et vérifier le niveau de tension d'entrée.

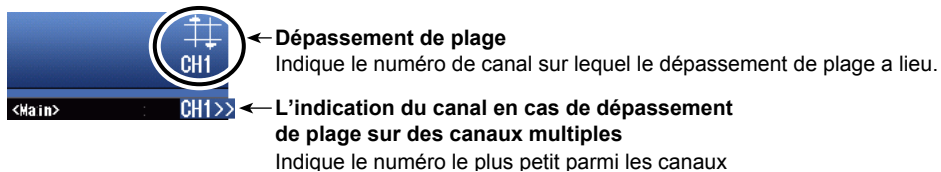

### ATTENTION

- Le fait d'appliquer une tension dépassant les valeurs indiquées ci-dessous sur 701275 (ACCL/VOLT) risque d'endommager la zone d'entrée.  
Tension d'entrée maximale : 42 V (c.c. + crête c.a.)
- Lors du branchement des capteurs d'accélération, faire en sorte que le courant de polarisation n'alimente pas le capteur. Cela risquerait en effet d'endommager les circuits internes des capteurs d'accélération.
- DL850E/DL850EV ne prend en charge que les capteurs d'accélération alimentés par un courant constant avec un courant d'entraînement de 4 mA et une tension d'entraînement de 22 V.

## Connecting Acceleration Sensors

### When Connecting Built-in Amplifier Type Acceleration Sensors

The DL850E/DL850EV allows built-in amplifier type (low impedance) acceleration sensors to be directly connected. To connect built-in amplifier type acceleration sensors, use BNC cables. Use cables that are appropriate for the acceleration sensors being used.

Connect the acceleration sensors with the bias current turned off. After connection, turn on the supply current to the acceleration sensors for making measurements.

### When Connecting Charge Output Type Acceleration Sensors

Since the charge output type (high impedance) acceleration sensors do not have built-in amplifier circuit, they cannot be directly connected to the DL850E/DL850EV. Use either of the following two methods to connect the sensors.

#### Using the Charge Amplifier

Connect a charge-output-type acceleration sensor to the charge amplifier using a high-insulation, low-noise cable. The acceleration signal (charge signal) that has been converted to a voltage signal by the charge amplifier is input to the DL850E/DL850EV using a normal coaxial cable. The DL850E/DL850EV measures the signal in the voltage measurement mode. The measured data can be converted to acceleration values using the scale conversion function of the DL850E/DL850EV.

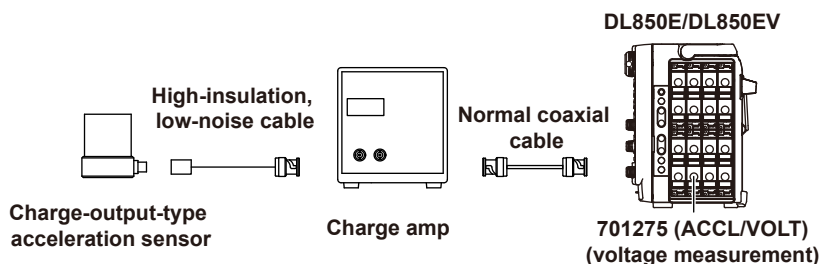

#### When using the charge converter

Connect a charge-output-type acceleration sensor to the charge converter using a high-insulation, low-noise cable. By driving the charge converter using a constant current from the DL850E/DL850EV, voltage signals similar to those of the built-in amplifier type acceleration sensor can be obtained. The DL850E/DL850EV measures the signals in the acceleration measurement mode and supplies bias current to the charge converter. Set the input sensitivity of the DL850E/DL850EV according to the charge converter gain and the sensitivity of the charge output type acceleration sensor. The DL850E/DL850EV only supports charge converters that are driven by constant current with driving current of 4 mA and driving voltage of 22 V.

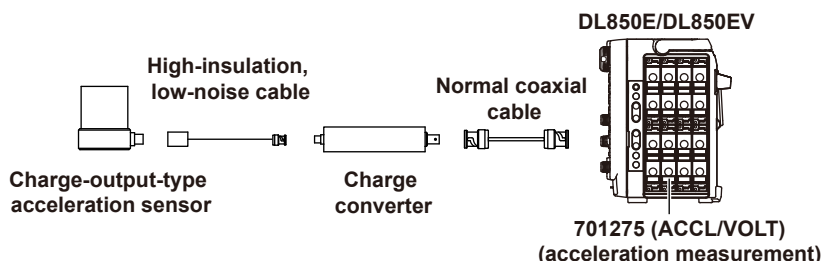

#### Note

The unit of measurement of acceleration on the DL850E/DL850EV is  $m/s^2$ . If the sensitivity is indicated in  $mV/G$  for the acceleration sensor that you are using, convert it to  $m/s^2$ . ( $1 G = 9.81 m/s^2$ )



#### Precautions

- Do not apply shock outside the specifications (see the manual for the acceleration sensor) to the acceleration sensors. Doing so can damage the sensors.
- Do not impose drastic temperature changes on the acceleration sensors. Temperature changes may affect the output value of the acceleration sensors.
- By default, the bias current on the acceleration sensors is turned off. Be sure to turn it on before using the acceleration sensors. Bias current is valid only when measuring acceleration. When measuring other parameters, it is automatically turned off. The bias current on/off setting is saved when the DL850E/DL850EV is turned off.

## 3.12 Connecting Sensors to the Frequency Module

### Sensors and Signal Output Sources That Can Be Connected

The table below shows the sensor and signal output source that can be connected. Appropriate input presets are provided for each sensor and signal output source. For information about presets, see Input Setup in section 1.7, “Configuring Frequency, Revolution, Period, Duty Cycle, Power Supply Frequency, Pulse Width, Pulse Integration, and Velocity Measurements,” in the user’s manual.

| Sensor and Signal Output Source  | Preset Name |
|--|-------------|
| 5-V logic signal, 5-V output sensor, and sensor with TTL output  | Logic 5V    |
| 3-V logic signal and 3-V output sensor   | Logic 3V    |
| 12-V driven relay/sequence circuit and 12-V driven sensor  | Logic 12V   |
| 24-V driven relay/sequence circuit and 24-V driven sensor  | Logic 24V   |
| Sensor/Encoder that outputs positive and negative voltages and sensor that outputs sine waves          | ZeroCross   |
| 100-VAC power supply (connected through the isolated probe (700929 or 701947) or passive probe 702902) | AC100V      |
| 200-VAC power supply (connected through the isolated probe (700929 or 701947) or passive probe 702902) | AC200V      |
| Power-generating electromagnetic pickup  | EM Pickup   |
| Open collector (0 to 5 V) output sensor, contact output  | Pull-up 5V* |

\* For the internal equivalent circuit when the preset setting is Pull-up 5V, see the “Frequency Measurement” section in chapter 2, “Vertical Axis” in the feature’s guide (IM DL850E-01EN).



#### WARNING

If over-range is indicated, the DL850E/DL850EV may be receiving a voltage higher than the observed waveform or measured waveform values. To prevent electric shock, change the vertical scale with the SCALE knob so that the entire amplitude of the waveform is displayed within the waveform display area, and check the input voltage level.



← **Over-range indication**

Indicates the number of the channel that over-range is occurring on.

← **Channel indication when over-range is occurring on multiple channels**

Indicates the smallest number among the channels that over-range is occurring on.

#### French



#### AVERTISSEMENT

En cas de dépassement de plage, le DL850E/DL850EV risque de recevoir une tension supérieure à la forme d’onde observée ou aux valeurs de forme d’onde mesurées. Pour éviter tout risque de choc électrique, modifier l’échelle de gain vertical à l’aide du bouton SCALE, de sorte que l’amplitude entière de la forme d’onde s’affiche sur l’afficheur, et vérifier le niveau de tension d’entrée.



← **Dépassement de plage**

Indique le numéro de canal sur lequel le dépassement de plage a lieu.

← **L’indication du canal en cas de dépassement de plage sur des canaux multiples**

Indique le numéro le plus petit parmi les canaux

## Precautions to Be Taken When Connecting to Sensors or Signal Output Sources



### CAUTION

- The maximum input voltage for direct input is indicated below. Applying a voltage exceeding this value can damage the input section. To apply high voltage that is 42 V or higher, be sure to connect through an isolated probe (700929 or 701947) or passive probe 702902. Maximum input voltage: 42 V (DC + ACpeak) (CAT II)
- The minimum input voltage is 0.2 Vpp. At voltage amplitude less than 0.2 Vpp, the measured values may be unstable.
- Attach/Remove the sensors after confirming that the rotating object to be measured is stopped.
- Set the preset to electromagnetic pickup (EM Pickup) only when using the electromagnetic pickup.

### French



### ATTENTION

- La tension d'entrée maximale de l'entrée directe est indiquée ci-dessous. Le fait d'appliquer une tension dépassant cette valeur risque d'endommager la section d'entrée. Pour appliquer une tension élevée de 42 V au moins, bien réaliser le branchement à l'aide d'une sonde isolée (700929 ou 701947) ou d'une sonde passive 702902. Tension d'entrée maximale : 42 V (c.c. + crête c.a.) (CAT II)
- La tension d'entrée minimale est 0,2 Vpp. Pour une amplitude de tension inférieure à 0,2 Vpp, les valeurs mesurées risquent d'être instables.
- Brancher/retirer les capteurs après avoir confirmé que l'objet rotatif à mesuré a été arrêté.
- Prérégler le paramétrage sur détection électromagnétique (EM Pickup) uniquement lors de l'utilisation de la détection électromagnétique.

## Connecting the Electromagnetic Pickup

- The DL850E/DL850EV allows power-generating electromagnetic pickup to be connected directly. The DL850E/DL850EV does not support electromagnetic pickups that require external power supply or those that require a terminator at the output.
- To connect electromagnetic pickups, use BNC cables. Use cables that are appropriate for the electromagnetic pickups being used.
- When the input is set to electromagnetic pickup, determination is not made on whether the input voltage level exceeds the specified input voltage range. Therefore, the LEDs (see page 3-10) do not illuminate even when the input voltage level is over range.

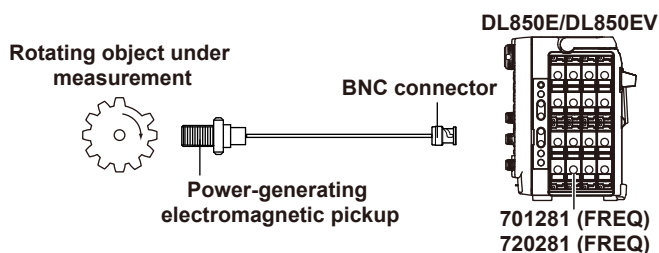

## 3.13 Connecting Wires to the 16-CH Voltage Input Module

To measure voltages with the 16-CH voltage input module (720220 (16CH VOLT)), connect wires to the terminal block.



### WARNING

When connecting a device under measurement to the instrument, be sure to turn off the device. It is extremely dangerous to connect or remove wires while the device under measurement is on.

#### Precautions to Be Taken When Using the Modules

- Do not apply input voltage exceeding the maximum input voltage or maximum rated voltage to earth.
- To avoid electric shock, be sure to ground the instrument.
- To prevent the possibility of electric shock, be sure to fasten the module screws. Otherwise, the electrical protection function and the mechanical protection function will not be activated.
- Avoid continuous connection under an environment in which the surge voltage may occur.
- To prevent electric shock, connect wires to the terminal block that match the voltage range that you are measuring.
- Applying a voltage exceeding the value indicated below may damage the input section. If the frequency is above 1 kHz, damage may occur even when the voltage is below this value.
  - Maximum input voltage (across the input terminals, H and L,<sup>1</sup> at a frequency of 1 kHz or less)
    - 42 V (DC + ACpeak)
  - Maximum rated voltage to earth (across the input terminals, H or L, and earth,<sup>2</sup> at a frequency of 1 kHz or less)
    - 42 V (DC + ACpeak) (CAT II, 30 Vrms)
- Wire the L input terminals for all of the sub channels on the same module to the same potential. The L input terminals of the sub channels are all common. Because the L input terminals are electrically connected inside the DL850E/DL850EV, connecting different potentials to them could result in short circuiting and damage to the 16-CH voltage input module.

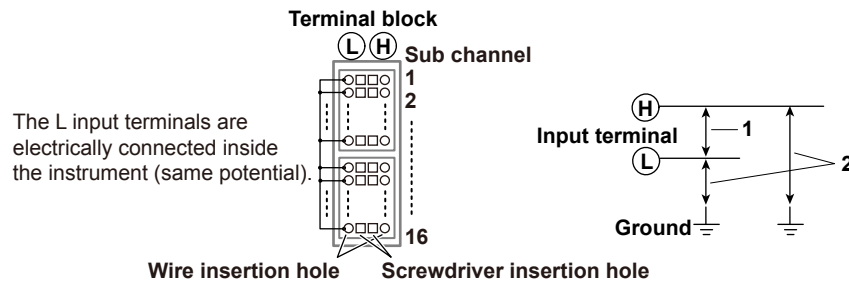

- When you release or lock the terminal block release levers, be careful not to injure yourself on the levers' protrusions.

#### Over-Range Indication

If over-range is indicated, the DL850E/DL850EV may be receiving a voltage higher than the observed waveform or measured waveform values. To prevent electric shock, change the vertical scale with the SCALE knob so that the entire amplitude of the waveform is displayed within the waveform display area, and check the input voltage level.

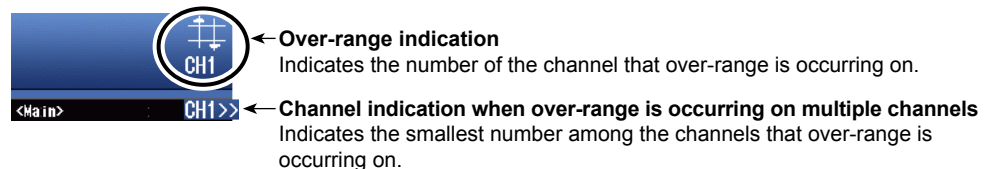

### CAUTION

When you attach the terminal block, if you try to attach it upside down, you may damage the terminal block and the module. Check the vertical orientation of the block before you install it.

French



**AVERTISSEMENT**

Toujours mettre l'appareil à mesurer hors tension avant de le brancher sur l'instrument. Il est extrêmement dangereux de brancher un câble de mesure lorsque l'appareil à mesurer est sous tension.

**Précautions à prendre lors de l'utilisation des modules**

- Ne pas dépasser les valeurs maximales de tension d'entrée, de tension nominale maximale à la terre.
- Pour éviter tout risque de choc électrique, l'instrument doit impérativement être relié à la terre.
- Pour éviter tout risque de choc électrique, toujours serrer les vis des modules, à défaut de quoi les fonctions de protection électrique et de protection mécanique ne seront pas activées.
- Éviter les connexions continues dans les environnements pouvant être soumis à surtension.
- Afin d'éviter un risque de choc électrique, raccorder les câbles au bornier qui correspondent à la plage de tensions en cours de mesure.
- L'application d'une tension supérieure à la valeur indiquée ci-dessous pourrait endommager la section d'entrée. Si la fréquence est supérieure à 1 kHz, une tension inférieure à cette valeur pourra tout de même endommager la section d'entrée.

Tension d'entrée maximale (via les bornes d'entrée, H et L,<sup>1</sup> à une fréquence d'1 kHz ou moins)  
42 V (c.c. + crête c.a.)

Tension nominale maximale à la terre (via les bornes d'entrée, H ou L et la terre,<sup>2</sup> à une fréquence d'1 kHz ou moins)

42 V (c.c. + crête c.a.) (CAT II, 30 Vrms)

- Câbler les bornes d'entrée L pour toutes les sous-voies sur le même module, au même potentiel. Les bornes d'entrée L des sous-voies sont toutes communes. Les bornes d'entrée L étant reliées électriquement à l'intérieur du dispositif DL850E/DL850EV, le fait d'y relier différents potentiels risque d'entraîner un court-circuit et d'endommager le module d'entrée de la tension 16-CH.

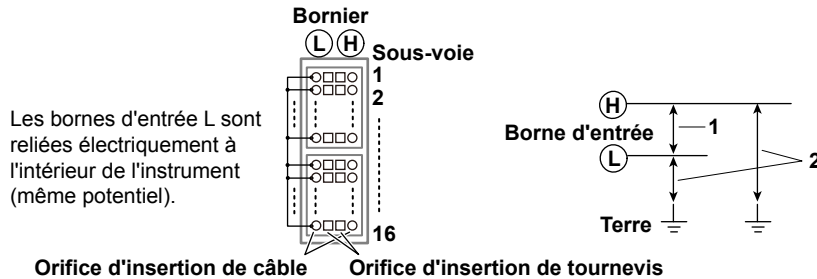

- Lors du déblocage ou blocage des leviers de desserrage du bornier, faire attention de ne pas se blesser contre les leviers.

**Dépassement de plage**

En cas de dépassement de plage, le DL850E/DL850EV risque de recevoir une tension supérieure à la forme d'onde observée ou aux valeurs de forme d'onde mesurées. Pour éviter tout risque de choc électrique, modifier l'échelle de gain vertical à l'aide du bouton SCALE, de sorte que l'amplitude entière de la forme d'onde s'affiche sur l'afficheur, et vérifier le niveau de tension d'entrée.

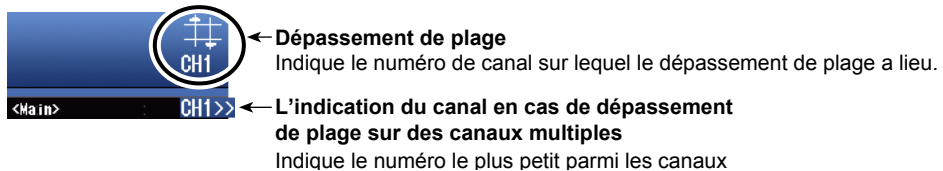

**ATTENTION**

Lors du branchement du bornier, s'il est branché à l'envers, cela risque d'endommager le bornier et le module. Vérifier l'orientation verticale du bornier avant de l'installer

## What to Prepare

### Wiring

Remove approximately 7 mm of the insulation from the ends of the wires.

Electrical wire: 0.20 mm<sup>2</sup> to 1.00 mm<sup>2</sup> recommended (solid wire or thin stranded wire). AWG size: 24-18.



### Flat-blade Screwdriver

Tip size: 0.4 mm (thickness) × 2.5 mm (width)

Shape: DIN5264-A (Use a straight driver.)

## Connecting Wires to the Terminal Block

First, turn off the DL850E/DL850EV. Make sure that the other end of the wire that you are connecting to the terminal block is not connected to the device under measurement, or make sure that the device under measurement that you are going to connect to is turned off.

1. Insert the flat-blade screwdriver into the screwdriver insertion hole right next to the wire insertion hole.  
Insert the flat-blade screwdriver into the hole firmly until the wire insertion hole will open.
2. Insert the wire that you prepared into the wire insertion hole.  
Insert the wire until it reaches the back of the wire insertion hole.
3. Pull the flat-blade screwdriver out of the screwdriver insertion hole.  
When you pull out the flat-blade screwdriver, hold the wire in place so that it does not come out with the screwdriver.
4. Pull lightly on the wire to make sure that it doesn't come out.

After you have finished connecting the wires, turn on the DL850E/DL850EV and the device under measurement.

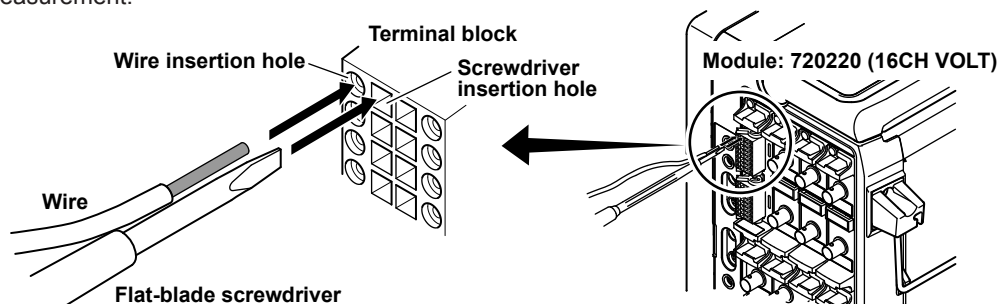

## Note

### Removing and Attaching the Terminal Block

It is normally not necessary to remove the terminal block, but it is possible to do so.

#### Removal

Push terminal block release levers 1 and 2 to their release positions, and pull out the terminal block.

#### Attachment

Push terminal block release levers 1 and 2 to their lock positions, and insert the terminal block. Push the terminal block firmly all the way to the back. However, the terminal block will not go all the way to the back if it is upside down. Do not try to force the terminal block all the way to the back.

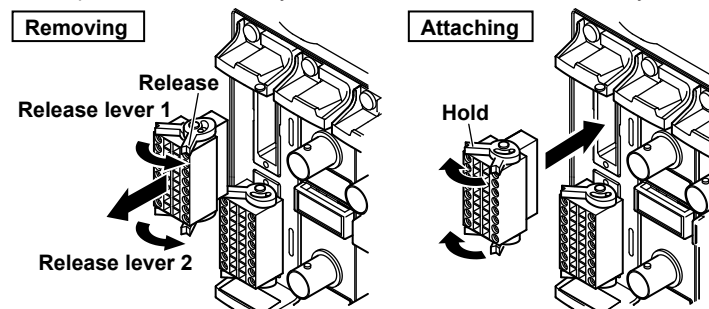

## 3.14 Connecting Wires to the 16-CH Temperature/Voltage Input Module

If you are using the 16-CH temperature/voltage input module (720221 (16CH TEMP/VOLT)) to measure temperature and voltage, connect thermocouples or wires to the 16-channel scanner box.



### WARNING

When connecting a device under measurement to the instrument, be sure to turn off the device. It is extremely dangerous to connect or disconnect thermocouples or wires while the device under measurement is on.

#### Precautions to Be Taken When Using the Modules

- To avoid electric shock, be sure to ground the instrument.
- To prevent the possibility of electric shock, be sure to fasten the module screws. Otherwise, the electrical protection function and the mechanical protection function will not be activated.

#### Precautions to Be Taken When Using the 16-CH Scanner Box

- Do not connect or disconnect the 16-CH scanner box or the cables that are connected to it while the power is on.
- Do not apply input voltage exceeding the maximum input voltage or maximum rated voltage to earth.
- Avoid continuous connection under an environment in which the surge voltage may occur.
- To prevent electric shock, connect wires to the terminal block that match the voltage range that you are measuring.
- Applying a voltage exceeding the value indicated below may damage the input section. If the frequency is above 1 kHz, damage may occur even when the voltage is below this value.  
Maximum input voltage (across the input terminals, + and -,<sup>1</sup> at a frequency of 1 kHz or less)  
42 V (DC + ACpeak)  
Maximum rated voltage to earth (across the input terminals, + or -, and earth,<sup>2</sup> at a frequency of 1 kHz or less)  
42 V (DC + ACpeak) (CAT II, 30 Vrms)
- The - input terminals of the sub channels are electrically insulated inside the scanner box. If you connect a wire that has a potential difference greater than 42 V (DC + ACpeak) between sub channels, the insulation may be damaged, which will lead to the 16-CH scanner box being damaged.

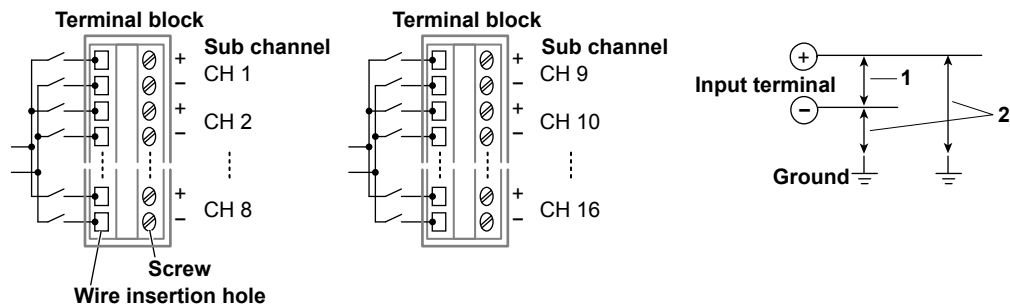

#### Over-Range Indication

If over-range is indicated, the DL850E/DL850EV may be receiving a voltage higher than the observed waveform or measured waveform values. To prevent electric shock, change the vertical scale with the SCALE knob so that the entire amplitude of the waveform is displayed within the waveform display area, and check the input voltage level.

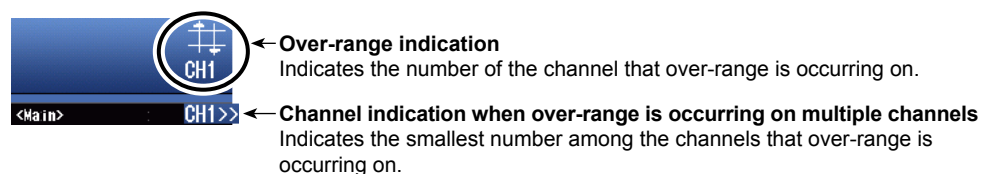



### CAUTION

- Correct measurements cannot be obtained when the positive and negative thermocouple leads are connected in reverse.
- Immediately after connecting the thermocouple, the heat balance may be disturbed at the input terminal section and may cause measurement errors. Therefore, wait about ten minutes before making a measurement.
- In an environment where the air from the air conditioning is directly applied to the input terminals or where there are effects from a heat source, the heat balance may be disturbed at the input terminal section and cause measurement errors.  
When making measurements in this type of environment, take preventive measures such as changing the position.

### French



### AVERTISSEMENT

Lors du raccordement d'un appareil en cours de mesure à l'instrument, s'assurer que l'appareil est éteint. Il est extrêmement dangereux de brancher ou débrancher des thermocouples ou des câbles lorsque l'appareil en cours de mesure est allumé.

#### Précautions à prendre lors de l'utilisation des modules

- Pour éviter tout risque de choc électrique, l'instrument doit impérativement être relié à la terre.
- Pour éviter tout risque de choc électrique, toujours serrer les vis des modules, à défaut de quoi les fonctions de protection électrique et de protection mécanique ne seront pas activées.

#### Précautions à prendre lors de l'utilisation de boîtier de scanner 16-CH

- Ne pas brancher ou débrancher le boîtier de scanner 16-CH ou les câbles qui y sont reliés s'ils sont sous tension.
- Ne pas dépasser les valeurs maximales de tension d'entrée, de tension nominale maximale à la terre.
- Éviter les connexions continues dans les environnements pouvant être soumis à surtension.
- Afin d'éviter un risque de choc électrique, raccorder les câbles au bornier qui correspondent à la plage de tensions en cours de mesure.
- L'application d'une tension supérieure à la valeur indiquée ci-dessous pourrait endommager la section d'entrée. Si la fréquence est supérieure à 1 kHz, une tension inférieure à cette valeur pourra tout de même endommager la section d'entrée.

Tension d'entrée maximale (via les bornes d'entrée, + et -,<sup>1</sup> à une fréquence d'1 kHz ou moins)  
42 V (c.c. + crête c.a.)

Tension nominale maximale à la terre (via les bornes d'entrée, + ou -, et la terre,<sup>2</sup> à une fréquence d'1 kHz ou moins)

42 V (c.c. + crête c.a.) (CAT II, 30 Vrms)

- Les bornes d'entrée - des sous-voies sont électriquement isolées à l'intérieur du boîtier de scanner. En cas de branchement d'un câble présentant une différence de potentiel supérieure à 42 V (c.c. + crête c.a.) entre les sous-voies, l'isolation risque d'être endommagée, ce qui causera des dégâts sur le boîtier de scanner 16-CH.

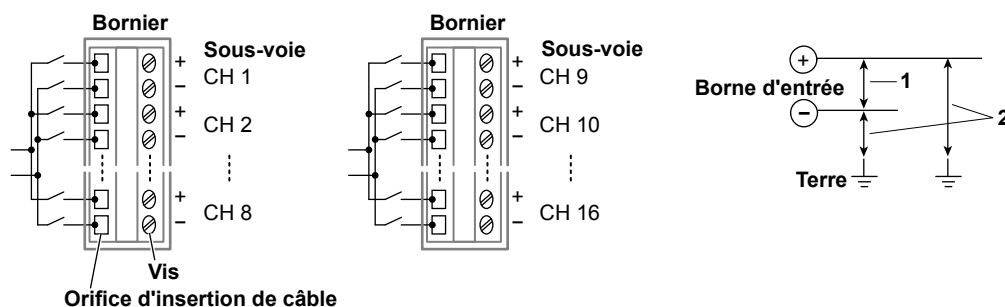



### 3.14 Connecting Wires to the 16-CH Temperature/Voltage Input Module

#### Dépassement de plage

En cas de dépassement de plage, le DL850E/DL850EV risque de recevoir une tension supérieure à la forme d'onde observée ou aux valeurs de forme d'onde mesurées. Pour éviter tout risque de choc électrique, modifier l'échelle de gain vertical à l'aide du bouton SCALE, de sorte que l'amplitude entière de la forme d'onde s'affiche sur l'afficheur, et vérifier le niveau de tension d'entrée.

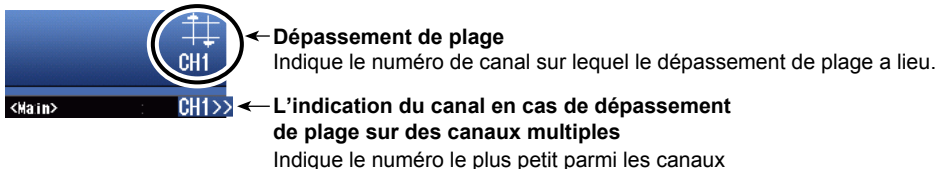

#### ATTENTION

- Il est impossible d'obtenir des mesures correctes si les fils de thermocouple positifs et négatifs sont branchés à l'envers.
- Immédiatement après avoir branché le thermocouple, l'équilibreur thermique risque d'être perturbé dans la zone de la borne d'entrée, ce qui risque de causer des erreurs de mesure. C'est pourquoi, il faut attendre environ dix minutes avant d'effectuer une mesure.
- Dans un environnement dans lequel l'air provenant de la climatisation est directement appliqué sur les bornes d'entrée ou dans lequel il existe des effets provenant de la source de chaleur, l'équilibreur de chaleur risque d'être perturbé dans la zone de la borne d'entrée, ce qui risque de causer des erreurs de mesure.  
Si des mesures sont réalisées dans ce type d'environnement, prendre des mesures préventives telles que le changement de position.

### What to Prepare

#### Thermocouple or Wiring

Remove approximately 7 mm of the insulation from the ends of the thermocouple or wires.

Electrical wire: 0.14 mm<sup>2</sup> to 1.5 mm<sup>2</sup> recommended (solid wire or thin stranded wire).

AWG size: 26-16.



#### Flat-blade Screwdriver

Tip size: 0.6 mm (thickness) × 3.5 mm (width)

Screw tightening torque: 0.5 to 0.6 N·m

### Connecting Wires to the Terminal Block

First, turn off the DL850E/DL850EV. Make sure that the other end of the wire that you are connecting to the terminal block is not connected to the device under measurement, or make sure that the device under measurement that you are going to connect to is turned off.

When you first use the 16-CH scanner box, follow the procedure from step 3.

1. Remove the protection cover screw using a screwdriver.
2. Pull the protection cover up, and pull it out from the guide hole.

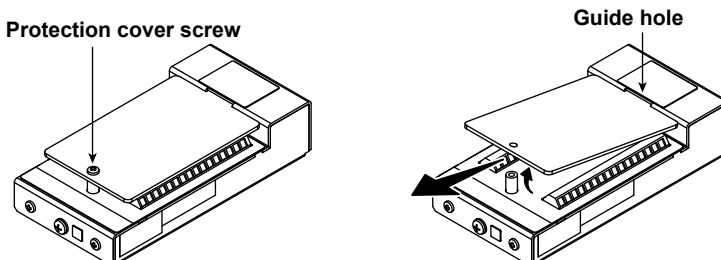

3. Loosen the terminal block screw using a flat-blade screwdriver.
4. Insert the thermocouple or wire that you prepared into the wire insertion hole. Insert the thermocouple or wire until its end reaches the back of the wire insertion hole.
5. Tighten the terminal block screw using a flat-blade screwdriver.

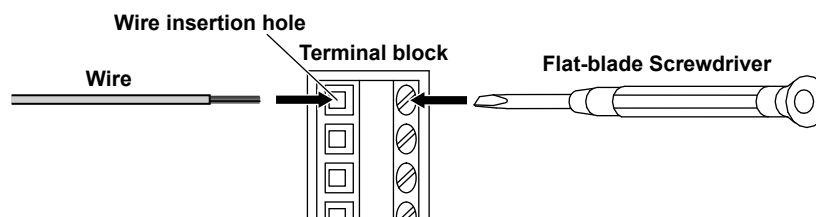

6. Pull lightly on the wire to make sure that it doesn't come out.
7. Insert the protection cover into the guide hole.
8. Tighten the protection cover screw using a screwdriver.

### Fixing the Device in Place

If necessary, you can use the accessory attaching plate, B8074LN, to fix the scanner box to the panel.

1. Align the small holes on the bottom side of the scanner box to the small projections of the attaching plate.
2. Screw the scanner box and the attaching plate together using the accessory binding screws (M4 × 5 mm).  
Screw tightening torque: 1.2 N·m

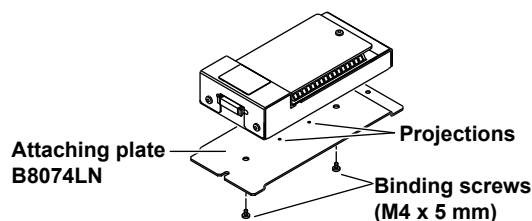

### Connecting the 16-CH Temperature/Voltage Input Module and the Scanner Box

Using the cable that came with the scanner box (701953), connect the 720221 (16CH TEMP/VOLT) and the scanner box.

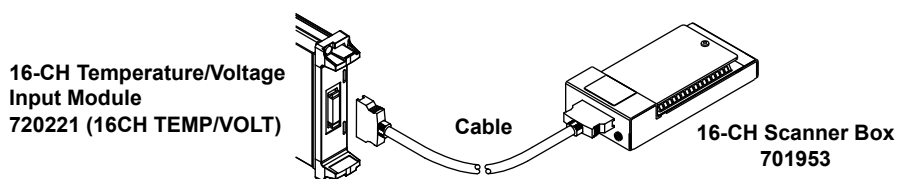

## 3.15 Connecting a Cable to the CAN Bus Monitor, CAN/CAN FD Monitor Module

To monitor CAN bus signals, connect a cable to the CAN bus monitor or CAN/CAN FD monitor module's D-sub connector. To monitor CAN/CAN FD bus signals, connect a cable to the CAN/CAN FD monitor module's D-sub connector.

### Connector Pinout

The pinout of the D-sub connector (9 pin, male) is shown below.

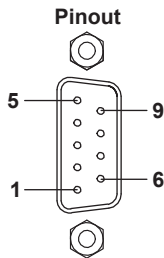

| Pin No. | Signal | Function                           |
|---------|--------|------------------------------------|
| 1       | (NC)   | Not used (can not be connected to) |
| 2       | CAN_L  | CAN low signal                     |
| 3       | GND    | Ground                             |
| 4       | (NC)   | Not used (can not be connected to) |
| 5       | (NC)   | Not used (can not be connected to) |
| 6       | GND    | Ground                             |
| 7       | CAN_H  | CAN high signal                    |
| 8       | (NC)   | Not used (can not be connected to) |
| 9       | (NC)   | Not used (can not be connected to) |

\* One-inch screws (number 4-40 UNC) are used.

#### Note

The connector shell is connected to GND. Additionally, GND and the connector shell are isolated from the electric potential of the DL850E/DL850EV case (earth).



#### CAUTION

Applying a voltage greater than the maximum input voltage may damage the input section.

#### French



#### ATTENTION

Le fait d'appliquer une tension dépassant la tension d'entrée maximale risque d'endommager la section d'entrée.

### Connecting the Cable (Signal wires)

When you connect a cable to the D-sub connector, be sure to tighten the screws to ensure that the cable is connected securely.

CAN bus monitor module 720240 (CAN MONITOR)  
CAN/CAN FD monitor module 720242 (CAN/CAN FD)

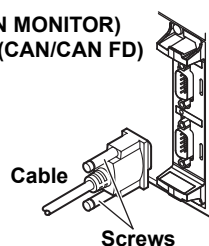

## 3.16 Connecting a Cable to the CAN & LIN Bus Monitor Module

To monitor CAN bus signals, connect a cable to the CAN bus monitor module's D-sub connector.

### Connector Pinout

The pinout of the D-sub connector (9 pin, male) is shown below.

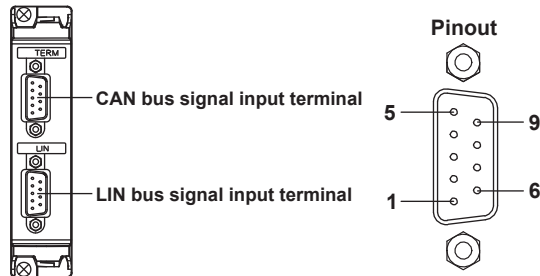

| Pin No. | CAN bus signal input terminal |                                    | LIN bus signal input terminal |                                    |
|---------|-------------------------------|------------------------------------|-------------------------------|------------------------------------|
|         | Signal                        | Function                           | Signal                        | Function                           |
| 1       | (NC)                          | Not used (can not be connected to) | LIN                           | LIN signal                         |
| 2       | CAN_L                         | CAN low signal                     | (NC)                          | Not used (can not be connected to) |
| 3       | CAN_GND                       | Ground                             | LIN_GND                       | Ground                             |
| 4       | (NC)                          | Not used (can not be connected to) | VBAT                          | Battery supply voltage             |
| 5       | (NC)                          | Not used (can not be connected to) | (NC)                          | Not used (can not be connected to) |
| 6       | CAN_GND                       | Ground                             | LIN_GND                       | Ground                             |
| 7       | CAN_H                         | CAN high signal                    | (NC)                          | Not used (can not be connected to) |
| 8       | (NC)                          | Not used (can not be connected to) | (NC)                          | Not used (can not be connected to) |
| 9       | (NC)                          | Not used (can not be connected to) | (NC)                          | Not used (can not be connected to) |

\* One-inch screws (number 4-40 UNC) are used.

### Note

The shell of the CAN bus signal input connector is connected to CAN\_GND. The shell of the LIN bus signal input connector is connected to LIN\_GND. Additionally, CAN\_GND and its connector shell and LIN\_GND and its connector shell are isolated from the electric potential of the DL850E/DL850EV case (earth).



### CAUTION

Applying a voltage greater than the maximum input voltage may damage the input section.

### French



### ATTENTION

Le fait d'appliquer une tension dépassant la tension d'entrée maximale risque d'endommager la section d'entrée.

### Connecting the Cable (Signal wires)

When you connect a cable to the D-sub connector, be sure to tighten the screws to ensure that the cable is connected securely.

CAN & LIN bus monitor module  
720241 (CAN & LIN)

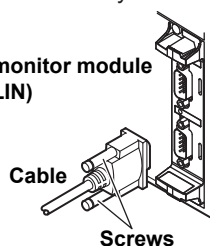

## 3.17 Attaching the Panel Sheet

Depending on the suffix code, attach the supplied front panel sheet if necessary. You can attach the panel sheet over the panel sheet that was attached when the DL850E/DL850EV was shipped from the factory.

### Attaching the Panel Sheet

There are three panel sheet attachment hooks on both the left and right sides of the front panel.

Hook the panel sheet onto the three hooks on the left side.

Then, bend the panel sheet slightly, and hook it onto the three hooks on the right side.

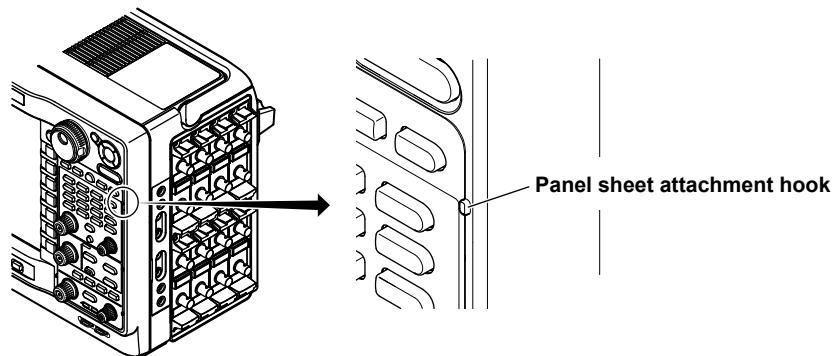

## 3.18 Loading Roll Paper into the Built-In Printer (Option)

This section explains how to load roll paper into the optional built-in printer.

### Printer Roll Paper

Only use roll paper specifically made for use with the DL850E/DL850EV series. The DL850E/DL850EV comes with one set of roll paper included. Use this when you first load roll paper into the built-in printer. When you need a new supply of roll paper, please contact your nearest YOKOGAWA dealer.

Part Number: B9988AE  
Specifications: Heat sensitive paper, 10 m  
Minimum Quantity: 10 rolls

### Handling Roll Paper

The roll paper is made of heat sensitive paper that changes color thermochemically. Please read the following information carefully.

#### Storage Precautions

The heat-sensitive paper changes color gradually at temperatures of approximately 70°C or higher. The paper can be affected by heat, humidity, light, and chemicals, whether something has been recorded on it. As such, please follow the guidelines listed below.

- Store the paper in a cool, dry, and dark place.
- Use the paper as quickly as possible after you break its protective seal.
- If you attach a plastic film that contains plasticizing material, such as vinyl chloride film or cellophane tape, to the paper for a long time, the recorded sections will fade due to the effect of the plasticizing material. Use a holder made of polypropylene to store the roll paper.
- When pasting the record paper to another material, do not use paste that contains organic solvents such as alcohol or ether. Doing so will change the paper's color.
- We recommend that you make copies of the recordings if you intend to store them for a long period of time. Because of the nature of heat-sensitive paper, the recorded sections may fade.

#### Handling Precautions

- Only use genuine, YOKOGAWA-supplied roll paper.
- If you touch the roll paper with sweaty hands, there is a chance that you will leave fingerprints on the paper, or blur the recorded sections.
- If you rub something hard against the surface of the roll paper, the paper may change color due to frictional heat.
- If the roll paper comes into contact with products such as chemicals or oil, the paper may change color or the recorded sections may disappear.

## Attaching the Roll Paper



### CAUTION

- Do not touch the print head. If you do, you may burn yourself.
- Do not touch the roll paper cutter section at the front end of the printer cover. Doing so may cause injury.

### French



### ATTENTION

- Ne pas toucher la tête d'impression. Vous pourriez vous brûler.
- Ne pas toucher la section du coupe-papier à l'extrémité du cache de l'imprimante. Vous pourriez vous blesser.

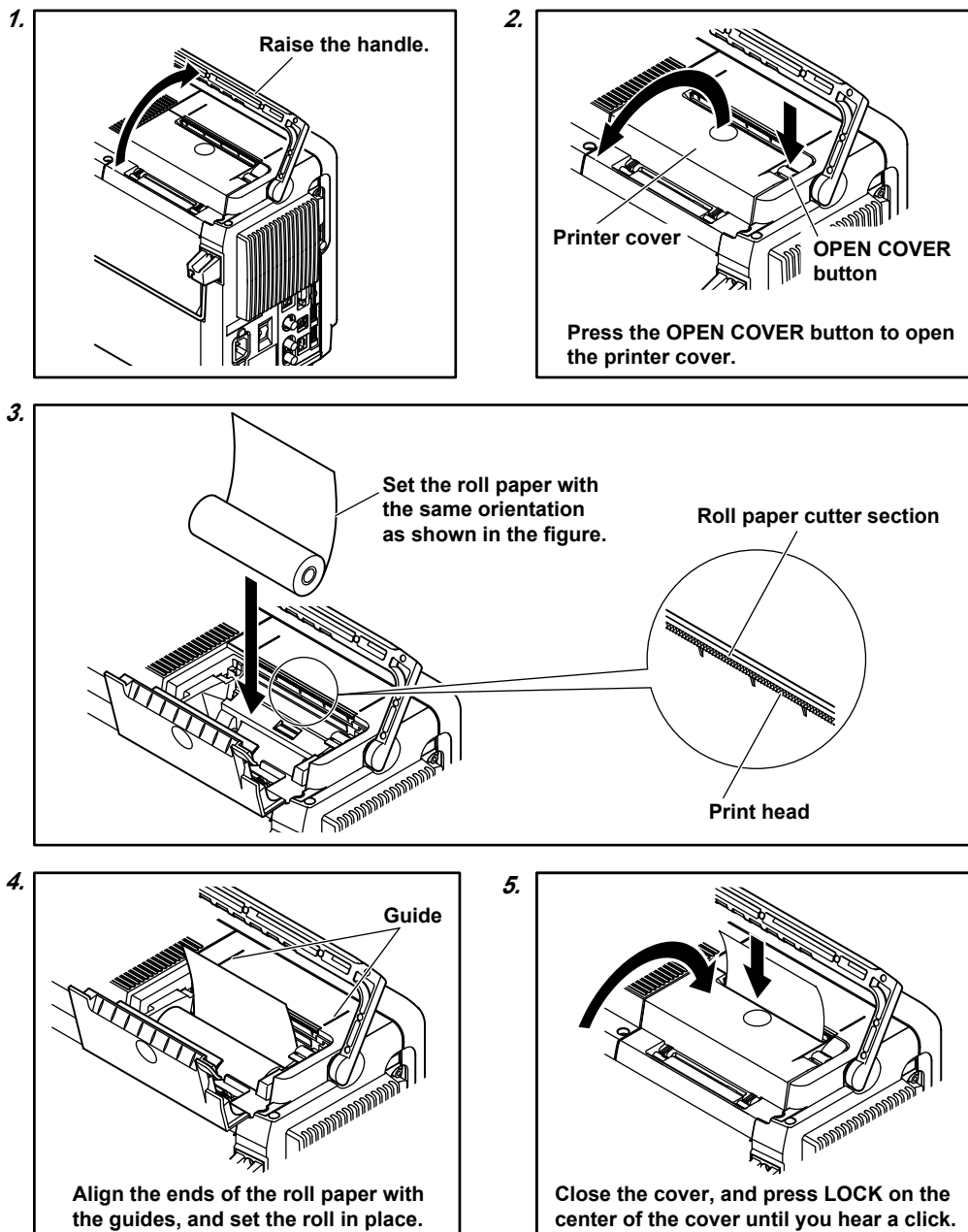

## 3.19 Connecting an Antenna to the GPS Interface (Option)

To synchronize the clock using GPS, connect the supplied GPS antenna to the clock sync signal input terminal

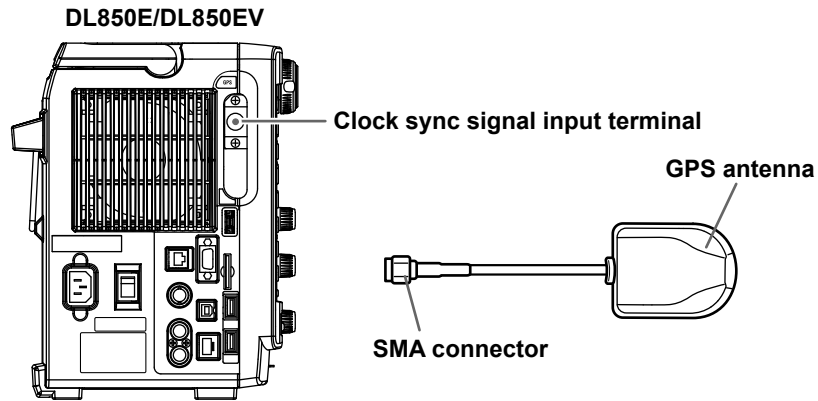

### CAUTION

- Attach or remove the GPS antenna from the DL850E/DL850EV with the power turned off.
- If installed indoors, place the GPS antenna near a window or a location where it has a good line of sight to GPS satellites.  
Otherwise, time synchronization may not work properly.
- Do not install the GPS antenna in water or in contact with other liquids.

### French

### ATTENTION

- Brancher l'antenne GPS à DL850E/DL850EV ou l'en retirer avec l'alimentation coupée.
- Si elle est installée à l'intérieur, placer l'antenne GPS à proximité d'une fenêtre ou de l'endroit où la connexion avec les satellites GPS est bonne.  
La synchronisation des durées risque sinon de ne pas se faire correctement.
- Ne pas installer l'antenne GPS dans l'eau ou au contact d'autres liquides..



## 4.1 Key and Jog Shuttle Operations

### Key Operations

#### How to Use Setup Menus That Appear When Keys Are Pressed

The operation after you press a key varies depending on the key that you press.



- A: Press the soft key to display a selection menu.  
 Press the soft key that corresponds to the appropriate setting.
- B: Press the soft key to use the jog shuttle to configure this setting. Use the jog shuttle or the arrow keys to set the value or select an item.  
 To set a value, press NUM LOCK, and then use the CH1 to CH16 keys.
- C: A related setup menu appears when you press the soft key.
- D: Press the soft key to execute the specified feature.
- E: Selects which item to configure when configuring a feature that consists of two items that operate with different settings, such as the FFT1 and FFT2 features.
- F: The selected setting switches each time you press the soft key.
- G: Displays a dialog box or a keyboard.  
 Use the jog shuttle, SET key, and arrow keys to configure the settings in the dialog box or operate the keyboard.
- H: Pressing a key sets the item to the setting that corresponds to that key.

#### How to Display the Setup Menus That Are Written in Purple below the Keys

In the explanations in this manual, "SHIFT+key name (written in purple)" is used to indicate the following operation.

1. Press **SHIFT**. The SHIFT key illuminates to indicate that the keys are shifted.  
 Now you can select the setup menus written in purple below the keys.
2. Press the key that you want to display the setup menu of.

#### ESC Key Operation

If you press the ESC key when a setup menu or available settings are displayed, the screen returns to the menu level above the current one. If you press the ESC key when the highest level menu is displayed, the setup menu disappears.

## 4.1 Key and Jog Shuttle Operations

### RESET Key Operation

If you press RESET when you are using the jog shuttle to set a value or select an item, the setting is reset to its default value (depending on the operating state of the DL850E/DL850EV, the setting may not be reset).

### SET Key Operations

The operation varies as indicated below depending on what you are setting.

- For a setup menu that has two values that you use the jog shuttle to adjust  
Press SET to switch the value that the jog shuttle adjusts.
- For a menu that has the jog shuttle + SET mark (⊙+⊕) displayed on it.  
Press SET to confirm the selected item.

### Arrow Key Operations

The operation varies depending on what you are setting.

- When setting a value  
Up and down arrow keys: Increases and decreases the value  
Left and right arrow keys: Changes which digit to set
- When selecting the item to set  
You can use the up and down arrow keys.

## How to Enter Values in Setup Dialog Boxes

1. Use the keys to display the appropriate setup dialog box.
2. Use the **jog shuttle** or the **arrow** keys to move the cursor to the setting that you want to set.
3. Press **SET**. The operation varies as indicated below depending on what you are setting.
  - A selection menu appears.
  - A check box is selected or cleared.
  - An item is selected.
  - A table of settings is selected.

### Displaying a Selection Menu and Selecting an Item

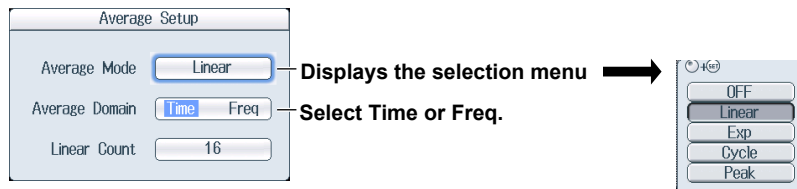

After selecting an item with the jog shuttle, press SET to confirm it.

### Setting Items in a Table

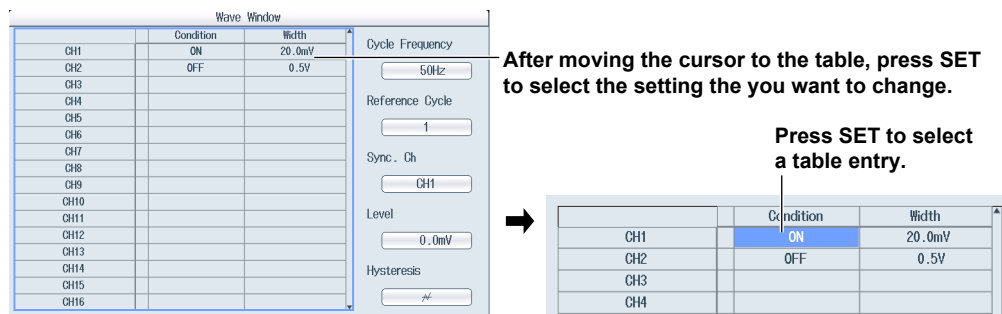

### How to Clear Setup Dialog Boxes

Press **ESC** to clear the setup dialog box from the screen.

## 4.2 Entering Values and Strings

### Entering Values

#### Using Dedicated Knobs

You can use the following dedicated knobs to enter values directly.

- Vertical POSITION knob
- SCALE knob
- TIME/DIV knob
- ZOOM magnification knob (MAG)
- Zoom POSITION knob (for scrolling zoom waveforms)

#### Using the Jog Shuttle

Select the appropriate item using the soft keys, and change the value using the jog shuttle, the SET key, and the arrow keys. This manual sometimes describes this operation simply as “using the jog shuttle.”

#### Using the Keypad

Press **NUM LOCK** to illuminate the NUM LOCK key, and use the **CH1** to **CH16** keys to enter a value. After you enter the value, press **ENTER** to confirm it.

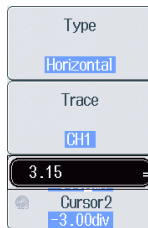

Use the keypad to enter the value.

#### Note

Some items that you can set using the jog shuttle are reset to their default values when you press the RESET key.

## Entering Character Strings

Use the keyboard that appears on the screen to enter file names and comments. Use the jog shuttle, the SET key, and the arrow keys to operate the keyboard and enter a character string.

### How to Operate the Keyboard

1. Press the **InputMode** soft key and then the **English** soft key.
2. After bringing up the keyboard, use the jog shuttle to move the cursor to the character that you want to enter. You can also move the cursor using the up, down, left, and right arrow keys.
3. Press SET to enter the character.
  - If a character string has already been entered, use the arrow soft keys (< and >) to move the cursor to the position you want to insert characters into.
  - To switch between uppercase and lowercase letters, press the **Caps** soft key.
  - To delete the previous character, press the **BS** soft key.
4. Repeat steps 1 and 3 to enter all of the characters in the string.
 

Select  on the keyboard or press the **History** soft key to display a list of character strings that you have entered previously.

Use the jog shuttle to select a character string, and press **SET** to enter the selected character string.
5. Press the **ENTER** soft key, or move the cursor to ENTER on the keyboard, and press **SET** to confirm the character string and clear the keyboard.

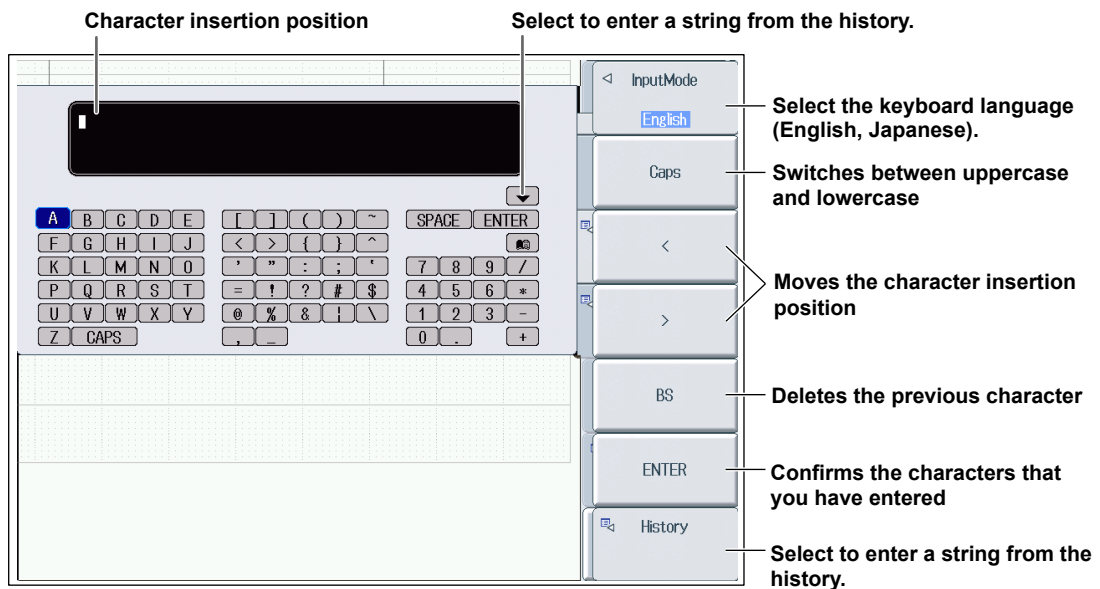

#### List of previously entered strings



After selecting an item using the jog shuttle or the arrow keys, press SET to confirm it.

#### Note

- @ cannot be entered consecutively.
- File names are not case-sensitive. Comments are case-sensitive. The following file names cannot be used due to MS-DOS limitations:  
AUX, CON, PRN, NUL, CLOCK, COM1 to COM9, and LPT1 to LPT9

## 4.3 Using USB Keyboards and Mouse Devices

### Connecting a USB Keyboard

You can connect a USB keyboard and use it to enter file names, comments, and other items.

#### Usable Keyboards

You can use the following keyboards that conform to USB Human Interface Devices (HID) Class Ver. 1.1.

- When the USB keyboard language is English: 104 keyboards
- When the USB keyboard language is Japanese: 109 keyboards

#### Note

- Do not connect incompatible keyboards.
- The operation of USB keyboards that have USB hubs or mouse connectors is not guaranteed.
- For USB keyboards that have been tested for compatibility, contact your nearest YOKOGAWA dealer.

#### USB Ports for Peripherals

Connect a USB keyboard to the USB port for peripherals on the left side panel.

#### Connection Procedure

Connect a USB keyboard directly to the DL850E/DL850EV using a USB cable. You can connect or remove the USB cable regardless of whether the DL850E/DL850EV power switch is turned on (hot-plug support). Connect the type A connector of the USB cable to the DL850E/DL850EV, and connect the type B connector to the keyboard. When the power switch is on, the keyboard is detected and enabled approximately 6 seconds after it is connected.

#### Note

- Only connect a compatible USB keyboard, mouse, printer, or storage device to the USB port for peripherals.
- Do not connect multiple keyboards. You can connect one keyboard, one mouse, and one printer to the DL850E/DL850EV.
- Do not connect and disconnect multiple USB devices repetitively. Wait for at least 10 seconds after you connect or remove one USB device before you connect or remove another USB device.
- Do not remove USB cables during the time from when the DL850E/DL850EV is turned on until key operation becomes available (approximately 20 to 30 seconds).

#### Entering File Names, Comments, and Other Items

When a keyboard is displayed on the screen, you can enter file names, comments, and other items using the USB keyboard.

#### Entering Values

You can use a USB keyboard to enter the values of items with  $\text{Ⓒ}_{123}$  marks on the menu screens by pressing CTRL+N on the USB keyboard to put the DL850E/DL850EV in the NUM LOCK state.

### Using a USB Mouse

You can connect a USB mouse and use it to perform the same operations that you can perform with the DL850E/DL850EV keys. Also, by clicking a menu item, you can perform the same operation that you can perform by pressing the menu item's soft key or selecting the menu item and pressing the SET key.

#### USB Ports for Peripherals

Connect a USB mouse to a USB port for peripherals on the left side panel of the DL850E/DL850EV.

#### Usable USB Mouse Devices

You can use mouse devices (with wheels) that are compliant with USB HID Class Version 1.1.

#### Note

---

- For USB mouse devices that have been tested for compatibility, contact your nearest YOKOGAWA dealer.
  - Some settings cannot be configured by a mouse without a wheel.
- 

#### Connection Procedure

To connect a USB mouse to the DL850E/DL850EV, use one of the USB ports for peripherals. You can connect or disconnect the USB mouse at any time regardless of whether the DL850E/DL850EV is on or off (hot-plugging is supported). When the power switch is on, the mouse is detected approximately 6 seconds after it is connected, and the mouse pointer (⤠) appears.

#### Note

---

- Only connect a compatible USB keyboard, mouse, printer, or storage device to the USB port for peripherals.
  - Even though there are two USB ports for peripherals, do not connect two mouse devices to the DL850E/DL850EV.
-

## Operating the DL850E/DL850EV Using a USB Mouse

- Operations That Correspond to the Front Panel Keys (Top Menu)

### Displaying the Top Menu

Right-click on the display. A menu of the DL850E/DL850EV front panel keys appears.

### Selecting an Item from the Top Menu

Click on the item that you want to select. A setup menu that corresponds to the item that you selected appears at the bottom of the display. The top menu disappears.

To display an item's submenu, point to the item. To select an item on a submenu, click on it, just as you would to select an item on the top menu.

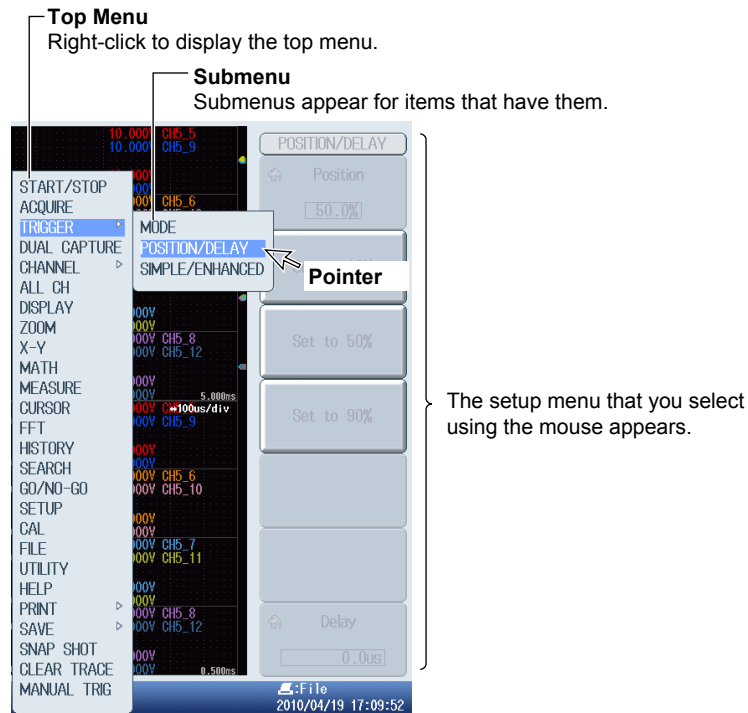

### Note

The following keys are not displayed in the top menu:  
ESC, RESET, and SET

### 4.3 Using USB Keyboards and Mouse Devices

- **Setup Menu Operations (Same as soft key operations)**

#### Selecting a Setup Menu Item

Click the setup menu item that you want to select.

If a selection menu appears after you select an item, click the selection menu item that you want to choose.

If an item such as ON or OFF appears, click on the item to change its setting.

For menu items that are usually selected using the jog shuttle and the SET key, clicking on the item that you want to select will confirm your selection and close the dialog box.

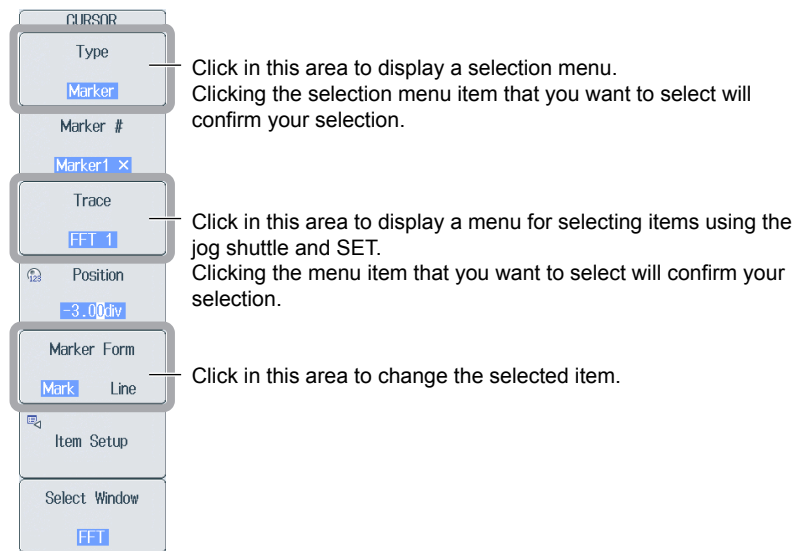

#### Clearing the Menu

To clear the menu, click outside of it.

- **Specifying Values**

The following description explains how to specify values for menu items that have a  $\text{C}_{123}$  icon next to them.

- If there are two  $\text{C}_{123}$  icons next to a single menu item, click on the item to select an item to configure.
- To increase a value, rotate the mouse wheel back.
- To decrease a value, rotate the mouse wheel forward.
- To increase a value, move the pointer above the value so that the pointer becomes a  $\text{C}_{123}$ , and then click the left mouse button.
- To decrease a value, move the pointer below the value so that the pointer becomes a  $\text{C}_{123}$ , and then click the left mouse button.
- To move the decimal place, point to the left or right of the value you want to set so that the pointer becomes a  $\text{C}_{123}$  or a  $\text{C}_{123}$ , and then click the left mouse button. The decimal place will move one place to the right or left each time you click the left mouse button.

**Change the value by clicking and using the mouse wheel.**

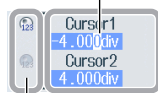

**Click within this area to select the item that you want to set.**



• **Selecting Check Boxes**

To select a check box, click it. To clear a check box, click it again.

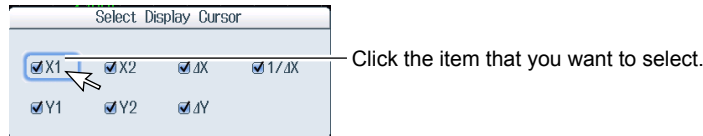

**Note**

To close a dialog box, click outside of it.

• **Selecting a File, Folder, or Media Drive from the File List Window**

Click on a file, folder, or media drive to select it.

Rotate the mouse wheel to scroll through the file list.

To cancel your selection, click outside of the File List window. The File List window will close when you cancel your selection.

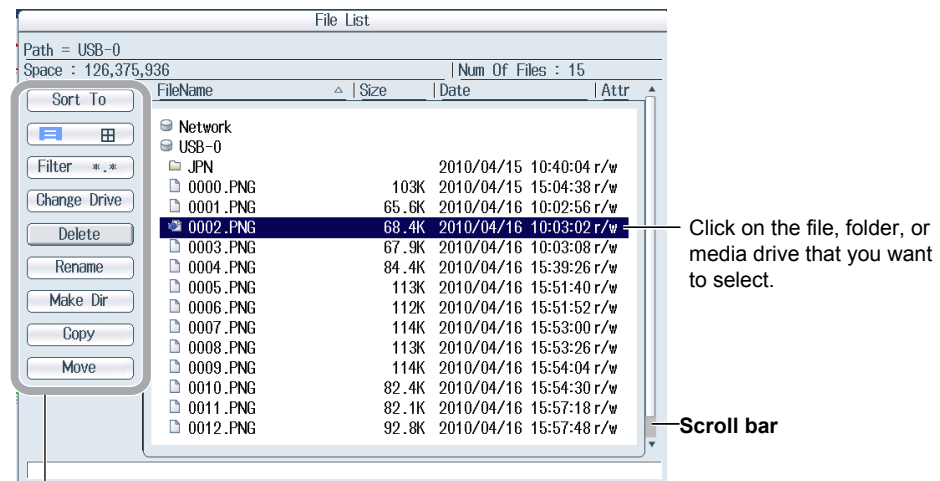

Click on the item that you want to select.

• **Setting V/DIV and TIME/DIV**

**Setting V/DIV**

Move the pointer close to the V/DIV value in the upper left of the display. The pointer becomes a . Rotate the mouse wheel forward to increase the V/DIV value, and rotate it back to decrease the value.

**Setting TIME/DIV**

Move the pointer close to the TIME/DIV value in the upper right of the display. The pointer becomes a . Rotate the mouse wheel forward to increase the TIME/DIV value, and rotate it back to decrease the value.



## 4.4 Synchronizing the Clock

This section explains how to set the DL850E/DL850EV clock, which is used to generate timestamps for measured data and files. The DL850E/DL850EV is factory shipped with a set date and time. You must set the clock before you start measurements.

### UTILITY System Config Menu

Press **UTILITY**, the **System Config** soft key, and then the **Date/Time** soft key to display the following screen.

The screenshot shows the 'Date/Time Setup' menu. It has a title bar 'Date/Time Setup'. Below the title bar, there are three main sections:

- Display:** A toggle switch currently set to 'ON'. A callout points to it with the text: 'Turns the display of the date and time on and off'.
- Format:** A dropdown menu showing '2015/02/09'. A callout points to it with the text: 'Set the display format.'
- Date/Time:** A section with six input fields: Year (2015), Month (2), Day (9), Hour (11), Minute (0), and Second (29). A 'Set' button is located below these fields. A callout points to this section with the text: 'Set the date and time.'

Below the Date/Time section is the **Time Diff. GMT** section, which has two input fields: Hour (9) and Minute (0). A callout points to this section with the text: 'Set the time difference from Greenwich Mean Time.'

### Setting the Display Format (Format)

You can display the date in one of the following formats.

- 2008/09/30 (year/numeric month/day)
- 30/09/2008 (day/numeric month/year)
- 30-Sep-08 (day-English abbreviation of the month-last two digits of the year)
- 30 Sep 2008 (day month (English abbreviation) year)

### Setting the Time Difference from Greenwich Mean Time (Time Diff. GMT)

Set the time difference between the region where you are using the DL850E/DL850EV and Greenwich Mean Time.

Selectable range: -12 hours 00 minutes to 13 hours 00 minutes

For example, Japan standard time is ahead of GMT by 9 hours. In this case, set Time Hour to 9 and Minute to 00.

#### Checking the Standard Time

Using one of the methods below, check the standard time of the region where you are using the DL850E/DL850EV.

- Check the Date, Time, Language, Regional Options on your PC.
- Check the standard time at the following URL:<http://www.worldtimeserver.com/>

#### Note

- The DL850E/DL850EV does not support Daylight Saving Time. To set the time to Daylight Saving Time, reset the time difference from Greenwich Mean Time.
- Date and time settings are backed up using an internal lithium battery. They are retained even if the power is turned off.
- The DL850E/DL850EV has leap-year information.

## 4.5 Performing Auto Setup

The auto setup feature automatically sets the V/div, Time/div, trigger level, and other settings to the most suitable values for the input signals.

### SETUP Menu

Press **SETUP** to display the following menu.

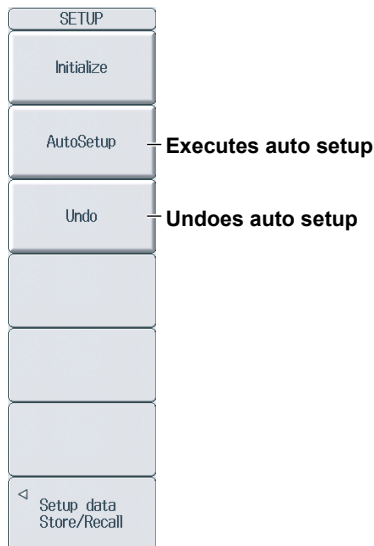

### Center Position after the Execution of Auto Setup

The center position after you execute auto setup will be 0 V.

### Applicable Modules

Auto setup is performed on the following modules.

701250 (HS10M12), 720250 (HS10M12), 701251 (HS1M16), 701255 (NONISO\_10M12), 701267 (HV (with RMS)), 720268 (HV (AAF, RMS)), 701261 (UNIVERSAL), 701262 (UNIVERSAL (AAF)), 701275 (ACCL/VOLT), 720210 (HS100M12), 720211 (HS100M12), 720220 (16CH VOLT), 720254 (4CH 1M16)

### Channels That Auto Setup Is Performed On

Auto setup is performed on all channels except logic channels.

Logic waveforms are displayed with the same settings as before you executed auto setup.

### Waveforms Displayed before the Execution of Auto Setup

When you perform auto setup, the data in the acquisition memory is overwritten, and the waveforms that were displayed before you executed auto setup are cleared.

### Undoing Auto Setup

You can press the Undo soft key to revert to the settings that were in effect before you executed auto setup. You cannot undo auto setup if you switch to a different setup menu or clear the SETUP menu using the ESC key.

## 4.5 Performing Auto Setup

---

### Signals That Auto Setup Can Be Applied To

|                         |  |
|-------------------------|--|
| Frequency:              | Approx. 50 Hz or higher  |
| Absolute input voltage: | Signals whose maximum value is at least approx. 20 mV (at 1:1 setting) |
| Type:                   | Simple, repeating signals  |

#### Note

The auto setup feature may not work properly for signals that include a DC component or high-frequency components.

---

### Settings after the Execution of Auto Setup

---

#### Waveform Acquisition and Display Settings

---

|                        |   |
|------------------------|---|
| T/div                  | The waveform with the shortest period out of the waveforms affected by auto setup is used to set T/div. T/div is set to the value at which 1.6 to 4 periods of the waveform can be displayed. |
| START/STOP             | START   |
| Acquisition mode       | Normal  |
| Acquisition count      | Infinite  |
| Record length          | 10 k  |
| Time base              | Int.  |
| Real-time HD recording | Off   |
| Dual capturing         | Off   |
| Accumulation           | Off   |

---

#### Vertical axis settings

---

|                 |   |
|-----------------|---|
| V/Div           | The value that causes the absolute values of the input waveform to be between 1.6 and 4.5 div   |
| Offset voltage  | 0 V   |
| Coupling        | DC  |
| Bandwidth limit | Full  |
| Display on/off  | Channels whose absolute input voltage values reach or exceed 20 mV (1:1) are displayed (except for Scan).<br>The displays of modules that are not affected by auto setup do not change. |
| DIV/Scale       | DIV   |
| Position        | 0.00 div  |
| V Zoom          | ×1  |

---

#### Trigger Settings

---

|                     |   |
|---------------------|---|
| Trigger mode        | Auto  |
| Trigger type        | SIMPLE  |
| Trigger source      | The channel with the longest period out of the channels whose amplitude is 1 div or greater |
| Trigger level/slope | The level between the maximum and minimum values/rising                                     |
| Hysteresis          | Low   |
| Hold-off            | 0.0 nsec  |
| Trigger position    | 50%   |
| Trigger delay       | 0.0 μsec  |

---

#### Computation Settings

---

|      |     |
|------|-----|
| Math | Off |
|------|-----|

---

The values of settings not listed here do not change.

## 4.6 Initializing Settings

You can reset the DL850E/DL850EV settings to their factory default values. This feature is useful when you want to cancel all of the settings that you have entered or when you want to redo measurement from scratch.

### SETUP Menu

Press **SETUP** to display the following menu.



### Settings That Cannot Be Reset to Their Factory Default Values

- Date and time settings
- Communication settings
- Language setting (English or Japanese)

### Undoing the Reset Operation

If you reset the settings by mistake, you can press the Undo soft key to revert to the previous settings. However, you cannot undo the reset operation if you switch to a different setup menu or clear the SETUP menu by pressing the ESC key.

### To Reset All Settings to Their Factory Default Settings

While holding down the **RESET** key, turn the power switch on. All settings except the date and time settings (display on/off setting will be reset) and the setup data stored in internal memory will be reset to their factory default values.

#### **Note**

This operation cannot be undone.

## 4.7 Calibrating the DL850E/DL850EV

### CAL Menu

Press **SHIFT+SETUP** (CAL) to display the following menu.

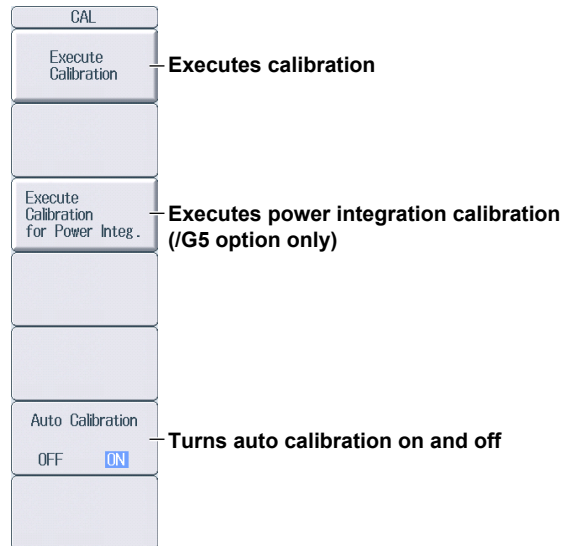

### Calibration

The following items are calibrated. Execute calibration when you want to make accurate measurements.

- Vertical axis ground level and gain

#### Note

Calibration is performed automatically when the power switch is turned on.

### Notes about Calibration

- Allow the DL850E/DL850EV to warm up for at least 30 minutes before you execute calibration. If you execute calibration immediately after power-on, the calibrated values may drift due to temperature changes or other environmental changes.
- Execute calibration in an environment with a stable temperature ranging from 5 to 40°C (23 ± 5°C recommended).
- Do not apply signals when calibrating. Calibration may not be executed properly when input signals are being applied to the DL850E/DL850EV.

### Auto Calibration (Auto Cal)

Auto calibration is executed when you start signal acquisition if you have changed Time/div and any of the time periods listed below has elapsed since the power was turned on.

- 3 minutes
- 10 minutes
- 30 minutes
- One hour and every hour thereafter

If calibration is executed while signals are being applied to the DL850E/DL850EV, we recommend that you recalibrate the DL850E/DL850EV without any signals being applied to it.

## 4.8 Starting and Stopping Waveform Acquisition

### Starting and Stopping Waveform Acquisition.

Press **START/STOP** to start or stop waveform acquisition.

The key is illuminated while the DL850E/DL850EV is acquiring waveforms.

### Waveform Acquisition and Indicators

- When the START/STOP key is illuminated, the DL850E/DL850EV is acquiring waveforms. “Running” appears in the lower left of the screen.
- When the START/STOP key is not illuminated, waveform acquisition is stopped. “Stopped” appears in the lower left of the screen.

### DL850E/DL850EV Operation When the Acquisition Mode Is Set to Averaging

- Averaging stops when you stop waveform acquisition.
- If you restart waveform acquisition again, averaging starts from the beginning.

### START and STOP Operations during Accumulation

- Accumulation stops when you stop acquisition.
- If you restart waveform acquisition, past waveforms are cleared, and accumulation starts over.

#### **Note**

You can use the snapshot feature to retain the displayed waveform on the screen. This feature allows you to retain a waveform on the screen while the DL850E/DL850EV continues signal acquisition.

---

## 4.9 Displaying Help

### Displaying Help

Press **HELP** (**?**) to display help.

The table of contents and index appear in the left frame, and text appears in the right frame.

### Switching between Frames

To switch to the frame that you want to control, use the left and right arrow (**▶**, **◀**) keys.

### Moving Cursors and Scrolling

To scroll through the screen or to move the cursor in the table of contents or index, turn the **jog shuttle**.

### Moving to the Link Destination

To move to a description that relates to blue text or to move from the table of contents or index to the corresponding description, move the cursor to the appropriate blue text or item, and press **SET**.

### Displaying Panel Key Descriptions

With help displayed, press a panel key to display an explanation of it.

### Returning to the Previous Screen

To return to the previous screen, press **RESET**.

### Hiding Help

With help displayed, press **HELP** (**?**) to clear help.



# 5.1 External Trigger Input (TRIGGER IN)



## CAUTION

Only apply signals that meet the following specifications. Signals that do not meet the specifications may damage the DL850E/DL850EV, because of factors such as excessive voltage.

### French



## ATTENTION

Appliquer uniquement des signaux respectant les spécifications ci-dessous. Les signaux ne respectant pas les spécifications risquent d'endommager DL850E/DL850EV, à cause de facteurs tels que la surtension.

## External Trigger Input Terminal



This terminal is used when an external signal is used as the trigger source.

| Item                              | Specifications   |
|-----------------------------------|--|
| Connector type                    | BNC  |
| Input level                       | TTL (0 to 5 V)   |
| Minimum pulse width               | 100 ns   |
| Logic                             | Rising and falling edges   |
| Trigger delay time                | Within 100 ns + 1 sample period  |
| Externally synchronized operation | Possible (through the connection of the TRIGGER IN and TRIGGER OUT terminals of two DL850E/DL850EVs) |

## Circuit Diagram and Timing Chart for External Trigger Input

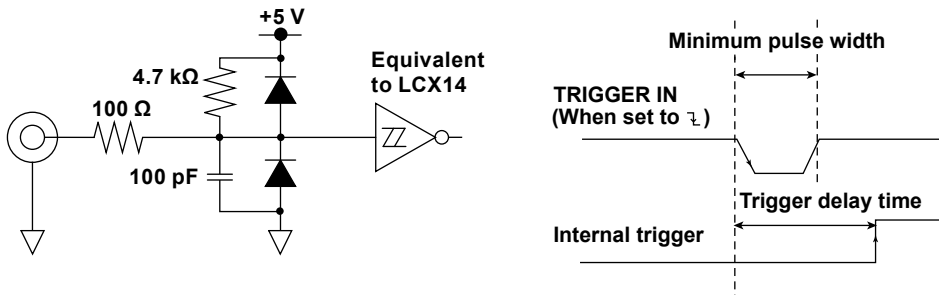

### Note

You can synchronize the operation of two DL850E/DL850EVs by using the trigger output function.

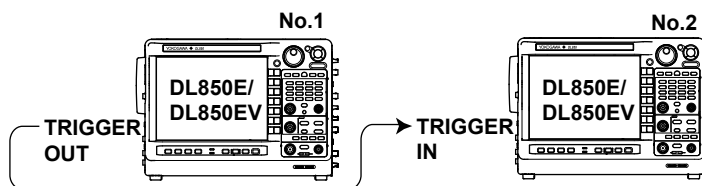

## 5.2 Trigger Output (TRIGGER OUT)



### CAUTION

Do not short the TRIGGER OUT terminal or apply external voltage to it. Doing so may damage the instrument.

### French



### ATTENTION

Ne pas court-circuiter la borne TRIGGER OUT et ne pas appliquer de tension de sortie. Cela pourrait endommager l'instrument.

## External Trigger Output Terminal

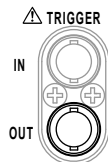

The following CMOS level signals can be transmitted.

### Trigger Output (Normal)

When the output format is set to normal, the terminal transmits a falling signal when a trigger occurs. The signal level is normally high but goes low when a trigger occurs.

### Trigger Output (Pulse)

When the output format is set to pulse, the terminal transmits a pulse signal when a trigger occurs. You can set the pulse width.

### Sample Clock Synchronization Signal Output (Sample Pulse)

When the output format is set to sample pulse, the terminal transmits a pulse signal at regular intervals when waveform acquisition is started. You can set the pulse rate.

### Start/Stop Level Signal Output (Start/Stop)

When the output format is set to start/stop, the terminal transmits start/stop level signals. The signal level is high during waveform acquisition and goes low when waveform acquisition is complete.

### Specifications

| Item                | Specifications                            |   |
|---------------------|---|---|
| Connector type      | BNC                                       |   |
| Output level        | CMOS level (0 to 5 V)                     |   |
| Output formats      |   |   |
| • Normal mode       | Logic<br>Output delay<br>Output hold time | Low when a trigger occurs and high after acquisition is completed<br>Within 100 ns + 1 sample period<br>100 ns or more  |
| • Pulse mode        | Logic<br>Output delay<br>Pulse width      | Transmits a pulse when a trigger occurs<br>Within 100 ns + 1 sample period<br>1 ms, 50 ms, 100 ms, or 500 ms  |
| • Sample pulse mode | Logic<br>Pulse rate                       | Transmits pulses at a given frequency during waveform acquisition<br>5 Hz to 200 kHz (1-2-5 steps)<br>However, the interval must be longer than the DL850E/DL850EV sampling interval. The interval can be set to 1 over the integer multiple of the DL850E/DL850EV sampling interval. |
| • Start/Stop mode   | Logic                                     | High level output during waveform acquisition<br>Low level output while waveform acquisition is stopped   |

### Circuit Diagram and Timing Chart for Trigger Out

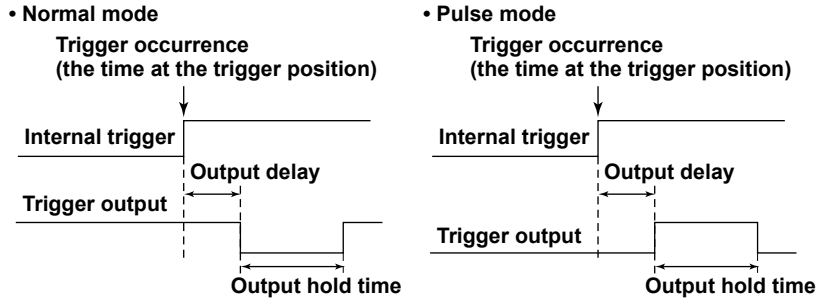
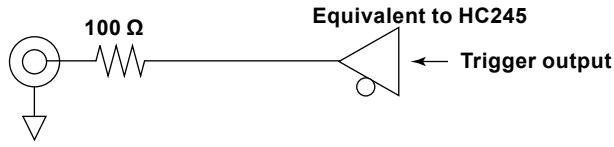

### Low Level and High Level Hold Times (In normal mode)

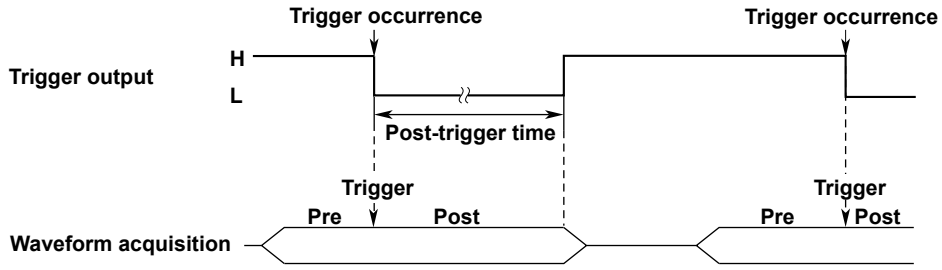

## 5.3 External Clock Input (EXT CLK IN)



### CAUTION

Only apply signals that meet the following specifications. Signals that do not meet the specifications may damage the DL850E/DL850EV, because of factors such as excessive voltage.

### French



### ATTENTION

Appliquer uniquement des signaux respectant les spécifications ci-dessous. Les signaux ne respectant pas les spécifications risquent d'endommager DL850E/DL850EV, à cause de facteurs tels que la surtension.

## External-clock input terminal



Use this terminal to operate the DL850E/DL850EV using an external clock signal.

| Item                           | Specifications                      |
|--------------------------------|-------------------------------------|
| Connector type                 | BNC                                 |
| Input level                    | TTL (0 to 5 V)                      |
| Detected edge                  | Rising                              |
| Minimum pulse width            | 50 ns or more for both high and low |
| External clock frequency range | Up to 9.5 MHz                       |

## Circuit Diagram for External Clock Input

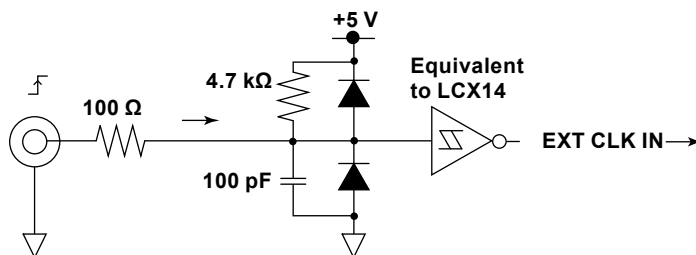

## 5.4 Video Signal Output (VIDEO OUT (XGA))



### CAUTION

- Only connect the DL850E/DL850EV to a monitor after turning both the DL850E/DL850EV and the monitor off.
- Do not short the VIDEO OUT terminal or apply external voltage to it. Doing so may damage the DL850E/DL850EV.

### French



### ATTENTION

- Ne brancher le DL850E/DL850EV sur un moniteur qu'après avoir mis hors tension le DL850E/DL850EV et le moniteur.
- Ne pas court-circuiter la borne VIDEO OUT et ne pas appliquer de tension de sortie. Cela pourrait endommager le DL850E/DL850EV.

### Video Signal Output Terminal

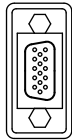

VIDEO OUT  
(XGA)

You can use video signal output to display the DL850E/DL850EV screen on a monitor. Any multisync monitor that supports XGA can be connected.

| Item              | Specifications                                   |
|-------------------|--|
| Connector type    | D-sub 15-pin                                     |
| Output format     | Analog RGB output                                |
| Output resolution | XGA output, 1024 × 768 dots, approx. 60 Hz Vsync |

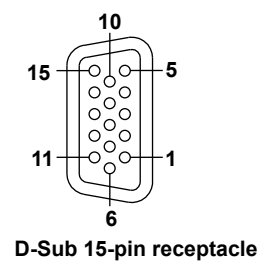

| Pin No. | Signal                 | Specifications                       |
|---------|------------------------|--------------------------------------|
| 1       | Red                    | 0.7 V <sub>P-P</sub>                 |
| 2       | Green                  | 0.7 V <sub>P-P</sub>                 |
| 3       | Blue                   | 0.7 V <sub>P-P</sub>                 |
| 4       | —                      |                                      |
| 5       | —                      |                                      |
| 6       | GND                    |                                      |
| 7       | GND                    |                                      |
| 8       | GND                    |                                      |
| 9       | —                      |                                      |
| 10      | GND                    |                                      |
| 11      | —                      |                                      |
| 12      | —                      |                                      |
| 13      | Horizontal sync signal | Approx. 36.4 kHz, TTL positive logic |
| 14      | Vertical sync signal   | Approx. 60 Hz, TTL positive logic    |
| 15      | —                      |                                      |

### Connecting to a Monitor

1. Turn off the DL850E/DL850EV and the monitor.
2. Connect the DL850E/DL850EV and the monitor using an RGB cable.
3. Turn on the DL850E/DL850EV and the monitor.

## 5.5 GO/NO-GO Determination I/O and External Start/Stop Input (EXT I/O)

### Connecting to Other Instruments



#### CAUTION

- Do not apply external voltage to the NO-GO OUT and GO OUT output pins. Doing so may damage the instrument.
- When connecting the GO/NO-GO determination signal output to another device, do not connect the wrong signal pin. Doing so may damage the DL850E/DL850EV or the connected instrument.
- Do not connect a USB cable to the GO/NO-GO I/O connector. Doing so may damage the instrument.

#### French



#### ATTENTION

- Ne pas appliquer de tension externe aux broches de sortie NO-GO OUT et GO OUT. Cela pourrait endommager le DL850E/DL850EV.
- Lors de la connexion de la sortie de signal de détermination GO/NO-GO à un autre instrument, veiller à ne pas connecter les mauvaises broches de signal. Cela pourrait endommager le DL850E/DL850EV ou l'instrument connecté.
- Ne pas brancher de câble USB sur le connecteur de sortie GO/NO-GO. Cela pourrait endommager l'instrument.

### About the External I/O Cable (720911; sold separately)

- Do not use the cable for anything other than the DL850E/DL850EV external I/O.
- Refer to the following figure to connect the cable to an external device.

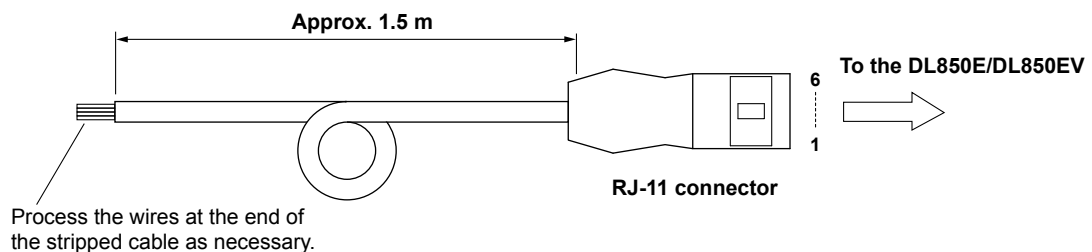

| Wire color | Pin no. | Signal       | Logic          |
|------------|---------|--------------|----------------|
| Red        | 1       | EXT EVENT IN | Negative logic |
| Yellow     | 2       | START IN     | Negative logic |
| White      | 3       | GO OUT       | Negative logic |
| Green      | 4       | NOGO OUT     | Negative logic |
| Blue       | 5       | GND          |                |

## GO/NO-GO Determination I/O

You can apply an external signal to the DL850E/DL850EV's GO/NO-GO I/O terminal and perform GO/NO-GO determination, and you can output the results of GO/NO-GO determination from the GO/NO-GO I/O terminal.

### GO/NO-GO I/O Connector

#### Type

The connector uses an RJ-11 modular jack. Use the external I/O cable accessory (720911; sold separately). If you are using a commercially sold cable (four-conductor modular telephone cable), wire the pins according to the above figure.

#### I/O Level

Within 0 to 5 V, threshold level: TTL

#### Pinout

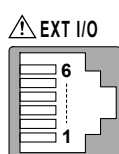

Connector on the DL850E/DL850EV

| Pin no. | Signal             |     |  |   |
|---------|--------------------|-----|--|---|
| 1       | EXT EVENT IN       | IN  |  | Manual event. Event input occurs on low edge. |
| 2       | START IN           | IN  |  | Starts on low edge                            |
| 3       | GO OUT             | OUT |  | Active low (GO)                               |
| 4       | NOGO OUT           | OUT |  | Active low (NO-GO)                            |
| 5       | GND                |     |  |   |
| 6       | NC (no connection) |     |  |   |

### Input Signal

#### START IN (Negative logic)

Use this signal to perform GO/NO-GO determination by synchronizing to an external input signal. The signal is only valid when on the GO/NO-GO menu, Remote is set to ON. If Remote is set to OFF, GO/NO-GO determination is performed regardless of the external signal input (the GO/NO-GO determination result is output).

#### Signal Input Circuit

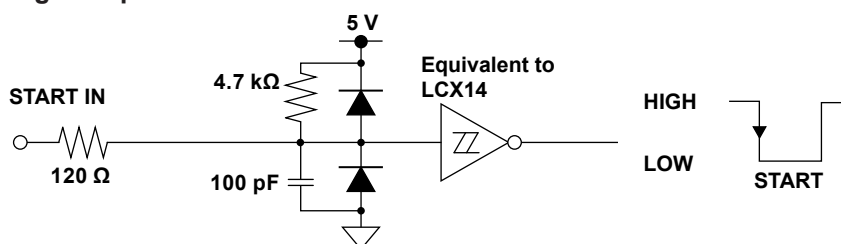

## Output Signal

### NOGO OUT (Negative logic)

When the determination result is NO-GO (fail), the output signal level temporarily changes from high (H) to low (L).

### GO OUT (Negative logic)

When the determination result is GO, the output signal level temporarily changes from high (H) to low (L).

### Signal Output Circuit

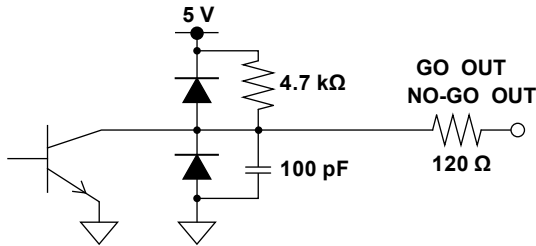

## GO/NO-GO I/O Timing

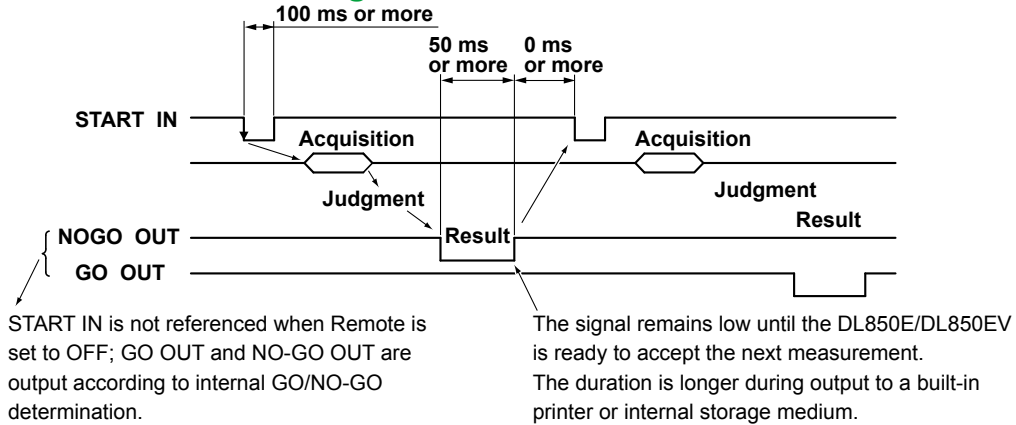



## External Start/Stop Input (EXT I/O)

You can use an external signal to start and stop the DL850E/DL850EV.

### External Start/Stop Input Terminal

The External Start/Stop Input terminal and the GO/NO-GO I/O terminal are the same terminal. This terminal is used as an external start/stop input when the GO/NO-GO determination I/O function is not used (when on the GO/NO-GO menu, Mode is set to OFF).

#### Specifications

The connector uses an RJ-11 modular jack. Connect the separately sold 720911 cable to the connector.

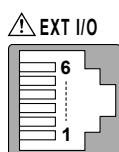

Connector on the DL850E/DL850EV

| Pin no. | Signal   |
|---------|--|
| 1       | EXT EVENT IN — Manual event. Event input occurs on low edge. |
| 2       | START IN — Starts on low edge, stops on high                 |
| 3       | NC (no connection)   |
| 4       | NC (no connection)   |
| 5       | GND  |
| 6       | NC (no connection)   |

Input level: TTL (0 to 5 V)

### Circuit Diagram for External Start/Stop Input

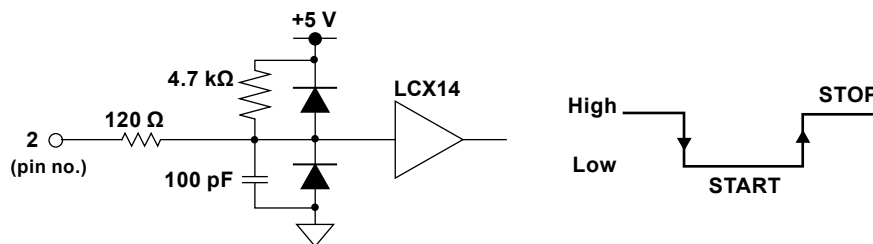

- Contact input is possible

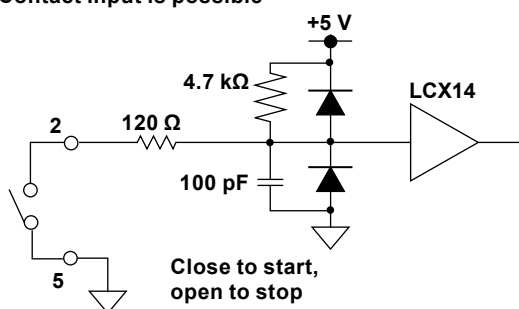

#### Note

- Low and high edges are used to detect starts and stops.
- You can select whether to enable high edges (stops) in the external start/stop signal or disable. For information about how to do so, see section 18.8, "Configuring the Environment Settings," in the user's manual.

## 5.6 IRIG Signal Input (IRIG option)



### CAUTION

Only apply signals that meet the following specifications. Signals that do not meet the specifications may damage the DL850E/DL850EV, because of factors such as excessive voltage.

#### French



### ATTENTION

Appliquer uniquement des signaux respectant les spécifications ci-dessous. Les signaux ne respectant pas les spécifications risquent d'endommager DL850E/DL850EV, à cause de facteurs tels que la surtension.

## IRIG Signal Input Terminal



You can use an IRIG (Inter Range Instrumentation Group) signal to set the time on the DL850E/DL850EV.

| Item                       | Specifications  |
|----------------------------|---|
| Input connector            | BNC   |
| Number of input connectors | 1   |
| Supported IRIG signals     | A002, B002, A132, and B122  |
| Input impedance            | You can switch between 50 $\Omega$ and 5 k $\Omega$ .                   |
| Maximum input voltage      | $\pm 8$ V   |
| Used for                   | Synchronizing the DL850E/DL850EV time<br>Synchronizing the sample clock |
| Clock sync range           | $\pm 80$ ppm  |
| Post-sync accuracy         | No drift from the input signal  |

## 5.7 GPS Signal Input (GPS option)

### CAUTION

Only apply signals that meet the following specifications. Signals that do not meet the specifications may damage the DL850E/DL850EV, because of factors such as excessive voltage.

### French



### ATTENTION

Appliquer uniquement des signaux respectant les spécifications ci-dessous. Les signaux ne respectant pas les spécifications risquent d'endommager DL850E/DL850EV, à cause de facteurs tels que la surtension.

## GPS Signal Input Terminal



You can use a GPS (Global Positioning System) signal to set the time on the DL850E/DL850EV.

| Item  | Specifications  |
|---|---|
| Input connector                             | SMA   |
| Number of input connectors                  | 1   |
| Receiver type                               | GPS L1 C/A code SBAS:WAAS EGNOS MSAS                                |
| Function                                    | DL850E/DL850EV time synchronization<br>Sample clock synchronization |
| Accuracy after synchronization <sup>1</sup> | ± 200 ns (when locked to GPS signal)                                |
| Sync time                                   | Within 5 minutes after the power is turned on                       |
| Compatible antenna                          | Active antenna, 3.3 V power supply<br>A1058ER standard accessory    |

1 The figure is based on results obtained when the GPS antenna is installed in a location with good line of sight to GPS satellites.

The accuracy may not be attained depending on the measurement location, the location of satellites when the measurement is taken, the weather, and influence caused by obstruction.

## 6.1 Signal Input Section

| Item                             | Specifications   |
|----------------------------------|--|
| Type                             | Plug-in input unit   |
| Number of slots                  | 8  |
| Maximum number of input channels | 16 channels per slot, 128 channels per unit (when a 16-CH voltage input module is installed in each slot)  |
| Maximum record length            | The maximum length when all channels are being used depends on the number of channels in each module.<br>The maximum values when the entire memory is used are listed below.<br>Standard      250 Mpoint when 1 channel is being used. 10 Mpoint per channel when 16 channels are being used.<br>/M1 option    1 Gpoint when 1 channel is being used. 50 Mpoint per channel when 16 channels are being used.<br>/M2 option    2 Gpoint when 1 channel is being used. 100 Mpoint per channel when 16 channels are being used.   |
| Real Time Math channels (option) | The DL850E/DL850EV is equipped with 16 dedicated channels for performing computations. This enables you to perform the following computations in real time on 16 analog input channels or 16 realtime math output channels: digital filter, basic arithmetic, basic arithmetic with coefficients, differentiation and integration, angle of rotation, logic signal/analog waveform conversion, quartic polynomial, rms value, power, integrated power, common logarithm, square root, cosine, sine, arc tangent, electrical angle, knocking filter, coefficient multiplied by addition or subtraction of sources, frequency, period, edge count, resolver, IIR filter, demodulation of the pulse width modulated signal, reactive power, CAN ID detection and torque, angle difference, and 3 phase resolver. (For detailed specifications of Real Time Math channel's math features, see section 6.5, Features.)<br>Real Time Math features are as follows: <ul style="list-style-type: none"> <li>• Even when the display is in roll mode, you can view the math results.</li> <li>• There are no restrictions on the record length. You can specify a record length that is the same as a normal input channel.</li> <li>• Math results can be used to trigger the DL850E/DL850EV.</li> <li>• Because both acquisition and computations can be performed at the same time, you can make the waveform update period shorter than it is with normal math operations.</li> </ul> |

## 6.2 Triggering Section

| Item                              | Specifications   |
|-----------------------------------|--|
| Trigger mode                      | Auto, Auto Level, Normal, Single, N Single, or On Start  |
| Selectable trigger level range    | 0 ± 10 div   |
| Trigger hysteresis                | When measuring voltage:      Select from ±0.1 div, ±0.5 div, and ±1 div.<br>When measuring temperature:    Select from ±0.5°C, ±1.0°C, and ±2.0°C.<br>When measuring strain:          Select from ±2.5%, ±12.5%, and ±25%.<br>When measuring acceleration:    Select from ±0.1 div, ±0.5 div, and ±1 div.<br>When measuring frequency:      Select from ±0.01 div, ±0.5 div, and ±1 div. |
| Selectable trigger position range | 0 to 100% (of the display record length; resolution: 0.1%)   |
| Selectable trigger delay range    | 0 to 10 s (resolution: 10 ns)  |
| Selectable hold-off time range    | 0 to 10 s (resolution: 10 ns)  |
| Manual trigger key                | A dedicated manual trigger key can be used.  |
| Simple trigger                    |  |
| Trigger source                    | CHn (select an input channel), EXT, LINE, or Time  |
| Trigger slope                     | Rising, falling, or rising or falling  |
| Time trigger                      | Date (year, month, and day), time (hour and minute), and time interval (10 seconds to 24 hours)  |

## 6.2 Triggering Section

| Item             | Specifications  |
|------------------|---|
| Enhanced trigger |   |
| Trigger source   | CHn (select an input channel)   |
| Trigger type     | <p>A -&gt; B(N): After the trigger A conditions are met, the DL850E/DL850EV triggers when the trigger B conditions are met N times.<br/>           Count: 1 to 10000<br/>           Condition A: Enter/Exit<br/>           Condition B: Enter/Exit</p> <hr/> <p>A Delay B: After the specified amount of time elapses after the trigger A conditions are met, the DL850E/DL850EV triggers when the trigger B conditions are first met.<br/>           Time: 0 to 10 s (resolution: 10 ns)<br/>           Condition A: Enter/Exit<br/>           Condition B: Enter/Exit</p> <hr/> <p>Edge on A: While the trigger A conditions are met, the DL850E/DL850EV triggers on the OR of multiple trigger source edges.<br/>           Condition A: True/False</p> <hr/> <p>AND: The DL850E/DL850EV triggers on the AND of multiple state conditions.</p> <hr/> <p>OR: The DL850E/DL850EV triggers on the OR of multiple trigger source edges or states (or Window triggers)</p> <hr/> <p>Pulse Width: The DL850E/DL850EV triggers after state condition B has been met for a specified duration (width).</p> <p>B&gt;Time: The DL850E/DL850EV triggers when the time from when the trigger B conditions are met to when they change from being met to not being met is greater than the specified time.<br/>           Time: 20 ns to 10 s (resolution: 10 ns)</p> <p>B&lt;Time: The DL850E/DL850EV triggers when the time from when the trigger B conditions are met to when they change from being met to not being met is less than the specified time.<br/>           Time: 20 ns to 10 s (resolution: 10 ns)</p> <p>B Time Out: The DL850E/DL850EV triggers when the trigger B conditions continue to be met for the specified period of time.<br/>           Time: 20 ns to 10 s (resolution: 10 ns)</p> <p>B Between: The DL850E/DL850EV triggers when the period during which the trigger B conditions continue to be met is within the specified time range.<br/>           Time T1: 10 ns to 9.99999999 s<br/>           T2: 20 ns to 10 s (resolution: 10 ns)</p> <hr/> <p>Period: The DL850E/DL850EV triggers when the period meets one of the following conditions.</p> <p>T&gt;Time: The DL850E/DL850EV triggers when the period of the trigger T conditions is longer than the specified time.<br/>           Time: 20 ns to 10 s (resolution: 10 ns)</p> <p>T&lt;Time: The DL850E/DL850EV triggers when the period of the trigger T conditions is less than the specified time.<br/>           Time: 20 ns to 10 s (resolution: 10 ns)</p> <p>T1&lt;T&lt;T2: The DL850E/DL850EV triggers when the period of the trigger T conditions is within the specified time range.<br/>           Time: T1: 20 ns to 10 s (resolution: 10 ns)<br/>           T2: 30 ns to 10 s (resolution: 10 ns)</p> <p>T&lt;T1, T2&lt;T: The DL850E/DL850EV triggers when the period of the trigger T conditions is outside of the specified time range.<br/>           Time: T1: 20 ns to 10 s (resolution: 10 ns)<br/>           T2: 30 ns to 10 s (resolution: 10 ns)</p> <hr/> <p>Window: The DL850E/DL850EV triggers when the trigger source enters or exits the range of two specified levels.<br/>           The DL850E/DL850EV can trigger on the OR of the window triggers of multiple channels.</p> <hr/> <p>Wave Window: This trigger is for monitoring power supplies.<br/>           The DL850E/DL850EV creates templates in real time by comparing 1, 2, or 4 cycles directly preceding the current waveforms using a tolerance value, compares the current waveforms to the real-time templates, and triggers if one of the current waveforms falls outside of its real-time template.</p> |
|                  | <ul style="list-style-type: none"> <li>• The trigger A and B conditions can be set to High, Low, or Don't Care for each channel. The AND of the conditions (the parallel pattern) is used to determine the result.</li> <li>• For OR and AND, the condition can be set to High, Low, IN, OUT, or Don't Care for each channel.</li> </ul>  |

## 6.3 Time Axis

| Item                        | Specifications  |
|-----------------------------|---|
| Selectable time scale range | The display of minutes per div, hours per div, and days per div is also possible.<br>100 ns/div <sup>1</sup> to 1 s/div (in 1-2-5 steps), 2 s/div, 3 s/div, 4 s/div, 5 s/div, 6 s/div, 8 s/div, 10 s/div, 20 s/div, 30 s/div, 1 min/div to 10 min/div (in 1 min steps), 12 min/div, 15 min/div, 30 min/div, 1 h/div to 10 h/div (in 1 h steps), 12 h/div, 1 day/div, 2 days/div, 3 days/div, 4 days/div, 5 days/div, 6 days/div, 8 days/div, 10 days/div, 20 days/div |
| Time accuracy <sup>2</sup>  | ±0.005%   |
| External clock input        | Connector type: BNC<br>Input level: TTL level<br>Detected edge: Rising<br>Frequency range: Up to 9.5 MHz<br>Minimum pulse width: 50 ns or more for both High and Low  |

- 1 1 µs/div when the High-Speed 100 MS/s, 12-Bit Isolation Module (720210 or 720211) is not installed
- 2 Under standard operating conditions after the warm-up time has passed

## 6.4 Display

| Item                               | Specifications   |
|------------------------------------|--|
| Display                            | 10.4-inch TFT LCD  |
| Display screen size                | 210.4 mm × 157.8 mm  |
| Display resolution*                | 1024 × 768 (XGA)   |
| Resolution of the waveform display | 801 × 656 (normal) or 1001 × 656 (wide)  |
| Display format                     | Divisions: Up to three screen divisions can be displayed at the same time.<br>Each division can contain one of the following windows: TY, ZOOM1, ZOOM2, XY1, XY2, FFT1, or FFT2. |

- \* The LCD may include a few defective pixels (within 5 ppm over the total number of pixels including RGB). The LCD may contain some pixels that are always illuminated or that never light. Please be aware that these are not defects.

## 6.5 Features

### Waveform Acquisition and Display

| Item  | Specifications  |
|---|---|
| Acquisition mode  | Normal: Normal waveform acquisition<br>Envelope: The peak values are held at the maximum sample rate regardless of the Time/div setting.<br>Averaging: The number of times to average can be set to 2 to 65536 in 2 <sup>n</sup> steps.<br>Box average: Increases the A/D resolution by up to 4 bits (16 bits max.).  |
| Record length   | 1 kpoint, 2.5 kpoint, 5 kpoint, 10 kpoint, 25 kpoint, 50 kpoint, 100 kpoint, 250 kpoint, 500 kpoint, 1 Mpoint, 2.5 Mpoint, 5 Mpoint, 10 Mpoint, 25 Mpoint, 50 Mpoint, 100 Mpoint, 250 Mpoint, 500 Mpoint (on models with the /M1 or /M2 option), 1000 Mpoint (on models with the /M1 or /M2 option), 2000 Mpoint (on models with the /M2 option)  |
| Zoom  | The displayed waveform is expanded along the time axis (up to two locations can be zoomed at separate zoom factors).<br>Auto scrolling: The DL850E/DL850EV automatically scrolls to the zoom position.  |
| Display format  | 1, 2, 3, 4, 5, 6, 8, 12, 16 analog waveform windows   |
| Maximum number of displayed traces                              | 64 traces per display group. You can switch between four display groups.  |
| Display interpolation   | Sampled points can be displayed through the use of dots (OFF), sine interpolation, linear interpolation, or pulse interpolation.  |
| Graticule   | Three graticule types to choose from  |
| Auxiliary display on/off  | Scale values, waveform labels, the extra window, the level indicator, and the numeric display can be turned on and off.   |
| X-Y display   | The X and Y axes can be selected from CHn and MATHn (Max. four traces × two windows).   |
| Accumulation  | Persistence mode  |
| Snapshot  | The currently displayed waveforms can be retained on the screen.<br>Snapshot waveforms can be saved and loaded.   |
| Clear trace   | The displayed waveform is cleared.  |
| Dual capturing  | The data of a single waveform can be acquired at two different sample rates.  |
| Main waveform   | Maximum sample rate: 100 kS/s (roll mode area)  |
| Captured waveform   | Maximum sample rate: 100 MS/s*<br>Record length: 5 kpoint, 10 kpoint, 25 kpoint, 50 kpoint, 100 kpoint, 250 kpoint, 500 kpoint  |
| Hard disk recording (when the /HD0 or /HD1 option is installed) | Maximum sample rate: Depends on the number of channels being used. 1 MS/s when 1 channel is being used. 100 kS/s when 16 channels are being used.<br>Capacity: Depends on the amount of free space on the HDD<br>Operation overview: When waveform acquisition occurs according to the specified trigger mode, the DL850E/DL850EV stores the data to an internal hard disk or an external hard disk that supports eSATA. Note that hard disks that can be used are those whose disk partition style is MBR and the format is FAT32. |

\* 10 MS/s when the High-Speed 100 MS/s, 12-Bit Isolation Module (720210 or 720211) is not installed

### Vertical and Horizontal Control

| Item                      | Specifications  |
|---------------------------|---|
| Channel on/off            | CHn and MATHn can be turned on and off separately.  |
| ALL CH menu               | You configure the settings of all channels while displaying waveforms.<br>You can use a USB keyboard or mouse.  |
| Vertical axis zooming     | ×0.1 to ×100 (varies depending on the module)<br>You set the scale using upper and lower limits or switch between different scales.   |
| Vertical position setting | Waveforms can be moved in the range of ±5 div from the center of the waveform display frame.  |
| Linear scaling            | The linear scaling mode can be set separately for each channel (only for voltage, stress, and frequency). It can be set to AX+B or P1-P2.                                   |
| Roll mode                 | Roll mode is enabled automatically when the trigger mode is set to Auto, Auto Level, Single, or On Start, and the time axis setting is greater than or equal to 100 ms/div. |

## Analysis

| Item   | Specifications  |
|--|---|
| Zooming and searching                        | You can search for and then expand and display a portion of the displayed waveform. You can choose from the following search methods.<br>Edge: The DL850E/DL850EV counts the number of rising or falling edges<br>Logic pattern: The DL850E/DL850EV counts the number of times a logic pattern is detected.<br>Event: The DL850E/DL850EV searches for an event number.<br>Time: The DL850E/DL850EV searches for a date and time.  |
| History search feature                       | You can search through history waveforms for specified conditions.<br>Zone search: The DL850E/DL850EV displays waveforms that pass through or do not pass through a specified area on the screen.<br>Parameter search: The DL850E/DL850EV displays a waveform when the results of the automated measurement of its parameters meet the specified conditions.  |
| Cursor measurement                           | Horizontal, Vertical, H&V, Degree (only during T-Y waveform display) and Marker   |
| Automated measurement of waveform parameters | Automated measurement of waveform parameters<br>Up to 32 items can be displayed.<br>P-P, Amp, Max, Min, High, Low, Avg, Mid, Rms, SDev, +OverShoot, -OverShoot, Rise, Fall, Freq, Period, +Width, -Width, Duty, Pulse, Burst1, Burst2, AvgFreq, AvgPeriod, Int1TY, Int2TY, Int1XY, Int2XY, Delay(between channels)  |
| Statistical processing                       | Applicable items: Automated measurement values of waveform parameters<br>Statistical items: Max, Min, Avg, Sdv, and Cnt<br>Maximum number of cycles: 64000 cycles (when the number of parameters is 1)<br>Maximum total number of parameters: 64000<br>Normal statistical processing: Statistical processing is performed while waveforms are acquired.<br>Cyclic statistical processing: The DL850E/DL850EV automatically measures the waveform parameters of the data in the acquisition memory and performs statistical processing on the parameters once per period.<br>Statistical processing of the history data: The DL850E/DL850EV automatically measures the waveform parameters of each history waveform and performs statistical processing on the parameters. |
| Computation                                  | Operators: +, -, ×, ÷, binary computation, phase shift, and power spectrum  |
| User-defined computation (/G2 option)        | Expressions can be created through the combination of the following operators and constants.<br>ABS, SQRT, LOG, EXP, NEG, SIN, COS, TAN, ATAN, PH, DIF, DDIF, INTG, IINTG, BIN, P2, P3, F1, F2, FV, PWHH, PWHL, PWLH, PWLL, PWXX, DUTYH, DUTYL, FILT1, FILT2, HLB, MEAN, LS-, RS-, PS-, PSD-, CS-, TF-, CH-, MAG, LOGMAG, PHASE, REAL, IMAG   |
| Phase shifting                               | You can monitor the waveform of a specified channel with its phase shifted  |
| GO/NO-GO determination                       | The following two types of GO/NO-GO determination are available:<br>• Determination using zones on the screen<br>• Determination using the automated measurement values of waveform parameters.<br>The following operations can be performed at the time of determination:<br>Output of screen capture data, saving of waveform data (to binary, ASCII, floating-point, or MATLAB), sounding of a notification buzzer, transfer of e-mail   |

## Screen Capture Data Output

| Item                          | Specifications   |
|-------------------------------|--|
| Built-in printer (/B5 option) | A hard copy of the screen can be output.   |
| External printer              | Prints screen captures on an external printer connected over an Ethernet or USB. |
| File format                   | PNG, JPEG, or BMP  |

## Data Storage

| Item                                    | Specifications   |
|---|--|
| History                                 | Automatically holds up to 5000 pages of waveforms (depending on the record length)                               |
| Internal HDD and external storage media | Waveform data, setup data, automated measurement values, and the results of statistical processing can be saved. |



## Real Time Math (Option)

| Item                         | Specifications  |
|------------------------------|---|
| Math expression              | Real Time Math using hardware   |
| Max. number of math channels | 16 (select analog waveform storage or Real Time Math result storage)  |
| Math source channels         | Analog channel 1 to channel 16 (multi-channel modules can also be selected as math sources)   |
| Math result                  | 16 bits (2400 LSB/div). Results are converted to 16-bit values according to the scaling setting and stored in memory.   |
| Digital filter               | Math can be performed independently on each channel. Math can be performed on up to 16 channels at the same time.   |
| Math rate                    | Max. math rate (sample rate): 1 MS/s. The math rate is selected automatically depending on the set frequency. The possible rates are 1 MS/s, 100 kS/s, 10 kS/s, 1 kS/s and 100 S/s.   |
| Filter types                 | <p>Mean (moving average)</p> <p>Filter format: FIR (moving average)</p> <p>Filter type: LPF</p> <p>Number of moving average points: Selectable from 2, 4, 8, 16, 32, 64, and 128</p> <hr/> <p>Gauss:</p> <p>Filter format: FIR</p> <p>Filter type: LPF</p> <p>Filter order: 5 to 49</p> <p>Cutoff frequency: 300 kHz to 2 Hz</p> <p>Resolution: 300 kHz to 30 kHz, in steps of 2 kHz</p> <p>Resolution: 29.8 kHz to 3 kHz, in steps of 200 Hz</p> <p>Resolution: 2.98 kHz to 300 Hz, in steps of 20 Hz</p> <p>Resolution: 298 Hz to 30 Hz, in steps of 2 Hz</p> <p>Resolution: 29.8 Hz to 2 Hz, in steps of 0.2 Hz</p> <p>Cutoff characteristic: <math>-3.0 \times (f/f_c)^2</math> (where f is the frequency and <math>f_c</math> is the cutoff frequency)</p> <hr/> <p>Sharp:</p> <p>Filter format: FIR</p> <p>Filter type: LPF, HPF, BPF</p> <p>Filter order: 5 to 194</p> <p>LPF:</p> <p>Cutoff frequency: 300 kHz to 2 Hz</p> <p>Resolution: 300 kHz to 30 kHz, in steps of 2 kHz</p> <p>Resolution: 29.8 kHz to 3 kHz, in steps of 200 Hz</p> <p>Resolution: 2.98 kHz to 300 Hz, in steps of 20 Hz</p> <p>Resolution: 298 Hz to 30 Hz, in steps of 2 Hz</p> <p>Resolution: 29.8 Hz to 2 Hz, in steps of 0.2 Hz</p> <p>HPF:</p> <p>Cutoff frequency: 300 kHz to 200 Hz</p> <p>Resolution: 300 kHz to 30 kHz, in steps of 2 kHz</p> <p>Resolution: 29.8 kHz to 3 kHz, in steps of 200 Hz</p> <p>Resolution: 2.98 kHz to 200 Hz, in steps of 20 Hz</p> <p>BPF:</p> <p>Center frequency: 300 kHz to 300 Hz</p> <p>Resolution: 300 kHz to 30 kHz, in steps of 2 kHz</p> <p>Resolution: 29.8 kHz to 3 kHz, in steps of 200 Hz</p> <p>Resolution: 2.98 kHz to 300 Hz, in steps of 20 Hz</p> <p>Bandwidth: 200 kHz, 150 kHz, 100 kHz, 50 kHz, 20 kHz, 15 kHz, 10 kHz, 5 kHz, 2 kHz, 1.5 kHz, 1 kHz, 500 Hz, 200 Hz (there are limits based on the center frequency)</p> <p>Cutoff characteristic: <math>-40 \text{ dB @ } 2f_c</math> (LPF), <math>-40 \text{ dB @ } 0.5f_c</math> (HPF)</p> <p>Phase: Linear phase characteristics</p> |

| Item           | Specifications  |
|----------------|---|
|                | <p>IIR:</p> <p>Filter format: IIR (Butterworth)</p> <p>Filter type: LPF, HPF, BPF</p> <p>Filter order: 4</p> <p>LPF:</p> <p>Cutoff frequency: 300 kHz to 2 Hz</p> <p>Resolution: 300 kHz to 30 kHz, in steps of 2 kHz</p> <p>Resolution: 29.8 kHz to 3 kHz, in steps of 200 Hz</p> <p>Resolution: 2.98 kHz to 0.3 kHz, in steps of 20 Hz</p> <p>Resolution: 298 Hz to 2 Hz, in steps of 2 Hz</p> <p>HPF:</p> <p>Cutoff frequency: 300 kHz to 20 Hz</p> <p>Resolution: 300 kHz to 30 kHz, in steps of 2 kHz</p> <p>Resolution: 29.8 kHz to 3 kHz, in steps of 200 Hz</p> <p>Resolution: 2.98 kHz to 20 Hz, in steps of 20 Hz</p> <p>BPF:</p> <p>Center frequency: 300 kHz to 60 Hz</p> <p>Resolution: 300 kHz to 12 kHz, in steps of 2 kHz</p> <p>Resolution: 11.8 kHz to 1.2 kHz, in steps of 200 Hz</p> <p>Resolution: 1.18 kHz to 60 Hz, in steps of 20 Hz</p> <p>Bandwidth: 200 kHz, 150 kHz, 100 kHz, 50 kHz, 20 kHz, 15 kHz, 10 kHz, 5 kHz, 2 kHz, 1.5 kHz, 1 kHz, 500 Hz, 200 Hz, 100 Hz (there are limits based on the center frequency)</p> <p>Cutoff characteristic: -24 dB/Oct</p> <p>Phase: Nonlinear phase characteristics</p>  |
|                | <p>IIR-Lowpass filter:</p> <p>Filter format: IIR (Butterworth)</p> <p>Filter type: LPF</p> <p>Filter order: 4</p> <p>Cutoff frequency: 128 kHz, 64 kHz, 32 kHz, 16 kHz, 8 kHz, 4 kHz, 2 kHz, 1 kHz, 500 Hz, 250 Hz, 125 Hz, 62.5 Hz (no limits based on the sample rate)</p>  |
|                | <p>Interpolation Interpolation can be turned on and off for each channel.</p>   |
| Delay          | <p>Delay can be set for each channel.</p>   |
|                | <p>Delay 100 ns to 10 ms</p>  |
|                | <p>Delay resolution 100 ns to 100 <math>\mu</math>s, in steps of 100 ns</p> <p>101 <math>\mu</math>s to 1 ms, in steps of 1 <math>\mu</math>s</p> <p>1.01 ms to 10 ms, in steps of 10 <math>\mu</math>s</p>   |
| Real Time Math | <p>Math rate Max. math rate: 10 MS/s or 1 MS/s for polynomials</p> <p>Math type Basic arithmetic:</p> <p>Addition, subtraction, multiplication, and division of two channels (no coefficients)</p> <p>Differentiation:</p> <p>Differentiation using a fifth order Lagrange interpolation formula</p> <p>Integration:</p> <p>Integration reset condition: When waveform acquisition starts, when a channel is turned on or off</p> <p>Selectable reset conditions:</p> <p>Over limit (<math>\pm 10</math> div)</p> <p>Zero crossing to positive: When the source signal is moving in the positive direction and crosses zero</p> <p>Zero crossing to negative: When the source signal is moving in the negative direction and crosses zero</p> <p>Basic arithmetic with coefficients:</p> <p>Expressions: +, -, <math>\times</math>, /</p> <p>Coefficients: A, B, and C can be defined.</p> <p>Addition: <math>(A \times S1) + (B \times S2) + C</math></p> <p>Subtraction: <math>(A \times S1) - (B \times S2) + C</math></p> <p>Multiplication: <math>(A \times S1) \times (B \times S2) + C</math></p> <p>Division: <math>(A \times S1)/(B \times S2) + C</math></p> <p>Range of coefficients A, B, and C: -9.9999E+30 to +9.9999E+30</p> |

## 6.5 Features

| Item | Specifications  |
|------|---|
|      | Angle of rotation:<br>Specify the A, B, and Z phase signals, and the angle of the bit signal from the pulse integration logic input is computed as an absolute value. Max. setting of the number of pulses per rotation: 65535  |
|      | Logic signal/analog waveform conversion:<br>Uses the logic signal as an analog signal, and performs a scaling conversion  |
|      | Quartic polynomial:<br>$A \times s^4 + B \times s^3 + C \times s^2 + D \times s + E$ Range of coefficients A, B, C, D, and E: $-9.9999E+30$ to $+9.9999E+30$  |
|      | Rms value:<br>$\sqrt{\frac{1}{N} \sum_{n=1}^N s(n)^2}$ The math period is from one zero crossing of the specified signal to the next zero crossing.<br>Alternatively, the period is the specified time: 1 to 500 ms, resolution: 1 ms   |
|      | Effective power:<br>$\frac{1}{T} \int_0^T (s1 \cdot s2) dt$ The math period is the integrated value of the time from one zero crossing of the specified signal to the next zero crossing.   |
|      | Effective power integration:<br>$\int_0^T (s1 \cdot s2) dt$ The value "s1 × s2" is integrated over time.  |
|      | Common logarithm (Log1):<br>$K \times \text{Log}_{10}(s1/s2)$   |
|      | Common logarithm (Log2):<br>$K \times \text{Log}_{10}(s1)$  |
|      | Square root (Sqr1):<br>$\sqrt{s1^2 \pm s2^2}$   |
|      | Square root (Sqr2):<br>$\sqrt{s}$   |
|      | Cosine:<br>$\cos(\text{angle})$   |
|      | Sine:<br>$\sin(\text{angle})$   |
|      | Arc tangent:<br>$\text{atan}(s1/s2)$  |
|      | Electrical angle: <ul style="list-style-type: none"> <li>Calculates the phase difference between (1) the angle that was determined from the logic signals that were specified for phases A, B, and Z, and (2) the fundamental wave component that was determined from the discrete Fourier transform of the waveform that was specified as the target.</li> <li>Calculates the phase difference (electrical angle) between the angle of rotation and drive current of the motor.</li> </ul> |
|      | Knocking filter:<br>When the signal level of the math source waveform that is being differentiated is less than or equal to the elimination level, the output is set to 0.  |
|      | Coefficient multiplied by addition or subtraction of sources:<br>$K \times (s1 \pm s2 \pm s3 \pm s4)$ Range of coefficient K: $-9.9999E+30$ to $+9.9999E+30$  |
|      | Period:<br>The period from one edge condition to the next edge condition is measured.<br>Resolution: 100 ns. Max. period: 10 s  |
|      | Frequency:<br>The period is measured, and the frequency is calculated as 1/period.  |
|      | Edge count:<br>Counts the specified edges   |

| Item | Specifications  |
|------|---|
|      | <p>IIR:</p> <p>Filter format: IIR (Butterworth)</p> <p>Filter type: LPF, HPF, BPF</p> <p>Filter order: 4</p> <p>LPF:</p> <p>Cutoff frequency: 3 MHz to 0.2 Hz</p> <p>Resolution: 3 MHz to 300 kHz, in steps of 20 kHz</p> <p>Resolution: 298 kHz to 30 kHz, in steps of 2 kHz</p> <p>Resolution: 29.8 kHz to 3 kHz, in steps of 200 Hz</p> <p>Resolution: 2.98 kHz to 0.3 kHz, in steps of 20 Hz</p> <p>Resolution: 298 Hz to 30 Hz, in steps of 2 Hz</p> <p>Resolution: 29.8 Hz to 0.2 Hz, in steps of 0.2 Hz</p> <p>HPF:</p> <p>Cutoff frequency: 3 MHz to 20 Hz</p> <p>Resolution: 3 MHz to 300 kHz, in steps of 20 kHz</p> <p>Resolution: 298 kHz to 30 kHz, in steps of 2 kHz</p> <p>Resolution: 29.8 kHz to 3 kHz, in steps of 200 Hz</p> <p>Resolution: 2.98 kHz to 20 Hz, in steps of 20 Hz</p> <p>BPF:</p> <p>Center frequency: 3 MHz to 60 Hz</p> <p>Resolution: 3 MHz to 120 kHz, in steps of 20 kHz</p> <p>Resolution: 118 kHz to 12 kHz, in steps of 2 kHz</p> <p>Resolution: 11.8 kHz to 1.2 kHz, in steps of 200 Hz</p> <p>Resolution: 1.18 kHz to 60 Hz, in steps of 20 Hz</p> <p>Bandwidth: 2 MHz, 1.5 MHz, 1 MHz, 500 kHz, 200 kHz, 150 kHz, 100 kHz, 50 kHz, 20 kHz, 15 kHz, 10 kHz, 5 kHz, 2 kHz, 1.5 kHz, 1 kHz, 500 Hz, 200 Hz, 100 Hz (there are limits based on the center frequency)</p> <p>Cutoff characteristic: -24 dB/Oct</p> <p>Phase: Nonlinear phase characteristic</p> <p>Interpolation: Interpolation can be turned on and off.</p> |
|      | <p>Resolver:</p> <p>The angle of rotation is computed from the carrier signal, sine signal, and cosine signal.</p> <p>Supported carrier frequencies: 1 kHz to 20 kHz</p> <p>Tracking filter band setting: 2 kHz, 1 kHz, 250 Hz, 100 Hz</p> <p>Maximum measurable angular acceleration:</p> <p>140000 rps<sup>2</sup> (when the tracking filter is set to 2 kHz)</p> <p>54000 rps<sup>2</sup> (when the tracking filter is set to 1 kHz)</p> <p>1800 rps<sup>2</sup> (when the tracking filter is set to 250 Hz)</p> <p>180 rps<sup>2</sup> (when the tracking filter is set to 100 Hz)</p>  |
|      | <p>Demodulation of the pulse width modulated (PWM) signal:</p> <p>The PWM-modulated signal is integrated over the modulation period and converted into an analog signal.</p>  |
|      | <p>Reactive power:</p> <p>The reactive power is computed from apparent power and effective power.</p>   |
|      | <p>CAN ID detection:</p> <p>The frame of the CAN bus signal with the specified ID is detected.</p>  |
|      | <p>Torque:</p> <p>The torque is computed from the measured frequency and the specified coefficient.</p>   |
|      | <p>Angle difference math:</p> <p>S1 - S2 (Angle)</p> <p>Subtract the value (angle) of source channel 2 from the value (angle) of source channel 1.</p>  |
|      | <p>3 Phase Resolver:</p> <p>Calculates the angle of rotation from the two sine signals that are generated from the detection coil of the 3 phase resolver depending on the angle of the rotor.</p> <p>Supported carrier frequencies: 1 kHz to 20 kHz</p> <p>Tracking filter band setting: 2 kHz, 1 kHz, 250 Hz, 100 Hz</p>  |

## 6.5 Features

| Item  | Specifications  |
|---|---|
| Math source waveforms                             | Analog channels 1 to 16 and the sub channels of scanner and CAN modules. <ul style="list-style-type: none"> <li>• Math results can be specified as sources of another channel.</li> <li>• However, you can only specify math results of channels whose numbers are smaller than the channel that you are specifying sources for.</li> </ul> |
| Math delay  | A uniform delay for each math operation, regardless of the number of math channels  |
| Mean  | The mean can be calculated on the math results.<br>Number of taps: 32 (fixed)<br>The calculation period changes automatically according to the DL850E/DL850EV sample rate.  |
| Zoom Method                                       |   |
| Zooming by Setting a Magnification                | V Zoom is set in steps of 1, 2, or 5 to a value in the range of 10.00E-21 to 500.0E+18.   |
| Zooming by Setting Upper and Lower Display Limits | Upper limit: $\pm 5.0000E+22$ ; lower limit: $\pm 1.0000E-23$   |

## Power Math (Option)

| Item  | Specifications   |
|---|--|
| Math expression                             | Real time math using hardware  |
| Math source channels                        | Analog channel 1 to channel 16 (multi-channel modules cannot be selected as math sources)*   |
| Max. math rate                              | 10 MS/s  |
| Math data update rate                       | 100 kS/s max.  |
| Math result output channels                 | Power analysis math CH13, CH14; harmonic analysis math CH15, CH16 (fixed)  |
| Math result                                 | 16 bits (2400 LSB/div)<br>Results are converted to 16-bit values according to the scaling setting and stored in memory.  |
| Power analysis                              |  |
| Max. number of analyzable systems           | Up to two three-phase systems can be computed simultaneously.  |
| Max. number of simultaneous math parameters | 126 when one system is measured<br>54 × 2 systems when two systems are measured  |
| Supported wiring systems                    | Single-phase, two-wire (1P2W); single-phase, three-wire (1P3W); or three-phase, three-wire (3P3W),<br>Three-phase, three wire system that uses a three-voltage, three-current method (3P3W; 3V3A); three-phase, four-wire system (3P4W)  |
| Delta math function                         | Three-phase, three-wire (3P3W) → three-phase, three wire system that uses a three-voltage, three-current method (3P3W; 3V3A)<br>Three-phase, three-wire (3V3A) → three-phase, four-wire system (3P4W) (delta → star)<br>Three-phase, four-wire system (3P4W) → three-phase, three-wire (3V3A) (star → delta)   |
| Math items                                  | Rms voltage and current of each phase<br>Voltage and current simple average of each phase (DC)<br>AC voltage and current components of each phase (AC)<br>Active power<br>Apparent power<br>Reactive power<br>Power factor<br>Current phase difference<br>Voltage and current frequencies<br>Maximum voltage and current, minimum voltage and current<br>Maximum power, minimum power<br>Integrated watt-hour, integrated watt-hour of each polarity (positive and negative)<br>Integrated ampere-hour, integrated ampere-hour of each polarity (positive and negative)<br>Apparent energy<br>Reactive energy<br>Impedance of the load circuit<br>Series resistance of the load circuit<br>Series reactance of the load circuit<br>Parallel resistance of the load circuit<br>Parallel reactance of the load circuit<br>Three-phase voltage unbalanced factor<br>Three-phase current unbalanced factor<br>Motor output math<br>Power efficiency (select motor output result and power math result or power math result of two systems) |

| Item                                  | Specifications   |
|---------------------------------------|--|
| Rms math system                       | Select true rms value or rectified mean value calibrated to the rms value  |
| Math sync mode                        | Edge: Select a signal. Computed using zero-crossings.<br>Auto Timer: Specify the time. Computed at specified time intervals.<br>AC: Select a signal. Computed using zero-crossings. Signal stop determined by a stop prediction function.<br>AC+DC: Select a signal. Computed using zero-crossings. Signal stop determined by a stop prediction function.<br>Switches to Auto Timer after stopping.  |
| Channel selection for edge            | Select a single channel from own phase voltage, own phase current, or other voltage/current.   |
| Sync channel filter                   | If sync mode is set to Edge, low-pass filter can be selected.<br>Cutoff frequency: Select from 128 kHz, 64 kHz, 32 kHz, 16 kHz, 8 kHz, 4 kHz, 2 kHz, 1 kHz, 500 Hz, 250 Hz, 125 Hz, and 62.5 Hz.   |
| Harmonic analysis                     |  |
| Max. number of analyzable systems     | 1 system   |
| Max. number of analyzable frequencies | Fundamental wave 1 kHz   |
| FFT points                            | 512  |
| Supported wiring systems              | Single-phase, two-wire (1P2W); single-phase, three-wire (1P3W); or three-phase, three-wire (3P3W),<br>Three-phase, three wire system that uses a three-voltage, three-current method (3P3W; 3V3A); three-phase, four-wire system (3P4W)  |
| Delta math function                   | Three-phase, three-wire (3P3W) → three-phase, three wire system that uses a three-voltage, three-current method (3P3W; 3V3A)<br>Three-phase, three-wire (3V3A) → three-phase, four-wire system (3P4W) (delta → star)<br>Three-phase, four-wire system (3P4W) → three-phase, three-wire (3V3A) (star → delta)   |
| Math mode                             | Rms analysis mode, power analysis mode   |
| Math items                            | Rms analysis mode:<br>Rms values of the 1st to 40th harmonic<br>Rms percentage content of the 1st to 40th harmonic<br>Phase angles of the 1st to 40th harmonic<br>Total rms value<br>Distortion factor (IEC)<br>Distortion factor (CSA)<br>Power analysis mode:<br>Active powers from the 1st to the 35th harmonic<br>Active power percentage content from the 1st to the 35th harmonic<br>Phase angles of the 1st to 35th harmonic<br>Total active powers<br>Total reactive powers<br>Total apparent powers<br>Power factor<br>1st harmonic rms voltage<br>1st harmonic rms current<br>1st harmonic voltage phase angle<br>1st harmonic current phase angle |
| Sync channel                          | Rms analysis mode: Analysis source channel<br>Power analysis mode: Select one channel from voltage and current.  |
| Sync channel filter                   | Low-pass filter can be selected.<br>Cutoff frequency: Select from 128 kHz, 64 kHz, 32 kHz, 16 kHz, 8 kHz, 4 kHz, 2 kHz, 1 kHz, 500 Hz, 250 Hz, 125 Hz, and 62.5 Hz.  |

\* If power math is not to be performed, the data on channels 13 to 16 are also applicable.  
Example: If only harmonic analysis is to be performed, the data on channels 1 to 14 are applicable.

## 6.5 Features

### Other Features

| Item                  | Specifications  |
|-----------------------|---|
| Initialization        | Resets settings to the factory default (excluding the date and time setting, communication interface settings, language setting, and time difference from GMT setting). The reset can be undone.  |
| Auto setup            | Automatically sets the voltage axis, time axis, trigger, etc. The automatic settings can be undone.   |
| Action                | Outputs screen capture data, saves waveform data (to binary, ASCII, floating-point, or MATLAB), sounds a notification buzzer, transfers an e-mail, or performs some combination of the previous actions whenever a trigger occurs or waveform acquisition stops |
| E-mail transmission   | Sends e-mail using SMTP   |
| Calibration           | Auto or manual  |
| System settings       | Screen color, date and time, message language, menu language, click sound on/off, and grid thickness  |
| Overview              | The system specifications can be displayed.   |
| Self tests            | Memory test, key test, printer test, and storage test   |
| Help feature          | Displays a description of the settings  |
| PROTECT key           | You can lock the keys to prevent unintentional operations.  |
| NUM key               | You can enter numbers directly.   |
| Japanese string input | Compact-VJE Ver.3.0   |

## 6.6 FFT

| Item                    | Specifications   |
|-------------------------|--|
| Waveform to be computed | CHn or MATHn   |
| Number of channels      | 1 (on models without the /G2 option), 2(on models with the /G2 option)   |
| Computation range       | From the specified computation start point until the specified number of points have been computed   |
| Computed points         | 1 k, 2 k, 5 k, 10 k, 20 k, 50 k, or 100 k  |
| Time windows            | Rect, Hanning, Hamming, FlatTop, and Exponential (on models with the /G2 option)<br>When the Exponential time window is selected, the following settings must be configured.<br>Damping rate: The weight of the last data point, with the weight of the first data point in the specified number of FFT points taken to be 100% (= 1).<br>Selectable range: 1 to 100%<br>Resolution: 1%<br>Force1: Set the area over which computation is performed in terms of a percentage from the first FFT point, taking the number of FFT points to be 100%.<br>Selectable range: 1 to 100%<br>Resolution: 1%<br>Force2: This setting applies to the output (response) signal (second parameter) of a two-waveform FFT.<br>Selectable range: 1 to 100%<br>Resolution: 1% |
| Display window          | The FFT computation results are displayed in a separate window independent from the normal waveform display.<br>Display range: Set the display range by setting Center and Sensitivity.  |

## 6.7 Built-in Printer

| Item                         | Specifications                      |
|------------------------------|-------------------------------------|
| Print system                 | Thermal line dot system             |
| Sheet width                  | 112 mm                              |
| Effective print width        | 104 mm (832 dots)                   |
| Dot density                  | 8 dot/mm                            |
| Feeding direction resolution | 8 dot/mm                            |
| Used for                     | Producing a hard copy of the screen |

## 6.8 Storage

### SD Memory Card

| Item             | Specifications                     |
|------------------|------------------------------------|
| Number of slots  | 1                                  |
| Maximum capacity | 32 GB                              |
| Supported cards  | SD and SDHC compliant memory cards |

### Internal HDD (/HD1 option)

| Item             | Specifications |
|------------------|----------------|
| Number of drives | 1              |
| Size             | 2.5 in.        |
| Available space  | 500 GB, FAT32  |

### USB Storage Device

| Item                           | Specifications   |
|--------------------------------|--|
| Compatible USB storage devices | Mass storage devices that are compliant with USB Mass Storage Class Ver. 1.1 |
| Available space                | 2 TB<br>Partition style: MBR, Format: FAT32/FAT16                            |

\* See section 6.9, "USB Ports for Peripherals."

### External HDD Interface (/HD0 option)

| Item                 | Specifications                                   |
|----------------------|--|
| Connection interface | eSATA  |
| Number of drives     | 1  |
| Available space      | 2 TB<br>Disk partition style: MBR, Format: FAT32 |

## 6.9 USB Ports for Peripherals

| Item                                     | Specifications  |
|--|---|
| Connector type                           | USB type A (receptacle)   |
| Electrical and mechanical specifications | USB Rev. 2.0 compliant  |
| Supported transfer mode                  | HS (High Speed; 480 Mbps), FS (Full Speed; 12 Mbps), LS (Low Speed; 1.5 Mbps)   |
| Compatible devices                       | Mass storage devices that are compliant with USB Mass Storage Class Ver. 1.1<br>104 or 109 keyboards that are compliant with USB HID Class Version 1.1<br>Mouse devices that are compliant with USB HID Class Version 1.1 |
| Number of ports                          | 2   |
| Power supply                             | 5 V, 500 mA (for each port)   |



## 6.10 Auxiliary I/O Section

### External Trigger Input (TRIGGER IN)

| Item                | Specifications           |
|---------------------|--------------------------|
| Connector type      | BNC                      |
| Input level         | TTL                      |
| Minimum pulse width | 100 ns                   |
| Detected edge       | Rising or falling        |
| Trigger delay time  | Within 100 ns + 1 sample |

### Trigger Output (TRIGGER OUT)

| Item              | Specifications                            |   |
|-------------------|---|---|
| Connector type    | BNC                                       |   |
| Output level      | 5 V CMOS                                  |   |
| Output formats    |   |   |
| Normal mode       | Logic<br>Output delay<br>Output hold time | Low when a trigger occurs and high after acquisition is completed<br>Within 100 ns + 1 sample period<br>100 ns or more  |
| Pulse mode        | Logic<br>Output delay<br>Pulse width      | Transmits a pulse when a trigger occurs<br>Within 100 ns + 1 sample period<br>1 ms, 50 ms, 100 ms, or 500 ms  |
| Sample pulse mode | Logic<br>Pulse rate                       | Transmits pulses at a given frequency during waveform acquisition<br>5 Hz to 200 kHz (1-2-5 steps)<br>However, the interval must be longer than the DL850E/DL850EV sampling interval. The interval can be set to 1 over the integer multiple of the DL850E/DL850EV sampling interval. |
| Start/Stop mode   | Logic                                     | High level output during waveform acquisition<br>Low level output while waveform acquisition is stopped   |

### External Clock Input (EXT CLK IN)

| Item                | Specifications           |
|---------------------|--------------------------|
| Connector type      | BNC                      |
| Input level         | TTL                      |
| Minimum pulse width | 50 ns                    |
| Detected edge       | Rising                   |
| Sampling jitter     | Within 100 ns + 1 sample |

### Video Signal Output (VIDEO OUT)

| Item              | Specifications   |
|-------------------|--|
| Connector type    | D-sub 15 pin receptacle  |
| Output format     | Analog RGB   |
| Output resolution | XGA-compliant output, 1024 × 768 dots<br>Approx. 60 Hz Vsync (dot clock frequency: 66 MHz) |

### GO/NO-GO Determination I/O

| Item           | Specifications     |
|----------------|--------------------|
| Connector type | RJ-11 modular jack |
| Input level    | TTL or contact     |
| Output level   | 5 V CMOS           |

## External Start/Stop Input

| Item           | Specifications     |
|----------------|--------------------|
| Connector type | RJ-11 modular jack |
| Input level    | TTL or contact     |

## COMP Output (Probe-compensation-signal output terminal)

| Item                    | Specifications               |
|-------------------------|------------------------------|
| Output signal frequency | 1 kHz $\pm$ 1%               |
| Output amplitude        | 1 V <sub>p-p</sub> $\pm$ 10% |

## Probe Power Output (/P4 Option)

| Item                       | Specifications |
|----------------------------|----------------|
| Number of output terminals | 4              |
| Output voltage             | $\pm$ 12 V     |
| Output current             | Up to 1 A      |

## Time Sync Signal Input (IRIG; /C20 option)

| Item                       | Specifications  |
|----------------------------|---|
| Input connector            | BNC   |
| Number of input connectors | 1   |
| Supported IRIG signals     | A002, B002, A132, and B122  |
| Input impedance            | You can switch between 50 $\Omega$ and 5 k $\Omega$ .                   |
| Maximum input voltage      | $\pm$ 8 V   |
| Used for                   | Synchronizing the DL850E/DL850EV time<br>Synchronizing the sample clock |
| Clock sync range           | $\pm$ 80 ppm  |
| Post-sync accuracy         | No drift from the input signal  |

## GPS Interface (/C30 option)

| Item  | Specifications  |
|---|---|
| Input connector                             | SMA   |
| Number of input connectors                  | 1   |
| Receiver type                               | GPS L1 C/A code SBAS:WAAS EGNOS MSAS                                |
| Function                                    | DL850E/DL850EV time synchronization<br>Sample clock synchronization |
| Accuracy after synchronization <sup>1</sup> | $\pm$ 200 ns (when locked to GPS signal)                            |
| Sync time                                   | Within 5 minutes after the power is turned on                       |
| Compatible antenna                          | Active antenna, 3.3 V power supply<br>A1058ER standard accessory    |

<sup>1</sup> The figure is based on results obtained when the GPS antenna is installed in a location with good line of sight to GPS satellites. The accuracy may not be attained depending on the measurement location, the location of satellites when the measurement is taken, the weather, and influence caused by obstruction.

## 6.11 Computer Interface

### USB-PC Connection

| Item                                     | Specifications  |
|--|---|
| Connector type                           | USB type B receptacle   |
| Electrical and mechanical specifications | USB Rev. 2.0 compliant  |
| Supported transfer mode                  | HS (High Speed; 480 Mbps) and FS (Full Speed; 12 Mbps)  |
| Number of ports                          | 1   |
| Supported protocols                      | Functions as a device that conforms to one of the following two protocols.<br>USBTMC-USB488 (USB Test and Measurement Class Ver. 1.0)*<br>GP-IB commands can be used through USB.<br>Mass Storage Class Ver.1.1<br>Only reading from a PC to the internal hard disk of the DL850E/DL850EV is possible.<br>(Operations, such as writing, deleting and formatting, are impossible.) |
| PC system requirements                   | Windows 7, 8.1, 10  |

\* A separate driver is required.

### Ethernet

| Item                                     | Specifications   |
|--|--|
| Connector type                           | RJ-45 modular jack   |
| Ports                                    | 1  |
| Electrical and mechanical specifications | IEEE802.3  |
| Transmission system                      | Ethernet (1000BASE-T, 100BASE-TX, 10BASE-T)  |
| Communication protocol                   | TCP/IP   |
| Supported services                       | DHCP, DNS, SNTP client, SMTP client, FTP server and client, LPR, Web server, and VXI11 |

### GP-IB (/C1 or /C20 option)

| Item                      | Specifications   |
|---------------------------|--|
| Connector type            | 24-pin connector   |
| Electrical specifications | Complies with IEEE St'd 488-1978 (JIS C 1901-1987)                                       |
| Functional specifications | SH1, AH1, T6, L4, SR1, RL1, PP0, DC1, DT0, and C0  |
| Protocol                  | IEEE St'd 488.2-1992   |
| Code                      | ISO (ASCII)  |
| Mode                      | Addressable mode   |
| Address                   | Talker and listener addresses can be specified from 0 to 30.                             |
| Remote mode release       | Remote mode can be cleared with the SHIFT+CLEAR TRACE key (except during Local Lockout). |

## 6.12 General Specifications

| Item  | Specifications  |
|---|---|
| Standard operating conditions   | Ambient Temperature: 23 ± 5°C<br>Ambient humidity: 20 to 80% RH<br>Supply voltage and frequency errors: Within ±1% of rating<br>After the DL850E/DL850EV has been warmed up for 30 minutes and then calibration has been performed  |
| Recommended calibration period  | 1 year  |
| Warm-up time  | At least 30 minutes   |
| Storage environment   | Temperature: -20 to 60°C<br>Humidity: 20 to 85% RH (no condensation)<br>Altitude: 3000 m or less  |
| Operating environment   | Temperature: 5 to 40°C<br>Humidity: 20 to 85% RH (when the printer is not being used)<br>35 to 85% RH (when the printer is used)<br>In both cases, no condensation<br>Altitude: 2000 m or less  |
| Standard model  |   |
| Rated supply voltage  | 100 to 120 VAC, 220 to 240 VAC (auto switching)   |
| Permitted supply voltage range  | 90 to 132 VAC, 198 to 264 VAC   |
| Rated supply frequency  | 50/60 Hz  |
| Permitted supply voltage frequency range  | 48 to 63 Hz   |
| Power fuse  | Built in (not replaceable)  |
| Maximum power consumption   | 200 VA  |
| Withstand voltage   | 1500 VAC for one minute between the power supply and case   |
| Insulation resistance   | 10 MΩ or more for 500 VDC between the power supply and case   |
| External dimensions   | Approx. 355 mm (W) × 259 mm (H) × 180 mm (D), not including the handle and protrusions  |
| Weight  | Approx. 6.5 kg (weight of the DL850E/DL850EV only without paper and with the /B5, /M2, /HD1, /C1, and /P4 options installed)  |
| Instrument cooling method   | Forced air cooling. Exhaust on the left side and top panel.   |
| DL850EV DC power supply model   |   |
| (/DC option; the AC power supply specifications are the same as those shown for the standard model) |   |
| Supply format   | Auto DC/AC switching (AC preferred), isolation between DC power input terminal and the DL850EV  |
| Rated supply voltage  | 12 VDC  |
| Permitted supply voltage  | 10 to 18 VDC  |
| Power consumption   | Approx. 90 VA (typical value <sup>1</sup> ): When driving 2 channels (High-Speed 10 MS/s, 12-Bit Isolation Module × 1)<br>Approx. 105 VA (typical value <sup>1</sup> ): When driving 8 channels (High-Speed 100 MS/s, 12-Bit Isolation Module × 2 and High-Speed 10 MS/s 12-Bit Isolation Module × 2)<br>Approx. 135 VA (typical value <sup>1</sup> ): When driving 16 channels (High-Speed 100 MS/s, 12-Bit Isolation Module × 4 and High-Speed 10 MS/s 12-Bit Isolation Module × 4) |
| Maximum power consumption   | Approx. 150 VA  |
| Standby power (during DC standby)   | 30 mW (typical value <sup>1</sup> , DC power consumption when power is supplied both to AC and DC power)  |
| Voltage input protection circuit  | Overcurrent detection: Breaker (15 A)<br>Reverse connection protection: Breaker shutdown<br>Undervoltage detection: Cut off at a voltage less than approx. 9.5 V<br>Overvoltage detection: Cut off at a voltage greater than approx. 18 V   |
| Withstand voltage   | 30 VDC for one minute between the DC power input terminal and earth terminal  |
| External dimensions   | Approx. 355 mm (W) × 259 mm (H) × 202 mm (D), (DL850EV with the /DC option installed, not including the handle and protrusions)   |
| Weight  | Weight increase by the DC power option Approx. 800 g  |
| Indicator function  | Indicates the status of the power supply to the DL850EV using two LEDs  |
| Instrument cooling method   | Forced air cooling. Exhaust on the left side and top panel.<br>In DC mode, air is vented from the left side, top panel, and rear panel.   |
| Battery backup  | The settings and clock are backed up with an internal lithium battery.  |
| Backup battery life   | Approx. five years (at an ambient temperature of 25°C)  |

## 6.12 General Specifications

| Item            | Specifications  |
|-----------------|---|
| Safety standard | <p>Compliant standards<sup>2</sup></p> <p>EN 61010-1, EN 61010-2-030, EN 61010-031, EN 60825-1</p> <ul style="list-style-type: none"> <li>• Overvoltage category (installation category) II<sup>3</sup></li> <li>• Measurement Category: See the specifications of each module.<sup>4</sup></li> <li>• Pollution degree 2<sup>5</sup></li> </ul> <p>Approved (DL850E, DL850EV, 701250, 720250, 701251, 701255, 701267, 720268, 701261, 701262, 701265, 720266, 701270, 701271, 701275, 701281, 720281, 720210, 720211, 720220, 720221, 720230, 720240, 720241, 720242, 720243, 720254, 700986, 700987, 701953, 701955, 701956, 701957, 701958, 702911, 702912)</p> <ul style="list-style-type: none"> <li>• Bridgehead for the strain module</li> </ul> <p>Use the 701955 or 701956 with the 701270, and use the 701957 or 701958 with the 701271.</p>  |
| Emissions       | <p>Compliant standards</p> <p>EN 61326-1 Class A, EN 61326-2-1, EN 301 489-1<sup>6</sup>, EN 301 489-3<sup>6</sup>, EN 303 413<sup>6</sup>, EN 55011 Class A, Group 1, EMC Regulatory Arrangement in Australia and New Zealand EN 55011 Class A, Group 1, Korea Electromagnetic Conformity Standard ( 한국 전자파적합성기준 )</p> <p>Approved (DL850E, DL850EV, 701250, 720250, 701251, 701255, 701267, 720268, 701261, 701262, 701265, 720266, 701270, 701271, 701275, 701281, 720281, 720210, 720211, 720220, 720221, 720230, 720240, 720241, 720242, 720243, 720254, 700986, 700987, 701953, 701955, 701956, 701957, 701958, 702911, 702912)</p> <p>EN 61000-3-2, EN 61000-3-3</p> <p>This product is a Class A (for industrial environments) product. Operation of this product in a residential area may cause radio interference in which case the user is required to correct the interference.</p> <p>If the measurement lead or probe is connected to the input module, or if this instrument is connected to an object to be measured, emissions requirements may not be satisfied. In this case, the user sometimes need to take proper actions.</p> <p>Test items</p> <ol style="list-style-type: none"> <li>1. Power supply terminal noise</li> <li>2. Radiation emission</li> <li>3. Power supply harmonic regulation</li> <li>4. Power supply voltage fluctuation and flicker</li> <li>5. Receiver spurious emissions<sup>6</sup></li> </ol> <p>Cable conditions (DL850E/DL850EV)</p> <p>Current probe</p> <p>When connecting a current probe to the input terminal and probe power terminal of a module, attach a single ferrite core<sup>7</sup> to both cables on the side of the cables closest to the DL850E/DL850EV.</p> <p>GP-IB cable</p> <p>Use a shielded cable that is 3 m or less in length.</p> <p>USB cable</p> <p>Use a shielded cable that is 3 m or less in length, and attach a ferrite core<sup>7</sup> to the side of the cable closest to the DL850E/DL850EV.</p> <p>Ethernet cable</p> <p>Use a shielded cable that is 30 m or less in length, and attach a ferrite core<sup>7</sup> to the side of the cable closest to the DL850E/DL850EV.</p> <p>External clock input, external trigger input, external trigger output</p> <p>Use a shielded cable that is 3 m or less in length, and attach a ferrite core<sup>7</sup> to the side of the cable closest to the DL850E/DL850EV.</p> <p>IRIG cable</p> <p>Use a shielded cable that is 3 m or less in length, and attach a ferrite core<sup>7</sup> to the side of the cable closest to the DL850E/DL850EV.</p> <p>External HDD cable</p> <p>Use a shielded cable that is 3 m or less in length.</p> <p>Video signal output cable</p> <p>Use a shielded cable that is 3 m or less in length, and attach a ferrite core<sup>8</sup> to the side of the cable closest to the DL850E/DL850EV.</p> <p>External I/O cable</p> <p>Use a shielded cable that is 3 m or less in length, and attach a ferrite core<sup>7</sup> to the side of the cable closest to the DL850E/DL850EV.</p> <p>DC power cable</p> <p>Attach a ferrite core<sup>8</sup> to the DC power cable.</p> <p>Probe power cable</p> <p>Use the dedicated cable, and attach a ferrite-core<sup>6</sup> to the side of the cable closest to the DL850E/DL850EV by passing the cable twice through the core.</p> |

### Example of passing the cable through twice



Cable conditions (input module)

| Item     | Specifications  |
|----------|---|
|          | <p>50 <math>\Omega</math> terminator 700976 (for the 701281, 720211, 720243, 720254, 720250, 720266, 720268, and 720281)</p> <p>Isolated probe 700929 (for the 701250, 701251, 701255, 701275, and 720210)<br/>Attach a ferrite-core<sup>7</sup> to the side of the cable closest to the DL850E/DL850EV by passing the cable twice through the core.</p> <p>Twisted pair cable for the 701261, 701262, and 701265<br/>Use a cable that is 3 m or less in length, and attach a ferrite-core<sup>7</sup> to the side of the cable closest to the DL850E/DL850EV by passing the cable twice through the core.</p> <p>Twisted pair cable for the 720220 and 720221(701953)<br/>Use a cable that is 3 m or less in length, and attach a ferrite-core<sup>9</sup> to the side of the cable closest to the DL850E/DL850EV by passing the cable twice through the core.</p> <p>Measurement lead 758933 (for the 701267)<br/>Bundle the H and L measurement leads. Attach a ferrite core<sup>7</sup> to the DL850E/DL850EV side of the bundled leads.</p> <p>D-sub 9-pin shielded cable (for the 720240, 720241, and 720242)<br/>Use a cable that is 3 m or less in length, and attach a ferrite core<sup>7</sup> to the side of the cable closest to the DL850E/DL850EV.</p> <p>Bridgeheads 701955 and 701956 (for the 701270)<br/>Use a cable that is 5 m or less in length, and attach a ferrite core<sup>7</sup> to the side of the cable closest to the DL850E/DL850EV.</p> <p>Bridgeheads 701957 and 701958 (for the 701271)<br/>Use a cable that is 5 m or less in length, and attach a ferrite core<sup>7</sup> to the side of the cable closest to the DL850E/DL850EV.</p> <p>Logic probe input cables 700986, 700987, 702911, and 702912 (for the 720230)<br/>Attach a ferrite core<sup>7</sup> to the side of the cable closest to the DL850E/DL850EV.</p>  |
| Immunity | <p>Compliant standards<br/>EN 61326-1 Table 2 (for use in industrial locations), EN 61326-2-1, EN 301 489-1<sup>6</sup>, EN 301 489-3<sup>6</sup>, EN 303 413<sup>6</sup><br/>Approved (DL850E, DL850EV, 701250, 720250, 701251, 701255, 701267, 720268, 701261, 701262, 701265, 720266, 701270, 701271, 701275, 701281, 720281, 720210, 720211, 720220, 720221, 720230, 720240, 720241, 720242, 720243, 720254, 700986, 700987, 701953, 701955, 701956, 701957, 701958, 702911, 702912)<br/>If the measurement lead or probe is connected to the input module, or if this instrument is connected to an object to be measured, immunity requirements may not be satisfied. In this case, the user sometimes need to take proper actions.</p> <p>Influence in the immunity environment (criteria A)<br/>Noise increase<br/>701250: <math>\leq \pm 20</math> mV (1:1 input, 5 mV/div range conversion)<br/>701251: <math>\leq \pm 3</math> mV (1:1 input, 1 mV/div range conversion)<br/>701255: <math>\leq \pm 25</math> mV (1:1 input, 5 mV/div range conversion)<br/>701267: <math>\leq \pm 30</math> mV (1:1 input, 20 mV/div range conversion)<br/>701261: <math>\leq \pm 3</math> mV (5 mV/div range conversion)<br/>701262: <math>\leq \pm 3</math> mV (5 mV/div range conversion)<br/>701265: <math>\leq \pm 0.05</math> mV (0.1 mV/div)<br/>701270: <math>\leq \pm 100</math> <math>\mu</math>STR (<math>\pm 500</math> <math>\mu</math>V range, gauge factor = 2)<br/>701271: <math>\leq \pm 100</math> <math>\mu</math>STR (<math>\pm 500</math> <math>\mu</math>V range, gauge factor = 2)<br/>701275: <math>\leq \pm 6</math> mV (1:1 input, 5 mV/div range conversion)<br/>701281: <math>\leq \pm 0.01</math> Hz (frequency, 0.1 Hz/div range conversion)<br/>720210: <math>\leq \pm 50</math> mV (1:1 input, 10 mV/div range conversion)<br/>720211: <math>\leq \pm 50</math> mV (1:1 input, 10 mV/div range conversion)<br/>720220: <math>\leq \pm 20</math> mV (0.2 V/div range conversion)<br/>720221: <math>\leq \pm 2</math> mV (1 mV/div range; data update period = 100 ms when you are using the 701953)<br/>720230: No bit errors<br/>720240: No erros<br/>720241: No erros<br/>720242: No erros<br/>720243: No erros<br/>720254: <math>\leq \pm 15</math> mV (1:1 input, 10 mV/div range conversion)<br/>720250: <math>\leq \pm 20</math> mV (1:1 input, 5 mV/div range conversion)<br/>720266: <math>\leq \pm 0.05</math> mV (0.1 mV/div)<br/>720268: <math>\leq \pm 300</math> mV (50 mV/div range conversion)<br/>720281: <math>\leq 0.01</math> Hz (frequency, 0.1 Hz/div range conversion)</p> <p>Test conditions<br/>701250: 10 MS/s, envelope mode, 50 mV/div, no input filter, with the tip of the probe (700929 (10:1)) shorted<br/>701251: 1 MS/s, envelope mode, 10 mV/div, no input filter, with the tip of the probe (700929 (10:1)) shorted</p> |

## 6.12 General Specifications

| Item                   | Specifications  |
|------------------------|---|
|                        | 701255: 10 MS/s, envelope mode, 50 mV/div, no input filter, with the tip of the probe (701940 (10:1)) shorted   |
|                        | 701267: 100 kS/s, envelope mode, 0.2 V/div, no input filter, with the end of the cable shorted  |
|                        | 701261: 100 kS/s, envelope mode, 5 mV/div, no input filter, with the end of the cable shorted   |
|                        | 701262: 100 kS/s, envelope mode, 5 mV/div, no input filter, with the end of the cable shorted   |
|                        | 701265: 500 S/s, envelope mode, 0.1 mV/div, no input filter, with the end of the cable shorted  |
|                        | 701270: 100 kS/s, envelope mode, 500 $\mu$ STR, gauge factor: 2.0, no input filter<br>701955 bridge voltage: 2 V<br>701956 bridge voltage: 10 V   |
|                        | 701271: 100 kS/s, envelope mode, 500 $\mu$ STR, gauge factor: 2.0, no input filter<br>701957 bridge voltage: 2 V<br>701958 bridge voltage: 10 V   |
|                        | 701275: 100 kS/s, envelope mode, 50 mV/div, no input filter, with the tip of the probe (700929 (10:1)) shorted  |
|                        | 701281: 1 MS/s, envelope mode, Frequency, no input filter, with the tip of the probe shorted  |
|                        | 720210: 100 M/s, envelope mode, 0.1 V/div, no input filter, with the tip of the probe (700929 (10:1)) shorted   |
|                        | 720211: 100 M/s, envelope mode, 0.1 V/div, no input filter, 50 $\Omega$ terminator  |
|                        | 720220: 12.5 kS/s, envelope mode, 0.2 V/div, no input filter, with the end of the cable shorted   |
|                        | 720221: 25 kS/s, envelope mode, 1 mV/div, data update period = 100 ms with the end of the cable shorted when you are using the 701953   |
|                        | 720230: Logic probes 700986, 700987, 702911, and 702912, with the tips of the logic probes shorted  |
|                        | 720240: Bit rate: 1 Mbps, one shot operation  |
|                        | 720241: Bit rate: 19.2 kbps, external signal input  |
|                        | 720242: Arbitration bit rate: 1 Mbps, data bit rate: 5 Mbps, one shot operation   |
|                        | 720243: Clock tick: 3 $\mu$ s, external signal input  |
|                        | 720254: 1 MS/s, envelope mode, 10 mV/div, no input filter (1:1 input), 50 $\Omega$ terminator   |
|                        | 720250: 10 MS/s, envelope mode, 5 mV/div, no input filter (1:1 input), 50 $\Omega$ terminator   |
|                        | 720266: 500 S/s, envelope mode, 0.1 mV/div, no input filter, 50 $\Omega$ terminator   |
|                        | 720268: 1 MS/s, envelope mode, 50 mV/div, no input filter, 50 $\Omega$ terminator   |
|                        | 720281: 1 MS/s, envelope mode, Frequency, no input filter, 50 $\Omega$ terminator   |
|                        | Test items  |
|                        | 1. Electrostatic discharge<br>Air discharge: $\pm$ 8 kV. Contact discharge: $\pm$ 4 kV. Criteria B.   |
|                        | 2. Radiated immunity<br>80 M to 1 GHz, 10 V/m, 1.4 G to 6 GHz, 3 V/m, criteria A (except for /30 option)<br>80 M to 1 GHz, 10 V/m, 1 G to 6 GHz, 3 V/m, criteria A (for /30 option)   |
|                        | 3. Conducted immunity<br>10 V, criteria A   |
|                        | 4. Fast transient/burst<br>Power line: $\pm$ 2 kV. Signal line: $\pm$ 1 kV, criteria B  |
|                        | 5. Power frequency magnetic field<br>Omitted, because the device does not exert considerable influence on the magnetic field  |
|                        | 6. Surge immunity<br>$\pm$ 1 kV between lines, $\pm$ 2 kV common, criteria B  |
|                        | 7. Voltage dip and interruption<br>1 cycle, 100%, criteria B<br>Other tests, criteria C   |
|                        | 8. GUE adjacent frequency band selectivity <sup>6</sup>   |
|                        | Definitions of criteria<br>Criteria A: During testing, "influence in the immunity environment" described above is met.<br>Criteria B: The instrument continues to function and is controllable throughout testing. The instrument does not change operation modes, and data changes do not persist.<br>Criteria C: Temporary losses of functionality (such as measurement stopping, etc.) are recovered from through the intervention of the operator.  |
| Environmental standard | Compliant Standards <sup>10</sup><br>EN 50581 Monitoring and control instruments including industrial monitoring and control instruments.<br>Approved (DL850E, DL850EV, 701250, 720250, 701251, 701255, 701267, 720268, 701261, 701262, 701265, 720266, 701270, 701271, 701275, 701281, 720281, 720210, 720211, 720220, 720221, 720230, 720240, 720241, 720242, 720243, 720254, 700986, 700987, 701953, 701955, 701956, 701957, 701958, 702911, 702912) |

- 1 The typical value is a representative or standard value. It is not strictly warranted.
- 2 If the 701260 module is inserted into the DL850E/DL850EV, it will not comply with safety standard EN 61010-1:2010 or EN 61010-2-030:2010.
- 3 The overvoltage category (installation category) is a value used to define the transient overvoltage condition and includes the rated impulse withstand voltage. Category I applies to electric equipment whose power is supplied from a circuit that incorporates withstand voltage control. Category II applies to electrical equipment that is powered through a fixed installation such as a wall outlet wiring to a switchboard.
- 4 The measurement category of this instrument's signal input terminals varies depending on the modules that are installed. Use the instrument within the scope of the measurement category that corresponds to the module specifications. Do not use the instrument outside the scope of the measurement category that corresponds to the module specifications. The scope of each measurement category is as follows.

Measurement category Other (O) applies to measurement of circuits that are not directly connected to a main power supply. This category applies to measurement of secondary electric circuits in equipment across a transformer. If the module specifications fall under measurement category O, the estimated transient voltage that may appear at the signal input terminals is 1500 V.

Measurement category II applies to measurement of circuits, such as household electric appliances and portable electric tools, that are connected to low-voltage installations.

Measurement category III applies to measurement of facility circuits, such as distribution boards and circuit breakers.

Measurement category IV applies to measurement of power source circuits, such as entrance cables to buildings and cable systems, for low-voltage installations.
- 5 Pollution Degree applies to the degree of adhesion of a solid, liquid, or gas which deteriorates withstand voltage or surface resistivity. Pollution degree 2 applies to normal indoor atmospheres (with only non-conductive pollution).
- 6 Only for /30 option
- 7 TDK: ZCAT2035-0930A, YOKOGAWA part number: A1190MN
- 8 TDK: ZCAT3035-1330, YOKOGAWA part number: A1179MN
- 9 TDK: ZCAT1325-0530A, YOKOGAWA part number: A1181MN
- 10 If the 701260 or 701280 module is inserted into the DL850E/DL850EV, it will not comply with environment regulation standard EN 50581:2012.



## 6.13 Module Specifications

### High-Speed 10 MS/s, 12-Bit Isolation Module (701250)

| Item  | Specifications   |
|---|--|
| Standard operating conditions   | Temperature: 23 ±5°C<br>Humidity: 20 to 80% RH<br>After a 30-minute warm-up and after calibration  |
| Effective measurement range   | 20 div (display range: 10 div)   |
| Number of input channels  | 2  |
| Input coupling  | AC, DC, and GND  |
| Maximum sample rate   | 10 MS/s  |
| Input format  | Isolated unbalanced  |
| Frequency characteristics <sup>1</sup><br>(-3 dB point when sine wave of amplitude ±3 div is applied)               | DC to 3 MHz  |
| Voltage-axis sensitivity setting  | 5 mV/div to 20 V/div (1-2-5 steps) (when using 1:1 probe attenuation)  |
| Maximum input voltage<br>(at a frequency of 1 kHz or less)  | Combined with the 700929(10:1), 702902(10:1), or 701947(100:1): <sup>2</sup><br>600 V (DC+ACpeak)<br>Combined with the 701901+701954 (1:1): <sup>4</sup><br>200 V (DC+ACpeak) (as a value that meets the safety standard)<br>250 V (DC+ACpeak) (maximum allowable voltage, as a value that does not damage the instrument when applied)<br>Direct input (cable that does not comply with the safety standards): <sup>6</sup><br>42 V (DC+ACpeak) |
| Maximum rated voltage to earth<br>Between input and case<br>Between each input<br>(at a frequency of 1 kHz or less) | Working voltage of safety standard<br>In combination with 700929 (10:1)/702902 (10:1)/701947 (100:1), <sup>3</sup> or in combination with 701901+701954 (1:1): <sup>5</sup><br>400 Vrms (measurement category Other (O)), 300 Vrms (CAT II)<br>Direct input (cable that does not comply with the safety standards): <sup>7</sup><br>42 V (DC+ACpeak) (CAT II, 30 Vrms)   |
| Vertical (voltage) axis accuracy<br>DC accuracy <sup>1</sup>  | 5 mV/div to 20 V/div: ±(0.5% of 10 div)  |
| Input connector   | BNC connector (isolated type)  |
| Input impedance   | 1 MΩ ± 1%, approx. 35 pF   |
| -3 dB point when AC coupled<br>low frequency attenuation point  | 10 Hz or less (1 Hz or less when using the 700929 or 702902, 0.1 Hz or less when using the 701947)   |
| Common mode rejection ratio   | 80 dB (50/60 Hz) or more (typical value <sup>8</sup> )   |
| Residual noise level<br>(Input section shorted)   | ±400 μV or ±0.06 div whichever is greater (typical value <sup>8</sup> )  |
| Withstand voltage   | 2300Vrms for 2 seconds (across each terminal and earth) (60 Hz)  |
| Insulation resistance   | 500 VDC, 10 MΩ or more (across each input terminal and earth)  |
| A/D conversion resolution   | 12 bit (150 LSB/div)   |
| Temperature coefficient   | Zero point: 5 mV/div to 20 V/div: ±(0.05% of 10 div)/°C (typical value <sup>8</sup> )<br>Gain: ±(0.02% of 10 div)/°C (typical value <sup>8</sup> )   |
| Bandwidth limit   | Select from Full, 500 kHz, 50 kHz, 5 kHz, and 500 Hz<br>Cut-off characteristics: -18 dB/OCT (typical value <sup>8</sup> )  |
| Probe attenuation setting   | Voltage probe: 1:1, 10:1, 100:1, 1000:1<br>Current probe: 1 A:1 V, 10 A:1 V (for the 701932/701933), 100 A: 1 V (for the 701930/701931)  |

| Item                     | Specifications   |
|--------------------------|--|
| Compatible probes/cables | <p>Voltage probe: Recommended</p> <p>700929 (10:1 safety probe), 20 to 45 pF: For measuring 600 V (DC+ACpeak) or less</p> <p>702902 (10:1 safety probe), 25 to 40 pF: For measuring 600 V (DC+ACpeak) or less</p> <p>701947 (100:1 probe), 15 to 45 pF: For measuring 600 V (DC+ACpeak) or less</p> <p>Current probe (power can be supplied from the DL850E/DL850EV, Option)</p> <p>701930 (150 A), 701931 (500 A), 701932 (30 A), 701933 (30 A)</p> <p>Clamp-on probe</p> <p>720930 (50 A), 720931 (200 A)</p> <p>High voltage differential probe (connect the GND cable provided with the probe to the DL850E/DL850EV case)</p> <p>700924 (1000:1, 100:1/1400 V (DC+ACpeak)): For measuring 1400 V (DC+ACpeak) or less</p> <p>Connection cable (for high voltage 1:1)</p> <p>701901 (isolated type BNC-safety alligator clip adapter ×2: For measuring 200 V (DC+ACpeak) or less), 701954 (alligator clip (dolphin type) red/black 2-piece set) is required separately</p> <p>Connection cable (for low voltage 1:1)</p> <p>366926 (non-isolated type BNC-alligator clip ×2: For measuring low voltage less than or equal to 42 V (DC+ACpeak))</p> |

1 Value measured under standard operating conditions.

Combined with the 700929, 702902, or 701947

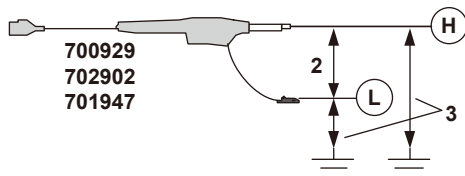

Combined with the 701901+701954

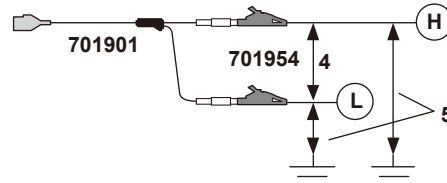

Direct input (cable that does not comply with the safety standards)

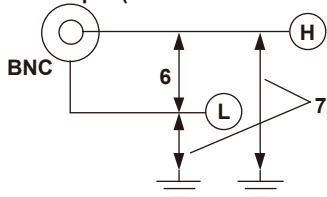

8 The typical value is a representative or standard value. It is not strictly warranted.

## 6.13 Module Specifications

### High-Speed 10 MS/s, 12-Bit Isolation Module (720250)

| Item  | Specifications   |
|---|--|
| Standard operating conditions   | Temperature: 23 ±5°C<br>Humidity: 20 to 80% RH<br>After a 30-minute warm-up and after calibration  |
| Effective measurement range   | 20 div (display range: 10 div)   |
| Number of input channels  | 2  |
| Input coupling  | AC, DC, and GND  |
| Maximum sample rate   | 10 MS/s  |
| Input format  | Isolated unbalanced  |
| Frequency characteristics <sup>1</sup><br>(-3 dB point when sine wave of amplitude ±3 div is applied)               | DC to 3 MHz  |
| Voltage-axis sensitivity setting  | 5 mV/div to 20 V/div (1-2-5 steps) (when using 1:1 probe attenuation)  |
| Maximum input voltage<br>(at a frequency of 1 kHz or less)  | Combined with the 700929(10:1), 702902(10:1), or 701947(100:1): <sup>2</sup><br>800 V (DC+ACpeak)<br>Combined with the 701901+701954 (1:1): <sup>4</sup><br>200 V (DC+ACpeak) (as a value that meets the safety standard)<br>250 V (DC+ACpeak) (maximum allowable voltage, as a value that does not damage the instrument when applied)<br>Direct input (cable that does not comply with the safety standards): <sup>6</sup><br>42 V (DC+ACpeak) |
| Maximum rated voltage to earth<br>Between input and case<br>Between each input<br>(at a frequency of 1 kHz or less) | Working voltage of safety standard<br>In combination with 700929 (10:1)/702902 (10:1)/701947 (100:1), <sup>3</sup> or in combination with 701901+701954 (1:1): <sup>5</sup><br>400 Vrms (CAT II)<br>Direct input (cable that does not comply with the safety standards): <sup>7</sup><br>42 V (DC+ACpeak) (CAT II, 30 Vrms)  |
| Vertical (voltage) axis accuracy<br>DC accuracy <sup>1</sup>  | ±0.5 % of 10 div   |
| Input connector   | BNC connector (isolated type)  |
| Input impedance   | 1 MΩ ± 1%, approx. 35 pF   |
| -3 dB point when AC coupled<br>low frequency attenuation point  | 10 Hz or less (1 Hz or less when using the 700929 or 702902, 0.1 Hz or less when using the 701947)   |
| Common mode rejection ratio   | 80 dB (50/60 Hz) or more (typical value <sup>8</sup> )   |
| Residual noise level<br>(Input section shorted)   | ±400 μV or ±0.06 div whichever is greater (typical value <sup>8</sup> )  |
| Withstand voltage   | 2300 Vrms for 2 seconds (across each terminal and earth)   |
| Insulation resistance   | 500 VDC, 10 MΩ or more (across each input terminal and earth)  |
| A/D conversion resolution   | 12 bit (150 LSB/div)   |
| Temperature coefficient   | Zero point: ±(0.05% of 10 div)/°C (typical value <sup>8</sup> )<br>Gain: ±(0.02% of 10 div)/°C (typical value <sup>8</sup> )   |
| Bandwidth limit   | Select from Full, 500 kHz, 50 kHz, 5 kHz, and 500 Hz<br>Cut-off characteristics: -18 dB/OCT (typical value <sup>8</sup> )  |
| Probe attenuation setting   | Voltage probe: 1:1, 10:1, 100:1, 1000:1<br>Current probe: 1 A:1 V, 10 A:1 V (for the 701932/701933), 100 A: 1 V (for the 701930/701931)<br>Clamp-on probe: 1 A:10 mV (for the 720930), 1 A: 2.5 mV (for the 720931)  |

| Item                     | Specifications   |
|--------------------------|--|
| Compatible probes/cables | <p>Voltage probe: Recommended</p> <p>700929 (10:1 safety probe), 20 to 45 pF: For measuring 600 V (DC+ACpeak) or less</p> <p>702902 (10:1 safety probe), 25 to 40 pF: For measuring 600 V (DC+ACpeak) or less</p> <p>701947 (100:1 probe), 15 to 45 pF: For measuring 600 V (DC+ACpeak) or less</p> <p>Current probe (power can be supplied from the DL850E/DL850EV, Option)</p> <p>701930 (150 A), 701931 (500 A), 701932 (30 A), 701933 (30 A)</p> <p>Clamp-on probe</p> <p>720930 (50 A), 720931 (200 A)</p> <p>High voltage differential probe (connect the GND cable provided with the probe to the DL850E/DL850EV case)</p> <p>700924 (1000:1, 100:1/1400 V (DC+ACpeak)): For measuring 1400 V (DC+ACpeak) or less</p> <p>Connection cable (for high voltage 1:1)</p> <p>701901 (isolated type BNC-safety alligator clip adapter ×2: For measuring 200 V (DC+ACpeak) or less), 701954 (alligator clip (dolphin type) red/black 2-piece set) is required separately</p> <p>Connection cable (for low voltage 1:1)</p> <p>366926 (non-isolated type BNC-alligator clip ×2: For measuring low voltage less than or equal to 42 V (DC+ACpeak))</p> |

1 Value measured under standard operating conditions.

Combined with the 700929, 702902, or 701947

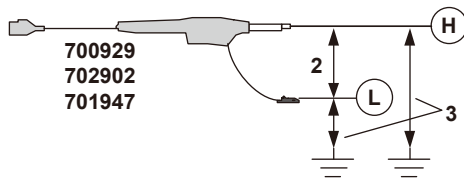

Combined with the 701901+701954

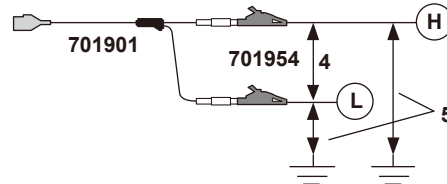

Direct input (cable that does not comply with the safety standards)

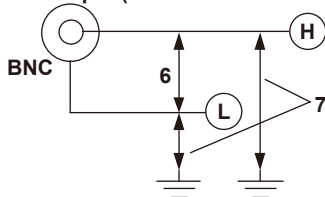

8 The typical value is a representative or standard value. It is not strictly warranted.

## 6.13 Module Specifications

### High-Speed High-Resolution 1 MS/s, 16-Bit Isolation Module (701251)

| Item  | Specifications   |
|---|--|
| Standard operating conditions   | Temperature: 23 ±5°C<br>Humidity: 20 to 80% RH<br>After a 30-minute warm-up and after calibration  |
| Effective measurement range   | 20 div (display range: 10 div)   |
| Number of input channels  | 2  |
| Input coupling  | AC, DC, and GND  |
| Maximum sample rate   | 1 MS/s   |
| Input format  | Isolated unbalanced  |
| Frequency characteristics <sup>1</sup><br>(-3 dB point when a sine wave of amplitude ±3 div is applied)             | 5 mV/div to 20 V/div: DC to 300 kHz<br>2 mV/div and 1mV/div: DC to 200 kHz   |
| Voltage-axis sensitivity setting  | 1 mV/div to 20 V/div (1-2-5 steps) (when using 1:1 probe attenuation)  |
| Maximum input voltage<br>(at a frequency of 1 kHz or less)  | Combined with the 700929 (10:1), 702902 (10:1), or 701947 (100:1): <sup>2</sup><br>600 V (DC+ACpeak)<br>Combined with the 701901+701954 (1:1): <sup>4</sup><br>140 V (DC+ACpeak)<br>Direct input (cable that does not comply with the safety standards): <sup>6</sup><br>42 V (DC+ACpeak)  |
| Maximum rated voltage to earth<br>Between input and case<br>Between each input<br>(at a frequency of 1 kHz or less) | Working voltage of safety standard<br>In combination with 700929 (10:1)/702902 (10:1)/701947 (100:1), <sup>3</sup> or in combination with 701901+701954 (1:1): <sup>5</sup><br>400 Vrms (measurement category Other (O)), 300 Vrms (CAT II)<br>Direct input (cable that does not comply with the safety standards): <sup>7</sup><br>42 V (DC+ACpeak) (CAT II, 30 Vrms) |
| Vertical (voltage) axis accuracy<br>DC accuracy <sup>1</sup>  | 5 mV/div to 20 V/div: ±(0.25% of 10 div)<br>2 mV/div: ±(0.3% of 10 div)<br>1 mV/div: ±(0.5% of 10 div)   |
| Input connector   | BNC connector (isolated type)  |
| Input impedance   | 1 MΩ ± 1%, approx. 35 pF   |
| -3 dB point when AC coupled<br>low frequency attenuation point  | 1 Hz or less (0.1 Hz or less when using the 700929 or 702902, 0.01 Hz or less when using the 701947)   |
| Common mode rejection ratio   | 80 dB (50/60 Hz) or more (typical value <sup>8</sup> )   |
| Residual noise level<br>(Input section shorted)   | ±100 μV or ±0.01 div whichever is greater (typical value <sup>8</sup> )  |
| Withstand voltage   | 2300 Vrms for 2 seconds (across each terminal and earth) (60 Hz)   |
| Insulation resistance   | 500 VDC, 10 MΩ or more (across each input terminal and earth)  |
| A/D conversion resolution   | 16 bit (2400 LSB/div)  |
| Temperature coefficient   | Zero point: 5 mV/div to 20 V/div: ±(0.02% of 10 div)/°C (typical value <sup>8</sup> )<br>2 mV/div: ±(0.05% of 10 div)/°C (typical value <sup>8</sup> )<br>1 mV/div: ±(0.10% of 10 div)/°C (typical value <sup>8</sup> )<br>Gain: 1 mV/div to 20 V/div: ±(0.02% of 10 div)/°C (typical value <sup>8</sup> )   |
| Bandwidth limit   | Select from Full, 40 kHz, 4 kHz, and 400 Hz<br>Cut-off characteristics: -12 dB/OCT (typical value <sup>8</sup> )   |
| Probe attenuation setting   | Voltage probe: 1:1, 10:1, 100:1, 1000:1<br>Current probe: 1 A:1 V, 10 A:1 V (for the 701932/701933), 100 A: 1 V (for the 701930/701931)<br>Clamp-on probe: 1 A:10 mV (for the 720930), 1 A: 2.5 mV (for the 720931)  |

| Item                     | Specifications  |
|--------------------------|---|
| Compatible probes/cables | Voltage probe: Recommended<br>700929 (10:1 safety probe), 20 to 45 pF: For measuring 600 V (DC+ACpeak) or less<br>702902 (10:1 safety probe), 25 to 40 pF: For measuring 600 V (DC+ACpeak) or less<br>701947 (100:1 probe), 15 to 45 pF: For measuring 600 V (DC+ACpeak) or less<br>Current probe (power can be supplied from the DL850E/DL850EV. Option)<br>701930 (150 A), 701931 (500 A), 701932 (30 A), 701933 (30 A)<br>Clamp-on probe<br>720930 (50 A), 720931 (200 A)<br>High voltage differential probe (connect the GND cable provided with the probe to the DL850E/DL850EV case)<br>700924 (1000:1, 100:1/1400 V (DC+ACpeak)): For measuring 1400 V (DC+ACpeak) or less<br>Connection cable (for high voltage 1:1)<br>701901 (isolated type BNC-safety alligator clip adapter ×2: For measuring 200 V (DC+ACpeak) or less), 701954 (alligator clip (dolphin type) red/black 2-piece set) is required separately<br>Connection cable (for low voltage 1:1)<br>366926 (non-isolated type BNC-alligator clip ×2: For measuring low voltage less than or equal to 42 V (DC+ACpeak)) |

1 Value measured under standard operating conditions.

Combined with the 700929, 702902, or 701947

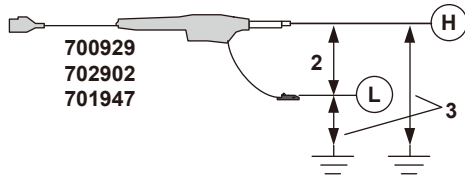

Combined with the 701901+701954

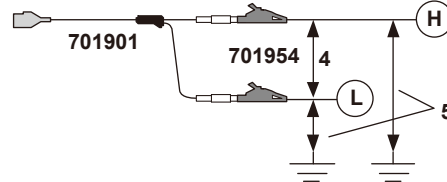

Direct input (cable that does not comply with the safety standards)

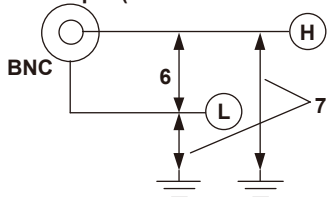

8 The typical value is a representative or standard value. It is not strictly warranted.

## 6.13 Module Specifications

### High-Speed 10 MS/s, 12-Bit Non-Isolation Module (701255)

| Item  | Specifications   |
|---|--|
| Standard operating conditions   | Temperature: 23 ±5°C<br>Humidity: 20 to 80% RH<br>After a 30-minute warm-up and after calibration  |
| Effective measurement range   | 20 div (display range: 10 div)   |
| Number of input channels  | 2  |
| Input coupling  | AC, DC, and GND  |
| Maximum sample rate   | 10 MS/s  |
| Input format  | Non-isolated, unbalanced   |
| Frequency characteristics <sup>1</sup><br>(-3 dB point when sine wave of amplitude ±3 div is applied) | DC to 3 MHz  |
| Voltage-axis sensitivity setting  | 5 mV/div to 20 V/div (1-2-5 steps) (when using 1:1 probe attenuation)  |
| Maximum input voltage<br>(at a frequency of 1 kHz or less)  | Combined with the 701940 (10:1): <sup>2</sup><br>600 V (DC+ACpeak)<br>Direct input (cable that does not comply with the safety standards): <sup>3</sup><br>200 V (DC+ACpeak) (as a value that meets the safety standard)<br>250 V (DC+ACpeak) (maximum allowable voltage, as a value that does not damage the instrument when applied)   |
| Vertical (voltage) axis accuracy<br>DC accuracy <sup>1</sup>  | 5 mV/div to 20 V/div: ±(0.5% of 10 div)  |
| Input connector   | BNC connector (metallic type)  |
| Input impedance   | 1 MΩ ± 1%, approx. 35 pF   |
| -3 dB point when AC coupled<br>low frequency attenuation point  | 10 Hz or less (1 Hz or less when using the 701940)   |
| Residual noise level<br>(Input section shorted)   | ±400 μV or ±0.06 div whichever is greater (typical value <sup>4</sup> )  |
| A/D conversion resolution   | 12 bit (150 LSB/div)   |
| Temperature coefficient   | Zero point: 5 mV/div to 20 V/div: ±(0.05% of 10 div)/°C (typical value <sup>4</sup> )<br>Gain: ±(0.02% of 10 div)/°C (typical value <sup>4</sup> )   |
| Bandwidth limit   | Select from Full, 500 kHz, 50 kHz, 5 kHz, and 5400 Hz<br>Cut-off characteristics: -18 dB/OCT (typical value <sup>4</sup> )   |
| Probe attenuation setting   | Voltage probe: 1:1, 10:1, 100:1, 1000:1<br>Current probe: 1 A:1 V, 10 A:1 V (for the 701932/701933), 100 A: 1 V (for the 701930/701931)<br>Clamp-on probe: 1 A:10 mV (for the 720930), 1 A: 2.5 mV (for the 720931)  |
| Compatible probes/cables  | Voltage probe (10:1 passive probe): Recommended<br>701940, 17 to 46 pF: For measuring 600 V (DC+ACpeak) or less<br>Current probe (power can be supplied from the DL850E/DL850EV. Option)<br>701930 (150 A), 701931 (500 A), 701932 (30 A), 701933 (30 A)<br>Clamp-on probe<br>720930 (50 A), 720931 (200 A)<br>High voltage differential probe (connect the GND cable provided with the probe to the DL850E/DL850EV case)<br>700924 (1000:1, 100:1/1400 V (DC+ACpeak)): For measuring 1400 V (DC+ACpeak) or less<br>Connection cable (for low voltage 1:1)<br>366926 (non-isolated type BNC-alligator clip ×2: For measuring low voltage less than or equal to 42 V (DC+ACpeak)) |

1 Value measured under standard operating conditions.

**Recommended:  
Combined with the 10:1 passive probe  
(701940)**

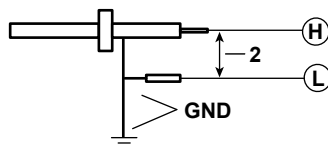

**GND is connected to the case potential.**

**Direct input  
(cable that does not comply with the safety standards)**

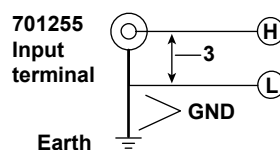

**GND is connected to the case potential.**

4 The typical value is a representative or standard value. It is not strictly warranted.

## High-Voltage 100 kS/s, 16-Bit Isolation Module (with RMS) (701267)

| Item  | Specifications   |
|---|--|
| Standard operating conditions   | Temperature: 23 ±5°C<br>Humidity: 20 to 80% RH<br>After a 30-minute warm-up and after calibration  |
| Effective measurement range   | 20 div (display range: 10 div)   |
| Number of input channels  | 2  |
| Input coupling  | AC, DC, GND, AC-RMS, and DC-RMS  |
| Maximum sample rate   | 100 kS/s   |
| Input format  | Isolated unbalanced  |
| Frequency characteristics <sup>1</sup><br>(-3 dB point when a sine wave of amplitude ±3 div is applied) | Waveform observation mode: DC to 40 kHz<br>RMS observation mode: DC, 40 Hz to 10 kHz   |
| Voltage-axis sensitivity setting  | 20 mV/div to 200 V/div (1-2-5 steps)   |
| Maximum input voltage<br>(at a frequency of 1 kHz or less)  | Combined with the 758933+701954 or 701904+701954: <sup>2</sup> 850 V (DC+ACpeak)<br>Direct input (cable that does not comply with the safety standards): <sup>5</sup> 42 V (DC+ACpeak)   |
| Maximum rated voltage to earth  | Working voltage of safety standard<br>Combined with the 758933+701954 or 701904+701954   |
| Between input and case  | Across probe tip H and earth: <sup>3</sup> 700 Vrms (CAT II)   |
| Between each input<br>(at a frequency of 1 kHz or less)   | Across probe tip L and earth: <sup>4</sup> 400 Vrms (CAT II)   |
|   | Direct input (cable that does not comply with the safety standards)<br>Across the input terminal, H or L, and earth: <sup>6</sup> 42 V (DC+ACpeak) (CAT II, 30 Vrms)   |
| Vertical (voltage) axis accuracy DC accuracy <sup>1</sup>   | Waveform observation mode<br>DC accuracy ±(0.25% of 10 div)<br>RMS observation mode<br>DC accuracy ±(1.0% of 10 div)<br>AC accuracy (when a sine wave is input) ±(1.5% of 10 div) At frequency of 40 Hz to 1 kHz<br>AC accuracy (when the crest factor is 2 or less) ±(2.0% of 10 div) At frequency of 40 Hz to 1 kHz<br>AC accuracy (when the crest factor is 3 or less) ±(3.0% of 10 div) At frequency of 40 Hz to 1 kHz |
| Input connector   | Plug-in terminal (safety terminal)   |
| Input impedance   | 1 MΩ ± 1%, approx. 35 pF   |
| -3 dB point when AC coupled low frequency attenuation point   | 1 Hz or less   |
| Common mode rejection ratio   | 80 dB (50/60 Hz) or more (typical value <sup>7</sup> )   |
| Residual noise level<br>(Input section shorted)   | ±1 mV or ±0.02 div whichever is greater (typical value <sup>7</sup> )  |
| Withstand voltage   | 3510 Vrms for 2 seconds (across each terminal and earth) (60 Hz)   |
| Insulation resistance   | 500 VDC, 10 MΩ or more (across each input terminal and earth)  |
| A/D conversion resolution   | 16 bit (2400 LSB/div)  |
| Temperature coefficient   | Zero point: ±(0.02% of 10 div)/°C (typical value <sup>7</sup> )<br>Gain: ±(0.02% of 10 div)/°C (typical value <sup>7</sup> )   |
| Response time (only when observing RMS)   | Rising (0 to 90% of 10 div): 100 ms (typical value <sup>7</sup> )<br>Falling (100 to 10% of 10 div): 250 ms (typical value <sup>7</sup> )  |
| Bandwidth limit   | Select from Full, 10 kHz, 1 kHz, and 100 Hz<br>Cut-off characteristics: -12 dB/OCT (typical value <sup>7</sup> )   |
| Connection cable  | Measurement lead 758933 and alligator clip for measuring 850 V (DC+ACpeak) or less<br>1:1 safety cables 701904 and alligator clip for measuring 850 V (DC+ACpeak) or less<br>(the alligator clip (dolphin type) 701954 is recommended)   |



### 6.13 Module Specifications

---

1. Value measured under standard operating conditions.

**Combined with the 758933+701954 or 701904+701954**

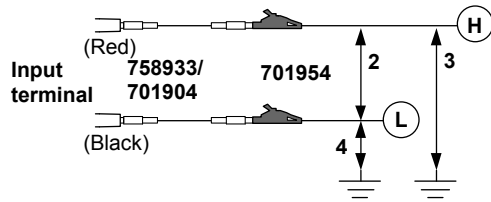

**Direct input (cable that does not comply with the safety standards)**

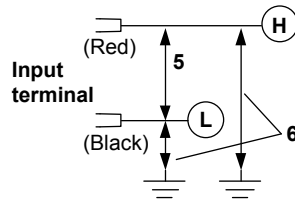

7 The typical value is a representative or standard value. It is not strictly warranted.

## High-Voltage 1 MS/s, 16-Bit Isolation Module (with AAF, RMS) (720268)

| Item  | Specifications  |   |                       |                    |        |                    |                        |                |       |  |
|---|---|---|-----------------------|--------------------|--------|--------------------|------------------------|----------------|-------|--|
| Standard operating conditions   | Temperature: 23 ±5°C<br>Humidity: 20 to 80% RH<br>After a 30-minute warm-up and after calibration   |   |                       |                    |        |                    |                        |                |       |  |
| Effective measurement range   | 20 div (display range: 10 div)  |   |                       |                    |        |                    |                        |                |       |  |
| Number of input channels  | 2   |   |                       |                    |        |                    |                        |                |       |  |
| Input coupling  | AC, DC, GND, AC-RMS, and DC-RMS   |   |                       |                    |        |                    |                        |                |       |  |
| Maximum sample rate   | 1 MS/s  |   |                       |                    |        |                    |                        |                |       |  |
| Input format  | Isolated unbalanced   |   |                       |                    |        |                    |                        |                |       |  |
| Frequency characteristics <sup>1</sup><br>(-3 dB point when a sine wave of amplitude ±3 div is applied) | Waveform observation mode: DC to 300 kHz<br>RMS observation mode: DC, 40 Hz to 100 kHz  |   |                       |                    |        |                    |                        |                |       |  |
| Voltage-axis sensitivity setting  | 20 mV/div to 200 V/div (1-2-5 steps)  |   |                       |                    |        |                    |                        |                |       |  |
| Maximum input voltage<br>(at a frequency of 1 kHz or less)  | Combined with the 758933+701954 or 701904+701954 <sup>2, 7</sup> :<br>Direct input (cable that does not comply with the safety standards): <sup>4</sup>   | 850 V (DC+ACpeak)<br>42 V (DC+ACpeak)   |                       |                    |        |                    |                        |                |       |  |
| Maximum rated voltage to earth  | Combined with the 758933+701954 or 701904+701954 <sup>3</sup> :   | 1000 Vrms (CAT II),<br>600 Vrms (CAT III)   |                       |                    |        |                    |                        |                |       |  |
| Between input and case<br>Between each input<br>(at a frequency of 1 kHz or less)                       | Direct input (cable that does not comply with the safety standards): <sup>5</sup>   | 42 V (DC+ACpeak) (CAT II,<br>30 Vrms)   |                       |                    |        |                    |                        |                |       |  |
| Vertical (voltage) axis accuracy DC accuracy <sup>1</sup>   | Waveform observation mode<br>DC accuracy<br>RMS observation mode<br>DC accuracy<br>AC accuracy (when a sine wave is input)<br>AC accuracy (when the crest factor is 2 or less)<br>AC accuracy (when the crest factor is 3 or less)  | ±(0.25% of 10 div)<br>±(1.0% of 10 div)<br>±(1.5% of 10 div) At frequency of 40 Hz to 10 kHz<br>±(2.0% of 10 div) At frequency of 40 Hz to 10 kHz<br>±(3.0% of 10 div) At frequency of 40 Hz to 10 kHz<br>1kHz to 10kHz: Add 1.0% to the above AC accuracy. |                       |                    |        |                    |                        |                |       |  |
| Input connector   | Plug-in terminal (safety terminal)  |   |                       |                    |        |                    |                        |                |       |  |
| Input impedance   | 2 MΩ ± 1%, approx. 12 pF  |   |                       |                    |        |                    |                        |                |       |  |
| -3 dB point when AC coupled low frequency attenuation point   | 1 Hz or less  |   |                       |                    |        |                    |                        |                |       |  |
| Common mode rejection ratio   | 80 dB (50/60 Hz) or more (typical value <sup>6</sup> )  |   |                       |                    |        |                    |                        |                |       |  |
| Residual noise level<br>(Input section shorted)   | ±2 mV or ±0.04 div whichever is greater (typical value <sup>6</sup> )   |   |                       |                    |        |                    |                        |                |       |  |
| Withstand voltage   | 5400 VACrms for 2 seconds (across each terminal and earth) (60 Hz)  |   |                       |                    |        |                    |                        |                |       |  |
| Insulation resistance   | 500 VDC, 10 MΩ or more (across each input terminal and earth)   |   |                       |                    |        |                    |                        |                |       |  |
| A/D conversion resolution   | 16 bit (2400 LSB/div)   |   |                       |                    |        |                    |                        |                |       |  |
| Temperature coefficient   | Zero point: ±(0.02% of 10 div)/°C (typical value <sup>6</sup> )<br>Gain: ±(0.02% of 10 div)/°C (typical value <sup>6</sup> )  |   |                       |                    |        |                    |                        |                |       |  |
| Response time (only when observing RMS)   | Rising (0 to 90% of 10 div):<br>Falling (100 to 10% of 10 div):   | 120 ms (typical value <sup>6</sup> )<br>280 ms (typical value <sup>6</sup> )  |                       |                    |        |                    |                        |                |       |  |
| Bandwidth limit   | Select from Full, 40 kHz, 4 kHz, 400 Hz, and AUTO<br>Cut-off characteristics: Setting other than AUTO: -18 dB/OCT (typical value <sup>6</sup> )<br>AUTO: Digital filter<br>Cutoff frequency (fc) when set to AUTO   |   |                       |                    |        |                    |                        |                |       |  |
|   | <table border="1" style="margin-left: auto; margin-right: auto;"> <thead> <tr> <th>Sample Rate</th> <th>Cutoff Frequency (fc)</th> </tr> </thead> <tbody> <tr> <td>100 kS/s or higher</td> <td>40 kHz</td> </tr> <tr> <td>100 S/s to 50 kS/s</td> <td>40% of the sample rate</td> </tr> <tr> <td>50 S/s or less</td> <td>40 Hz</td> </tr> </tbody> </table> | Sample Rate   | Cutoff Frequency (fc) | 100 kS/s or higher | 40 kHz | 100 S/s to 50 kS/s | 40% of the sample rate | 50 S/s or less | 40 Hz |  |
| Sample Rate   | Cutoff Frequency (fc)   |   |                       |                    |        |                    |                        |                |       |  |
| 100 kS/s or higher  | 40 kHz  |   |                       |                    |        |                    |                        |                |       |  |
| 100 S/s to 50 kS/s  | 40% of the sample rate  |   |                       |                    |        |                    |                        |                |       |  |
| 50 S/s or less  | 40 Hz   |   |                       |                    |        |                    |                        |                |       |  |
| Connection cable  | Measurement lead 758933 and alligator clip for measuring 1000 V (DC+ACpeak) or less<br>1:1 safety cables 701904 and alligator clip for measuring 1000 V (DC+ACpeak) or less<br>(the alligator clip (dolphin type) 701954 is recommended)  |   |                       |                    |        |                    |                        |                |       |  |
| Crest factor (only when observing RMS)  | 3 or less   |   |                       |                    |        |                    |                        |                |       |  |

### 6.13 Module Specifications

| Item  | Specifications  |                 |     |                 |        |        |        |          |        |        |          |        |        |          |        |        |         |        |        |         |       |        |         |       |       |        |       |       |        |        |       |        |        |        |         |        |        |         |       |        |         |       |        |        |       |        |            |     |     |
|---|---|-----------------|-----|-----------------|--------|--------|--------|----------|--------|--------|----------|--------|--------|----------|--------|--------|---------|--------|--------|---------|-------|--------|---------|-------|-------|--------|-------|-------|--------|--------|-------|--------|--------|--------|---------|--------|--------|---------|-------|--------|---------|-------|--------|--------|-------|--------|------------|-----|-----|
| Maximum setting range of DC offset  | ±5 div  |                 |     |                 |        |        |        |          |        |        |          |        |        |          |        |        |         |        |        |         |       |        |         |       |       |        |       |       |        |        |       |        |        |        |         |        |        |         |       |        |         |       |        |        |       |        |            |     |     |
| Input bias current  | 2 nA or less  |                 |     |                 |        |        |        |          |        |        |          |        |        |          |        |        |         |        |        |         |       |        |         |       |       |        |       |       |        |        |       |        |        |        |         |        |        |         |       |        |         |       |        |        |       |        |            |     |     |
| Table of cutoff frequency characteristics of the anti-aliasing filter (AAF) | When the filter is set to Auto, the anti-aliasing filter and low-pass filter are automatically set according to the sample rate.  |                 |     |                 |        |        |        |          |        |        |          |        |        |          |        |        |         |        |        |         |       |        |         |       |       |        |       |       |        |        |       |        |        |        |         |        |        |         |       |        |         |       |        |        |       |        |            |     |     |
|   | <table border="1"> <thead> <tr> <th>Sample Rate</th> <th>AAF</th> <th>Low-Pass Filter</th> </tr> </thead> <tbody> <tr><td>1 MS/s</td><td>40 kHz</td><td>40 kHz</td></tr> <tr><td>500 kS/s</td><td>40 kHz</td><td>40 kHz</td></tr> <tr><td>200 kS/s</td><td>40 kHz</td><td>40 kHz</td></tr> <tr><td>100 kS/s</td><td>40 kHz</td><td>40 kHz</td></tr> <tr><td>50 kS/s</td><td>20 kHz</td><td>40 kHz</td></tr> <tr><td>20 kS/s</td><td>8 kHz</td><td>40 kHz</td></tr> <tr><td>10 kS/s</td><td>4 kHz</td><td>4 kHz</td></tr> <tr><td>5 kS/s</td><td>2 kHz</td><td>4 kHz</td></tr> <tr><td>2 kS/s</td><td>800 Hz</td><td>4 kHz</td></tr> <tr><td>1 kS/s</td><td>400 Hz</td><td>400 Hz</td></tr> <tr><td>500 S/s</td><td>200 Hz</td><td>400 Hz</td></tr> <tr><td>200 S/s</td><td>80 Hz</td><td>400 Hz</td></tr> <tr><td>100 S/s</td><td>40 Hz</td><td>400 Hz</td></tr> <tr><td>50 S/s</td><td>40 Hz</td><td>400 Hz</td></tr> <tr><td>Ext sample</td><td>OFF</td><td>OFF</td></tr> </tbody> </table> | Sample Rate     | AAF | Low-Pass Filter | 1 MS/s | 40 kHz | 40 kHz | 500 kS/s | 40 kHz | 40 kHz | 200 kS/s | 40 kHz | 40 kHz | 100 kS/s | 40 kHz | 40 kHz | 50 kS/s | 20 kHz | 40 kHz | 20 kS/s | 8 kHz | 40 kHz | 10 kS/s | 4 kHz | 4 kHz | 5 kS/s | 2 kHz | 4 kHz | 2 kS/s | 800 Hz | 4 kHz | 1 kS/s | 400 Hz | 400 Hz | 500 S/s | 200 Hz | 400 Hz | 200 S/s | 80 Hz | 400 Hz | 100 S/s | 40 Hz | 400 Hz | 50 S/s | 40 Hz | 400 Hz | Ext sample | OFF | OFF |
| Sample Rate   | AAF   | Low-Pass Filter |     |                 |        |        |        |          |        |        |          |        |        |          |        |        |         |        |        |         |       |        |         |       |       |        |       |       |        |        |       |        |        |        |         |        |        |         |       |        |         |       |        |        |       |        |            |     |     |
| 1 MS/s  | 40 kHz  | 40 kHz          |     |                 |        |        |        |          |        |        |          |        |        |          |        |        |         |        |        |         |       |        |         |       |       |        |       |       |        |        |       |        |        |        |         |        |        |         |       |        |         |       |        |        |       |        |            |     |     |
| 500 kS/s  | 40 kHz  | 40 kHz          |     |                 |        |        |        |          |        |        |          |        |        |          |        |        |         |        |        |         |       |        |         |       |       |        |       |       |        |        |       |        |        |        |         |        |        |         |       |        |         |       |        |        |       |        |            |     |     |
| 200 kS/s  | 40 kHz  | 40 kHz          |     |                 |        |        |        |          |        |        |          |        |        |          |        |        |         |        |        |         |       |        |         |       |       |        |       |       |        |        |       |        |        |        |         |        |        |         |       |        |         |       |        |        |       |        |            |     |     |
| 100 kS/s  | 40 kHz  | 40 kHz          |     |                 |        |        |        |          |        |        |          |        |        |          |        |        |         |        |        |         |       |        |         |       |       |        |       |       |        |        |       |        |        |        |         |        |        |         |       |        |         |       |        |        |       |        |            |     |     |
| 50 kS/s   | 20 kHz  | 40 kHz          |     |                 |        |        |        |          |        |        |          |        |        |          |        |        |         |        |        |         |       |        |         |       |       |        |       |       |        |        |       |        |        |        |         |        |        |         |       |        |         |       |        |        |       |        |            |     |     |
| 20 kS/s   | 8 kHz   | 40 kHz          |     |                 |        |        |        |          |        |        |          |        |        |          |        |        |         |        |        |         |       |        |         |       |       |        |       |       |        |        |       |        |        |        |         |        |        |         |       |        |         |       |        |        |       |        |            |     |     |
| 10 kS/s   | 4 kHz   | 4 kHz           |     |                 |        |        |        |          |        |        |          |        |        |          |        |        |         |        |        |         |       |        |         |       |       |        |       |       |        |        |       |        |        |        |         |        |        |         |       |        |         |       |        |        |       |        |            |     |     |
| 5 kS/s  | 2 kHz   | 4 kHz           |     |                 |        |        |        |          |        |        |          |        |        |          |        |        |         |        |        |         |       |        |         |       |       |        |       |       |        |        |       |        |        |        |         |        |        |         |       |        |         |       |        |        |       |        |            |     |     |
| 2 kS/s  | 800 Hz  | 4 kHz           |     |                 |        |        |        |          |        |        |          |        |        |          |        |        |         |        |        |         |       |        |         |       |       |        |       |       |        |        |       |        |        |        |         |        |        |         |       |        |         |       |        |        |       |        |            |     |     |
| 1 kS/s  | 400 Hz  | 400 Hz          |     |                 |        |        |        |          |        |        |          |        |        |          |        |        |         |        |        |         |       |        |         |       |       |        |       |       |        |        |       |        |        |        |         |        |        |         |       |        |         |       |        |        |       |        |            |     |     |
| 500 S/s   | 200 Hz  | 400 Hz          |     |                 |        |        |        |          |        |        |          |        |        |          |        |        |         |        |        |         |       |        |         |       |       |        |       |       |        |        |       |        |        |        |         |        |        |         |       |        |         |       |        |        |       |        |            |     |     |
| 200 S/s   | 80 Hz   | 400 Hz          |     |                 |        |        |        |          |        |        |          |        |        |          |        |        |         |        |        |         |       |        |         |       |       |        |       |       |        |        |       |        |        |        |         |        |        |         |       |        |         |       |        |        |       |        |            |     |     |
| 100 S/s   | 40 Hz   | 400 Hz          |     |                 |        |        |        |          |        |        |          |        |        |          |        |        |         |        |        |         |       |        |         |       |       |        |       |       |        |        |       |        |        |        |         |        |        |         |       |        |         |       |        |        |       |        |            |     |     |
| 50 S/s  | 40 Hz   | 400 Hz          |     |                 |        |        |        |          |        |        |          |        |        |          |        |        |         |        |        |         |       |        |         |       |       |        |       |       |        |        |       |        |        |        |         |        |        |         |       |        |         |       |        |        |       |        |            |     |     |
| Ext sample  | OFF   | OFF             |     |                 |        |        |        |          |        |        |          |        |        |          |        |        |         |        |        |         |       |        |         |       |       |        |       |       |        |        |       |        |        |        |         |        |        |         |       |        |         |       |        |        |       |        |            |     |     |

1. Value measured under standard operating conditions.

**Combined with the 758933+701954 or 701904+701954**

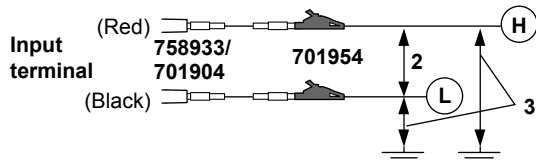

**Withstand voltage: 2210 Vrms for 1 minute**  
**Allowable transient surge voltage (between earth and input): ±3100 Vpeak**

**Direct input (cable that does not comply with the safety standards)**

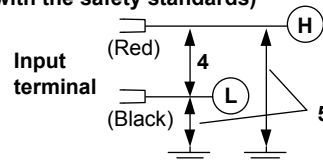

- 6 The typical value is a representative or standard value. It is not strictly warranted.
- 7 When using this module other than DL850, DL850V, DL850E, DL850EV, or SL1000, the maximum input voltage is 1000 Vrms: however, 1000 VDC or 1414 Vpeak MAX.

## Universal (Voltage/Temp.) Module (701261) /Universal (Voltage/Temp.) Module (with AAF) (701262)

| Item   | Specifications  |   |                   |          |   |                |   |   |               |   |                |   |               |   |               |   |               |   |             |   |             |   |             |   |             |   |             |                          |                    |           |                                    |
|--|---|---|-------------------|----------|---|----------------|---|---|---------------|---|----------------|---|---------------|---|---------------|---|---------------|---|-------------|---|-------------|---|-------------|---|-------------|---|-------------|--------------------------|--------------------|-----------|------------------------------------|
| Standard operating conditions  | Temperature: 23 ±5°C<br>Humidity: 20 to 80% RH<br>After a 30-minute warm-up and after calibration   |   |                   |          |   |                |   |   |               |   |                |   |               |   |               |   |               |   |             |   |             |   |             |   |             |   |             |                          |                    |           |                                    |
| Function   | Temperature (thermocouple) or voltage measurement (switchable)  |   |                   |          |   |                |   |   |               |   |                |   |               |   |               |   |               |   |             |   |             |   |             |   |             |   |             |                          |                    |           |                                    |
| Effective measurement range  | [Voltage measurement] 20 div (display range: 10 div)  |   |                   |          |   |                |   |   |               |   |                |   |               |   |               |   |               |   |             |   |             |   |             |   |             |   |             |                          |                    |           |                                    |
| Number of input channels   | 2   |   |                   |          |   |                |   |   |               |   |                |   |               |   |               |   |               |   |             |   |             |   |             |   |             |   |             |                          |                    |           |                                    |
| Input coupling   | TC, DC, AC, and GND<br>TC: Temperature (thermocouple) measurement<br>DC: Voltage measurement (DC coupling)<br>AC: Voltage measurement (AC coupling)   |   |                   |          |   |                |   |   |               |   |                |   |               |   |               |   |               |   |             |   |             |   |             |   |             |   |             |                          |                    |           |                                    |
| Voltage measurement maximum sample rate  | 100 kS/s  |   |                   |          |   |                |   |   |               |   |                |   |               |   |               |   |               |   |             |   |             |   |             |   |             |   |             |                          |                    |           |                                    |
| Temperature measurement data update rate   | 500 Hz  |   |                   |          |   |                |   |   |               |   |                |   |               |   |               |   |               |   |             |   |             |   |             |   |             |   |             |                          |                    |           |                                    |
| Input format   | Isolated unbalanced   |   |                   |          |   |                |   |   |               |   |                |   |               |   |               |   |               |   |             |   |             |   |             |   |             |   |             |                          |                    |           |                                    |
| Measurement range/accuracy <sup>1</sup>  | [Voltage measurement] Voltage sensitivity: 5 mV/div to 20 V/div (1-2-5 steps)<br>Voltage accuracy: ±(0.25% of 10 div)   |   |                   |          |   |                |   |   |               |   |                |   |               |   |               |   |               |   |             |   |             |   |             |   |             |   |             |                          |                    |           |                                    |
| Thermocouple standards   | [Temperature measurement] <sup>2</sup>  |   |                   |          |   |                |   |   |               |   |                |   |               |   |               |   |               |   |             |   |             |   |             |   |             |   |             |                          |                    |           |                                    |
| <ul style="list-style-type: none"> <li>• K, E, J, T, N, R, S, B:<br/>IEC 60584-1</li> <li>• DIN IEC 60584-1</li> <li>• JIS C1602</li> <li>• W: W-5%/Re/W-26%/Re<br/>(Hoskins Mfg. Co.)</li> <li>• ASTM E988</li> <li>• L: Fe-CuNi, DIN43710</li> <li>• U: Cu-CuNi, DIN43710</li> </ul> | <table border="1"> <thead> <tr> <th>Type</th> <th>Measurement Range</th> <th>Accuracy</th> </tr> </thead> <tbody> <tr> <td>K</td> <td>-200 to 1300°C</td> <td rowspan="10">±(0.1% of reading + 1.5°C)<br/>Except ±(0.2% of reading + 1.5°C) for -200°C to 0°C</td> </tr> <tr> <td>E</td> <td>-200 to 800°C</td> </tr> <tr> <td>J</td> <td>-200 to 1100°C</td> </tr> <tr> <td>T</td> <td>-200 to 400°C</td> </tr> <tr> <td>L</td> <td>-200 to 900°C</td> </tr> <tr> <td>U</td> <td>-200 to 400°C</td> </tr> <tr> <td>N</td> <td>0 to 1300°C</td> </tr> <tr> <td>R</td> <td>0 to 1700°C</td> </tr> <tr> <td>S</td> <td>0 to 1700°C</td> </tr> <tr> <td>B</td> <td>0 to 1800°C</td> </tr> <tr> <td>W</td> <td>0 to 2300°C</td> <td>±(0.1% of reading + 3°C)</td> </tr> <tr> <td>Au7Fe<sup>3</sup></td> <td>0 to 300K</td> <td>0 to 50K: ±4K<br/>50 to 300K: ±2.5K</td> </tr> </tbody> </table> | Type  | Measurement Range | Accuracy | K | -200 to 1300°C | ±(0.1% of reading + 1.5°C)<br>Except ±(0.2% of reading + 1.5°C) for -200°C to 0°C | E | -200 to 800°C | J | -200 to 1100°C | T | -200 to 400°C | L | -200 to 900°C | U | -200 to 400°C | N | 0 to 1300°C | R | 0 to 1700°C | S | 0 to 1700°C | B | 0 to 1800°C | W | 0 to 2300°C | ±(0.1% of reading + 3°C) | Au7Fe <sup>3</sup> | 0 to 300K | 0 to 50K: ±4K<br>50 to 300K: ±2.5K |
| Type   | Measurement Range   | Accuracy  |                   |          |   |                |   |   |               |   |                |   |               |   |               |   |               |   |             |   |             |   |             |   |             |   |             |                          |                    |           |                                    |
| K  | -200 to 1300°C  | ±(0.1% of reading + 1.5°C)<br>Except ±(0.2% of reading + 1.5°C) for -200°C to 0°C |                   |          |   |                |   |   |               |   |                |   |               |   |               |   |               |   |             |   |             |   |             |   |             |   |             |                          |                    |           |                                    |
| E  | -200 to 800°C   |   |                   |          |   |                |   |   |               |   |                |   |               |   |               |   |               |   |             |   |             |   |             |   |             |   |             |                          |                    |           |                                    |
| J  | -200 to 1100°C  |   |                   |          |   |                |   |   |               |   |                |   |               |   |               |   |               |   |             |   |             |   |             |   |             |   |             |                          |                    |           |                                    |
| T  | -200 to 400°C   |   |                   |          |   |                |   |   |               |   |                |   |               |   |               |   |               |   |             |   |             |   |             |   |             |   |             |                          |                    |           |                                    |
| L  | -200 to 900°C   |   |                   |          |   |                |   |   |               |   |                |   |               |   |               |   |               |   |             |   |             |   |             |   |             |   |             |                          |                    |           |                                    |
| U  | -200 to 400°C   |   |                   |          |   |                |   |   |               |   |                |   |               |   |               |   |               |   |             |   |             |   |             |   |             |   |             |                          |                    |           |                                    |
| N  | 0 to 1300°C   |   |                   |          |   |                |   |   |               |   |                |   |               |   |               |   |               |   |             |   |             |   |             |   |             |   |             |                          |                    |           |                                    |
| R  | 0 to 1700°C   |   |                   |          |   |                |   |   |               |   |                |   |               |   |               |   |               |   |             |   |             |   |             |   |             |   |             |                          |                    |           |                                    |
| S  | 0 to 1700°C   |   |                   |          |   |                |   |   |               |   |                |   |               |   |               |   |               |   |             |   |             |   |             |   |             |   |             |                          |                    |           |                                    |
| B  | 0 to 1800°C   |   |                   |          |   |                |   |   |               |   |                |   |               |   |               |   |               |   |             |   |             |   |             |   |             |   |             |                          |                    |           |                                    |
| W  | 0 to 2300°C   | ±(0.1% of reading + 3°C)  |                   |          |   |                |   |   |               |   |                |   |               |   |               |   |               |   |             |   |             |   |             |   |             |   |             |                          |                    |           |                                    |
| Au7Fe <sup>3</sup>   | 0 to 300K   | 0 to 50K: ±4K<br>50 to 300K: ±2.5K  |                   |          |   |                |   |   |               |   |                |   |               |   |               |   |               |   |             |   |             |   |             |   |             |   |             |                          |                    |           |                                    |
| Frequency characteristics <sup>1</sup><br>(-3 dB point when a sine wave of amplitude ±3 div is applied)  | [Voltage measurement] DC to 40 kHz<br>[Temperature measurement] DC to 100 Hz  |   |                   |          |   |                |   |   |               |   |                |   |               |   |               |   |               |   |             |   |             |   |             |   |             |   |             |                          |                    |           |                                    |
| Maximum input voltage <sup>4</sup><br>(at a frequency of 1 kHz or less)  | Both temperature and voltage input:<br>42 V (DC + ACpeak) (as a value that meets the safety standard)<br>150 V (DC + ACpeak) (maximum allowable voltage, as a value that does not damage the instrument when applied)   |   |                   |          |   |                |   |   |               |   |                |   |               |   |               |   |               |   |             |   |             |   |             |   |             |   |             |                          |                    |           |                                    |
| Maximum rated voltage to earth <sup>5</sup><br>Between input and case<br>Between each input<br>(at a frequency of 1 kHz or less)   | Both temperature and voltage input:<br>42 V (DC+ACpeak) (CAT II, 30 Vrms)   |   |                   |          |   |                |   |   |               |   |                |   |               |   |               |   |               |   |             |   |             |   |             |   |             |   |             |                          |                    |           |                                    |
| Vertical resolution  | [Voltage measurement] During voltage input: 2400 LSB/div<br>[Temperature measurement] When measuring temperature: 0.1°C   |   |                   |          |   |                |   |   |               |   |                |   |               |   |               |   |               |   |             |   |             |   |             |   |             |   |             |                          |                    |           |                                    |
| -3 dB point when AC coupled<br>low frequency attenuation point   | [Voltage measurement] 0.5 Hz or less  |   |                   |          |   |                |   |   |               |   |                |   |               |   |               |   |               |   |             |   |             |   |             |   |             |   |             |                          |                    |           |                                    |
| Input connector  | Binding post  |   |                   |          |   |                |   |   |               |   |                |   |               |   |               |   |               |   |             |   |             |   |             |   |             |   |             |                          |                    |           |                                    |
| Input impedance  | Approx. 1 MΩ  |   |                   |          |   |                |   |   |               |   |                |   |               |   |               |   |               |   |             |   |             |   |             |   |             |   |             |                          |                    |           |                                    |
| Common mode rejection ratio  | [Voltage measurement] 80 dB (50/60 Hz) or more (typical value <sup>6</sup> )<br>[Temperature measurement] 120 dB or more (50/60 Hz, with 2-Hz filter ON, signal source resistance of 500 Ω or less) (typical value <sup>6</sup> )   |   |                   |          |   |                |   |   |               |   |                |   |               |   |               |   |               |   |             |   |             |   |             |   |             |   |             |                          |                    |           |                                    |
| Residual noise level<br>(Input section shorted)  | [Voltage measurement] ±100 μV or ±0.01 div, whichever is greater (typical value <sup>6</sup> )  |   |                   |          |   |                |   |   |               |   |                |   |               |   |               |   |               |   |             |   |             |   |             |   |             |   |             |                          |                    |           |                                    |
| A/D conversion resolution  | [Voltage measurement] 16 bits (2400 LSB/div)  |   |                   |          |   |                |   |   |               |   |                |   |               |   |               |   |               |   |             |   |             |   |             |   |             |   |             |                          |                    |           |                                    |
| Temperature coefficient  | [Voltage measurement] Zero point: ±(0.01% of 10 div)/°C (typical value <sup>6</sup> )<br>Gain: ±(0.02% of 10 div)/°C (typical value <sup>6</sup> )  |   |                   |          |   |                |   |   |               |   |                |   |               |   |               |   |               |   |             |   |             |   |             |   |             |   |             |                          |                    |           |                                    |

### 6.13 Module Specifications

| Item   | Specifications            |   |
|--|---------------------------|---|
| Reference junction compensation accuracy (when the input terminal temperature is balanced) | K, E, J, T, L, U, N:      | $\pm 1^{\circ}\text{C}$   |
|  | R, S, B, W:               | $\pm 1.5^{\circ}\text{C}$   |
|  | Au7Fe:                    | $\pm 1\text{K}$   |
| Bandwidth limit  | [Temperature measurement] | (Digital filter + analog filter)<br>Select from Full, 30 Hz, 8 Hz, and 2 Hz + 150 Hz secondary analog filter  |
|  | [Voltage measurement]     | Select from Full, AUTO, 4 kHz, 400 Hz, or 40 Hz.<br>Cutoff characteristics: $-12\text{ dB/OCT}$ (typical value, <sup>6</sup> setting other than AUTO) |
| Cutoff frequency (fc) when set to AUTO (701262 only)                                       |                           |   |
|  | <b>Sample Rate</b>        | <b>Cutoff Frequency (fc)</b>  |
|  | 100 kS/s or higher        | 40 kHz  |
|  | 100 kS/s to 50 S/s        | 40% of the sample rate  |
|  | 50 S/s or less            | 20 Hz   |

Cutoff characteristics for AUTO:  $-65\text{ dB at } 2 \times \text{fc}$  (typical value<sup>6</sup>)

Table of cutoff frequency characteristics of the anti-aliasing filter (AAF)

When the filter is set to Auto, the anti-aliasing filter and low-pass filter are automatically set according to the sample rate.

| Sample Rate     | AAF    | Low-Pass Filter |
|-----------------|--------|-----------------|
| 100 kS/s        | 40 kHz | OFF             |
| 50 kS/s         | 20 kHz | OFF             |
| 20 kS/s         | 8 kHz  | OFF             |
| 10 kS/s         | 4 kHz  | 4 kHz           |
| 5 kS/s          | 2 kHz  | 4 kHz           |
| 2 kS/s          | 800 Hz | 4 kHz           |
| 1 kS/s          | 400 Hz | 400 Hz          |
| 500 S/s         | 200 Hz | 400 Hz          |
| 200 S/s         | 80 Hz  | 400 Hz          |
| 100 S/s         | 40 Hz  | 40 Hz           |
| 50 S/s          | 20 Hz  | 40 Hz           |
| 20 S/s to 5 S/s | 20 Hz  | 40 Hz           |
| 2 S/s or less   | 20 Hz  | 40 Hz           |
| Ext sample      | 40 kHz | OFF             |

- Value measured under standard operating conditions.
- Does not include the reference junction temperature compensation accuracy.
- This module supports Au7Fe with 0.07% metal content with respect to gold.

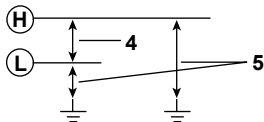

- Typical value represents a typical or average value. It is not strictly warranted.

## Temperature, High Precision Voltage Isolation Module (701265)

| Item   | Specifications   |  |                                    |  |
|--|--|--|------------------------------------|--|
| Standard operating conditions  | Temperature: 23 ±5°C<br>Humidity: 20 to 80% RH<br>After a 30-minute warm-up and after calibration      |  |                                    |  |
| Function   | Temperature (thermocouple) or voltage measurement (switchable)   |  |                                    |  |
| Effective measurement range  | [Voltage measurement]  | 20 div (display range: 10 div)   |                                    |  |
| Number of input channels   | 2  |  |                                    |  |
| Input coupling   | TC, DC, and GND<br>TC: Temperature (thermocouple) measurement<br>DC: Voltage measurement (DC coupling) |  |                                    |  |
| Data update rate   | 500 Hz   |  |                                    |  |
| Input format   | Isolated unbalanced  |  |                                    |  |
| Measurement range/accuracy <sup>1</sup>  | [Voltage measurement]  | Voltage sensitivity: 100 µV/div to 10 V/div (1-2-5 steps)<br>Voltage accuracy: ±(0.08% of 10 div + 2 µV)                                 |                                    |  |
| For the thermocouple standards, see the 701261 specifications.   | [Temperature measurement] <sup>2</sup>   |  |                                    |  |
|  |  | <b>Type</b>  | <b>Measurement Range</b>           | <b>Accuracy</b>  |
|  |  | K  | -200 to 1300°C                     | ±(0.1% of reading + 1.5°C)<br>Except ±(0.2% of reading + 1.5°C) for -200°C to 0°C          |
|  |  | E  | -200 to 800°C                      |  |
|  |  | J  | -200 to 1100°C                     |  |
|  |  | T  | -200 to 400°C                      |  |
|  |  | L  | -200 to 900°C                      |  |
|  |  | U  | -200 to 400°C                      |  |
|  |  | N  | 0 to 1300°C                        |  |
|  |  | R  | 0 to 1700°C                        | ±(0.1% of reading + 3°C)   |
|  |  | S  | 0 to 1700°C                        | Except, 0 to 200°C: ±8°C<br>200 to 800°C: ±5°C   |
|  |  | B  | 0 to 1800°C                        | ±(0.1% of reading + 2°C)<br>Except, 400 to 700°C: ±8°C<br>Effective range is 400 to 1800°C |
|  |  | W  | 0 to 2300°C                        | ±(0.1% of reading + 3°C)   |
|  | Au7Fe <sup>3</sup>   | 0 to 300K  | 0 to 50K: ±4K<br>50 to 300K: ±2.5K |  |
| Frequency characteristics <sup>1</sup><br>(-3 dB point when a sine wave of amplitude ±3 div is applied)                          | [Voltage measurement]  | DC to 100 Hz   |                                    |  |
|  | [Temperature measurement]  | DC to 100 Hz   |                                    |  |
| Maximum input voltage <sup>4</sup><br>(at a frequency of 1 kHz or less)  | Both temperature and voltage input: 42 V (DC+ACpeak)   |  |                                    |  |
| Maximum rated voltage to earth <sup>5</sup><br>Between input and case<br>Between each input<br>(at a frequency of 1 kHz or less) | Both temperature and voltage input: 42 V (DC+ACpeak) (CAT II, 30 Vrms)                                 |  |                                    |  |
| Vertical resolution  | [Voltage measurement]  | During voltage input: 2400 LSB/div   |                                    |  |
|  | [Temperature measurement]  | When measuring temperature: 0.1°C  |                                    |  |
| -3 dB point when AC coupled<br>low frequency attenuation point   | [Voltage measurement]  | 0.5 Hz or less   |                                    |  |
| Input connector  | Binding post   |  |                                    |  |
| Input impedance  | Approx. 1 MΩ   |  |                                    |  |
| Common mode rejection ratio  | [Voltage measurement]  | 80 dB (50/60 Hz) or more (typical value <sup>6</sup> )   |                                    |  |
|  | [Temperature measurement]  | 120 dB or more (50/60 Hz, with 2-Hz filter ON, signal source resistance of 500 Ω or less) (typical value <sup>6</sup> )                  |                                    |  |
| Residual noise level<br>(Input section shorted)  | [Voltage measurement]  | ±4 µV or ±0.01 div, whichever is greater (typical value <sup>6</sup> )   |                                    |  |
| A/D conversion resolution  | [Voltage measurement]  | 16 bits (2400 LSB/div)   |                                    |  |
| Temperature coefficient  | [Voltage measurement]  | Zero point: ±(0.01% of 10 div)/°C + 0.05µV/°C (typical value <sup>6</sup> )<br>Gain: ±(0.02% of 10 div)/°C (typical value <sup>6</sup> ) |                                    |  |
| Reference junction compensation accuracy (when the input terminal temperature is balanced)                                       | K, E, J, T, L, U, N:   | ±1°C   |                                    |  |
|  | R, S, B, W:  | ±1.5°C   |                                    |  |
|  | Au7Fe:   | ±1K  |                                    |  |
| Bandwidth limit (digital filter)   | Select from Full, 30 Hz, 8 Hz, and 2 Hz  |  |                                    |  |

### 6.13 Module Specifications

| Item               | Specifications  |
|--------------------|---|
| Input bias current | 20 nA or less<br>The zero point appears to be offset when the input is open due to the effects of bias current on this module. However, this is not a malfunction.<br>Connect the input to the object to be measured. |

- 1 Value measured under standard operating conditions.
- 2 Does not include the reference junction temperature compensation accuracy.
- 3 This module supports Au7Fe with 0.07% metal content with respect to gold.

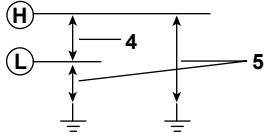

- 6 The typical value is a representative or standard value. It is not strictly warranted.

## Temperature, High Precision Voltage Isolation Module (low noise) (720266)

| Item   | Specifications   |  |                                    |  |
|--|--|--|------------------------------------|--|
| Standard operating conditions  | Temperature: 23 ±5°C<br>Humidity: 20 to 80% RH<br>After a 30-minute warm-up and after calibration      |  |                                    |  |
| Function   | Temperature (thermocouple) or voltage measurement (switchable)   |  |                                    |  |
| Effective measurement range  | [Voltage measurement]  | 20 div (display range: 10 div)   |                                    |  |
| Number of input channels   | 2  |  |                                    |  |
| Input coupling   | TC, DC, and GND<br>TC: Temperature (thermocouple) measurement<br>DC: Voltage measurement (DC coupling) |  |                                    |  |
| Data update rate   | 125 Hz   |  |                                    |  |
| Input format   | Isolated unbalanced  |  |                                    |  |
| Measurement range/accuracy <sup>1</sup>  | [Voltage measurement]  | Voltage sensitivity: 100 µV/div to 20 V/div (1-2-5 steps)<br>Voltage accuracy: ±(0.08% of 10 div + 2 µV)                                 |                                    |  |
| For the thermocouple standards, see the 701261 specifications.   | [Temperature measurement] <sup>2</sup>   |  |                                    |  |
|  |  | <b>Type</b>  | <b>Measurement Range</b>           | <b>Accuracy</b>  |
|  |  | K  | -200 to 1300°C                     | ±(0.1% of reading + 1.5°C)<br>Except ±(0.2% of reading + 1.5°C) for -200°C to 0°C          |
|  |  | E  | -200 to 800°C                      |  |
|  |  | J  | -200 to 1100°C                     |  |
|  |  | T  | -200 to 400°C                      |  |
|  |  | L  | -200 to 900°C                      |  |
|  |  | U  | -200 to 400°C                      |  |
|  |  | N  | 0 to 1300°C                        |  |
|  |  | R  | 0 to 1700°C                        | ±(0.1% of reading + 3°C)   |
|  |  | S  | 0 to 1700°C                        | Except, 0 to 200°C: ±8°C<br>200 to 800°C: ±5°C   |
|  |  | B  | 0 to 1800°C                        | ±(0.1% of reading + 2°C)<br>Except, 400 to 700°C: ±8°C<br>Effective range is 400 to 1800°C |
|  |  | W  | 0 to 2300°C                        | ±(0.1% of reading + 3°C)   |
|  | Au7Fe <sup>3</sup>   | 0 to 300K  | 0 to 50K: ±4K<br>50 to 300K: ±2.5K |  |
| Frequency characteristics <sup>1</sup><br>(-3 dB point when a sine wave of amplitude ±3 div is applied)                          | [Voltage measurement]  | DC to 15 Hz  |                                    |  |
|  | [Temperature measurement]  | DC to 15 Hz  |                                    |  |
| Maximum input voltage <sup>4</sup><br>(at a frequency of 1 kHz or less)  | Both temperature and voltage input: 42 V (DC+ACpeak)   |  |                                    |  |
| Maximum rated voltage to earth <sup>5</sup><br>Between input and case<br>Between each input<br>(at a frequency of 1 kHz or less) | Both temperature and voltage input: 42 V (DC+ACpeak) (CAT II, 30 Vrms)                                 |  |                                    |  |
| Vertical resolution  | [Voltage measurement]  | During voltage input: 2400 LSB/div   |                                    |  |
|  | [Temperature measurement]  | When measuring temperature: 0.1°C  |                                    |  |
| DC offset setting range  | ±5 div   |  |                                    |  |
| Input connector  | Binding post   |  |                                    |  |
| Input impedance  | Approx. 1 MΩ   |  |                                    |  |
| Common mode rejection ratio  | [Voltage measurement]  | 80 dB (50/60 Hz) or more (typical value <sup>6</sup> )   |                                    |  |
|  | [Temperature measurement]  | 120 dB or more (50/60 Hz, with 2-Hz filter ON, signal source resistance of 500 Ω or less) (typical value <sup>6</sup> )                  |                                    |  |
| Residual noise level<br>(Input section shorted)  | [Voltage measurement]  | ±4 µV or ±0.01 div, whichever is greater (typical value <sup>6</sup> )   |                                    |  |
| A/D conversion resolution  | [Voltage measurement]  | 16 bits (2400 LSB/div)   |                                    |  |
| Temperature coefficient  | [Voltage measurement]  | Zero point: ±(0.01% of 10 div)/°C + 0.05µV/°C (typical value <sup>6</sup> )<br>Gain: ±(0.02% of 10 div)/°C (typical value <sup>6</sup> ) |                                    |  |
| Reference junction compensation accuracy (when the input terminal temperature is balanced)                                       | K, E, J, T, L, U, N:<br>R, S, B, W:<br>Au7Fe:  | ±1°C<br>±1.5°C<br>±1K  |                                    |  |



### 6.13 Module Specifications

| Item               | Specifications  |
|--------------------|---|
| Bandwidth limit    | Line filter: 15 Hz<br>Cutoff characteristic: -6 dB/OCT (typical value <sup>6</sup> )<br>Digital filter: Select from Full, 8 Hz, 1 Hz, and 0.1 Hz<br>Cutoff characteristic: -24 dB/OCT                                 |
| Input bias current | 20 nA or less<br>The zero point appears to be offset when the input is open due to the effects of bias current on this module. However, this is not a malfunction.<br>Connect the input to the object to be measured. |

- 1 Value measured under standard operating conditions.
- 2 Does not include the reference junction temperature compensation accuracy.
- 3 This module supports Au7Fe with 0.07% metal content with respect to gold.

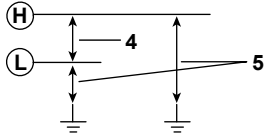

- 6 The typical value is a representative or standard value. It is not strictly warranted.

## Strain Module (NDIS) (701270)

| Item  | Specifications  |                        |                   |          |                        |           |                          |           |                          |           |                          |            |                            |            |                            |                        |                   |           |                          |          |                        |        |                    |          |                        |        |                    |         |                      |
|---|---|------------------------|-------------------|----------|------------------------|-----------|--------------------------|-----------|--------------------------|-----------|--------------------------|------------|----------------------------|------------|----------------------------|------------------------|-------------------|-----------|--------------------------|----------|------------------------|--------|--------------------|----------|------------------------|--------|--------------------|---------|----------------------|
| Standard operating conditions   | Temperature: 23 ±5°C<br>Humidity: 20 to 80% RH<br>After a 30-minute warm-up and after calibration and auto balance  |                        |                   |          |                        |           |                          |           |                          |           |                          |            |                            |            |                            |                        |                   |           |                          |          |                        |        |                    |          |                        |        |                    |         |                      |
| Effective measurement range   | -FS to +FS (set using upper and lower limits)   |                        |                   |          |                        |           |                          |           |                          |           |                          |            |                            |            |                            |                        |                   |           |                          |          |                        |        |                    |          |                        |        |                    |         |                      |
| Number of input channels  | 2   |                        |                   |          |                        |           |                          |           |                          |           |                          |            |                            |            |                            |                        |                   |           |                          |          |                        |        |                    |          |                        |        |                    |         |                      |
| Maximum sample rate   | 100 kS/s  |                        |                   |          |                        |           |                          |           |                          |           |                          |            |                            |            |                            |                        |                   |           |                          |          |                        |        |                    |          |                        |        |                    |         |                      |
| Input format  | DC bridge (auto balancing), balanced differential input, and isolated   |                        |                   |          |                        |           |                          |           |                          |           |                          |            |                            |            |                            |                        |                   |           |                          |          |                        |        |                    |          |                        |        |                    |         |                      |
| Auto balance type   | Electronic auto balance   |                        |                   |          |                        |           |                          |           |                          |           |                          |            |                            |            |                            |                        |                   |           |                          |          |                        |        |                    |          |                        |        |                    |         |                      |
| Auto balance range  | ±10000 μSTR (1 gauge method)  |                        |                   |          |                        |           |                          |           |                          |           |                          |            |                            |            |                            |                        |                   |           |                          |          |                        |        |                    |          |                        |        |                    |         |                      |
| Bridge voltage  | Select from 2 V, 5 V, and 10 V.   |                        |                   |          |                        |           |                          |           |                          |           |                          |            |                            |            |                            |                        |                   |           |                          |          |                        |        |                    |          |                        |        |                    |         |                      |
| Gauge resistance  | 120 Ω to 1000 Ω (bridge voltage: 2 V)<br>350 Ω to 1000 Ω (bridge voltage: 2 V, 5 V, and 10 V)   |                        |                   |          |                        |           |                          |           |                          |           |                          |            |                            |            |                            |                        |                   |           |                          |          |                        |        |                    |          |                        |        |                    |         |                      |
| Gauge factor  | 1.90 to 2.20 (set in 0.01 steps)  |                        |                   |          |                        |           |                          |           |                          |           |                          |            |                            |            |                            |                        |                   |           |                          |          |                        |        |                    |          |                        |        |                    |         |                      |
| Frequency characteristics <sup>1</sup><br>(-3 dB point when a sine wave of amplitude ±3 div is applied)             | DC to 20 kHz  |                        |                   |          |                        |           |                          |           |                          |           |                          |            |                            |            |                            |                        |                   |           |                          |          |                        |        |                    |          |                        |        |                    |         |                      |
| mV/V range support  | Supports the strain gauge transducer unit system.<br>mV/V range = 0.5×(μSTR range/1000)   |                        |                   |          |                        |           |                          |           |                          |           |                          |            |                            |            |                            |                        |                   |           |                          |          |                        |        |                    |          |                        |        |                    |         |                      |
| Measurement range (FS) and measurement range  | When using STR range <table border="1" data-bbox="571 853 1193 1055"> <thead> <tr> <th>Measurement Range (FS)</th> <th>Measurement Range</th> </tr> </thead> <tbody> <tr> <td>500 μSTR</td> <td>-500 μSTR to +500 μSTR</td> </tr> <tr> <td>1000 μSTR</td> <td>-1000 μSTR to +1000 μSTR</td> </tr> <tr> <td>2000 μSTR</td> <td>-2000 μSTR to +2000 μSTR</td> </tr> <tr> <td>5000 μSTR</td> <td>-5000 μSTR to +5000 μSTR</td> </tr> <tr> <td>10000 μSTR</td> <td>-10000 μSTR to +10000 μSTR</td> </tr> <tr> <td>20000 μSTR</td> <td>-20000 μSTR to +20000 μSTR</td> </tr> </tbody> </table><br>When using mV/V range <table border="1" data-bbox="571 1099 1193 1301"> <thead> <tr> <th>Measurement Range (FS)</th> <th>Measurement Range</th> </tr> </thead> <tbody> <tr> <td>0.25 mV/V</td> <td>-0.25 mV/V to +0.25 mV/V</td> </tr> <tr> <td>0.5 mV/V</td> <td>-0.5 mV/V to +0.5 mV/V</td> </tr> <tr> <td>1 mV/V</td> <td>-1 mV/V to +1 mV/V</td> </tr> <tr> <td>2.5 mV/V</td> <td>-2.5 mV/V to +2.5 mV/V</td> </tr> <tr> <td>5 mV/V</td> <td>-5 mV/V to +5 mV/V</td> </tr> <tr> <td>10 mV/V</td> <td>-10 mV/V to +10 mV/V</td> </tr> </tbody> </table> | Measurement Range (FS) | Measurement Range | 500 μSTR | -500 μSTR to +500 μSTR | 1000 μSTR | -1000 μSTR to +1000 μSTR | 2000 μSTR | -2000 μSTR to +2000 μSTR | 5000 μSTR | -5000 μSTR to +5000 μSTR | 10000 μSTR | -10000 μSTR to +10000 μSTR | 20000 μSTR | -20000 μSTR to +20000 μSTR | Measurement Range (FS) | Measurement Range | 0.25 mV/V | -0.25 mV/V to +0.25 mV/V | 0.5 mV/V | -0.5 mV/V to +0.5 mV/V | 1 mV/V | -1 mV/V to +1 mV/V | 2.5 mV/V | -2.5 mV/V to +2.5 mV/V | 5 mV/V | -5 mV/V to +5 mV/V | 10 mV/V | -10 mV/V to +10 mV/V |
| Measurement Range (FS)  | Measurement Range   |                        |                   |          |                        |           |                          |           |                          |           |                          |            |                            |            |                            |                        |                   |           |                          |          |                        |        |                    |          |                        |        |                    |         |                      |
| 500 μSTR  | -500 μSTR to +500 μSTR  |                        |                   |          |                        |           |                          |           |                          |           |                          |            |                            |            |                            |                        |                   |           |                          |          |                        |        |                    |          |                        |        |                    |         |                      |
| 1000 μSTR   | -1000 μSTR to +1000 μSTR  |                        |                   |          |                        |           |                          |           |                          |           |                          |            |                            |            |                            |                        |                   |           |                          |          |                        |        |                    |          |                        |        |                    |         |                      |
| 2000 μSTR   | -2000 μSTR to +2000 μSTR  |                        |                   |          |                        |           |                          |           |                          |           |                          |            |                            |            |                            |                        |                   |           |                          |          |                        |        |                    |          |                        |        |                    |         |                      |
| 5000 μSTR   | -5000 μSTR to +5000 μSTR  |                        |                   |          |                        |           |                          |           |                          |           |                          |            |                            |            |                            |                        |                   |           |                          |          |                        |        |                    |          |                        |        |                    |         |                      |
| 10000 μSTR  | -10000 μSTR to +10000 μSTR  |                        |                   |          |                        |           |                          |           |                          |           |                          |            |                            |            |                            |                        |                   |           |                          |          |                        |        |                    |          |                        |        |                    |         |                      |
| 20000 μSTR  | -20000 μSTR to +20000 μSTR  |                        |                   |          |                        |           |                          |           |                          |           |                          |            |                            |            |                            |                        |                   |           |                          |          |                        |        |                    |          |                        |        |                    |         |                      |
| Measurement Range (FS)  | Measurement Range   |                        |                   |          |                        |           |                          |           |                          |           |                          |            |                            |            |                            |                        |                   |           |                          |          |                        |        |                    |          |                        |        |                    |         |                      |
| 0.25 mV/V   | -0.25 mV/V to +0.25 mV/V  |                        |                   |          |                        |           |                          |           |                          |           |                          |            |                            |            |                            |                        |                   |           |                          |          |                        |        |                    |          |                        |        |                    |         |                      |
| 0.5 mV/V  | -0.5 mV/V to +0.5 mV/V  |                        |                   |          |                        |           |                          |           |                          |           |                          |            |                            |            |                            |                        |                   |           |                          |          |                        |        |                    |          |                        |        |                    |         |                      |
| 1 mV/V  | -1 mV/V to +1 mV/V  |                        |                   |          |                        |           |                          |           |                          |           |                          |            |                            |            |                            |                        |                   |           |                          |          |                        |        |                    |          |                        |        |                    |         |                      |
| 2.5 mV/V  | -2.5 mV/V to +2.5 mV/V  |                        |                   |          |                        |           |                          |           |                          |           |                          |            |                            |            |                            |                        |                   |           |                          |          |                        |        |                    |          |                        |        |                    |         |                      |
| 5 mV/V  | -5 mV/V to +5 mV/V  |                        |                   |          |                        |           |                          |           |                          |           |                          |            |                            |            |                            |                        |                   |           |                          |          |                        |        |                    |          |                        |        |                    |         |                      |
| 10 mV/V   | -10 mV/V to +10 mV/V  |                        |                   |          |                        |           |                          |           |                          |           |                          |            |                            |            |                            |                        |                   |           |                          |          |                        |        |                    |          |                        |        |                    |         |                      |
| DC accuracy <sup>1</sup>  | ±(0.5% of FS + 5 μSTR)  |                        |                   |          |                        |           |                          |           |                          |           |                          |            |                            |            |                            |                        |                   |           |                          |          |                        |        |                    |          |                        |        |                    |         |                      |
| Maximum input voltage<br>(at a frequency of 1 kHz or less)  | Between Input+ and Input-: 10 V (DC+ACpeak)   |                        |                   |          |                        |           |                          |           |                          |           |                          |            |                            |            |                            |                        |                   |           |                          |          |                        |        |                    |          |                        |        |                    |         |                      |
| Maximum rated voltage to earth<br>Between input and case<br>Between each input<br>(at a frequency of 1 kHz or less) | Between each terminal and earth ground: 42 V (DC+ACpeak) (CAT II, 30 Vrms)  |                        |                   |          |                        |           |                          |           |                          |           |                          |            |                            |            |                            |                        |                   |           |                          |          |                        |        |                    |          |                        |        |                    |         |                      |
| Input connector   | NDIS connector (Recommended by JSNDI (The Japanese Society for Non-destructive Inspection))   |                        |                   |          |                        |           |                          |           |                          |           |                          |            |                            |            |                            |                        |                   |           |                          |          |                        |        |                    |          |                        |        |                    |         |                      |
| Common mode rejection ratio   | 80 dB (50/60 Hz) or more (typical value <sup>2</sup> )  |                        |                   |          |                        |           |                          |           |                          |           |                          |            |                            |            |                            |                        |                   |           |                          |          |                        |        |                    |          |                        |        |                    |         |                      |
| A/D conversion resolution   | 16 bit (4800 LSB/div: Upper = +FS, Lower = -FS)   |                        |                   |          |                        |           |                          |           |                          |           |                          |            |                            |            |                            |                        |                   |           |                          |          |                        |        |                    |          |                        |        |                    |         |                      |
| Temperature coefficient   | Zero point: ±5 μSTR/°C (typical value <sup>2</sup> )<br>Gain: ±(0.02% of FS)/°C (typical value <sup>2</sup> )   |                        |                   |          |                        |           |                          |           |                          |           |                          |            |                            |            |                            |                        |                   |           |                          |          |                        |        |                    |          |                        |        |                    |         |                      |
| Bandwidth limit   | Select from Full, 1 kHz, 100 Hz, and 10 Hz<br>Cutoff characteristics: -12 dB/OCT (typical value <sup>2</sup> )  |                        |                   |          |                        |           |                          |           |                          |           |                          |            |                            |            |                            |                        |                   |           |                          |          |                        |        |                    |          |                        |        |                    |         |                      |
| Function  | mV/V support. Supports the strain gauge transducer unit system.   |                        |                   |          |                        |           |                          |           |                          |           |                          |            |                            |            |                            |                        |                   |           |                          |          |                        |        |                    |          |                        |        |                    |         |                      |
| Standard accessories  | NDIS connector (for external connection: PRC03-12A10-7M10.5 by Tajimi) A1002JC: 2 pieces  |                        |                   |          |                        |           |                          |           |                          |           |                          |            |                            |            |                            |                        |                   |           |                          |          |                        |        |                    |          |                        |        |                    |         |                      |
| Compatible accessories (sold separately)  | Recommended bridge head 701955 (NDIS 120 Ω, enhanced shield version, comes with a 5-m cable)<br>Recommended bridge head 701956 (NDIS 350 Ω, enhanced shield version, comes with a 5-m cable)  |                        |                   |          |                        |           |                          |           |                          |           |                          |            |                            |            |                            |                        |                   |           |                          |          |                        |        |                    |          |                        |        |                    |         |                      |

### 6.13 Module Specifications

| Item        | Specifications   |
|-------------|--|
| Precautions | <ul style="list-style-type: none"><li>• Highly sensitive measurements are made in the <math>\mu\text{V}</math> level in strain measurements. Therefore, take measures against noise at the strain sensor perimeter, bridge head, and cable wiring.</li><li>• Depending on the noise environment, an error may result in the balance. Check the influence before making measurements.</li><li>• The bridge head specified by YOKOGAWA has high noise resistance.</li><li>• Some of the strain gauge sensors and bridge heads made by other manufacturers do not have sensing wires connected. (No such problems with bridge heads made by YOKOGAWA.) If such products are used, an error may result in the bridge voltage leading to measurement errors, because sensing does not work effectively. Perform sensing as close to the bridge head as possible.</li><li>• The connector shell is connected to the case potential.</li><li>• When a bridge head (701955 or 701956) is used, the connector shell, cable shield, and the bridge head case are all connected to the case potential of the DL850E/DL850EV.</li><li>• When a bridge head (701955 or 701956) is used, the floating GND is connected to the bridge head case inside the bridge head.</li><li>• Be sure to execute balancing again when you change the range or the bridge voltage.</li></ul> |

- 1 Value measured under standard operating conditions.
- 2 The typical value is a representative or standard value. It is not strictly warranted.

#### Module front View

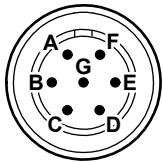

- A: Bridge+ (positive bridge voltage)**
- B: Input- (negative measurement signal)**
- C: Bridge- (negative bridge voltage)**
- D: Input+ (positive measurement signal)**
- E: Floating common**
- F: Sense+ (positive bridge voltage sensing)**
- G: Sense- (positive bridge voltage sensing)**

The connector shell is connected to the case potential.

## Strain Module (DSUB, Shunt-Cal) (701271)

| Item  | Specifications  |                        |                   |          |                        |           |                          |           |                          |           |                          |            |                            |            |                            |                        |                   |           |                          |          |                        |        |                    |          |                        |        |                    |         |                      |
|---|---|------------------------|-------------------|----------|------------------------|-----------|--------------------------|-----------|--------------------------|-----------|--------------------------|------------|----------------------------|------------|----------------------------|------------------------|-------------------|-----------|--------------------------|----------|------------------------|--------|--------------------|----------|------------------------|--------|--------------------|---------|----------------------|
| Standard operating conditions   | Temperature: 23 ±5°C<br>Humidity: 20 to 80% RH<br>After a 30-minute warm-up and after calibration and auto balance  |                        |                   |          |                        |           |                          |           |                          |           |                          |            |                            |            |                            |                        |                   |           |                          |          |                        |        |                    |          |                        |        |                    |         |                      |
| Effective measurement range   | -FS to +FS (set using upper and lower limits)   |                        |                   |          |                        |           |                          |           |                          |           |                          |            |                            |            |                            |                        |                   |           |                          |          |                        |        |                    |          |                        |        |                    |         |                      |
| Number of input channels  | 2   |                        |                   |          |                        |           |                          |           |                          |           |                          |            |                            |            |                            |                        |                   |           |                          |          |                        |        |                    |          |                        |        |                    |         |                      |
| Maximum sample rate   | 100 kS/s  |                        |                   |          |                        |           |                          |           |                          |           |                          |            |                            |            |                            |                        |                   |           |                          |          |                        |        |                    |          |                        |        |                    |         |                      |
| Input format  | DC bridge (auto balancing), balanced differential input, and isolated   |                        |                   |          |                        |           |                          |           |                          |           |                          |            |                            |            |                            |                        |                   |           |                          |          |                        |        |                    |          |                        |        |                    |         |                      |
| Auto balance type   | Electronic auto balance   |                        |                   |          |                        |           |                          |           |                          |           |                          |            |                            |            |                            |                        |                   |           |                          |          |                        |        |                    |          |                        |        |                    |         |                      |
| Auto balance range  | ±10000 µSTR (1 gauge method)  |                        |                   |          |                        |           |                          |           |                          |           |                          |            |                            |            |                            |                        |                   |           |                          |          |                        |        |                    |          |                        |        |                    |         |                      |
| Bridge voltage  | Select from 2 V, 5 V, and 10 V.   |                        |                   |          |                        |           |                          |           |                          |           |                          |            |                            |            |                            |                        |                   |           |                          |          |                        |        |                    |          |                        |        |                    |         |                      |
| Gauge resistance  | 120 Ω to 1000 Ω (bridge voltage: 2 V)<br>350 Ω to 1000 Ω (bridge voltage: 2 V, 5 V, and 10 V)   |                        |                   |          |                        |           |                          |           |                          |           |                          |            |                            |            |                            |                        |                   |           |                          |          |                        |        |                    |          |                        |        |                    |         |                      |
| Gauge factor  | 1.90 to 2.20 (set in 0.01 steps)  |                        |                   |          |                        |           |                          |           |                          |           |                          |            |                            |            |                            |                        |                   |           |                          |          |                        |        |                    |          |                        |        |                    |         |                      |
| Frequency characteristics <sup>1</sup><br>(-3 dB point when a sine wave of amplitude ±3 div is applied)             | DC to 20 kHz  |                        |                   |          |                        |           |                          |           |                          |           |                          |            |                            |            |                            |                        |                   |           |                          |          |                        |        |                    |          |                        |        |                    |         |                      |
| mV/V range support  | Supports the strain gauge transducer unit system.<br>mV/V range = 0.5×(µSTR range/1000)   |                        |                   |          |                        |           |                          |           |                          |           |                          |            |                            |            |                            |                        |                   |           |                          |          |                        |        |                    |          |                        |        |                    |         |                      |
| Measurement range (FS) and measurement range  | When using STR range <table border="1" data-bbox="582 846 1206 1048"> <thead> <tr> <th>Measurement Range (FS)</th> <th>Measurement Range</th> </tr> </thead> <tbody> <tr> <td>500 µSTR</td> <td>-500 µSTR to +500 µSTR</td> </tr> <tr> <td>1000 µSTR</td> <td>-1000 µSTR to +1000 µSTR</td> </tr> <tr> <td>2000 µSTR</td> <td>-2000 µSTR to +2000 µSTR</td> </tr> <tr> <td>5000 µSTR</td> <td>-5000 µSTR to +5000 µSTR</td> </tr> <tr> <td>10000 µSTR</td> <td>-10000 µSTR to +10000 µSTR</td> </tr> <tr> <td>20000 µSTR</td> <td>-20000 µSTR to +20000 µSTR</td> </tr> </tbody> </table><br>When using mV/V range <table border="1" data-bbox="582 1093 1206 1294"> <thead> <tr> <th>Measurement Range (FS)</th> <th>Measurement Range</th> </tr> </thead> <tbody> <tr> <td>0.25 mV/V</td> <td>-0.25 mV/V to +0.25 mV/V</td> </tr> <tr> <td>0.5 mV/V</td> <td>-0.5 mV/V to +0.5 mV/V</td> </tr> <tr> <td>1 mV/V</td> <td>-1 mV/V to +1 mV/V</td> </tr> <tr> <td>2.5 mV/V</td> <td>-2.5 mV/V to +2.5 mV/V</td> </tr> <tr> <td>5 mV/V</td> <td>-5 mV/V to +5 mV/V</td> </tr> <tr> <td>10 mV/V</td> <td>-10 mV/V to +10 mV/V</td> </tr> </tbody> </table> | Measurement Range (FS) | Measurement Range | 500 µSTR | -500 µSTR to +500 µSTR | 1000 µSTR | -1000 µSTR to +1000 µSTR | 2000 µSTR | -2000 µSTR to +2000 µSTR | 5000 µSTR | -5000 µSTR to +5000 µSTR | 10000 µSTR | -10000 µSTR to +10000 µSTR | 20000 µSTR | -20000 µSTR to +20000 µSTR | Measurement Range (FS) | Measurement Range | 0.25 mV/V | -0.25 mV/V to +0.25 mV/V | 0.5 mV/V | -0.5 mV/V to +0.5 mV/V | 1 mV/V | -1 mV/V to +1 mV/V | 2.5 mV/V | -2.5 mV/V to +2.5 mV/V | 5 mV/V | -5 mV/V to +5 mV/V | 10 mV/V | -10 mV/V to +10 mV/V |
| Measurement Range (FS)  | Measurement Range   |                        |                   |          |                        |           |                          |           |                          |           |                          |            |                            |            |                            |                        |                   |           |                          |          |                        |        |                    |          |                        |        |                    |         |                      |
| 500 µSTR  | -500 µSTR to +500 µSTR  |                        |                   |          |                        |           |                          |           |                          |           |                          |            |                            |            |                            |                        |                   |           |                          |          |                        |        |                    |          |                        |        |                    |         |                      |
| 1000 µSTR   | -1000 µSTR to +1000 µSTR  |                        |                   |          |                        |           |                          |           |                          |           |                          |            |                            |            |                            |                        |                   |           |                          |          |                        |        |                    |          |                        |        |                    |         |                      |
| 2000 µSTR   | -2000 µSTR to +2000 µSTR  |                        |                   |          |                        |           |                          |           |                          |           |                          |            |                            |            |                            |                        |                   |           |                          |          |                        |        |                    |          |                        |        |                    |         |                      |
| 5000 µSTR   | -5000 µSTR to +5000 µSTR  |                        |                   |          |                        |           |                          |           |                          |           |                          |            |                            |            |                            |                        |                   |           |                          |          |                        |        |                    |          |                        |        |                    |         |                      |
| 10000 µSTR  | -10000 µSTR to +10000 µSTR  |                        |                   |          |                        |           |                          |           |                          |           |                          |            |                            |            |                            |                        |                   |           |                          |          |                        |        |                    |          |                        |        |                    |         |                      |
| 20000 µSTR  | -20000 µSTR to +20000 µSTR  |                        |                   |          |                        |           |                          |           |                          |           |                          |            |                            |            |                            |                        |                   |           |                          |          |                        |        |                    |          |                        |        |                    |         |                      |
| Measurement Range (FS)  | Measurement Range   |                        |                   |          |                        |           |                          |           |                          |           |                          |            |                            |            |                            |                        |                   |           |                          |          |                        |        |                    |          |                        |        |                    |         |                      |
| 0.25 mV/V   | -0.25 mV/V to +0.25 mV/V  |                        |                   |          |                        |           |                          |           |                          |           |                          |            |                            |            |                            |                        |                   |           |                          |          |                        |        |                    |          |                        |        |                    |         |                      |
| 0.5 mV/V  | -0.5 mV/V to +0.5 mV/V  |                        |                   |          |                        |           |                          |           |                          |           |                          |            |                            |            |                            |                        |                   |           |                          |          |                        |        |                    |          |                        |        |                    |         |                      |
| 1 mV/V  | -1 mV/V to +1 mV/V  |                        |                   |          |                        |           |                          |           |                          |           |                          |            |                            |            |                            |                        |                   |           |                          |          |                        |        |                    |          |                        |        |                    |         |                      |
| 2.5 mV/V  | -2.5 mV/V to +2.5 mV/V  |                        |                   |          |                        |           |                          |           |                          |           |                          |            |                            |            |                            |                        |                   |           |                          |          |                        |        |                    |          |                        |        |                    |         |                      |
| 5 mV/V  | -5 mV/V to +5 mV/V  |                        |                   |          |                        |           |                          |           |                          |           |                          |            |                            |            |                            |                        |                   |           |                          |          |                        |        |                    |          |                        |        |                    |         |                      |
| 10 mV/V   | -10 mV/V to +10 mV/V  |                        |                   |          |                        |           |                          |           |                          |           |                          |            |                            |            |                            |                        |                   |           |                          |          |                        |        |                    |          |                        |        |                    |         |                      |
| DC accuracy <sup>1</sup>  | ±(0.5% of FS+5 µSTR)  |                        |                   |          |                        |           |                          |           |                          |           |                          |            |                            |            |                            |                        |                   |           |                          |          |                        |        |                    |          |                        |        |                    |         |                      |
| Maximum input voltage<br>(at a frequency of 1 kHz or less)  | Between Input+ and Input-: 10 V (DC+ACpeak)   |                        |                   |          |                        |           |                          |           |                          |           |                          |            |                            |            |                            |                        |                   |           |                          |          |                        |        |                    |          |                        |        |                    |         |                      |
| Maximum rated voltage to earth<br>Between input and case<br>Between each input<br>(at a frequency of 1 kHz or less) | Between each terminal and earth ground: 42 V (DC+ACpeak) (CAT II, 30 Vrms)  |                        |                   |          |                        |           |                          |           |                          |           |                          |            |                            |            |                            |                        |                   |           |                          |          |                        |        |                    |          |                        |        |                    |         |                      |
| Input connector   | 9-pin D-Sub connector (female)  |                        |                   |          |                        |           |                          |           |                          |           |                          |            |                            |            |                            |                        |                   |           |                          |          |                        |        |                    |          |                        |        |                    |         |                      |
| Common mode rejection ratio   | 80 dB (50/60 Hz) or more (typical value <sup>2</sup> )  |                        |                   |          |                        |           |                          |           |                          |           |                          |            |                            |            |                            |                        |                   |           |                          |          |                        |        |                    |          |                        |        |                    |         |                      |
| A/D conversion resolution   | 16 bit (4800 LSB/div: Upper = +FS, Lower = -FS)   |                        |                   |          |                        |           |                          |           |                          |           |                          |            |                            |            |                            |                        |                   |           |                          |          |                        |        |                    |          |                        |        |                    |         |                      |
| Temperature coefficient   | Zero point: ±5 µSTR/°C (typical value <sup>2</sup> )<br>Gain: ±(0.02% of FS)/°C (typical value <sup>2</sup> )   |                        |                   |          |                        |           |                          |           |                          |           |                          |            |                            |            |                            |                        |                   |           |                          |          |                        |        |                    |          |                        |        |                    |         |                      |
| Bandwidth limit   | Select from Full, 1 kHz, 100 Hz, and 10 Hz<br>Cutoff characteristics: -12 dB/OCT (typical value <sup>2</sup> )  |                        |                   |          |                        |           |                          |           |                          |           |                          |            |                            |            |                            |                        |                   |           |                          |          |                        |        |                    |          |                        |        |                    |         |                      |
| Function  | mV/V support. Supports the strain gauge transducer unit system.<br>Shunt calibration support. Built-in shunt calibration relay (1 gauge method).  |                        |                   |          |                        |           |                          |           |                          |           |                          |            |                            |            |                            |                        |                   |           |                          |          |                        |        |                    |          |                        |        |                    |         |                      |
| Standard accessories  | Connector shell set for soldering<br>A1520JD (9-pin D-Sub): 2 pieces, A1618JD (connector shell): 2 pieces   |                        |                   |          |                        |           |                          |           |                          |           |                          |            |                            |            |                            |                        |                   |           |                          |          |                        |        |                    |          |                        |        |                    |         |                      |
| Compatible accessories (sold separately)  | Recommended bridge head 701957 (D-Sub 120 Ω, shunt-Cal, enhanced shield version, comes with a 5-m cable)<br>Recommended bridge head 701958 (D-Sub 350 Ω, shunt-Cal, enhanced shield version, comes with a 5-m cable)  |                        |                   |          |                        |           |                          |           |                          |           |                          |            |                            |            |                            |                        |                   |           |                          |          |                        |        |                    |          |                        |        |                    |         |                      |

## 6.13 Module Specifications

| Item        | Specifications  |
|-------------|---|
| Precautions | <ul style="list-style-type: none"> <li>Highly sensitive measurements are made in the <math>\mu\text{V}</math> level in strain measurements. Therefore, take measures against noise at the strain sensor perimeter, bridge head, and cable wiring.</li> <li>Depending on the noise environment, an error may result in the balance. Check the influence before making measurements.</li> <li>The bridge head specified by YOKOGAWA has high noise resistance.</li> <li>When executing shunt calibration, be sure to calculate the shunt resistance in advance, and execute it in a range so that the measured values do not exceed the range even when the shunt resistance is ON.</li> <li>Some of the strain gauge sensors and bridge heads made by other manufacturers do not have sensing wires connected. (No such problems with bridge heads made by YOKOGAWA.) If such products are used, an error may result in the bridge voltage leading to measurement errors, because sensing does not work effectively. Perform sensing as close to the bridge head as possible. (There is no conversion cable for sensing on D-Sub connector types.)</li> <li>The connector shell is connected to the case potential.</li> <li>When a bridge head (701957 or 701958) is used, the connector shell, cable shield, and the bridge head case are all connected to the case potential of the DL850E/DL850EV.</li> <li>When a bridge head (701957 or 701958) is used, the floating GND is connected to the bridge head case inside the bridge head.</li> <li>Be sure to execute balancing again when you change the range or the bridge voltage.</li> </ul> |

1 Value measured under standard operating conditions.

2 The typical value is a representative or standard value. It is not strictly warranted.

### Module front View

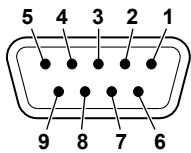

- 1: Floating common
- 2: Sense- (positive bridge voltage sensing)
- 3: Shuntcal- (negative shunt signal)
- 4: Shuntcal+ (positive shunt signal)
- 5: Sense+ (positive bridge voltage sensing)
- 6: Bridge- (negative bridge voltage)
- 7: Input- (negative measurement signal)
- 8: Input+ (positive measurement signal)
- 9: Bridge+ (positive bridge voltage)

## Acceleration/Voltage Module (with AAF) (701275)

| Item  | Specifications   |
|---|--|
| Standard operating conditions   | Temperature: 23 ±5°C<br>Humidity: 20 to 80% RH<br>After a 30-minute warm-up and after calibration  |
| Effective measurement range   | 20 div (display range: 10 div)   |
| Number of input channels  | 2  |
| Input coupling  | AC, DC, GND, ACCL (acceleration), and GND  |
| Maximum sample rate   | 100 kS/s   |
| Input format  | Isolated unbalanced  |
| Frequency characteristics <sup>1</sup><br>(-3 dB point when a sine wave of amplitude ±3 div is applied)             | Waveform observation mode: DC to 40 kHz<br>Acceleration measurement mode: 0.4 Hz to 40 kHz   |
| Voltage-axis sensitivity setting  | 5 mV/div to 10 V/div (1-2-5 steps) (when using 1:1 probe attenuation)<br>Acceleration (±5 V = ×1 range): ×0.1 to ×1 to ×100 (in 1-2-5 steps)   |
| Maximum input voltage<br>(at a frequency of 1 kHz or less)  | 42 V (DC+Acpeak) <sup>2</sup>  |
| Maximum rated voltage to earth<br>Between input and case<br>Between each input<br>(at a frequency of 1 kHz or less) | Working voltage of safety standard<br>42 V (DC+ACpeak) (CAT II, 30 Vrms) <sup>3</sup>  |
| Vertical (voltage) axis accuracy<br>DC accuracy <sup>1</sup>  | Waveform measurement mode DC accuracy: ±(0.25% of 10 div)<br>Acceleration measurement mode: ±(0.5% of 10 div) at 1 kHz   |
| Input connector   | BNC connector (metallic type)  |
| Input impedance   | 1 MΩ±1%, approx. 35 pF   |
| -3 dB point when AC coupled<br>low frequency attenuation point  | 0.4 Hz or less (0.04 Hz or less when using the 701940) (typical value <sup>4</sup> )   |
| Common mode rejection ratio   | 80 dB (50/60 Hz) or more (typical value <sup>4</sup> )   |
| Residual noise level<br>(Input section shorted)   | ±100 μV or ±0.01 div, whichever is greater (typical value <sup>4</sup> )   |
| A/D conversion resolution   | 16 bits (2400LSB/div)  |
| Temperature coefficient   | When in waveform measurement mode (excluding AUTO filter)<br>Zero point: ±(0.02% of 10 div)/°C (typical value <sup>4</sup> )<br>Gain: ±(0.02% of 10 div)/°C (typical value <sup>4</sup> )  |
| Bandwidth limit   | Select from Full, Auto, 4 kHz, 400 Hz, and 40 Hz<br>Cutoff characteristics: -12 dB/OCT (typical value <sup>4</sup> , excluding AUTO)<br>Cutoff frequency (fc) when set to AUTO<br>Sample rate of 100 kHz or higher: fc = 40 kHz<br>Sample rate of 100 Hz to 50 kHz: fc = 40% of the sampling rate<br>Sample rate of 50 Hz or less: fc = 20 Hz<br>Cutoff characteristics when set to AUTO: -65 dB at 2×fc (typical value <sup>4</sup> )                 |
| Probe attenuation setting   | Voltage probe 1:1, 10:1, 100:1, or 1000:1<br>Current probe 1 A:1 V, 10 A:1 V (for the 701932/701933), 100 A:1 V (for the 701930/701931)  |
| Compatible probes/cables  | Connection cable (for low voltage 1:1)<br>366926 (non-isolated type BNC-alligator clip × 2: For measuring low voltage less than or equal to 42 V (DC+ACpeak))<br>Voltage probe (10:1 passive probe)<br>701940 17 to 46 pF: For measuring 600 V (DC+ACpeak) or less<br>Current probe (power can be supplied from the DL850E/DL850EV)<br>701930 (150 A), 701931 (500 A), 701932 (30 A), 701933 (30 A)<br>Clamp-on probe<br>720930 (50 A), 720931 (200 A) |
| Sensor supply current (voltage)   | OFF/4 mA ± 10% (approx. 22 VDC)  |
| Applicable acceleration sensor  | Built-in amplifier type<br>Kistler Instrument Corporation: Piezotron, PCB Piezotronics Incorporated: ICP, ENDEVCO Corporation: ISOTRON, etc.   |

### 6.13 Module Specifications

| Item  | Specifications   |        |                 |
|---|--|--------|-----------------|
| Table of Cutoff Frequency Characteristics of the Anti-Aliasing Filter (AAF) | When the filter is set to Auto, the anti-aliasing filter and low-pass filter are automatically set according to the sample rate. |        |                 |
|   | Sample Rate  | AAF    | Low-pass filter |
|   | 100 kS/s   | 40 kHz | OFF             |
|   | 50 kS/s  | 20 kHz | OFF             |
|   | 20 kS/s  | 8 kHz  | OFF             |
|   | 10 kS/s  | 4 kHz  | 4 kHz           |
|   | 5 kS/s   | 2 kHz  | 4 kHz           |
|   | 2 kS/s   | 800 Hz | 4 kHz           |
|   | 1 kS/s   | 400 Hz | 400 Hz          |
|   | 500 S/s  | 200 Hz | 400 Hz          |
|   | 200 S/s  | 80 Hz  | 400 Hz          |
|   | 100 S/s  | 40 Hz  | 40 Hz           |
|   | 50 S/s   | 20 Hz  | 40 Hz           |
|   | 20 S/s to 5 S/s  | 20 Hz  | 40 Hz           |
|   | 2 S/s or less  | 20 Hz  | 40 Hz           |
|   | Ext sample   | 40 kHz | OFF             |

1 Value measured under standard operating conditions.

**Combined with the 10:1 passive probe (701940)**

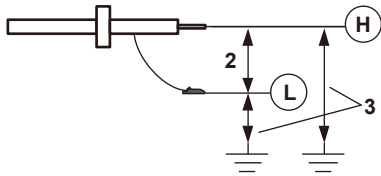

**Direct input (cable that does not comply with the safety standards)**

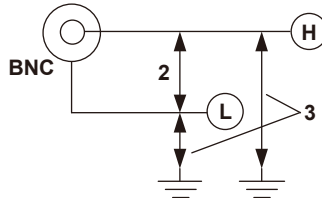

4 The typical value is a representative or standard value. It is not strictly warranted.

## Frequency Module (701281)

| Item   | Specifications  |
|--|---|
| Standard operating conditions  | Temperature: 23 ±5°C<br>Humidity: 20 to 80% RH<br>After a 30-minute warm-up and after calibration   |
| Measurement function   | Frequency, RPMs, RPSs, period, duty cycle, power supply frequency, pulse width, pulse integration, and velocity   |
| Effective measurement range  | 20 div (display range: 10 div)  |
| Number of input channels   | 2   |
| Data update rate   | 1 MHz (1 μs)  |
| Output delay time  | Approx. 3 μs  |
| Input format   | Isolated unbalanced   |
| Input connector  | BNC connector (isolated type)   |
| Maximum input voltage  | Combined with the 700929 (10:1), 702902 (10:1), or 701947 (100:1): <sup>2</sup><br>420 V (DC+ACpeak)<br>Combined with the (701901 + 701954) (1:1) or direct input (cable that does not comply with the safety standards): <sup>4</sup><br>42 V (DC+ACpeak)  |
| Maximum rated voltage to earth<br>Between input and case<br>Between each input | Working voltage of safety standard<br>Combined with the 700929 (10:1), 702902 (10:1), or 701947 (100:1): <sup>3</sup><br>300 Vrms (CAT II)<br>Combined with the (701901 + 701954) (1:1) or direct input (cable that does not comply with the safety standards): <sup>5</sup><br>42 V (DC+ACpeak) (CAT II, 30 Vrms)  |
| Withstand voltage  | 2300 Vrms for 2 seconds (across each terminal and earth) (60 Hz)  |
| Insulation resistance  | 500 VDC, 10 MΩ or more (across each input terminal and earth)   |
| Minimum measurement resolution   | 625 ps  |
| Measured data resolution   | 16 bits (2400 LSB/div)  |
| Measurement accuracy <sup>1</sup>  | <ul style="list-style-type: none"> <li>• <b>When in frequency, RPM, RPS, or velocity measurement mode<sup>6</sup></b><br/>Measurement accuracy is specified according to the measurement range and input frequency<br/>[Definition of measurement accuracy]<br/>±(0.05% of 10 div + accuracy dependent on the input frequency)<br/>[Accuracy dependent on the input frequency]<br/>When input frequency is 2 kHz or less: 0.05% of the input frequency + 0.001 Hz<br/>Input frequency of 2 kHz to 50 kHz: 0.05% of the input frequency<br/>Input frequency of 50 kHz to 100 kHz: 0.1% of the input frequency<br/>Input frequency of 100 kHz to 200 kHz: 0.2% of the input frequency<br/>Input frequency of 200 kHz to higher: 0.5% of the input frequency</li> <li>• <b>When in power supply frequency mode<sup>7</sup></b><br/>When the center frequency is 50/60 Hz: ±0.03 Hz (0.01 Hz resolution)<br/>When the center frequency is 400 Hz: ±0.3 Hz (0.01 Hz resolution)<br/>(Input set to AC100 V or AC200 V with sine wave input)</li> <li>• <b>When in period measurement mode<sup>6</sup></b><br/>Measurement accuracy is specified according to the measurement range and input period<br/>[Definition of measurement accuracy]<br/>±(0.05% of 10 div + accuracy dependent on the input period)<br/>[Accuracy dependent on the input period]<br/>Input period of 500 μs or greater: 0.05% of the input period<br/>Input period of 20 μs to 500 μs: 0.1% of the input period + 0.1 μs<br/>Input period of 10 μs to 20 μs: 0.2% of the input period + 0.1 μs<br/>Input period of 10 μs or less: 0.5% of the input period + 0.1 μs</li> <li>• <b>When in duty cycle measurement mode<sup>8</sup></b><br/>Dependent on the input frequency<br/>Input frequency of 50 kHz or less: ±0.1%<br/>Input frequency of 50 kHz to 100 kHz: ±0.2%<br/>Input frequency of 100 kHz to 200 kHz: ±0.5%<br/>Input frequency of 200 kHz to 500 kHz: ±1.0%</li> </ul> |



### 6.13 Module Specifications

| Item                                      | Specifications   |
|---|--|
|   | <ul style="list-style-type: none"> <li>• <b>When in pulse width measurement mode<sup>8</sup></b><br/>                     Measurement accuracy is specified according to the measurement range and input pulse width<br/>                     [Definition of measurement accuracy]<br/> <math>\pm(0.05\%</math> of 10 div + accuracy dependent on the input pulse width)<br/>                     [Accuracy dependent on the input pulse width]<br/>                     Input pulse width of 500 <math>\mu</math>s or greater: 0.05% of the input pulse width<br/>                     Input pulse width of 20 <math>\mu</math>s to 500 <math>\mu</math>s: 0.1% of the input pulse width + 0.1 <math>\mu</math>s<br/>                     Input pulse width of 10 <math>\mu</math>s to 20 <math>\mu</math>s: 0.2% of the input pulse width + 0.1 <math>\mu</math>s<br/>                     Input pulse width of 10 <math>\mu</math>s or less: 0.5% of the input pulse width + 0.1 <math>\mu</math>s</li> </ul> |
| Input voltage range ( $\pm$ FS)           | When using 1:1 probe attenuation: $\pm 1$ V, $\pm 2$ V, $\pm 5$ V, $\pm 10$ V, $\pm 20$ V, $\pm 50$ V ( $\pm$ FS)  |
| Input impedance                           | 1 M $\Omega$ $\pm$ 1 approx. 35 pF<br>Pull-up function: 10 k $\Omega$ , approx. 5 V (pull-up can be turned ON only when the input is set to Pull-up 5 V)   |
| Input coupling settings                   | AC, DC   |
| Probe attenuation setting                 | 10:1, 1:1  |
| Minimum voltage width for pulse detection | 200 mV <sub>P-P</sub>  |
| Bandwidth limit                           | Select from Full, 100 kHz, 10 kHz, 1 kHz, and 100 Hz<br>Cutoff characteristics: -12 dB/OCT (typical value <sup>9</sup> )   |
| Threshold                                 | Set within the FS of the voltage range. Set in units of 1% of the FS.  |
| Hysteresis                                | Select $\pm 1\%$ , $\pm 2.5\%$ , or $\pm 5\%$ of the FS of the voltage range   |
| Preset function                           | Logic (5 V/3 V/12 V/24 V), electromagnetic pickup, zero crossing, pull-up, AC100 V, AC200 V, and user-defined  |
| Slope selection                           | Select rising or falling   |
| Lower -3 dB point when AC coupled         | 0.5 Hz or less (0.05 Hz or less when using the 700929 or 702902, 0.005 Hz or less when using the 701947) (typical value <sup>9</sup> )   |
| Chatter elimination function              | OFF or 1 to 1000 ms (1 ms resolution)<br>Eliminates the chatter that occurs such when the contact input is turned ON/OFF.<br>Can discard the signal changes over the specified interval.   |
| Input status indication function          | Input status indication through the LEDs of each channel function<br>When in operation: Illuminates in green when pulse input is detected<br>When overdriven: Illuminates in red when the input voltage exceeds the range  |
| Compatible probes/cables                  | Connection cable (1:1): Recommended 1<br>366926<br>Voltage probe: Recommended 2<br>700929 (10:1 safety probe), 20 to 45 pF<br>702902 (10:1 safety probe), 25 to 40 pF<br>701947 (100:1 probe), 15 to 45 pF   |

1 Value measured under standard operating conditions.

**Combined with the 700929, 702902, or 701947**

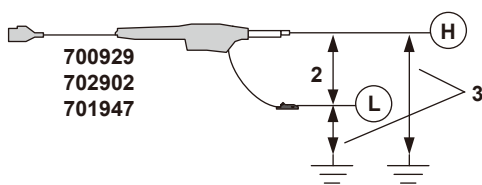

**Combined with the (701901 + 701954) or direct input (cable that does not comply with the safety standards)**

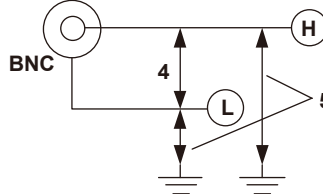

6 Input waveform of 1 Vpp, rectangular wave, rise/fall time within 1  $\mu$ s (input range:  $\pm 10$  V, bandwidth limit: Full, and hysteresis:  $\pm 1\%$ )

7 Input waveform of 90 Vrms, sine wave (input range: AC100 V, bandwidth limit 100 kHz, and hysteresis:  $\pm 1\%$ )

8 Input waveform of 1 Vpp, rectangular wave, rise/fall time within 5 ns (input range:  $\pm 10$  V, bandwidth limit: Full, and hysteresis:  $\pm 1\%$ )

9 Typical value represents a typical or average value. It is not strictly warranted.

## Specifications by Measurement Modes

| Item                                 | Specifications   |
|--------------------------------------|--|
| Frequency                            |  |
| Measurable frequency range           | 0.01 Hz to 500 kHz   |
| Selectable vertical axis sensitivity | 0.1 Hz/div to 100 kHz/div (1-2-5 steps)  |
| Minimum resolution                   | 0.001 Hz   |
| RPMs                                 |  |
| Measurable RPMs range                | 0.01 rpm to 100000 rpm (where the input frequency is DC to 500 kHz).   |
| Selectable vertical axis sensitivity | 0.1 rpm/div to 10 krpm/div (1-2-5 steps)   |
| Computing method                     | Computed from the frequency based on the number of pulses per rotation<br>RPMs = Frequency/(pulse/rotate value) × 60   |
| Selectable pulse/rotate range        | 1 to 99999   |
| RPSs                                 |  |
| Measurable RPSs range                | 0.001 rps to 2000 rps (where the input frequency is DC to 500 kHz).  |
| Selectable vertical axis sensitivity | 0.01 rps/div to 200 rps/div (1-2-5 steps)  |
| Computing method                     | Computed from the frequency based on the number of pulses per rotation<br>RPSs = Frequency/(pulse/rotate value)  |
| Selectable pulse/rotate range        | 1 to 99999   |
| Period                               |  |
| Measurable period range              | 2 μs to 50 s (where the minimum pulse width is 1 μs)   |
| Selectable vertical axis sensitivity | 10 μs/div to 5 s/div (1-2-5 steps)   |
| Minimum resolution                   | 0.1 μs   |
| Duty cycle                           |  |
| Measurable duty cycle range          | 0 to 100%  |
| Selectable vertical axis sensitivity | 1 %/div to 20 %/div (1-2-5 steps)  |
| Measurable frequency range           | 0.1 Hz to 500 kHz  |
| Measurement pulse selection          | Select positive or negative pulse  |
| Minimum resolution                   | 0.1 μs   |
| Power supply frequency               |  |
| Measurable frequency range           | 30 Hz to 70 Hz (when the center frequency is 50 Hz), 40 Hz to 80 Hz (when the center frequency is 60 Hz), 380 Hz to 420 Hz (when the center frequency is 400 Hz) |
| Selectable vertical axis sensitivity | 0.1 Hz/div to 2 Hz/div (0.01 Hz resolution)  |
| Center frequency setting             | Select 50 Hz, 60 Hz, or 400 Hz   |
| Minimum resolution                   | 0.01 Hz  |
| Pulse width                          |  |
| Measurable pulse width               | 1 μs to 50 s (where the input frequency is up to 500 kHz)  |
| Selectable vertical axis sensitivity | 10 μs/div to 5 s/div (1-2-5 steps)   |
| Measurement pulse selection          | Select positive or negative pulse  |
| Minimum resolution                   | 0.1 μs   |
| Pulse integration                    |  |
| Maximum pulse count                  | 2×10 <sup>9</sup> pulses   |
| Selectable vertical axis sensitivity | 500.0E+18 value/div to 10.00E-21 value/div (1-2-5 range: total of 123 ranges)  |
| Frequency measuring range            | 0.1 Hz to 500 kHz (where the minimum pulse width is 1 μs)  |
| Computation function                 | Set the physical amount per pulse and display by converting the values into physical values such as distance and flow rate.                                      |
| Selectable Unit/Pulse range          | -9.9999E+30 to +9.9999E+30   |
| Counter reset                        | Manual reset and over-limit reset  |
| Velocity                             |  |
| Selectable vertical axis sensitivity | 500.0E+18 value/div to 10.00E-21 value/div (1-2-5 range: total of 123 ranges)  |
| Computing method                     | Set the amount of displacement per pulse and compute the velocity from the frequency<br>Automatic unit time conversion of s, min, and hour.                      |
| Selectable Distance/Pulse range      | -9.9999E+30 to +9.9999E+30   |

## 6.13 Module Specifications

### Functional Specifications

| Item                    | Specifications   |
|-------------------------|--|
| Deceleration prediction | Computes the deceleration condition in realtime when the pulse input is cut off.<br>Can be specified when measuring the frequency, RPMs, RPSs, period, and velocity  |
| Stop prediction         | Sets the frequency to 0 after a certain time elapses after the pulse input is cut off.<br>Stop interval setting: Set in the range of 1.5 to 10 times (10 settings) the period of the pulse measured last<br>Can be specified when measuring the frequency, RPMs, RPSs, period, and velocity  |
| Smoothing               | Computes the moving average of the measured data using the specified time<br>Specified time: 0.1 to 1000 ms (0.1 ms resolution)<br>Can be specified on all measurement parameters  |
| Pulse average           | Performs frequency measurement per specified number of pulses. When fluctuation exists periodically in the pulse interval, the fluctuation can be eliminated.<br>Specified number of pulses: 1 to 4096<br>Can be specified when measuring the frequency, RPMs, RPSs, power supply frequency, period, pulse integration, and velocity   |
| Offset function         | Observe fluctuation with respect to the offset frequency<br>Offset range: Can be set up to 1000 times the maximum div value <ul style="list-style-type: none"><li>• Frequency: 0 Hz to 500 kHz</li><li>• RPMs: 0 rpm to 50 krpm</li><li>• RPSs: 0 rps to 1000 rps</li><li>• Period: 0 s to 50 s</li><li>• Duty cycle: 0% to 100%</li><li>• Pulse width: 0 s to 50 s</li><li>• Pulse integration: <math>-1.0000 \times 10^{22}</math> to <math>1.0000 \times 10^{22}</math></li><li>• Velocity: <math>-1.0000 \times 10^{22}</math> to <math>1.0000 \times 10^{22}</math></li></ul> |

## Frequency Module (720281)

| Item   | Specifications  |
|--|---|
| Standard operating conditions  | Temperature: 23 ±5°C<br>Humidity: 20 to 80% RH<br>After a 30-minute warm-up and after calibration   |
| Measurement function   | Frequency, RPMs, RPSs, period, duty cycle, power supply frequency, pulse width, pulse integration, and velocity   |
| Effective measurement range  | 20 div (display range: 10 div)  |
| Number of input channels   | 2   |
| Data update rate   | 1 MHz (1 μs)  |
| Output delay time  | Approx. 3 μs  |
| Input format   | Isolated unbalanced   |
| Input connector  | BNC connector (isolated type)   |
| Maximum input voltage  | Combined with the 700929 (10:1), 702902 (10:1), or 701947 (100:1): <sup>2</sup><br>420 V (DC+ACpeak)<br>Combined with the (701901 + 701954) (1:1) or direct input (cable that does not comply with the safety standards): <sup>4</sup><br>42 V (DC+ACpeak)  |
| Maximum rated voltage to earth<br>Between input and case<br>Between each input | Working voltage of safety standard<br>Combined with the 700929 (10:1), 702902 (10:1), or 701947 (100:1): <sup>3</sup><br>400 Vrms (CAT II)<br>Combined with the (701901 + 701954) (1:1) or direct input (cable that does not comply with the safety standards): <sup>5</sup><br>42 V (DC+ACpeak) (CAT II, 30 Vrms)  |
| Withstand voltage  | 2300 VACrms for 2 seconds (across each terminal and earth) (60 Hz)  |
| Insulation resistance  | 500 VDC, 10 MΩ or more (across each input terminal and earth)   |
| Minimum measurement resolution   | 625 ps  |
| Measured data resolution   | 16 bits (2400 LSB/div)  |
| Measurement accuracy <sup>1</sup>  | <ul style="list-style-type: none"> <li>• <b>When in frequency, RPM, RPS, or velocity measurement mode<sup>6</sup></b><br/>Measurement accuracy is specified according to the measurement range and input frequency<br/>[Definition of measurement accuracy]<br/>±(0.05% of 10 div + accuracy dependent on the input frequency)<br/>[Accuracy dependent on the input frequency]<br/>When input frequency is 2 kHz or less: 0.05% of the input frequency + 0.001 Hz<br/>Input frequency of 2 kHz to 50 kHz: 0.05% of the input frequency<br/>Input frequency of 50 kHz to 100 kHz: 0.1% of the input frequency<br/>Input frequency of 100 kHz to 200 kHz: 0.2% of the input frequency<br/>Input frequency of 200 kHz to higher: 0.5% of the input frequency</li> <li>• <b>When in power supply frequency mode<sup>7</sup></b><br/>When the center frequency is 50/60 Hz: ±0.03 Hz (0.01 Hz resolution)<br/>When the center frequency is 400 Hz: ±0.3 Hz (0.01 Hz resolution)<br/>(Input set to AC100 V or AC200 V with sine wave input)</li> <li>• <b>When in period measurement mode<sup>6</sup></b><br/>Measurement accuracy is specified according to the measurement range and input period<br/>[Definition of measurement accuracy]<br/>±(0.05% of 10 div + accuracy dependent on the input period)<br/>[Accuracy dependent on the input period]<br/>Input period of 500 μs or greater: 0.05% of the input period<br/>Input period of 20 μs to 500 μs: 0.1% of the input period + 0.1 μs<br/>Input period of 10 μs to 20 μs: 0.2% of the input period + 0.1 μs<br/>Input period of 10 μs or less: 0.5% of the input period + 0.1 μs</li> <li>• <b>When in duty cycle measurement mode<sup>8</sup></b><br/>Dependent on the input frequency<br/>Input frequency of 50 kHz or less: ±0.1%<br/>Input frequency of 50 kHz to 100 kHz: ±0.2%<br/>Input frequency of 100 kHz to 200 kHz: ±0.5%<br/>Input frequency of 200 kHz to 500 kHz: ±1.0%</li> </ul> |

### 6.13 Module Specifications

| Item                                      | Specifications   |
|---|--|
|   | <ul style="list-style-type: none"> <li>• <b>When in pulse width measurement mode<sup>8</sup></b><br/>                     Measurement accuracy is specified according to the measurement range and input pulse width<br/>                     [Definition of measurement accuracy]<br/> <math>\pm(0.05\% \text{ of } 10 \text{ div} + \text{accuracy dependent on the input pulse width})</math><br/>                     [Accuracy dependent on the input pulse width]<br/>                     Input pulse width of 500 <math>\mu\text{s}</math> or greater: 0.05% of the input pulse width<br/>                     Input pulse width of 20 <math>\mu\text{s}</math> to 500 <math>\mu\text{s}</math>: 0.1% of the input pulse width + 0.1 <math>\mu\text{s}</math><br/>                     Input pulse width of 10 <math>\mu\text{s}</math> to 20 <math>\mu\text{s}</math>: 0.2% of the input pulse width + 0.1 <math>\mu\text{s}</math><br/>                     Input pulse width of 10 <math>\mu\text{s}</math> or less: 0.5% of the input pulse width + 0.1 <math>\mu\text{s}</math> </li> </ul> |
| Input voltage range ( $\pm\text{FS}$ )    | When using 10:1 probe attenuation (combined with the 700929): $\pm 10 \text{ V}, \pm 20 \text{ V}, \pm 50 \text{ V}, \pm 100 \text{ V}, \pm 200 \text{ V}, \pm 500 \text{ V}$ ( $\pm\text{FS}$ )   |
| Input impedance                           | 1 M $\Omega$ $\pm$ 1 approx. 35 pF<br>Pull-up function: 10 k $\Omega$ , approx. 5 V (pull-up can be turned ON only when the input is set to Pull-up 5 V)   |
| Input coupling settings                   | AC, DC   |
| Probe attenuation setting                 | 10:1, 1:1  |
| Minimum voltage width for pulse detection | 200 mV <sub>P-P</sub>  |
| Bandwidth limit                           | Select from Full, 100 kHz, 10 kHz, 1 kHz, and 100 Hz<br>Cutoff characteristics: -12 dB/OCT (typical value <sup>9</sup> )   |
| Threshold                                 | Set within the FS of the voltage range. Set in units of 1% of the FS.  |
| Hysteresis                                | Select $\pm 1\%$ , $\pm 2.5\%$ , or $\pm 5\%$ of the FS of the voltage range   |
| Preset function                           | Logic (5 V/3 V/12 V/24 V), electromagnetic pickup, zero crossing, pull-up, AC100 V, AC200 V, and user-defined  |
| Slope selection                           | Select rising or falling   |
| Lower -3 dB point when AC coupled         | 0.5 Hz or less (0.05 Hz or less when using the 700929 or 702902, 0.005 Hz or less when using the 701947) (typical value <sup>9</sup> )   |
| Chatter elimination function              | OFF or 1 to 1000 ms (1 ms resolution)<br>Eliminates the chatter that occurs such when the contact input is turned ON/OFF.<br>Can discard the signal changes over the specified interval.   |
| Input status indication function          | Input status indication through the LEDs of each channel function<br>When in operation: Illuminates in green when pulse input is detected<br>When overdriven: Illuminates in red when the input voltage exceeds the range  |
| Compatible probes/cables                  | Connection cable (1:1): Recommended 1<br>366926<br>Voltage probe: Recommended 2<br>700929 (10:1 safety probe), 20 to 45 pF<br>702902 (10:1 safety probe), 25 to 40 pF<br>701947 (100:1 probe), 15 to 45 pF   |

1 Value measured under standard operating conditions.

**Combined with the 700929, 702902, or 701947**

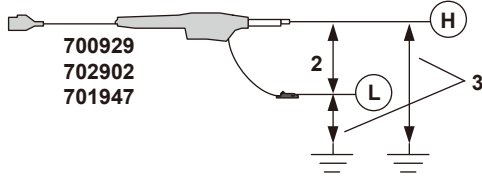

**Combined with the (701901 + 701954) or direct input (cable that does not comply with the safety standards)**

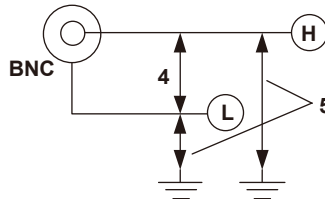

6 Input waveform of 1 V<sub>pp</sub>, rectangular wave, rise/fall time within 1  $\mu\text{s}$  (input range:  $\pm 10 \text{ V}$ , bandwidth limit: Full, and hysteresis:  $\pm 1\%$ )

7 Input waveform of 90 V<sub>rms</sub>, sine wave (input range: AC100 V, bandwidth limit 100 kHz, and hysteresis:  $\pm 1\%$ )

8 Input waveform of 1 V<sub>pp</sub>, rectangular wave, rise/fall time within 5 ns (input range:  $\pm 10 \text{ V}$ , bandwidth limit: Full, and hysteresis:  $\pm 1\%$ )

9 Typical value represents a typical or average value. It is not strictly warranted.

## Specifications by Measurement Modes

| Item                                 | Specifications   |
|--------------------------------------|--|
| Frequency                            |  |
| Measurable frequency range           | 0.01 Hz to 500 kHz   |
| Selectable vertical axis sensitivity | 0.1 Hz/div to 100 kHz/div (1-2-5 steps)  |
| Minimum resolution                   | 0.001 Hz   |
| RPMs                                 |  |
| Measurable RPMs range                | 0.01 rpm to 100000 rpm (where the input frequency is DC to 500 kHz).   |
| Selectable vertical axis sensitivity | 0.1 rpm/div to 10 krpm/div (1-2-5 steps)   |
| Computing method                     | Computed from the frequency based on the number of pulses per rotation<br>RPMs = Frequency/(pulse/rotate value) × 60   |
| Selectable pulse/rotate range        | 1 to 99999   |
| RPSs                                 |  |
| Measurable RPSs range                | 0.001 rps to 2000 rps (where the input frequency is DC to 500 kHz).  |
| Selectable vertical axis sensitivity | 0.01 rps/div to 200 rps/div (1-2-5 steps)  |
| Computing method                     | Computed from the frequency based on the number of pulses per rotation<br>RPSs = Frequency/(pulse/rotate value)  |
| Selectable pulse/rotate range        | 1 to 99999   |
| Period                               |  |
| Measurable period range              | 2 μs to 50 s (where the minimum pulse width is 1 μs)   |
| Selectable vertical axis sensitivity | 10 μs/div to 5 s/div (1-2-5 steps)   |
| Minimum resolution                   | 0.1 μs   |
| Duty cycle                           |  |
| Measurable duty cycle range          | 0 to 100%  |
| Selectable vertical axis sensitivity | 1 %/div to 20 %/div (1-2-5 steps)  |
| Measurable frequency range           | 0.1 Hz to 500 kHz  |
| Measurement pulse selection          | Select positive or negative pulse  |
| Minimum resolution                   | 0.1 μs   |
| Power supply frequency               |  |
| Measurable frequency range           | 30 Hz to 70 Hz (when the center frequency is 50 Hz), 40 Hz to 80 Hz (when the center frequency is 60 Hz), 380 Hz to 420 Hz (when the center frequency is 400 Hz) |
| Selectable vertical axis sensitivity | 0.1 Hz/div to 2 Hz/div (0.01 Hz resolution)  |
| Center frequency setting             | Select 50 Hz, 60 Hz, or 400 Hz   |
| Minimum resolution                   | 0.01 Hz  |
| Pulse width                          |  |
| Measurable pulse width               | 1 μs to 50 s (where the input frequency is up to 500 kHz)  |
| Selectable vertical axis sensitivity | 10 μs/div to 5 s/div (1-2-5 steps)   |
| Measurement pulse selection          | Select positive or negative pulse  |
| Minimum resolution                   | 0.1 μs   |
| Pulse integration                    |  |
| Maximum pulse count                  | 2×10 <sup>9</sup> pulses   |
| Selectable vertical axis sensitivity | 500.0E+18 value/div to 10.00E-21 value/div (1-2-5 range: total of 123 ranges)  |
| Frequency measuring range            | 0.1 Hz to 500 kHz (where the minimum pulse width is 1 μs)  |
| Computation function                 | Set the physical amount per pulse and display by converting the values into physical values such as distance and flow rate.                                      |
| Selectable Unit/Pulse range          | -9.9999E+30 to +9.9999E+30   |
| Counter reset                        | Manual reset and over-limit reset  |
| Velocity                             |  |
| Selectable vertical axis sensitivity | 500.0E+18 value/div to 10.00E-21 value/div (1-2-5 range: total of 123 ranges)  |
| Computing method                     | Set the amount of displacement per pulse and compute the velocity from the frequency<br>Automatic unit time conversion of s, min, and hour.                      |
| Selectable Distance/Pulse range      | -9.9999E+30 to +9.9999E+30   |

## 6.13 Module Specifications

### Functional Specifications

| Item                    | Specifications   |
|-------------------------|--|
| Deceleration prediction | Computes the deceleration condition in realtime when the pulse input is cut off.<br>Can be specified when measuring the frequency, RPMs, RPSs, period, and velocity  |
| Stop prediction         | Sets the frequency to 0 after a certain time elapses after the pulse input is cut off.<br>Stop interval setting: Set in the range of 1.5 to 10 times (10 settings) the period of the pulse measured last<br>Can be specified when measuring the frequency, RPMs, RPSs, period, and velocity  |
| Smoothing               | Computes the moving average of the measured data using the specified time<br>Specified time: 0.1 to 1000 ms (0.1 ms resolution)<br>Can be specified on all measurement parameters  |
| Pulse average           | Performs frequency measurement per specified number of pulses. When fluctuation exists periodically in the pulse interval, the fluctuation can be eliminated.<br>Specified number of pulses: 1 to 4096<br>Can be specified when measuring the frequency, RPMs, RPSs, power supply frequency, period, pulse integration, and velocity   |
| Offset function         | Observe fluctuation with respect to the offset frequency<br>Offset range: Can be set up to 1000 times the maximum div value <ul style="list-style-type: none"><li>• Frequency: 0 Hz to 500 kHz</li><li>• RPMs: 0 rpm to 50 krpm</li><li>• RPSs: 0 rps to 1000 rps</li><li>• Period: 0 s to 50 s</li><li>• Duty cycle: 0% to 100%</li><li>• Pulse width: 0 s to 50 s</li><li>• Pulse integration: <math>-1.0000 \times 10^{22}</math> to <math>1.0000 \times 10^{22}</math></li><li>• Velocity: <math>-1.0000 \times 10^{22}</math> to <math>1.0000 \times 10^{22}</math></li></ul> |

## High-Speed 100 MS/s, 12-Bit Isolation Module (720210 and 720211)

| Item  | Specifications   |
|---|--|
| Standard operating conditions   | Temperature: 23 ±5°C<br>Humidity: 20 to 80% RH<br>After a 30-minute warm-up and after calibration  |
| Effective measurement range   | 20 div (display range: 10 div)   |
| Number of input channels  | 2  |
| Input coupling  | AC, DC, and GND  |
| Maximum sample rate   | 100 MS/s   |
| Input format  | Isolated unbalanced  |
| Frequency characteristics <sup>1</sup><br>(-3 dB point when sine wave<br>of amplitude ±3 div is applied)            | DC to 20 MHz   |
| Voltage-axis sensitivity setting  | 10 mV/div to 20 V/div (1-2-5 steps) (when using 1:1 probe attenuation)   |
| Maximum input voltage<br>(at a frequency of 1 kHz or less)  | Combined with the 700929 (10:1), 702902 (10:1), or 701947 (100:1): <sup>2</sup><br>1000 V (DC+ACpeak)<br>Combined with the 701901+701954 (1:1): <sup>4</sup><br>200 V (DC+ACpeak)<br>Direct input (cable that does not comply with the safety standards): <sup>6</sup><br>42 V (DC+ACpeak)   |
| Maximum rated voltage to earth<br>Between input and case<br>Between each input<br>(at a frequency of 1 kHz or less) | Working voltage of safety standard<br>In combination with 700929 (10:1)/702902 (10:1)/701947 (100:1), <sup>3</sup> or in combination with<br>701901+701954 (1:1): <sup>5</sup><br>1000 Vrms (CAT II)<br>Combined with the 702902 (10:1): <sup>3</sup><br>1000 V (DC+ACpeak)<br>Direct input (cable that does not comply with the safety standards): <sup>7</sup><br>42 V (DC+ACpeak) (CAT II, 30 Vrms) |
| Vertical (voltage) axis accuracy<br>DC accuracy <sup>1</sup>  | 10 mV/div to 20 V/div: ±(0.5% of 10 div)   |
| Input connector   | BNC connector (isolated type)  |
| Input impedance   | 1 MΩ ± 1%, approx. 35 pF   |
| -3 dB point when AC coupled<br>low frequency attenuation point  | 10 Hz or less (1 Hz or less when using the 700929 or 702902, 0.1 Hz or less when using the<br>700929)  |
| Common mode rejection ratio   | 80 dB (50/60 Hz) or more (typical value <sup>8</sup> )   |
| Residual noise level<br>(Input section shorted)   | ±1.1 mV or ±0.15 /div whichever is greater (typical value <sup>8</sup> )   |
| Withstand voltage   | 5400 Vrms for 2 seconds (across each terminal and earth) (60 Hz)   |
| Insulation resistance   | 500 VDC, 10 MΩ or more (across each input terminal and earth)  |
| A/D conversion resolution   | 12 bit (150 LSB/div)   |
| Temperature coefficient   | Zero point: 10 mV/div to 20 V/div: ±(0.1% of 10 div)/°C (typical value <sup>8</sup> )<br>Gain: ±(0.05% of 10 div)/°C (typical value <sup>8</sup> )   |
| Bandwidth limit   | Select from Full and 2 MHz<br>Cut-off characteristics: -12 dB/OCT (typical value <sup>8</sup> )<br>Cutoff frequency: 1.28 MHz, 640 kHz, 320 kHz, 160 kHz, 80 kHz, 40 kHz, 20 kHz, 10 kHz<br>Filter format: IIR   |
| Probe attenuation setting   | Voltage probe: 1:1, 10:1, 100:1, 1000:1<br>Current probe: 1 A:1 V, 10 A:1 V (for the 701932/701933), 100 A: 1 V (for the 701930/701931)  |

<sup>1</sup> Value measured under standard operating conditions.



## 6.13 Module Specifications

Combined with the 700929, 702902, or 701947

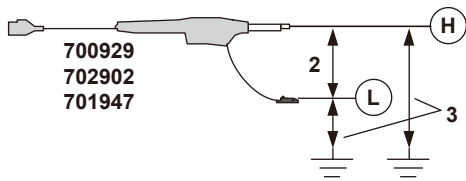

Combined with the 701901 + 701954

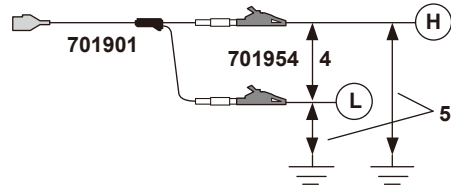

Direct input (cable that does not comply with the safety standards)

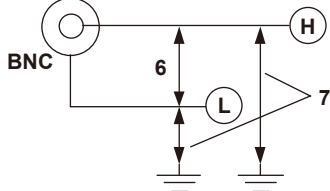

8 Typical value represents a typical or average value. It is not strictly warranted.

### **Note**

You can install up to four 720210 modules, and these modules must be installed in the top slots.

## 16-CH Voltage Input Module (720220)

| Item   | Specifications  |
|--|---|
| Standard operating conditions  | Ambient temperature: $23 \pm 5^\circ\text{C}$<br>Ambient humidity: 20 to 80% RH<br>After the DL850E/DL850EV has been warmed up for 30 minutes and then calibration has been performed |
| Effective measurement range  | 20 div (display range: 10 div)  |
| Number of input sub channels   | 16  |
| Input coupling settings  | DC, GND, and OFF  |
| Maximum sample rate  | 200 kS/s for a single channel, 16 ch $\times$ 10 kS/s   |
| Input format   | All isolated unbalanced   |
| Frequency characteristics <sup>1</sup><br>(-3 dB point when a sine wave with an amplitude of $\pm 3$ div is applied)             | DC to 5 kHz   |
| Selectable voltage sensitivity range   | 0.2 V/div to 2 V/div (in 1-2-5 steps)   |
| Max. measurement voltage range   | $\pm 20$ V  |
| Maximum input voltage <sup>2</sup><br>(at a frequency of 1 kHz or less)  | Direct input: 42 V (DC + ACpeak)  |
| Maximum rated voltage to earth <sup>3</sup><br>Between input and case<br>Between each input<br>(at a frequency of 1 kHz or less) | The Working Voltage in the safety standards<br>Direct input: 42 V (DC + ACpeak) (CAT II, 30 Vrms)   |
| DC vertical-axis (voltage-axis) accuracy <sup>1</sup>  | $\pm (0.3\%$ of 10 div)   |
| Input connector  | Spring terminal blocks. Each 8-channel unit is removable.   |
| Input impedance  | $1\ \text{M}\Omega \pm 1\%$   |
| Common mode rejection ratio  | 80 dB (50/60 Hz) or more (typical value <sup>4</sup> )  |
| Residual noise level (input section shorted)   | $\pm 0.05$ div  |
| A/D converter resolution   | 16 bits, 2400 LSB/div   |
| Temperature coefficient  | Zero point: $\pm(0.02\%$ of 10 div)/ $^\circ\text{C}$ (typical value <sup>4</sup> )<br>Gain: $\pm(0.02\%$ of 10 div)/ $^\circ\text{C}$ (typical value <sup>4</sup> )                  |
| Bandwidth limit  | Can be set to Full or 500 Hz on each sub channel  |
| Wiring   | Recommended: 0.20 mm <sup>2</sup> to 1.00 mm <sup>2</sup> . AWG size: 24-18.  |

1 Value measured under standard operating conditions.

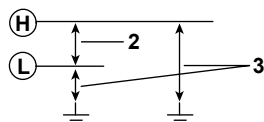

4 Typical value represents a typical or average value. It is not strictly warranted.

## 6.13 Module Specifications

### 16-CH Temperature/Voltage Input Module (720221)

| Item   | Specifications  |  |  |
|--|---|--|--|
| Standard operating conditions  | Temperature: 23 ±5°C<br>Humidity: 20 to 80% RH<br>After a 30-minute warm-up and after calibration   |  |  |
| Function   | Temperature (thermocouple) or voltage measurement (DC coupling)   |  |  |
| Effective measurement range  | [Voltage measurement]   | 20 div (display range: 10 div)   |  |
| Number of input sub channels   | 16  |  |  |
| Input coupling   | TC, DC, OFF, and GND<br>TC: Temperature (thermocouple) measurement<br>DC: Voltage measurement (DC coupling)<br>Can be set separately for each sub channel |  |  |
| Data update period   | 100 ms, 300 ms, 1 s, 3 s  |  |  |
| Input format   | Isolated unbalanced   |  |  |
| Measurement range/accuracy <sup>1</sup>  | [Voltage measurement]   | Voltage sensitivity:   | 1 mV/div to 2 V/div (1-2-5 steps)  |
|  |   | Voltage accuracy:  | ±(0.15% of 10 div)   |
| For the thermocouple standards, see the 701261 specifications.   | [Temperature measurement] <sup>2</sup>  |  |  |
|  | <b>Type</b>   | <b>Measurement Range</b>   | <b>Accuracy</b>  |
|  | K   | -200 to 1300°C   |  |
|  | E   | -200 to 800°C  |  |
|  | J   | -200 to 1100°C   |  |
|  | T   | -200 to 400°C  | ±(0.1% of reading + 1.5°C)   |
|  | L   | -200 to 900°C  | Except ±(0.2% of reading + 1.5°C) for -200°C to 0°C  |
|  | U   | -200 to 400°C  |  |
|  | N   | 0 to 1300°C  |  |
|  | R   | 0 to 1700°C  | ±(0.1% of reading + 3°C)   |
|  | S   | 0 to 1700°C  | Except, 0 to 200°C: ±8°C<br>200 to 800°C: ±5°C   |
|  | B   | 0 to 1800°C  | ±(0.1% of reading + 2°C)<br>Except, 400 to 700°C: ±8°C<br>Effective range is 400 to 1800°C |
|  | W   | 0 to 2300°C  | ±(0.1% of reading + 3°C)   |
|  | Au7Fe <sup>3</sup>  | 0 to 300K  | 0 to 50K: ±4K<br>50 to 300K: ±2.5K   |
| Maximum input voltage <sup>4</sup><br>(at a frequency of 1 kHz or less)  | Both temperature and voltage input:   | 42 V (DC + ACpeak)   |  |
| Maximum rated voltage to earth <sup>5</sup><br>Between input and case<br>Between each input<br>(at a frequency of 1 kHz or less) | Both temperature and voltage input:   | 42 V (DC+ACpeak) (CAT II, 30 Vrms)   |  |
| Vertical resolution  | [Voltage measurement]   | During voltage input:  | 2400 LSB/div   |
|  | [Temperature measurement]   | When measuring temperature:  | 0.1°C  |
| Common mode rejection ratio  | [Voltage measurement]   | 100 dB (50/60 Hz) or more (typical value <sup>6</sup> )                                      |  |
|  | [Temperature measurement]   | 140 dB or more (50/60 Hz, with data update period = 3 seconds) (typical value <sup>6</sup> ) |  |
| Residual noise level<br>(Input section shorted)  | ±0.01 div (typical value <sup>6</sup> )   |  |  |
| A/D conversion resolution  | [Voltage measurement]   | 16 bits (2400 LSB/div)   |  |
| Temperature coefficient  | Zero point:   | ±(0.025% of 10 div)/°C (typical value <sup>6</sup> )   |  |
|  | Gain:   | ±(0.01% of 10 div)/°C (typical value <sup>6</sup> )  |  |
| Reference junction compensation accuracy (when the input terminal temperature is balanced)                                       | K, E, J, T, L, U, N:  | ±1°C   |  |
|  | R, S, B, W:   | ±1.5°C   |  |
|  | Au7Fe:  | ±1K  |  |
| Bandwidth limit (typical value <sup>6</sup> )<br>(-3 dB point)   | Data update period:   | 100 ms: 600 Hz<br>300 ms: 200 Hz<br>1 s: 50 Hz<br>3 s: 10 Hz                                 |  |
| Input connector  | Screw type  |  |  |
| Input impedance  | Approx. 1 MΩ  |  |  |
| Interference between sub channels:   | 100 dB (50/60 Hz) or more (typical value <sup>6</sup> )   |  |  |
| External scanner box   | Model number: 701953, built-in reference junction<br>Length of included cable: 1 m, 3 m (selectable)  |  |  |

- 1 Value measured under standard operating conditions.
- 2 Does not include the reference junction temperature compensation accuracy.
- 3 This module supports Au7Fe with 0.07% metal content with respect to gold.

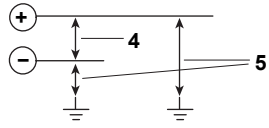

- 6 Typical value represents a typical or average value. It is not strictly warranted.

## 6.13 Module Specifications

---

### Logic Input Module (720230)

| Item                              | Specifications   |
|-----------------------------------|--|
| Standard operating conditions     | Ambient temperature: 23 ± 5°C<br>Ambient humidity: 20 to 80% RH  |
| Number of input ports             | 2  |
| Number of input bits              | 8 bits per port  |
| Maximum sample rate               | 10 MS/s  |
| Input format                      | Use a non-isolated, dedicated probe (automatic detection)  |
| Compatible probes                 | 700986 (non-isolated 8-bit input)<br>700987 (isolated 8-bit input)<br>702911 (non-isolated 8-bit input)<br>702912 (non-isolated 8-bit input) |
| Chatter suppression time settings | Off, 5 ms, 10 ms, 20 ms, 50 ms, and 100 ms   |

## CAN Bus Monitor Module (720240)

| Item   | Specifications  |
|--|---|
| Standard operating condition                               | Ambient temperature: 23±5°C<br>Ambient humidity: 20 to 80% RH   |
| Number of input ports                                      | 2   |
| Maximum sample rate  | 100 kS/s  |
| Input format   | Isolated unbalanced   |
| Maximum input voltage                                      | -3 to +10 V (between CAN_H and GND or CAN_L and GND)  |
| Maximum rated voltage to earth                             | 42 V (DC+ACpeak) (CAT II, 30 Vrms)  |
| Between input and case                                     |   |
| Between each input   |   |
| Input connector  | D-sub 9 pin (male)  |
| Terminator   | Internal, can be enabled or disabled for each port  |
| Supported protocol   | Physical layer: ISO-11898 (High Speed Communication)  |
| Supported bit rates <sup>1</sup>                           | 10 kbps, 20 kbps, 33.3 kbps, 50 kbps, 62.5 kbps, 66.7 kbps, 83.3 kbps, 100 kbps, 125 kbps, 200 kbps, 250 kbps, 400 kbps, 500 kbps, 800 kbps, 1 Mbps |
| LED display  | Illuminates to indicate that the terminator is enabled  |
| Number of sub channels                                     | 60 sub channels/ports   |
| One shot output  | Frames can be output in single shots  |
| Terminator resistance (when the terminator is enabled)     | 110 to 130 Ω  |
| A/D converter resolution (when Value Type is set to Float) | 16 bits, 2400 LSB/div   |

1 Low-speed CAN at low-speed transceiver levels is not supported.

## 6.13 Module Specifications

### CAN & LIN Bus Monitor Module (720241)

| Item                         | Specifications  |
|------------------------------|---|
| Standard operating condition | Ambient temperature: 23±5°C<br>Ambient humidity: 20 to 80% RH |
| Number of input ports        | CAN port: 1. LIN port: 1.                                     |
| Maximum sample rate          | 100 kS/s  |
| Input format                 | Isolated unbalanced   |

#### CAN port

| Item   | Specifications  |
|--|---|
| Maximum input voltage  | -3 to +10 V (between CAN_H and GND or CAN_L and GND)  |
| Maximum rated voltage to earth<br>Between input and case<br>Between each input | 42 V (DC+ACpeak) (CAT II, 30 Vrms)  |
| Input connector  | D-sub 9 pin (male)  |
| Terminator   | Internal, can be enabled or disabled  |
| Terminator resistance<br>(when the terminator is enabled)                      | 110 to 130 Ω  |
| LED display  | Illuminates to indicate that the terminator is enabled  |
| Supported protocol   | Physical layer: ISO-11898 (High Speed Communication)  |
| Supported bit rates <sup>1</sup>   | 10 kbps, 20 kbps, 33.3 kbps, 50 kbps, 62.5 kbps, 66.7 kbps, 83.3 kbps, 100 kbps, 125 kbps, 200 kbps, 250 kbps, 400 kbps, 500 kbps, 800 kbps, 1 Mbps |
| Number of sub channels   | 60 sub channels   |
| One shot output  | Frames can be output in single shots  |
| A/D converter resolution<br>(when Value Type is set to Float)                  | 16 bits, 2400 LSB/div   |

1 Low-speed CAN at low-speed transceiver levels is not supported.

#### LIN port

| Item   | Specifications                           |
|--|--|
| Maximum input voltage  | -0.3 to +18 V (between LIN.VBAT and GND) |
| Maximum rated voltage to earth<br>Between input and case<br>Between each input | 30 Vrms (CAT I and II)                   |
| Input connector  | D-sub 9 pin (male)                       |
| Supported protocol   | Physical layer: Complies with ISO9141    |
| Supported bit rates  | 2400 bps, 9600 bps, 19200 bps            |
| Number of sub channels   | 60 sub channels                          |
| Supported check sums   | Standard check sum, extended check sum   |

## CAN/CAN FD Monitor Module (720242)

| Item   | Specifications   |
|--|--|
| Standard operating condition                               | Ambient temperature: 23±5°C<br>Ambient humidity: 20 to 80% RH  |
| Number of input ports                                      | 2  |
| Maximum sample rate  | 100 kS/s   |
| Input format   | Differential input that is compliant with ISO 11898<br>Isolated (across port and main unit, across each port)  |
| Maximum input voltage                                      | -3 to +10 V (between CAN_H and GND or CAN_L and GND)   |
| Maximum rated voltage to earth                             | 42 V (DC+ACpeak) (CAT II, 30 Vrms)   |
| Between input and case                                     |  |
| Between each input   |  |
| Input connector  | D-sub 9 pin (male)   |
| Terminator   | Internal, can be enabled or disabled for each port   |
| Supported protocol   | CAN, CAN FD (ISO 11898-1:2015 or non-ISO)<br>Physical layer: ISO-11898 (High Speed Communication)  |
| Supported bit rates <sup>1</sup>                           | 10 kbps, 20 kbps, 33.3 kbps, 50 kbps, 62.5 kbps, 66.7 kbps, 83.3 kbps, 100 kbps, 125 kbps, 200 kbps, 250 kbps, 400 kbps, 500 kbps, 800 kbps, 1 Mbps<br>Flexible data rate 1 Mbps, 2 Mbps, 3 Mbps, 4 Mbps, 5 Mbps |
| Sample point   | 65% to 90% (in 1% steps)   |
| LED display  | Illuminates to indicate that the terminator is enabled   |
| Number of sub channels                                     | 60 sub channels/ports  |
| One shot output  | Frames can be output in single shots.<br>CAN/CAN FD packets can be output (packet format can be set).<br>CAN FD packets can be output up to 64 bytes.  |
| Terminator resistance (when the terminator is enabled)     | 110 to 130 Ω   |
| A/D converter resolution (when Value Type is set to Float) | 16 bits, 2400 LSB/div  |

<sup>1</sup> Low-speed CAN at low-speed transceiver levels is not supported.



## 6.13 Module Specifications

### SENT Monitor Module (720243)

| Item   | Specifications  |
|--|---|
| Standard operating condition   | Ambient temperature: 23±5°<br>Ambient humidity: 20 to 80% RH  |
| Number of input ports  | 2   |
| Maximum data update rate   | 100 kS/s (10 µs)  |
| Input format   | Isolated unbalanced   |
| Input connector  | BNC connector (isolated type)   |
| Input impedance  | 1 MΩ±1%, approx. 35 pF  |
| Supported protocol   | SAE J2716   |
| Supported clock tick span  | 1 µs to 100 µs      Resolution: 0.01 µs   |
| Supported number of nibbles  | 1 to 8  |
| Number of analysis sub channels  | 8 channels total including fast channels and slow channels<br>Fast channel      Up to 8<br>Slow channel      Up to 5<br>Status & communication      1 ch (4 bit)<br>Error trigger      1 ch (5 bit)<br>Error count      1 ch  |
| Fast channel analysis function   | Handles fast channel multiplexing   |
| Low level input voltage  | 1.5 V (typical value <sup>1</sup> )   |
| High level input voltage   | 3.5 V (typical value <sup>1</sup> )   |
| Maximum input voltage  | Combined with the 700929 (10:1) or 702902 (10:1): <sup>2</sup><br>420 V (DC+ACpeak)<br>Combined with the (701901 + 701954) (1:1) or direct input (cable that does not comply with the safety standards): <sup>4</sup><br>42 V (DC+ACpeak)   |
| Maximum rated voltage to earth<br>Between input and case<br>Between each input | Working voltage of safety standard<br>42 V (DC+ACpeak) (CAT II, 30 Vrms)  |
| Withstand voltage  | 2300 Vrms for 2 seconds (across each terminal and earth) (60 Hz)  |
| Insulation resistance  | 500 VDC, 10 MΩ or more (across each input terminal and earth)   |
| Input status indication function   | Input status indication through the LEDs of each port function<br>When in operation:      Illuminates in green when pulse input is detected<br>When overdriven:      Illuminates in red when the input voltage exceeds 20 V   |
| Probe attenuation setting  | 10:1, 1:1   |
| Compatible probes/cables   | Voltage probe: Recommended<br>700929 (10:1 safety probe), 20 to 45 pF<br>702902 (10:1 safety probe), 25 to 40 pF<br>Connection cable (for high voltage 1:1)<br>701901 (isolated type BNC-safety alligator clip adapter ×2), 701954 (alligator clip (dolphin type) red/black 2-piece set) is required separately<br>Connection cable (for low voltage 1:1)<br>366926 (non-isolated type BNC-alligator clip ×2) |

1 Typical value represents a typical or average value. It is not strictly warranted.

**Combined with the 700929 or 702902**

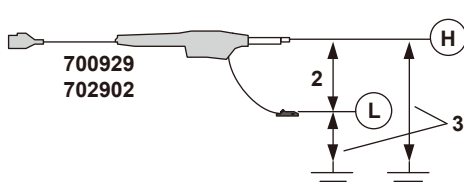

**Combined with the (701901 + 701954) or direct input (cable that does not comply with the safety standards)**

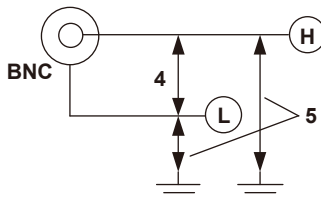

## 4-CH 1 MS/s, 16-Bit Isolation Module (720254)

| Item  | Specifications  |
|---|---|
| Standard operating conditions   | Temperature: 23 ±5°C<br>Humidity: 20 to 80% RH<br>After a 30-minute warm-up and after calibration   |
| Effective measurement range   | 20 div (display range: 10 div)  |
| Number of input channels  | 4   |
| Input coupling  | AC, DC, and GND   |
| Maximum sample rate   | 1 MS/s  |
| Input format  | Isolated unbalanced   |
| Frequency characteristics <sup>1</sup><br>(-3 dB point when a sine wave of amplitude ±3 div is applied)             | DC to 300 kHz   |
| Voltage-axis sensitivity setting  | 10 mV/div to 50 V/div (1-2-5 steps) (when using 1:1 probe attenuation)  |
| Maximum input voltage<br>(at a frequency of 1 kHz or less)  | Combined with the 700929 (10:1), 702902 (10:1), or 701947 (100:1): <sup>2</sup><br>600 V (DC+ACpeak)<br>Combined with the 701901+701954 (1:1): <sup>4</sup><br>200 V (DC+ACpeak) (as a value that meets the safety standard)<br>400 V (DC + ACpeak) (maximum allowable voltage, as a value that does not damage the instrument when applied)<br>Direct input (cable that does not comply with the safety standards): <sup>6</sup><br>42 V (DC+ACpeak) |
| Maximum rated voltage to earth<br>Between input and case<br>Between each input<br>(at a frequency of 1 kHz or less) | Working voltage of safety standard<br>In combination with 700929 (10:1)/702902 (10:1)/701947 (100:1), <sup>3</sup> or in combination with 701901+701954 (1:1) <sup>5</sup><br>400 Vrms (measurement category Other (O)), 300 Vrms (CAT II)<br>Direct input (cable that does not comply with the safety standards): <sup>7</sup><br>42 V (DC+ACpeak) (CAT II, 30 Vrms)   |
| Vertical (voltage) axis accuracy<br>DC accuracy <sup>1</sup>  | ±(0.25% of 10 div)  |
| Input connector   | BNC connector (isolated type)   |
| Input impedance   | 1 MΩ ± 1%, approx. 35 pF  |
| -3 dB point when AC coupled<br>low frequency attenuation point  | 1 Hz or less (0.1 Hz or less when using the 700929 or 702902, 0.01 Hz or less when using the 701947)  |
| Common mode rejection ratio   | 80 dB (50/60 Hz) or more (typical value <sup>8</sup> )  |
| Residual noise level<br>(Input section shorted)   | ±0.05 div (typical value <sup>8</sup> ) 10 mV/div, 20 mV/div<br>±0.025 div (typical value <sup>8</sup> ) 50 mV/div to 20 V/div  |
| Withstand voltage   | 2300 Vrms for 2 seconds (across each terminal and earth) (60 Hz)  |
| Insulation resistance   | 500 VDC, 10 MΩ or more (across each input terminal and earth)   |
| A/D conversion resolution   | 16 bit (2400 LSB/div)   |
| Temperature coefficient   | Zero point: ±(0.02% of 10 div)/°C (typical value <sup>8</sup> )<br>Gain: ±(0.02% of 10 div)/°C (typical value <sup>8</sup> )  |
| Bandwidth limit   | Select from Full and 40 kHz<br>Cut-off characteristics: -12 dB/OCT (typical value <sup>8</sup> )<br>Digital filter<br>Cutoff frequency: 12.8 kHz, 6.4 kHz, 3.2 kHz, 1.6 kHz, 800 Hz, 400 Hz, 200 Hz, 100 Hz, 50 Hz, 25 Hz, 12.5 Hz, 6.25 Hz<br>Filter format: IIR   |
| Probe attenuation setting   | Voltage probe: 1:1, 10:1, 100:1, 1000:1<br>Current probe: 1 A:1 V, 10 A:1 V (for the 701932/701933), 100 A: 1 V (for the 701930/701931)   |

### 6.13 Module Specifications

| Item                     | Specifications  |
|--------------------------|---|
| Compatible probes/cables | <p>Voltage probe: Recommended</p> <p>700929 (10:1 safety probe), 20 to 45 pF: For measuring 600 V (DC+ACpeak) or less</p> <p>702902 (10:1 safety probe), 25 to 40 pF: For measuring 600 V (DC+ACpeak) or less</p> <p>701947 (100:1 probe), 15 to 45 pF: For measuring 600 V (DC+ACpeak) or less</p> <p>Current probe (power can be supplied from the DL850E/DL850EV. Option)</p> <p>701930 (150 A), 701931 (500 A), 701932 (30 A), 701933 (30 A)</p> <p>High voltage differential probe (connect the GND cable provided with the probe to the DL850E/DL850EV case)</p> <p>700924 (1000:1, 100:1/1400 V (DC+ACpeak)): For measuring 1400 V (DC+ACpeak) or less</p> <p>Connection cable (for high voltage 1:1)</p> <p>701901 (isolated type BNC-safety alligator clip adapter ×2: For measuring 200 V (DC+ACpeak) or less), 701954 (alligator clip (dolphin type) red/black 2-piece set) is required separately</p> <p>Connection cable (for low voltage 1:1)</p> <p>366926 (non-isolated type BNC-alligator clip ×2: For measuring low voltage less than or equal to 42 V (DC+ACpeak))</p> |

1 Value measured under standard operating conditions.

Combined with the 700929, 702902, or 701947

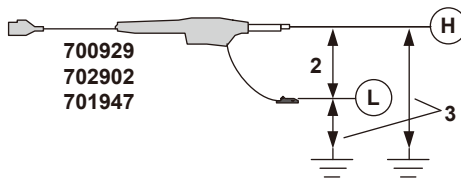

Combined with the 701901+701954

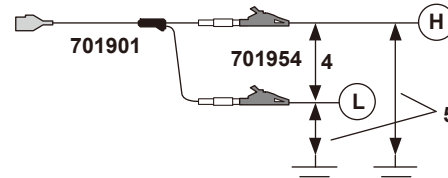

Direct input (cable that does not comply with the safety standards)

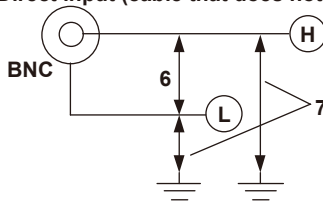

8 The typical value is a representative or standard value. It is not strictly warranted.

## 6.14 Logic Probe Specifications

### High-Speed Logic Probe (700986)

| Item  | Specifications   |
|---|--|
| Number of inputs  | 8  |
| Input format  | Non-isolated (all the bits share the same ground with the DL850E/DL850EV and each other) |
| Maximum input voltage (at a frequency of 1 kHz or less) | 42V (DC + ACpeak) (CAT II, 30 Vrms), between the probe tip and ground                    |
| Response time   | Within 1 $\mu$ s (typical value <sup>1</sup> )   |
| Input impedance   | 100 k $\Omega$ or more   |
| Threshold level   | Approx. 1.4 V  |

1 The typical value is a representative or standard value. It is not strictly warranted.

### Isolated Logic Probe (700987)

| Item                                   | Specifications   |
|--|--|
| Number of inputs                       | 8  |
| Input format                           | Isolated (all bits are isolated)   |
| Input connector                        | Safety terminal type (for banana plug) $\times$ 8  |
| Input switching                        | Each bit can be switched to AC or DC input.  |
| Input signal display                   | The H/L state of each bit is indicated with LEDs (the LEDs illuminate to indicate H).  |
| Applicable input range                 | During DC input: H/L detection of 10 VDC to 250 VDC<br>During AC input: H/L detection of 80 VAC to 250 VAC at 50/60 Hz   |
| Threshold level                        | During DC input: 6 V $\pm$ 50% (High level: 10 to 250 VDC, Low level: 0 to 3 VDC)<br>During AC input: 50 VAC $\pm$ 50% (High level: 80 to 250 VAC, Low level: 0 to 20 VAC) |
| Response time                          | During DC input: 1 ms (typical value <sup>1</sup> )<br>During AC input: 20 ms (typical value <sup>1</sup> )  |
| Input impedance                        | Approx. 100 k $\Omega$   |
| Maximum input voltage                  | 250 Vrms <sup>2</sup> (CAT II) (between the H and L terminals of each bit)   |
| Maximum rated voltage to earth         | 250 Vrms <sup>2</sup> (CAT II) (between input terminal H or L and the ground)  |
| Between input and case                 |  |
| Between each input                     |  |
| Maximum allowable voltage between bits | 250 Vrms <sup>2</sup> (CAT II)   |
| Withstand voltage                      | 2000 VAC for 1 minute (between the input terminals and the ground)   |
| Insulation resistance                  | 500 VDC, 10 M $\Omega$ or greater (between the input terminals and the ground)   |
| Fuse <sup>3</sup>                      | Location: H side of input terminal<br>Max. rated voltage: 250 V<br>Max. rated current: 50 mA<br>Type: Time lag<br>Standard: VDE/SEMKO approved                             |

1 The typical value is a representative or standard value. It is not strictly warranted.

2 Make sure that the peak AC voltage does not exceed 350 V and that the DC voltage does not exceed 250 V when the frequency is 1 kHz or less.

3 Because the fuses used by this instrument are all inside the case, you cannot replace them yourself. If you believe that the fuse inside the case has blown, please contact your nearest YOKOGAWA dealer.

### Logic Probe (702911 and 702912)

| Item                  | Specifications   |
|-----------------------|--|
| Number of inputs      | 8  |
| Input format          | Non-isolated (all the bits share the same ground with the DL850E/DL850EV and each other) |
| Maximum input voltage | $\pm$ 35 V   |
| Response time         | Within 3 $\mu$ s (typical value <sup>1</sup> )   |
| Input impedance       | 10 k $\Omega$ or more  |
| Threshold level       | Approx. 1.4 V  |
| Input methods         | TTL level or contact input (switchable). During contact input: Pulled up to 5 V          |

1 The typical value is a representative or standard value. It is not strictly warranted.

## 6.14 Logic Probe Specifications

---

### **Note**

Before using logic probes (702911, 702912) or isolated logic probe 700987, flip the attenuation switch back and forth several times. The switch's electrical contacts can weaken if not used for long periods of time.

---

## 6.15 16-CH Scanner Box Specifications

For the specifications other than the dimensions of the 16-CH Scanner Box, see the 16-CH temperature/voltage input module (720221) specifications.

### External Dimensions

Unit: mm

Unless otherwise specified, tolerances are  $\pm 3\%$  (however, tolerances are  $\pm 0.3$  mm when below 10 mm).

#### 16-CH Scanner Box

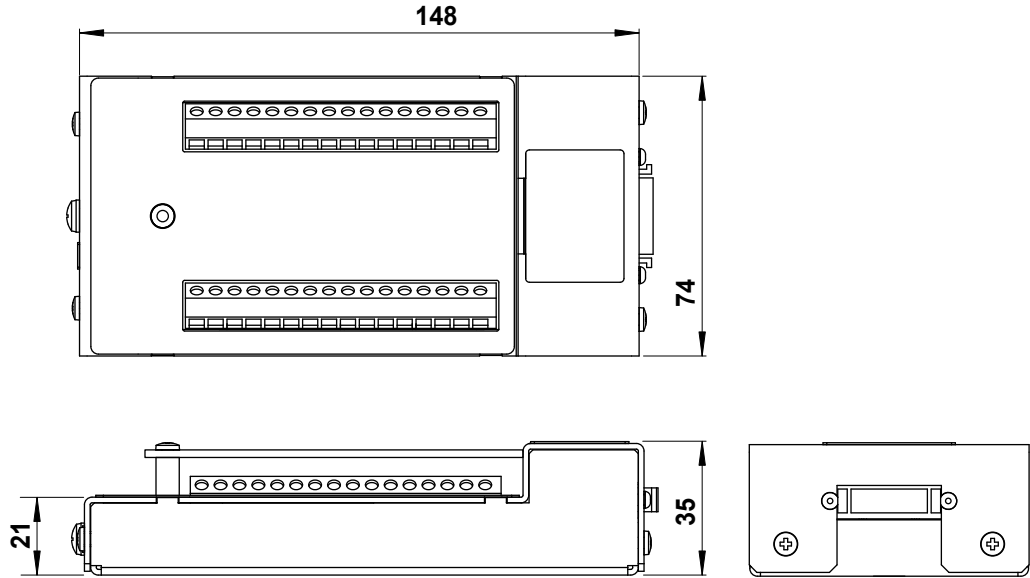

#### Attaching plate

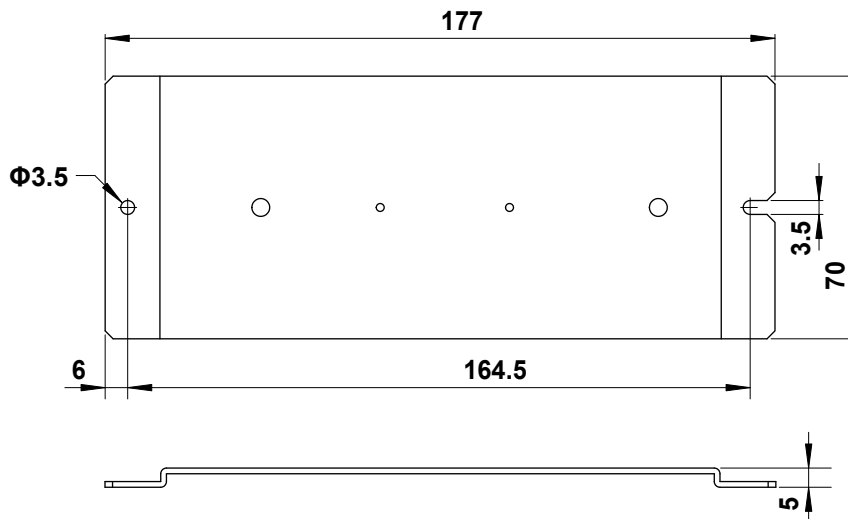

## 6.16 External Dimensions

### DL850E/DL850EV

Unit: mm

Unless otherwise specified, tolerances are  $\pm 3\%$  (however, tolerances are  $\pm 0.3$  mm when below 10 mm).

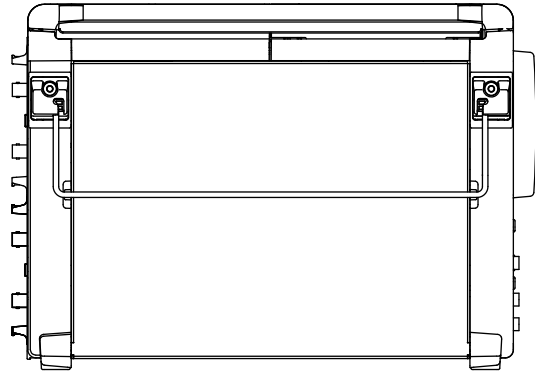
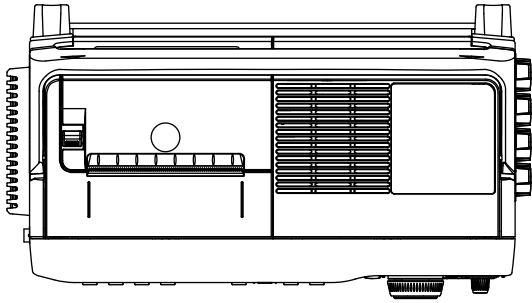

Rear view

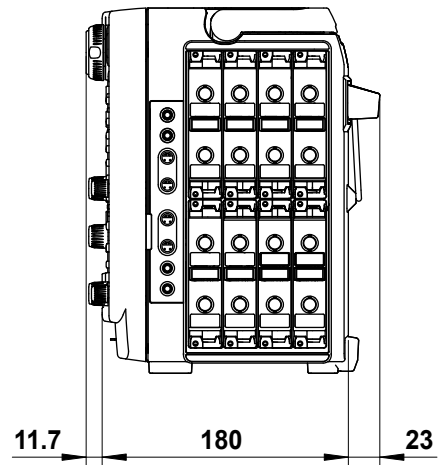
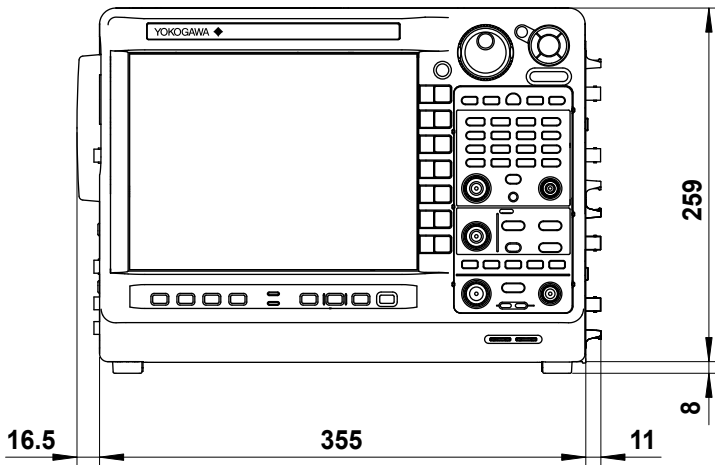

### DC Power Model

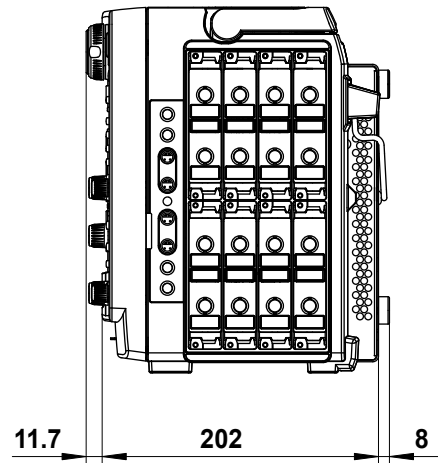

# Appendix 1 Relationship between the Time Axis Setting, Record Length, and Sample Rate

**When the High-Speed 100 MS/s, 12-Bit Isolation Module Is Installed**

**When the Record Length Is 1 kpoint, 2.5 kpoint, 5 kpoint, 10 kpoint, or 25 kpoint**

| Time/div | Record            |                                |                   |                                |                   |                                |                   |                                |                   |                                |
|----------|-------------------|--------------------------------|-------------------|--------------------------------|-------------------|--------------------------------|-------------------|--------------------------------|-------------------|--------------------------------|
|          | 1 kpoint          |                                | 2.5 kpoint        |                                | 5 kpoint          |                                | 10 kpoint         |                                | 25 kpoint         |                                |
|          | Sample Rate (S/s) | Display Record Length (Points) | Sample Rate (S/s) | Display Record Length (Points) | Sample Rate (S/s) | Display Record Length (Points) | Sample Rate (S/s) | Display Record Length (Points) | Sample Rate (S/s) | Display Record Length (Points) |
| 100 ns   | 100 M             | 100                            | 100 M             | 100                            | 100 M             | 100                            | 100 M             | 100                            | 100 M             | 100                            |
| 200 ns   | 100 M             | 200                            | 100 M             | 200                            | 100 M             | 200                            | 100 M             | 200                            | 100 M             | 200                            |
| 500 ns   | 100 M             | 500                            | 100 M             | 500                            | 100 M             | 500                            | 100 M             | 500                            | 100 M             | 500                            |
| 1 μs     | 100 M             | 1 k                            | 100 M             | 1 k                            | 100 M             | 1 k                            | 100 M             | 1 k                            | 100 M             | 1 k                            |
| 2 μs     | 50 M              | 1 k                            | 100 M             | 2 k                            | 100 M             | 2 k                            | 100 M             | 2 k                            | 100 M             | 2 k                            |
| 5 μs     | 20 M              | 1 k                            | 50 M              | 2.5 k                          | 100 M             | 5 k                            | 100 M             | 5 k                            | 100 M             | 5 k                            |
| 10 μs    | 10 M              | 1 k                            | 20 M              | 2 k                            | 50 M              | 5 k                            | 100 M             | 10 k                           | 100 M             | 10 k                           |
| 20 μs    | 5 M               | 1 k                            | 10 M              | 2 k                            | 20 M              | 4 k                            | 50 M              | 10 k                           | 100 M             | 20 k                           |
| 50 μs    | 2 M               | 1 k                            | 5 M               | 2.5 k                          | 10 M              | 5 k                            | 20 M              | 10 k                           | 50 M              | 25 k                           |
| 100 μs   | 1 M               | 1 k                            | 2 M               | 2 k                            | 5 M               | 5 k                            | 10 M              | 10 k                           | 20 M              | 20 k                           |
| 200 μs   | 500 k             | 1 k                            | 1 M               | 2 k                            | 2 M               | 4 k                            | 5 M               | 10 k                           | 10 M              | 20 k                           |
| 500 μs   | 200 k             | 1 k                            | 500 k             | 2.5 k                          | 1 M               | 5 k                            | 2 M               | 10 k                           | 5 M               | 25 k                           |
| 1 ms     | 100 k             | 1 k                            | 200 k             | 2 k                            | 500 k             | 5 k                            | 1 M               | 10 k                           | 2 M               | 20 k                           |
| 2 ms     | 50 k              | 1 k                            | 100 k             | 2 k                            | 200 k             | 4 k                            | 500 k             | 10 k                           | 1 M               | 20 k                           |
| 5 ms     | 20 k              | 1 k                            | 50 k              | 2.5 k                          | 100 k             | 5 k                            | 200 k             | 10 k                           | 500 k             | 25 k                           |
| 10 ms    | 10 k              | 1 k                            | 20 k              | 2 k                            | 50 k              | 5 k                            | 100 k             | 10 k                           | 200 k             | 20 k                           |
| 20 ms    | 5 k               | 1 k                            | 10 k              | 2 k                            | 20 k              | 4 k                            | 50 k              | 10 k                           | 100 k             | 20 k                           |
| 50 ms    | 2 k               | 1 k                            | 5 k               | 2.5 k                          | 10 k              | 5 k                            | 20 k              | 10 k                           | 50 k              | 25 k                           |
| 100 ms   | 1 k               | 1 k                            | 2 k               | 2 k                            | 5 k               | 5 k                            | 10 k              | 10 k                           | 20 k              | 20 k                           |
| 200 ms   | 500               | 1 k                            | 1 k               | 2 k                            | 2 k               | 4 k                            | 5 k               | 10 k                           | 10 k              | 20 k                           |
| 500 ms   | 200               | 1 k                            | 500               | 2.5 k                          | 1 k               | 5 k                            | 2 k               | 10 k                           | 5 k               | 25 k                           |
| 1 s      | 100               | 1 k                            | 200               | 2 k                            | 500               | 5 k                            | 1 k               | 10 k                           | 2 k               | 20 k                           |
| 2 s      | 50                | 1 k                            | 100               | 2 k                            | 200               | 4 k                            | 500               | 10 k                           | 1 k               | 20 k                           |
| 3 s      | 20                | 600                            | 50                | 1.5 k                          | 100               | 3 k                            | 200               | 6 k                            | 500               | 15 k                           |
| 4 s      | 20                | 800                            | 50                | 2 k                            | 100               | 4 k                            | 200               | 8 k                            | 500               | 20 k                           |
| 5 s      | 20                | 1 k                            | 50                | 2.5 k                          | 100               | 5 k                            | 200               | 10 k                           | 500               | 25 k                           |
| 6 s      | 10                | 600                            | 20                | 1.2 k                          | 50                | 3 k                            | 100               | 6 k                            | 200               | 12 k                           |
| 8 s      | 10                | 800                            | 20                | 1.6 k                          | 50                | 4 k                            | 100               | 8 k                            | 200               | 16 k                           |
| 10 s     | 10                | 1 k                            | 20                | 2 k                            | 50                | 5 k                            | 100               | 10 k                           | 200               | 20 k                           |
| 20 s     | 5                 | 1 k                            | 10                | 2 k                            | 20                | 4 k                            | 50                | 10 k                           | 100               | 20 k                           |
| 30 s     |                   |                                | 5                 | 1.5 k                          | 10                | 3 k                            | 20                | 6 k                            | 50                | 15 k                           |
| 1 min    |                   |                                |                   |                                | 5                 | 3 k                            | 10                | 6 k                            | 20                | 12 k                           |
| 2 min    |                   |                                |                   |                                |                   |                                | 5                 | 6 k                            | 20                | 24 k                           |
| 3 min    |                   |                                |                   |                                |                   |                                | 5                 | 9 k                            | 10                | 18 k                           |
| 4 min    |                   |                                |                   |                                |                   |                                |                   |                                | 10                | 24 k                           |
| 5 min    |                   |                                |                   |                                |                   |                                |                   |                                | 5                 | 15 k                           |
| 6 min    |                   |                                |                   |                                |                   |                                |                   |                                | 5                 | 18 k                           |
| 7 min    |                   |                                |                   |                                |                   |                                |                   |                                | 5                 | 21 k                           |

When the time axis setting is 100 ms or greater (the settings surrounded by bold lines) and the trigger mode is Auto or Auto Level, waveforms are displayed in roll mode.



Appendix 1 Relationship between the Time Axis Setting, Record Length, and Sample Rate

When the Record Length Is 50 kpoint, 100 kpoint, 250 kpoint, 500 kpoint, or 1 Mpoint

| Time/div | Record Length     |                                |                   |                                |                   |                                |                   |                                |                   |                                |
|----------|-------------------|--------------------------------|-------------------|--------------------------------|-------------------|--------------------------------|-------------------|--------------------------------|-------------------|--------------------------------|
|          | 50 kpoint         |                                | 100 kpoint        |                                | 250 kpoint        |                                | 500 kpoint        |                                | 1 Mpoint          |                                |
|          | Sample Rate (S/s) | Display Record Length (Points) | Sample Rate (S/s) | Display Record Length (Points) | Sample Rate (S/s) | Display Record Length (Points) | Sample Rate (S/s) | Display Record Length (Points) | Sample Rate (S/s) | Display Record Length (Points) |
| 100 ns   | 100 M             | 100                            | 100 M             | 100                            | 100 M             | 100                            | 100 M             | 100                            | 100 M             | 100                            |
| 200 ns   | 100 M             | 200                            | 100 M             | 200                            | 100 M             | 200                            | 100 M             | 200                            | 100 M             | 200                            |
| 500 ns   | 100 M             | 500                            | 100 M             | 500                            | 100 M             | 500                            | 100 M             | 500                            | 100 M             | 500                            |
| 1 µs     | 100 M             | 1 k                            | 100 M             | 1 k                            | 100 M             | 1 k                            | 100 M             | 1 k                            | 100 M             | 1 k                            |
| 2 µs     | 100 M             | 2 k                            | 100 M             | 2 k                            | 100 M             | 2 k                            | 100 M             | 2 k                            | 100 M             | 2 k                            |
| 5 µs     | 100 M             | 5 k                            | 100 M             | 5 k                            | 100 M             | 5 k                            | 100 M             | 5 k                            | 100 M             | 5 k                            |
| 10 µs    | 100 M             | 10 k                           | 100 M             | 10 k                           | 100 M             | 10 k                           | 100 M             | 10 k                           | 100 M             | 10 k                           |
| 20 µs    | 100 M             | 20 k                           | 100 M             | 20 k                           | 100 M             | 20 k                           | 100 M             | 20 k                           | 100 M             | 20 k                           |
| 50 µs    | 100 M             | 50 k                           | 100 M             | 50 k                           | 100 M             | 50 k                           | 100 M             | 50 k                           | 100 M             | 50 k                           |
| 100 µs   | 50 M              | 50 k                           | 100 M             | 100 k                          | 100 M             | 100 k                          | 100 M             | 100 k                          | 100 M             | 100 k                          |
| 200 µs   | 20 M              | 40 k                           | 50 M              | 100 k                          | 100 M             | 200 k                          | 100 M             | 200 k                          | 100 M             | 200 k                          |
| 500 µs   | 10 M              | 50 k                           | 20 M              | 100 k                          | 50 M              | 250 k                          | 100 M             | 500 k                          | 100 M             | 500 k                          |
| 1 ms     | 5 M               | 50 k                           | 10 M              | 100 k                          | 20 M              | 200 k                          | 50 M              | 500 k                          | 100 M             | 1 M                            |
| 2 ms     | 2 M               | 40 k                           | 5 M               | 100 k                          | 10 M              | 200 k                          | 20 M              | 400 k                          | 50 M              | 1 M                            |
| 5 ms     | 1 M               | 50 k                           | 2 M               | 100 k                          | 5 M               | 250 k                          | 10 M              | 500 k                          | 20 M              | 1 M                            |
| 10 ms    | 500 k             | 50 k                           | 1 M               | 100 k                          | 2 M               | 200 k                          | 5 M               | 500 k                          | 10 M              | 1 M                            |
| 20 ms    | 200 k             | 40 k                           | 500 k             | 100 k                          | 1 M               | 200 k                          | 2 M               | 400 k                          | 5 M               | 1 M                            |
| 50 ms    | 100 k             | 50 k                           | 200 k             | 100 k                          | 500 k             | 250 k                          | 1 M               | 500 k                          | 2 M               | 1 M                            |
| 100 ms   | 50 k              | 50 k                           | 100 k             | 100 k                          | 200 k             | 200 k                          | 500 k             | 500 k                          | 1 M               | 1 M                            |
| 200 ms   | 20 k              | 40 k                           | 50 k              | 100 k                          | 100 k             | 200 k                          | 200 k             | 400 k                          | 500 k             | 1 M                            |
| 500 ms   | 10 k              | 50 k                           | 20 k              | 100 k                          | 50 k              | 250 k                          | 100 k             | 500 k                          | 200 k             | 1 M                            |
| 1 s      | 5 k               | 50 k                           | 10 k              | 100 k                          | 20 k              | 200 k                          | 50 k              | 500 k                          | 100 k             | 1 M                            |
| 2 s      | 2 k               | 40 k                           | 5 k               | 100 k                          | 10 k              | 200 k                          | 20 k              | 400 k                          | 50 k              | 1 M                            |
| 3 s      | 1 k               | 30 k                           | 2 k               | 60 k                           | 5 k               | 150 k                          | 10 k              | 300 k                          | 20 k              | 600 k                          |
| 4 s      | 1 k               | 40 k                           | 2 k               | 80 k                           | 5 k               | 200 k                          | 10 k              | 400 k                          | 20 k              | 800 k                          |
| 5 s      | 1 k               | 50 k                           | 2 k               | 100 k                          | 5 k               | 250 k                          | 10 k              | 500 k                          | 20 k              | 1 M                            |
| 6 s      | 500               | 30 k                           | 1 k               | 60 k                           | 2 k               | 120 k                          | 5 k               | 300 k                          | 10 k              | 600 k                          |
| 8 s      | 500               | 40 k                           | 1 k               | 80 k                           | 2 k               | 160 k                          | 5 k               | 400 k                          | 10 k              | 800 k                          |
| 10 s     | 500               | 50 k                           | 1 k               | 100 k                          | 2 k               | 200 k                          | 5 k               | 500 k                          | 10 k              | 1 M                            |
| 20 s     | 200               | 40 k                           | 500               | 100 k                          | 1 k               | 200 k                          | 2 k               | 400 k                          | 5 k               | 1 M                            |
| 30 s     | 100               | 30 k                           | 200               | 60 k                           | 500               | 150 k                          | 1 k               | 300 k                          | 2 k               | 600 k                          |
| 1 min    | 50                | 30 k                           | 100               | 60 k                           | 200               | 120 k                          | 500               | 300 k                          | 1 k               | 600 k                          |
| 2 min    | 20                | 24 k                           | 50                | 60 k                           | 200               | 240 k                          | 200               | 240 k                          | 500               | 600 k                          |
| 3 min    | 20                | 36 k                           | 50                | 90 k                           | 100               | 180 k                          | 200               | 360 k                          | 500               | 900 k                          |
| 4 min    | 20                | 48 k                           | 20                | 48 k                           | 100               | 240 k                          | 200               | 480 k                          | 200               | 480 k                          |
| 5 min    | 10                | 30 k                           | 20                | 60 k                           | 50                | 150 k                          | 100               | 300 k                          | 200               | 600 k                          |
| 6 min    | 10                | 36 k                           | 20                | 72 k                           | 50                | 180 k                          | 100               | 360 k                          | 200               | 720 k                          |
| 7 min    | 10                | 42 k                           | 20                | 84 k                           | 50                | 210 k                          | 100               | 420 k                          | 200               | 840 k                          |
| 8 min    | 10                | 48 k                           | 20                | 96 k                           | 50                | 240 k                          | 100               | 480 k                          | 200               | 960 k                          |
| 9 min    | 5                 | 27 k                           | 10                | 54 k                           | 20                | 108 k                          | 50                | 270 k                          | 100               | 540 k                          |
| 10 min   | 5                 | 30 k                           | 10                | 60 k                           | 20                | 120 k                          | 50                | 300 k                          | 100               | 600 k                          |
| 12 min   | 5                 | 36 k                           | 10                | 72 k                           | 20                | 144 k                          | 50                | 360 k                          | 100               | 720 k                          |
| 15 min   | 5                 | 45 k                           | 10                | 90 k                           | 20                | 180 k                          | 50                | 450 k                          | 100               | 900 k                          |
| 30 min   |                   |                                | 5                 | 90 k                           | 10                | 180 k                          | 20                | 360 k                          | 50                | 900 k                          |
| 1 h      |                   |                                |                   |                                | 5                 | 180 k                          | 10                | 360 k                          | 20                | 720 k                          |
| 2 h      |                   |                                |                   |                                |                   |                                | 5                 | 360 k                          | 10                | 720 k                          |
| 3 h      |                   |                                |                   |                                |                   |                                |                   |                                | 5                 | 540 k                          |
| 4 h      |                   |                                |                   |                                |                   |                                |                   |                                | 5                 | 720 k                          |
| 5 h      |                   |                                |                   |                                |                   |                                |                   |                                | 5                 | 900 k                          |

When the time axis setting is 100 ms or greater (the settings surrounded by bold lines) and the trigger mode is Auto or Auto Level, waveforms are displayed in roll mode.

When the Record Length Is 2.5 Mpoint, 5 Mpoint, 10 Mpoint, 25 Mpoint, or 50 Mpoint

| Time/div | Record Length     |                                |                   |                                |                   |                                |                   |                                |                   |                                |
|----------|-------------------|--------------------------------|-------------------|--------------------------------|-------------------|--------------------------------|-------------------|--------------------------------|-------------------|--------------------------------|
|          | 2.5 Mpoint        |                                | 5 Mpoint          |                                | 10 Mpoint         |                                | 25 Mpoint         |                                | 50 Mpoint         |                                |
|          | Sample Rate (S/s) | Display Record Length (Points) | Sample Rate (S/s) | Display Record Length (Points) | Sample Rate (S/s) | Display Record Length (Points) | Sample Rate (S/s) | Display Record Length (Points) | Sample Rate (S/s) | Display Record Length (Points) |
| 100 ns   | 100 M             | 100                            | 100 M             | 100                            | 100 M             | 100                            | 100 M             | 100                            | 100 M             | 100                            |
| 200 ns   | 100 M             | 200                            | 100 M             | 200                            | 100 M             | 200                            | 100 M             | 200                            | 100 M             | 200                            |
| 500 ns   | 100 M             | 500                            | 100 M             | 500                            | 100 M             | 500                            | 100 M             | 500                            | 100 M             | 500                            |
| 1 μs     | 100 M             | 1 k                            | 100 M             | 1 k                            | 100 M             | 1 k                            | 100 M             | 1 k                            | 100 M             | 1 k                            |
| 2 μs     | 100 M             | 2 k                            | 100 M             | 2 k                            | 100 M             | 2 k                            | 100 M             | 2 k                            | 100 M             | 2 k                            |
| 5 μs     | 100 M             | 5 k                            | 100 M             | 5 k                            | 100 M             | 5 k                            | 100 M             | 5 k                            | 100 M             | 5 k                            |
| 10 μs    | 100 M             | 10 k                           | 100 M             | 10 k                           | 100 M             | 10 k                           | 100 M             | 10 k                           | 100 M             | 10 k                           |
| 20 μs    | 100 M             | 20 k                           | 100 M             | 20 k                           | 100 M             | 20 k                           | 100 M             | 20 k                           | 100 M             | 20 k                           |
| 50 μs    | 100 M             | 50 k                           | 100 M             | 50 k                           | 100 M             | 50 k                           | 100 M             | 50 k                           | 100 M             | 50 k                           |
| 100 μs   | 100 M             | 100 k                          | 100 M             | 100 k                          | 100 M             | 100 k                          | 100 M             | 100 k                          | 100 M             | 100 k                          |
| 200 μs   | 100 M             | 200 k                          | 100 M             | 200 k                          | 100 M             | 200 k                          | 100 M             | 200 k                          | 100 M             | 200 k                          |
| 500 μs   | 100 M             | 500 k                          | 100 M             | 500 k                          | 100 M             | 500 k                          | 100 M             | 500 k                          | 100 M             | 500 k                          |
| 1 ms     | 100 M             | 1 M                            | 100 M             | 1 M                            | 100 M             | 1 M                            | 100 M             | 1 M                            | 100 M             | 1 M                            |
| 2 ms     | 100 M             | 2 M                            | 100 M             | 2 M                            | 100 M             | 2 M                            | 100 M             | 2 M                            | 100 M             | 2 M                            |
| 5 ms     | 50 M              | 2.5 M                          | 100 M             | 5 M                            | 100 M             | 5 M                            | 100 M             | 5 M                            | 100 M             | 5 M                            |
| 10 ms    | 20 M              | 2 M                            | 50 M              | 5 M                            | 100 M             | 10 M                           | 100 M             | 10 M                           | 100 M             | 10 M                           |
| 20 ms    | 10 M              | 2 M                            | 20 M              | 4 M                            | 50 M              | 10 M                           | 100 M             | 20 M                           | 100 M             | 20 M                           |
| 50 ms    | 5 M               | 2.5 M                          | 10 M              | 5 M                            | 20 M              | 10 M                           | 50 M              | 25 M                           | 100 M             | 50 M                           |
| 100 ms   | 2 M               | 2 M                            | 5 M               | 5 M                            | 10 M              | 10 M                           | 20 M              | 20 M                           | 50 M              | 50 M                           |
| 200 ms   | 1 M               | 2 M                            | 2 M               | 4 M                            | 5 M               | 10 M                           | 10 M              | 20 M                           | 20 M              | 40 M                           |
| 500 ms   | 500 k             | 2.5 M                          | 1 M               | 5 M                            | 2 M               | 10 M                           | 5 M               | 25 M                           | 10 M              | 50 M                           |
| 1 s      | 200 k             | 2 M                            | 500 k             | 5 M                            | 1 M               | 10 M                           | 2 M               | 20 M                           | 5 M               | 50 M                           |
| 2 s      | 100 k             | 2 M                            | 200 k             | 4 M                            | 500 k             | 10 M                           | 1 M               | 20 M                           | 2 M               | 40 M                           |
| 3 s      | 50 k              | 1.5 M                          | 100 k             | 3 M                            | 200 k             | 6 M                            | 500 k             | 15 M                           | 1 M               | 30 M                           |
| 4 s      | 50 k              | 2 M                            | 100 k             | 4 M                            | 200 k             | 8 M                            | 500 k             | 20 M                           | 1 M               | 40 M                           |
| 5 s      | 50 k              | 2.5 M                          | 100 k             | 5 M                            | 200 k             | 10 M                           | 500 k             | 25 M                           | 1 M               | 50 M                           |
| 6 s      | 20 k              | 1.2 M                          | 50 k              | 3 M                            | 100 k             | 6 M                            | 200 k             | 12 M                           | 500 k             | 30 M                           |
| 8 s      | 20 k              | 1.6 M                          | 50 k              | 4 M                            | 100 k             | 8 M                            | 200 k             | 16 M                           | 500 k             | 40 M                           |
| 10 s     | 20 k              | 2 M                            | 50 k              | 5 M                            | 100 k             | 10 M                           | 200 k             | 20 M                           | 500 k             | 50 M                           |
| 20 s     | 10 k              | 2 M                            | 20 k              | 4 M                            | 50 k              | 10 M                           | 100 k             | 20 M                           | 200 k             | 40 M                           |
| 30 s     | 5 k               | 1.5 M                          | 10 k              | 3 M                            | 20 k              | 6 M                            | 50 k              | 15 M                           | 100 k             | 30 M                           |
| 1 min    | 2 k               | 1.2 M                          | 5 k               | 3 M                            | 10 k              | 6 M                            | 20 k              | 12 M                           | 50 k              | 30 M                           |
| 2 min    | 2 k               | 2.4 M                          | 2 k               | 2.4 M                          | 5 k               | 6 M                            | 20 k              | 24 M                           | 20 k              | 24 M                           |
| 3 min    | 1 k               | 1.8 M                          | 2 k               | 3.6 M                          | 5 k               | 9 M                            | 10 k              | 18 M                           | 20 k              | 36 M                           |
| 4 min    | 1 k               | 2.4 M                          | 2 k               | 4.8 M                          | 2 k               | 4.8 M                          | 10 k              | 24 M                           | 20 k              | 48 M                           |
| 5 min    | 500               | 1.5 M                          | 1 k               | 3 M                            | 2 k               | 6 M                            | 5 k               | 15 M                           | 10 k              | 30 M                           |
| 6 min    | 500               | 1.8 M                          | 1 k               | 3.6 M                          | 2 k               | 7.2 M                          | 5 k               | 18 M                           | 10 k              | 36 M                           |
| 7 min    | 500               | 2.1 M                          | 1 k               | 4.2 M                          | 2 k               | 8.4 M                          | 5 k               | 21 M                           | 10 k              | 42 M                           |
| 8 min    | 500               | 2.4 M                          | 1 k               | 4.8 M                          | 2 k               | 9.6 M                          | 5 k               | 24 M                           | 10 k              | 48 M                           |
| 9 min    | 200               | 1.08 M                         | 500               | 2.7 M                          | 1 k               | 5.4 M                          | 2 k               | 10.8 M                         | 5 k               | 27 M                           |
| 10 min   | 200               | 1.2 M                          | 500               | 3 M                            | 1 k               | 6 M                            | 2 k               | 12 M                           | 5 k               | 30 M                           |
| 12 min   | 200               | 1.44 M                         | 500               | 3.6 M                          | 1 k               | 7.2 M                          | 2 k               | 14.4 M                         | 5 k               | 36 M                           |
| 15 min   | 200               | 1.8 M                          | 500               | 4.5 M                          | 1 k               | 9 M                            | 2 k               | 18 M                           | 5 k               | 45 M                           |
| 30 min   | 100               | 1.8 M                          | 200               | 3.6 M                          | 500               | 9 M                            | 1 k               | 18 M                           | 2 k               | 36 M                           |
| 1 h      | 50                | 1.8 M                          | 100               | 3.6 M                          | 200               | 7.2 M                          | 500               | 18 M                           | 1 k               | 36 M                           |
| 2 h      | 20                | 1.44 M                         | 50                | 3.6 M                          | 100               | 7.2 M                          | 200               | 14.4 M                         | 500               | 36 M                           |
| 3 h      | 20                | 2.16 M                         | 20                | 2.16 M                         | 50                | 5.4 M                          | 200               | 21.6 M                         | 200               | 21.6 M                         |
| 4 h      | 10                | 1.44 M                         | 20                | 2.88 M                         | 50                | 7.2 M                          | 100               | 14.4 M                         | 200               | 28.8 M                         |
| 5 h      | 10                | 1.8 M                          | 20                | 3.6 M                          | 50                | 9 M                            | 100               | 18 M                           | 200               | 36 M                           |

When the time axis setting is 100 ms or greater (the settings surrounded by bold lines) and the trigger mode is Auto or Auto Level, waveforms are displayed in roll mode.

(Continued on next page)

## Appendix 1 Relationship between the Time Axis Setting, Record Length, and Sample Rate

(Continued from previous page)

| Time/div | Record Length     |                                |                   |                                |                   |                                |                   |                                |                   |                                |
|----------|-------------------|--------------------------------|-------------------|--------------------------------|-------------------|--------------------------------|-------------------|--------------------------------|-------------------|--------------------------------|
|          | 2.5 Mpoint        |                                | 5 Mpoint          |                                | 10 Mpoint         |                                | 25 Mpoint         |                                | 50 Mpoint         |                                |
|          | Sample Rate (S/s) | Display Record Length (Points) | Sample Rate (S/s) | Display Record Length (Points) | Sample Rate (S/s) | Display Record Length (Points) | Sample Rate (S/s) | Display Record Length (Points) | Sample Rate (S/s) | Display Record Length (Points) |
| 6 h      | 10                | 2.16 M                         | 20                | 4.32 M                         | 20                | 4.32 M                         | 100               | 21.6 M                         | 200               | 43.2 M                         |
| 7 h      | 5                 | 1.26 M                         | 10                | 2.52 M                         | 20                | 5.04 M                         | 50                | 12.6 M                         | 100               | 25.2 M                         |
| 8 h      | 5                 | 1.44 M                         | 10                | 2.88 M                         | 20                | 5.76 M                         | 50                | 14.4 M                         | 100               | 28.8 M                         |
| 9 h      | 5                 | 1.62 M                         | 10                | 3.24 M                         | 20                | 6.48 M                         | 50                | 16.2 M                         | 100               | 32.4 M                         |
| 10 h     | 5                 | 1.8 M                          | 10                | 3.6 M                          | 20                | 7.2 M                          | 50                | 18 M                           | 100               | 36 M                           |
| 12 h     | 5                 | 2.16 M                         | 10                | 4.32 M                         | 20                | 8.64 M                         | 50                | 21.6 M                         | 100               | 43.2 M                         |
| 1 day    |                   |                                | 5                 | 4.32 M                         | 10                | 8.64 M                         | 20                | 17.28 M                        | 50                | 43.2 M                         |
| 2 days   |                   |                                |                   |                                | 5                 | 8.64 M                         | 10                | 17.28 M                        | 20                | 34.56 M                        |
| 3 days   |                   |                                |                   |                                |                   |                                | 5                 | 12.96 M                        | 10                | 25.92 M                        |
| 4 days   |                   |                                |                   |                                |                   |                                | 5                 | 17.28M                         | 10                | 34.56M                         |
| 5 days   |                   |                                |                   |                                |                   |                                | 5                 | 21.6M                          | 10                | 43.2M                          |
| 6 days   |                   |                                |                   |                                |                   |                                |                   |                                | 5                 | 25.92M                         |
| 8 days   |                   |                                |                   |                                |                   |                                |                   |                                | 5                 | 34.56M                         |
| 10 days  |                   |                                |                   |                                |                   |                                |                   |                                | 5                 | 43.2M                          |

When the time axis setting is 100 ms or greater (the settings surrounded by bold lines) and the trigger mode is Auto or Auto Level, waveforms are displayed in roll mode.

### When the Record Length Is 100 Mpoint, 250 Mpoint, 500 Mpoint, 1 Gpoint, or 2 Gpoint

| Time/div | Record Length     |                                |                   |                                |                   |                                |                   |                                |                   |                                |
|----------|-------------------|--------------------------------|-------------------|--------------------------------|-------------------|--------------------------------|-------------------|--------------------------------|-------------------|--------------------------------|
|          | 100 Mpoint        |                                | 250 Mpoint        |                                | 500 Mpoint        |                                | 1 Gpoint          |                                | 2 Gpoint          |                                |
|          | Sample Rate (S/s) | Display Record Length (Points) | Sample Rate (S/s) | Display Record Length (Points) | Sample Rate (S/s) | Display Record Length (Points) | Sample Rate (S/s) | Display Record Length (Points) | Sample Rate (S/s) | Display Record Length (Points) |
| 100 ns   | 100 M             | 100                            | 100 M             | 100                            | 100 M             | 100                            | 100 M             | 100                            | 100 M             | 100                            |
| 200 ns   | 100 M             | 200                            | 100 M             | 200                            | 100 M             | 200                            | 100 M             | 200                            | 100 M             | 200                            |
| 500 ns   | 100 M             | 500                            | 100 M             | 500                            | 100 M             | 500                            | 100 M             | 500                            | 100 M             | 500                            |
| 1 μs     | 100 M             | 1 k                            | 100 M             | 1 k                            | 100 M             | 1 k                            | 100 M             | 1 k                            | 100 M             | 1 k                            |
| 2 μs     | 100 M             | 2 k                            | 100 M             | 2 k                            | 100 M             | 2 k                            | 100 M             | 2 k                            | 100 M             | 2 k                            |
| 5 μs     | 100 M             | 5 k                            | 100 M             | 5 k                            | 100 M             | 5 k                            | 100 M             | 5 k                            | 100 M             | 5 k                            |
| 10 μs    | 100 M             | 10 k                           | 100 M             | 10 k                           | 100 M             | 10 k                           | 100 M             | 10 k                           | 100 M             | 10 k                           |
| 20 μs    | 100 M             | 20 k                           | 100 M             | 20 k                           | 100 M             | 20 k                           | 100 M             | 20 k                           | 100 M             | 20 k                           |
| 50 μs    | 100 M             | 50 k                           | 100 M             | 50 k                           | 100 M             | 50 k                           | 100 M             | 50 k                           | 100 M             | 50 k                           |
| 100 μs   | 100 M             | 100 k                          | 100 M             | 100 k                          | 100 M             | 100 k                          | 100 M             | 100 k                          | 100 M             | 100 k                          |
| 200 μs   | 100 M             | 200 k                          | 100 M             | 200 k                          | 100 M             | 200 k                          | 100 M             | 200 k                          | 100 M             | 200 k                          |
| 500 μs   | 100 M             | 500 k                          | 100 M             | 500 k                          | 100 M             | 500 k                          | 100 M             | 500 k                          | 100 M             | 500 k                          |
| 1 ms     | 100 M             | 1 M                            | 100 M             | 1 M                            | 100 M             | 1 M                            | 100 M             | 1 M                            | 100 M             | 1 M                            |
| 2 ms     | 100 M             | 2 M                            | 100 M             | 2 M                            | 100 M             | 2 M                            | 100 M             | 2 M                            | 100 M             | 2 M                            |
| 5 ms     | 100 M             | 5 M                            | 100 M             | 5 M                            | 100 M             | 5 M                            | 100 M             | 5 M                            | 100 M             | 5 M                            |
| 10 ms    | 100 M             | 10 M                           | 100 M             | 10 M                           | 100 M             | 10 M                           | 100 M             | 10 M                           | 100 M             | 10 M                           |
| 20 ms    | 100 M             | 20 M                           | 100 M             | 20 M                           | 100 M             | 20 M                           | 100 M             | 20 M                           | 100 M             | 20 M                           |
| 50 ms    | 100 M             | 50 M                           | 100 M             | 50 M                           | 100 M             | 50 M                           | 100 M             | 50 M                           | 100 M             | 50 M                           |
| 100 ms   | 100 M             | 100 M                          | 100 M             | 100 M                          | 100 M             | 100 M                          | 100 M             | 100 M                          | 100 M             | 100 M                          |
| 200 ms   | 50 M              | 100 M                          | 100 M             | 200 M                          | 100 M             | 200 M                          | 100 M             | 200 M                          | 100 M             | 200 M                          |
| 500 ms   | 20 M              | 100 M                          | 50 M              | 250 M                          | 100 M             | 500 M                          | 100 M             | 500 M                          | 100 M             | 500 M                          |
| 1 s      | 10 M              | 100 M                          | 20 M              | 200 M                          | 50 M              | 500 M                          | 100 M             | 1 G                            | 100 M             | 1 G                            |
| 2 s      | 5 M               | 100 M                          | 10 M              | 200 M                          | 20 M              | 400 M                          | 50 M              | 1 G                            | 100 M             | 2 G                            |
| 3 s      | 2 M               | 60 M                           | 5 M               | 150 M                          | 10 M              | 300 M                          | 20 M              | 600 M                          | 50 M              | 1.5 G                          |
| 4 s      | 2 M               | 80 M                           | 5 M               | 200 M                          | 10 M              | 400 M                          | 20 M              | 800 M                          | 50 M              | 2 G                            |
| 5 s      | 2 M               | 100 M                          | 5 M               | 250 M                          | 10 M              | 500 M                          | 20 M              | 1 G                            | 20 M              | 1 G                            |

When the time axis setting is 100 ms or greater (the settings surrounded by bold lines) and the trigger mode is Auto or Auto Level, waveforms are displayed in roll mode.

(Continued on next page)

## Appendix 1 Relationship between the Time Axis Setting, Record Length, and Sample Rate

(Continued from previous page)

| Time/div | Record Length     |                                |                   |                                |                   |                                |                   |                                |                   |                                |
|----------|-------------------|--------------------------------|-------------------|--------------------------------|-------------------|--------------------------------|-------------------|--------------------------------|-------------------|--------------------------------|
|          | 100 Mpoint        |                                | 250 Mpoint        |                                | 500 Mpoint        |                                | 1 Gpoint          |                                | 2 Gpoint          |                                |
|          | Sample Rate (S/s) | Display Record Length (Points) | Sample Rate (S/s) | Display Record Length (Points) | Sample Rate (S/s) | Display Record Length (Points) | Sample Rate (S/s) | Display Record Length (Points) | Sample Rate (S/s) | Display Record Length (Points) |
| 6 s      | 1 M               | 60 M                           | 2 M               | 120 M                          | 5 M               | 300 M                          | 10 M              | 600 M                          | 20 M              | 1.2 G                          |
| 8 s      | 1 M               | 80 M                           | 2 M               | 160 M                          | 5 M               | 400 M                          | 10 M              | 800 M                          | 20 M              | 1.6 G                          |
| 10 s     | 1 M               | 100 M                          | 2 M               | 200 M                          | 5 M               | 500 M                          | 10 M              | 1 G                            | 20 M              | 2 G                            |
| 20 s     | 500 k             | 100 M                          | 1 M               | 200 M                          | 2 M               | 400 M                          | 5 M               | 1 G                            | 10 M              | 2 G                            |
| 30 s     | 200 k             | 60 M                           | 500 k             | 150 M                          | 1 M               | 300 M                          | 2 M               | 600 M                          | 5 M               | 1.5 G                          |
| 1 min    | 100 k             | 60 M                           | 200 k             | 120 M                          | 500 k             | 300 M                          | 1 M               | 600 M                          | 2 M               | 1.2 G                          |
| 2 min    | 50 k              | 60 M                           | 200 k             | 240 M                          | 200 k             | 240 M                          | 500 k             | 600 M                          | 1 M               | 1.2 G                          |
| 3 min    | 50 k              | 90 M                           | 100 k             | 180 M                          | 200 k             | 360 M                          | 500 k             | 900 M                          | 1 M               | 1.8 G                          |
| 4 min    | 20 k              | 48 M                           | 100 k             | 240 M                          | 200 k             | 480 M                          | 200 k             | 480 M                          | 500 k             | 1.2 G                          |
| 5 min    | 20 k              | 60 M                           | 50 k              | 150 M                          | 100 k             | 300 M                          | 200 k             | 600 M                          | 500 k             | 1.5 G                          |
| 6 min    | 20 k              | 72 M                           | 50 k              | 180 M                          | 100 k             | 360 M                          | 200 k             | 720 M                          | 500 k             | 1.8 G                          |
| 7 min    | 20 k              | 84 M                           | 50 k              | 210 M                          | 100 k             | 420 M                          | 200 k             | 840 M                          | 200 k             | 840 M                          |
| 8 min    | 20 k              | 96 M                           | 50 k              | 240 M                          | 100 k             | 480 M                          | 200 k             | 960 M                          | 200 k             | 960 M                          |
| 9 min    | 10 k              | 54 M                           | 20 k              | 108 M                          | 50 k              | 270 M                          | 100 k             | 540 M                          | 200 k             | 1.08 G                         |
| 10 min   | 10 k              | 60 M                           | 20 k              | 120 M                          | 50 k              | 300 M                          | 100 k             | 600 M                          | 200 k             | 1.2 G                          |
| 12 min   | 10 k              | 72 M                           | 20 k              | 144 M                          | 50 k              | 360 M                          | 100 k             | 720 M                          | 200 k             | 1.44 G                         |
| 15 min   | 10 k              | 90 M                           | 20 k              | 180 M                          | 50 k              | 450 M                          | 100 k             | 900 M                          | 200 k             | 1.8 G                          |
| 30 min   | 5 k               | 90 M                           | 10 k              | 180 M                          | 20 k              | 360 M                          | 50 k              | 900 M                          | 100 k             | 1.8 G                          |
| 1 h      | 2 k               | 72 M                           | 5 k               | 180 M                          | 10 k              | 360 M                          | 20 k              | 720 M                          | 50 k              | 1.8 G                          |
| 2 h      | 1 k               | 72 M                           | 2 k               | 144 M                          | 5 k               | 360 M                          | 10 k              | 720 M                          | 20 k              | 1.44 G                         |
| 3 h      | 500               | 54 M                           | 2 k               | 144 M                          | 2 k               | 216 M                          | 5 k               | 540 M                          | 10 k              | 1.08 G                         |
| 4 h      | 500               | 72 M                           | 1 k               | 144 M                          | 2 k               | 288 M                          | 5 k               | 720 M                          | 10 k              | 1.44 G                         |
| 5 h      | 500               | 90 M                           | 1 k               | 180 M                          | 2 k               | 360 M                          | 5 k               | 900 M                          | 10 k              | 1.8 G                          |
| 6 h      | 200               | 43.2 M                         | 1 k               | 216 M                          | 2 k               | 432 M                          | 2 k               | 432 M                          | 5 k               | 1.08 G                         |
| 7 h      | 200               | 50.4 M                         | 500               | 126 M                          | 1 k               | 252 M                          | 2 k               | 504 M                          | 5 k               | 1.26 G                         |
| 8 h      | 200               | 57.6 M                         | 500               | 144 M                          | 1 k               | 288 M                          | 2 k               | 576 M                          | 5 k               | 1.44 G                         |
| 9 h      | 200               | 64.8 M                         | 500               | 162 M                          | 1 k               | 324 M                          | 2 k               | 648 M                          | 5 k               | 1.62 G                         |
| 10 h     | 200               | 72 M                           | 500               | 180 M                          | 1 k               | 360 M                          | 2 k               | 720 M                          | 5 k               | 1.8 G                          |
| 12 h     | 200               | 86.4 M                         | 500               | 216 M                          | 1 k               | 432 M                          | 2 k               | 864 M                          | 2 k               | 864 M                          |
| 1 day    | 100               | 86.4 M                         | 200               | 172.8 M                        | 500               | 432 M                          | 1 k               | 864 M                          | 2 k               | 1.728 G                        |
| 2 days   | 50                | 86.4 M                         | 100               | 172.8 M                        | 200               | 345.6 M                        | 500               | 864 M                          | 1 k               | 1.728 G                        |
| 3 days   | 20                | 51.84 M                        | 50                | 129.6 M                        | 100               | 259.2 M                        | 200               | 518.4 M                        | 500               | 1.296 G                        |
| 4 days   | 20                | 69.12M                         | 50                | 172.8M                         | 100               | 345.6M                         | 200               | 691.2M                         | 500               | 1.728G                         |
| 5 days   | 20                | 86.4M                          | 50                | 216M                           | 100               | 432M                           | 200               | 864M                           | 200               | 864M                           |
| 6 days   | 10                | 51.84M                         | 20                | 103.68M                        | 50                | 259.2M                         | 100               | 518.4M                         | 200               | 1.0368G                        |
| 8 days   | 10                | 69.12M                         | 20                | 138.24M                        | 50                | 345.6M                         | 100               | 691.2M                         | 200               | 1.3824G                        |
| 10 days  | 10                | 86.4M                          | 20                | 172.8M                         | 50                | 432M                           | 100               | 864M                           | 200               | 1.728G                         |
| 20 days  | 5                 | 86.4M                          | 10                | 172.8M                         | 20                | 345.6M                         | 50                | 864M                           | 100               | 1.728G                         |

When the time axis setting is 100 ms or greater (the settings surrounded by bold lines) and the trigger mode is Auto or Auto Level, waveforms are displayed in roll mode.

Appendix 1 Relationship between the Time Axis Setting, Record Length, and Sample Rate

When the Record Length Is 4 Gpoint, 5 Gpoint, 10 Gpoint, 20 Gpoint, or 50 Gpoint

| Time/div | Record Length     |                                |                   |                                |                   |                                |                   |                                |                   |                                |
|----------|-------------------|--------------------------------|-------------------|--------------------------------|-------------------|--------------------------------|-------------------|--------------------------------|-------------------|--------------------------------|
|          | 4 Gpoint          |                                | 5 Gpoint          |                                | 10 Gpoint         |                                | 20 Gpoint         |                                | 50 Gpoint         |                                |
|          | Sample Rate (S/s) | Display Record Length (Points) | Sample Rate (S/s) | Display Record Length (Points) | Sample Rate (S/s) | Display Record Length (Points) | Sample Rate (S/s) | Display Record Length (Points) | Sample Rate (S/s) | Display Record Length (Points) |
| 100 ns   |                   |                                |                   |                                |                   |                                |                   |                                |                   |                                |
| 200 ns   |                   |                                |                   |                                |                   |                                |                   |                                |                   |                                |
| 500 ns   |                   |                                |                   |                                |                   |                                |                   |                                |                   |                                |
| 1 µs     |                   |                                |                   |                                |                   |                                |                   |                                |                   |                                |
| 2 µs     |                   |                                |                   |                                |                   |                                |                   |                                |                   |                                |
| 5 µs     |                   |                                |                   |                                |                   |                                |                   |                                |                   |                                |
| 10 µs    |                   |                                |                   |                                |                   |                                |                   |                                |                   |                                |
| 20 µs    |                   |                                |                   |                                |                   |                                |                   |                                |                   |                                |
| 50 µs    |                   |                                |                   |                                |                   |                                |                   |                                |                   |                                |
| 100 µs   |                   |                                |                   |                                |                   |                                |                   |                                |                   |                                |
| 200 µs   |                   |                                |                   |                                |                   |                                |                   |                                |                   |                                |
| 500 µs   |                   |                                |                   |                                |                   |                                |                   |                                |                   |                                |
| 1 ms     |                   |                                |                   |                                |                   |                                |                   |                                |                   |                                |
| 2 ms     |                   |                                |                   |                                |                   |                                |                   |                                |                   |                                |
| 5 ms     |                   |                                |                   |                                |                   |                                |                   |                                |                   |                                |
| 10 ms    |                   |                                |                   |                                |                   |                                |                   |                                |                   |                                |
| 20 ms    |                   |                                |                   |                                |                   |                                |                   |                                |                   |                                |
| 50 ms    |                   |                                |                   |                                |                   |                                |                   |                                |                   |                                |
| 100 ms   |                   |                                |                   |                                |                   |                                |                   |                                |                   |                                |
| 200 ms   |                   |                                |                   |                                |                   |                                |                   |                                |                   |                                |
| 500 ms   |                   |                                |                   |                                |                   |                                |                   |                                |                   |                                |
| 1 s      |                   |                                |                   |                                |                   |                                |                   |                                |                   |                                |
| 2 s      |                   |                                |                   |                                |                   |                                |                   |                                |                   |                                |
| 3 s      |                   |                                |                   |                                |                   |                                |                   |                                |                   |                                |
| 4 s      |                   |                                |                   |                                |                   |                                |                   |                                |                   |                                |
| 5 s      |                   |                                |                   |                                |                   |                                |                   |                                |                   |                                |
| 6 s      |                   |                                |                   |                                |                   |                                |                   |                                |                   |                                |
| 8 s      |                   |                                |                   |                                |                   |                                |                   |                                |                   |                                |
| 10 s     |                   |                                |                   |                                |                   |                                |                   |                                |                   |                                |
| 20 s     |                   |                                |                   |                                |                   |                                |                   |                                |                   |                                |
| 30 s     |                   |                                |                   |                                |                   |                                |                   |                                |                   |                                |
| 1 min    |                   |                                |                   |                                |                   |                                |                   |                                |                   |                                |
| 2 min    |                   |                                |                   |                                |                   |                                |                   |                                |                   |                                |
| 3 min    |                   |                                |                   |                                |                   |                                |                   |                                |                   |                                |
| 4 min    | 1 M               | 2.4 G                          |                   |                                |                   |                                |                   |                                |                   |                                |
| 5 min    | 1 M               | 3 G                            | 1 M               | 3 G                            |                   |                                |                   |                                |                   |                                |
| 6 min    | 1 M               | 3.6 G                          | 1 M               | 3.6 G                          |                   |                                |                   |                                |                   |                                |
| 7 min    | 500 k             | 2.1 G                          | 1 M               | 4.2 G                          |                   |                                |                   |                                |                   |                                |
| 8 min    | 500 k             | 2.4 G                          | 1 M               | 4.8 G                          |                   |                                |                   |                                |                   |                                |
| 9 min    | 500 k             | 2.7 G                          | 500 k             | 2.7 G                          | 1 M               | 5.4 G                          |                   |                                |                   |                                |
| 10 min   | 500 k             | 3 G                            | 500 k             | 3 G                            | 1 M               | 6 G                            |                   |                                |                   |                                |
| 12 min   | 500 k             | 3.6 G                          | 500 k             | 3.6 G                          | 1 M               | 7.2 G                          |                   |                                |                   |                                |
| 15 min   | 200 k             | 1.8 G                          | 500 k             | 4.5 G                          | 1 M               | 9 G                            |                   |                                |                   |                                |
| 30 min   | 200 k             | 3.6 G                          | 200 k             | 3.6 G                          | 500 k             | 9 G                            | 1 M               | 18 G                           |                   |                                |
| 1 h      | 100 k             | 3.6 G                          | 100 k             | 3.6 G                          | 200 k             | 7.2 G                          | 500 k             | 18 G                           | 1 M               | 36 G                           |
| 2 h      | 50 k              | 3.6 G                          | 50 k              | 3.6 G                          | 100 k             | 7.2 G                          | 200 k             | 14.4 G                         | 500 k             | 36 G                           |
| 3 h      | 20 k              | 2.16 G                         | 20 k              | 2.16 G                         | 50 k              | 5.4 G                          | 100 k             | 10.8 G                         | 200 k             | 21.6 G                         |
| 4 h      | 20 k              | 2.88 G                         | 20 k              | 2.88 G                         | 50 k              | 7.2 G                          | 100 k             | 14.4 G                         | 200 k             | 28.8 G                         |
| 5 h      | 20 k              | 3.6 G                          | 20 k              | 3.6 G                          | 50 k              | 9 G                            | 100 k             | 18 G                           | 200 k             | 36 G                           |

When the time axis setting is 100 ms or greater (the settings surrounded by bold lines) and the trigger mode is Auto or Auto Level, waveforms are displayed in roll mode.

(Continued on next page)

## Appendix 1 Relationship between the Time Axis Setting, Record Length, and Sample Rate

(Continued from previous page)

| Time/div | Record Length     |                                |                   |                                |                   |                                |                   |                                |                   |                                |
|----------|-------------------|--------------------------------|-------------------|--------------------------------|-------------------|--------------------------------|-------------------|--------------------------------|-------------------|--------------------------------|
|          | 4 Gpoint          |                                | 5 Gpoint          |                                | 10 Gpoint         |                                | 20 Gpoint         |                                | 50 Gpoint         |                                |
|          | Sample Rate (S/s) | Display Record Length (Points) | Sample Rate (S/s) | Display Record Length (Points) | Sample Rate (S/s) | Display Record Length (Points) | Sample Rate (S/s) | Display Record Length (Points) | Sample Rate (S/s) | Display Record Length (Points) |
| 6 h      | 10 k              | 2.16 G                         | 20 k              | 4.32 G                         | 20 k              | 4.32 G                         | 50 k              | 10.8 G                         | 200 k             | 43.2 G                         |
| 7 h      | 10 k              | 2.52 G                         | 10 k              | 2.52 G                         | 20 k              | 5.04 G                         | 50 k              | 12.6 G                         | 100 k             | 25.2 G                         |
| 8 h      | 10 k              | 2.88 G                         | 10 k              | 2.88 G                         | 20 k              | 5.76 G                         | 50 k              | 14.4 G                         | 100 k             | 28.8 G                         |
| 9 h      | 10 k              | 3.24 G                         | 10 k              | 3.24 G                         | 20 k              | 6.48 G                         | 50 k              | 16.2 G                         | 100 k             | 32.4 G                         |
| 10 h     | 10 k              | 3.6 G                          | 10 k              | 3.6 G                          | 20 k              | 7.2 G                          | 50 k              | 18 G                           | 100 k             | 36 G                           |
| 12 h     | 5 k               | 2.16 G                         | 10 k              | 4.32 G                         | 20 k              | 8.64 G                         | 20 k              | 8.64 G                         | 100 k             | 43.2 G                         |
| 1 day    | 2 k               | 1.728 G                        | 5 k               | 4.32 G                         | 10 k              | 8.64 G                         | 20 k              | 17.28 G                        | 50 k              | 43.2 G                         |
| 2 days   | 2 k               | 3.456 G                        | 2 k               | 3.456 G                        | 5 k               | 8.64 G                         | 10 k              | 17.28 G                        | 20 k              | 34.56 G                        |
| 3 days   | 1 k               | 2.592 G                        | 1 k               | 2.592 G                        | 2 k               | 5.184 G                        | 5 k               | 12.96 G                        | 10 k              | 25.9 G                         |
| 4 days   | 1 k               | 3.456G                         | 1 k               | 3.456G                         | 2 k               | 6.912G                         | 5 k               | 17.28G                         | 10 k              | 34.56G                         |
| 5 days   | 500               | 2.16G                          | 1 k               | 4.32G                          | 2 k               | 8.64G                          | 2 k               | 8.64G                          | 10 k              | 43.2G                          |
| 6 days   | 500               | 2.592G                         | 500               | 2.592G                         | 1 k               | 5.184G                         | 2 k               | 10.368G                        | 5 k               | 25.92G                         |
| 8 days   | 500               | 3.456G                         | 500               | 3.456G                         | 1 k               | 6.912G                         | 2 k               | 13.824G                        | 5 k               | 34.56G                         |
| 10 days  | 200               | 1.728G                         | 500               | 4.32G                          | 1 k               | 8.64G                          | 2 k               | 17.28G                         | 5 k               | 43.2G                          |
| 20 days  | 200               | 3.456G                         | 200               | 3.456G                         | 500               | 8.64G                          | 1 k               | 17.28G                         | 2 k               | 34.56G                         |

When the time axis setting is 100 ms or greater (the settings surrounded by bold lines) and the trigger mode is Auto or Auto Level, waveforms are displayed in roll mode.

## When the High-Speed 100 MS/s, 12-Bit Isolation Module Is Not Installed

When the Record Length Is 1 kpoint, 2.5 kpoint, 5 kpoint, 10 kpoint, or 25 kpoint

| Time/div | Record Length     |                                |                   |                                |                   |                                |                   |                                |                   |                                |
|----------|-------------------|--------------------------------|-------------------|--------------------------------|-------------------|--------------------------------|-------------------|--------------------------------|-------------------|--------------------------------|
|          | 1 kpoint          |                                | 2.5 kpoint        |                                | 5 kpoint          |                                | 10 kpoint         |                                | 25 kpoint         |                                |
|          | Sample Rate (S/s) | Display Record Length (Points) | Sample Rate (S/s) | Display Record Length (Points) | Sample Rate (S/s) | Display Record Length (Points) | Sample Rate (S/s) | Display Record Length (Points) | Sample Rate (S/s) | Display Record Length (Points) |
| 1 µs     | 10 M              | 100                            | 10 M              | 100                            | 10 M              | 100                            | 10 M              | 100                            | 10 M              | 100                            |
| 2 µs     | 10 M              | 200                            | 10 M              | 200                            | 10 M              | 200                            | 10 M              | 200                            | 10 M              | 200                            |
| 5 µs     | 10 M              | 500                            | 10 M              | 500                            | 10 M              | 500                            | 10 M              | 500                            | 10 M              | 500                            |
| 10 µs    | 10 M              | 1 k                            | 10 M              | 1 k                            | 10 M              | 1 k                            | 10 M              | 1 k                            | 10 M              | 1 k                            |
| 20 µs    | 5 M               | 1 k                            | 10 M              | 2 k                            | 10 M              | 2 k                            | 10 M              | 2 k                            | 10 M              | 2 k                            |
| 50 µs    | 2 M               | 1 k                            | 5 M               | 2.5 k                          | 10 M              | 5 k                            | 10 M              | 5 k                            | 10 M              | 5 k                            |
| 100 µs   | 1 M               | 1 k                            | 2 M               | 2 k                            | 5 M               | 5 k                            | 10 M              | 10 k                           | 10 M              | 10 k                           |
| 200 µs   | 500 k             | 1 k                            | 1 M               | 2 k                            | 2 M               | 4 k                            | 5 M               | 10 k                           | 10 M              | 20 k                           |
| 500 µs   | 200 k             | 1 k                            | 500 k             | 2.5 k                          | 1 M               | 5 k                            | 2 M               | 10 k                           | 5 M               | 25 k                           |
| 1 ms     | 100 k             | 1 k                            | 200 k             | 2 k                            | 500 k             | 5 k                            | 1 M               | 10 k                           | 2 M               | 20 k                           |
| 2 ms     | 50 k              | 1 k                            | 100 k             | 2 k                            | 200 k             | 4 k                            | 500 k             | 10 k                           | 1 M               | 20 k                           |
| 5 ms     | 20 k              | 1 k                            | 50 k              | 2.5 k                          | 100 k             | 5 k                            | 200 k             | 10 k                           | 500 k             | 25 k                           |
| 10 ms    | 10 k              | 1 k                            | 20 k              | 2 k                            | 50 k              | 5 k                            | 100 k             | 10 k                           | 200 k             | 20 k                           |
| 20 ms    | 5 k               | 1 k                            | 10 k              | 2 k                            | 20 k              | 4 k                            | 50 k              | 10 k                           | 100 k             | 20 k                           |
| 50 ms    | 2 k               | 1 k                            | 5 k               | 2.5 k                          | 10 k              | 5 k                            | 20 k              | 10 k                           | 50 k              | 25 k                           |
| 100 ms   | 1 k               | 1 k                            | 2 k               | 2 k                            | 5 k               | 5 k                            | 10 k              | 10 k                           | 20 k              | 20 k                           |
| 200 ms   | 500               | 1 k                            | 1 k               | 2 k                            | 2 k               | 4 k                            | 5 k               | 10 k                           | 10 k              | 20 k                           |
| 500 ms   | 200               | 1 k                            | 500               | 2.5 k                          | 1 k               | 5 k                            | 2 k               | 10 k                           | 5 k               | 25 k                           |
| 1 s      | 100               | 1 k                            | 200               | 2 k                            | 500               | 5 k                            | 1 k               | 10 k                           | 2 k               | 20 k                           |
| 2 s      | 50                | 1 k                            | 100               | 2 k                            | 200               | 4 k                            | 500               | 10 k                           | 1 k               | 20 k                           |
| 3 s      | 20                | 600                            | 50                | 1.5 k                          | 100               | 3 k                            | 200               | 6 k                            | 500               | 15 k                           |
| 4 s      | 20                | 800                            | 50                | 2 k                            | 100               | 4 k                            | 200               | 8 k                            | 500               | 20 k                           |
| 5 s      | 20                | 1 k                            | 50                | 2.5 k                          | 100               | 5 k                            | 200               | 10 k                           | 500               | 25 k                           |
| 6 s      | 10                | 600                            | 20                | 1.2 k                          | 50                | 3 k                            | 100               | 6 k                            | 200               | 12 k                           |
| 8 s      | 10                | 800                            | 20                | 1.6 k                          | 50                | 4 k                            | 100               | 8 k                            | 200               | 16 k                           |
| 10 s     | 10                | 1 k                            | 20                | 2 k                            | 50                | 5 k                            | 100               | 10 k                           | 200               | 20 k                           |
| 20 s     | 5                 | 1 k                            | 10                | 2 k                            | 20                | 4 k                            | 50                | 10 k                           | 100               | 20 k                           |
| 30 s     |                   |                                | 5                 | 1.5 k                          | 10                | 3 k                            | 20                | 6 k                            | 50                | 15 k                           |
| 1 min    |                   |                                |                   |                                | 5                 | 3 k                            | 10                | 6 k                            | 20                | 12 k                           |
| 2 min    |                   |                                |                   |                                |                   |                                | 5                 | 6 k                            | 20                | 24 k                           |
| 3 min    |                   |                                |                   |                                |                   |                                | 5                 | 9 k                            | 10                | 18 k                           |
| 4 min    |                   |                                |                   |                                |                   |                                |                   |                                | 10                | 24 k                           |
| 5 min    |                   |                                |                   |                                |                   |                                |                   |                                | 5                 | 15 k                           |
| 6 min    |                   |                                |                   |                                |                   |                                |                   |                                | 5                 | 18 k                           |
| 7 min    |                   |                                |                   |                                |                   |                                |                   |                                | 5                 | 21 k                           |

When the time axis setting is 100 ms or greater (the settings surrounded by bold lines) and the trigger mode is Auto or Auto Level, waveforms are displayed in roll mode.

When the Record Length Is 50 kpoint, 100 kpoint, 250 kpoint, 500 kpoint, or 1 Mpoint

| Time/div | Record Length     |                                |                   |                                |                   |                                |                   |                                |                   |                                |
|----------|-------------------|--------------------------------|-------------------|--------------------------------|-------------------|--------------------------------|-------------------|--------------------------------|-------------------|--------------------------------|
|          | 50 kpoint         |                                | 100 kpoint        |                                | 250 kpoint        |                                | 500 kpoint        |                                | 1 Mpoint          |                                |
|          | Sample Rate (S/s) | Display Record Length (Points) | Sample Rate (S/s) | Display Record Length (Points) | Sample Rate (S/s) | Display Record Length (Points) | Sample Rate (S/s) | Display Record Length (Points) | Sample Rate (S/s) | Display Record Length (Points) |
| 1 μs     | 10 M              | 100                            | 10 M              | 100                            | 10 M              | 100                            | 10 M              | 100                            | 10 M              | 100                            |
| 2 μs     | 10 M              | 200                            | 10 M              | 200                            | 10 M              | 200                            | 10 M              | 200                            | 10 M              | 200                            |
| 5 μs     | 10 M              | 500                            | 10 M              | 500                            | 10 M              | 500                            | 10 M              | 500                            | 10 M              | 500                            |
| 10 μs    | 10 M              | 1 k                            | 10 M              | 1 k                            | 10 M              | 1 k                            | 10 M              | 1 k                            | 10 M              | 1 k                            |
| 20 μs    | 10 M              | 2 k                            | 10 M              | 2 k                            | 10 M              | 2 k                            | 10 M              | 2 k                            | 10 M              | 2 k                            |
| 50 μs    | 10 M              | 5 k                            | 10 M              | 5 k                            | 10 M              | 5 k                            | 10 M              | 5 k                            | 10 M              | 5 k                            |
| 100 μs   | 10 M              | 10 k                           | 10 M              | 10 k                           | 10 M              | 10 k                           | 10 M              | 10 k                           | 10 M              | 10 k                           |
| 200 μs   | 10 M              | 20 k                           | 10 M              | 20 k                           | 10 M              | 20 k                           | 10 M              | 20 k                           | 10 M              | 20 k                           |
| 500 μs   | 10 M              | 50 k                           | 10 M              | 50 k                           | 10 M              | 50 k                           | 10 M              | 50 k                           | 10 M              | 50 k                           |
| 1 ms     | 5 M               | 50 k                           | 10 M              | 100 k                          | 10 M              | 100 k                          | 10 M              | 100 k                          | 10 M              | 100 k                          |
| 2 ms     | 2 M               | 40 k                           | 5 M               | 100 k                          | 10 M              | 200 k                          | 10 M              | 200 k                          | 10 M              | 200 k                          |
| 5 ms     | 1 M               | 50 k                           | 2 M               | 100 k                          | 5 M               | 250 k                          | 10 M              | 500 k                          | 10 M              | 500 k                          |
| 10 ms    | 500 k             | 50 k                           | 1 M               | 100 k                          | 2 M               | 200 k                          | 5 M               | 500 k                          | 10 M              | 1 M                            |
| 20 ms    | 200 k             | 40 k                           | 500 k             | 100 k                          | 1 M               | 200 k                          | 2 M               | 400 k                          | 5 M               | 1 M                            |
| 50 ms    | 100 k             | 50 k                           | 200 k             | 100 k                          | 500 k             | 250 k                          | 1 M               | 500 k                          | 2 M               | 1 M                            |
| 100 ms   | 50 k              | 50 k                           | 100 k             | 100 k                          | 200 k             | 200 k                          | 500 k             | 500 k                          | 1 M               | 1 M                            |
| 200 ms   | 20 k              | 40 k                           | 50 k              | 100 k                          | 100 k             | 200 k                          | 200 k             | 400 k                          | 500 k             | 1 M                            |
| 500 ms   | 10 k              | 50 k                           | 20 k              | 100 k                          | 50 k              | 250 k                          | 100 k             | 500 k                          | 200 k             | 1 M                            |
| 1 s      | 5 k               | 50 k                           | 10 k              | 100 k                          | 20 k              | 200 k                          | 50 k              | 500 k                          | 100 k             | 1 M                            |
| 2 s      | 2 k               | 40 k                           | 5 k               | 100 k                          | 10 k              | 200 k                          | 20 k              | 400 k                          | 50 k              | 1 M                            |
| 3 s      | 1 k               | 30 k                           | 2 k               | 60 k                           | 5 k               | 150 k                          | 10 k              | 300 k                          | 20 k              | 600 k                          |
| 4 s      | 1 k               | 40 k                           | 2 k               | 80 k                           | 5 k               | 200 k                          | 10 k              | 400 k                          | 20 k              | 800 k                          |
| 5 s      | 1 k               | 50 k                           | 2 k               | 100 k                          | 5 k               | 250 k                          | 10 k              | 500 k                          | 20 k              | 1 M                            |
| 6 s      | 500               | 30 k                           | 1 k               | 60 k                           | 2 k               | 120 k                          | 5 k               | 300 k                          | 10 k              | 600 k                          |
| 8 s      | 500               | 40 k                           | 1 k               | 80 k                           | 2 k               | 160 k                          | 5 k               | 400 k                          | 10 k              | 800 k                          |
| 10 s     | 500               | 50 k                           | 1 k               | 100 k                          | 2 k               | 200 k                          | 5 k               | 500 k                          | 10 k              | 1 M                            |
| 20 s     | 200               | 40 k                           | 500               | 100 k                          | 1 k               | 200 k                          | 2 k               | 400 k                          | 5 k               | 1 M                            |
| 30 s     | 100               | 30 k                           | 200               | 60 k                           | 500               | 150 k                          | 1 k               | 300 k                          | 2 k               | 600 k                          |
| 1 min    | 50                | 30 k                           | 100               | 60 k                           | 200               | 120 k                          | 500               | 300 k                          | 1 k               | 600 k                          |
| 2 min    | 20                | 24 k                           | 50                | 60 k                           | 200               | 240 k                          | 200               | 240 k                          | 500               | 600 k                          |
| 3 min    | 20                | 36 k                           | 50                | 90 k                           | 100               | 180 k                          | 200               | 360 k                          | 500               | 900 k                          |
| 4 min    | 20                | 48 k                           | 20                | 48 k                           | 100               | 240 k                          | 200               | 480 k                          | 200               | 480 k                          |
| 5 min    | 10                | 30 k                           | 20                | 60 k                           | 50                | 150 k                          | 100               | 300 k                          | 200               | 600 k                          |
| 6 min    | 10                | 36 k                           | 20                | 72 k                           | 50                | 180 k                          | 100               | 360 k                          | 200               | 720 k                          |
| 7 min    | 10                | 42 k                           | 20                | 84 k                           | 50                | 210 k                          | 100               | 420 k                          | 200               | 840 k                          |
| 8 min    | 10                | 48 k                           | 20                | 96 k                           | 50                | 240 k                          | 100               | 480 k                          | 200               | 960 k                          |
| 9 min    | 5                 | 27 k                           | 10                | 54 k                           | 20                | 108 k                          | 50                | 270 k                          | 100               | 540 k                          |
| 10 min   | 5                 | 30 k                           | 10                | 60 k                           | 20                | 120 k                          | 50                | 300 k                          | 100               | 600 k                          |
| 12 min   | 5                 | 36 k                           | 10                | 72 k                           | 20                | 144 k                          | 50                | 360 k                          | 100               | 720 k                          |
| 15 min   | 5                 | 45 k                           | 10                | 90 k                           | 20                | 180 k                          | 50                | 450 k                          | 100               | 900 k                          |
| 30 min   |                   |                                | 5                 | 90 k                           | 10                | 180 k                          | 20                | 360 k                          | 50                | 900 k                          |
| 1 h      |                   |                                |                   |                                | 5                 | 180 K                          | 10                | 360 k                          | 20                | 720 k                          |
| 2 h      |                   |                                |                   |                                |                   |                                | 5                 | 360 k                          | 10                | 720 k                          |
| 3 h      |                   |                                |                   |                                |                   |                                |                   |                                | 5                 | 540 k                          |
| 4 h      |                   |                                |                   |                                |                   |                                |                   |                                | 5                 | 720 k                          |
| 5 h      |                   |                                |                   |                                |                   |                                |                   |                                | 5                 | 900 k                          |

When the time axis setting is 100 ms or greater (the settings surrounded by bold lines) and the trigger mode is Auto or Auto Level, waveforms are displayed in roll mode.



Appendix 1 Relationship between the Time Axis Setting, Record Length, and Sample Rate

When the Record Length Is 2.5 Mpoint, 5 Mpoint, 10 Mpoint, 25 Mpoint, or 50 Mpoint

| Time/div | Record Length     |                                |                   |                                |                   |                                |                   |                                |                   |                                |
|----------|-------------------|--------------------------------|-------------------|--------------------------------|-------------------|--------------------------------|-------------------|--------------------------------|-------------------|--------------------------------|
|          | 2.5 Mpoint        |                                | 5 Mpoint          |                                | 10 Mpoint         |                                | 25 Mpoint         |                                | 50 Mpoint         |                                |
|          | Sample Rate (S/s) | Display Record Length (Points) | Sample Rate (S/s) | Display Record Length (Points) | Sample Rate (S/s) | Display Record Length (Points) | Sample Rate (S/s) | Display Record Length (Points) | Sample Rate (S/s) | Display Record Length (Points) |
| 1 µs     | 10 M              | 100                            | 10 M              | 100                            | 10 M              | 100                            | 10 M              | 100                            | 10 M              | 100                            |
| 2 µs     | 10 M              | 200                            | 10 M              | 200                            | 10 M              | 200                            | 10 M              | 200                            | 10 M              | 200                            |
| 5 µs     | 10 M              | 500                            | 10 M              | 500                            | 10 M              | 500                            | 10 M              | 500                            | 10 M              | 500                            |
| 10 µs    | 10 M              | 1 k                            | 10 M              | 1 k                            | 10 M              | 1 k                            | 10 M              | 1 k                            | 10 M              | 1 k                            |
| 20 µs    | 10 M              | 2 k                            | 10 M              | 2 k                            | 10 M              | 2 k                            | 10 M              | 2 k                            | 10 M              | 2 k                            |
| 50 µs    | 10 M              | 5 k                            | 10 M              | 5 k                            | 10 M              | 5 k                            | 10 M              | 5 k                            | 10 M              | 5 k                            |
| 100 µs   | 10 M              | 10 k                           | 10 M              | 10 k                           | 10 M              | 10 k                           | 10 M              | 10 k                           | 10 M              | 10 k                           |
| 200 µs   | 10 M              | 20 k                           | 10 M              | 20 k                           | 10 M              | 20 k                           | 10 M              | 20 k                           | 10 M              | 20 k                           |
| 500 µs   | 10 M              | 50 k                           | 10 M              | 50 k                           | 10 M              | 50 k                           | 10 M              | 50 k                           | 10 M              | 50 k                           |
| 1 ms     | 10 M              | 100 k                          | 10 M              | 100 k                          | 10 M              | 100 k                          | 10 M              | 100 k                          | 10 M              | 100 k                          |
| 2 ms     | 10 M              | 200 k                          | 10 M              | 200 k                          | 10 M              | 200 k                          | 10 M              | 200 k                          | 10 M              | 200 k                          |
| 5 ms     | 10 M              | 500 k                          | 10 M              | 500 k                          | 10 M              | 500 k                          | 10 M              | 500 k                          | 10 M              | 500 k                          |
| 10 ms    | 10 M              | 1 M                            | 10 M              | 1 M                            | 10 M              | 1 M                            | 10 M              | 1 M                            | 10 M              | 1 M                            |
| 20 ms    | 10 M              | 2 M                            | 10 M              | 2 M                            | 10 M              | 2 M                            | 10 M              | 2 M                            | 10 M              | 2 M                            |
| 50 ms    | 5 M               | 2.5 M                          | 10 M              | 5 M                            | 10 M              | 5 M                            | 10 M              | 5 M                            | 10 M              | 5 M                            |
| 100 ms   | 2 M               | 2 M                            | 5 M               | 5 M                            | 10 M              | 10 M                           | 10 M              | 10 M                           | 10 M              | 10 M                           |
| 200 ms   | 1 M               | 2 M                            | 2 M               | 4 M                            | 5 M               | 10 M                           | 10 M              | 20 M                           | 10 M              | 20 M                           |
| 500 ms   | 500 k             | 2.5 M                          | 1 M               | 5 M                            | 2 M               | 10 M                           | 5 M               | 25 M                           | 10 M              | 50 M                           |
| 1 s      | 200 k             | 2 M                            | 500 k             | 5 M                            | 1 M               | 10 M                           | 2 M               | 20 M                           | 5 M               | 50 M                           |
| 2 s      | 100 k             | 2 M                            | 200 k             | 4 M                            | 500 k             | 10 M                           | 1 M               | 20 M                           | 2 M               | 40 M                           |
| 3 s      | 50 k              | 1.5 M                          | 100 k             | 3 M                            | 200 k             | 6 M                            | 500 k             | 15 M                           | 1 M               | 30 M                           |
| 4 s      | 50 k              | 2 M                            | 100 k             | 4 M                            | 200 k             | 8 M                            | 500 k             | 20 M                           | 1 M               | 40 M                           |
| 5 s      | 50 k              | 2.5 M                          | 100 k             | 5 M                            | 200 k             | 10 M                           | 500 k             | 25 M                           | 1 M               | 50 M                           |
| 6 s      | 20 k              | 1.2 M                          | 50 k              | 3 M                            | 100 k             | 6 M                            | 200 k             | 12 M                           | 500 k             | 30 M                           |
| 8 s      | 20 k              | 1.6 M                          | 50 k              | 4 M                            | 100 k             | 8 M                            | 200 k             | 16 M                           | 500 k             | 40 M                           |
| 10 s     | 20 k              | 2 M                            | 50 k              | 5 M                            | 100 k             | 10 M                           | 200 k             | 20 M                           | 500 k             | 50 M                           |
| 20 s     | 10 k              | 2 M                            | 20 k              | 4 M                            | 50 k              | 10 M                           | 100 k             | 20 M                           | 200 k             | 40 M                           |
| 30 s     | 5 k               | 1.5 M                          | 10 k              | 3 M                            | 20 k              | 6 M                            | 50 k              | 15 M                           | 100 k             | 30 M                           |
| 1 min    | 2 k               | 1.2 M                          | 5 k               | 3 M                            | 10 k              | 6 M                            | 20 k              | 12 M                           | 50 k              | 30 M                           |
| 2 min    | 2 k               | 2.4 M                          | 2 k               | 2.4 M                          | 5 k               | 6 M                            | 20 k              | 24 M                           | 20 k              | 24 M                           |
| 3 min    | 1 k               | 1.8 M                          | 2 k               | 3.6 M                          | 5 k               | 9 M                            | 10 k              | 18 M                           | 20 k              | 36 M                           |
| 4 min    | 1 k               | 2.4 M                          | 2 k               | 4.8 M                          | 2 k               | 4.8 M                          | 10 k              | 24 M                           | 20 k              | 48 M                           |
| 5 min    | 500               | 1.5 M                          | 1 k               | 3 M                            | 2 k               | 6 M                            | 5 k               | 15 M                           | 10 k              | 30 M                           |
| 6 min    | 500               | 1.8 M                          | 1 k               | 3.6 M                          | 2 k               | 7.2 M                          | 5 k               | 18 M                           | 10 k              | 36 M                           |
| 7 min    | 500               | 2.1 M                          | 1 k               | 4.2 M                          | 2 k               | 8.4 M                          | 5 k               | 21 M                           | 10 k              | 42 M                           |
| 8 min    | 500               | 2.4 M                          | 1 k               | 4.8 M                          | 2 k               | 9.6 M                          | 5 k               | 24 M                           | 10 k              | 48 M                           |
| 9 min    | 200               | 1.08 M                         | 500               | 2.7 M                          | 1 k               | 5.4 M                          | 2 k               | 10.8 M                         | 5 k               | 27 M                           |
| 10 min   | 200               | 1.2 M                          | 500               | 3 M                            | 1 k               | 6 M                            | 2 k               | 12 M                           | 5 k               | 30 M                           |
| 12 min   | 200               | 1.44 M                         | 500               | 3.6 M                          | 1 k               | 7.2 M                          | 2 k               | 14.4 M                         | 5 k               | 36 M                           |
| 15 min   | 200               | 1.8 M                          | 500               | 4.5 M                          | 1 k               | 9 M                            | 2 k               | 18 M                           | 5 k               | 45 M                           |
| 30 min   | 100               | 1.8 M                          | 200               | 3.6 M                          | 500               | 9 M                            | 1 k               | 18 M                           | 2 k               | 36 M                           |
| 1 h      | 50                | 1.8 M                          | 100               | 3.6 M                          | 200               | 7.2 M                          | 500               | 18 M                           | 1 k               | 36 M                           |
| 2 h      | 20                | 1.44 M                         | 50                | 3.6 M                          | 100               | 7.2 M                          | 200               | 14.4 M                         | 500               | 36 M                           |
| 3 h      | 20                | 2.16 M                         | 20                | 2.16 M                         | 50                | 5.4 M                          | 200               | 21.6 M                         | 200               | 21.6 M                         |
| 4 h      | 10                | 1.44 M                         | 20                | 2.88 M                         | 50                | 7.2 M                          | 100               | 14.4 M                         | 200               | 28.8 M                         |
| 5 h      | 10                | 1.8 M                          | 20                | 3.6 M                          | 50                | 9 M                            | 100               | 18 M                           | 200               | 36 M                           |
| 6 h      | 10                | 2.16 M                         | 20                | 4.32 M                         | 20                | 4.32 M                         | 100               | 21.6 M                         | 200               | 43.2 M                         |
| 7 h      | 5                 | 1.26 M                         | 10                | 2.52 M                         | 20                | 5.04 M                         | 50                | 12.6 M                         | 100               | 25.2 M                         |
| 8 h      | 5                 | 1.44 M                         | 10                | 2.88 M                         | 20                | 5.76 M                         | 50                | 14.4 M                         | 100               | 28.8 M                         |
| 9 h      | 5                 | 1.62 M                         | 10                | 3.24 M                         | 20                | 6.48 M                         | 50                | 16.2 M                         | 100               | 32.4 M                         |
| 10 h     | 5                 | 1.8 M                          | 10                | 3.6 M                          | 20                | 7.2 M                          | 50                | 18 M                           | 100               | 36 M                           |
| 12 h     | 5                 | 2.16 M                         | 10                | 4.32 M                         | 20                | 8.64 M                         | 50                | 21.6 M                         | 100               | 43.2 M                         |
| 1 day    |                   |                                | 5                 | 4.32 M                         | 10                | 8.64 M                         | 20                | 17.28 M                        | 50                | 43.2 M                         |
| 2 days   |                   |                                |                   |                                | 5                 | 8.64 M                         | 10                | 17.28 M                        | 20                | 34.56 M                        |
| 3 days   |                   |                                |                   |                                |                   |                                | 5                 | 12.96 M                        | 10                | 25.92 M                        |

When the time axis setting is 100 ms or greater (the settings surrounded by bold lines) and the trigger mode is Auto or Auto Level, waveforms are displayed in roll mode.

(Continued on next page)

## Appendix 1 Relationship between the Time Axis Setting, Record Length, and Sample Rate

(Continued from previous page)

| Time/div | Record Length     |                                |                   |                                |                   |                                |                   |                                |                   |                                |
|----------|-------------------|--------------------------------|-------------------|--------------------------------|-------------------|--------------------------------|-------------------|--------------------------------|-------------------|--------------------------------|
|          | 2.5 Mpoint        |                                | 5 Mpoint          |                                | 10 Mpoint         |                                | 25 Mpoint         |                                | 50 Mpoint         |                                |
|          | Sample Rate (S/s) | Display Record Length (Points) | Sample Rate (S/s) | Display Record Length (Points) | Sample Rate (S/s) | Display Record Length (Points) | Sample Rate (S/s) | Display Record Length (Points) | Sample Rate (S/s) | Display Record Length (Points) |
| 4 days   |                   |                                |                   |                                |                   |                                | 5                 | 17.28M                         | 10                | 34.56M                         |
| 5 days   |                   |                                |                   |                                |                   |                                | 5                 | 21.6M                          | 10                | 43.2M                          |
| 6 days   |                   |                                |                   |                                |                   |                                |                   |                                | 5                 | 25.92M                         |
| 8 days   |                   |                                |                   |                                |                   |                                |                   |                                | 5                 | 34.56M                         |
| 10 days  |                   |                                |                   |                                |                   |                                |                   |                                | 5                 | 43.2M                          |

When the time axis setting is 100 ms or greater (the settings surrounded by bold lines) and the trigger mode is Auto or Auto Level, waveforms are displayed in roll mode.

Appendix 1 Relationship between the Time Axis Setting, Record Length, and Sample Rate

When the Record Length Is 100 Mpoint, 250 Mpoint, 500 Mpoint, 1 Gpoint, or 2 Gpoint

| Time/div | Record Length     |                                |                   |                                |                   |                                |                   |                                |                   |                                |
|----------|-------------------|--------------------------------|-------------------|--------------------------------|-------------------|--------------------------------|-------------------|--------------------------------|-------------------|--------------------------------|
|          | 100 Mpoint        |                                | 250 Mpoint        |                                | 500 Mpoint        |                                | 1 Gpoint          |                                | 2 Gpoint          |                                |
|          | Sample Rate (S/s) | Display Record Length (Points) | Sample Rate (S/s) | Display Record Length (Points) | Sample Rate (S/s) | Display Record Length (Points) | Sample Rate (S/s) | Display Record Length (Points) | Sample Rate (S/s) | Display Record Length (Points) |
| 1 µs     | 10 M              | 100                            | 10 M              | 100                            | 10 M              | 100                            | 10 M              | 100                            | 10 M              | 100                            |
| 2 µs     | 10 M              | 200                            | 10 M              | 200                            | 10 M              | 200                            | 10 M              | 200                            | 10 M              | 200                            |
| 5 µs     | 10 M              | 500                            | 10 M              | 500                            | 10 M              | 500                            | 10 M              | 500                            | 10 M              | 500                            |
| 10 µs    | 10 M              | 1 k                            | 10 M              | 1 k                            | 10 M              | 1 k                            | 10 M              | 1 k                            | 10 M              | 1 k                            |
| 20 µs    | 10 M              | 2 k                            | 10 M              | 2 k                            | 10 M              | 2 k                            | 10 M              | 2 k                            | 10 M              | 2 k                            |
| 50 µs    | 10 M              | 5 k                            | 10 M              | 5 k                            | 10 M              | 5 k                            | 10 M              | 5 k                            | 10 M              | 5 k                            |
| 100 µs   | 10 M              | 10 k                           | 10 M              | 10 k                           | 10 M              | 10 k                           | 10 M              | 10 k                           | 10 M              | 10 k                           |
| 200 µs   | 10 M              | 20 k                           | 10 M              | 20 k                           | 10 M              | 20 k                           | 10 M              | 20 k                           | 10 M              | 20 k                           |
| 500 µs   | 10 M              | 50 k                           | 10 M              | 50 k                           | 10 M              | 50 k                           | 10 M              | 50 k                           | 10 M              | 50 k                           |
| 1 ms     | 10 M              | 100 k                          | 10 M              | 100 k                          | 10 M              | 100 k                          | 10 M              | 100 k                          | 10 M              | 100 k                          |
| 2 ms     | 10 M              | 200 k                          | 10 M              | 200 k                          | 10 M              | 200 k                          | 10 M              | 200 k                          | 10 M              | 200 k                          |
| 5 ms     | 10 M              | 500 k                          | 10 M              | 500 k                          | 10 M              | 500 k                          | 10 M              | 500 k                          | 10 M              | 500 k                          |
| 10 ms    | 10 M              | 1 M                            | 10 M              | 1 M                            | 10 M              | 1 M                            | 10 M              | 1 M                            | 10 M              | 1 M                            |
| 20 ms    | 10 M              | 2 M                            | 10 M              | 2 M                            | 10 M              | 2 M                            | 10 M              | 2 M                            | 10 M              | 2 M                            |
| 50 ms    | 10 M              | 5 M                            | 10 M              | 5 M                            | 10 M              | 5 M                            | 10 M              | 5 M                            | 10 M              | 5 M                            |
| 100 ms   | 10 M              | 10 M                           | 10 M              | 10 M                           | 10 M              | 10 M                           | 10 M              | 10 M                           | 10 M              | 10 M                           |
| 200 ms   | 10 M              | 20 M                           | 10 M              | 20 M                           | 10 M              | 20 M                           | 10 M              | 20 M                           | 10 M              | 20 M                           |
| 500 ms   | 10 M              | 50 M                           | 10 M              | 50 M                           | 10 M              | 50 M                           | 10 M              | 50 M                           | 10 M              | 50 M                           |
| 1 s      | 10 M              | 100 M                          | 10 M              | 100 M                          | 10 M              | 100 M                          | 10 M              | 100 M                          | 10 M              | 100 M                          |
| 2 s      | 5 M               | 100 M                          | 10 M              | 200 M                          | 10 M              | 200 M                          | 10 M              | 200 M                          | 10 M              | 200 M                          |
| 3 s      | 2 M               | 60 M                           | 5 M               | 150 M                          | 10 M              | 300 M                          | 10 M              | 300 M                          | 10 M              | 300 M                          |
| 4 s      | 2 M               | 80 M                           | 5 M               | 200 M                          | 10 M              | 400 M                          | 10 M              | 400 M                          | 10 M              | 400 M                          |
| 5 s      | 2 M               | 100 M                          | 5 M               | 250 M                          | 10 M              | 500 M                          | 10 M              | 500 M                          | 10 M              | 500 M                          |
| 6 s      | 1 M               | 60 M                           | 2 M               | 120 M                          | 5 M               | 300 M                          | 10 M              | 600 M                          | 10 M              | 600 M                          |
| 8 s      | 1 M               | 80 M                           | 2 M               | 160 M                          | 5 M               | 400 M                          | 10 M              | 800 M                          | 10 M              | 800 M                          |
| 10 s     | 1 M               | 100 M                          | 2 M               | 200 M                          | 5 M               | 500 M                          | 10 M              | 1 G                            | 10 M              | 1 G                            |
| 20 s     | 500 k             | 100 M                          | 1 M               | 200 M                          | 2 M               | 400 M                          | 5 M               | 1 G                            | 10 M              | 2 G                            |
| 30 s     | 200 k             | 60 M                           | 500 k             | 150 M                          | 1 M               | 300 M                          | 2 M               | 600 M                          | 5 M               | 1.5 G                          |
| 1 min    | 100 k             | 60 M                           | 200 k             | 120 M                          | 500 k             | 300 M                          | 1 M               | 600 M                          | 2 M               | 1.2 G                          |
| 2 min    | 50 k              | 60 M                           | 200 k             | 240 M                          | 200 k             | 240 M                          | 500 k             | 600 M                          | 1 M               | 1.2 G                          |
| 3 min    | 50 k              | 90 M                           | 100 k             | 180 M                          | 200 k             | 360 M                          | 500 k             | 900 M                          | 1 M               | 1.8 G                          |
| 4 min    | 20 k              | 48 M                           | 100 k             | 240 M                          | 200 k             | 480 M                          | 200 k             | 480 M                          | 500 k             | 1.2 G                          |
| 5 min    | 20 k              | 60 M                           | 50 k              | 150 M                          | 100 k             | 300 M                          | 200 k             | 600 M                          | 500 k             | 1.5 G                          |
| 6 min    | 20 k              | 72 M                           | 50 k              | 180 M                          | 100 k             | 360 M                          | 200 k             | 720 M                          | 500 k             | 1.8 G                          |
| 7 min    | 20 k              | 84 M                           | 50 k              | 210 M                          | 100 k             | 420 M                          | 200 k             | 840 M                          | 200 k             | 840 M                          |
| 8 min    | 20 k              | 96 M                           | 50 k              | 240 M                          | 100 k             | 480 M                          | 200 k             | 960 M                          | 200 k             | 960 M                          |
| 9 min    | 10 k              | 54 M                           | 20 k              | 108 M                          | 50 k              | 270 M                          | 100 k             | 540 M                          | 200 k             | 1.08 G                         |
| 10 min   | 10 k              | 60 M                           | 20 k              | 120 M                          | 50 k              | 300 M                          | 100 k             | 600 M                          | 200 k             | 1.2 G                          |
| 12 min   | 10 k              | 72 M                           | 20 k              | 144 M                          | 50 k              | 360 M                          | 100 k             | 720 M                          | 200 k             | 1.44 G                         |
| 15 min   | 10 k              | 90 M                           | 20 k              | 180 M                          | 50 k              | 450 M                          | 100 k             | 900 M                          | 200 k             | 1.8 G                          |
| 30 min   | 5 k               | 90 M                           | 10 k              | 180 M                          | 20 k              | 360 M                          | 50 k              | 900 M                          | 100 k             | 1.8 G                          |
| 1 h      | 2 k               | 72 M                           | 5 k               | 180 M                          | 10 k              | 360 M                          | 20 k              | 720 M                          | 50 k              | 1.8 G                          |
| 2 h      | 1 k               | 72 M                           | 2 k               | 144 M                          | 5 k               | 360 M                          | 10 k              | 720 M                          | 20 k              | 1.44 G                         |
| 3 h      | 500               | 54 M                           | 2 k               | 216 M                          | 2 k               | 216 M                          | 5 k               | 540 M                          | 10 k              | 1.08 G                         |
| 4 h      | 500               | 72 M                           | 1 k               | 144 M                          | 2 k               | 288 M                          | 5 k               | 720 M                          | 10 k              | 1.44 G                         |
| 5 h      | 500               | 90 M                           | 1 k               | 180 M                          | 2 k               | 360 M                          | 5 k               | 900 M                          | 10 k              | 1.8 G                          |
| 6 h      | 200               | 43.2 M                         | 1 k               | 216 M                          | 2 k               | 432 M                          | 2 k               | 432 M                          | 5 k               | 1.08 G                         |
| 7 h      | 200               | 50.4 M                         | 500               | 126 M                          | 1 k               | 252 M                          | 2 k               | 504 M                          | 5 k               | 1.26 G                         |
| 8 h      | 200               | 57.6 M                         | 500               | 144 M                          | 1 k               | 288 M                          | 2 k               | 576 M                          | 5 k               | 1.44 G                         |
| 9 h      | 200               | 64.8 M                         | 500               | 162 M                          | 1 k               | 324 M                          | 2 k               | 648 M                          | 5 k               | 1.62 G                         |
| 10 h     | 200               | 72 M                           | 500               | 180 M                          | 1 k               | 360 M                          | 2 k               | 720 M                          | 5 k               | 1.8 G                          |
| 12 h     | 200               | 86.4 M                         | 500               | 216 M                          | 1 k               | 432 M                          | 2 k               | 864 M                          | 2 k               | 864 M                          |
| 1 day    | 100               | 86.4 M                         | 200               | 172.8 M                        | 500               | 432 M                          | 1 k               | 864 M                          | 2 k               | 1.728 G                        |
| 2 days   | 50                | 86.4 M                         | 100               | 172.8 M                        | 200               | 345.6 M                        | 500               | 864 M                          | 1 k               | 1.728 G                        |
| 3 days   | 20                | 51.84 M                        | 50                | 129.6 M                        | 100               | 259.2 M                        | 200               | 518.4 M                        | 500               | 1.296 G                        |

When the time axis setting is 100 ms or greater (the settings surrounded by bold lines) and the trigger mode is Auto or Auto Level, waveforms are displayed in roll mode.

(Continued on next page)

## Appendix 1 Relationship between the Time Axis Setting, Record Length, and Sample Rate

(Continued from previous page)

| Time/div | Record Length     |                                |                   |                                |                   |                                |                   |                                |                   |                                |
|----------|-------------------|--------------------------------|-------------------|--------------------------------|-------------------|--------------------------------|-------------------|--------------------------------|-------------------|--------------------------------|
|          | 100 Mpoint        |                                | 250 Mpoint        |                                | 500 Mpoint        |                                | 1 Gpoint          |                                | 2 Gpoint          |                                |
|          | Sample Rate (S/s) | Display Record Length (Points) | Sample Rate (S/s) | Display Record Length (Points) | Sample Rate (S/s) | Display Record Length (Points) | Sample Rate (S/s) | Display Record Length (Points) | Sample Rate (S/s) | Display Record Length (Points) |
| 4 days   | 20                | 69.12M                         | 50                | 172.8M                         | 100               | 345.6M                         | 200               | 691.2M                         | 500               | 1.728G                         |
| 5 days   | 20                | 86.4M                          | 50                | 216M                           | 100               | 432M                           | 200               | 864M                           | 200               | 864M                           |
| 6 days   | 10                | 51.84M                         | 20                | 103.68M                        | 50                | 259.2M                         | 100               | 518.4M                         | 200               | 1.0368G                        |
| 8 days   | 10                | 69.12M                         | 20                | 138.24M                        | 50                | 345.6M                         | 100               | 691.2M                         | 200               | 1.3824G                        |
| 10 days  | 10                | 86.4M                          | 20                | 172.8M                         | 50                | 432M                           | 100               | 864M                           | 200               | 1.728G                         |
| 20 days  | 5                 | 86.4M                          | 10                | 172.8M                         | 20                | 345.6M                         | 50                | 864M                           | 100               | 1.728G                         |

When the time axis setting is 100 ms or greater (the settings surrounded by bold lines) and the trigger mode is Auto or Auto Level, waveforms are displayed in roll mode.

Appendix 1 Relationship between the Time Axis Setting, Record Length, and Sample Rate

When the Record Length Is 4 Gpoint, 5 Gpoint, 10 Gpoint, 20 Gpoint, or 50 Gpoint

| Time/div | Record Length     |                                |                   |                                |                   |                                |                   |                                |                   |                                |
|----------|-------------------|--------------------------------|-------------------|--------------------------------|-------------------|--------------------------------|-------------------|--------------------------------|-------------------|--------------------------------|
|          | 4 Gpoint          |                                | 5 Gpoint          |                                | 10 Gpoint         |                                | 20 Gpoint         |                                | 50 Gpoint         |                                |
|          | Sample Rate (S/s) | Display Record Length (Points) | Sample Rate (S/s) | Display Record Length (Points) | Sample Rate (S/s) | Display Record Length (Points) | Sample Rate (S/s) | Display Record Length (Points) | Sample Rate (S/s) | Display Record Length (Points) |
| 1 µs     |                   |                                |                   |                                |                   |                                |                   |                                |                   |                                |
| 2 µs     |                   |                                |                   |                                |                   |                                |                   |                                |                   |                                |
| 5 µs     |                   |                                |                   |                                |                   |                                |                   |                                |                   |                                |
| 10 µs    |                   |                                |                   |                                |                   |                                |                   |                                |                   |                                |
| 20 µs    |                   |                                |                   |                                |                   |                                |                   |                                |                   |                                |
| 50 µs    |                   |                                |                   |                                |                   |                                |                   |                                |                   |                                |
| 100 µs   |                   |                                |                   |                                |                   |                                |                   |                                |                   |                                |
| 200 µs   |                   |                                |                   |                                |                   |                                |                   |                                |                   |                                |
| 500 µs   |                   |                                |                   |                                |                   |                                |                   |                                |                   |                                |
| 1 ms     |                   |                                |                   |                                |                   |                                |                   |                                |                   |                                |
| 2 ms     |                   |                                |                   |                                |                   |                                |                   |                                |                   |                                |
| 5 ms     |                   |                                |                   |                                |                   |                                |                   |                                |                   |                                |
| 10 ms    |                   |                                |                   |                                |                   |                                |                   |                                |                   |                                |
| 20 ms    |                   |                                |                   |                                |                   |                                |                   |                                |                   |                                |
| 50 ms    |                   |                                |                   |                                |                   |                                |                   |                                |                   |                                |
| 100 ms   |                   |                                |                   |                                |                   |                                |                   |                                |                   |                                |
| 200 ms   |                   |                                |                   |                                |                   |                                |                   |                                |                   |                                |
| 500 ms   |                   |                                |                   |                                |                   |                                |                   |                                |                   |                                |
| 1 s      |                   |                                |                   |                                |                   |                                |                   |                                |                   |                                |
| 2 s      |                   |                                |                   |                                |                   |                                |                   |                                |                   |                                |
| 3 s      |                   |                                |                   |                                |                   |                                |                   |                                |                   |                                |
| 4 s      |                   |                                |                   |                                |                   |                                |                   |                                |                   |                                |
| 5 s      |                   |                                |                   |                                |                   |                                |                   |                                |                   |                                |
| 6 s      |                   |                                |                   |                                |                   |                                |                   |                                |                   |                                |
| 8 s      |                   |                                |                   |                                |                   |                                |                   |                                |                   |                                |
| 10 s     |                   |                                |                   |                                |                   |                                |                   |                                |                   |                                |
| 20 s     |                   |                                |                   |                                |                   |                                |                   |                                |                   |                                |
| 30 s     |                   |                                |                   |                                |                   |                                |                   |                                |                   |                                |
| 1 min    |                   |                                |                   |                                |                   |                                |                   |                                |                   |                                |
| 2 min    |                   |                                |                   |                                |                   |                                |                   |                                |                   |                                |
| 3 min    |                   |                                |                   |                                |                   |                                |                   |                                |                   |                                |
| 4 min    | 1 M               | 2.4 G                          |                   |                                |                   |                                |                   |                                |                   |                                |
| 5 min    | 1 M               | 3 G                            | 1 M               | 3 G                            |                   |                                |                   |                                |                   |                                |
| 6 min    | 1 M               | 3.6 G                          | 1 M               | 3.6 G                          |                   |                                |                   |                                |                   |                                |
| 7 min    | 500 k             | 2.1 G                          | 1 M               | 4.2 G                          |                   |                                |                   |                                |                   |                                |
| 8 min    | 500 k             | 2.4 G                          | 1 M               | 4.8 G                          |                   |                                |                   |                                |                   |                                |
| 9 min    | 500 k             | 2.7 G                          | 500 k             | 2.7 G                          | 1 M               | 5.4 G                          |                   |                                |                   |                                |
| 10 min   | 500 k             | 3 G                            | 500 k             | 3 G                            | 1 M               | 6 G                            |                   |                                |                   |                                |
| 12 min   | 500 k             | 3.6 G                          | 500 k             | 3.6 G                          | 1 M               | 7.2 G                          |                   |                                |                   |                                |
| 15 min   | 200 k             | 1.8 G                          | 500 k             | 4.5 G                          | 1 M               | 9 G                            |                   |                                |                   |                                |
| 30 min   | 200 k             | 3.6 G                          | 200 k             | 3.6 G                          | 500 k             | 9 G                            | 1 M               | 18 G                           |                   |                                |
| 1 h      | 100 k             | 3.6 G                          | 100 k             | 3.6 G                          | 200 k             | 7.2 G                          | 500 k             | 18 G                           | 1 M               | 36 G                           |
| 2 h      | 50 k              | 3.6 G                          | 50 k              | 3.6 G                          | 100 k             | 7.2 G                          | 200 k             | 14.4 G                         | 500 k             | 36 G                           |
| 3 h      | 20 k              | 2.16 G                         | 20 k              | 2.16 G                         | 50 k              | 5.4 G                          | 100 k             | 10.8 G                         | 200 k             | 21.6 G                         |
| 4 h      | 20 k              | 2.88 G                         | 20 k              | 2.88 G                         | 50 k              | 7.2 G                          | 100 k             | 14.4 G                         | 200 k             | 28.8 G                         |
| 5 h      | 20 k              | 3.6 G                          | 20 k              | 3.6 G                          | 50 k              | 9 G                            | 100 k             | 18 G                           | 200 k             | 36 G                           |
| 6 h      | 10 k              | 2.16 G                         | 20 k              | 4.32 G                         | 20 k              | 4.32 G                         | 50 k              | 10.8 G                         | 200 k             | 43.2 G                         |
| 7 h      | 10 k              | 2.52 G                         | 10 k              | 2.52 G                         | 20 k              | 5.04 G                         | 50 k              | 12.6 G                         | 100 k             | 25.2 G                         |
| 8 h      | 10 k              | 2.88 G                         | 10 k              | 2.88 G                         | 20 k              | 5.76 G                         | 50 k              | 14.4 G                         | 100 k             | 28.8 G                         |
| 9 h      | 10 k              | 3.24 G                         | 10 k              | 3.24 G                         | 20 k              | 6.48 G                         | 50 k              | 16.2 G                         | 100 k             | 32.4 G                         |
| 10 h     | 10 k              | 3.6 G                          | 10 k              | 3.6 G                          | 20 k              | 7.2 G                          | 50 k              | 18 G                           | 100 k             | 36 G                           |
| 12 h     | 5 k               | 2.16 G                         | 10 k              | 4.32 G                         | 20 k              | 8.64 G                         | 20 k              | 8.64 G                         | 100 k             | 43.2 G                         |
| 1 day    | 2 k               | 1.728 G                        | 5 k               | 4.32 G                         | 10 k              | 8.64 G                         | 20 k              | 17.28 G                        | 50 k              | 43.2 G                         |
| 2 days   | 2 k               | 3.456 G                        | 2 k               | 3.456 G                        | 5 k               | 8.64 G                         | 10 k              | 17.28 G                        | 20 k              | 34.56 G                        |
| 3 days   | 1 k               | 2.592 G                        | 1 k               | 2.592 G                        | 2 k               | 5.184 G                        | 5 k               | 12.96 G                        | 10 k              | 25.9 G                         |

When the time axis setting is 100 ms or greater (the settings surrounded by bold lines) and the trigger mode is Auto or Auto Level, waveforms are displayed in roll mode.

(Continued on next page)

## Appendix 1 Relationship between the Time Axis Setting, Record Length, and Sample Rate

(Continued from previous page)

| Time/div | Record Length     |                                |                   |                                |                   |                                |                   |                                |                   |                                |
|----------|-------------------|--------------------------------|-------------------|--------------------------------|-------------------|--------------------------------|-------------------|--------------------------------|-------------------|--------------------------------|
|          | 4 Gpoint          |                                | 5 Gpoint          |                                | 10 Gpoint         |                                | 20 Gpoint         |                                | 50 Gpoint         |                                |
|          | Sample Rate (S/s) | Display Record Length (Points) | Sample Rate (S/s) | Display Record Length (Points) | Sample Rate (S/s) | Display Record Length (Points) | Sample Rate (S/s) | Display Record Length (Points) | Sample Rate (S/s) | Display Record Length (Points) |
| 4 days   | 1 k               | 3.456G                         | 1 k               | 3.456G                         | 2 k               | 6.912G                         | 5 k               | 17.28G                         | 10 k              | 34.56G                         |
| 5 days   | 500               | 2.16G                          | 1 k               | 4.32G                          | 2 k               | 8.64G                          | 2 k               | 8.64G                          | 10 k              | 43.2G                          |
| 6 days   | 500               | 2.592G                         | 500               | 2.592G                         | 1 k               | 5.184G                         | 2 k               | 10.368G                        | 5 k               | 25.92G                         |
| 8 days   | 500               | 3.456G                         | 500               | 3.456G                         | 1 k               | 6.912G                         | 2 k               | 13.824G                        | 5 k               | 34.56G                         |
| 10 days  | 200               | 1.728G                         | 500               | 4.32G                          | 1 k               | 8.64G                          | 2 k               | 17.28G                         | 5 k               | 43.2G                          |
| 20 days  | 200               | 3.456G                         | 200               | 3.456G                         | 500               | 8.64G                          | 1 k               | 17.28G                         | 2 k               | 34.56G                         |

When the time axis setting is 100 ms or greater (the settings surrounded by bold lines) and the trigger mode is Auto or Auto Level, waveforms are displayed in roll mode.

## Appendix 2 Relationship between the Main Channel Sample Rate, Sub Channel Data Update Rate, and Acquisition Memory Writing Rate

### 16-CH Voltage Input Module

Rate at Which Data Is Written to the Acquisition Memory

| Number of Sub Channels Used                       | 1     | 2     | 3 to 4 | 5 to 8 | 9 to 16 |
|---|-------|-------|--------|--------|---------|
| <b>Sub Channel Sample Rate (Data Update Rate)</b> | 200 k | 100 k | 50 k   | 20 k   | 10 k    |
| <b>Main Channel Sample Rate Setting (S/s)</b>     | 100 M | 500 k | 500 k  | 500 k  | 500 k   |
|   | 50 M  | 500 k | 500 k  | 500 k  | 500 k   |
|   | 20 M  | 500 k | 500 k  | 500 k  | 500 k   |
|   | 10 M  | 500 k | 500 k  | 500 k  | 500 k   |
|   | 5 M   | 500 k | 500 k  | 500 k  | 200 k   |
|   | 2 M   | 500 k | 500 k  | 500 k  | 200 k   |
|   | 1 M   | 500 k | 500 k  | 200 k  | 100 k   |
|   | 500 k | 500 k | 100 k  | 100 k  | 50 k    |
|   | 200 k | 200 k | 100 k  | 50 k   | 20 k    |
|   | 100 k | 100 k | 50 k   | 20 k   | 10 k    |
|   | 50 k  | 50 k  | 10 k   | 10 k   | 5 k     |
|   | 20 k  | 20 k  | 10 k   | 5 k    | 2 k     |
|   | 10 k  | 10 k  | 5 k    | 2 k    | 1 k     |
|   | 5 k   | 5 k   | 1 k    | 1 k    | 500     |
|   | 2 k   | 2 k   | 1 k    | 500    | 200     |
|   | 1 k   | 1 k   | 500    | 200    | 100     |
|   | 500   | 500   | 100    | 100    | 50      |
|   | 200   | 200   | 100    | 50     | 20      |
|   | 100   | 100   | 50     | 20     | 10      |
|   | 50    | 50    | 10     | 10     | 5       |
|   | 20    | 20    | 10     | 5      | 2       |
|   | 10    | 10    | 5      | 2      | 1       |
|   | 5     | 5     | 1      | 1      | —       |

: Some data will not be updated. If this occurs, previous data is displayed consecutively.

If you set the sample rate (the main channel sample rate setting) of the DL850E/DL850VE to a rate that exceeds the sub channel data update rate, all data within the sub channel data update interval will be the same.

## 16-CH Temperature/Voltage Input Module

Rate at Which Data Is Written to the Acquisition Memory

| Number of Sub Channels Used                   |       | 1 to 16 |        |       |       |
|---|-------|---------|--------|-------|-------|
| Data Update Period Setting                    |       | 100 ms  | 300 ms | 1 s   | 3 s   |
| <b>Main Channel Sample Rate Setting (S/s)</b> | 100 M | 100 k   | 100 k  | 100 k | 100 k |
|   | 50 M  | 100 k   | 100 k  | 100 k | 100 k |
|   | 20 M  | 100 k   | 100 k  | 100 k | 100 k |
|   | 10 M  | 100 k   | 100 k  | 100 k | 100 k |
|   | 5 M   | 100 k   | 100 k  | 100 k | 100 k |
|   | 2 M   | 100 k   | 100 k  | 100 k | 100 k |
|   | 1 M   | 50 k    | 50 k   | 50 k  | 50 k  |
|   | 500 k | 20 k    | 20 k   | 20 k  | 20 k  |
|   | 200 k | 10 k    | 10 k   | 10 k  | 10 k  |
|   | 100 k | 5 k     | 5 k    | 5 k   | 5 k   |
|   | 50 k  | 2 k     | 2 k    | 2 k   | 2 k   |
|   | 20 k  | 1 k     | 1 k    | 1 k   | 1 k   |
|   | 10 k  | 500     | 500    | 500   | 500   |
|   | 5 k   | 200     | 200    | 200   | 200   |
|   | 2 k   | 100     | 100    | 100   | 100   |
|   | 1 k   | 50      | 50     | 50    | 50    |
|   | 500   | 20      | 20     | 20    | 20    |
|   | 200   | 10      | 10     | 10    | 10    |
|   | 100   | 5       | 5      | 5     | 5     |
|   | 50    | 2       | 2      | 2     | 2     |
| 20  | 1     | 1       | 1      | 1     |       |
| 10  | —     | —       | —      | —     |       |
| 5   | —     | —       | —      | —     |       |

: Some data will not be updated. If this occurs, previous data is displayed consecutively.

If you set the sample rate (the main channel sample rate setting) of the DL850E/DL850VE to a rate that exceeds the data update period, all data within the sub channel data update interval will be the same.



## CAN Bus Monitor Module, CAN & LIN Bus Monitor Module, CAN/CAN FD Monitor Module, and SENT Monitor Moudule

Rate at Which Data Is Written to the Acquisition Memory

| Number of Sub Channels Used                       |       | 1     | 2     | 3 to 4 | 5 to 8 | 9 to 16 | 17 to 32 | 33 to 60 |
|---|-------|-------|-------|--------|--------|---------|----------|----------|
| <b>Sub Channel Sample Rate (Data Update Rate)</b> |       | 100 k | 100 k | 100 k  | 100 k  | 100 k   | 100 k    | 100 k    |
| <b>Main Channel Sample Rate Setting (S/s)</b>     | 100 M | 100 k | 100 k | 100 k  | 100 k  | 100 k   | 100 k    | 100 k    |
|   | 50 M  | 100 k | 100 k | 100 k  | 100 k  | 100 k   | 100 k    | 100 k    |
|   | 20 M  | 100 k | 100 k | 100 k  | 100 k  | 100 k   | 100 k    | 100 k    |
|   | 10 M  | 100 k | 100 k | 100 k  | 100 k  | 100 k   | 100 k    | 100 k    |
|   | 5 M   | 100 k | 100 k | 100 k  | 100 k  | 100 k   | 100 k    | 50 k     |
|   | 2 M   | 100 k | 100 k | 100 k  | 100 k  | 100 k   | 50 k     | 20 k     |
|   | 1 M   | 100 k | 100 k | 100 k  | 100 k  | 50 k    | 20 k     | 10 k     |
|   | 500 k | 100 k | 100 k | 100 k  | 50 k   | 20 k    | 10 k     | 5k       |
|   | 200 k | 100 k | 100 k | 50 k   | 20 k   | 10 k    | 5 k      | 2k       |
|   | 100 k | 100 k | 50 k  | 20 k   | 10 k   | 5 k     | 2 k      | 1k       |
|   | 50 k  | 50 k  | 10 k  | 10 k   | 5 k    | 2 k     | 1 k      | 500      |
|   | 20 k  | 20 k  | 10 k  | 5 k    | 2 k    | 1 k     | 500      | 200      |
|   | 10 k  | 10 k  | 5 k   | 2 k    | 1 k    | 500     | 200      | 100      |
|   | 5 k   | 5 k   | 1 k   | 1 k    | 500    | 200     | 100      | 50       |
|   | 2 k   | 2 k   | 1 k   | 500    | 200    | 100     | 50       | 20       |
|   | 1 k   | 1 k   | 500   | 200    | 100    | 50      | 20       | 10       |
|   | 500   | 500   | 100   | 100    | 50     | 20      | 10       | 5        |
|   | 200   | 200   | 100   | 50     | 20     | 10      | 5        | 2        |
|   | 100   | 100   | 50    | 20     | 10     | 5       | 2        | 1        |
|   | 50    | 50    | 10    | 10     | 5      | 2       | 1        | —        |
| 20  | 20    | 10    | 5     | 2      | 1      | —       | —        |          |
| 10  | 10    | 5     | 2     | 1      | —      | —       | —        |          |
| 5   | 5     | 1     | 1     | —      | —      | —       | —        |          |

If you set the sample rate (the main channel sample rate setting) of the DL850E/DL850VE to a rate that exceeds the sub channel data update rate, all data within the sub channel data update interval will be the same.

## 4-CH 1 MS/s, 16-Bit Isolation Module

|   |       | Sample Rate of the 4-CH 1 MS/s, 16-Bit Isolation Module |  |
|---|-------|---|--|
| <b>Main Channel Sample Rate Setting (S/s)</b> | 100 M | 1 M   | The sample rate (data update rate) of the 4-CH 1MS/s, 16-bit isolation module is always one-half that of the two-channel module regardless of the number of sub channels to be used. |
|   | 50 M  | 1 M   |  |
|   | 20 M  | 1 M   |  |
|   | 10 M  | 1 M   |  |
|   | 5 M   | 1 M   |  |
|   | 2 M   | 1 M   |  |
|   | 1 M   | 500 k   |  |
|   | 500 k | 100 k   |  |
|   | 200 k | 100 k   |  |
|   | 100 k | 50 k  |  |
|   | 50 k  | 10 k  |  |
|   | 20 k  | 10 k  |  |
|   | 10 k  | 5 k   |  |
|   | 5 k   | 1 k   |  |
|   | 2 k   | 1 k   |  |
|   | 1 k   | 500   |  |
|   | 500   | 100   |  |
|   | 200   | 100   |  |
|   | 100   | 50  |  |
|   | 50    | 10  |  |
| 20  | 10    |   |  |
| 10  | 5     |   |  |
| 5   | 1     |   |  |

## Appendix 3 Relationship between the Record Length and the Acquisition Mode

### Maximum Record Length That Can Be Set

The maximum record length varies as indicated below for each model depending on the number of displayed channels.

#### When Dual Capturing and Hard Disk Recording Are Off

| Number of Displayed Channels | Model    |           |           |
|------------------------------|----------|-----------|-----------|
|                              | Standard | /M1 (1 G) | /M2 (2 G) |
| 9 to 16 channels             | 10 M     | 50 M      | 100 M     |
| 5 to 8 channels              | 25 M     | 100 M     | 250 M     |
| 3 to 4 channels              | 50 M     | 250 M     | 500 M     |
| 2 channels                   | 100 M    | 500 M     | 1 G       |
| 1 channel                    | 250 M    | 1 G       | 2 G       |

Unit of record length: Point

#### When Dual Capturing Is Off and Hard Disk Recording Is On

| Number of Displayed Channels | Model    |           |           |
|------------------------------|----------|-----------|-----------|
|                              | Standard | /M1 (1 G) | /M2 (2 G) |
| 9 to 16 channels             | 500 M    | 2 G       | 5 G       |
| 5 to 8 channels              | 1 G      | 5 G       | 10 G      |
| 3 to 4 channels              | 2 G      | 10 G      | 20 G      |
| 2 channels                   | 5 G      | 20 G      | 20 G      |
| 1 channel                    | 10 G     | 20 G      | 50 G      |

Unit of record length: Point

#### When Dual Capturing Is On and Hard Disk Recording Is Off

| Number of Displayed Channels | Model    |           |           |
|------------------------------|----------|-----------|-----------|
|                              | Standard | /M1 (1 G) | /M2 (2 G) |
| 9 to 16 channels             | 5 M      | 25 M      | 50 M      |
| 5 to 8 channels              | 10 M     | 50 M      | 100 M     |
| 3 to 4 channels              | 25 M     | 100 M     | 250 M     |
| 2 channels                   | 50 M     | 250 M     | 500 M     |
| 1 channel                    | 100 M    | 500 M     | 1 G       |

Unit of record length: Point

#### When Dual Capturing and Hard Disk Recording Are On

| Number of Displayed Channels | Model    |           |           |
|------------------------------|----------|-----------|-----------|
|                              | Standard | /M1 (1 G) | /M2 (2 G) |
| 9 to 16 channels             | 500 M    | 2 G       | 5 G       |
| 5 to 8 channels              | 1 G      | 5 G       | 10 G      |
| 3 to 4 channels              | 2 G      | 10 G      | 20 G      |
| 2 channels                   | 5 G      | 20 G      | 20 G      |
| 1 channel                    | 10 G     | 20 G      | 50 G      |

Unit of record length: Point

### Maximum Number of History Waveform Acquisitions

The maximum number of acquisitions varies for each module as indicated below.

| Record Length | Model          |                |                |
|---------------|----------------|----------------|----------------|
|               | Standard       | /M1 (1 G)      | /M2 (2 G)      |
| 1 k           | 5000           | 5000           | 5000           |
| 2.5 k         | 5000           | 5000           | 5000           |
| 5 k           | 2976           | 5000           | 5000           |
| 10 k          | 1487           | 5000           | 5000           |
| 25 k          | 593            | 2381           | 5000           |
| 50 k          | 295            | 1189           | 2381           |
| 100 k         | 144            | 583            | 1168           |
| 250 k         | 57             | 236            | 474            |
| 500 k         | 28             | 116            | 235            |
| 1 M           | 13             | 54             | 111            |
| 2.5 M         | 4              | 22             | 46             |
| 5 M           | 1              | 10             | 22             |
| 10 M          | 1              | 4              | 10             |
| 25 M          | 1 <sup>1</sup> | 1              | 3              |
| 50 M          | 1 <sup>2</sup> | 1              | 1              |
| 100 M         | 1 <sup>3</sup> | 1 <sup>1</sup> | 1              |
| 250 M         | 1 <sup>4</sup> | 1 <sup>2</sup> | 1 <sup>1</sup> |
| 500 M         | 0              | 1 <sup>3</sup> | 1 <sup>2</sup> |
| 1 G           | 0              | 1 <sup>4</sup> | 1 <sup>3</sup> |
| 2 G           | 0              | 0              | 1 <sup>4</sup> |

Unit of record length: Point

- 1 When there are eight displayed channels
- 2 When there are four displayed channels
- 3 When there are two displayed channels
- 4 When there is one displayed channel

### Maximum Sample Rate at Which Hard Disk Recording Is Possible

The maximum sample rate varies as indicated below depending on the number of channels that are recorded.

| Maximum Number of Channels | Maximum Sample Rate |
|----------------------------|---------------------|
| 16 channels                | 100 kS/s            |
| 8 channels                 | 200 kS/s            |
| 3 channels                 | 500 kS/s            |
| 1 channel                  | 1 MS/s              |

## Dual Capture Count

The dual capture count varies depending on the maximum number of main waveform capturing channels and the record length of DCAP waveforms as shown below.

| Record length of DCAP waveforms | Maximum number of main waveform capturing channels | Standard Model   |                 | /M1 Model        |                 | /M2 Model        |                 |
|---------------------------------|--|------------------|-----------------|------------------|-----------------|------------------|-----------------|
|                                 |  | HD Recording Off | HD Recording On | HD Recording Off | HD Recording On | HD Recording Off | HD Recording On |
| 5 k                             | 16   | 1488             | 743             | 5000             | 2977            | 5000             | 5000            |
| 10 k                            |  | 743              | 371             | 2977             | 1488            | 5000             | 2977            |
| 25 k                            |  | 296              | 147             | 1190             | 594             | 2382             | 1190            |
| 50 k                            |  | 147              | 73              | 594              | 296             | 1190             | 594             |
| 100 k                           |  | 72               | 35              | 291              | 145             | 584              | 291             |
| 250 k                           |  | 28               | 13              | 118              | 58              | 237              | 118             |
| 500 k                           |  | 13               | 6               | 58               | 28              | 117              | 58              |
| 5 k                             | 8  | 2977             | 743             | 5000             | 2977            | 5000             | 5000            |
| 10 k                            |  | 1488             | 371             | 5000             | 1488            | 5000             | 2977            |
| 25 k                            |  | 594              | 147             | 2382             | 594             | 4765             | 1190            |
| 50 k                            |  | 296              | 73              | 1190             | 296             | 2382             | 594             |
| 100 k                           |  | 145              | 35              | 584              | 145             | 1169             | 291             |
| 250 k                           |  | 58               | 13              | 237              | 58              | 475              | 118             |
| 500 k                           |  | 28               | 6               | 117              | 28              | 236              | 58              |
| 5 k                             | 4  | 5000             | 743             | 5000             | 2977            | 5000             | 5000            |
| 10 k                            |  | 2977             | 371             | 5000             | 1488            | 5000             | 2977            |
| 25 k                            |  | 1190             | 147             | 4765             | 594             | 5000             | 1190            |
| 50 k                            |  | 594              | 73              | 2382             | 296             | 4765             | 594             |
| 100 k                           |  | 291              | 35              | 1169             | 145             | 2339             | 291             |
| 250 k                           |  | 118              | 13              | 475              | 58              | 952              | 118             |
| 500 k                           |  | 58               | 6               | 236              | 28              | 473              | 58              |
| 5 k                             | 2  | 5000             | 743             | 5000             | 2977            | 5000             | 5000            |
| 10 k                            |  | 5000             | 371             | 5000             | 1488            | 5000             | 2977            |
| 25 k                            |  | 2382             | 147             | 5000             | 594             | 5000             | 1190            |
| 50 k                            |  | 1190             | 73              | 4765             | 296             | 5000             | 594             |
| 100 k                           |  | 584              | 35              | 2339             | 145             | 4680             | 291             |
| 250 k                           |  | 237              | 13              | 952              | 58              | 1905             | 118             |
| 500 k                           |  | 117              | 6               | 473              | 28              | 948              | 58              |
| 5 k                             | 1  | 5000             | 743             | 5000             | 2977            | 5000             | 5000            |
| 10 k                            |  | 5000             | 371             | 5000             | 1488            | 5000             | 2977            |
| 25 k                            |  | 4765             | 147             | 5000             | 594             | 5000             | 1190            |
| 50 k                            |  | 2382             | 73              | 5000             | 296             | 5000             | 594             |
| 100 k                           |  | 1169             | 35              | 4680             | 145             | 5000             | 291             |
| 250 k                           |  | 475              | 13              | 1905             | 58              | 3812             | 118             |
| 500 k                           |  | 236              | 6               | 948              | 28              | 1898             | 58              |

## Appendix 4 Default Values

| Operation Key                       | Soft Key     | Setting        |
|-------------------------------------|--------------|----------------|
| <b>CH1 to 16 (HS10M12 (701250))</b> |              |                |
|                                     | V/div        | 50.0 V/div     |
|                                     | Position     | 0.00 div       |
|                                     | Label        | Channel number |
|                                     | Coupling     | DC             |
|                                     | Probe        | 10:1           |
|                                     | BandWidth    | Full           |
|                                     | V Scale      | DIV            |
|                                     | V Zoom       | ×1             |
|                                     | Offset       | 0.0 V          |
|                                     | Invert       | OFF            |
|                                     | Linear Scale | OFF            |

|                                    |              |                |
|------------------------------------|--------------|----------------|
| <b>CH1 to 16 (HS1M16 (701251))</b> |              |                |
|                                    | V/div        | 50.0 V/div     |
|                                    | Position     | 0.00 div       |
|                                    | Label        | Channel number |
|                                    | Coupling     | DC             |
|                                    | Probe        | 10:1           |
|                                    | BandWidth    | Full           |
|                                    | V Scale      | DIV            |
|                                    | V Zoom       | ×1             |
|                                    | Offset       | 0.00 V         |
|                                    | Invert       | OFF            |
|                                    | Linear Scale | OFF            |

|  |              |                |
|--|--------------|----------------|
| <b>CH1 to 16 (NONISO_10M12 (701255))</b> |              |                |
|  | V/div        | 50.0 V/div     |
|  | Position     | 0.00 div       |
|  | Label        | Channel number |
|  | Coupling     | DC             |
|  | Probe        | 10:1           |
|  | BandWidth    | Full           |
|  | V Scale      | DIV            |
|  | V Zoom       | ×1             |
|  | Offset       | 0.0 V          |
|  | Invert       | OFF            |
|  | Linear Scale | OFF            |

|   |              |                |
|---|--------------|----------------|
| <b>CH1 to 16 (HV (with RMS) (701267))</b> |              |                |
|   | V/div        | 5.000 V/div    |
|   | Position     | 0.00 div       |
|   | Label        | Channel number |
|   | Coupling     | DC             |
|   | Probe        | 1:1            |
|   | BandWidth    | Full           |
|   | V Scale      | DIV            |
|   | V Zoom       | ×1             |
|   | Offset       | 0.000 V        |
|   | Invert       | OFF            |
|   | Linear Scale | OFF            |

|   |           |                |
|---|-----------|----------------|
| <b>CH1 to 16 (HV (with RMS) (701268))</b> |           |                |
|   | V/div     | 5.000 V/div    |
|   | Position  | 0.00 div       |
|   | Label     | Channel number |
|   | Coupling  | DC             |
|   | BandWidth | Full           |
|   | V Scale   | DIV            |
|   | V Zoom    | ×1             |
|   | Offset    | 0.000 V        |

| Operation Key | Soft Key     | Setting |
|---------------|--------------|---------|
|               | Invert       | OFF     |
|               | Linear Scale | OFF     |

|  |              |                |
|--|--------------|----------------|
| <b>CH1 to 16 (UNIVERSAL (701261)/UNIVERSAL (AAF) (701262))</b> |              |                |
|  | V/div        | 5.000 V/div    |
|  | Position     | 0.00 div       |
|  | Label        | Channel number |
|  | Coupling     | DC             |
|  | BandWidth    | Full           |
|  | V Scale      | DIV            |
|  | V Zoom       | ×1             |
|  | Offset       | 0.000 V        |
|  | Invert       | OFF            |
|  | Linear Scale | OFF            |

|   |              |                |
|---|--------------|----------------|
| <b>CH1 to 16 (TEMP/HPV (701265/720266))</b> |              |                |
|   | V/div        | 5.000 V/div    |
|   | Position     | 0.00 div       |
|   | Label        | Channel number |
|   | Coupling     | DC             |
|   | BandWidth    | Full           |
|   | V Scale      | DIV            |
|   | V Zoom       | ×1             |
|   | Offset       | 0.000 V        |
|   | Invert       | OFF            |
|   | Linear Scale | OFF            |

|  |              |                 |
|--|--------------|-----------------|
| <b>CH1 to 16 (STRAIN_NDIS (701270)/STRAIN_DSUB (701271))</b> |              |                 |
|  | Value/div    | 4000.0 μSTR/div |
|  | Range        | ±20000 μSTR     |
|  | Label        | Channel number  |
|  | Excitation   | 2 V             |
|  | Gauge Factor | 2               |
|  | BandWidth    | Full            |
|  | Upper        | 20000 μSTR      |
|  | Lower        | -20000 μSTR     |
|  | Range Unit   | μSTR            |
|  | Invert       | OFF             |
|  | Linear Scale | OFF             |

|                                       |              |                |
|---------------------------------------|--------------|----------------|
| <b>CH1 to 16 (ACCL/VOLT (701275))</b> |              |                |
|                                       | V/div        | 50.0 V/div     |
|                                       | Position     | 0.00 div       |
|                                       | Label        | Channel number |
|                                       | Coupling     | DC             |
|                                       | Probe        | 10:01          |
|                                       | BandWidth    | Full           |
|                                       | V Scale      | DIV            |
|                                       | V Zoom       | ×1             |
|                                       | Offset       | 0.00 V         |
|                                       | Invert       | OFF            |
|                                       | Linear Scale | OFF            |

| Operation Key                                   | Soft Key              | Setting        |
|---|-----------------------|----------------|
| <b>CH1 to 16 (FREQ (701281))</b>                |                       |                |
|   | Value/div             | 1 kHz/div      |
|   | Position              | 0.00 div       |
|   | Label                 | Channel number |
|   | FV Setup              | Frequency      |
|   | Input Setup           | User           |
|   | V Scale               | DIV            |
|   | V Zoom                | ×1             |
|   | Offset                | 0.000 Hz       |
|   | Linear Scale          | OFF            |
| <b>CH1 to 16 (HS100M12 (720210 and 720211))</b> |                       |                |
|   | V/div                 | 50.0 V/div     |
|   | Position              | 0.00 div       |
|   | Label                 | Channel number |
|   | Coupling              | DC             |
|   | Probe                 | 10:01          |
|   | BandWidth             | Full           |
|   | V Scale               | DIV            |
|   | V Zoom                | ×1             |
|   | Offset                | 0.0 V          |
|   | Invert                | OFF            |
|   | Linear Scale          | OFF            |
| <b>CH1 to 16 (16CH VOLT (720220))</b>           |                       |                |
|   | V/div                 | 2.000 V/div    |
|   | Position              | 0.00 div       |
|   | Label                 | Channel number |
|   | Coupling              | DC             |
|   | BandWidth             | Full           |
|   | V Scale               | DIV            |
|   | V Zoom                | ×1             |
|   | Offset                | 0 mV           |
|   | Invert                | OFF            |
|   | Linear Scale          | OFF            |
| <b>CH1 to 16 (16CH TEMP/VOLT (720221))</b>      |                       |                |
|   | V/div                 | 2.000 V/div    |
|   | Position              | 0.00 div       |
|   | Data Update Period    | 100 ms         |
|   | Label                 | Channel number |
|   | Coupling              | DC             |
|   | V Scale               | DIV            |
|   | V Zoom                | ×1             |
|   | Offset                | 0.0 mV         |
|   | Invert                | OFF            |
|   | Linear Scale          | OFF            |
| <b>CH1 to 16 (LOGIC (720230))</b>               |                       |                |
|   | Position              | 0.00 div       |
|   | Label                 | Channel number |
|   | Bit Mapping           | Auto           |
| <b>CH13 to 16 (CAN MONITOR (720240))</b>        |                       |                |
|   | All SubChannels Setup |                |
|   | Input                 | OFF            |
|   | Label                 | Channel number |
|   | Message Format        | STD            |
|   | ID (Hex)              | 0              |
|   | Byte Count            | Auto           |
|   | Start Bit             | 0              |
|   | Bit Count             | 8              |
|   | Byte Order            | Big            |
|   | Value Type            | Unsigned       |
|   | Factor                | 1              |
|   | Offset                | 0              |
|   | Port Setup            |                |
|   | FD Standard(CAN FD)   | ISO            |
|   | Bit Rate              | 500 Kbps       |
|   | Sample Point          | 85%            |
|   | Data BitRate(CAN FD)  | 1 Mbps         |
|   | Sample Point(CAN FD)  | 85%            |
|   | Listen Only           | OFF            |
|   | Terminator            | OFF            |
|   | One Shot Out          |                |
|   | Message Type          | CAN FD         |
|   | Message Format        | STD            |
|   | ID (Hex)              | 000            |
|   | Frame                 | Data           |
|   | DLC                   | 0              |
|   | Data (Hex)            | 0x00           |

| Operation Key                              | Soft Key  | Setting        |
|--|---|----------------|
|  | Bit Rate  | 500 Kbps       |
|  | Sample Point  | 85%            |
|  | Sync Jump Width   | 2              |
|  | Bit Sample Num  | 1              |
|  | Listen Only   | OFF            |
|  | Terminator  | OFF            |
|  | Scale   | Auto           |
|  | One Shot Out  |                |
|  | Message Format  | STD            |
|  | ID (Hex)  | 000            |
|  | Frame   | Data           |
|  | DLC   | 0              |
|  | Data (Hex)  | 00 00 00 00    |
|  |   | 00 00 00 00    |
| <b>CH13 to 16 (CAN &amp; LIN (720241))</b> |   |                |
|  | The values for CAN are the same as the values for the 720240. |                |
|  | All SubChannels Setup   |                |
|  | Input   | OFF            |
|  | Label   | Channel number |
|  | ID (Hex)  | 0              |
|  | Start Bit   | 0              |
|  | Bit Count   | 8              |
|  | Byte Order  | Little         |
|  | Value Type  | Unsigned       |
|  | Factor  | 1              |
|  | Offset  | 0              |
|  | Port Setup  |                |
|  | Bit Rate  | 19200 bps      |
|  | Frame Setup   |                |
|  | Data Length   | 1              |
|  | Check Sum   | Classic        |
|  | Scale   | Auto           |
| <b>CH13 to 16 (CAN/CAN FD (720242))</b>    |   |                |
|  | All SubChannels Setup   |                |
|  | Input   | OFF            |
|  | Label   | Channel number |
|  | Message Format  | STD            |
|  | ID (Hex)  | 0              |
|  | Byte Count  | Auto           |
|  | Start Bit   | 0              |
|  | Bit Count   | 8              |
|  | Byte Order  | Big            |
|  | Value Type  | Unsigned       |
|  | Factor  | 1              |
|  | Offset  | 0              |
|  | Port Setup  |                |
|  | FD Standard(CAN FD)   | ISO            |
|  | Bit Rate  | 500 Kbps       |
|  | Sample Point  | 85%            |
|  | Data BitRate(CAN FD)  | 1 Mbps         |
|  | Sample Point(CAN FD)  | 85%            |
|  | Listen Only   | OFF            |
|  | Terminator  | OFF            |
|  | One Shot Out  |                |
|  | Message Type  | CAN FD         |
|  | Message Format  | STD            |
|  | ID (Hex)  | 000            |
|  | Frame   | Data           |
|  | DLC   | 0              |
|  | Data (Hex)  | 0x00           |

## Appendix 4 Default Values

| Operation Key                    | Soft Key                                | Setting                              |          |
|----------------------------------|---|--------------------------------------|----------|
| <b>CH9 to 16 (SENT (720243))</b> |   |                                      |          |
|                                  | SENT Format Setup                       |                                      |          |
|                                  | Clock Tick                              | 3.00 $\mu$ s                         |          |
|                                  | Data Nibbles Number                     | 6                                    |          |
|                                  | Pause Pulse                             | ON                                   |          |
|                                  | CRC Type                                | Recommended                          |          |
|                                  | Slow CH Type                            | Enhanced (ID 8 bit<br>+ Data 12 bit) |          |
|                                  | Fast Channel Multiplexing               | OFF                                  |          |
|                                  | Error Channel Setup                     |                                      |          |
|                                  | Fast Channel CRC                        |                                      |          |
|                                  | Detect                                  | —                                    |          |
|                                  | Error Trigger                           | ON                                   |          |
|                                  | Error Count                             | ON                                   |          |
|                                  | Slow Channel CRC                        |                                      |          |
|                                  | Detect                                  | —                                    |          |
|                                  | Error Trigger                           | ON                                   |          |
|                                  | Error Count                             | ON                                   |          |
|                                  | Nibble Value                            |                                      |          |
|                                  | Detect                                  | —                                    |          |
|                                  | Error Trigger                           | ON                                   |          |
|                                  | Error Count                             | ON                                   |          |
|                                  | Successive Calibration Pulses (Option2) |                                      |          |
|                                  | Detect                                  | OFF                                  |          |
|                                  | Error Trigger                           | ON                                   |          |
|                                  | Error Count                             | ON                                   |          |
|                                  | Pulse Number                            |                                      |          |
|                                  | Detect                                  | —                                    |          |
|                                  | Error Trigger                           | ON                                   |          |
|                                  | Error Count                             | ON                                   |          |
|                                  | Error Count Reset on Start              | ON                                   |          |
|                                  | Input Setup                             |                                      |          |
|                                  | Probe                                   | 1:1                                  |          |
|                                  | Time Out                                | 2000.0ms                             |          |
|                                  | All SubChannels Setup                   |                                      |          |
| Sub channel number               | Data Type                               | Input                                | Label    |
| 1                                | FastCH                                  | ON                                   | CH<x>_F1 |
| 2                                | FastCH                                  | ON                                   | CH<x>_F2 |
| 3                                | FastCH                                  | ON                                   | CH<x>_F3 |
| 4                                | S&C                                     | ON                                   | CH<x>_SC |
| 5                                | SlowCH                                  | ON                                   | CH<x>_S1 |
| 6                                | SlowCH                                  | ON                                   | CH<x>_S2 |
| 7                                | SlowCH                                  | ON                                   | CH<x>_S3 |
| 8                                | SlowCH                                  | ON                                   | CH<x>_S4 |
| 9                                | SlowCH                                  | ON                                   | CH<x>_S5 |
| 10                               | Error Trigger                           | ON                                   | CH<x>_ET |
| 11                               | Error Count                             | ON                                   | CH<x>_EC |
|                                  | (When Data Type is set to FastCH)       |                                      |          |
|                                  | FC                                      | 0x00                                 |          |
|                                  | Endian                                  | Big                                  |          |
|                                  | Start Bit                               |                                      |          |
|                                  | FastCH 1                                | 0                                    |          |
|                                  | FastCH 2                                | 12                                   |          |
|                                  | FastCH 3                                | 0                                    |          |
|                                  | Bit Size                                | 12                                   |          |
|                                  | Value Type                              | Unsigned                             |          |
|                                  | Factor                                  | 1.00                                 |          |
|                                  | Offset                                  | 0.00                                 |          |
|                                  | Unit                                    | ""                                   |          |
|                                  | (When Data Type is set to S&C)          |                                      |          |

| Operation Key                        | Soft Key                                 | Setting         |
|--------------------------------------|--|-----------------|
|                                      | Bit 0                                    |                 |
|                                      | Display                                  | ON              |
|                                      | Label                                    | Bit0            |
|                                      | Bit 1                                    |                 |
|                                      | Display                                  | ON              |
|                                      | Label                                    | Bit1            |
|                                      | Bit 2                                    |                 |
|                                      | Display                                  | ON              |
|                                      | Label                                    | Bit2            |
|                                      | Bit 3                                    |                 |
|                                      | Display                                  | ON              |
|                                      | Label                                    | Bit3            |
|                                      | V Zoom                                   | $\times 1.0$    |
|                                      | (When Data Type is set to SlowCH)        |                 |
|                                      | ID                                       | 0x00            |
|                                      | Start Bit                                | 0               |
|                                      | Bit Size                                 | 12              |
|                                      | Value Type                               | Unsigned        |
|                                      | Factor                                   | 1.00            |
|                                      | Offset                                   | 0.00            |
|                                      | Unit                                     | ""              |
|                                      | (When Data Type is set to Error Trigger) |                 |
|                                      | V Zoom                                   | $\times 1.0$    |
| <b>CH1 to 16 (4CH 1M16 (720254))</b> |  |                 |
|                                      | V/div                                    | 50.00 V/div     |
|                                      | Position                                 | 0.00 div        |
|                                      | Label                                    |                 |
|                                      | Sub channel number 1                     | CH<x>_1         |
|                                      | Sub channel number 2                     | CH<x>_2         |
|                                      | Coupling                                 | DC              |
|                                      | Probe                                    | 10:1            |
|                                      | BandWidth                                | Full            |
|                                      | V Scale                                  | DIV             |
|                                      | V Zoom                                   | $\times 1$      |
|                                      | Offset                                   | 0.00 V          |
|                                      | Invert                                   | OFF             |
|                                      | Linear Scale                             | OFF             |
| <b>START/STOP</b>                    |  |                 |
|                                      | STOP                                     |                 |
| <b>TIME/DIV</b>                      |  |                 |
|                                      | 1 ms/div                                 |                 |
| <b>ACQUIRE</b>                       |  |                 |
|                                      | Record Length                            | 10 k            |
|                                      | Acquisition Mode                         | Normal          |
|                                      | Trigger Mode                             | Auto            |
|                                      | Acquisition Count                        | Infinite        |
|                                      | HD Recording                             | OFF             |
|                                      | Time Base                                | Int             |
| <b>DUAL CAPTURE</b>                  |  |                 |
|                                      | Mode                                     | OFF             |
|                                      | Capture Setup                            |                 |
|                                      | Time/div                                 | 100 $\mu$ s/div |
|                                      | Capture Length                           | 10 k            |
|                                      | Capture Mode                             | Auto            |
|                                      | Select Number                            | Current         |
|                                      | Mag                                      | 100 $\mu$ s/div |
|                                      | Position                                 | 0.0 div         |
|                                      | Window                                   | ON              |
|                                      | Main Ratio                               | 50%             |
|                                      | Window Layout                            | Side            |
|                                      | Format                                   | Main            |
|                                      | Event Display                            | OFF             |

| Operation Key          | Soft Key            | Setting      |
|------------------------|---------------------|--------------|
| <b>FILE</b>            |                     |              |
|                        | Save_Waveform       |              |
|                        | Auto Naming         | Numbering    |
|                        | Data Type           | Binary       |
|                        | Range               | Main         |
|                        | Save_Setup          |              |
|                        | Auto Naming         | Numbering    |
|                        | Save_Others         |              |
|                        | Auto Naming         | Numbering    |
|                        | Data Type           | Screen Image |
|                        | Format              | PNG          |
|                        | Color               | ON           |
| <b>MENU</b>            |                     |              |
|                        | Waveform Save       | ON           |
|                        | Waveform Save Setup |              |
|                        | Auto Naming         | Numbering    |
|                        | Data Type           | Binary       |
|                        | Image Save          | OFF          |
|                        | Image Save Setup    |              |
|                        | Auto Naming         | Numbering    |
|                        | Image Format        | PNG          |
|                        | Color               | ON           |
|                        | Back Ground         | Normal       |
| <b>DISPLAY</b>         |                     |              |
|                        | Format              | Quad         |
|                        | Extra Window        | OFF          |
|                        | Graticule           | Grid         |
|                        | Scale Value         | ON           |
|                        | Setup               |              |
|                        | Allocation Mode     | Auto         |
|                        | Trace Label         | OFF          |
|                        | Dot Connect         | Line         |
|                        | Accumulate          | OFF          |
|                        | Manual Event        | OFF          |
|                        | Ch. Information     | Narrow       |
| <b>X-Y</b>             |                     |              |
|                        | Window1/2           | OFF          |
|                        | Display             | OFF          |
|                        | Start Point         | -5 div       |
|                        | End Point           | 5 div        |
| <b>MODE</b>            |                     |              |
|                        |                     | Auto         |
| <b>POSITION/DELAY</b>  |                     |              |
|                        | Position            | 50.0%        |
|                        | Delay               | 0.0 μs       |
| <b>SIMPLE/ENHANCED</b> |                     |              |
|                        | Setting             | Simple       |
|                        | Source              | CH1          |
|                        | Slope               | Rising       |
|                        | Level               | 0 V          |
|                        | Hysteresis          | <del>A</del> |
|                        | Hold Off            | 0.00 μs      |
| <b>CURSORS</b>         |                     |              |
|                        | Type                | OFF          |
|                        | Horizontal          |              |
|                        | Trace               | CH1          |
|                        | Cursor1             | 3.00 div     |
|                        | Cursor2             | -3.00 div    |
|                        | Vertical            |              |
|                        | Trace               | CH1          |
|                        | Cursor1             | -4.000 div   |
|                        | Cursor2             | 4.000 div    |

| Operation Key   | Soft Key                               | Setting       |
|-----------------|--|---------------|
|                 | Marker                                 |               |
|                 | Marker #                               | Marker1 X     |
|                 | Trace                                  | CH1           |
|                 | Position                               | -3.000 div    |
|                 | Marker From                            | Mark          |
|                 | Degree                                 |               |
|                 | Trace                                  | CH1           |
|                 | Cursor1                                | -4.000 div    |
|                 | Cursor2                                | 4.000 div     |
|                 | RefValue                               | 360           |
|                 | Ref1                                   | -2.000 div    |
|                 | Ref2                                   | 2.000 div     |
|                 | H & V                                  |               |
|                 | Trace                                  | CH1           |
|                 | V-Cursor1                              | -4.000 div    |
|                 | V-Cursor2                              | 4.000 div     |
|                 | H-Cursor1                              | 3.00 div      |
|                 | H-Cursor2                              | -3.00 div     |
| <b>MEASURE</b>  |  |               |
|                 | Mode                                   | OFF           |
|                 | Distal/Mesial/Proximal                 |               |
|                 | Mode                                   | %             |
|                 | Distal                                 | 90.0%         |
|                 | Mesial                                 | 50.0%         |
|                 | Proximal                               | 10.0%         |
|                 | High/Low                               | Auto          |
|                 | Delay Setup                            |               |
|                 | Mode                                   | OFF           |
|                 | Polarity                               | Rising        |
|                 | Edge Count                             | 1             |
|                 | Reference                              | Trace         |
|                 | Range                                  | Main          |
|                 | Time Range1                            | -5.00 div     |
|                 | Time Range2                            | 5.00 div      |
|                 | (When Mode is set to ON, Statistics)   |               |
|                 | 1-Cycle Mode                           | OFF           |
|                 | (When Mode is set to Cycle Statistics) |               |
|                 | Cycle Trace                            | CH1           |
| <b>GO/NO-GO</b> |  |               |
|                 | Mode                                   | OFF           |
|                 | Logic                                  | AND           |
|                 | ActCondition                           | Fail          |
|                 | Sequence                               | Continue      |
|                 | Acquisition Count                      | Infinite      |
|                 | Remote                                 | OFF           |
|                 | Beep                                   | OFF           |
|                 | Print Image                            | OFF           |
|                 | Save Waveform                          | OFF           |
|                 | Save Image                             | OFF           |
|                 | Send Mail                              | OFF           |
|                 | Time Range1                            | -5.00 div     |
|                 | Time Range2                            | 5.00 div      |
| <b>HISTORY</b>  |  |               |
|                 | Display Mode                           | 1 Record      |
|                 | Select Record                          | 0             |
|                 | Start Record                           | 0             |
|                 | End Record                             | Oldest number |
|                 | Search Mode                            | OFF           |



## Appendix 4 Default Values

| Operation Key     | Soft Key          | Setting               | Operation Key  | Soft Key            | Setting        |
|-------------------|-------------------|-----------------------|----------------|---------------------|----------------|
| <b>MATH</b>       |                   |                       | <b>UTILITY</b> |                     |                |
|                   | Mode              | OFF                   |                | System Config       |                |
|                   | Select Math Trace | 1                     |                | Date/Time           |                |
|                   | Opeartion:Math1   | OFF                   |                | Display             | ON             |
|                   | Opeartion:Math2   | OFF                   |                | Format              | Year/Month/Day |
|                   | Opeartion:Math3   | OFF                   |                | Time Synchro        |                |
|                   | Opeartion:Math4   | OFF                   |                | Time Synchro        | OFF            |
|                   | Opeartion:Math5   | OFF                   |                | IRIG Format         | A              |
|                   | Opeartion:Math6   | OFF                   |                | Modulation          | AM             |
|                   | Opeartion:Math7   | OFF                   |                | Impedance           | 50             |
|                   | Opeartion:Math8   | OFF                   |                | Language            |                |
|                   | Scaling Mode      | Auto                  |                | Menu                | English        |
|                   | Start Point       | -5.00 div             |                | Message             | English        |
|                   | End Point         | 5.00 div              |                | LCD                 |                |
|                   | FFT Points        | 1 k                   |                | Auto OFF            | OFF            |
|                   | Window            | Hanning               |                | Auto OFF Time       | 1 min          |
| <b>FFT</b>        |                   |                       |                | Brightness          | 3              |
|                   | Display           | OFF                   |                | Storage Manager     |                |
|                   | Trace             | CH1                   |                | Media               | HD             |
|                   | Start Point       | -5.00 div             |                | USB Keyboard        | English        |
|                   | FFT Points        | 1 k                   |                | USB Function        | TMC            |
|                   | Window            | Hanning               |                | Remote Ctrl         |                |
|                   | Vert. Scale Mode  | Auto                  |                | Device              | USB            |
|                   | Main Ratio        | 50%                   |                | USB Function        | TMC            |
|                   | Window Layout     | Side                  |                | Network             |                |
|                   | Horiz. Axis       | Log Hz                |                | TCP/IP              |                |
| <b>ZOOM</b>       |                   |                       |                | DHCP                | ON             |
|                   | Display (Zoom1)   | ON                    |                | DNS                 | Auto           |
|                   | Display (Zoom2)   | OFF                   |                | FTP/Web Server      |                |
|                   | Position          | 0.00 div              |                | User Name           | anonymous      |
|                   | Main Ratio        | 50%                   |                | TimeOut(s)          | 1800           |
|                   | Window Layout     | Side                  |                | TimeOut (s)         | 15             |
|                   | Format Zoom1      | Main                  |                | Mail                |                |
| <b>SEARCH</b>     |                   |                       |                | Attached Image File | OFF            |
|                   | Type              | Edge                  |                | TimeOut (s)         | 15             |
|                   | Edge              |                       |                | Net Print           |                |
|                   | Trace             | CH1                   |                | LPR Name            | PASSTHRU       |
|                   | Level             | 0.0 V                 |                | TimeOut (s)         | 15             |
|                   | Polarity          | Rising                |                | Net Drive           |                |
|                   | Hysteresis        |                       |                | LoginName           | anonymous      |
|                   | Count             | 1                     |                | Passive             | ON             |
|                   | Result Window     | Zoom1                 |                | TimeOut (s)         | 1800           |
|                   | Pattern No.       | No Match              |                | SNTP                |                |
|                   | Event             |                       |                | TimeOut (s)         | 3              |
|                   | Select Number     | 1                     |                | Adjust at PowerON   | OFF            |
|                   | Result Window     | Zoom1                 |                | Preference          |                |
|                   | Select Event      | Capture               |                | Power On Action     |                |
|                   | Logic Pattern     |                       |                | Start               | OFF            |
|                   | Trace             | Installation channel  |                | Action              | OFF            |
|                   | Bit Setting       | X                     |                | Logic Setup         |                |
|                   | Result Window     | Zoom1                 |                | Numerical Format    | Bit            |
|                   | Pattern No.       | No Match              |                | Cursor Order        | 1 -> 8         |
|                   | Start Point       | -5.00 div             |                | Bit Order           | 1 -> 8         |
|                   | End Point         | 5.00 div              |                | Terminal Setup      |                |
|                   | Time              |                       |                | Remote Stop         | On             |
|                   | Absolute Time     | Current date and time |                | Trigger Out         | Normal         |
|                   | Result Window     | Zoom1                 |                | Pulse Width         | 1 msec         |
| <b>PRINT MENU</b> |                   |                       |                | Display Setup       |                |
|                   | Print To          | Builtin               |                | Menu Font Size      | Large          |
|                   |                   |                       |                | Base Color          | Blue           |
|                   |                   |                       |                | Scale Font Size     | Large          |
|                   |                   |                       |                | Scale On Item       | All            |

| Operation Key | Soft Key              | Setting  |
|---------------|-----------------------|----------|
|               | Level Indicator       | On       |
|               | Horizontal Axis       | Auto     |
|               | Display Mode          |          |
|               | Intensity             |          |
|               | Grid                  | 2        |
|               | Cursor                | 8        |
|               | Marker                | 8        |
|               | Key/Knob Setup        |          |
|               | Click Sound           | ON       |
|               | START/STOP            | Quick    |
|               | Response Time         |          |
|               | Key Protect           |          |
|               | Type                  | All      |
|               | Release Type          | Key      |
|               | Analysis Setup        |          |
|               | Cursor Read Mode      | Display  |
|               | Action Folder Mode    | ON       |
|               | Input Setup DC Offset | OFF      |
|               | & Adjust              |          |
|               | Self Test             | Keyboard |

## Appendix 5 USB Keyboard Key Assignments

| DL850E/DL850EV                      | USB Keyboard   |
|-------------------------------------|--|
| AQUIRE                              | CTRL+A   |
| MATH                                | CTRL+B   |
| Execute PRINT                       | CTRL+C or PRINT SCREEN                               |
| DISPLAY                             | CTRL+D   |
| FILE                                | CTRL+F   |
| HELP                                | CTRL+G   |
| HISTORY                             | CTRL+H   |
| Execute SAVE                        | CTRL+I   |
| MANUALTRIG                          | CTRL+J   |
| KEY PROTECT                         | CTRL+K   |
| ALL CH                              | CTRL+L   |
| MEASURE                             | CTRL+M   |
| NUM LOCK                            | CTRL+N   |
| POSITION/DELAY                      | CTRL+P   |
| Execute CLEAR TRACE                 | CTRL+Q   |
| Execute RESET                       | CTRL+R   |
| SHIFT                               | CTRL+S   |
| MODE (TRIGGER)                      | CTRL+T   |
| CURSOR                              | CTRL+U   |
| ANALYSIS                            | CTRL+X   |
| SIMPLE/ENHANCED                     | CTRL+W   |
| ZOOM                                | CTRL+Z   |
| CH1                                 | CTRL+1   |
| CH2                                 | CTRL+2   |
| CH3                                 | CTRL+3   |
| CH4                                 | CTRL+4   |
| CH5                                 | CTRL+5   |
| CH6                                 | CTRL+6   |
| CH7                                 | CTRL+7   |
| CH8                                 | CTRL+8   |
| CH9                                 | CTRL+9   |
| CH10                                | CTRL+0   |
| SET                                 | CTRL+ENTER   |
| SETUP                               | CTRL+\   |
| UTILITY                             | CTRL+/   |
| CH11                                | CTRL+F1  |
| CH12                                | CTRL+F2  |
| CH13                                | CTRL+F3  |
| CH14                                | CTRL+F4  |
| CH15                                | CTRL+F5  |
| CH16                                | CTRL+F6  |
| Turn ZOOM POSITION to the right     | CTRL+INSERT  |
| Turn VERTICAL POSITION to the right | CTRL+HOME  |
| Turn ZOOM POSITION to the left      | CTRL+DELETE  |
| Turn VERTICAL POSITION to the left  | CTRL+END   |
| START/STOP                          | CTRL+* or F12  |
| DUAL CAPTURE                        | CTRL+SHIFT+A   |
| FFT                                 | CTRL+SHIFT+B   |
| PRINT MENU                          | CTRL+SHIFT+C   |
| X-Y                                 | CTRL+SHIFT+D   |
| MENU                                | CTRL+SHIFT+I   |
| GO/NO-GO                            | CTRL+SHIFT+M   |
| ACTION                              | CTRL+SHIFT+T   |
| SEARCH                              | CTRL+SHIFT+Z   |
| CAL                                 | CTRL+SHIFT+\   |
| EXP (CH key)                        | E when NUM LOCK is illuminated on the DL850E/DL850EV |
| k (CH key) + ENTER (CH key)         | K when NUM LOCK is illuminated on the DL850E/DL850EV |

## Appendix 5 USB Keyboard Key Assignments

| DL850E/DL850EV                        | USB Keyboard   |
|---------------------------------------|--|
| m (CH key) + ENTER (CH key)           | M when NUM LOCK is illuminated on the DL850E/DL850EV     |
| 1 (CH key)                            | 1 when NUM LOCK is illuminated on the DL850E/DL850EV     |
| 2 (CH key)                            | 2 when NUM LOCK is illuminated on the DL850E/DL850EV     |
| 3 (CH key)                            | 3 when NUM LOCK is illuminated on the DL850E/DL850EV     |
| 4 (CH key)                            | 4 when NUM LOCK is illuminated on the DL850E/DL850EV     |
| 5 (CH key)                            | 5 when NUM LOCK is illuminated on the DL850E/DL850EV     |
| 6 (CH key)                            | 6 when NUM LOCK is illuminated on the DL850E/DL850EV     |
| 7 (CH key)                            | 7 when NUM LOCK is illuminated on the DL850E/DL850EV     |
| 8 (CH key)                            | 8 when NUM LOCK is illuminated on the DL850E/DL850EV     |
| 9 (CH key)                            | 9 when NUM LOCK is illuminated on the DL850E/DL850EV     |
| 0 (CH key)                            | 0 when NUM LOCK is illuminated on the DL850E/DL850EV     |
| ENTER (CH key)                        | ENTER when NUM LOCK is illuminated on the DL850E/DL850EV |
| . (CH key)                            | . when NUM LOCK is illuminated on the DL850E/DL850EV     |
| - (CH key)                            | - when NUM LOCK is illuminated on the DL850E/DL850EV     |
| ESC                                   | ESC or F8  |
| Select soft key 1                     | F1   |
| Select soft key 2                     | F2   |
| Select soft key 3                     | F3   |
| Select soft key 4                     | F4   |
| Select soft key 5                     | F5   |
| Select soft key 6                     | F6   |
| Select soft key 7                     | F7   |
| SNAPSHOT                              | PAUSE  |
| Turn ZOOM MAG to the right            | INSERT   |
| Turn VERTICAL SCALE to the right      | HOME   |
| Turn HORIZONTAL TIME/DIV to the right | PAGE UP  |
| Turn ZOOM MAG to the left             | DELETE   |
| Turn VERTICAL SCALE to the left       | End  |
| Turn HORIZONTAL TIME/DIV to the left  | PageDown   |
| Right arrow                           | →  |
| Left arrow                            | ←  |
| Up arrow                              | ↑  |
| Down arrow                            | ↓  |

# Appendix 6 Block Diagrams

## Block Diagram of the DL850E/DL850EV

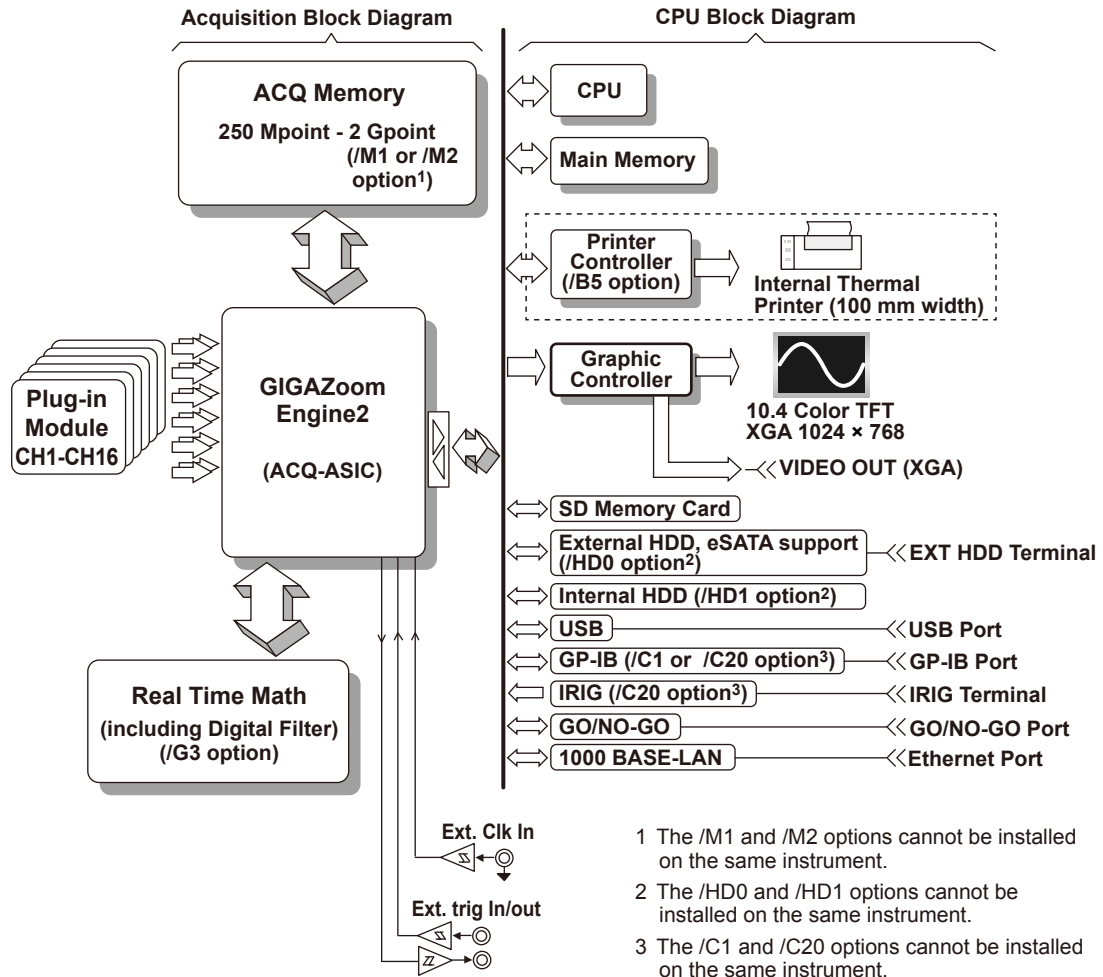

### Signal Flow of the DL850E/DL850EV

The input terminal signal flow varies for each model. In this example, we will explain the signal flow for the High-Speed 10 MS/s, 12-Bit Isolation Module, 701250 (HS10 M12). (For the signal flow of a particular module, see the module's block diagram.)

The input signal applied to the two input terminals is first processed by each module's input section. In the 701250 (HS10 M12), the signal is attenuated and amplified by an attenuator (ATT) and amplifier (AMP). Then, the signal's bandwidth is limited by a filter (FLT). Next, the signal is sampled at a rate of 10 MS/s (10,000,000 times a second) by an A/D converter and converted into digital data. Then, the signal passes through an isolator and an ASIC to a waveform-processing ASIC (ACQ-ASIC).

The 16 channel of digital data that is sent to the CPU board passes through the GIGAZoom Engine2 waveform processor and is stored to the acquisition memory (ACQ Memory). The digital data stored to the ACQ memory is compressed quickly by the GIGAZoom Engine2, and then it passes through a graphic controller and is shown on the XGA TFT color display.

The realtime math feature (/G3 option) uses the A/D converted data of the analog input channels or the math results of realtime math channels or both as its math sources and performs math operations on the specified channels in real time.

You can use the DL850E/DL850EV to perform realtime math on up to 16 channels at the same time.

Plug-in Module Block Diagram

701250 (HS10M12)  
720250 (HS10M12)

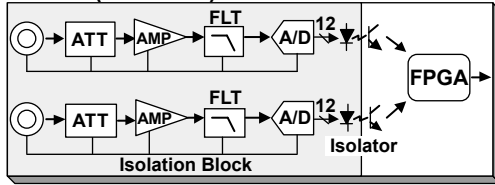

701251 (HS1M16)

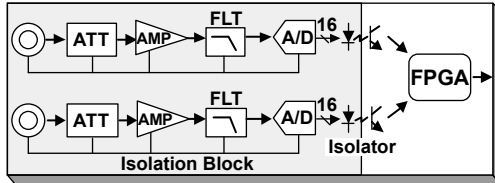

701255 (NONISO\_10M12)

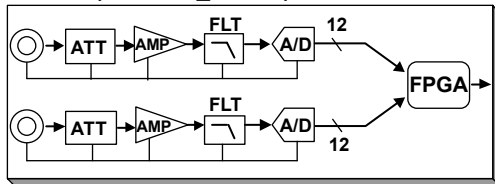

701267 (HV (with RMS))  
720268 (HV (AAF, RMS))

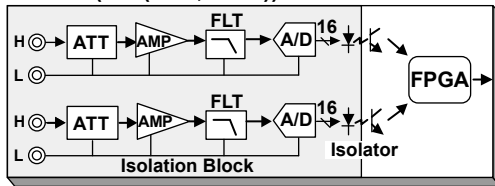

701261 (UNIVERSAL)  
701262 (UNIVERSAL (AAF))

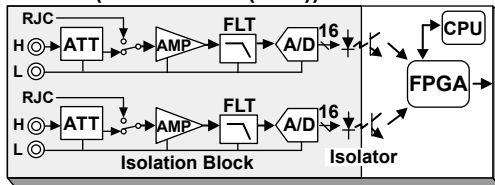

701265 (TEMP/HPV)  
720266 (TEMP/HPV)

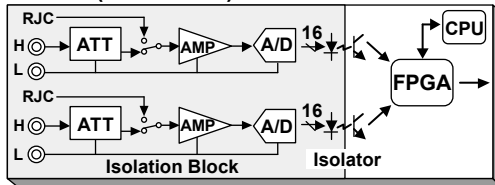

701270 (STRAIN\_NDIS)  
701271 (STRAIN\_DSUB)

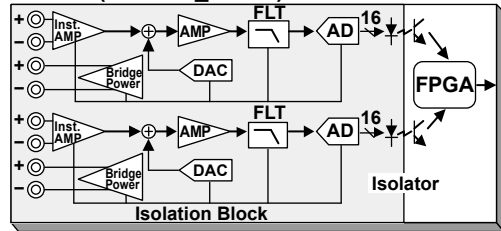

701275 (ACCL/VOLT)

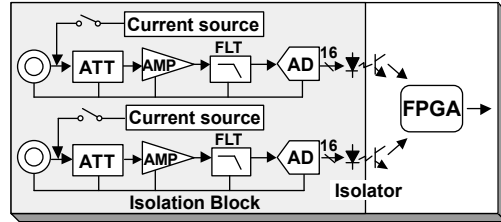

701281 (FREQ)  
720281 (FREQ)  
720243 (SENT)

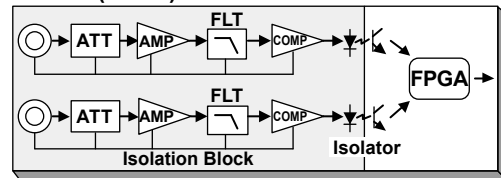

720210 (HS100M12)  
720211 (HS100M12)

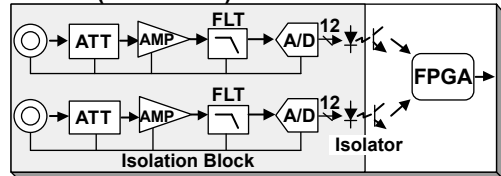

720220 (16CHVOLT)

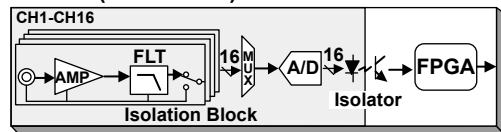

701953 (16CH SCANNER BOX)

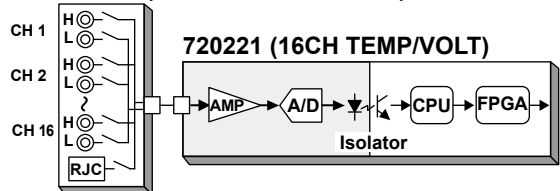

720230 (LOGIC)

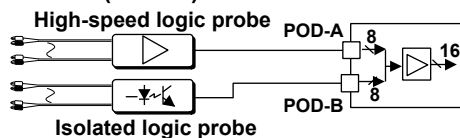

Appendix 6 Block Diagrams

**720240 (CAN MONITOR)**

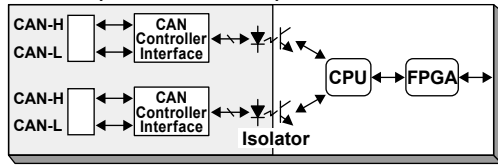

**720241 (CAN & LIN)**

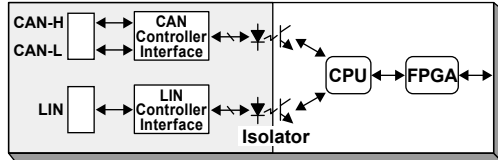

**720242 (CAN/CAN FD MONITOR)**

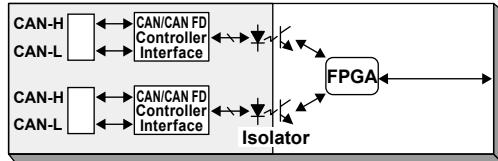

**720254 (4CH 1M16)**

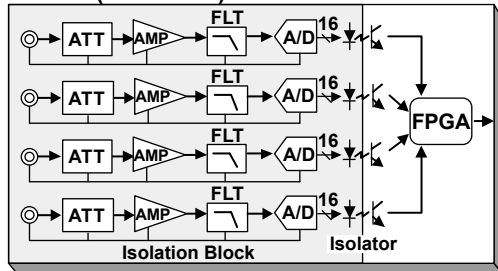

# Appendix 7 High-Voltage 100 kS/s, 16-Bit Isolation Module (with RMS) (701260) Specifications

The specifications for the High-Voltage 100 kS/s, 16-Bit Isolation Module (with RMS) (701260) are provided below. This input module (701260) does not comply with safety standard EN 61010-1 or EN 61010-2-030 as of September 30, 2013.

| Item  | Specifications  |
|---|---|
| Standard operating conditions   | Temperature: 23 ±5°C<br>Humidity: 20 to 80% RH<br>After a 30-minute warm-up and after calibration   |
| Effective measurement range   | 20 div (display range: 10 div)  |
| Number of input channels  | 2   |
| Input coupling  | AC, DC, GND, AC-RMS, and DC-RMS   |
| Maximum sample rate   | 100 kS/s  |
| Input format  | Isolated unbalanced   |
| Frequency characteristics <sup>1</sup><br>(-3 dB point when a sine wave of amplitude ±3 div is applied) | Waveform observation mode: DC to 40 kHz<br>RMS observation mode: DC, 40 Hz to 10 kHz  |
| Voltage-axis sensitivity setting  | 20 mV/div to 200 V/div (1-2-5 steps) (when using 1:1 probe attenuation)   |
| Maximum input voltage (at a frequency of 1 kHz or less)   | Combined with the 700929 (10:1), 702902 (10:1) or 701947 (100:1): <sup>2</sup><br>1000 V (DC+ACpeak)<br>Combined with the 701901+701954 (1:1): <sup>5</sup><br>850 V (DC+ACpeak)<br>Direct input or cable not complying with the safety standard: <sup>8</sup><br>42 V (DC+ACpeak)  |
| Maximum rated voltage to earth  | Working voltage of safety standard  |
| Between input and case  | Combined with the 700929 (10:1), 702902 (10:1), or 701947 (100:1)   |
| Between each input (at a frequency of 1 kHz or less)  | Across probe tip H and earth: <sup>3</sup> 1000 Vrms (CAT II)<br>Across probe tip L and earth: <sup>4</sup> 400 Vrms (CAT II)<br>Combined with the 701901+701954 (1:1)<br>Across tip H and earth: <sup>6</sup> 700 Vrms (CAT II)<br>Across tip L and earth: <sup>7</sup> 400 Vrms (CAT II)<br>Direct input or cable not complying with the safety standard<br>Across the input terminal, H or L, and earth: <sup>9</sup> 42 V (DC+ACpeak) (CAT II, 30 Vrms) |
| Vertical (voltage) axis accuracy DC accuracy <sup>1</sup>   | Waveform observation mode<br>DC accuracy ±(0.25% of 10 div)<br>RMS observation mode<br>DC accuracy ±(1.0% of 10 div)<br>AC accuracy (when a sine wave is input) ±(1.5% of 10 div) At frequency of 40 Hz to 1 kHz<br>AC accuracy (when the crest factor is 2 or less) ±(2.0% of 10 div) At frequency of 40 Hz to 1 kHz<br>AC accuracy (when the crest factor is 3 or less) ±(3.0% of 10 div) At frequency of 40 Hz to 1 kHz                                  |
| Input connector   | BNC connector (isolated type)   |
| Input impedance   | 1 MΩ ± 1%, approx. 35 pF  |
| -3 dB point when AC coupled low frequency attenuation point   | 1 Hz or less (0.1 Hz or less when using the 700929 or 702902, 0.01 Hz or less when using the 701947)  |
| Common mode rejection ratio   | 80 dB (50/60 Hz) or more (Typical <sup>10</sup> )   |
| Residual noise level (Input section shorted)  | ±1 mV or ±0.02 div whichever is greater (Typical <sup>10</sup> )  |
| Withstand voltage   | 3700 Vrms for 1 minute (across each terminal and earth) (60 Hz)   |
| Allowable transient surge voltage (instantaneous)   | ±5200 Vpeak (across each input terminal and earth)  |
| Insulation resistance   | 500 VDC, 10 MΩ or more (across each input terminal and earth)   |
| A/D conversion resolution   | 16 bit (2400 LSB/div)   |
| Temperature coefficient   | Zero point: ±(0.02% of 10 div)/°C (Typical <sup>10</sup> )<br>Gain: ±(0.02% of 10 div)/°C (Typical <sup>10</sup> )  |
| Response time (only when observing RMS)   | Rising (0 to 90% of 10 div): 100 ms (Typical <sup>10</sup> )<br>Falling (100 to 10% of 10 div): 250 ms (Typical <sup>10</sup> )   |



## Appendix 7 High-Voltage 100 kS/s, 16-Bit Isolation Module (with RMS) (701260) Specifications

| Item                         | Specifications  |
|------------------------------|---|
| Bandwidth limit              | Select from Full, 10 kHz, 1 kHz, and 100 Hz<br>Cut-off characteristics: -12 dB/OCT (Typical <sup>10</sup> )   |
| Probe attenuation setting    | Voltage probe: 1:1, 10:1, 100:1, 1000:1<br>Current probe: 1 A:1 V, 10 A:1 V (for the 701932/701933), 100 A: 1 V (for the 701930/701931)   |
| Compatible probes/<br>cables | Connection cable (for high voltage 1:1): Recommended 1<br>701901 (isolated type BNC-safety alligator clip adapter ×2: For measuring 850 V (DC+ACpeak) or less), 701954 (alligator clip (dolphin type) red/black 2-piece set) is required separately<br>Voltage probe: Recommended 2<br>700929 (10:1 safety probe), 20 to 45 pF: For measuring 1000 V (DC+ACpeak) or less<br>702902 (10:1 safety probe), 25 to 40 pF: For measuring 1000 V (DC+ACpeak) or less<br>701947 (100:1 probe), 15 to 45 pF: For measuring 1000 V (DC+ACpeak) or less<br>Current probe (power can be supplied from the DL850E/DL850EV. Option)<br>701930 (150 A), 701931 (500 A), 701932 (30 A), 701933 (30 A) |

1 Value measured under standard operating conditions.

Combined with the 700929, 702902, or 701947

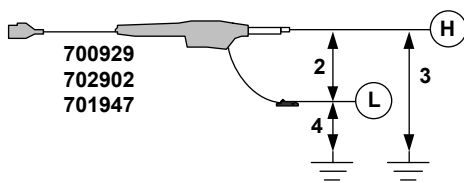

Combined with the 701901+701954

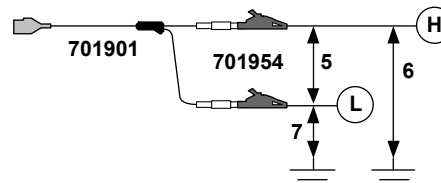

Direct input (cable that does not comply with the safety standards)

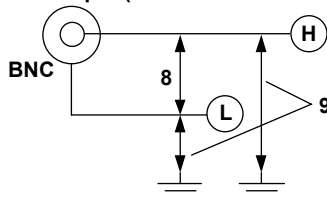

Withstand voltage: 3700 Vrms for 1 minute  
Allowable transient surge voltage: ±5200 Vpeak  
(between earth and input)

10 The typical value is a representative or standard value. It is not strictly warranted.



### WARNING

- To receive high voltage with the module, use a 1:1 safety cable (combination of 701901 and 701954), isolated probe (700929, 701947), or passive probe 702902.
- Note that the overvoltage tolerance of the low and high sides of this module may differ depending on the combination of the connected probe, measurement lead, and clip.

### French



### AVERTISSEMENT

- Pour recevoir une tension élevée avec le module, utiliser un câble de sécurité 1:1 (combinaison de 701901 et 701954), une sonde isolée (700929, 701947) ou une sonde passive 702902.
- Noter que la tolérance de surtension des du bas et du haut de ce module peut être différente suivant la combinaison de sonde reliée, de fil de mesure et de pince.

# Appendix 8 Frequency Module (701280) Specifications

The specifications for the Frequency Module (701280) are provided below. This module does not comply with environmental standard EN 50581.

| Item   | Specifications  |
|--|---|
| Standard operating conditions  | Temperature: 23 ±5°C<br>Humidity: 20 to 80% RH<br>After a 30-minute warm-up and after calibration   |
| Measurement function   | Frequency, RPMs, RPSs, period, duty cycle, power supply frequency, pulse width, pulse integration, and velocity   |
| Effective measurement range  | 20 div (display range: 10 div)  |
| Number of input channels   | 2   |
| Data update rate   | 25 kHz (40 µs)  |
| Output delay time  | Up to 2 computation periods   |
| Input format   | Isolated unbalanced   |
| Input connector  | Metal BNC connector   |
| Maximum input voltage  | Combined with the 700929 (10:1), 702902 (10:1), or 701947 (100:1): <sup>2</sup><br>420 V (DC+ACpeak)<br>Combined with the (701901 + 701954) (1:1) or direct input (cable that does not comply with the safety standards): <sup>4</sup><br>42 V (DC+ACpeak)  |
| Maximum rated voltage to earth<br>Between input and case<br>Between each input | Working voltage of safety standard<br>Combined with the 700929 (10:1), 702902 (10:1), or 701947 (100:1): <sup>3</sup><br>300 Vrms (CAT II)<br>Combined with the (701901 + 701954) (1:1) or direct input (cable that does not comply with the safety standards): <sup>5</sup><br>42 V (DC+ACpeak) (CAT II, 30 Vrms)  |
| Withstand voltage  | 1500 Vrms for 1 minute (across each terminal and earth) (60 Hz)   |
| Allowable transient surge voltage (instantaneous)                              | ±2100 Vpeak (across each input terminal and earth)  |
| Insulation resistance  | 500 VDC, 10 MΩ or more (across each input terminal and earth)   |
| Minimum measurement resolution   | 50 ns   |
| Measured data resolution   | 16 bits (2400 LSB/div)  |
| Measurement accuracy <sup>1</sup>  | <ul style="list-style-type: none"> <li>• <b>When in frequency, RPM, RPS, or velocity measurement mode<sup>6</sup></b><br/>Measurement accuracy is specified according to the measurement range and input frequency<br/>[Definition of measurement accuracy]<br/>±(0.05% of 10 div + accuracy dependent on the input frequency)<br/>[Accuracy dependent on the input frequency]<br/>When input frequency is 2 kHz or less: 0.05% of the input frequency + 0.001 Hz<br/>Input frequency of 2 kHz to 10 kHz: 0.1% of the input frequency<br/>Input frequency of 10 kHz to 20 kHz: 0.3% of the input frequency<br/>Input frequency of 20 kHz or higher: 0.5% of the input frequency</li> <li>• <b>When in power supply frequency mode<sup>7</sup></b><br/>When the center frequency is 50/60 Hz: ±0.03 Hz (0.01 Hz resolution)<br/>When the center frequency is 400 Hz: ±0.3 Hz (0.01 Hz resolution)<br/>(Input set to AC100 V or AC200 V with sine wave input)</li> <li>• <b>When in period measurement mode<sup>6</sup></b><br/>Measurement accuracy is specified according to the measurement range and input period<br/>[Definition of measurement accuracy]<br/>±(0.05% of 10 div + accuracy dependent on the input period)<br/>[Accuracy dependent on the input period]<br/>Input period of 500 µs or greater: 0.05% of the input period<br/>Input period of 100 µs to 500 µs: 0.1% of the input period<br/>Input period of 50 µs to 100 µs: 0.3% of the input period<br/>Input period of 50 µs or less: 0.5% of the input period + 0.1 µs</li> </ul> |

## Appendix 8 Frequency Module (701280) Specifications

| Item                                      | Specifications  |
|---|---|
|   | <ul style="list-style-type: none"> <li>• <b>When in duty cycle measurement mode<sup>8</sup></b><br/>Dependent on the input frequency<br/>Input frequency of 1 kHz or less: <math>\pm 0.1\%</math><br/>Input frequency of 1 kHz to 10 kHz: <math>\pm 0.2\%</math><br/>Input frequency of 10 kHz to 50 kHz: <math>\pm 1.0\%</math><br/>Input frequency of 50 kHz to 100 kHz: <math>\pm 2.0\%</math><br/>Input frequency of 100 kHz to 200 kHz: <math>\pm 4.0\%</math></li> <li>• <b>When in pulse width measurement mode<sup>8</sup></b><br/>Measurement accuracy is specified according to the measurement range and input pulse width<br/>[Definition of measurement accuracy]<br/><math>\pm(0.05\%</math> of 10 div + accuracy dependent on the input pulse width)<br/>[Accuracy dependent on the input pulse width]<br/>Input pulse width of 500 <math>\mu\text{s}</math> or greater: 0.05% of the input pulse width<br/>Input pulse width of 100 <math>\mu\text{s}</math> to 500 <math>\mu\text{s}</math>: 0.1% of the input pulse width<br/>Input pulse width of 50 <math>\mu\text{s}</math> to 100 <math>\mu\text{s}</math>: 0.3% of the input pulse width<br/>Input pulse width of 50 <math>\mu\text{s}</math> or less: 0.5% of the input pulse width + 0.1 <math>\mu\text{s}</math></li> </ul> |
| Input voltage range ( $\pm\text{FS}$ )    | When using 1:1 probe attenuation: $\pm 1\text{ V}, \pm 2\text{ V}, \pm 5\text{ V}, \pm 10\text{ V}, \pm 20\text{ V}, \pm 50\text{ V}$ ( $\pm\text{FS}$ )  |
| Input impedance                           | 1 M $\Omega$ $\pm$ 1 approx. 35 pF<br>Pull-up function: 4.7 k $\Omega$ , approx. 5 V (pull-up can be turned ON only when the input is set to Pull-up 5 V)   |
| Input coupling settings                   | AC, DC  |
| Probe attenuation setting                 | 10:1, 1:1   |
| Minimum voltage width for pulse detection | 200 mV <sub>P-P</sub>   |
| Bandwidth limit                           | Select from Full, 100 kHz, 10 kHz, 1 kHz, and 100 Hz<br>Cutoff characteristics: -12 dB/OCT (Typical <sup>9</sup> )  |
| Threshold                                 | Set within the FS of the voltage range. Set in units of 1% of the FS.   |
| Hysteresis                                | Select $\pm 1\%$ , $\pm 2.5\%$ , or $\pm 5\%$ of the FS of the voltage range  |
| Preset function                           | Logic (5 V/3 V/12 V/24 V), electromagnetic pickup, zero crossing, pull-up, AC100 V, AC200 V, and user-defined   |
| Slope selection                           | Select rising or falling  |
| Lower -3 dB point when AC coupled         | 0.5 Hz or less (0.05 Hz or less when using the 700929 or 702902, 0.005 Hz or less when using the 701947) (Typical <sup>9</sup> )  |
| Chatter elimination function              | OFF or 1 to 1000 ms (1 ms resolution)<br>Eliminates the chatter that occurs such when the contact input is turned ON/OFF.<br>Can discard the signal changes over the specified interval.  |
| Input status indication function          | Input status indication through the LEDs of each channel function<br>When in operation: Illuminates in green when pulse input is detected<br>When overdriven: Illuminates in red when the input voltage exceeds the range   |
| Compatible probes/cables                  | Connection cable (1:1): Recommended 1<br>366926<br>Voltage probe: Recommended 2<br>700929 (10:1 safety probe), 20 to 45 pF<br>702902 (10:1 safety probe), 25 to 40 pF<br>701947 (100:1 probe), 15 to 45 pF  |

1 Value measured under standard operating conditions.

Combined with the 700929, 702902, or 701947

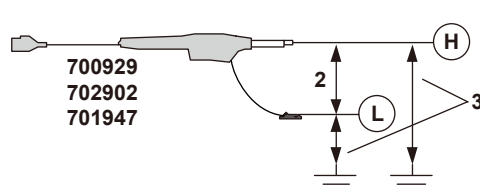

Combined with the (701901 + 701954) or direct input (cable that does not comply with the safety standards)

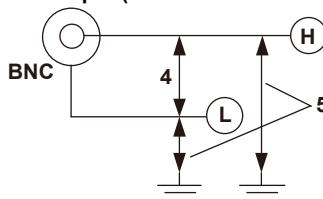

**Withstand voltage: 1500 Vrms for 1 minute**

**Allowable transient surge voltage (between earth and input):  $\pm 2100\text{ Vpeak}$**

6 Input waveform of 1 Vpp, rectangular wave, rise/fall time within 1 ms (input range:  $\pm 10\text{ V}$ , bandwidth limit: Full, and hysteresis:  $\pm 1\%$ )

7 Input waveform of 90 Vrms, sine wave (input range: AC100 V, bandwidth limit 100 kHz, and hysteresis:  $\pm 1\%$ )

8 Input waveform of 1 Vpp, rectangular wave, rise/fall time within 5 ns (input range:  $\pm 10\text{ V}$ , bandwidth limit: Full, and hysteresis:  $\pm 1\%$ )

9 Typical value represents a typical or average value. It is not strictly warranted.

## Specifications by Measurement Modes

| Item                                 | Specifications   |
|--------------------------------------|--|
| Frequency                            |  |
| Measurable frequency range           | 0.01 Hz to 200 kHz   |
| Selectable vertical axis sensitivity | 0.1 Hz/div to 50 kHz/div (1-2-5 steps)   |
| Minimum resolution                   | 0.001 Hz   |
| RPMs                                 |  |
| Measurable RPMs range                | 0.01 rpm to 100000 rpm (where the input frequency is DC to 200 kHz).   |
| Selectable vertical axis sensitivity | 0.1 rpm/div to 10 krpm/div (1-2-5 steps)   |
| Computing method                     | Computed from the frequency based on the number of pulses per rotation<br>RPMs = Frequency/(pulse/rotate value) × 60   |
| Selectable pulse/rotate range        | 1 to 99999   |
| RPSs                                 |  |
| Measurable RPSs range                | 0.001 rps to 2000 rps (where the input frequency is DC to 200 kHz).  |
| Selectable vertical axis sensitivity | 0.01 rps/div to 200 rps/div (1-2-5 steps)  |
| Computing method                     | Computed from the frequency based on the number of pulses per rotation<br>RPSs = Frequency/(pulse/rotate value)  |
| Selectable pulse/rotate range        | 1 to 99999   |
| Period                               |  |
| Measurable period range              | 5 μs to 50 s (where the minimum pulse width is 2 μs)   |
| Selectable vertical axis sensitivity | 10 μs/div to 5 s/div (1-2-5 steps)   |
| Minimum resolution                   | 0.1 μs   |
| Duty cycle                           |  |
| Measurable duty cycle range          | 0 to 100%  |
| Selectable vertical axis sensitivity | 1 %/div to 20 %/div (1-2-5 steps)  |
| Measurable frequency range           | 0.1 Hz to 200 kHz  |
| Measurement pulse selection          | Select positive or negative pulse  |
| Minimum resolution                   | 0.01%  |
| Power supply frequency               |  |
| Measurable frequency range           | 30 Hz to 70 Hz (when the center frequency is 50 Hz), 40 Hz to 80 Hz (when the center frequency is 60 Hz), 380 Hz to 420 Hz (when the center frequency is 400 Hz) |
| Selectable vertical axis sensitivity | 0.1 Hz/div to 2 Hz/div (0.01 Hz resolution)  |
| Center frequency setting             | Select 50 Hz, 60 Hz, or 400 Hz   |
| Minimum resolution                   | 0.01 Hz  |
| Pulse width                          |  |
| Measurable pulse width               | 2 μs to 50 s (where the input frequency is up to 200 kHz)  |
| Selectable vertical axis sensitivity | 10 μs/div to 5 s/div (1-2-5 steps)   |
| Measurement pulse selection          | Select positive or negative pulse  |
| Minimum resolution                   | 0.1 μs   |
| Pulse integration                    |  |
| Maximum pulse count                  | 2×10 <sup>9</sup> pulses   |
| Selectable vertical axis sensitivity | 500.0E+18 value/div to 10.00E-21 value/div (1-2-5 range: total of 123 ranges)  |
| Frequency measuring range            | 0.1 Hz to 200 kHz (where the minimum pulse width is 2 μs)  |
| Computation function                 | Set the physical amount per pulse and display by converting the values into physical values such as distance and flow rate.                                      |
| Selectable Unit/Pulse range          | -9.9999E+30 to +9.9999E+30   |
| Counter reset                        | Manual reset and over-limit reset  |
| Velocity                             |  |
| Selectable vertical axis sensitivity | Set the amount of displacement per pulse and compute the velocity from the frequency<br>Automatic unit time conversion of s, min, and hour.                      |
| Computing method                     | 500.0 E+18 value/div to 10.00 E-21 value/div (1-2-5 range: total of 123 ranges)  |
| Selectable Distance/Pulse range      | -9.9999E+30 to +9.9999E+30   |

## Appendix 8 Frequency Module (701280) Specifications

---

### Functional Specifications

| Item                    | Specifications   |
|-------------------------|--|
| Deceleration prediction | Computes the deceleration condition in realtime when the pulse input is cut off.<br>Can be specified when measuring the frequency, RPMs, RPSs, period, and velocity  |
| Stop prediction         | Sets the frequency to 0 after a certain time elapses after the pulse input is cut off.<br>Stop interval setting: Set in the range of 1.5 to 10 times (10 settings) the period of the pulse measured last<br>Can be specified when measuring the frequency, RPMs, RPSs, period, and velocity  |
| Smoothing               | Computes the moving average of the measured data using the specified time<br>Specified time: 0.1 to 1000 ms (0.1 ms resolution)<br>Can be specified on all measurement parameters  |
| Pulse average           | Performs frequency measurement per specified number of pulses. When fluctuation exists periodically in the pulse interval, the fluctuation can be eliminated.<br>Specified number of pulses: 1 to 4096<br>Can be specified when measuring the frequency, RPMs, RPSs, power supply frequency, period, pulse integration, and velocity   |
| Offset function         | Observe fluctuation with respect to the offset frequency<br>Offset range: Can be set up to 1000 times the maximum div value <ul style="list-style-type: none"><li>• Frequency: 0 Hz to 200 kHz</li><li>• RPMs: 0 rpm to 50 krpm</li><li>• RPSs: 0 rps to 1000 rps</li><li>• Period: 0 s to 50 s</li><li>• Duty cycle: 0% to 100%</li><li>• Pulse width: 0 s to 50 s</li><li>• Pulse integration: <math>-1.0000 \times 10^{22}</math> to <math>1.0000 \times 10^{22}</math></li><li>• Velocity: <math>-1.0000 \times 10^{22}</math> to <math>1.0000 \times 10^{22}</math></li></ul> |