

NUMATICS®

SPS Series

Small Power Slide

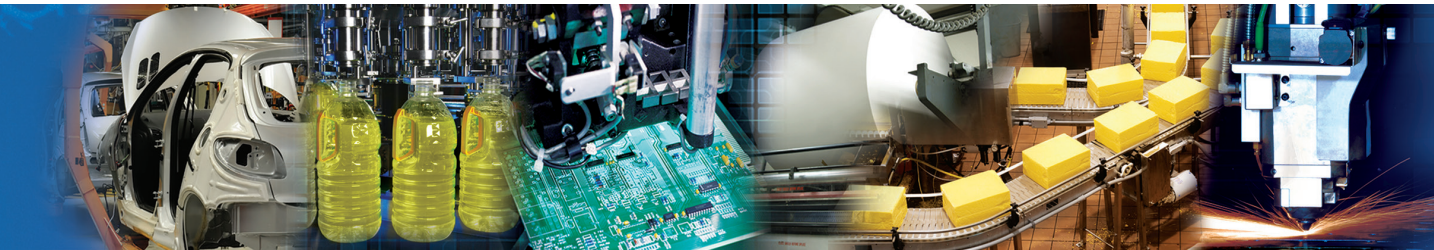
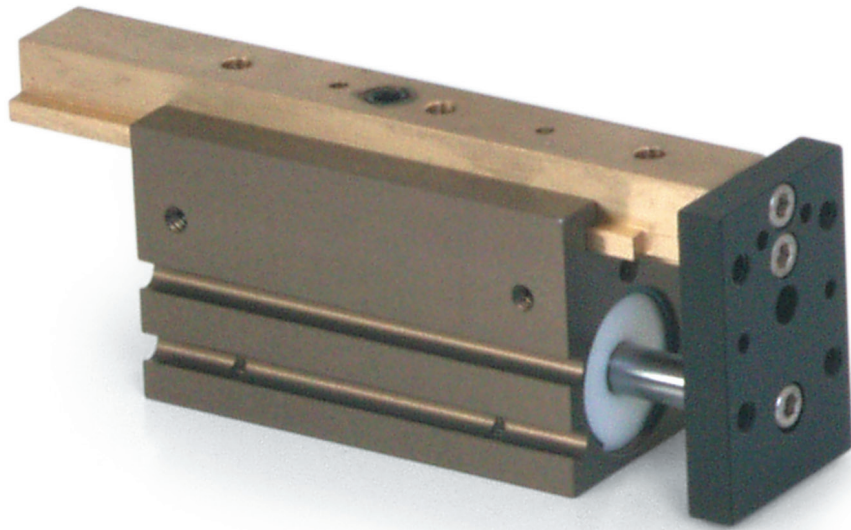

www.numatics.com

SPS Series Small Power Slide

Features and Benefits	3
How To Order	3
SPS050 1/2" & 1" Stroke Dimensions	4
Specifications	4
SPS050 1-1/2" & 2" Stroke Dimensions	5
Specifications	5
SPS075 1/2" & 1" Stroke Dimensions	6
Specifications	6
SPS075 1-1/2" & 2" Stroke Dimensions	7
Specifications	7
Switch Information	8-9

SPS Series Small Power Slide

The SPS-Series small size makes it the ideal slide for getting into those tight spaces.

A. Body

Hardcoat Anodized, PTFE impregnated inside & out.
Light weight durable, High strength to weight ratio.

B. Slide

Aluminum Bronze alloy. Heavy cross section T-Slot style to prevent fatigue failure and breakage.
Offers superior load bearing capabilities throughout stroke. Payload can be attached to top of slide or tooling plate.

C. Stroke adjustment

Fine adjustments can be made to extend stroke accessible through the tooling plate. Retract stroke can be adjusted from backside of unit. Locking set screws ensure precise repetitive operation.

D. Sensing

Hall effect sensing is available for sensing extend & retract.

E. Bearing

Special engineered material, low friction, long life
Maximum rigidity.

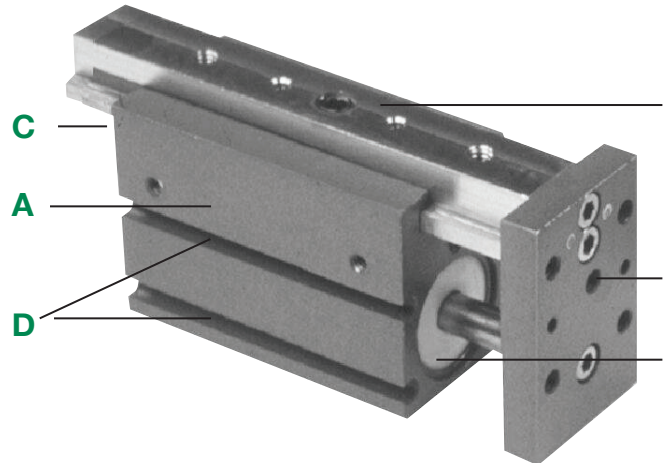

How to Order

SPS	075	X9	1	4	C	X	
<p>Bore Sizes</p> <p>050 = 1/2 Inch Bore 075 = 3/4 Inch Bore</p>		<p>Standard Stroke</p> <p>X5 = 1/2 Inch 01 = 1 Inch X9 = 1-1/2 Inches 02 = 2 Inches</p>		<p>Seal Option</p> <p>1 = Buna-N 2 = FKM</p>		<p>Special Options</p> <p>M = Metric X = Standard</p>	
				<p>Stroke Adjustment</p> <p>A = Single Position Extend B = Single Position Retract C = Two Position Sensing D = No Sensing</p>		<p>Sensing Type</p> <p>Standard Cord Set</p> <p>1 = Hall Switch - PNP (sourcing) 2 = Hall Switch - NPN (sinking) 6 = No Sensing</p> <p>Quick Disconnect Cord Set</p> <p>Z = Hall Switch - PNP (sourcing) Straight Y = Hall Switch - NPN (sinking) Straight See Sensor section</p>	

When ordering additional switches:

Switch Description	Standard Part No.	Quick Disconnect Part No.
Hall Effect-PNP (Sourcing)	CS-20TP	CS-18P-QD
Hall Effect-NPN (Sinking)	CS-20TN	CS-20TN-QD

Dimensions: Inches

SPS050 1/2" and 1" Strokes

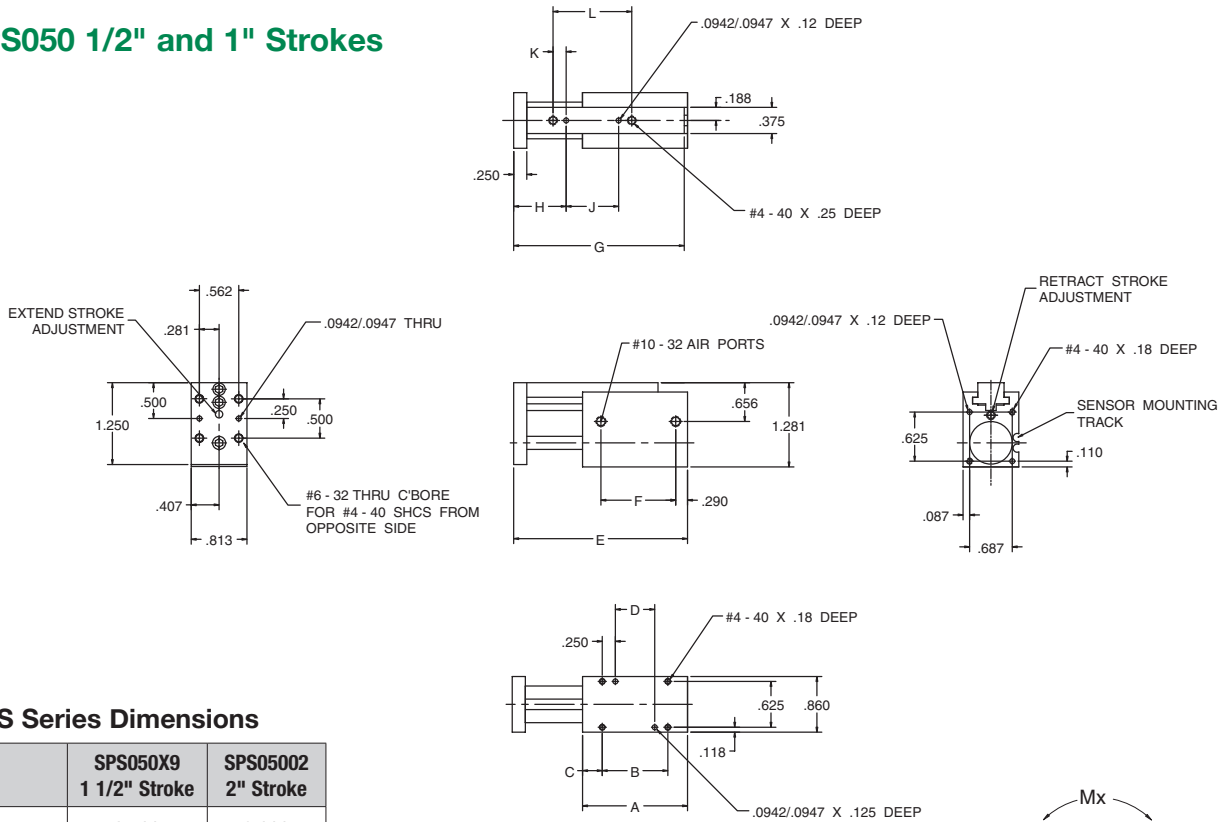

SPS Series Dimensions

	SPS050X9 1 1/2" Stroke	SPS05002 2" Stroke
A	2.500	3.000
B	1.500	2.000
C	0.500	0.500
D	N/A	1.000
E	0.750	1.500
F	4.313	5.313
G	1.910	2.410
H	4.250	5.250
J	1.344	1.250
K	1.187	2.250
L	0.594	0.500
M	1.188	1.000
N	2.375	2.250
P	N/A	3.250

Specifications

	SPS050X5 1/2" Stroke	SPS05001 1" Stroke
Thrust Force @ 100 psi	19 lbs	19 lbs
Maximum Pressure	120 psi	120 psi
Maximum Stroke	0.5 in	1 in
Stroke Adjustment	0.25 in	0.25 in
Maximum Payload on Tool Plate	2 lbs.	5 lbs.
Cylinder Bore Dia.	.500	0.500
Max. Actuation Speed	12 in/sec	12 in/sec
Repeatability	+/- 0.001	+/- 0.001
Displacement	0.07 cu in	0.15 cu in
Weight	2.9 oz.	3.5 oz.

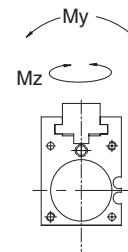
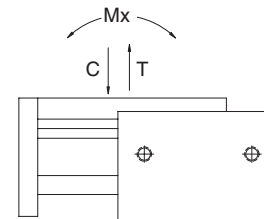

Static Condition

Load Capacity	SPS050X5 1/2" Stroke	SPS05001 1" Stroke
C-compression	50 lbs.	75 lbs.
T-tension	50 lbs.	75 lbs.
Mx	35 in.-lbs.	60 in.-lbs.
My	30 in.-lbs.	40 in.-lbs.
Mz	30 in.-lbs.	40 in.-lbs.

Dynamic Condition

Load Capacity	SPS050X5 1/2" Stroke	SPS05001 1" Stroke
C-compression	15 lbs.	18 lbs.
T-tension	15 lbs.	18 lbs.
Mx	20 in.-lbs.	25 in.-lbs.
My	15 in.-lbs.	20 in.-lbs.
Mz	15 in.-lbs.	20 in.-lbs.

Dimensions: Inches

SPS050 1 1/2" and 2" Strokes

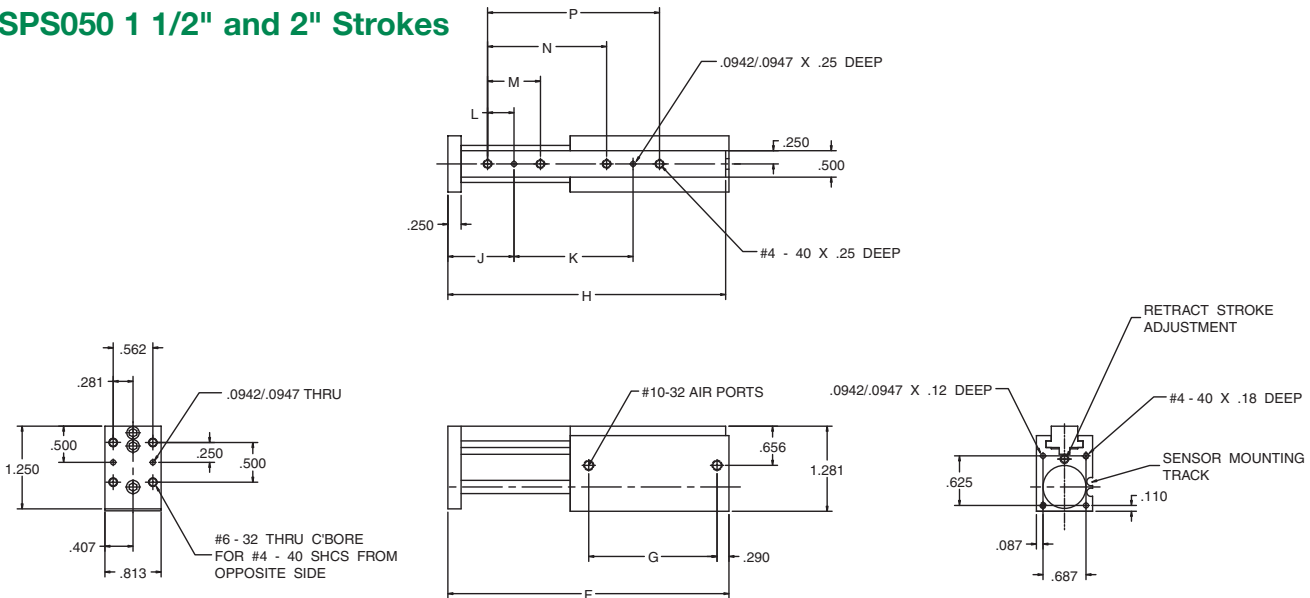

SPS Series Dimensions

	SPS050X9 1 1/2" Stroke	SPS05002 2" Stroke
A	2.500	3.000
B	1.500	2.000
C	0.500	0.500
D	N/A	1.000
E	0.750	1.500
F	4.313	5.313
G	1.910	2.410
H	4.250	5.250
J	1.344	1.250
K	1.187	2.250
L	0.594	0.500
M	1.188	1.000
N	2.375	2.250
P	N/A	3.250

Specifications

	SPS050X9 1 1/2" Stroke	SPS05002 2" Stroke
Thrust Force @ 100 psi	19 lbs	19 lbs
Maximum Pressure	120 psi	120 psi
Maximum Stroke	1.5 in	2 in
Stroke Adjustment	0.5 in	0.5 in
Maximum Payload on Tool Plate	8 lbs.	12 lbs.
Cylinder Bore Dia.	0.500	0.500
Max. Actuation Speed	12 in/sec	12 in/sec
Repeatability	+/- 0.001	+/- 0.001
Displacement	0.22 cu in	0.30 cu in
Weight	4.6 oz.	5.2 oz.

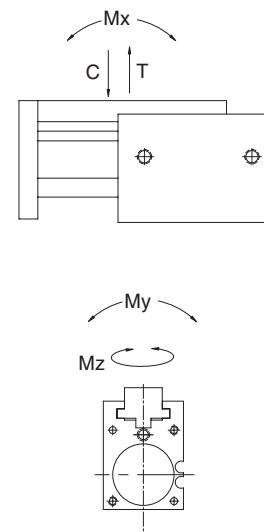

Static Condition

Load Capacity	SPS050X9 1-1/2" Stroke	SPS05002 2" Stroke
C-compression	60 lbs.	80 lbs.
T-tension	60 lbs.	80 lbs.
Mx	80 in.-lbs.	100 in.-lbs.
My	45 in.-lbs.	50 in.-lbs.
Mz	45 in.-lbs.	50 in.-lbs.

Dynamic Condition

Load Capacity	SPS050X9 1-1/2" Stroke	SPS05002 2" Stroke
C-compression	25 lbs.	35 lbs.
T-tension	25 lbs.	35 lbs.
Mx	30 in.-lbs.	40 in.-lbs.
My	25 in.-lbs.	30 in.-lbs.
Mz	25 in.-lbs.	30 in.-lbs.

Dimensions: Inches

SPS075 1/2" and 1" Strokes

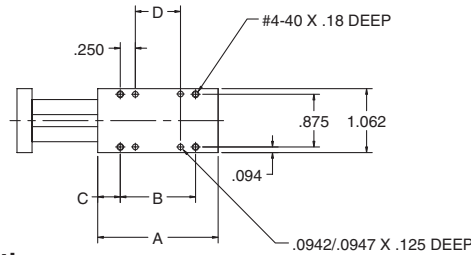
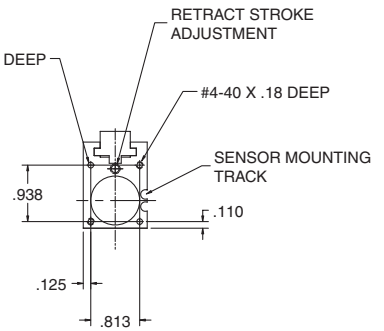
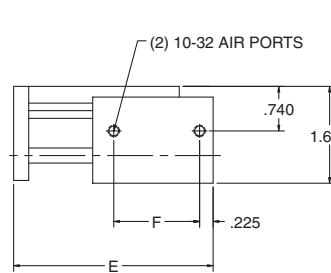
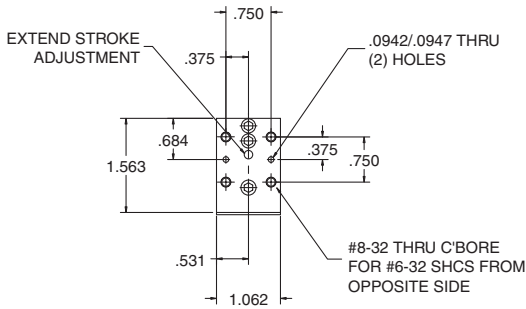
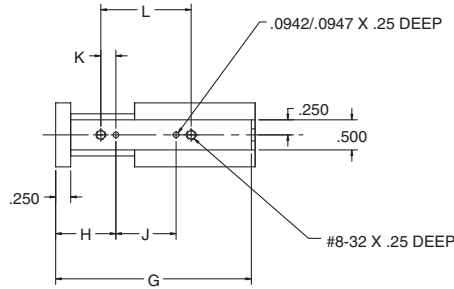

SPS Series Dimensions

	SPS075X5 1/2" Stroke	SPS07501 1" Stroke
A	1.500	2.000
B	0.750	1.250
C	0.375	0.375
D	0.250	0.750
E	2.313	3.313
F	0.925	1.425
G	2.250	3.250
H	0.969	1.000
J	0.500	1.000
K	0.219	0.250
L	0.938	1.500

Specifications

	SPS075X5 1/2" Stroke	SPS07501 1" Stroke
Thrust Force @ 100 psi	44 lbs	44 lbs
Maximum Pressure	120 psi	120 psi
Maximum Stroke	0.5 in	1 in
Stroke Adjustment	0.25 in	0.25 in
Maximum Payload on Tool Plate	7 lbs.	13 lbs.
Cylinder Bore Dia.	0.75	0.75
Max. Actuation Speed	12 in/sec	12 in/sec
Repeatability	+/- 0.001	+/- 0.001
Displacement	0.22 cu in	0.44 cu in
Weight	4.6 oz.	5.6 oz.

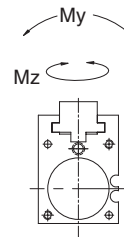
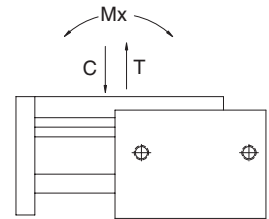

Static Condition

Load Capacity	SPS0750X5 1/2" Stroke	SPS075001 1" Stroke
C-compression	80 lbs.	150 lbs.
T-tension	80 lbs.	150 lbs.
Mx	35 in.-lbs.	70 in.-lbs.
My	30 in.-lbs.	40 in.-lbs.
Mz	30 in.-lbs.	40 in.-lbs.

Dynamic Condition

Load Capacity	SPS0750X5 1/2" Stroke	SPS075001 1" Stroke
C-compression	28 lbs.	30 lbs.
T-tension	28 lbs.	30 lbs.
Mx	20 in.-lbs.	25 in.-lbs.
My	15 in.-lbs.	20 in.-lbs.
Mz	15 in.-lbs.	20 in.-lbs.

Dimensions: Inches

SPS075 1 1/2" and 2" Strokes

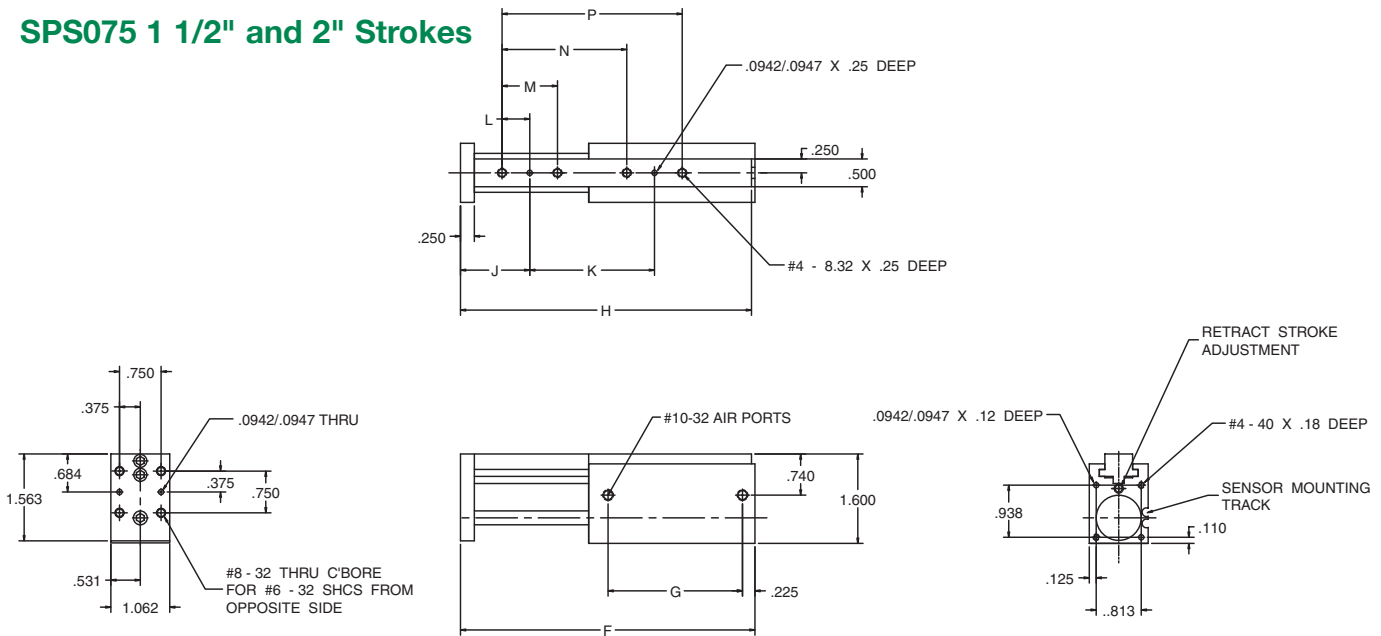

SPS Series Dimensions

	SPS075X9 1 1/2" Stroke	SPS07502 2" Stroke
A	2.500	3.000
B	1.500	2.000
C	0.500	0.500
D	N/A	1.000
E	1.000	1.500
F	4.313	5.313
G	1.925	2.425
H	4.250	5.250
J	1.344	1.250
K	1.187	2.250
L	0.594	0.500
M	1.188	1.000
N	2.375	2.250
P	N/A	3.250

Specifications

	SPS075X9 1 1/2" Stroke	SPS07502 2" Stroke
Thrust Force @ 100 psi	44 lbs	44 lbs
Maximum Pressure	120 psi	120 psi
Maximum Stroke	1.5 in	2 in
Stroke Adjustment	0.5 in	0.5 in
Maximum Payload on Tool Plate	25 lbs.	25 lbs.
Cylinder Bore Dia.	0.75	0.75
Max. Actuation Speed	12 in/sec	12 in/sec
Repeatability	+/- 0.001	+/- 0.001
Displacement	0.66 cu in	0.88 cu in
Weight	6.8 oz.	8.4 oz.

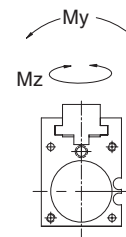
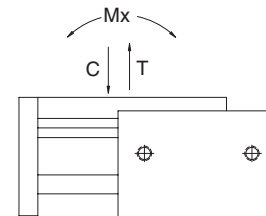

Static Condition

Load Capacity	SPS075X9 1-1/2" Stroke	SPS07502 2" Stroke
C-compression	250 lbs.	400 lbs.
T-tension	70 lbs.	90 lbs.
Mx	140 in.-lbs.	140 in.-lbs.
My	70 in.-lbs.	70 in.-lbs.
Mz	70 in.-lbs.	70 in.-lbs.

Dynamic Condition

Load Capacity	SPS075X9 1-1/2" Stroke	SPS07502 2" Stroke
C-compression	35 lbs.	35 lbs.
T-tension	35 lbs.	35 lbs.
Mx	40 in.-lbs.	40 in.-lbs.
My	25 in.-lbs.	25 in.-lbs.
Mz	25 in.-lbs.	25 in.-lbs.

SPS Series Switch Information

	Switch or Bracket Description	Standard Part No.	Quick Disconnect Part No.
1	Hall Effect PNP (Sourcing) 4mm	CS-20TP	CS-20TP-QD
1	Hall Effect NPN (Sinking) 4mm	CS-20TN	CS-20TN-QD

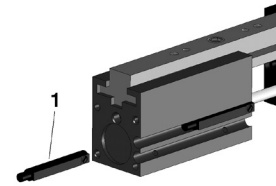

**Electro Switch (PNP NO)
8 mm Connector - CS-20TP-QD**

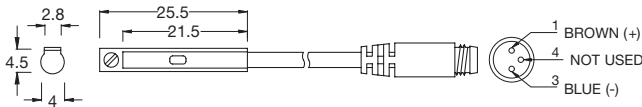

Sensor Type	Solid State Output
Switching Logic	Normally Open
Output	PNP Current Sourcing
Operating Voltage	5-30 VDC
Switching Current	50mA max.
Power Rating*	1.5 Watts
Voltage Drop	1.5 V @ 25 mA max.
Current Consumption	15 mA @ 24 VDC max.
Leakage Current	0.01 mA max.
LED Indicator	Green
Cable	-
Operating Frequency	1000 Hz
Magnetic Requirement	40 Gauss parallel
Temperature Range	14 to 158°F (-10 to 70°C)
Shock / Vibration	50G/9G
Enclosure Classification	IEC 529 IP67 (NEMA 6)
Protection Circuit	Reverse Polarity, Surge Suppression
Set Screw Max. Torque	1.77 in-lbs (0.2 N-m)

**Electro Switch (NPN NO)
8 mm Connector - CS-20TN-QD**

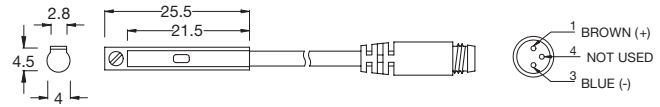

Sensor Type	Solid State Output
Switching Logic	Normally Open
Output	NPN Current Sinking
Operating Voltage	5-30 VDC
Switching Current	50mA max.
Power Rating*	1.5 Watts
Voltage Drop	0.5 V @ 25 mA max.
Current Consumption	12 mA @ 24 VDC max.
Leakage Current	0.01 mA max.
LED Indicator	Red
Cable	-
Operating Frequency	1000 Hz
Magnetic Requirement	40 Gauss parallel
Temperature Range	14 to 158°F (-10 to 70°C)
Shock / Vibration	50G/9G
Enclosure Classification	IEC 529 IP67 (NEMA 6)
Protection Circuit	Reverse Polarity, Surge Suppression
Set Screw Max. Torque	1.77 in-lbs (0.2 N-m)

Electro Switch (NPN NO) Flying Lead - CS-20TN

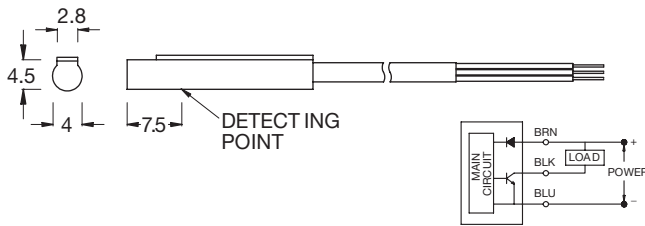

Sensor Type	Solid State Output
Switching Logic	Normally Open
Output	NPN Current Sinking
Operating Voltage	5-30 VDC
Switching Current	50mA max.
Power Rating*	1.5 Watts
Voltage Drop	0.5 V @ 25 mA max.
Current Consumption	12 mA @ 24 VDC max.
Leakage Current	0.01 mA max.
LED Indicator	Red
Cable	-
Operating Frequency	1000 Hz
Magnetic Requirement	40 Gauss parallel
Temperature Range	14 to 158°F (-10 to 70°C)
Shock / Vibration	50G/9G
Enclosure Classification	IEC 529 IP67 (NEMA 6)
Protection Circuit	Reverse Polarity, Surge Suppression
Set Screw Max. Torque	1.77 in-lbs (0.2 N-m)

Electro Switch (PNP NO) Flying Lead - CS-20TP

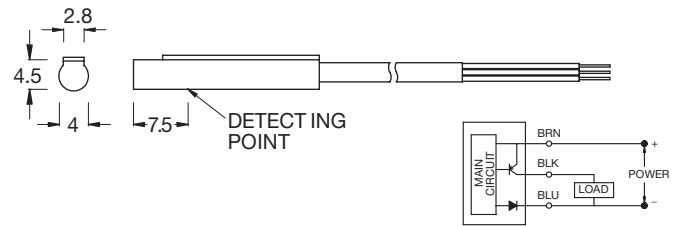

Sensor Type	Solid State Output
Switching Logic	Normally Open
Output	PNP Current Sourcing
Operating Voltage	5-30 VDC
Switching Current	50mA max.
Power Rating*	1.5 Watts
Voltage Drop	1.5 V @ 25 mA max.
Current Consumption	12 mA @ 24 VDC max.
Leakage Current	0.01 mA max.
LED Indicator	Green
Cable	Abrasion resistant polyurethane (PUR) jacket, PVC insulation
Operating Frequency	1000 Hz
Magnetic Requirement	40 Gauss parallel
Temperature Range	14 to 158°F (-10 to 70°C)
Shock / Vibration	50G/9G
Enclosure Classification	IEC 529 IP67 (NEMA 6)
Protection Circuit	Reverse Polarity, Surge Suppression
Set Screw Max. Torque	1.77 in-lbs (0.2 N-m)

Female Connectors for Reed Switches and Hall Effect Sensors

Type	Order Code
Straight, 5 m Cable	PXCST
Elbow, 5 m Cable	PXC90

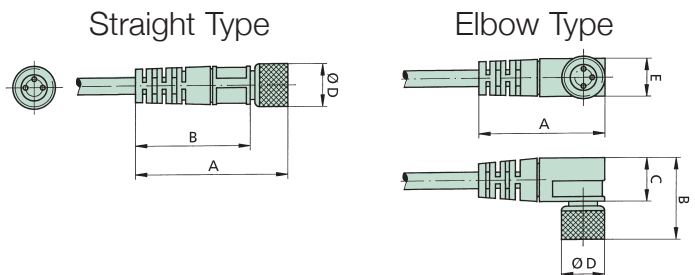



World Class Supplier of Pneumatic Components



World Headquarters

USA Numatics, Incorporated

46280 Dylan Drive
Novi, Michigan 48377

P: 248-596-3200
F: 248-596-3201

Canada Numatics, Ltd

P: 519-758-2700
F: 519-758-5540

México - Ascomatica SA de CV

P: 52 55 58 09 56 40 (DF y Area metropolitana)
P: 01 800 000 ASCO (2726) (Interior de la República)
F: 52 55 58 09 56 60

Brazil Ascovál Ind.e Comercio Ltda

P: (55) 11-4208-1700
F: (55) 11-4195-3970

