

Drawings

GS210/ GS211 GS200 DC Voltage/Current Source

GS200

Unit : mm
(approx. inch)

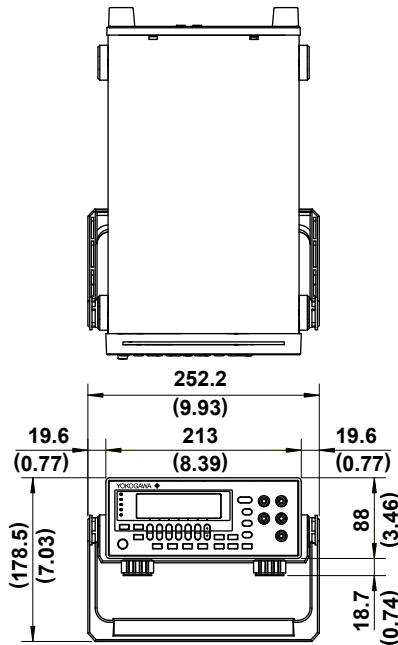

GS210

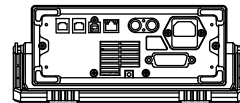

GS211

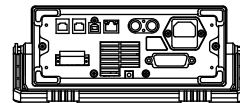

REAR VIEW

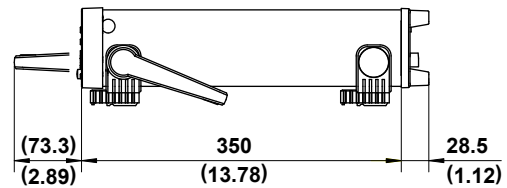

● Rack Mount (JIS)

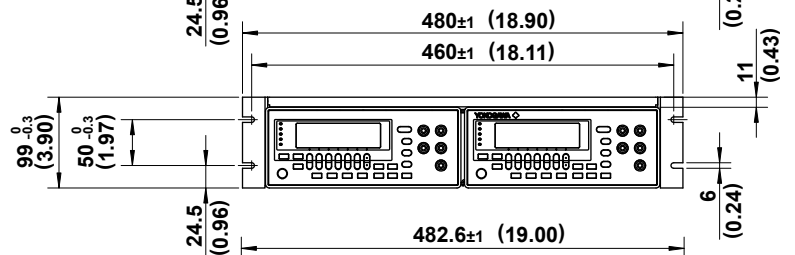
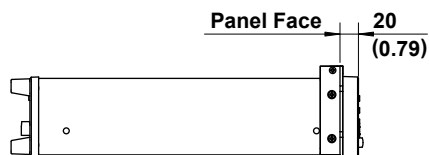
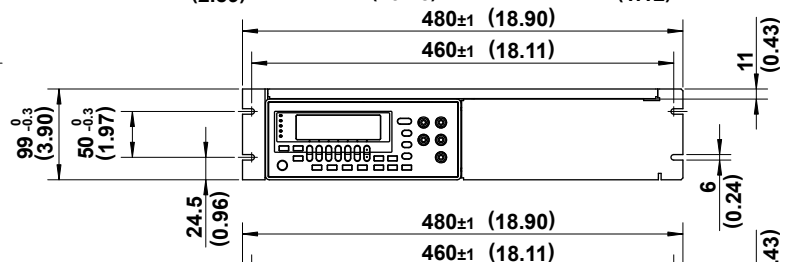
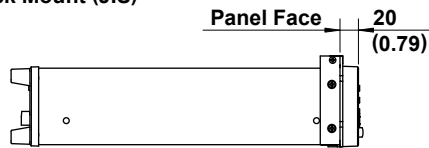

● Rack Mount (EIA)

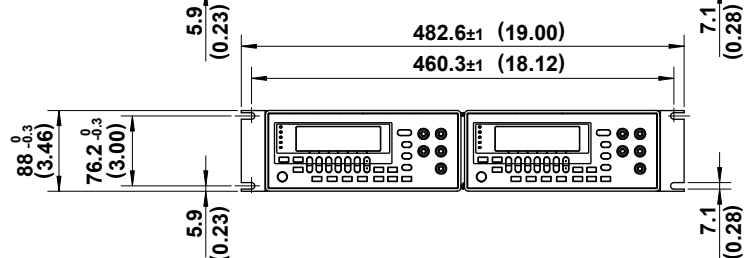
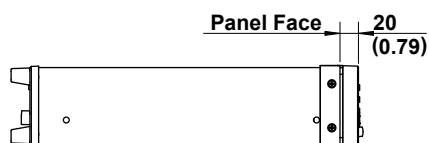
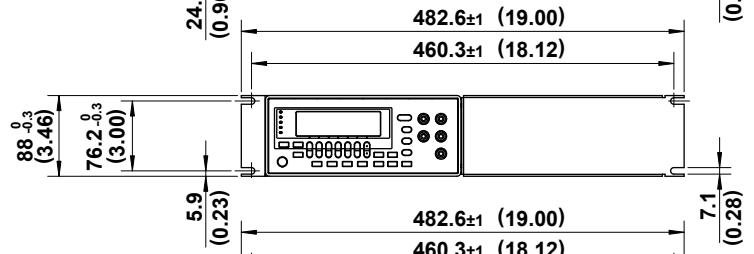
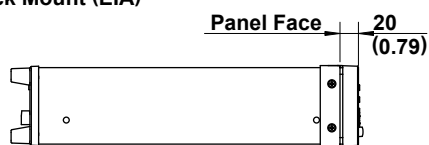

If not specified, the tolerance is $\pm 3\%$. However, in cases of less than 10 mm, the tolerance is ± 0.3 mm.