

LEVELtrol-II

Flow COMPUTER

Version 01.xx



KEP

KESSLER-ELLIS PRODUCTS

10 Industrial Way East

Eatontown, NJ 07724

800-631-2165 732-935-1320

Fax 732-935-9344

kep.com
<http://www.kep.com>

Proprietary Notice

The information contained in this publication is derived in part from proprietary and patent data. This information has been prepared for the expressed purpose of assisting operating and maintenance personnel in the efficient use of the instrument described herein. Publication of this information does not convey any rights to use or reproduce it or to use for any purpose other than in connection with the installation, operation and maintenance of the equipment described herein.

Copyright 1995
Printed in USA. All Rights Reserved.



WARNING!

This instrument contains electronic components that are susceptible to damage by static electricity. Proper handling* procedures must be observed during the removal, installation, or handling of internal circuit boards or devices.

*Handling Procedure

1. Power to unit must be removed.
2. Personnel must be grounded, via wrist strap or other safe, suitable means, before any printed circuit board or other internal device is installed, removed or adjusted.
3. Printed circuit boards must be transported in a conductive bag or other conductive container. Boards must not be removed from protective enclosure until the immediate time of installation. Removed boards must be placed immediately in protective container for transport, storage, or return to factory.

Comments

This instrument is not unique in its content of ESD (electrostatic discharge) sensitive components. Most modern electronic designs contain components that utilize metal oxide technology (NMOS, CMOS, etc.). Experience has proven that even small amounts of static electricity can damage or destroy these devices. Damaged components, even though they appear to function properly, may exhibit early failure.



SAFETY INSTRUCTIONS

The following instructions must be observed.

- This instrument was designed and is checked in accordance with regulations in force EN 60950 ("Safety of information technology equipment, including electrical business equipment"). A hazardous situation may occur if this instrument is not used for its intended purpose or is used incorrectly. Please note operating instructions provided in this manual.
 - The instrument must be installed, operated and maintained by personnel who have been properly trained. Personnel must read and understand this manual prior to installation and operation of the instrument.
 - This instrument is internally fused. Replace the internal fuse with the following specified type and rating only:

Input Power	Recommended Fuse
115 VAC	160 mA slow blow fuse
230 VAC	80 mA slow blow fuse
12-24 VDC	800 mA slow blow fuse
- Disconnect power supply before replacing fuse!**
- The manufacturer assumes no liability for damage caused by incorrect use of the instrument or for modifications or changes made to the instrument.

Symbols Used On Unit

<u>Number</u>	<u>Symbol</u>	<u>Publication</u>	<u>Description</u>
1	==	IEC 417, No. 5031	Direct current
2		IEC 417, No. 5172	Equipment protected throughout by DOUBLE INSULATION or REINFORCED INSULATION (equivalent to Class II of IEC 536—see annex H)
3		ISO 3864, No. B.3.1	Caution (refer to accompanying documents)

Technical Improvements

- The manufacturer reserves the right to modify technical data without prior notice.

CONTENTS

1. Description	1
1.1 Unit Description:.....	1
1.2 Unit Features:	1
1.3 Specifications:.....	2
2. Installation	6
2.1 General Mounting Hints:	6
2.2 Mounting Diagrams:.....	6
3. Applications	7
3.1 Tank Level/Volume.....	7
3.2 Corrected Tank Volume.....	8
3.3 Total Mass in Tank.....	9
3.4 Batching Volume, Corrected Volume or Mass from Tank Level	10
4 WIRING.....	11
4.1 Typical Batcher Wiring:	11
4.2 Typical Level/Total Wiring:	11
4.3 Wiring In Hazardous Areas:	12
5. UNIT OPERATION	13
5.1 Front Panel Operation Concept for Run Mode	13
5.2 General Operation	14
5.3 Level/Total Operation.....	14
5.3.1 Password Protection for Level/Total mode.....	14
5.3.2 Relay Operation in Level/Total mode	14
5.3.3 Pulse Output in Level/Total mode	14
5.3.4 Analog Output in Level/Total mode	15
5.3.5 RS-232 Serial Port Operation in Level/Total mode	15
5.3.6 RS-485 Serial Port Operation in Level/Total mode	15
5.4 Batcher Operation.....	16
5.4.1 Batcher Configuration.	16
5.4.2 Password Protection for Batcher Mode	17
5.4.3 Relay Operation in Batcher mode.....	17
5.4.4 Pulse Output in Batcher mode	17
5.4.5 Analog Output in Batcher mode	18
5.4.6 RS-232 Serial Port Operation in Batcher mode	18
5.4.7 RS-485 Serial Port Operation in Batcher mode	18
6. PROGRAMMING	19
6.1 Front Panel Operation Concept for Program Mode	19
6.2 EZ Setup.....	20
6.2.1 TOP LEVEL SETUP MENU	20
6.2.2 EZ Setup Submenu Groups.....	20
6.3 Setup Menus.....	22
6.3.1 Top Level Setup Menu	22
6.3.2 Submenu Groups.....	22
6.4 Setup Sub-Menus	23
6.4.1 DO EZ SETUP?	23
6.4.2 SET INSTRUMENT TYPE	23
6.4.3 SETUP INDICATORS (Vol).....	24
6.4.4 SETUP INDICATORS (Mass)	24
6.4.5 SETUP INDICATORS (Level)	25
6.4.6 SETUP INDICATORS (Temperature).....	25
6.4.7 SETUP TANK STYLE (Strapping Table)	26
6.4.8 SETUP TANK STYLE (Vertical Cylindrical or Horizontal Cylindrical).....	27
6.4.9 SETUP TANK STYLE (Sphere)	27
6.4.10 SETUP PROCESS INPUTS (Level)	28
6.4.11 SETUP PROCESS INPUTS (Compensation Input)	29
6.4.12 SET FLUID PROPERTIES.....	30
6.4.13 SETUP OUTPUTS (Analog Output)	30
6.4.14 SETUP OUTPUTS (Pulse Output).....	31
6.4.15 SETUP RELAYS (Relay 1).....	31
6.4.16 SETUP RELAYS (Relay 2).....	32
6.4.17 SETUP RELAYS (Relay 3 & 4)	33
6.4.18 SETUP CONTROL INPUTS (LEVEL/TOTAL).....	34
6.4.19 SETUP CONTROL INPUTS (BATCH)	34
6.4.20 SETUP REALTIME CLOCK (Time).....	34
6.4.21 SETUP REALTIME CLOCK (Date).....	35
6.4.22 SETUP SERIAL OUTPUT.....	35
6.4.23 SET PRINT OUTPUT (Configure).....	36
6.4.24 SET PRINT OUTPUT (Select_list).....	36
6.4.25 SETUP PASSWORDS (Operator)	37
6.4.26 SETUP PASSWORDS (Supervisor)	37
6.4.27 SETUP NETWORK CARD	37

CONTENTS

7. Principle Of Operation	38
7.1 General Operation	38
7.2 Determining the liquid quantity for various Tank Geometries.....	38
7.3 Determining Liquid Level	38
7.4 Corrections for density in hydrostatic pressure based level measurements.....	38
7.5 Computation of Corrected Volume in Tank and Mass in Tank.....	39
7.6 Calculating the Expansion Factor For a Fluid	41
8. Test, Service and Maintenance	42
8.1 Test Menus.....	42
8.1.1 TOP LEVEL TEST MENUS.....	42
8.2 Test Sub-Menus	43
8.2.1 Audit Trail Submenu Group.....	43
8.2.2 Error History Submenu Group	43
8.2.3 Print System Setup Submenu Group.....	43
8.2.4 Keypad test Submenu Group.....	44
8.2.5 Display test Submenu Group.....	44
8.2.6 - 8.2.16 Calibration Submenu Group	45
8.2.17 Analog In Test Submenu Group	49
8.2.18 Analog out test Submenu Group.....	50
8.2.19 Pulse out test Submenu Group.....	50
8.2.20 Relay test Submenu Group.....	50
8.2.21 Control input test Submenu Group	50
8.2.22 Battery Voltage test Submenu Group	51
8.2.23 Data logger utility Submenu Group.....	51
8.3 Internal Fuse Replacement.....	52
8.4 Installing New Software	52
9. RS-232 Serial Port	53
9.1 RS-232 Port Description:	53
9.2 Instrument Setup by PC's over Serial Port	53
9.3 Operation of Serial Communication Port with Printers	53
9.4 LEVELtrol-II RS-232 Port Pinout.....	53
10. RS-485 Serial Port (optional)	54
10.1 RS-485 Port Description:	54
10.2 General	54
10.3 Operation of Serial Communication Port with PC.....	54
10.4 LEVELtrol-II RS-485 Port Pinout.....	54
11. Instrument Setup Software (optional)	55
11.1 System Requirements:.....	55
11.2 Cable and Wiring Requirements:	55
11.3 Installation for Windows™	55
11.4 Using the Setup Software	56
11.5 File Tab.....	56
11.6 Setup Tab	56
11.7 View Tab.....	57
11.8 Misc. Tab	57
12. Glossary Of Terms.....	58
13. Diagnosis and Troubleshooting.....	62
13.1 Response of LEVELtrol-II on Error or Alarm:.....	62
13.2 Diagnosis Flow Chart and Troubleshooting	63
13.3 Error & Warning Messages:.....	64
13.3.1 Sensor/Process Alarms.....	64
13.3 Error & Warning Messages: (Continued)	65
13.3.2 Self Test Alarms	65
Appendix A	66
Common Fluid Properties Table.....	66
Appendix B.....	67
Setup Menus.....	67
Appendix C.....	67
RS485 Modbus RTU Protocol.....	68

Unit Description**1. Description****1.1 Unit Description:**

The LEVELtrol-II satisfies the requirements for a variety of level instrument needs. Multiple equations and instrument functions for a variety of tank shapes are available in a single unit with many advanced features.

The alphanumeric display shows measured and calculated parameters in easy to understand format. Single key direct access to measurements and display scrolling is supported.

The versatility of the LEVELtrol-II permits a wide measure of versatility within the instrument package. The various hardware inputs and outputs can be “soft” assigned to meet a variety of common application needs. The user “soft selects” the usage of each input/output while configuring the instrument. Consider the following illustrative examples.

The isolated analog output can be chosen to follow tank levels, volume, corrected volume, mass, temperature, or density by means of a menu selection. Most hardware features are assignable by this method.

The user can assign the standard RS-232 Serial Port for data logging, transaction printing, or for connection to a modem for remote reading.

An RS-485 Modbus RTU communication card provides multidrop capabilities.

Unit Features**1.2 Unit Features:**

The LEVELtrol-II offers the following features:

- Multiple Tank Shapes
- Level and Tank Volume Indicator
- Batching by Level
- Level Control, Tank Volume, Corrected Volume and Mass Calculations
- Multiple Instrument Functions
- Menu Selectable Hardware & Software Features
- Two Line LCD, OLED or VFD Display
- Isolated Outputs Standard
- RS-232 Port Standard
- DIN Enclosure with Two Piece Connectors
- Windows™ Setup Software
- RS-485 Modbus RTU Option

1.3 Specifications:

Specifications:

Environmental

Indoor Use
Altitude up to 2000m
Operating Temperature: 0°C to +50°C
(-20°C to 55°C optional)
Storage Temperature: -40°C to +85 C
Maximum Relative Humidity : 80% for temperatures up to 31°C decreasing linearly to 50% RH at 40°C
Mains supply voltage fluctuations not to exceed ±10% of the nominal voltage
Transient overvoltage according to INSTALLATION CATEGORY II (see UL 3101-1 Annex J)
POLLUTION DEGREE 2 in accordance with IEC 664 (see 3.7.3)
Materials: UL, CSA, VDE approved

Approvals: CE Approved Light Industrial,
UL File #: E192404
CSA Pending

Display

Type: 2 lines of 20 characters
Types: Backlit LCD, OLED or VFD ordering options
Character Size: 0.3" nominal
User selectable label descriptors and units of measure

Keypad

Keypad Type: Membrane Keypad
Keypad Rating: Sealed to NEMA 4X / IP65
Number of keys: 16

Enclosure

Size: See Dimensions
Depth behind panel: 6.5" including mating connector
Type: DIN
Materials: Plastic, UL94V-0, Flame retardant
Bezel: Textured per matt finish
Equipment Labels: Model, safety, and user wiring

Power Input

The factory equipped power option is internally fused. An internal line to line filter capacitor and MOV's are provided for added transient suppression.

Order Option 1: 110VAC: 85 to 127 Vrms, 50/60 Hz
Order Option 2: 220VAC: 170 to 276 Vrms, 50/60 Hz
Order Option 3: 12VDC: 10.5 to 16 VDC
Order Option 4: 24VDC: 16 to 24 VDC

Level Input:

Analog Input:

Ranges
Voltage: 0-10 VDC, 0-5 VDC, 1-5 VDC
Current: 4-20 mA, 0-20 mA
Basic Measurement Resolution: 16 bit
Update Level: 5 updates/sec minimum
Automatic Fault detection: Signal over/under-range, Current Loop Broken
Calibration: Self Calibration and Auto-zero Continuously
Extended calibration: Learns Zero and Full Scale of each range using special test mode.
Fault Protection:
Fast Transient: 500 V Protection (Capacitive Clamp)
Reverse Polarity: No ill effects
Over-Voltage Limit: 50 VDC Over voltage protection
Over-Current Protection: Internally current limited Protected to 24 VDC.

Compensation Input

The compensation input is menu selectable for temperature, density or not used.

Operation: Ratiometric
Accuracy: 0.01% FS
Thermal Drift: Less than 100 ppm/C
Basic Measurement Resolution: 16 bit
Update Level: 1 update/sec minimum
Automatic Fault detection:
Signal Over-range/under-range
Current Loop Broken
RTD short
RTD open
Fault mode to user defined default settings

Transient Protection: 500 V (Capacitive Clamp)
Reverse Polarity: No ill effects
Over-Voltage Limit (Voltage Input): 50 VDC

Available Input Ranges

Voltage: 0-10 VDC, 0-5 VDC, 1-5 VDC
Current: 4-20 mA, 0-20 mA
Resistance: 100 Ohms DIN RTD

100 Ohm DIN RTD (DIN 42-760, BS 1904):

Three Wire Lead Compensation
Internal RTD linearization learns ice point resistance
1 mA Excitation current with reverse polarity protection
Temperature Resolution: 0.01°C
Accuracy: ± 0.25°C

Control Inputs

Switch Inputs are menu selectable for Start, Stop, Reset, Lock, Alarm Acknowledge, Print or Not Used.

Control Input Specifications

Input Scan Rate: 10 scans per second
Logic 1: 4 - 30 VDC
Logic 0: 0 - 0.8 VDC
Transient Suppression: 500 V fast transient (Capacitive Clamp)
Input Impedance: 100 KΩ
Control Activation: Positive Edge or Pos. Level based on product definition

Excitation Voltage

24 VDC @ 100 mA (current limited)
Note: Not available on DC powered units

Relay Outputs

The relay outputs are menu assignable to (Individually for each relay) Level, Total, Temperature, Density, Low Alarm, Hi Alarm, Prewarn Alarm, Preset Alarm or General purpose warning (security).

Number of relays: 2 Standard, 4 Optional

Note: RS-232 Multidrop not available with 4 relay version.

Contact Style: Form C contacts
Contact Ratings: 250 VAC @ 5 amps
30 VDC @ 5 amps

Fast Transient Threshold: 1000 V

Analog Output

The analog output is menu assignable to correspond to the Uncompensated Volume Level, Corrected Volume Level, Mass, Temperature, Density.

Type: Isolated Current Sourcing
 Isolated I/P/C: 500 V
 Available Ranges: 4-20 mA
 Resolution: 12 bit
 Accuracy: 0.05% FS at 20 Degrees C
 Update Level: 1 update/sec minimum
 Temperature Drift: Less than 200 ppm/C
 Maximum Load: 1000 ohms (at nominal line voltage)
 Compliance Effect: Less than .05% Span
 60 Hz rejection: 40 dB minimum
 EMI: No effect at 3 V/M
 Calibration: Operator assisted Learn Mode
 Averaging: User entry of DSP Averaging constant to cause a smooth control action.

Isolated Pulse output

The isolated pulse output produces pulses based on the changing Uncompensated Volume Total, Compensated Volume Total or Mass Total.

Usage: Quantity entering or leaving tank
 Isolation I/O/P: 500 V
 Pulse Output Form: Open Collector
 Maximum On Current: 25 mA
 Maximum Off Voltage: 30 VDC
 Saturation Voltage: 1.0 VDC
 Maximum Off Current: 0.1 mA
 Pulse Duration: 10 msec or 100 msec
 Pulse output buffer: 8 bit

Fault Protection
 Reverse polarity: Shunt Diode
 Transient Protection: 500 VDC
 (Capacitive Clamp)

RS-232 Communication

Uses: Printing, Setup, Modem, Datalogging
 Baud Rates: 300, 600, 1200, 2400, 4800, 9600, 19200
 Parity: None, Odd, Even
 Device ID: 0 to 99
 Protocol: Proprietary, Contact factory for more information
 Chassis Connector Style: DB 9 Female connector

RS-485 Communication (optional)

Uses: Network Communications
 Baud Rates: 300, 600, 1200, 2400, 4800, 9600, 19200
 Parity: None, Odd, Even
 Device ID: 0 to 247
 Protocol: ModBus RTU
 Chassis Connector Style:
 DB 9 Female connector,
 Terminal Block Optional

Operating Mode

The LEVELtrol-II can be thought of as making a series of measurements of level, temperature/density sensors and then performing calculations to arrive at a result(s) which are then updated periodically on the display. The analog output, the pulse output, and the alarm relays are also updated. The cycle then repeats itself.

Step 1: Update the measurements of input signals
 Raw Input Measurements are made at each input using equations based on input signal type selected. The system notes the "out of range" input signal as an alarm condition.

Step 2: Compute the Flowing Fluid Parameters
 The temperature and density equations are computed as needed based on the instrument equations and input usage selected by the user.

Step 3 : Compute the Tank Level
 The value is computed based on the level sensor input type selected and by installation details on the tank and fluid properties.

Step 4: Compute the Uncorrected Tank Volume
 Compute the uncorrected tank volume from the tank level measurement and known geometry of the tank.

Step 5: Compute the Corrected Tank Volume at Reference Conditions or Mass in tank.

Step 6: Check Alarms
 The alarm functions have been assigned to one of the above during the setup of the instrument. A comparison is now made by comparing the current value against the specified hi and low limits.

Step 7: Compute the Analog Output
 This designated process value is now used to compute the analog output.

Step 8: Total Preset Comparisons
 The total associated with a preset function is then compared against the corresponding preset value and any required control actions taken.

Step 9: Pulse Output Service-
 The pulse output is next updated by scaling the total increment which has just been determined by the pulse output scaler and summing it to any residual pulse output amount.

Step 10: Update Display and Printer Output-
 The instrument finally runs a task to update the various table entries associated with the front panel display and serial outputs.

Setup Mode

The setup mode is password protected by means of a numeric lock out code established by the user. In addition, a secret, manufacturers numeric unlock entry sequence is available.

The system also provides a minimum implementation of an “audit trail” which tracks significant setup changes to the unit. This feature is increasingly being found of benefit to users or simply required by Weights and Measurement Officials in systems used in commerce, trade, or “custody transfer” applications.

A Worksheet is provided to assist the user in setting up the instrument. In addition, a software program is available (optional) which runs on a PC using a RS-232 Serial for connection to the instrument. Illustrative examples may be down loaded in this manner.

The setup mode has numerous subgrouping of parameters needed for the instrument functions. There is a well conceived hierarchy to the setup parameter list. Selections made at the beginning of the setup hide unnecessary items further down in the lists.

In the setup mode, the instrument activates the correct setup variables based on the instrument configuration, the equations, and the hardware selections made for the compensation transmitter type, the level transmitter type, and any enhancement options selected. All required setup parameters are enabled. All setup parameters not required are suppressed.

A help line prompt is provided for each entry. In addition a help message is available which may be accessed by depressing the “HELP” key.

Also note that in the setup mode are parameter selections which have preassigned industry standard values. The unit will assume these values unless they are modified by the user.

Most of the process input variables have available a “default” or emergency value which must be entered. These are the values that the unit assumes when a malfunction is determined to have occurred on the corresponding input.

It is possible to enter in a nominal constant value for temperature or density, or analog level inputs by placing the desired nominal value into both the lo and hi values. This is also a convenience when performing bench top tests without simulators.

Maintenance Mode:

The Maintenance Mode of the LEVELtrol-II is the Test and Calibration Mode for the device. This mode provides a number of specialized utilities required for factory calibration, instrument checkout on start-up, and periodic calibration documentation.

A Supervisor or Manufacturers password is required to gain access to this specialized mode of operation. Start-up, quality, calibration, and maintenance personnel will find this mode of operation very useful. It is also useful for factory testing.

Many of these tests may be used during start-up of a new system. Inputs signals may be read, and output signals may be exercised to verify the electrical interconnects before the entire system is put on line.

The following action items may be performed in the Maintenance Mode:

- Print Calibration/Maintenance Report
- Examine Audit Trail
- Examine Error History
- Perform Keypad Checkout
- Perform Display Checkout
- Perform Pulse Output Checkout
- Perform Control Input Checkout
- Perform Relay Output Checkout
- Perform Analog Input Checkout
- Perform Analog Output Checkout
- Calibrate Analog Inputs using the Learn Feature
- Calibrate Analog Output using the Learn Feature
- Battery Voltage Test
- Print Datalogger Contents

Note that a calibration of the analog input/output will advance the audit trail counters since it effects the accuracy of the system.

RS-232 Serial Port

The LEVELtrol-II has a general purpose RS-232 Port which may be used for any one of the following purposes:

- Transaction Printing
- Data Logging
- Remote Metering by Modem (optional)
- Computer Communication Link
- Configuration by Computer
- Print System Setup
- Print Calibration/Malfunction History

Instrument Setup by PC's over Serial Port

A Diskette program is optionally available with the instrument that enables the user to rapidly configure the LEVELtrol-II using an Personnel Computer. Included on the diskette are common instrument applications which may be used as a starting point for your application. This permits the user to have an excellent starting point and helps speed the user through the instrument setup.

Operation of Serial Communication Port with Printers

LEVELtrol-II's RS-232 channel supports a number of operating modes. One of these modes is intended to support operation with a printer in applications requiring transaction printing, data logging and/or printing of calibration and maintenance reports.

For transaction printing, the user defines the items to be included in the printed document. The user can also select what initiates the transaction print generated as part of the setup of the instrument. The transaction document may be initiated via a front panel key depression, a remote contact closure, or upon completion of a batch.

In data logging, the user defines the items to be

included in each data log as a print list. The user can also select when or how often he wishes a data log to be made. This is done during the setup of the instrument as either a time of day or as a time interval between logging.

The system setup and maintenance report lists all the instrument setup parameters and usage for the current instrument configuration. In addition, the Audit trail information is presented along with a status report listing any observed malfunctions which have not been corrected.

The user initiates the printing of this report at a designated point in the menu by pressing the print key on the front panel.

Operation of Serial Port with Modems (optional)

The LEVELtrol-II RS-232 channel may be used with a modem in remote metering applications.

2. Installation

WARNING: In control applications, independent safety interlocks (liquid level switches) should be used to prevent hazards which could result from a malfunctioning LEVELtrol II.



General Mounting Hints

2.1 General Mounting Hints:

The LEVELtrol-II Flow Computer should be located in an area with a clean, dry atmosphere which is relatively free of shock and vibration. The unit is installed in a 5.43" (138mm) wide by 2.68" (68mm) high panel cutout. (see Mounting Dimensions) To mount the instrument, proceed as follows:

Mounting Procedure

- a. Prepare the panel opening.
- b. Slide the unit through the panel cutout until it touches the panel.
- c. Install the screws (provided) in the mounting bracket and slip the bracket over the rear of the case until it snaps in place.
- d. Tighten the screws firmly to attach the bezel to the panel. 3 in. lb. of torque must be applied and the bezel must be parallel to the panel.

Termination Connectors:

Minimum Wire Gauge: 22 AWG
 Maximum Wire Gauge: 14 AWG
 Voltage/current limits are limited by unit specifications.

Permanently Connected Equipment:

UL 3101-1, Section 6.12.2.1 specifies that:

- A switch or circuit breaker shall be included in the building installation;
- It shall be in close proximity to the equipment and within easy reach of the OPERATOR;
- It shall be marked as the disconnecting device for the equipment.

Ensure that the switch or circuit breaker chosen is suitable for the power requirements of the unit.

2.2 Mounting Diagrams:



IMPORTANT!

To provide protection type IP65/NEMA 4X, the unit must be mounted with the bezel adaptor and the gasket (supplied with the mounting kit). The bezel must be glued to the unit with silicon. (see Instructions supplied with the mounting kit)

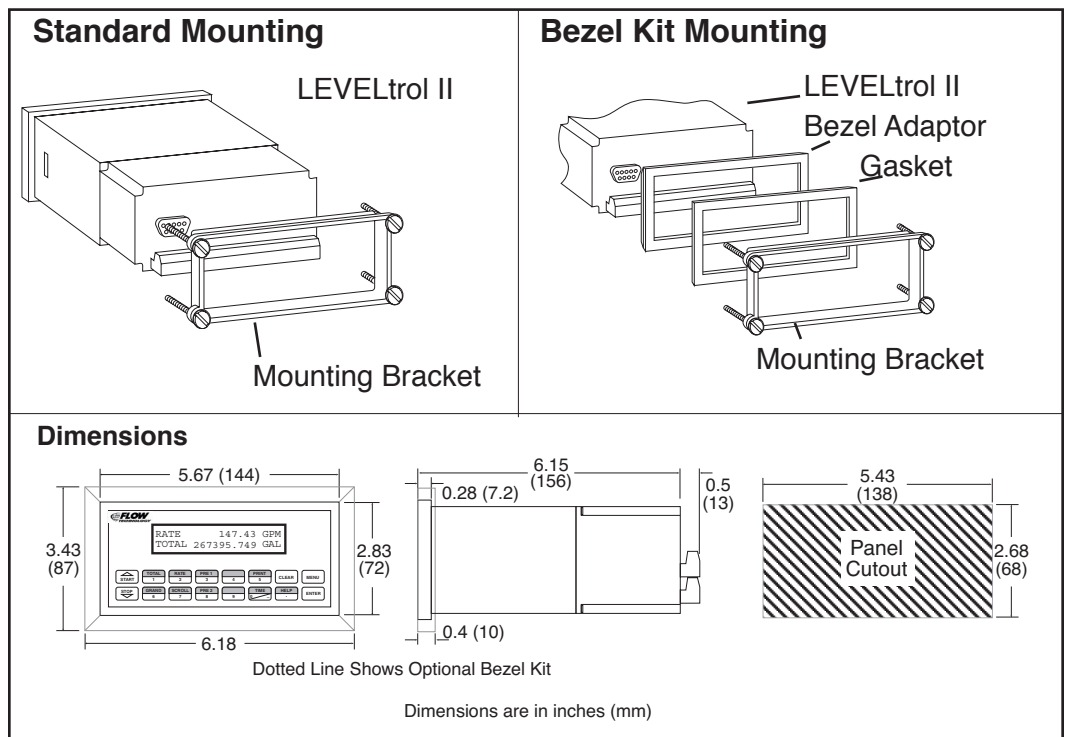

3. Applications

Tank Level/Volume

3.1 Tank Level/Volume

Measurements:

A level or hydrostatic pressure transmitter measures the liquid level in a tank. A temperature sensor can also be installed to correct for liquid thermal expansion or density effects.

Output Results:

- Display Results
Level, Available Tank Volume, Gross Tank Volume
- Analog Output
Level or Tank Volume
- Pulse Output
Changes in Tank Volume
- Relay Outputs
Level or Tank Volume Alarms

Applications:

The LEVELtrol-II can monitor actual liquid level and tank volume of a liquid. Alarms are provided via relays and datalogging is available via analog (4-20mA) and serial outputs.

Tank Level/ Volume Illustration

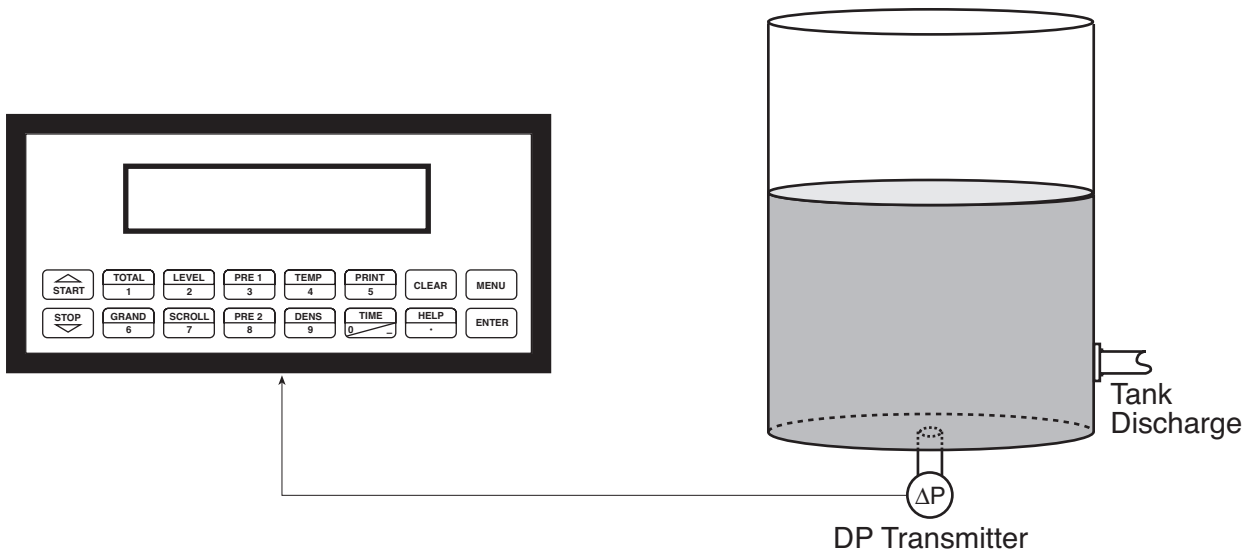

Corrected Tank Volume

3.2 Corrected Tank Volume

Measurements:

An ultrasonic, hydrostatic or differential pressure level sensor measures the liquid level in a horizontal tank. A temperature sensor is installed to correct for liquid thermal expansion.

Calculations:

- Corrected Tank Volume is calculated using the level and temperature inputs as well as the liquid's thermal expansion coefficient stored in the LEVELtrol-II. Use the "SET FLUID PROPERTIES" submenu to define reference temperature and density values for standard conditions.

Output Results:

- Display Results
Level, Available Corrected Volume, Gross Corrected Volume, Temperature
- Analog Output
Tank Volume or Temperature or Density
- Pulse Output
Change in Tank Volume
- Relay Outputs
Level or Tank Volume Alarms

Applications:

Monitoring corrected volume of a liquid stored in a horizontal tank. Alarms are provided via relays and datalogging is available via analog (4-20mA) and serial outputs.

Corrected Liquid Volume Illustration

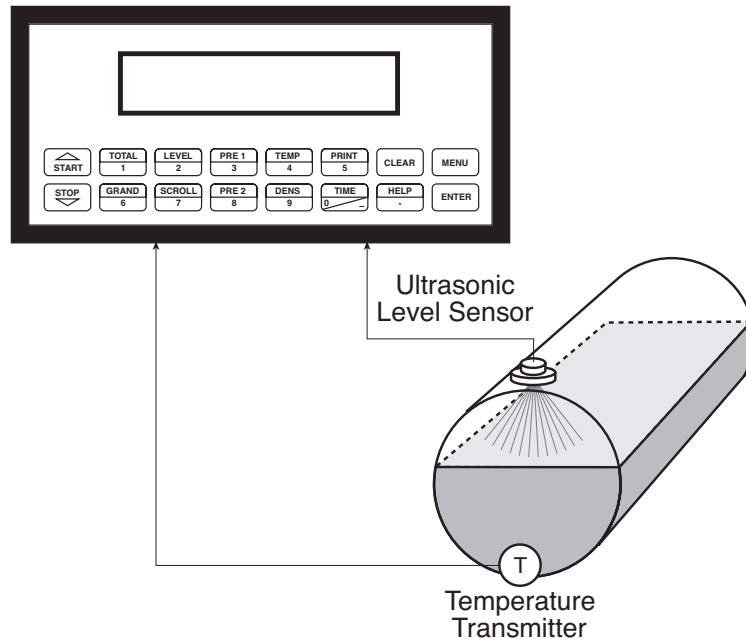

Total Mass in Tank

3.3 Total Mass in Tank

Measurements:

Actual level is measured by the level sensor (ultrasonic, hydrostatic or differential pressure transmitter). Temperature is measured by the temperature transmitter. A density transmitter can alternately be used for direct density measurements.

Calculations:

- The density is calculated using the reference density and the thermal expansion coefficient of the liquid (see "SET FLUID PROPERTIES" submenu).
- Total Mass in tank is computed for tank geometry.

Output Results:

- Display Results
Level, Total Available Mass in Tank, Total Gross Mass in Tank, Temperature, Density
- Analog Output
Level, Total, Temperature or Density
- Pulse Output
Change in Tank Mass
- Relay Outputs
Level, Total or Temperature Alarms

Applications:

Monitoring level and mass total of any liquid in a tank. Alarms are provided via relays and datalogging is available via analog (4-20mA) and serial outputs.

Liquid Mass Illustration

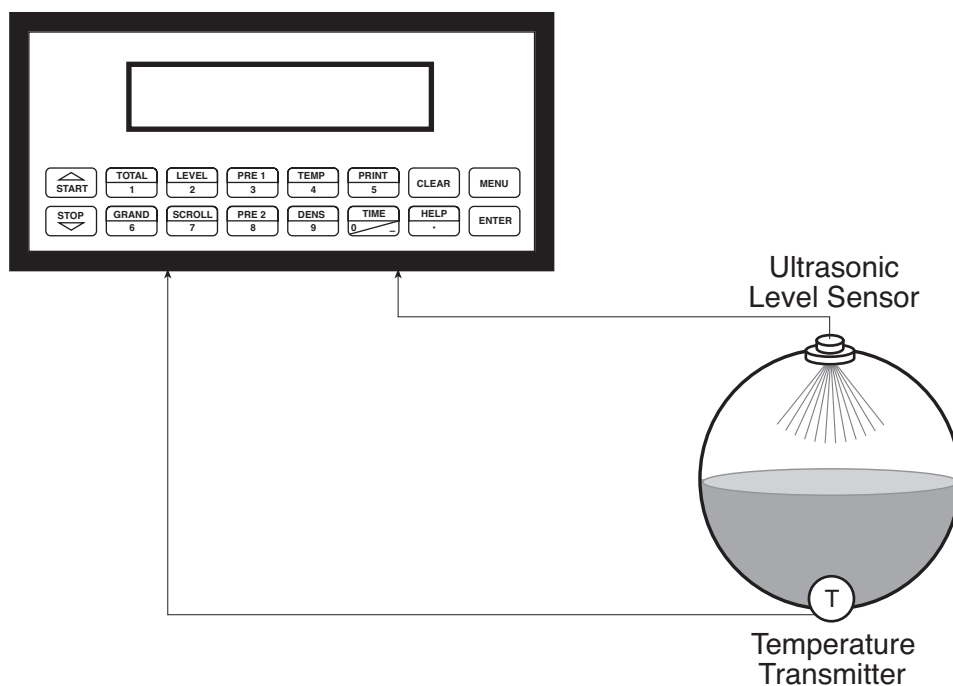

Batching Volume, Corrected Volume or Mass from Tank Level

3.4 Batching Volume, Corrected Volume or Mass from Tank Level

Measurements:

A Level transmitter measures the liquid level in a tank. A temperature sensor can also be installed to correct for liquid thermal expansion (see 3.2 Corrected Volume).

Calculations:

- Fluid Density (if required)
- Actual Level in tank is computed from level signal, installation parameters and fluid properties.
- Tank Volume, Corrected Volume, Mass
- Compare quantity delivered to quantity requested.

Output Results:

- Display Results
Level, Batch Total, Tank Total, Temperature, Density
- Analog Output
Level, Total, Temperature or Density
- Pulse Output
Amount delivered since start of batch (other uses available)
- Relay Outputs
Batch Total, Level, or Temperature Alarms

Applications:

Batching and monitoring level and total quantity in tank of any liquid. Batching is accomplished via relays and datalogging is available via analog (4-20mA) and serial outputs.

Batching Illustration

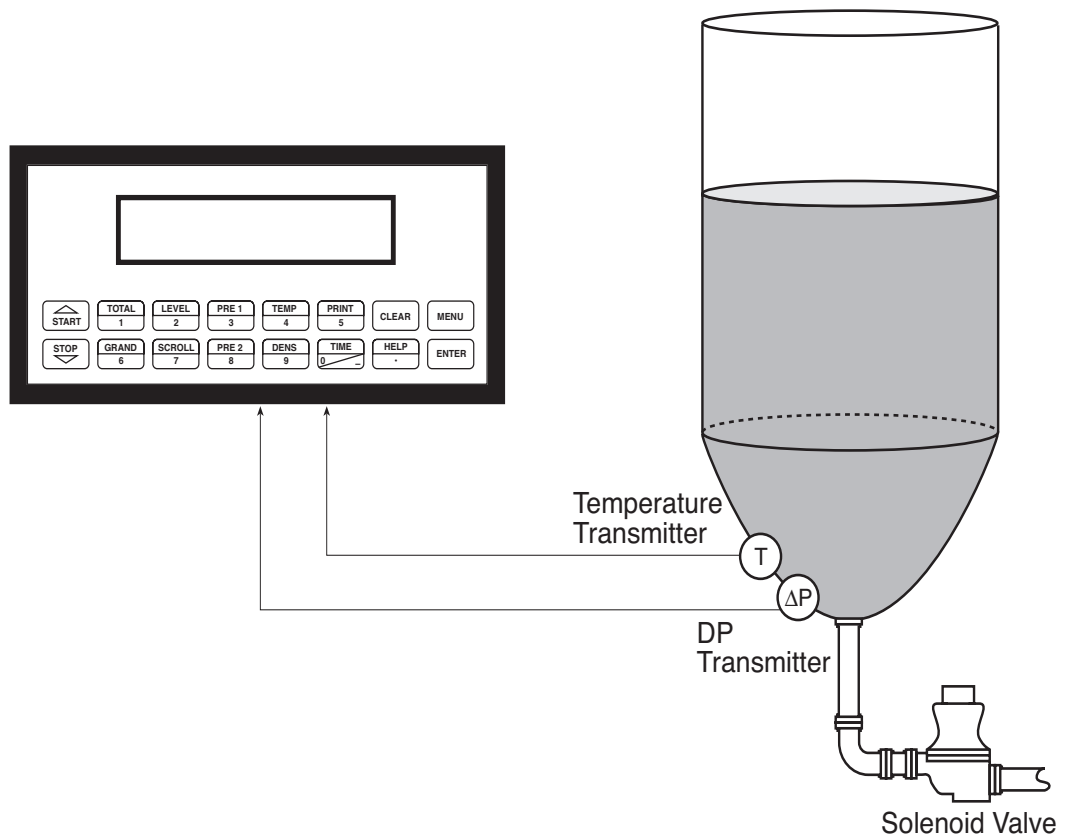

4 WIRING

Batcher Wiring

4.1 Typical Batcher Wiring:

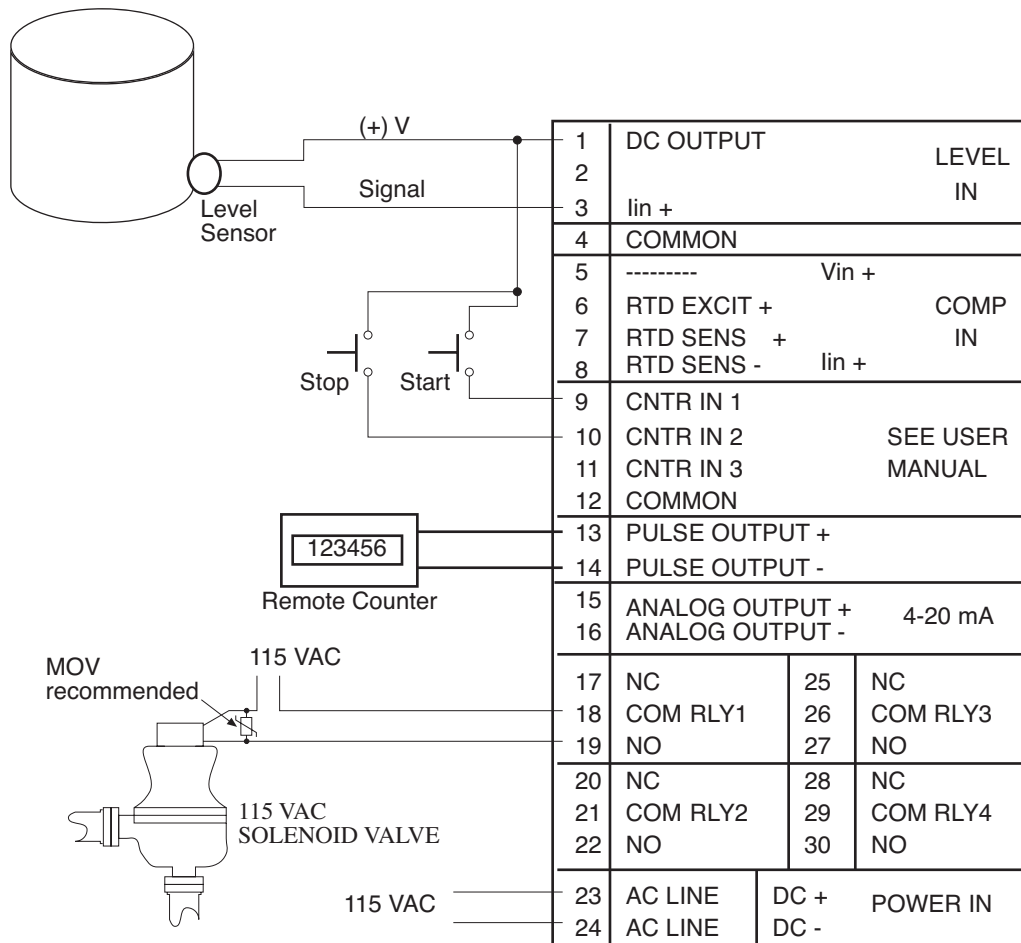

Level / Total Wiring

4.2 Typical Level/Total Wiring:

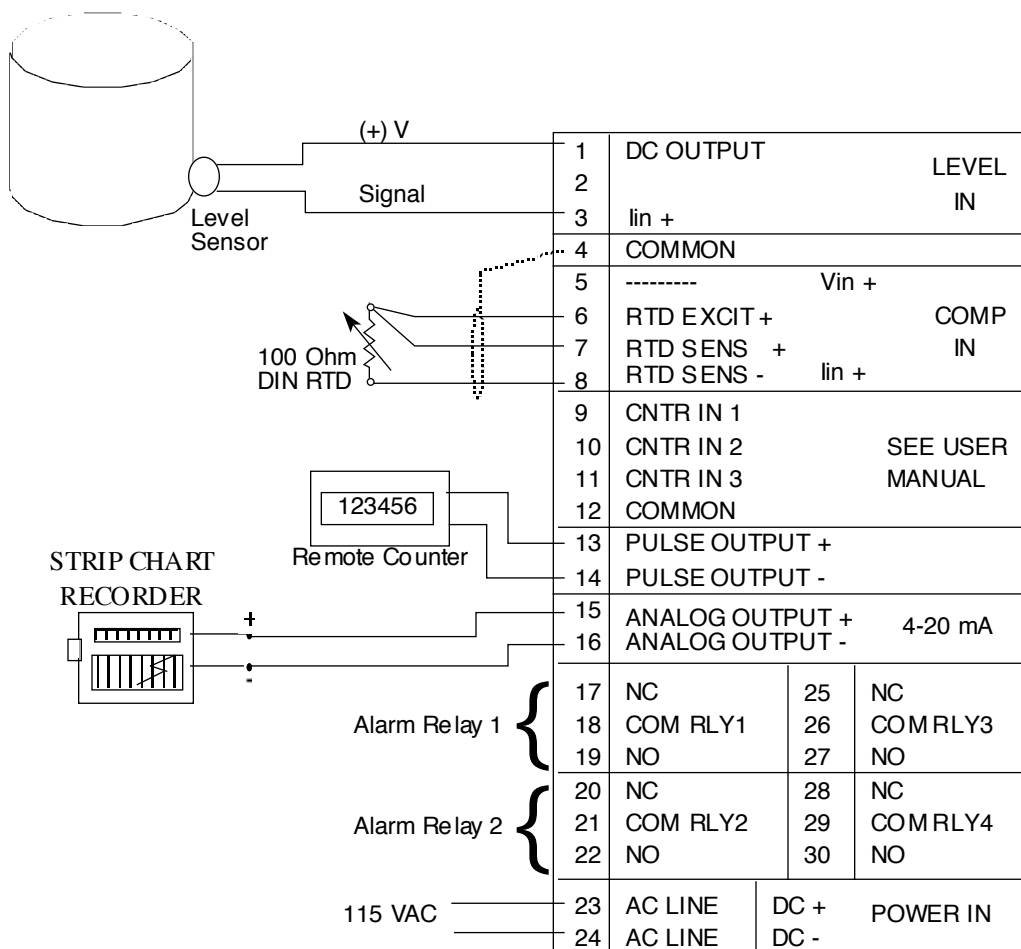

4.3 Wiring In Hazardous Areas:

Examples using MLT787S+ Barrier (MTL4755ac for RTD)

Level Input

Flow Input

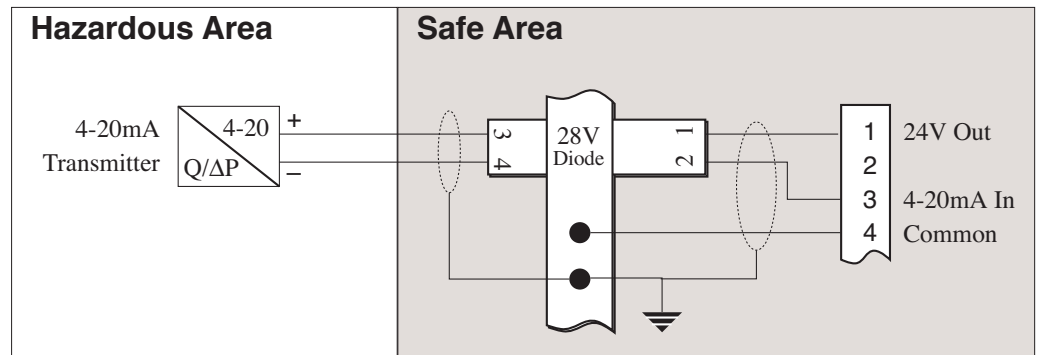

Temperature or Density Input (4-20mA Transmitter)

Temperature/Density Input (4-20mA Transmitter)

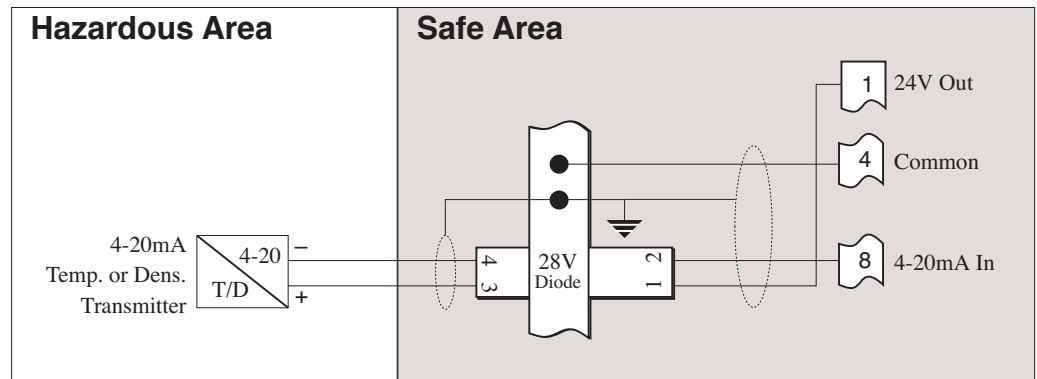

Temperature Input (RTD)

Temperature Input (RTD)

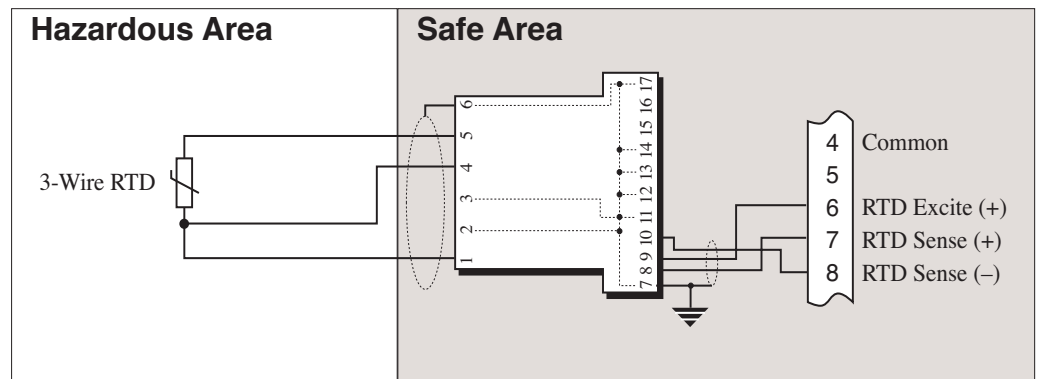

5. UNIT OPERATION

5.1 Front Panel Operation Concept for Run Mode

The LEVELtrol-II is fully programmable through the front panel. Please review the following usage summary before attempting to use the instrument.

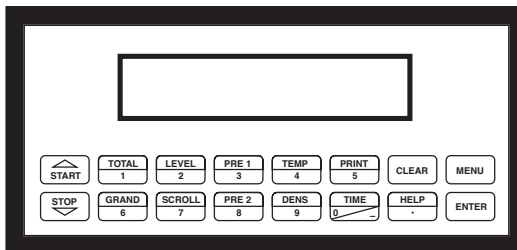

How To Use On-Line Help

HELP

On-line help is provided to assist the operator in using this product. The help is available during RUN and SETUP modes simply by pressing the HELP key. The HELP key is used to enter decimals when entering numeric values.

How To Use Function Keys

FUNCTION KEYS

In the RUN mode, several keys have a special, direct access feature, to display an item of interest (i.e. LEVEL, TOTAL, PRE 1, etc.). Press the key to view your choice. Press the SCROLL key to return to scrolling display.

How To Enter Presets

PRESET KEYS

In the RUN mode, PRE 1 & PRE 2 keys are used to view and/or change the preset setpoints. To view the Presets, simply press the desired Preset key once. Rapidly press the Preset keys three times, then press the Clear key for direct editing of the preset setpoints. The access for changing the presets can be locked.

How To Create a Scroll List

SCROLL

Rapidly press the Scroll key twice to setup a display list. Press the CLEAR key to remove old scroll list. Press the function key for the item you wish to add. Use the Δ ∇ keys to assign the line.

How To Use The Print Key

PRINT

The PRINT key is used to print on demand. When the PRINT key is pressed, a user defined list of data (TOTAL, LEVEL, PRE 1, etc.) is sent to the RS-232 port. A timed message of "PRINTING" will be displayed to acknowledge the print request.

How To Use Special Batching Keys

SPECIAL BATCHING KEYS

The START and STOP keys are used only when batching to start and stop batches. The CLEAR key will clear the batch total. All other keys work the same in both Level/Total mode and Batch mode. The Start and Stop keys operation are set by the control input settings. The Start options are: START or RESET/START. The Stop options are: STOP or STOP/RESET.

How To Use The Menu Key

MENU KEY

The MENU key is used to enter the Setup and Test modes. Press the MENU key to enter the Setup and Test modes. (See section 6 for Setup mode, section 8 for Test mode). The MENU key is used as "escape" in Setup and Test Programming. Pressing the MENU key while programming in the Sub-Menu groups will backup the display to that Sub-Menu group heading. Pressing the MENU key while viewing the Sub-Menu groups will backup the display to the Top Level Menu.

How To Acknowledge Alarms

ACKNOWLEDGING ALARMS

Most alarm messages are self-clearing. Press the ENTER key to acknowledge and clear alarms.

NOTE: Some keys and functions are password protected. Enter the password to gain access. The passwords are factory set as follows:
Operator = 0
Supervisor = 2000

**General
Operation****5.2 General Operation**

The unit can display: Level, Available Total, Gross Total, Temperature, Density, Presets and Time of Day. The Temperature and/or Density can be displayed even if you are using the Volumetric Flow Equation (a Temperature or Density sensor must be installed). The unit can perform Volume, Mass or Corrected Volume equations using a temperature or density sensor (these equations can be computed without Temp/Dens sensors by using user defined default values). The unit can be programmed to perform Level or Batching functions (see section 6.3, SELECT INSTRUMENT Submenu).

**Level/Total
Operation****5.3 Level/Total Operation**

The Level/Total mode is used primarily to monitor and control level and tank volume. The relays can be used to trigger level, tank volume, temperature or density alarms. Analog, pulse and communication outputs are also provided.

**Password Protection
(Level/Total mode)****5.3.1 Password Protection for Level/Total mode**

After an Operator and/or Supervisor Password is defined in the setup mode (see section 6.3, SETUP PASSWORD submenu), the unit will be locked. The unit will prompt the user for the password when trying to perform the following functions:

Enter Menu

Edit Preset 1 (PRE 1 Key) (if operator access is set to "none")

Edit Preset 2 (PRE 2 Key) (if operator access is set to "none")

The Supervisor password should be reserved for supervisors. The Supervisor password will allow access to restricted areas of the Setup and Test menus.

A control input can also be configured as a jumper hardware lockout.

**Relay Operation
(Level/Total mode)****5.3.2 Relay Operation in Level/Total mode**

Two or four relays are available for control and/or alarm output functions. The relays can be assigned to trip according to level, total, temperature or density readings. The relays can be programmed for low or high alarms. Preset 1 (RLY1) and Preset 2 (RLY2) are easily accessible by pressing the PRE 1 or PRE 2 key on the front panel. Preset 3 and Preset 4 are accessible only through the setup menu.

NOTE: Choose relay operations that will fail safe for your process. Also use suitable safety interlocks (level switches) to prevent overfilling containers.

**Pulse Output
(Level/Total mode)****5.3.3 Pulse Output in Level/Total mode**

The isolated pulse output (open collector) is menu is assigned to follow changes in the Volume Total, Corrected Volume Total or Mass Total. The pulse output duration can be set for 10mS (100Hz max) or 100mS (10Hz max). A pulse output scale factor (pulse value) can be set to scale the pulse output. The pulse output is ideal for connecting to remote totalizers or other devices such as a PLC. See section 1.3 for electrical specifications. Pulse outputs can be used to indicate approximate delivery totals received or delivered.

Analog Output
(Level/Total mode)

5.3.4 Analog Output in Level/Total mode

The analog output is menu assignable to correspond to the Level, Volume, Corrected Volume, Mass, Temperature, Density. The analog output is ideal for "trend" tracking using strip chart recorders or other devices.

RS-232 Serial Port
(Level/Total mode)

5.3.5 RS-232 Serial Port Operation in Level/Total mode

The RS-232 serial port can be used for programming (using the optional Setup Disk) or for communicating to printers and computers in the Operating Mode (Run Mode).

PC Communications:

The Setup Disk also allows the user to query the unit for operating status such as Level, Tank Total, Temperature, Density, Presets, etc.

Operation of RS-232 Serial Port with Printers:

Transaction Printing

For transaction printing, the user defines the items to be included in the printed document (see SET PRINT OUTPUT, Select_list). The transaction document can be initiated by pressing the PRINT key or by a remote contact closure.

Data Logging to Printer

In data logging, the user defines the items to be included in each data log (see SET PRINTER OUTPUT, Select_list). The user can also select when (time of day) or how often (print interval) the data log is to be made (see section 6.3.19 SET PRINT OUTPUT, Configure).

System Setup and Maintenance Report

The system setup and maintenance report lists all of the instrument setup parameters and usages for the current instrument configuration. The audit trail information and a status report is also printed. This report is initiated in the Test menu (see PRINT SYSTEM SETUP).

5.3.6 RS-485 Serial Port Operation in Level/Total mode

The RS-485 serial port can be used for accessing level, total quantity, temperature, density and alarm status information. The port can also be used for changing presets and acknowledging alarms.

**Batcher
Operation****5.4 Batcher Operation**

The Batcher mode is used primarily to dispense batches of fluid based on changes in tank volume as indicated by tank level. The main difference between the Batch mode and Level/Total mode is the relay operation. The Batch mode allows the operator to "START" the batch transfer via the front panel or remote input. Once started, the relays (RLY1 & RLY2) will energize and send power to a flow control device (i.e. solenoid valve or pump). The level sensor will send a signal to the unit and total comparisons will begin. When the Prewarn value (PRE 2) is reached, Relay 2 will drop out (this is ideal for flow slow down). When the Batch amount (PRE 1) is reached, Relay 1 will drop out and the Batch is complete.

Several messages will be displayed during normal batch operation (i.e. Batch Fill, Batch Stopped).

5.4.1 Batcher Configuration.**Batcher Configuration**

When the unit is programmed for the batch mode, several batch operation choices are available. These choices include: Up or Down Counting, Batch Into or Out of the Tank, Batch Overrun Correction feature, Start or Reset/Start, and Stop or Stop/Reset.

BATCH OVERRUN

The batch overrun is used for batch applications that have slow responding valves and a consistent batching flowrate. When the Batch Overrun is set, the unit will compensate for batch overruns by computing an averaged overrun value from the last four batches. This average is used to internally adjust the batch setpoint to minimize overrun.

START, RESET/START and STOP, STOP/RESET

When configuring the control inputs, Control Input1 can be set for START or RESET/START. When set for START, the unit will start batching when a signal is applied to Control Input1 or the front panel Start key is pressed. A separate Reset signal must be used to clear the previous batch total. When set for RESET/START, the unit will automatically reset then start when a signal is applied to Control Input1 or the front panel Start key is pressed (provided that the previous batch was completed). If a previous batch was stopped during a batch cycle, the unit will Restart from where it was stopped.

Control Input 2 can be set for STOP or STOP/RESET. When set for STOP, the unit will stop batching when a signal is applied to Control Input 2 or the front panel Stop key is pressed. A separate Reset signal must be used to clear the batch total. When set for STOP/RESET, a running batch will stop when a signal is applied to Control Input 2 or the front panel Stop key is pressed. If the unit is Stopped or after a completed batch, the unit will reset when a signal is applied to Control Input 2 or the front panel Stop key is pressed.

NOTE: Applying a voltage level to Control Input 2 will inhibit or override all Start inputs in either mode.

Password Protection
(Batch mode)**5.4.2 Password Protection for Batcher Mode**

After an Operator and/or Supervisor Password is defined in the setup mode (see section 6.3, SETUP PASSWORD submenu), the unit will be locked. The unit will prompt the user for the password when trying to enter the menu. The unit will also prompt the user to enter the password if this access has been limited.

The Supervisor password should be reserved for supervisors. The Supervisor password will allow access to restricted areas of the Setup and Test menus.

The passwords are factory set as follows:

Operator = 0

Supervisor = 2000

A control input can also be configured as a jumper hardware lockout.

Relay Operation
(Batch mode)**5.4.3 Relay Operation in Batcher mode**

Two or four relays are available for batch control and/or alarm outputs. Preset 1 (RLY1) is reserved for batch amount, Preset 2 (RLY2) is usually reserved for prewarn. (see section 5.4 Batcher Operation for Relay 1 & Relay 2 functions)

Preset 1 (RLY1) and Preset 2 (RLY2) are easily accessible by pressing the PRE 1 or PRE 2 key on the front panel. Preset 3 and Preset 4 are accessible only through the setup menu.

Relays 3 and 4 can be assigned to trip according to level, temperature, density, overrun or alarm. When level, temperature or density is selected the relays can be programmed as low or high alarms.

Overrun can be used to detect minor leakage around valves in some applications.

NOTE: Choose relay operations that will fail safe for your process. Also use suitable safety interlocks (level switches) to prevent overfilling containers.

Pulse Output
(Batch mode)**5.4.4 Pulse Output in Batcher mode**

The isolated pulse output (open collector) is assigned to produce pulses on changing Volume, Corrected Volume or Mass as indicated by the pulse output usage and the compensation equation selected. The pulse output duration can be set for 10mS (100Hz max) or 100mS (10Hz max). A pulse output scale factor (pulse value) can be set to scale the pulse output. The pulse output is ideal for connecting to remote totalizers or other devices such as a PLC. It may be used to keep track of deliveries, the amount sent to/from a tank or for a combination of these. See section 1.3 for electrical specifications.

Analog Output
(Batch mode)**5.4.5 Analog Output in Batch mode**

The analog output is menu assignable to correspond to the Tank Level, Temperature, Density, Volume Total, Corrected Volume Total or Mass Total. The analog output is ideal for "trend" tracking using strip chart recorders or other devices.

RS-232 Serial Port
(Batch mode)**5.4.6 RS-232 Serial Port Operation in Batch mode**

The RS-232 serial port can be used for programming (using the Setup Disk) or for communicating to printers and computers in the Operating Mode (Run Mode).

PC Communications:

The Setup Disk also allows the user to query the unit for operating status such as Level, Tank Total, Batch Total, Temperature, Density, Presets, etc.

Operation of RS-232 Serial Port with Printers:Transaction Printing

For transaction printing, the user defines the items to be included in the printed document (see section 6.3.20 SET PRINT OUTPUT, Select_list). The transaction document can be initiated by pressing the PRINT key, by a remote contact closure or print automatically at end of batch.

Data Logging

In data logging, the user defines the items to be included in each data log (see section 6.3.20 SET PRINT OUTPUT, Select_list). The user can also select when (time of day) or how often (print interval) the data log is to be made (see section 6.3.19 SET PRINT OUTPUT, Configure).

System Setup and Maintenance Report

The system setup and maintenance report lists all of the instrument setup parameters and usage for the current instrument configuration. The audit trail information and a status report is also printed. This report is initiated in the Test menu (see section 8.2.3 PRINT SYSTEM SETUP).

5.4.7 RS-485 Serial Port Operation in Batch mode**RS-485 Serial Port**
(Batch mode)

The RS-485 serial port can be used for starting, stopping, monitoring and controlling the instrument in the operating mode (run mode). The port can also be used for changing presets and acknowledging alarms.

6. PROGRAMMING

6.1 Front Panel Operation Concept for Program Mode

The LEVELtrol-II is fully programmable through the front panel. Please review the following usage summary before attempting to use the instrument.

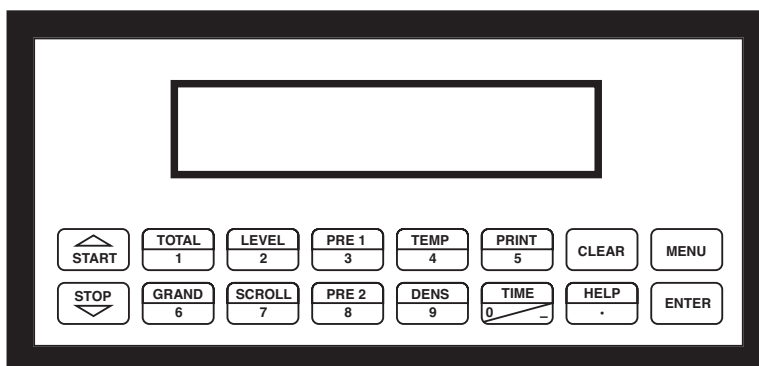

Setup Mode:

How To Make Mode Changes

MODE CHANGES

Pressing the MENU key will offer selections of RUN, SETUP, TEST. RUN is the normal operating mode for the instrument. SETUP offers various sub-menus used for instrument setup. TEST offers various sub-menus for Test, Calibration and System Start-up.

How To Navigate Through Sub-Menu Groups

SUBMENU GROUP NAVIGATION

Use the UP and DOWN arrow keys to navigate up and down through the Sub-Menu groups when in the SETUP or TEST mode. Press the ENTER key to enter a desired setup or test Sub-Menu group.

How To Select Program Choices

SELECTION OF ITEM

During setup, the unit will often offer multiple choices for a given topic. The topic prompt appears on the top line of the display. The choices are shown on the lower line of the display.

To select an item, press the key beneath the desired choice. The selected choice will blink. Press the ENTER key to accept the selected choice.

How To Enter Numeric Values

NUMERIC ENTRY

The keys labeled "0 - 9", "-", ".", CLEAR and ENTER are used to enter numerical values. A leading 0 will assume that you intend to enter a minus "-" sign. Press the CLEAR key to clear the existing value and to enable editing, then enter desired value and press ENTER to accept value.

How To Enter Text Characters

TEXT CHARACTER ENTRY

Some setup items (i.e. Descriptors, Units Label) require the user to enter text characters. Press CLEAR to enable editing. The UP and DOWN arrow keys are used to scroll through the available character sets for each individual character. Press the ENTER key to accept the character and advance to the next character until the entire text is acceptable.

WARNING!

WARNING: The outputs remain operational during instrument setup. The relays will change state as the instrument is configured. Be sure no hazards can be created before configuring the unit.











6.2 EZ Setup

The EZ Setup routine is a quick and easy way to configure the unit for the most commonly used instrument functions. This setup assumes that you are measuring level using a 4-20 mA transmitter. Entering the EZ Setup mode automatically sets many features. This may cause any previously programmed information to be lost or reset. For a complete customized configuration, see sections 6.3 and 6.4.

<u>Menus</u>	<u>Display</u>	<u>Notes</u>
6.2.1 TOP LEVEL SETUP MENU	<pre>SELECT OPERATE STATE Run Setup Test ENTER: </pre>	Select Setup to enter the instrument setup routine.
6.2.2 EZ Setup Submenu Groups	<pre>DO EZ SETUP? No Yes ENTER: </pre>	Select YES to enter EZ Setup routine.
	<pre>ARE YOU SURE? No Yes ENTER: </pre>	Confirm that you want to run EZ Setup. Caution: Any previous program settings may be lost or reset.
	<pre>INSTRUMENT TYPE Level/Tot Batch ENTER: </pre>	Instrument Type.
	<pre>COMPENSATION EQ. Volume Mass Cor/Vol ENTER: </pre>	Select the desired compensation equation.
	<pre>VOLUME UNIT LABEL gal ENTER: </pre>	Enter the desired volume units label.
	<pre>LEVEL UNIT LABEL in ENTER: </pre>	Enter the desired level units label.
	<pre>TANK SHAPE TBL. VERT HORZ SPHR ENTER: </pre>	Select the appropriate tank shape.
	<pre>STRAPPING TABLE LEV01:0.0 in ENTER: </pre>	If TBL selected, Enter the desired Level for the appropriate point of the table .
	<pre>STRAPPING TABLE VOL01:0.0 gal ENTER: </pre>	Enter the desired Level for the appropriate point of the table .
	<pre>VOLUME CONV. FACTOR 231.0 in³/g ENTER: </pre>	Enter the volume units conversion factor needed by the unit.
	<pre>TANK DIAMETER 100 in ENTER: </pre>	Enter the tank diameter.

Through 32 Points









Continued on next page.

Menus	Display	Notes	
6.2.2 (continued) EZ Setup Submenu Groups	TANK LENGTH 100 in	If VERT or HORZ selected, Enter tank length.	
		SENSOR LOCATION 0.0 in	Enter the distance between the base of tank and the level sensor location. (Enter a negative value if the sensor is located below the tank)
		DISCHARGE LOCATION 0.0 in	Enter the distance between the base of tank and the discharge location. (Enter a negative value if it is located below the tank)
		LEVEL SENSOR TYPE delta_p LEVEL	Select the appropriate sensor type.
		LEVEL FULL SCALE 3.609181b/in2	Enter full scale of level sensor.
		REF. DENSITY 8.3372 lbs/g	Enter the reference density.
		REF. TEMPERATURE 60.0 F	Enter the reference temperature.
		EXPAN. FACTOR [xe-6] 112.00	Enter the expansion factor of the fluid.
		OPERATOR PASSWORD ****	Enter an operator password.
	Advance to <i>Run Mode</i> .		

6.3 Setup Menus

Menus	Display	Notes
6.3.1 Top Level Setup Menu		Select Setup to enter the instrument setup routine.
6.3.2 Submenu Groups		<p>Refer to Page 20 for Details.</p> <p>Refer to Page 23 for Details.</p> <p>Refer to Page 24 & 25 for Details.</p> <p>Refer to Pages 26 & 27 for Details.</p> <p>Refer to Pages 28 & 29 for Details.</p> <p>Refer to Page 30 for Details.</p> <p>Refer to Pages 30 & 31 for Details.</p> <p>Refer to Page 31, 32 & 33 for Details.</p> <p>Refer to Page 34 for Details.</p> <p>Refer to Pages 34 & 35 for Details.</p> <p>Refer to Page 35 for Details.</p> <p>Refer to Page 36 for Details.</p> <p>Refer to Page 37 for Details.</p> <p>Refer to Page 37 for Details.</p>

6.4 Setup Sub-Menus

Sub-menus	Display	Notes
6.4.1 DO EZ SETUP?	<div style="border: 1px solid black; padding: 5px; text-align: center;"> DO EZ SETUP? NO YES </div> <div style="text-align: center; margin-top: 5px;">  </div> <p style="text-align: center;">Advance To INSTRUMENT TYPE</p>	<p>Refer to page 19 for EZ Setup routine.</p> <p>If NO selected, advance to Set Instrument Type for general menu access and setup.</p>
6.4.2 SET INSTRUMENT TYPE	<div style="border: 1px solid black; padding: 5px; text-align: center;"> SET INSTRUMENT TYPE </div> <div style="text-align: center; margin-top: 5px;">  </div> <div style="border: 1px solid black; padding: 5px; text-align: center;"> INSTRUMENT TYPE Level/Tot Batch </div> <div style="text-align: center; margin-top: 5px;">  </div> <div style="border: 1px solid black; padding: 5px; text-align: center;"> COMPENSATION EQ. Volume Mass Cor/Vol </div> <div style="text-align: center; margin-top: 5px;">  </div> <p style="text-align: center;">Advance To SETUP INDICATORS</p>	<p>Press ENTER when Level/Total is flashing to configure the instrument as a Level/Totalizer.</p> <p>Select the desired Compensation Equation.</p>
	<div style="border: 1px solid black; padding: 5px; text-align: center;"> INSTRUMENT TYPE Level/Tot Batch </div> <div style="text-align: center; margin-top: 5px;">  </div> <div style="border: 1px solid black; padding: 5px; text-align: center;"> BATCH COUNT MODE Up Down </div> <div style="text-align: center; margin-top: 5px;">  </div> <div style="border: 1px solid black; padding: 5px; text-align: center;"> BATCH DIRECTION Out In </div> <div style="text-align: center; margin-top: 5px;">  </div> <div style="border: 1px solid black; padding: 5px; text-align: center;"> BATCH OVERRUN COMP OFF ON </div> <div style="text-align: center; margin-top: 5px;">  </div>	<p>Press ENTER when Batch is flashing to configure the instrument as a Batcher.</p> <p>Select UP to Reset to 0 and count up to preset.</p> <p>Select DOWN to reset to Preset and count down to 0.</p> <p>Select "Out" if batching out of the tank. Select "In" if batching into the tank.</p> <p>Select ON to set the unit to operate using a Batch Overrun Compensation routine. Select OFF to inhibit Batch Overrun Compensation routine. (See Section 5.4)</p> <p>Select the desired Compensation Equation.</p>
	<div style="border: 1px solid black; padding: 5px; text-align: center;"> COMPENSATION EQ. Volume Mass Cor/Vol </div> <div style="text-align: center; margin-top: 5px;">  </div> <p style="text-align: center;">Advance To SETUP INDICATORS</p>	

Sub-menus	Display	Notes
6.4.3 SETUP INDICATORS (Vol)	SETUP INDICATORS	Press ENTER to begin setup of indicators.
	SETUP INDICATORS Vol. Mass Level Temp	Press ENTER when Vol. is flashing to configure the Totalizer Indicators
	TOTAL DESCRIPTOR TOTAL	Enter the desired Total Descriptor
	VOLUME UNIT LABEL gal	Enter the desired Volume Units Label.
	TOTAL DEC PLACES 0	Select the desired Total Decimal Place. 0-3 decimal places allowed.
Advance To SETUP INDICATORS (Mass)		
6.4.4 SETUP INDICATORS (Mass)	SETUP INDICATORS Vol. Mass Level Temp	Press ENTER when Mass is flashing to configure the Density Indicators.
	DENSITY DESCRIPTOR DENS	Enter the desired Density Descriptor.
	MASS UNITS lbs	Enter the desired Mass Units Label.
	DENSITY DEC PLACES 3	Select the desired Density Decimal Place. 0-3 decimal places allowed.
Advance To SETUP INDICATORS (Level)		

Sub-menus	Display	Notes
6.4.5 SETUP INDICATORS (Level)	<pre> SETUP INDICATORS Vol. Mass Level Temp ENTER LEVEL DESCRIPTOR Level ENTER LEVEL UNIT LABEL in ENTER LEVEL DEC PLACES 0 ENTER </pre>	<p>Press ENTER when Level is flashing to configure the Level Indicators</p> <p>Enter the desired Descriptor for the Level Indicator.</p> <p>Enter the desired Level Units Label.</p> <p>Select the desired Level Decimal Place. 0-3 decimal places allowed.</p>
<p>Advance To SETUP INDICATORS (Temperature)</p>		
6.4.6 SETUP INDICATORS (Temperature)	<pre> SETUP INDICATORS Vol. Mass Level Temp ENTER TEMP DESCRIPTOR TEMP ENTER TEMPERATURE SCALE C F K R ENTER TEMP DEC PLACES 1 ENTER </pre>	<p>Press ENTER when Temp is flashing to configure the Temperature Indicators.</p> <p>Enter the desired Temperature Descriptor.</p> <p>Enter the desired Temperature Scale. C = Celsius, F = Fahrenheit, K = Kelvin, R = Rankine</p> <p>Select the desired Temperature Decimal Place. 0-3 decimal places allowed.</p>
<p>Advance To SETUP TANK STYLE</p>		







Sub-menus	Display	Notes
6.4.7 SETUP TANK STYLE (Strapping Table)	<pre> SETUP TANK STYLE ----- ENTER: </pre>	Press ENTER to begin the tank style configuration.
	<pre> TANK SHAPE TBL. VERT HORZ SPHR ----- ENTER: </pre>	Press ENTER when TBL. is flashing to configure the Strapping Table.
NOTE: Enter 0.0 for any level point other than point 1 to exit the strapping table setup. The unit will use all of the points entered up to that point.	<pre> STRAPPING TABLE LEV01:0.0 in ----- ENTER: </pre>	Enter the level for the point pair from strapping table.
	<pre> STRAPPING TABLE VOL01:0.0 gal ----- ENTER: </pre>	Enter the volume in tank at the corresponding level from strapping table.
	<pre> VOLUME CONV FACTOR 231.0 in ----- ENTER: </pre>	Enter the volume units conversion factor needed by the unit.
	<pre> Tank Length 800 in ----- ENTER: </pre>	Enter the length inside tank.
	<pre> SENSOR LOCATION 0.0 in ----- ENTER: </pre>	Enter the distance between the base of tank and the level sensor location. (Enter a negative value if the sensor is located below the tank)
	<pre> DISCHARGE LOCATION 0.0 in ----- ENTER: </pre>	Enter the distance between the base of tank and the discharge location. (Enter a negative value if it is located below the tank)
<p>Advance To SETUP PROCESS INPUTS</p>		







Through 32 Points

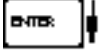
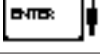
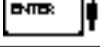
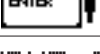
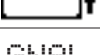
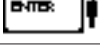
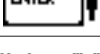
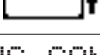

Table of Common Volume Conversion Factors

Level Unit	Volume Unit	Volume Conversion Factor	
in	gal	231	in ³ /gal
in	ft ³	1728	in ³ /ft ³
ft	gal	0.1337	ft ³ /gal
ft	ft ³	1	ft ³ /ft ³
mm	ℓ(dm ³)	1,000,000	mm ³ /ℓ
cm	ℓ(dm ³)	1,000	cm ³ /ℓ
m	ℓ(dm ³)	0.001	m ³ /ℓ
cm	m ³	1,000,000	cm ³ /m ³
m	m ³	1	m ³ /m ³

NOTE: For additional selections consult a detailed conversion table.

Sub-menus	Display	Notes
6.4.8 SETUP TANK STYLE (Vertical Cylindrical or Horizontal Cylindrical)	<pre> SETUP TANK STYLE </pre> 	Press ENTER to begin the tank style configuration.
	<pre> TANK SHAPE TBL. VERT HORZ SPHR </pre> 	Press ENTER when VERT or HORZ. to select vertical or horizontal tank.
	<pre> VOLUME CONU. FACTOR 231.0 in3/g </pre> 	Enter the requested volume conversion factor for units shown.
	<pre> TANK DIAMETER 100 in </pre> 	Enter the diameter inside tank.
	<pre> Tank Length 800 in </pre> 	Enter the length inside tank.
	<pre> SENSOR LOCATION 0.0 in </pre> 	Enter the distance between the base of tank and the level sensor location. (Enter a negative value if the sensor is located below the tank)
	<pre> DISCHARGE LOCATION 0.0 in </pre> 	Enter the distance between the base of tank and the discharge location. (Enter a negative value if it is located below the tank)
<p>Advance To SETUP PROCESS INPUTS</p>		

6.4.9 SETUP TANK STYLE (Sphere)	<pre> SETUP TANK STYLE </pre> 	Press ENTER to begin the tank style configuration.
	<pre> TANK SHAPE TBL. VERT HORZ SPHR </pre> 	Press ENTER when SPHR. is flashing to select spherical tank.
	<pre> VOLUME CONU. FACTOR 231.0 in3/g </pre> 	Enter the requested volume conversion factor for units shown.
	<pre> TANK DIAMETER 100 in </pre> 	Enter the diameter inside tank.
	<pre> SENSOR LOCATION 0.0 in </pre> 	Enter the distance between the base of tank and the level sensor location. (Enter a negative value if the sensor is located below the tank)
	<pre> DISCHARGE LOCATION 0.0 in </pre> 	Enter the distance between the base of tank and the discharge location. (Enter a negative value if it is located below the tank)
	<p>Advance To SETUP PROCESS INPUTS</p>	

Sub-menus	Display	Notes
6.4.10 SETUP PROCESS INPUTS (Level)	<pre> SETUP PROCESS INPUTS </pre>	Press ENTER to begin setup of Process Inputs.
		
	<pre> SETUP PROCESS INPUTS Level Compen/Input </pre>	Press ENTER when Level is flashing to configure the Level Input.
		
	<pre> LEVEL SENSOR TYPE delta_P Level </pre>	Press ENTER when desired level sensor type is flashing.
		<p>If LEVEL selected above; Select Level if sensor signal follows fluid level. Select Distance if sensor signal follows the distance from the sensor to the fluid.</p>
	<pre> LEVEL SIG. RESPONSE Level Distance </pre>	
		
	<pre> LEVEL INPUT SIGNAL Voltage Current </pre>	Choose Analog Signal Type.
		
	<pre> INPUT SIGNAL RANGE 0-10V 0-5V 1-5V </pre>	If Voltage selected, Choose desired Voltage Range.
	<pre> INPUT SIGNAL RANGE 4-20mA 0-20mA </pre>	If Current selected, Choose desired Current Range.
		
	<pre> LEVEL LOW SCALE ##### lb/in2 </pre>	Enter the value corresponding to the low analog signal of transmitter.
		
	<pre> LEVEL FULL SCALE ##### lb/in2 </pre>	Enter the High value corresponding to the High analog signal of transmitter.
		
	<pre> AVERAGING CONSTANT ##### </pre>	Enter the desired averaging value needed to dampen display.
		
	<pre> Advance To SETUP PROCESS INPUTS (Compen/Input) </pre>	

Sub-menus	Display	Notes
6.4.11 SETUP PROCESS INPUTS (Compensation Input)	<pre> SETUP PROCESS INPUTS Level Compen/Input [ENTER] </pre>	Press ENTER when Compen/Input is flashing to configure the Compensation Input.
	<pre> COMPENSATION INPUT None Dens Temp [ENTER] </pre>	Select Temperature to set the Compensation Input for Temperature inputs.
NOTE: When Density (Dens) is selected, The menu prompts will be very similar to the Temperature prompts. The menu will prompt the user for density values and density units.	<pre> COMP. INPUT SIGNAL Voltage Current RTD [ENTER] </pre>	Choose Temperature Signal Type. Advance to "Temp To Use if Input Fail", if RTD selected.
	<pre> INPUT SIGNAL RANGE 0-10V 0-5V 1-5V </pre>	If Voltage selected, Choose desired Voltage Range. Skip if RTD.
	<pre> INPUT SIGNAL RANGE 4-20mA 0-20mA [ENTER] </pre>	If Current selected, Choose desired Current Range. Skip if RTD.
	<pre> COMP. LOW SCALE 10 F [ENTER] </pre>	Enter the low temperature scale corresponding to the low temperature signal. Skip if RTD.
	<pre> COMP. FULL SCALE 110 F [ENTER] </pre>	Enter the high temperature scale corresponding to the high temperature signal. Skip if RTD.
	<pre> COMP. DEFAULT 60.0 F [ENTER] </pre>	Enter the Default Temperature. The unit will use this value if the temperature input fails.
	<pre> Advance To SET FLUID PROPERTIES </pre>	

Sub-menus	Display	Notes
<p>6.4.12 SET FLUID PROPERTIES</p>	<pre>SET FLUID PROPERTIES</pre>	<p>Press ENTER at this prompt to begin the Fluid Properties setup. (See Appendix A)</p>
	<pre>ENTER: </pre>	
	<pre>REF. DENSITY ##### lbs/g</pre>	<p>Enter the Reference Density.</p>
	<pre>ENTER: </pre>	
	<pre>REF. TEMPERATURE ##### F</pre>	<p>Enter the Reference Temperature.</p>
	<pre>ENTER: </pre>	
	<pre>EXPAN. FACTOR [xe-6] #####</pre>	<p>Enter the proper Expansion Factor of the fluid. NOTE: See section 7.6 for additional Expansion Factor information.</p>
	<pre>ENTER: </pre>	
	<pre>FLUID NAME Water</pre>	<p>Enter the fluid name.</p>
	<pre>ENTER: </pre>	
	<p>Advance To SETUP OUTPUTS (Analog)</p>	
<p>6.4.13 SETUP OUTPUTS (Analog Output)</p>	<pre>SETUP OUTPUTS</pre>	<p>Press ENTER to begin Outputs setup.</p>
	<pre>ENTER: </pre>	
	<pre>SETUP OUTPUTS Analog Pulse</pre>	<p>Press ENTER when Analog is flashing to setup the Analog Output.</p>
	<pre>ENTER: </pre>	
	<pre>ANALOG OUTPUT USAGE Level Tot Temp Dens</pre>	<p>Select the desired Analog Output Usage.</p>
	<pre>ENTER: </pre>	
	<pre>LOW SCALE (4mA) ##### in</pre>	<p>Enter the desired Analog Output Low Value. NOTE: Units label will correspond with output usage type selected.</p>
<pre>ENTER: </pre>		
<pre>FULL SCALE (20mA) ##### in</pre>	<p>Enter the desired Analog Output High Value.</p>	
<pre>ENTER: </pre>		
<pre>ANALOG OUT DAMPING 0.0</pre>	<p>Enter the desired Analog Output Damping Constant.</p>	
<pre>ENTER: </pre>		
	<p>Advance To SETUP OUTPUTS (Pulse)</p>	

Sub-menus	Display	Notes
6.4.14 SETUP OUTPUTS (Pulse Output)	<pre> SETUP OUTPUTS Analog Pulse [ENTER] </pre>	Press ENTER when Pulse is flashing to setup the Pulse Output.
	<pre> PULSE OUTPUT USAGE OFF FILL DRAIN BOTH [ENTER] </pre>	Select the desired Pulse Output Usage.
	<pre> PULSE WIDTH 10mS 100mS [ENTER] </pre>	Select the desired Pulse Width for the Pulse Output.
	<pre> PULSE VALUE ##### gal/P [ENTER] </pre>	Enter the desired Pulse Value for the Pulse Output (Units per Pulse).
Advance To SETUP RELAYS		
6.4.15 SETUP RELAYS (Relay 1)	<pre> SETUP RELAYS [ENTER] </pre>	Press ENTER at this prompt to begin the Relays setup.
	LEVEL/TOT MODE	<pre> SETUP RELAYS R1y1 R1y2 R1y3 R1y4 [ENTER] </pre>
	<pre> RELAY 1 USAGE LEVEL TOTAL OFF [ENTER] </pre>	Select Level, Total or Off.
	<pre> RELAY 1 MODE LO_ALARM HI_ALARM [ENTER] </pre>	If Level selected, Select the desired Relay Activation. Low: Relay activates when display is below setpoint. High: Relay activates when display is above setpoint.
	<pre> RELAY 1 DURATION ##### [ENTER] </pre>	If Total Selected, Enter desired Relay Duration (in seconds).
	<pre> RELAY 1 SETPOINT ##### gal [ENTER] </pre>	Enter the desired Setpoint.
	<pre> RELAY 1 HYSTERESIS ##### in [ENTER] </pre>	If Level, Selected, Enter desired Relay Hysteresis.
Advance To SETUP RELAYS 2, 3, 4		

Sub-menus	Display	Notes
6.4.15 (continued) SETUP RELAYS (Relay 1)	<pre> SETUP RELAYS R1y1 R1y2 R1y3 R1y4 </pre>	Select the desired Relay for setup. (Relay 1)
BATCH MODE	<pre> ENTER: RELAY 1 USAGE PRESET ENTER: Advance To SETUP RELAYS 2, 3, 4 </pre>	Relay 1 is reserved for Preset in Batch mode.
6.4.16 SETUP RELAYS (Relay 2)	<pre> SETUP RELAYS ENTER: </pre>	Press ENTER at this prompt to begin the Relays setup.
LEVEL/TOT MODE	<pre> SETUP RELAYS R1y1 R1y2 R1y3 R1y4 ENTER: RELAY 2 USAGE LEVEL TOTAL OFF ENTER: RELAY 2 MODE LO_ALARM HI_ALARM ENTER: </pre>	Select the desired Relay for setup. (Relay 2)
	<pre> RELAY 2 USAGE LEVEL TOTAL OFF </pre>	Select Level, Total or Off.
	<pre> RELAY 2 MODE LO_ALARM HI_ALARM </pre>	<p>If Level selected, Select the desired Relay Activation.</p> <p>Low: Relay activates when display is below setpoint.</p> <p>High: Relay activates when display is above setpoint.</p>
	<pre> RELAY 2 DURATION ##### </pre>	If Total Selected, Enter desired Relay Duration (in seconds).
	<pre> RELAY 2 SETPOINT ##### gal </pre>	Enter the desired Setpoint.
	<pre> RELAY 2 HYSTERESIS ##### in </pre>	If Level, Selected, Enter desired Relay Hysteresis.
	<pre> Advance To SETUP RELAYS 3, 4 </pre>	







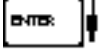
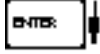
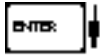
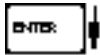
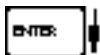
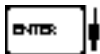

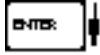
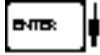
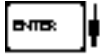



Sub-menus	Display	Notes
6.4.16 (continued) SETUP RELAYS (Relay 2)	<pre> SETUP RELAYS R1Y1 R1Y2 R1Y3 R1Y4 </pre>	Select the desired Relay for setup. (Relay 2)
BATCH MODE	<pre> ENTER RELAY 2 USAGE PRWRN LEV OURUN more </pre>	Select the desired Relay 2 usage.
	<pre> RELAY 2 USAGE TEMP DENS ALARM </pre>	These selections are available when more is selected.
	<pre> ENTER RELAY 2 MODE LO_ALARM HI_ALARM </pre>	If Level, Temp or Dens selected, Select the desired Relay Activation. Low: Relay activates when display is below setpoint. High: Relay activates when display is above setpoint.
	<pre> RELAY 2 SETPOINT ##### gal </pre>	If Level, Temp or Dens Selected, Enter the desired Setpoint.
	<pre> RELAY 2 HYSTERESIS ##### in </pre>	If Level, Temp or Dens Selected, Enter the desired Hysteresis.
	Advance To SETUP RELAYS 3, 4	
6.4.17 SETUP RELAYS (Relay 3 & 4)	<pre> SETUP RELAYS </pre>	Press ENTER at this prompt to begin the Relays setup.
LEVEL/TOT & Batch MODE	<pre> ENTER SETUP RELAYS R1Y1 R1Y2 R1Y3 R1Y4 </pre>	Select the desired Relay for setup. (Relay 3/4)
Setup is the same for Relay 3 & 4.	<pre> ENTER RELAY 3 USAGE LEVEL TOTAL OFF more </pre>	Select Level, Total or Off.
	<pre> RELAY 3 USAGE TEMP DENS ALARM </pre>	These selections are available when more is selected.
	<pre> ENTER RELAY 3 MODE LO_ALARM HI_ALARM </pre>	If Level, Temp or Dens selected, Select the desired Relay Activation. Low: Relay activates when display is below setpoint. High: Relay activates when display is above setpoint.
	<pre> RELAY 3 SETPOINT ##### gal </pre>	If Level, Temp or Dens Selected, Enter the desired Setpoint.
	<pre> ENTER RELAY 3 HYSTERESIS ##### in </pre>	If Level, Temp or Dens Selected, Enter the desired Hysteresis.
	Advance To SETUP CONTROL INPUTS	

Sub-menus	Display	Notes
6.4.18 SETUP CONTROL INPUTS (LEVEL/TOTAL)	<pre> SETUP CONTROL INPUTS ┌───────────────────┐ │ │ │ │ └───────────────────┘ [ENTER] ↓ SETUP CONTROL INPUTS Input1 Input2 Input3 ┌───────────────────┐ │ │ │ │ └───────────────────┘ [ENTER] ↓ CONTROL INPUT1 USAGE PRINT ACK KEYLOCK ┌───────────────────┐ │ │ │ │ └───────────────────┘ CONTROL INPUT2 USAGE PRINT ACK KEYLOCK ┌───────────────────┐ │ │ │ │ └───────────────────┘ CONTROL INPUT3 USAGE PRINT ACK KEYLOCK ┌───────────────────┐ │ │ │ │ └───────────────────┘ [ENTER] ↓ Advance To SETUP REALTIME CLOCK </pre>	<p>Press ENTER to begin the Control Input setup.</p> <p>Select the desired Control Input for setup.</p> <p>Control Inputs 1, 2 & 3 can be set for Print, Ack, or Keylock</p> <p>ACK (acknowledge) will acknowledge and clear alarms and warning messages. Note: Alarms may reassert themselves if alarm conditions are still present.</p> <p>PRINT is used to initiate print. KEYLOCK will lockout menus if held at a voltage greater than 3V.</p>
6.4.19 SETUP CONTROL INPUTS (BATCH)	<pre> SETUP CONTROL INPUTS Input1 Input2 Input3 ┌───────────────────┐ │ │ │ │ └───────────────────┘ [ENTER] ↓ CONTROL INPUT1 USAGE START RESET/START ┌───────────────────┐ │ │ │ │ └───────────────────┘ CONTROL INPUT2 USAGE STOP STOP/RESET ┌───────────────────┐ │ │ │ │ └───────────────────┘ CONTROL INPUT3 USAGE RST PRN KEYLOCK ACK ┌───────────────────┐ │ │ │ │ └───────────────────┘ [ENTER] ↓ Advance To SETUP REALTIME CLOCK </pre>	<p>Select the desired Control Input for setup.</p> <p>If Control Input 1 Selected, Select Start or Reset/Start</p> <p>If Control Input 2 Selected, Select Stop or Stop/Reset.</p> <p>If Control Input 3 Selected, Select Reset, Print, Keylock or Ack (acknowledge).</p>
6.4.20 SETUP REALTIME CLOCK (Time)	<pre> SETUP REALTIME CLOCK Time Date ┌──────────┐ │ Time Date │ └──────────┘ [ENTER] ↓ CLOCK TYPE 24HR 12HR ┌──────────┐ │ │ │ │ └──────────┘ [ENTER] ↓ SELECT CLOCK AM/PM AM PM ┌──────────┐ │ │ │ │ └──────────┘ [ENTER] ↓ TIME OF DAY HH:MM:SS ##:##:## ┌──────────┐ │ │ │ │ └──────────┘ [ENTER] ↓ Advance To SETUP REALTIME CLOCK (Date) </pre>	<p>Select Time to set the time.</p> <p>Select 24Hr or 12Hr clock</p> <p>If 12Hr Clock, Enter AM or PM</p> <p>Enter time of day.</p>

Sub-menus	Display	Notes
6.4.21 SETUP REALTIME CLOCK (Date)	<pre> SETUP REALTIME CLOCK Time Date [ENTER] DATE: MONTH, DAY, YEAR ##/##/#### [ENTER] Advance To SERIAL USAGE </pre>	<p>Select Date to enter the date.</p> <p>Enter the date. (Month, Day, Last two Digits of Year)</p>
6.4.22 SETUP SERIAL OUTPUT	<pre> SETUP SERIAL OUTPUT [ENTER] SERIAL USAGE PRINT ----- TERMINAL [ENTER] DEVICE ID 1 [ENTER] BAUD RATE 300 600 1200 <more> [ENTER] BAUD RATE 2400 4800 9600 19200 [ENTER] PARITY None Odd Even [ENTER] HANDSHAKING None Software Hardware [ENTER] DEVICE LINE FEED <CR> <CR+LF> [ENTER] Advance To SETUP DATA OUTPUT </pre>	<p>Press ENTER to setup serial output.</p> <p>Select the desired Serial Port usage.</p> <p>Enter the desired unit ID number (00-99).</p> <p>Select the desired Baud Rate.</p> <p>(If <more> selected)</p> <p>Select the desired Parity.</p> <p>Set the Handshake (future option).</p> <p>Choose end of line termination. Only choose <CR> if your external device automatically assigns a line feed for every <CR> carriage return.</p>

Sub-menus	Display	Notes
6.4.23 SET PRINT OUTPUT (Configure)	<pre> SETUP PRINT OUTPUT </pre> 	Press ENTER to setup print output.
	<pre> SETUP PRINT OUTPUT Config Select_list </pre> 	Select Config to setup Printer Output.
	<pre> PRINT TIME HH:MM:SS 00:00:00 </pre> 	Enter Print Time, printer will print at this time every day. Enter 00:00:00 to inhibit print time.
	<pre> PRINT INTERVAL 00:00:00 </pre> 	Enter Print Interval, HH:MM:SS Enter 00:00:00 to inhibit print interval..
	<pre> ENABLE PRINT KEY NO YES </pre> 	Select YES to enable Print Key. Select NO to disable Print Key
	<pre> PRINT END OF BATCH NO YES </pre> 	Batch mode only. Select Yes to automatically print at end of batch.
	Advance To SETUP DATA OUTPUT	

6.4.24 SET PRINT OUTPUT (Select_list)	<pre> SETUP PRINT OUTPUT </pre> 	Press ENTER to setup print output.
	<pre> SET PRINT OUTPUT Config Select_list </pre> 	Press enter when Select_list is selected to setup print list.
	<pre> PRINT LIST ITEMS TOTAL YES </pre>	Use Up and Down arrow keys to view list status. Press the Corresponding function key to the items that you wish to add or remove from the list. Items marked with Yes will be added to the list, items marked with No will be removed from the list.
	<pre> PRINT LIST ITEMS LEVEL YES </pre>	
	<pre> PRINT LIST ITEMS PRE 1 YES </pre> 	
	<pre> PRINT LIST ITEMS DataLog size =000325 </pre> 	The Select Print List Information display shows the maximum Datalog size.
Advance To SETUP PASSWORD		

Sub-menus	Display	Notes
6.4.25 SETUP PASSWORDS (Operator)	<pre>SETUP PASSWORDS</pre>	Press ENTER to setup passwords.
		Press enter when Operator is flashing to select Operator Password.
	<pre>SETUP PASSWORDS Operator Supervisor</pre>	
	<pre>OPERATOR PASSWORD *****</pre>	Enter a 4 digit number to define the Operator Password. (Factory Set to 0)
		<pre>OPERATOR ACCESS NONE PRESETS</pre>
Advance To SETUP PASSWORDS (SUPERVISOR)		
6.4.26 SETUP PASSWORDS (Supervisor)	<pre>SETUP PASSWORDS Operator Supervisor</pre>	Press enter when Supervisor is flashing to select Supervisor Password. NOTE: Only supervisor can change the Supervisor Password.
		<pre>SUPERVISOR PASSWORD *****</pre>
		Advance To SETUP NETWORK CARD
6.4.27 SETUP NETWORK CARD	<pre>SETUP NETWORK CARD</pre>	Future Option.
		<pre>SETUP NETWORK CARD Card not installed</pre>
		<pre>PROTOCOL ModbusRTU</pre>
		<pre>DEVICE ID 1</pre>
		<pre>BAUD RATE 300 600 1200 <more></pre>
	<pre>BAUD RATE 2400 4800 9600 19200</pre>	(If <more> selected)
		<pre>PARITY None Odd Even</pre>
		Advance To DO EZ SETUP?
		

7. Principle Of Operation

General Operation

7.1 General Operation

The determination of the level and the amount of material in a tank is a commonly needed industrial measurement. In other applications it is desired to dispense liquid from one container to another. This instrument is intended to satisfy these needs.

A variety of displays, analog outputs, pulse outputs, alarms, and communications ports are provided to suit the various application needs which might be encountered.

Determining the Liquid Quantity for Various Tank Geometries

7.2 Determining the liquid quantity for various Tank Geometries

Various tank geometries are used in industry as containers for liquids. These tank geometries may be classified as vertical cylindrical, horizontal cylindrical, or spherical. Many “calibrated” tanks come with a “strapping chart” which equates the volume in the tank for various liquid level measurements.

This instrument permits the user to either enter his tank shape and dimensions or strapping table. The unit then computes the volume in the tank for the measured liquid level based on mathematical equations solved by the instrument.

Tanks often have a discharge location which is somewhat above the base of the tank so that the tank can never be fully drained. The quantity of fluid below the discharge point is sometimes called a “reserve” amount. The instrument computes both the total amount and the available amount from the discharge location information entered by the user.

Determining Liquid Level

7.3 Determining Liquid Level

A liquid level measurement is required in order to compute the quantity in a tank.

There are a wide variety of liquid level measurement techniques to choose from. Among the most common measurement techniques are:

- a. hydrostatic pressure measurement
- b. ultrasonic level measurement

The equations necessary to compute the liquid level are different for the two techniques. This instrument uses the correct equation for the level sensor type you have chosen. The level calculations also include adjustments for the location of the sensor above the base of the tank.

7.4 Corrections for density in hydrostatic pressure based level measurements

The hydrostatic pressure measured at the base of a tank is a function of the liquid level and the density of the fluid.

The LEVELtrol-II provides for the connection of a compensated input, a temperature or density transmitter, which will enable accurate determination of the liquid level in the tank. Stored fluid properties are used to infer the density from a temperature measurement.

7.5 Computation of Corrected Volume in Tank and Mass in Tank

The mass in the tank can be computed if the volume in the tank and the density are known. This instrument has menu selections which permit the user to compute and view the quantity in the tank in mass units.

Corrected Volume is the equivalent volume the liquid would occupy at some reference condition. This instrument also provides menu selections which permit the user to compute and view the quantity in the tank in corrected volume units. This is often useful in determination of volume in the tank for petroleum quantities when it is desired to know the volume the liquid would occupy at 60 F. (Remember that when the temperature of the material is changing and the actual volume of the material in the tank is changing with that temperature based on the expansion factor for the liquid.).

LEVELtrol II Equations Summary

$$\text{Level_Sensor} = \% \cdot (\text{Level_fs} - \text{Level_zero}) + \text{Level_zero}$$

$$\text{Temperature} = \% \cdot (\text{Tfs} - \text{Tzero}) + \text{Tzero}$$

$$\text{Density} = \% \cdot (\text{Dfs} - \text{Dzero}) + \text{Dzero}$$

$$\text{Density} = \text{Dref} \cdot (1 - c \cdot 10^{-6} \cdot (\text{Tf} - \text{Tref}))^2 \text{ (if inferred by temp \& fluid properties)}$$

$$h = \text{height above sensor} = \text{Level_Sensor} \cdot \text{Volume_Conv_Factor} / \text{Df} \text{ (if hydrostatic)}$$

$$\text{Tank_Level} = h + \text{Sensor_Offset}$$

$$\text{Volume_Total} = \text{Volume}(\text{Tank_Level}, \text{Tank_Geometry})$$

$$\text{Avail_Volume} = \text{Volume_Total} - \text{Volume}(\text{Discharge_Pt}, \text{Tank Geometry})$$

$$\text{Mass Total} = \text{Volume Total} \cdot \text{Density}$$

$$\text{Corrected Volume} = \text{Volume Total} \cdot (1 - c \cdot 10^{-6} \cdot (\text{Tf} - \text{Tref}))^2$$

NOTE: Consult factory for applications requiring other fluid equations.

Utility Functions- Volume Equations for Various Tank Geometries

STRAPPING TABLE Case

$$\text{Volume} = \text{Linearize}(\text{level}) \cdot \text{call 32 point table to get volume} \cdot /$$

VERT Case

$$\text{Volume} = \text{level} \cdot \text{PI} \cdot \text{Tank_Diameter}^2 / (4 \cdot \text{Vol_Conv_Factor})$$

HORZ case

$$\begin{aligned} \text{full_volume} &= \text{PI} \cdot \text{D}^2 \cdot \text{Tank_Length} / 4 \\ x &= 1 - (\text{level} \cdot 2) / \text{Tank_Diameter} \\ \text{norm_vol} &= (\arccos x - (x \cdot \text{SQRT}(1 - x^2))) / \text{PI} \\ \text{Volume} &= \text{norm_vol} \cdot \text{full_volume} / \text{Vol_Conv_Factor} \end{aligned}$$

SPH case

$$\text{Volume} = \pi \cdot \text{level}^2 \cdot (\text{Tank_Diameter} / 2 - \text{level} / 6) / \text{Vol_Conv_Factor}$$

The liquid level is related to the measured hydrostatic pressure by the following basic relationship:

$$h = \frac{p \cdot c}{d}$$

h	<in>	<level unit>
p	<lbs>/<in> ²	<mass unit>/<level unit> ²
c	<in> ³ /<gal>	<level unit> ³ /<vol unit>
d	<lbs>/<gal>	<mass unit>/<vol unit>

The basic units of length, volume, and mass are entered by the user as text strings. The user is required to enter the volume conversion constant when prompted.

Example calculation:

Given:

p	4.625	lb/in ²
d	7.42	#/gal
c	231	in ³ /gal

Then:

h	144	in
---	-----	----

7.6 Calculating the Expansion Factor For a Fluid

Calculating Expansion Factor

The liquid density is a function of the flowing temperature for many fluids. This unit solves an equation which represents this physical property of the fluid.

The information which the unit uses to describe the fluid is entered by the user in the following variables: Reference Temperature, Reference Density, Expansion Factor. These parameters can be derived from fluid information available in one or more of the following forms:

- Fluid Specific Gravity vs. Temp. Table
- Specific Gravity vs. Temp. Graph
- Fluid Density vs. Temp. Table
- Fluid Density vs. Temp. Graph

Begin by obtaining one of the fluid properties for the fluid you are using from available manufacturers information or Engineering Handbooks. In some cases this information is listed on the Material Safety Data Sheet for the fluid.

Two temperature-density pairs will be required to compute the temperature coefficient. The reference temperature is simply chosen by the user. Common reference temperatures are 60° F or 15° C.

However, for cryogenic fluids, the normal boiling point may also be used. In some cases the fluid data may list properties at 100° F, this temperature may also be used as the reference temperature.

The reference temperature should be chosen so that it is in the application temperature range. i.e. application temperature range -10 to 120° F, reference temperature of 60° F chosen.

Enter the reference temperature you have chosen at this point.

The reference density corresponds to the fluid density at the reference temperature chosen. Enter this information in the units that are prompted for by the unit.

Expansion Factor Equations

EQ1.

$$\text{Spec.Grav.} = \text{Density of Fluid} / \text{Density of Water}$$

Given the reference temperature, reference specific gravity, a second temp. and a second Spec.Grav., the Expansion Factor (C Factor) can be computed as follows:

EQ2.

$$C = \left[\frac{1 - \sqrt{(\text{Spec.Grav.2} / \text{Ref.Spec.Grav.})}}{\text{Temp.2} - \text{Ref.Temp}} \right] \times 1,000,000$$

Given the reference temperature, reference density, a second temp. and a second density, the Expansion Factor (C Factor) can be computed as follows:

EQ3

$$C = \left[\frac{1 - \sqrt{(\text{Dens. 2} / \text{Ref. Density})}}{\text{Temp.2} - \text{Ref.Temp}} \right] \times 1,000,000$$

See Appendix A for a table of common fluid properties.

8. Test, Service and Maintenance







8.1 Test Menus



Menus	Display	Notes
8.1.1 TOP LEVEL TEST MENUS		Select Test to enter the instrument test & calibration routine. NOTE: Supervisor (Service) password required to gain access to this mode.
		Refer to Page 38 for Details.
		Refer to Page 38 for Details.
		Refer to Page 38 for Details.
		Refer to Page 39 Details.
		Refer to Page 39 for Details.
		Refer to Pages 40 - 44 for Details.
		Refer to Page 44 Details.
		Refer to Page 45 for Details.
		Refer to Page 46 for Details.
		Refer to Page 46 for Details.
		Refer to Page 46 for Details.
		Refer to Page 47 for Details.
		Refer to Page 47 for Details.

WARNING: The status of various outputs can be changed by the utilities here. Make sure no hazards in the process will be created before using these utilities.











8.2 Test Sub-Menus









Sub-menus	Display	Notes
8.2.1 Audit Trail Submenu Group	<div style="border: 1px solid black; padding: 5px; text-align: center;">Audit Trail</div>	Press Enter to view the audit trail information.
	<div style="text-align: center;">  </div> <div style="border: 1px solid black; padding: 5px; text-align: center;"> Audit Trail nnnnn hh:mm:ss mm/dd/yy </div>	The audit trail is viewed in this format: nnnnn= number of critical menu changes, hh:mm:ss; mm/dd/yy = time and date of last change.
	<div style="text-align: center;">  </div> <div style="border: 1px solid black; padding: 5px; text-align: center;">Audit Trail</div>	Press Menu to get back to audit trail top-level menu.
8.2.2 Error History Submenu Group	<div style="border: 1px solid black; padding: 5px; text-align: center;">Error history</div>	Press Enter to view error history.
	<div style="text-align: center;">  </div> <div style="border: 1px solid black; padding: 5px; text-align: center;"> Error history Level alarm low </div>	NOTE: Press Print Key to print Error History.
	<div style="text-align: center;">  </div> <div style="border: 1px solid black; padding: 5px; text-align: center;">Error history</div>	Press Menu to get back to error history top-level menu.
8.2.3 Print System Setup Submenu Group	<div style="border: 1px solid black; padding: 5px; text-align: center;">Print System Setup</div>	Press enter key to enter print system setup submenu
	<div style="text-align: center;">  </div> <div style="border: 1px solid black; padding: 5px; text-align: center;"> Print System Setup Press ENTER to print </div>	Press enter to begin printing the system setup.
	<div style="text-align: center;">  </div> <div style="border: 1px solid black; padding: 5px; text-align: center;"> Print System Setup -- Printing --- </div>	This message will display as the data transmission takes place.
	<div style="text-align: center;">  </div> <div style="border: 1px solid black; padding: 5px; text-align: center;">Print System Setup</div>	Press Menu to get back to print system setup top-level menu.
		Press Enter to enter keypad test





Sub-menus	Display	Notes
8.2.4 Keypad test Submenu Group	<div style="border: 1px solid black; padding: 5px; text-align: center;">Keypad test</div>	Press the various keys and the display will show the key that was pressed. Press Menu to exit the test
	<div style="border: 1px solid black; padding: 5px; text-align: center;">  </div>	
	<div style="border: 1px solid black; padding: 5px; text-align: center;"> Keypad test Key pressed-> ENTER </div>	
8.2.5 Display test Submenu Group	<div style="border: 1px solid black; padding: 5px; text-align: center;">Keypad test</div>	Press Menu to get back to Keypad test top-level menu.
	<div style="border: 1px solid black; padding: 5px; text-align: center;">Keypad test</div>	Press Enter to enter display test.
	<div style="border: 1px solid black; padding: 5px; text-align: center;">  </div>	Upon pressing enter the each digit on the display will scroll 0-9 then A-Z. Press menu to exit the test.
	<div style="border: 1px solid black; padding: 5px; text-align: center;"> 000000000000000000000000 000000000000000000000000 </div>	
<div style="border: 1px solid black; padding: 5px; text-align: center;">  </div>	Press Menu to get back to Display test top-level menu.	
<div style="border: 1px solid black; padding: 5px; text-align: center;">Display test</div>	Press Enter to begin the calibration routine.	

ALL UNITS ARE CALIBRATED AT THE FACTORY PRIOR TO SHIPMENT
CAUTION:
 This unit must be calibrated using precision and calibrated equipment.
 Equipment needed is as follows: Digital Multimeter,
 Precision Current/Voltage Source, Oscilloscope, Frequency Counter.











<u>Sub-menus</u>	<u>Display</u>	<u>Notes</u>
8.2.6 - 8.2.16 Calibration Submenu Group	<div style="border: 1px solid black; padding: 5px; display: inline-block;">Calibrate</div>	(Please note the caution above)
		
8.2.6 Calibrate CH1 0mA Submenu Group	<div style="border: 1px solid black; padding: 5px; display: inline-block;">Calibrate ch1 0mA Iin=TB1-3 GND=TB1-4</div>	Connect Current Source (+) TB1-3, (-) TB1-4. Input 0mA and press Enter.
		
	<div style="border: 1px solid black; padding: 5px; display: inline-block;">Calibrate ch1 0mA 0 CALIBRATING --</div>	This message is displayed during calibration.
	↓	
	<div style="border: 1px solid black; padding: 5px; display: inline-block;">Calibrate ch1 0mA *** DONE ***</div>	This message is displayed when the 0mA calibration is finished.
	↓	
	<div style="border: 1px solid black; padding: 5px; display: inline-block;">Calibrate ch1 0mA Iin=TB1-3 GND=TB1-4</div>	The display will automatically return to the Calibrate CH1 0mA submenu. Press the Down arrow key to advance to the CH1 20mA calibration.
		
8.2.7 Calibrate CH1 20mA Submenu Group	<div style="border: 1px solid black; padding: 5px; display: inline-block;">Calibrate ch1 20mA Iin=TB1-3 GND=TB1-4</div>	Connect Current Source (+) TB1-3, (-) TB1-4. Input 20mA and press Enter.
		
	<div style="border: 1px solid black; padding: 5px; display: inline-block;">Calibrate ch1 20mA 0 CALIBRATING --</div>	This message is displayed during calibration.
	↓	
	<div style="border: 1px solid black; padding: 5px; display: inline-block;">Calibrate ch1 20mA *** DONE ***</div>	This message is displayed when the 20mA calibration is finished.
	↓	
	<div style="border: 1px solid black; padding: 5px; display: inline-block;">Calibrate ch1 20mA Iin=TB1-3 GND=TB1-4</div>	The display will automatically return to the Calibrate CH1 20mA submenu. Press the Down arrow key to advance to the CH2 0mA calibration.
		
	Advance to <div style="border: 1px solid black; padding: 5px; display: inline-block;">Calibrate ch2 0mA</div>	To Calibrate: Connect Current Source (+)







Sub-menus	Display	Notes
8.2.8 Calibrate CH2 0mA Submenu Group	<pre>Calibrate ch2 0mA Iin=TB1-8 GND=TB1-4</pre>	TB1-8, (-) TB1-4. Input 0mA and press Enter.
		This message is displayed during calibration.
	<pre>Calibrate ch2 0mA 0 CALIBRATING --</pre>	This message is displayed when the 0mA calibration is finished.
	<pre>Calibrate ch2 0mA *** DONE ***</pre>	The display will automatically return to the Calibrate CH2 0mA submenu. Press the Down arrow key to advance to the CH2 20mA calibration.
8.2.9 Calibrate CH2 20mA Submenu Group	<pre>Calibrate ch2 0mA Iin=TB1-8 GND=TB1-4</pre>	To Calibrate: Connect Current Source (+)
		TB1-8, (-) TB1-4. Input 20mA and press Enter.
	<pre>Calibrate ch2 20mA Iin=TB1-8 GND=TB1-4</pre>	This message is displayed during calibration.
		This message is displayed when the 20mA calibration is finished.
<pre>Calibrate ch2 20mA 0 CALIBRATING --</pre>	The display will automatically return to the Calibrate CH2 20mA submenu. Press the Down arrow key to advance to the CH1 0V calibration.	
<pre>Calibrate ch2 20mA *** DONE ***</pre>		
<pre>Calibrate ch2 20mA Iin=TB1-8 GND=TB1-4</pre>		
		
<p style="text-align: center;">Advance to Calibrate ch1 0V</p>		





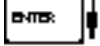
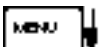



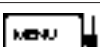

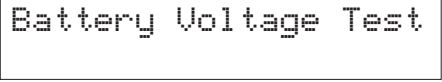
Sub-menus	Display	Notes
8.2.10 Calibrate CH1 0V Submenu Group	<pre>Calibrate ch1 0V Vin=TB1-2 GND=TB1-4</pre>	To Calibrate: Connect Voltage Source (+) TB1-2, (-) TB1-4. Input 0V and press Enter.
		
	<pre>Calibrate ch1 0V 0 CALIBRATING --</pre>	This message is displayed during calibration.
		
	<pre>Calibrate ch1 0V *** DONE ***</pre>	This message is displayed when the 0V calibration is finished.
		
	<pre>Calibrate ch1 0V Iin=TB1-2 GND=TB1-4</pre>	The display will automatically return to the Calibrate CH1 0V submenu. Press the Down arrow key to advance to the CH1 10V calibration.
		
8.2.11 Calibrate CH1 10V Submenu Group	<pre>Calibrate ch1 10V Iin=TB1-2 GND=TB1-4</pre>	To Calibrate: Connect Voltage Source (+) TB1-2, (-) TB1-4. Input 10V and press Enter.
		
	<pre>Calibrate ch1 10V 0 CALIBRATING --</pre>	This message is displayed during calibration.
		
	<pre>Calibrate ch1 10V *** DONE ***</pre>	This message is displayed when the 10V calibration is finished.
		
	<pre>Calibrate ch1 10V Iin=TB1-2 GND=TB1-4</pre>	The display will automatically return to the Calibrate CH1 10V submenu. Press the Down arrow key to advance to the CH2 0V calibration.
		
	<pre>Advance to Calibrate ch2 0V</pre>	

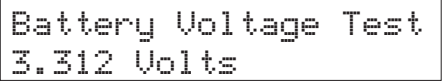
Sub-menus	Display	Notes
8.2.12 Calibrate CH2 0V Submenu Group	Calibrate ch2 0V Vin=TB1-5 GND=TB1-4	To Calibrate: Connect Voltage Source (+) TB1-5, (-) TB1-4. Input 0V and press Enter.
		This message is displayed during calibration.
	Calibrate ch2 0V 0 CALIBRATING --	This message is displayed during calibration.
	Calibrate ch2 0V *** DONE ***	This message is displayed when the 0V calibration is finished.
8.2.13 Calibrate CH2 10V Submenu Group	Calibrate ch2 0V Iin=TB1-5 GND=TB1-4	The display will automatically return to the Calibrate CH2 0V top-level menu. Press the Down arrow key to advance to the CH2 10V calibration.
		To Calibrate: Connect Voltage Source (+) TB1-5, (-) TB1-4. Input 10V and press Enter.
	Calibrate ch2 10V Iin=TB1-5 GND=TB1-4	This message is displayed during calibration.
	Calibrate ch2 10V 0 CALIBRATING --	This message is displayed during calibration.
Calibrate ch2 10V *** DONE ***	This message is displayed when the 10V calibration is finished.	
Calibrate ch2 10V Iin=TB1-5 GND=TB1-4	The display will automatically return to the Calibrate CH2 10V top-level menu. Press the Down arrow key to advance to the 100 ohm RTD calibration.	
	Advance to Calibrate 100ohm RTD	
8.2.14 Calibrate 100 ohm RTD Submenu Group	Calibrate 100ohm RTD JMP TB1-6,7 100R=7,8	To Calibrate: Connect a jumper wire between TB1-6 and TB1-7, Place a 100 ohm 0.1% resistor between TB1-7 and TB1-8. Press enter to calibrate.*
		This message is displayed during calibration.
	Calibrate 100ohm RTD 0 CALIBRATING --	This message is displayed during calibration.
	Calibrate 100ohm RTD *** DONE ***	This message is displayed when the RTD calibration is finished.
Calibrate 100ohm RTD JMP TB1-6,7 100R=7,8	The display will automatically return to the Calibrate 100 ohm RTD top-level menu. Press the Down arrow key to advance to the 4mA out calibration.	
	Advance to Calibrate 4mA out	

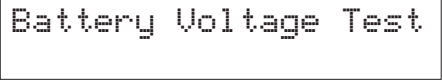
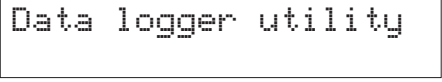
* For highest accuracy, an ice bath and actual RTD can be used in this calibration sequence.

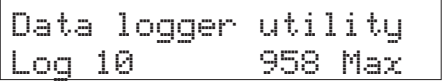
Sub-menus	Display	Notes
8.2.15 Calibrate 4mA Out Submenu Group	<pre>Calibrate 4mA out + TB1-15 - TB1-16</pre>	Connect ammeter to (+) TB1-15, (-) TB1-16. Press enter.
	 <pre>Calibrate 4mA out Enter mA: 4.00000</pre>	To trim 4mA output: Press CLEAR to enable editing and enter the current reading that is on the ammeter display. Press enter.
	 <pre>Calibrate 4mA out + TB1-15 - TB1-16</pre>	The display will automatically return to the Calibrate 4mA out submenu. Press the down arrow key to advance to Calibrate 20mA out.
8.2.16 Calibrate 20mA Out Submenu Group	<pre>Calibrate 20mA out + TB1-15 - TB1-16</pre>	Connect ammeter to (+) TB1-15, (-) TB1-16. Press enter.
	 <pre>Calibrate 20mA out Enter mA: 20.00000</pre>	To trim 20mA output: Press CLEAR to enable editing and enter the current reading that is on the ammeter display. Press enter.
	 <pre>Calibrate 20mA out + TB1-15 - TB1-16</pre>	The display will automatically return to the Calibrate 20mA out submenu. Calibration is complete.
	 <pre>Calibrate</pre>	Press the Menu key to go back to Calibrate top-level menu.
8.2.17 Analog In Test Submenu Group	<pre>Analog In Test</pre>	Press enter to test the analog inputs.
	 <pre>Analog In Test Volts T2:00.000 T5:00.000</pre>	To check voltage input accuracy: Use TB1-4 as Reference Ground, input 0-10 Volts to TB1-2 and/or TB1-5. Display should show voltage being input. Use voltage meter to verify input accuracy.
	  <pre>Analog In Test mA T3:00.000 T8:00.000</pre>	
	  <pre>Analog In Test OHMS RTD 00.000</pre>	To check RTD input accuracy: Connect a jumper wire between TB1-6 and TB1-7, Place a 100 ohm 0.1% resistor between TB1-7 and TB1-8. Display should show 100 ohms ±0.1%.
	 <pre>Analog In Test</pre>	Press Menu key to return to Analog In Test top-level menu.

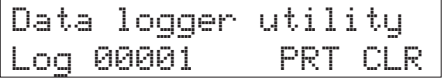
Sub-menus	Display	Notes
8.2.18 Analog out test Submenu Group	Analog out test	Press Enter to test the analog output.
	 Analog out test *4 8 12 16 20 mA	To simulate analog output: Connect an ammeter to (+) TB1-15, (-) TB1-16. Press the key under the desired setting to move the asterisk (*). The unit should output the selected current.
	 Analog out test	Press Menu key to return to Analog out test top-level menu.
8.2.19 Pulse out test Submenu Group	Pulse out test	Press Enter key to test the pulse output.
	 Pulse out test 0Hz 1Hz 10Hz 20Hz	To simulate a frequency on the pulse output: Connect a frequency counter to (+)TB1-13, (-)TB1-14. Press the key under the desired setting to move the asterisk (*). The unit should output the selected frequency as a burst of pulses.
	 Pulse out test	Press Menu key to return to Pulse out test top-level menu.
8.2.20 Relay test Submenu Group	Relay Test	Press Enter to test the relays.
	 R1y1 R1y2 R1y3 R1y4 Off Off Off Off	To manually control the relay outputs: Press the key under the desired relay to toggle the relays On/Off. (Use an ohmmeter to check the relay contacts.)
	 Relay Test	Press Menu key to return to Relay Test top-level menu.
<p>WARNING: The Relay Test will actuate/de-actuate any device or valve connected to the corresponding relay.</p>		
8.2.21 Control input test Submenu Group	Control inputs test	Press Enter to test the control inputs.
	 TB1-9 TB1-10 TB1-11 Off Off Off	To check the control inputs: Use TB1-12 as reference, input a DC signal to TB1-9, TB1-10 and/or TB1-11, The Display will show ON when input is active, OFF when inactive.
	 Control inputs test	Press Menu key to return to control input test top-level menu.

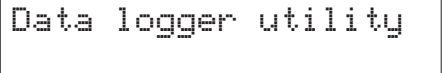
Sub-menus	Display	Notes
8.2.22 Battery Voltage test Submenu Group		Press Enter key to view the battery voltage.
	  	The display will show the battery voltage. Replace battery at 2.2 VDC or below.
		Press Menu key to return to battery voltage test top-level menu.
8.2.23 Data logger utility Submenu Group		Press Enter to use data logger utility.
	  	The displays shows the number of Data Logs. Press the Down arrow key to advance to PRT (print) or CLR (clear).
	 	Press PRINT key to output data logger logs to printer, Press CLEAR key to clear the data logger contents.
		Press Menu key to return to Data logger utility top-level menu.

8.3 Internal Fuse Replacement

Instructions:

1. Make sure you follow proper E.S.D. Precautions. All persons performing this replacement must follow proper grounding procedures.
2. Turn the power to the unit off.
3. Disconnect the two piece connector rear terminal block, leaving all connections in place.
4. Remove the unit from the panel.
5. Remove the four machine screws (see fig. 1) which hold the two sections of the case together.
6. The rear section of the case should detach from the rest of the case. It may be necessary to cut the wiring label along the joint where the two sections connect. With the rear section of the case removed the fuse will be exposed (located near the rear terminal, AC connection).
7. Locate the Fuse F1 (see fig. 2) and unplug the fuse from its socket.
8. Insert the new fuse into the socket. Insure that the pins are fully inserted and straight.
9. Reassemble the case and install the four machine screws which join the two sections of the case.
10. Reinstall the unit into the panel.
11. Reconnect the rear terminal block.
12. Turn the unit back on.

Fuse Specifications:

- 110 VAC Power: 160mA/250V, TD Wickman 19372-030-k or equivalent
- 220 VAC Power: 80mA/250V, TD Wickman 19372-026-k or equivalent
- 12/24 VDC Power: 800mA/250V, TD Wickman 19374-046-k or equivalent

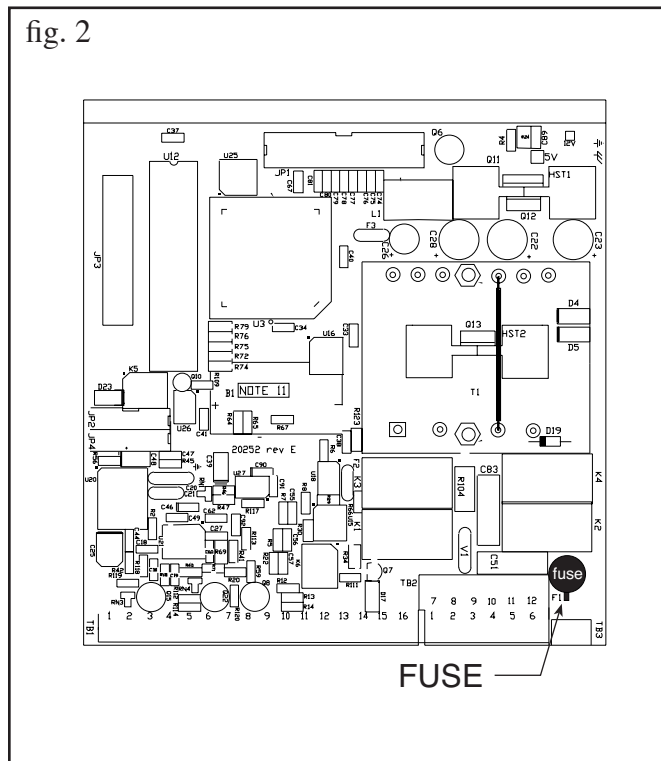
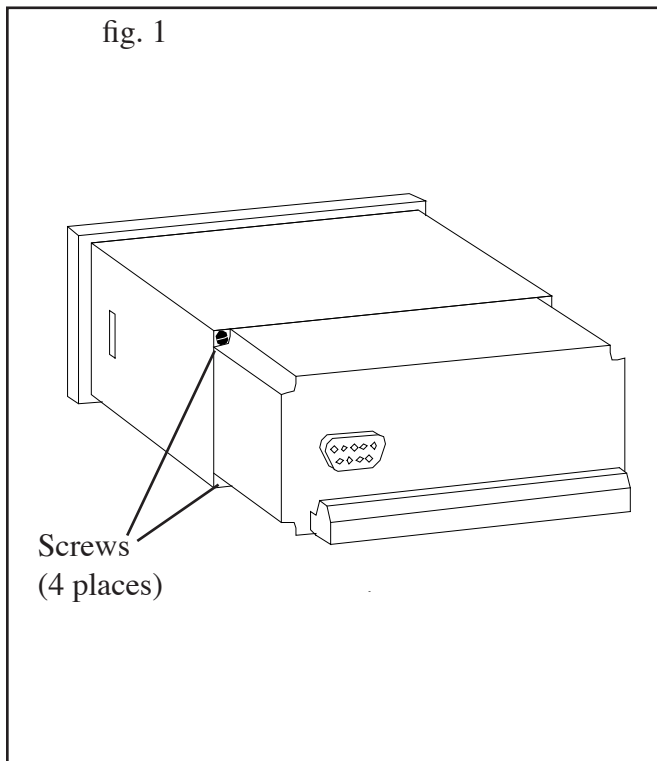

8.4 Installing New Software

Instructions:

The software is now stored in flash memory and can no longer be upgraded in the field. Call factory for a Return Goods Authorization (RGA) number.

9. RS-232 Serial Port

9.1 RS-232 Port Description:

The LEVELtrol-II has a general purpose RS-232 Port which may be used for any one of the following purposes:

- Transaction Printing
- Data Logging to Printer
- Remote Metering by Modem (optional)
- Computer Communication Link
- Configuration by Computer
- Print System Setup
- Print Calibration/Malfunction History

9.2 Instrument Setup by PC's over Serial Port

An optional diskette program is available for the LEVELtrol-II that enables the user to rapidly configure the unit using a Personal Computer. Included on the diskette are common instrument applications which may be used as a starting point for your application. This permits the user to have an excellent starting point and helps speed the user through the instrument setup. The diskette program also permits the user to remotely monitor the operation of the LEVELtrol II.

9.3 Operation of Serial Communication Port with Printers

LEVELtrol-II's RS-232 channel supports a number of operating modes. One of these modes is intended to support operation with a printer in metering applications requiring transaction printing, data logging and/or printing of calibration and maintenance reports.

For transaction printing, the user defines the items to be included in the printed document. The user can also select what initiates the transaction print generated as part of the setup of the instrument. The transaction document may be initiated via a front panel key depression, a remote contact closure, or upon completion of a batch.

In data logging, the user defines the items to be included in each data log as a print list. The user can also select when or how often he wishes a data log to be made. This is done during the setup of the instrument as either a time of day or as a time interval between logging.

The system setup and maintenance report list all the instrument setup parameters and usage for the current instrument configuration. In addition, the Audit trail information is presented as well as a status report listing any observed malfunctions which have not been corrected.

The user initiates the printing of this report at a designated point in the menu by pressing the print key on the front panel.

9.4 LEVELtrol-II RS-232 Port Pinout

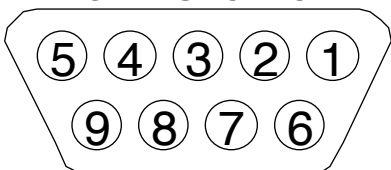

- 1 Handshake Line
- 2 Transmit
- 3 Receive
- 4 Do Not Use
- 5 Ground
- 6 Do Not Use
- 7 Do Not Use
- 8 Do Not Use
- 9 Do Not Use

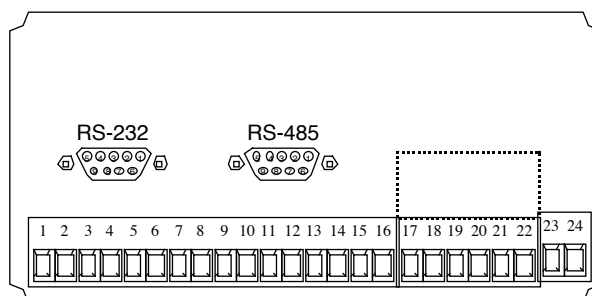

10. RS-485 Serial Port (optional)

10.1 RS-485 Port Description:

The LEVELtrol-II has a an optional general purpose RS-485 Port which may be used for any one of the following purposes:

Accessing Process Parameters

Level, Temperatures, Pressures, Density, Time & Date, Setpoints, etc.

Accessing System Alarms

System, Process, Alarm Status

Accessing Totalizers

Mass, Corrected Volume, Volume Totalizers and Grand Totalizers

Executing Various Action Routines

Reset Alarms, Print Transaction, Reset Error History, Batch ??????

10.2 General

The optional RS-485 card utilizes Modbus RTU protocol to access a variety of process parameters and totalizers. In addition, action routines can be executed. For further information, see Appendix C.

10.3 Operation of Serial Communication Port with PC

LEVELtrol-II's RS-485 channel supports a number of Modbus RTU commands. Refer to port pinout (below) for wiring details. Modbus RTU drivers are available from third party sources for a variety of Man Machine Interface software for IBM compatible PC's.

The user reads and writes information from/to the RS-485 using the Modbus RTU commands. The LEVELtrol II then responds to these information and command requests.

Process variables and totalizers are read in register pairs in floating point format. Time and date are read as a series of integer register values. Alarms are individually read as coils. Action routines are initiated by writing to coils.

10.4 LEVELtrol-II RS-485 Port Pinout

LEVELtrol-II RS-485 Port Pinout (recommended mating connector: DB-9M)

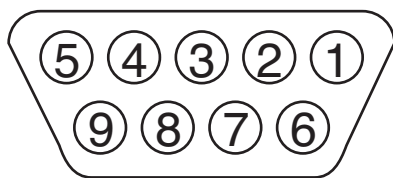

- 1 Ground
- 2 Ground
- 3 Ground
- 4 TX/RX (+)
- 5 TX/RX (-)
- 6 Do Not Use
- 7 Terminating Resistor (180 Ω)
- 8 TX/RX (+) (spare internally connected to 4)
- 9 TX/RX (-) (spare internally connected to 5)

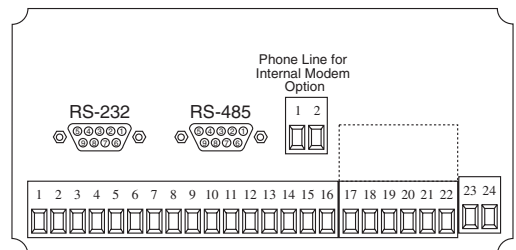

LEVELtrol-II RS-485 Port Pinout (Terminal Block Option)

- 1 Common
- 2 TX/RX (+)
- 3 TX/RX (-)
- 4 Terminating Resistor (180Ω)

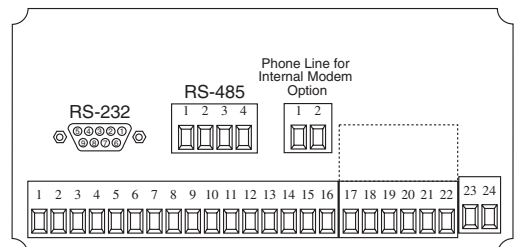

11. Instrument Setup Software (optional)

The LEVELtrol-II setup program provides for configuring, monitoring and controlling a LEVELtrol-II unit.

Sample applications are stored in disk files. The setup program calls these *Templates*. You can store the setup from the program's memory to either the LEVELtrol-II (*Downloading* the file) or to a disk file (*Saving* the file) for later usage. Similarly you can load the setup in program memory from either a disk file (*Opening* a file) or from the LEVELtrol-II unit (*Uploading* a file).

The program can monitor outputs from the unit while it is running.

The program can reset alarms.

For assistance there are mini-helps at the bottom of each screen in the program. There is also context sensitive help available for each screen accessible by pressing the F1 key.

11.1 System Requirements:

IBM PC or compatible with 386 or higher class microprocessor

4 MB RAM

3 MB free disk space

VGA or higher color monitor at 640 x 480

Microsoft® Windows 95™ up through Vista 32

Communication Port - RS-232

RS-232 Cable

11.2 Cable and Wiring Requirements:

The serial communication port on your PC is either a 25 pin or 9 pin connector. No cabling is supplied with the setup software. A cable must be purchased separately or made by the user. It is recommended to purchase a modem cable which matches the available communication port on you PC and a 9 pin male connection for the LEVELtrol-II serial port.

11.3 Installation for Windows 95™ or higher

The Setup Software includes an installation program which installs the software to your hard drive. The setup software may be supplied on a CD or downloaded from the KEP website.

Insert Setup CD in CD drive.

NOTE: For Windows 95™ Click the Start button, select Run and proceed as follows:

Type the floppy drive letter followed by a colon (:), and a backslash (\), and the word setup. For Example:

a:\setup

Follow the instructions on your screen.

In most cases the program will perform an auto-install once the CD is inserted in the drive. Note that the program needs to be run as an administrator on some Windows operating systems.

11.4 Using the Setup Software

The setup software window consists of several menu “Tabs”. Each tab is organized into groups containing various configuration and/or monitoring functions. To view the tab windows, simply click on the tab. The previous tab window will be hidden as the new tab window is brought to the foreground.

11.5 File Tab

The File Tab has three sections. Any of the options on this tab can also be accessed from the File submenu.

The **Template Section** provides for opening and saving templates. The *Save* and *Save As* buttons provide the standard Windows functionality for dealing with files. The *Load* button is used to open existing templates.

The *Open*, option allows for creating custom templates using the existing template in memory as the starting point. Assign a new name for this template. The template will be saved under this new name.

A typical scenario using the setup program would be the following:

- Open up a predefined template from the supplied list
- Choose ‘Save As’ to save this to a new file name
- Proceed to customize the template by making any changes that are needed
- Save the template to disk (if you want to reuse this template)
- Download the template to an attached unit.

The **Communications Section** allows the user to upload the setup information from the unit or download the program’s current template to the unit.

The **Print (report) Section** allows the user to:

1. Configure the current Windows printer through the Select Printer option.
2. Print a Maintenance Report through the PC's printer using the Print Maintenance option.
3. Print the current setup information through the PC's printer using Print Setup option.

11.6 Setup Tab

The Setup tab is where the majority of the LEVELtrol-II instrument setup modifications are done. The Setup tab is divided into five sections.

System Section: Instrument Type, Tank Geometry, Display, Indicators

Input Section: Level, Fluid, Compensation Input, Control Inputs

Output Section: Pulse, Current

Relay Section: Relays

Other Settings Section: Administration, Communication, Printing

NOTE: Many setup items are enabled or disabled depending on previous setup selections. It is important to work your way through the above list in the order shown. Be sure to verify your selections when you are through programming to insure that no settings were changed automatically.

11.7 View Tab

The View Tab screen allows for viewing selected group items on the PC in a similar format as shown on the unit display. Data from the following groups can be viewed in the List of Values section:

Process Parameters (i.e. level, temperature)

Totalizers (i.e. total, grand total)

The setup software assumes the current setup has been uploaded from the instrument into the PC. It is important that the setup program and the LEVELtrol-II unit are using the same setup information at all times or the information requests will be inconsistent. It is best to upload or download the setup before using this feature.

To start the viewer, first check the boxes of items to view and then click the start button. The data will appear in the appropriate sections and will be continuously updated. The refresh rate is dependent on the number of items that are being viewed and the baud rate of the connection. Data in the List of Values section can be collapsed by clicking on the 'minus' sign in front of the group title. The data can be expanded by clicking on the 'plus' sign in front of the group title. If a group is collapsed and data in the group changes on refresh, the group will automatically expand. Changing the view items requires stopping the current viewing, checking the new selections and then restarting the viewer.

If communication errors occur while reading data from the LEVELtrol-II device, the word 'Error' will appear in place of the actual value. If the connection to the LEVELtrol-II is lost, the viewer will time out with a message saying the device is not responding.

The viewer will attempt to communicate with the LEVELtrol-II device matching the device ID set in the communications screen. If you are having trouble establishing communication, compare settings for the PC and the instrument. Also verify the connections between the PC and instrument.

11.8 Misc. Tab

This tab has three sections: Tools, Actions and Options.

The tools section contains various system administration activities such as creating/modifying the initial sign-on screen or calibration, service test etc.

Create Sign-on, Create Print Header

The Actions section is used to send commands to the LEVELtrol-II.

Reset Alarms

The Options section has the following selections:

Tank Strapping Table, PC Communication

Additional capabilities may be provided in the future.

NOTE: Future options appear as disabled buttons on the screen.

12. Glossary Of Terms

Acknowledge & Clear Alarms

Acknowledge is used to clear alarm relays and remove any visual alarm messages from the display. In the run mode, press the ENTER key or activate CONTROL INPUT 1, 2 or 3 (if set for ACK) to momentarily clear alarms and alarm messages. Alarms will reassert themselves if alarm conditions are still present.

Alarm

A visual indication that the process is above or below the setpoint specified by the user.

Analog Output

The analog signal (4-20mA) that is generated by the LEVELtrol-II. It can correspond to the Level, Total, Temperature or Density. This output is used primarily for transmission of process information to remote systems.

Analog Output Damping

A damping factor for an averaging filter for the analog output. (see also Level Averaging Filter)

Audit Trail

The audit trail is used to track the number of changes made to the units setup program.

Averaging Constant

A dampening factor applied to the level sensor signal.

Batch Count Mode

Batch Count Mode specifies the user preference for count direction. The "Up" selection begins with a value of "0" and counts up until the batch size is reached. The "Down" selection begins with a value equal to the desired batch size and counts down to "0".

Batch Direction

Batch Direction specifies whether the user will be batching into or out of the tank.

Batch Overrun

The LEVELtrol-II offers a batch overrun compensation routine. If batch overrun occurs due to slow valve response time, the unit will compensate for the overrun amount on the next batch. This feature can be disabled if desired.

Batcher

An instrument which controls the dispensing of desired batch amounts. The liquid level based batching system is usually comprised of a batch controller (batcher), level transmitter and control valve. The batcher opens and closes the valve through the use of relays and measures the amounts of liquid being dispensed via the level measurement.

Baud Rate

The speed of serial communication transmissions, expressed in bits per second.

Calibration

A sequence of steps whereby the LEVELtrol II learns the zero and full scale value of various signals on it's inputs.

C-Factor (Fluid Expansion Factor)

A parameter in a flow equation which is used to describe the relationship between density or volume and temperature changes.

C-Factor (Fluid Expansion Factor)

A parameter in a flow equation which is used to describe the relationship between density or volume and temperature changes.

Compensation Equation

An equation which computes the tank contents as a volume, mass or corrected volume using a measured temperature and stored fluid properties.

12. Glossary Of Terms (Continued)

Custody Transfer

Weights and Measure metering codes often specify several requirements for instruments and mechanisms to prevent and track changes in the setup of an instrument which may be used in the commercial sale of goods. The LEVELtrol-II tracks changes via the Audit Trail.

Data Logger

The capturing of information for later use and the mechanism for specifying the conditions where a capture should be made.

DC Output / Excitation Voltage

An on-board DC power supply used to power peripheral sensors. The LEVELtrol-II offers an excitation voltage of 24VDC when powered by AC voltage.

Dec Places

The number of digits to the right of the decimal point.

Default Value

The value to be used by the instrument if a sensor failure or out of range signal is detected.

Descriptor

A label assigned to describe a measurement.

Device ID

A numeric identifier for a particular LEVELtrol II's serial communication port.

Discharge Location

The distance between the discharge location and the bottom of the tank.

Error History

An automatic recording of the individual errors which have occurred in the instrument.

Expansion Factor

See C-Factor

EZ Setup

A utility that provides for rapid configuration of an instrument. The LEVELtrol-II EZ Setup provides the following:

- 1) Prompts the user for only critical information.
- 2) Automatically sets specifications to common uses.

After following the EZ Setup procedure, the unit will be operational to perform the basic measurement. The setup can be further customized using the setup menus.

Fluid Name

Text used to describe the type of fluid as a name.

Follow, Alarm

Alarm relays which are non latching and whose output state is based solely on the comparison of the current process value and the alarm setpoint (trip point).

Function Key (Direct Access Key)

A key on a push-button panel or keyboard (whose function is described by the key label) used to perform an instrument function or special routine.

Handshake

A means of controlling the information flow between two pieces of equipment to prevent the sending device from transmitting information at a rate faster than what can be accepted by the receiver.

High Scale

The engineering value at a full scale signal.

12. Glossary Of Terms (Continued)

Hysteresis

The relay hysteresis is a "dead band" setting which allows the relay to remain energized for a given amount below the setpoint. This is used to prevent relay chatter when the process value is near the setpoint value.

Example: If the relay is assigned to temperature and the Preset is set at 100, and the hysteresis is set at 10, the relay will energize when the temperature reaches 100, the relay will remain energized until the reading falls below 90.

Instrument Type

A description of the basic instrument function. (i.e. Level/Total or Batcher)

Key Lock

A hard wire jumper which blocks access to the instrument setup and test mode.

LCD

Abbreviation for: Liquid Crystal Display

Level Sensor Type

The basic measurement principle for the level sensor.

Limit Setpoint

An alarm trip point setting which specifies the value or magnitude of a process parameter necessary to activate an alarm indicator or control relay.

Low Scale

The engineering value at a zero (low end) signal.

Mass Total

Mass Total is inferred by the volumetric total and density (or implied density) of a fluid.

Network Card

An optional RS-485 communication port for the LEVELtrol II.

Operator Access

The permissions given to users without password prompts.

Operator Password

An operator password code which authorizes changes to the setup of the instrument but blocks access to the Service/Calibration/Test mode.

Parity

A method for detecting errors in transmissions of serial communications data.

Preset

A set point used to trigger the relay outputs of the LEVELtrol-II.

Print Interval

The print interval allows the LEVELtrol-II to transmit information to the serial port at selectable time intervals.

Print Time

The time of day at which the LEVELtrol II will transmit information to the serial port.

Process Parameters

Any sensor information which has been scaled to engineering units including Level, Temperature and Density.

Protocol

A description of the exchange of information by a serial stream of data over the RS link(s).

12. Glossary Of Terms (Continued)

Pulse Output

The pulse output of the LEVELtrol-II is available for remote accumulation of the delivery totals or batch totals into or out of the tank. The output can be scaled using the Pulse Output Scaling Constant.

Level Averaging Filter

The level averaging filter is used to stabilize fluctuating level displays. Higher settings provide more averaging for a more stable display. Derived from the equation:

$$\frac{(\text{OLD DATA} \times \text{"Avg. Filter"} + \text{NEW DATA})}{(\text{"Avg. Filter"} + 1)}$$

Ref. Dens.

Abbreviation for Reference Density. This is the fluid density at reference temperature.

Ref. Temp.

Abbreviation for Reference Temperature. This represents the base or reference condition to which corrected total will be computed.

Reset/Start Control Input

In a batching system, a single operator activation of the START key or Control Input 1 will reset the total then start the batch process.

Sensor Location

The distance above the base of the tank at which the sensor is installed.

Stop/Reset Control Input

In a batching system, a single operator activation of the STOP key or Control Input 2 will stop the batch process then reset the total.

Strapping Table

The LEVELtrol-II uses a Strapping Table which is made up of level/volume values and makes interpolations of the table to arrive at a volume total amount from a level measurement.

Supervisor Password

The password of the individual user responsible for installation and troubleshooting of the instrument.

Tank Diameter

The length of the tank.

Tank Length

The diameter of the tank.

Tank Style

The basic shape of the tank.

Unit Label

The text characters which are used to describe the units of volume, mass, temperature and length.

Usage

A user's selection which assigns a feature to one of a number of optional selections offered.

VFD

Abbreviation for Vacuum Fluorescent Display

Volume Correction Factor

A conversion constant from one volume unit to another.

Volume Total

The measurement of volume of liquid in a container.

13. Diagnosis and Troubleshooting

13.1 Response of LEVELtrol-II on Error or Alarm:

Error and warning indications which occur during operation are indicated in the RUN mode alternately with the measured values. The instrument has three types of error:

TYPE OF ERROR	DESCRIPTION
Sensor/Process Alarms	Errors detected due to sensor failure or process alarm conditions
Self Test Errors	Errors detected during self test.
System Alarms	Errors detected due to system failure

Some alarms are self clearing. Other alarms require the user to acknowledge and clear the alarm. Press the ENTER button to acknowledged and clear alarms. Alarms may reassert themselves if the alarm condition is still present.

NOTE: A historical error alarm log is viewable in the "Test Mode".

The following descriptions suggest possible causes and corrective actions for each alarm message.

13.2 Diagnosis Flow Chart and Troubleshooting

All instruments undergo various stages of quality control during production. The last of these stages is a complete calibration carried out on state-of-the-art calibration rigs.

A summary of possible causes is given below to help you identify faults.

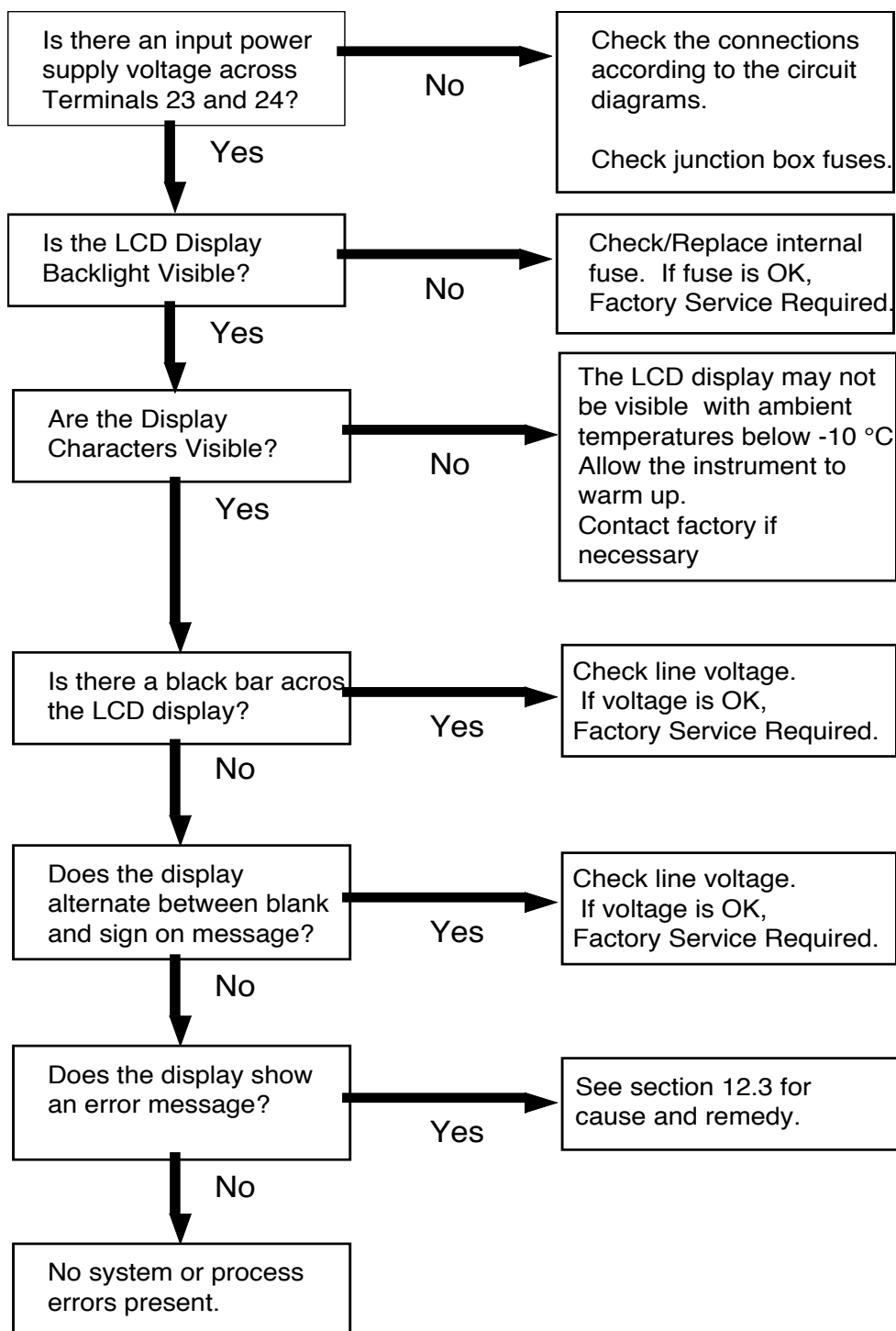

NOTE: The 24 VDC output on terminal 1 is equipped with a thermal self resetting fuse. The fuse will open if a short circuit occurs or if more than 100 mA is drawn from terminal 1. To reset fuse: turn power off for two minutes or disconnect wire from terminal 1 for two minutes.

13.3 Error & Warning Messages:

**13.3.1
Sensor/Process Alarms**

Error/Warning Message	Cause	Remedy
COMP INPUT TOO LOW	4-20 mA Input current at comp input smaller than 3.5 mA: <ul style="list-style-type: none"> • Faulty Wiring • Transmitter not set to "4-20 mA" • Transmitter defective 	<ul style="list-style-type: none"> • Check wiring • Check function of sensor
RTD OUT OF RANGE	Input current at RTD input too low: <ul style="list-style-type: none"> • Faulty wiring • RTD defective 	<ul style="list-style-type: none"> • Check wiring • Check function of RTD sensor
PULSE OUT OVERFLOW	Calculated pulse frequency too large: <ul style="list-style-type: none"> • Pulse width setting too long • Larger pulse scaler needed 	<ul style="list-style-type: none"> • Adjust pulse value • Adjust pulse width • Check process conditions
LEVEL INPUT TOO HIGH	Current input signal of the level input exceeds 20.5 mA: <ul style="list-style-type: none"> • Sensor overranged • Incorrect full scale setting of level sensor • Function error in transmitter or faulty wiring 	<ul style="list-style-type: none"> • Check the full scale setting of the transmitter • Check the application conditions • Check wiring
COMP INPUT TOO HIGH	Current input signal of the compensation input exceeds 20.5 mA: <ul style="list-style-type: none"> • Sensor overranged • Incorrect full scale setting of transmitter • Function error in transmitter or faulty wiring 	<ul style="list-style-type: none"> • Check the full scale setting of the transmitter • Check the application conditions • Check wiring
LEVEL INPUT TOO LOW	Current input signal of the level input is smaller than 3.5 mA: <ul style="list-style-type: none"> • Level sensor not set to 4-20 mA • Function error in transmitter or faulty wiring 	<ul style="list-style-type: none"> • Check wiring • Check calibration of transmitter • Check function of transmitter

13.3 Error & Warning Messages: (Continued)

**13.3.2
Self Test Alarms**

Error/Warning Message	Cause	Remedy
BATTERY LOW WARNING	Battery voltage too low	<ul style="list-style-type: none"> • Replace Battery • Consult Factory for service information
A to D NOT CONVERTING	Fault in analog/digital converter	<ul style="list-style-type: none"> • Unit may self correct, Press ENTER to acknowledge & clear alarm • If error reasserts, factory service is required
TIME CLOCK ERROR	The correct time/date is no longer shown	<ul style="list-style-type: none"> • Re-enter time and date. • If error occurs again contact factory

Appendix A

Fluid Properties Table

LIQUID

FLUID	REF. DENSITY (lb./gal)	REF. TEMP. (°F)	COEFF. OF EXPANSION (e-6 format)
AIR	7.2947	-317.8	1626.2
AMMONIA	5.6996	-28.2	570.4
ARGON	11.6172	-302.6	1486.1
CO2	8.735	-10.0	1260.9
METHANE	3.5404	-258.7	1052.3
NATURAL GAS	3.5404	-258.7	1052.3
NITROGEN	6.7438	-320.4	1491.7
OXYGEN	9.5208	-297.4	1345.8
PROPANE	4.2344	60	717.8
Nx-19	3.5404	-258.7	1052.3
GASOLINE	6.2572	60	370.3
KEROSENE	6.9243	60	268.1
No. 2 FUEL	7.8843	60	88.5
WATER	8.3389	60	101.5

APPENDIX B

SETUP MENUS

- START HERE**
- SELECT EZ SETUP**
- INSTRUMENT TYPE**
- SETUP INDICATORS**
- SETUP TANK STYLE**
- SETUP PROCESS INPUT**
- SET FLUID PROPERTIES**
- SETUP OUTPUTS**
- SETUP RELAYS**
- SETUP CONTROL INPUTS**
- SETUP REAL TIME CLOCK**
- SETUP SERIAL OUTPUT**
- SETUP DATALOG/PRINT**
- SETUP PASSWORD**
- SETUP NETWORK CARD**

INSTRUMENT TYPE	BATCH OFFSET MODE	BATCH DIRECTION	BATCH OVER/RUN COMP.	SELECT FLOW EDUCATION								
SETUP INDICATORS	TOTAL DESCRIPTOR	VOLUME UNITS	TOTAL DECIMAL PLACES	DENSITY DESCRIPTOR	MASS UNITS	DENSITY DECIMAL PLACES	LEVEL UNIT	LEVEL DESCRIPTOR	LEVEL DECIMAL PLACES	TEMP DESCRIPTOR	TEMPERATURE SCALE	TEMPERATURE DECIMAL PLACES
TANK SHAPE	STRAPPING TABLE LEV & VOL	VOLUME CONVERSION FACTOR	TANK DIAMETER	TANK LENGTH	SENSOR LOCATION	DISCHARGE LOCATION						
LEVEL	LEVEL SENSOR TYPE	LEVEL SIG. RESPONSE	LEVEL INPUT SIGNAL	VOLTAGE/CURRENT RANGE	LEVEL LOW SCALE	LEVEL FULL SCALE	AVERAGING CONSTANT					
COMPEN/INPUT	COMP INPUT TYPE	COMP SIGNAL TYPE	VOLTAGE/CURRENT RANGE	COMP LOW SCALE	COMP FULL SCALE	COMP DEFAULT						
REF DENSITY	REF. TEMPERATURE	EXPANSION FACTOR	FLUID NAME									
SETUP PULSE OUTPUT	PULSE OUTPUT USAGE	PULSE WIDTH	PULSE VALUE									
SETUP ANALOG OUTPUT	ANALOG OUTPUT USAGE	ANALOG OUT LOW SCALE	ANALOG OUT FULL SCALE	ANALOG OUT DAMPING								
SETUP RELAYS	RELAY USAGE	RELAY MODE	RELAY SETPOINT	RELAY HYSTERESIS								
SETUP CONTROL INPUTS	CONTROL INPUT 1 USAGE	CONTROL INPUT 2 USAGE	CONTROL INPUT 3 USAGE									
SETUP REAL TIME CLOCK	CLOCK TYPE	SELECT CLOCK/AMPM	TIME OF DAY	ENTER DATE								
SETUP SERIAL OUTPUT	SERIAL USAGE	DEVICE ID	BAUD RATE	PARITY	HANDSHAKE	DEVICE LINE FEED						
SETUP DATALOG/PRINT	PRINT TIME	PRINT INTERVAL	ENABLE PRINT KEY	PRINT END OF BATCH	PRINT LIST ITEMS							
SETUP PASSWORD	OPERATOR PASSWORD	OPERATOR ACCESS	SUPERVISOR PASSWORD									
SETUP NETWORK CARD	SELECT NETWORK PROTOCOL	NETWORK DEVICE ID	BAUD RATE	PARITY								

These functions will only appear with appropriate settings in other functions.

Appendix C - RS485 Modbus RTU Protocol

Introducing LEVELtrol-II with RS-485 & Modbus RTU Protocol

When the LEVELtrol-II is equipped with the RS-485 communication option, the protocol it uses is the Modbus RTU protocol. This protocol defines a message structure that hosts and clients will recognize and use on the RS-485 network over which they communicate. It describes the process a master device (PC compatible) uses to request access to another device (LEVELtrol-II), how it will respond to requests from the other devices, and how errors will be detected and reported. It establishes a common format for the layout and contents of message fields.

During communications on a Modbus RTU network, the protocol determines how each LEVELtrol-II will know its device address, recognize a message addressed to it, determine the kind of action to be taken, and extract any data or other information contained in the message. If a reply is required, the LEVELtrol-II will construct the reply message and send it using Modbus RTU protocol.

RTU Mode

The LEVELtrol-II with RS-485 communications option supports the Modbus RTU (Remote Terminal Unit) mode only. The Modbus ASCII mode is not supported. The main advantage of the RTU mode is that its greater character density allows better data throughput than ASCII for the same baud rate. The Modbus RTU uses a Master-Slave Query-Response Cycle in which the LEVELtrol-II is the slave device.

Control Functions

The LEVELtrol-II with RS-485 communications option supports the following function codes:

CODE	NAME	DESCRIPTION
01	Read Coil Status	Read a single coil
03	Read Holding Register	Read a range of holding registers
05	Force Single Coil	Forces a single coil (0x reference) to either ON or OFF
06	Preset Single Register	Presets a value into a single holding register (4x reference)
15	Force Multiple Coil	Forces each coil (0x reference) in a sequence of coils to either ON or OFF
16	Preset Multiple Registers	Presets values into a sequence of holding registers (4x reference)

Appendix C - RS485 Modbus RTU Protocol

LEVELtrol-II RS-485 Port Pinout (recommended mating connector: DB-9M)

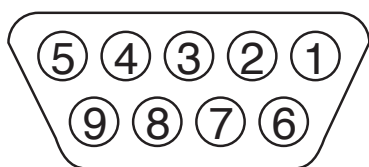

- 1 Ground
- 2 Ground
- 3 Ground
- 4 TX/RX (+)
- 5 TX/RX (-)
- 6 Do Not Use
- 7 Terminating Resistor (180 Ω)
- 8 TX/RX (+) (spare internally connected to 4)
- 9 TX/RX (-) (spare internally connected to 5)

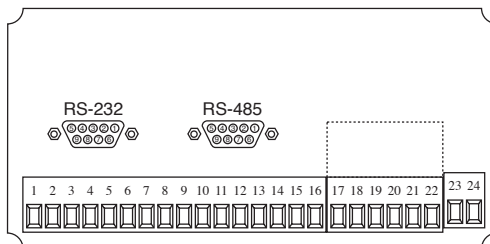

LEVELtrol-II RS-485 Port Pinout (Terminal Block Option)

- 1 Common
- 2 TX/RX (+)
- 3 TX/RX (-)
- 4 Terminating Resistor (180Ω)

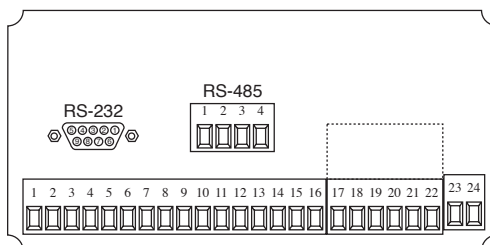

Installation Overview

A two wire RS-485 may be multidropped up to 4000 ft. and up to 32 units may be chained together. A RS-485 to RS-232 interface adaptor is required at the PC. An optically isolated type is recommended. Suitable wiring should be selected based on anticipated electrical interference. Terminators should be used to help improve the quality of electronic signals sent over the RS-485 wires. The RS-485 chain should be terminated at the beginning (RS-485 adaptor) and at the last device in the RS-485 chain and nowhere else. On the LEVELtrol-II this is accomplished by connecting a jumper from terminal 7 to terminal 4 or 8 at the RS-485 port when DB-9 connector is used. Place jumper between terminals 2 and 4 when the terminal block option is used. If lightning protection is required, a suitable surge protector should be used.

For additional information, refer to the technical requirements of EIA-485, interface adaptor user manual and the communication software user manual

LEVELtrol-II Communication Setup Menu

The setup menu allows Modbus RTU Protocol communications parameters of: Device ID, Baud Rate, and Parity to be selected to match the parameters of your RS-485 network. Each LEVELtrol-II must have it's own Device ID and the same Baud Rate and Parity setting.

Appendix C - RS485 Modbus RTU Protocol

Register & Coil Usage

Register Usage (each register is 2 bytes)

LEVELtrol-II Data	Register	Data Type	Access
Level	Reg 40001 & 40002	Float	Read
Unused	Reg 40003 & 40004	–	–
Total	Reg 40005 & 40006	Float	Read
Grand Total	Reg 40007 & 40008	Float	Read
Temperature	Reg 40009 & 40010	Float	Read
Density	Reg 40011 & 40012	Float	Read
Preset 1	Reg 40013 & 40014	Float	Read/Write
Preset 2	Reg 40015 & 40016	Float	Read/Write
Preset 3	Reg 40017 & 40018	Float	Read/Write
Preset 4	Reg 40019 & 40020	Float	Read/Write
Year	Reg 40021	Integer	Read
Month	Reg 40022	Integer	Read
Day	Reg 40023	Integer	Read
Hours	Reg 40024	Integer	Read
Minutes	Reg 40025	Integer	Read
Seconds	Reg 40026	Integer	Read
Unused	Reg 40027 & 40028	–	–
Transaction Number	Reg 40029	Integer	Read
Unused	Reg 40030	–	–
Unused	Reg 40031 & 40032	–	–
Unused	Reg 40033 & 40034	–	–
Unused	Reg 40035 & 40036	–	–
Unused	Reg 40037 & 40038	–	–
Unused	Reg 40039 & 40040	–	–
Unused	Reg 40041 & 40042	–	–
Unused	Reg 40043 & 40044	–	–
Unused	Reg 40045	–	–
Unused	Reg 40046	–	–
Unused	Reg 40047 & 40048	–	–
Unused	Reg 40049 & 40050	–	–
Unused	Reg 40051 & 40052	–	–
Unused	Reg 40053 & 40054	–	–
Unused	Reg 40055 & 40056	–	–
Unused	Reg 40057 & 40058	–	–
Unused	Reg 40059 & 40060	–	–
Unused	Reg 40061 & 40062	–	–
Unused	Reg 40063 & 40064	–	–

NOTE: The Float data type follows the IEEE format for a 32 bit float.

COIL USAGE (each coil is 1 bit)

LEVELtrol-II Data	Coil	Data Type	Access
Error-Pulse Out Overflow	Coil 00001	bit	Read
Unused	Coil 00002	–	–
Unused	Coil 00003	–	–
Unused	Coil 00004	–	–
Unused	Coil 00005	–	–
Unused	Coil 00006	–	–
Unused	Coil 00007	–	–
Unused	Coil 00008	–	–
Unused	Coil 00009	–	–
Unused	Coil 00010	–	–
Unused	Coil 00011	–	–
Unused	Coil 00012	–	–
Unused	Coil 00013	–	–

Appendix C - RS485 Modbus RTU Protocol

Coil Usage (continued)

LEVELtrol-II Data	Coil	Data Type	Access
Unused	Coil 00014	–	–
Unused	Coil 00015	–	–
Unused	Coil 00016	–	–
Unused	Coil 00017	–	–
Unused	Coil 00018	–	–
Unused	Coil 00019	–	–
Unused	Coil 00020	–	–
Unused	Coil 00021	–	–
Unused	Coil 00022	–	–
Error-A to D Not Converting	Coil 00023	bit	Read
Error-Aux Input Too Low	Coil 00024	bit	Read
Error-Aux Input Too High	Coil 00025	bit	Read
Error-Level Input Too Low	Coil 00026	bit	Read
Error-Level Input Too High	Coil 00027	bit	Read
Unused	Coil 00028	–	–
Error-RTD Out Of Range	Coil 00029	bit	Read
Warning-Battery Low Warning	Coil 00030	bit	Read
Unused	Coil 00031	–	–
Unused	Coil 00032	–	–
Unused	Coil 00033	–	–
Command-Reset Errors	Coil 00034	bit	Read/Write
Command-Print Command	Coil 00035	bit	Read/Write
Status-Instrument Type Level/Total or Batch	Coil 00036	bit	Read
Command-Start Batch Command*	Coil 00037	bit	Read/Write
Command-Stop Batch Command*	Coil 00038	bit	Read/Write
Command-Clear Batch Command*	Coil 00039	bit	Read/Write
Status-Batch Filling Status*	Coil 00040	bit	Read
Status-Batch Stopped Status*	Coil 00041	bit	Read
Status-Batch Idle Status*	Coil 00042	bit	Read
Unused	Coil 00043	–	–
Unused	Coil 00044	–	–
Unused	Coil 00045	–	–
Unused	Coil 00046	–	–
Status-Relay 1 Status	Coil 00047	bit	Read
Status-Relay 2 Status	Coil 00048	bit	Read
Status-Relay 3 Status	Coil 00049	bit	Read
Status-Relay 4 Status	Coil 00050	bit	Read
Status-Control 1 Status	Coil 00051	bit	Read
Status-Control 2 Status	Coil 00052	bit	Read
Status-Control 3 Status	Coil 00053	bit	Read
Unused	Coil 00054	–	–
Unused	Coil 00055	–	–
Unused	Coil 00056	–	–
Unused	Coil 00057	–	–
Unused	Coil 00058	–	–
Unused	Coil 00059	–	–
Unused	Coil 00060	–	–
Unused	Coil 00061	–	–
Unused	Coil 00062	–	–
Unused	Coil 00063	–	–
Unused	Coil 00064	–	–

* Batch functions are only active if unit has been configured as a batcher in the setup menus. “Instrument Type Level/Total or Batch” status is 0 for L/T, 1 for Batch.

WARRANTY

This product is warranted against defects in materials and workmanship for a period of two (2) years from the date of shipment to Buyer.

The Warranty is limited to repair or replacement of the defective unit at the option of the manufacturer. This warranty is void if the product has been altered, misused, dismantled, or otherwise abused.

ALL OTHER WARRANTIES, EXPRESSED OR IMPLIED, ARE EXCLUDED, INCLUDING BUT NOT LIMITED TO THE IMPLIED WARRANTIES OF MERCHANTABILITY AND FITNESS FOR A PARTICULAR PURPOSE.

DECODING PART NUMBER						
Example	LT2	L	1	B	0	P
<p>Series: _____ LT2 = LEVELtrol II</p> <p>Display Type: _____ L = LCD O = OLED V = VFD</p> <p>Input Type: _____ 1 = 110 VAC 2 = 220 VAC 3 = 12 VDC (10 to 14 VDC) 4 = 24 VDC (14 to 28 VDC)</p> <p>Relays: _____ A = 2 SPDT Relays B = 4 SPDT Relays</p> <p>Network Card: _____ 0 = None (STD) 2 = RS485/Modbus</p> <p>Mounting: _____ P = Panel Mount N = NEMA 4 Wall Mount W = NEMA 12/13 Wall Mount w/ Clear Cover E = Explosion Proof (No Button Access)</p> <p>Options ET = Extended Temperature: -4°F to 131°F (-20°C to 55°C) IM = Internal Modem IM-56K = 56K Internal Secure Modem M = Modem Power Option TB = RS485 Terminal Block for Panel Mount Enclosure</p> <p>Accessories: OPC/DDE Server for RS232 Port available, see EX5-UCOND-NA00 OPC/DDE Server for Modbus Suite available, see EX5-MDBUS-NA00 Modem Available, see MPP-56KN and MPP-2400N Serial printer available, see P1000, P295 Ethernet Port Server available, see IEPS (RS-232) Ethernet Port Server Modbus TCP available, see ADAM4572 (RS-485) RS-422/485 to RS-232 Communication Adapter available, see CA285 RS232 Extender Cable: P/N=13220-<length in inches></p>						

Kessler-Ellis Products

10 Industrial Way East
 Eatontown, NJ 07724

Toll Free: 800-631-2165
 Phone: (732) 935-1320
 Fax: (732) 935-9344