**User's
Manual**

**CW500
Power Quality Analyzer
Getting Started Guide**

Product Registration

Thank you for purchasing YOKOGAWA products.

YOKOGAWA provides registered users with a variety of information and services.

Please allow us to serve you best by completing the product registration form accessible from our homepage.

<http://tmi.yokogawa.com/>

Thank you for purchasing the CW500 Power Quality Analyzer. This Getting Started Guide focuses on the handling precautions, basic operations, and specifications of the CW500.

To ensure correct use, please read this manual thoroughly before beginning operation. Keep this manual in a safe place for quick reference in the event that a question arises.

List of Manuals

The following five manuals, including this one, are provided as manuals for the CW500.

Please read all manuals.

Manual Title	Manual No.	Description
CW500 Power Quality Analyzer User's Manual	IM CW500-01EN	The supplied CD contains the PDF file of this manual. This manual explains the CW500's standard features and how to use these features.
Application Software User's Manual	IM CW500-61EN	The supplied CD contains the PDF file of this manual. This manual explains how to use the application software.
CW500 Power Quality Analyzer Getting Started Guide	IM CW500-02EN	This guide. The guide explains the handling precautions and basic operations of the CW500 and provides a list of specifications.
Application Software Installation Manual	IM CW500-62EN	This manual describes how to install the application software.
CW500 Power Quality Analyzer User's Manual	IM CW500-92Z1	Chinese document

The "-EN" in the manual number is the language code.

Contact information of Yokogawa offices worldwide is provided on the following sheet.

Manual No.	Description
PIM113-01Z2	List of worldwide contacts

Notes

- The contents of this manual are subject to change without prior notice as a result of continuing improvements to the software's performance and functionality. The figures given in this manual may differ from those that actually appear on your screen.
- Every effort has been made in the preparation of this manual to ensure the accuracy of its contents. However, should you have any questions or find any errors, please contact your nearest YOKOGAWA dealer.
- Copying or reproducing all or any part of the contents of this manual without the permission of YOKOGAWA is strictly prohibited.

Trademarks

- Microsoft, Windows, Windows 7, Windows 8, and Windows 10 are either registered trademarks or trademarks of Microsoft Corporation in the United States and/or other countries.
- Adobe, Acrobat, and PostScript are either registered trademarks or trademarks of Adobe Systems Incorporated.
- In this manual, the ® and TM symbols do not accompany their respective registered trademark or trademark names.
- Other company and product names are trademarks or registered trademarks of their respective companies.

License

This product uses the T-Kernel source code under the T-License agreement of the T-Engine forum (www.t-engine.org). A portion of the copyright of this product software is owned by (c) 2010 The FreeType Project (www.freetype.org). All rights belong to the owner.

Revisions

September 2015	1st Edition	December 2015	2nd Edition
April 2016	3rd Edition	October 2017	4th Edition

Checking the Contents of the Package

Unpack the box and check the contents before operating the instrument. If the wrong items have been delivered, if items are missing, or if there is a problem with the appearance of the items, contact your nearest YOKOGAWA dealer.

CW500

Check that the product that you received is what you ordered by referring to the model name and suffix code given on the delivery note on the packing box. The suffix code of the power cord is not indicated on the instrument.

MODEL	Suffix Code	Specifications
CW500		Power Quality Analyzer
Bluetooth	-B0	Without Bluetooth function
	-B1	With Bluetooth function(only for Japan, US, and Canada)
Power cord ¹	-M	PSE standard power cord, maximum rated voltage: 125 V
	-D	UL/CSA standard power cord, maximum rated voltage: 125 V
	-F	VDE standard power cord, maximum rated voltage: 250 V
	-H	GB standard power cord, maximum rated voltage: 250 V
	-N	NBR standard power cord, maximum rated voltage: 250 V
	-P	Korean standard power cord, maximum rated voltage: 250 V
	-R	AS standard power cord, maximum rated voltage: 250 V
	-S	BS standard power cord, maximum rated voltage: 250 V

1 Make sure that the attached power cord meets the designated standards of the country and area that you are using it in.

*: For products whose suffix code contains "Z," an exclusive manual may be included. Please read it along with the standard manual.

No. (Instrument number)

When contacting the dealer from which you purchased the instrument, please give them the instrument number on the name plate affixed to the rear panel of the instrument.

Standard Accessories

The instrument is shipped with the following accessories. Make sure that all accessories are present and undamaged.

No	Name	Model/ Part No.	Quantity	Notes
1	Voltage probe	98078	1 set	1 red, 1 white, 1 blue, 1 black (with alligator clip)
2	Power cord	L3055HD	1 pc.	-M PSE standard
		B9988YA		-D UL/CSA standard
		B9988YB		-F VDE standard
		B9988YJ		-H GB standard
		A1086WD		-N NBR standard
		A1087WD		-P Korean standard
		B9988YC		-R AS standard
		B9988YD		-S BS standard
3	USB cable	L3064AD	1 pc.	
4	Batteries	-	6 pcs.	AA alkaline batteries (LR6)
5	SD memory card	97060	1 card	M-8326-02 2GB
6	Carrying case	93046	1 pc.	
7	Input terminal plate	-	1 pc.	
8	ID marker	-	4 of each color	8 colors: red, blue, yellow, green, brown, gray, black, white
9	CD	-	1	Application software, manuals (pdf)
10	Manuals	IM CW500-02EN IM CW500-62EN IM CW500-92Z1 PIM 113-01Z2	1 set	This document Installation Manual Chinese document List of contacts

1. Voltage probe

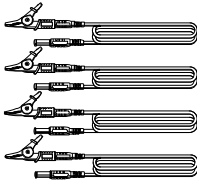

2. Power cord

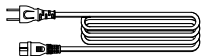

4. Alkaline battery **6. Carrying case**

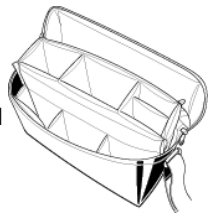
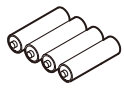

3. USB cord



5. SD memory card



7. Input terminal plates

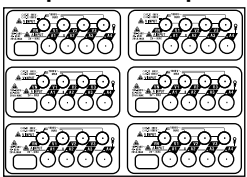

8. ID marker

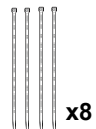

x8

9. CD



10. Manuals

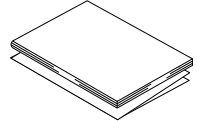

Application software and manual CD

WARNING

Never play this CD on an audio CD player. Doing so may cause loss of hearing or speaker damage due to the high-volume sound that may be produced.

French

AVERTISSEMENT

Ce CD contient les manuels d'utilisation. Ne jamais insérer ce CD dans un lecteur de CD audio. Cela pourrait entraîner une perte d'audition ou l'endommagement des enceintes en raison du volume potentiellement élevé des sons produits.

The English folder in the CD contains the PDF files shown below. The CD also contains Japanese manuals.

File Name	Manual Title	Manual No.
User's Manual.pdf	User's Manual	IM CW500-01EN
Getting Start Guide.pdf	Getting Started Guide	IM CW500-02EN
Application Software User's Manual.pdf	Application Software	IM CW500-61EN
Install Manual.pdf	Installation Manual	IM CW500-62EN

To view the PDF files above, you need Adobe Reader.

Optional Accessories (Sold separately)

Item	Model	Min. Q'ty	Specifications
Current clamp-on probe	96060	1	Measurement range: 2 A
Current clamp-on probe	96061	1	Measurement range: 50 A
Current clamp-on probe	96062	1	Measurement range: 100 A
Current clamp-on probe	96063	1	Measurement range: 200 A
Current clamp-on probe	96064	1	Measurement range: 500 A
Current clamp-on probe	96065	1	Measurement range: 1000 A
Current clamp-on probe	96066	1	Measurement range: 3000 A
Voltage probe	98078	1	
SD memory card	97060	1	2GB
Power supply adapter	98031	1	Exclusive for the CW500
Banana-DIN adapter cable	99073	1	For 96030, 96033, and 96036
Carrying case	93046	1	
Portable case	93047	1	

Safety Precautions

The general safety precautions described herein must be observed during all phases of operation. If the instrument is used in a manner not specified in this guide, the protection provided by the instrument may be impaired. YOKOGAWA assumes no liability for the customer's failure to comply with these requirements.

The following symbols are used on this instrument.



Warning: handle with care. Refer to the user's manual or service manual. This symbol appears on dangerous locations on the meter which require special instructions for proper handling or use. The same symbol appears in the corresponding place in the manual to identify those instructions.



Alternating current



Ground (earth) or functional ground terminal (do not use this terminal as a protective ground terminal)



Equipment protected throughout by double insulation or reinforced insulation

French



Avertissement : À manipuler délicatement. Toujours se reporter aux manuels d'utilisation et d'entretien. Ce symbole a été apposé aux endroits dangereux de l'instrument pour lesquels des consignes spéciales d'utilisation ou de manipulation ont été émises. Le même symbole apparaît à l'endroit correspondant du manuel pour identifier les consignes qui s'y rapportent.



Courant alternatif l'interrupteur d'alimentation



Borne de terre ou borne de terre fonctionnelle (ne pas utiliser cette borne comme prise de terre.)



Équipement protégé par une double isolation ou une isolation renforcée

Measurement Category

Safety standard IEC61010 defines safety levels for locations where measuring instrument are used. The definitions of the categories, O (other) to IV, are provided below.

Measurement category Other (O):

Applies to measurement of circuits that are not directly connected to a main power supply. This category applies to measurement of secondary electric circuits in equipment across a transformer.

Measurement category II :

Applies to measurement of circuits, such as household electric appliances and portable electric tools, that are connected to low-voltage installations.

Measurement category III:

Applies to measurement of facility circuits, such as distribution boards and circuit breakers.

Measurement category IV:

Applies to measurement of power source circuits, such as entrance cables to buildings and cable systems, for low-voltage installations.

Failure to comply with the precautions below could lead to injury or death or damage to the instrument.

WARNING

- **Use the Instrument Only for Its Intended Purpose**

The CW500 is a power measurement instrument that can measure parameters such as voltage, current, and power. Do not use this instrument for anything other than as a power measurement instrument.

- **Check the Physical Appearance**

Do not use the instrument if there is a problem with its physical appearance.

- **User's manual**

Before using this instrument, be sure to read the user's manual and fully understand how to operate it.

-
- **Use the Correct Power Cord and Plug**
 - Only use the dedicated AC adapter and power cord for this instrument.
 - Do not use this instrument's power cord with other instruments.
 - **Use the Correct Power Supply**
 - Make sure that the power supply voltage matches the instrument's rated supply voltage and that it does not exceed the maximum voltage range specified for the power cord.
 - If an appropriate AC outlet for the supplied power cord is unavailable, do not use the instrument.
 - Connect after checking that the power switch of the instrument is turned off.
 - **Batteries**

Do not mix new and old batteries or mix different brands or types of batteries. The batteries may leak, heat up, or burst due to their characteristic differences.

Never replace the batteries while measurement is in progress.
 - **Do Not Operate in an Explosive Atmosphere**

Do not operate the instrument in the presence of flammable gases or vapors. Doing so is extremely dangerous.
 - **Do Not Remove Covers or Disassemble or Alter the Instrument**

Only qualified YOKOGAWA personnel may remove the covers and disassemble or alter the instrument.
 - **Use the Instrument in Appropriate Locations**
 - Do not use the instrument in locations subject to rain or water.
 - Use the instrument in a location where you can immediately remove the power cord if an abnormal or dangerous condition occurs.
 - Never use the instrument with circuits that exceeds 300 VAC for CAT.IV, 600 VAC for CAT.III, and 1000 VAC for CAT.II.
 - Never use the instrument if the instrument or your hand is wet or when condensation or other water droplets are on the instrument.

-
- Do not apply signals that exceed the measurement range.
 - Never open the battery cover while measurement is in progress.
 - The power inlet when the instrument is running on batteries is isolated, but never touch it.
 - **Voltage probe**
 - Be sure to use the probes supplied with this instrument.
 - Attach probe caps according to the measurement category.
 - If the probe and the measurement category of the main unit are mismatched, the lower measurement category takes precedence. Be sure to check that the measurement voltage and rating are matched.
 - Never connect voltage probes that are not necessary for the measurement that you are taking.
 - Do not connect to the measurement line when the probe is not connected to the main unit.
 - When taking a measurement, be careful that your finger or the like does not cross over the barrier.
Barrier: A mark for securing the minimum required creep and spatial distance to prevent electric shock during operation.
 - Never remove the probe from the main unit connector while measuring (power running from the measurement line).
 - Do not let the metal part at the tip make contact between the two measurement lines.
 - Never touch the metal part at the tip.
 - **Clamp-on probe**
 - Use only the clamp-on probes exclusive for this instrument.
 - Be sure to check that the measurement current and rating are matched, and use it on an electric circuit whose voltage is less than or equal to the maximum rated voltage to ground.
 - Never connect probes that are not necessary for the measurement that you are taking.
 - Do not connect to the measurement line when the probe is not connected to the main unit.

-
- When taking a measurement, be careful that your finger or the like does not cross over the barrier.
 - Never remove the probe from the main unit connector while measuring (power running from the measurement line).
 - Be sure to connect to the secondary side of the circuit breaker. The current capacity is large on the primary side and is dangerous.
 - When the core is opened, do not let the metal part make contact between the two measurement lines.
-
-

CAUTION

- **Operating Environment Limitations**

This product is a Class A (for industrial environment) product. Operation of this product in a residential area may cause radio interference in which case the user will be required to correct the interference.

- The conductor to be measured may be hot. Be careful of burns.
 - Do not apply current or voltage that exceeds the measurement range of each range setting for a long period of time.
 - Do not apply voltage or current to the voltage probe or clamp-on probe when the power is off.
 - Do not use the instrument near objects that generate strong electromagnetic waves or charged objects.
 - Do not apply vibration or shock.
 - After use, be sure to turn the power off, and remove the power cord, voltage probe, and clamp-on probe.
 - If you do not intend to use the instrument for a long time, remove the batteries from the instrument.
-

AVERTISSEMENT

- **Utiliser l'instrument aux seules fins pour lesquelles il est prévu**

Le CW500 est un instrument de mesure de la puissance qui peut mesurer des paramètres tels que la tension, l'intensité et la puissance. Ne pas utiliser cet instrument à d'autres fins que la mesure de la puissance.

- **Inspecter l'apparence physique**

Ne pas utiliser l'instrument si son intégrité physique semble être compromise.

- **Manuel utilisateur**

Avant d'utiliser cet instrument, bien lire le manuel utilisateur et comprendre comment il fonctionne.

- **Utiliser le cordon d'alimentation et la fiche adaptés**

- Utiliser uniquement l'adaptateur le câble d'alimentation de cet instrument.
- Ne pas utiliser le câble d'alimentation de cet instrument avec d'autres instruments.

- **Vérifier l'alimentation**

- Vérifier que la tension d'alimentation correspond à la tension d'alimentation nominale de l'instrument et qu'elle ne dépasse pas la plage de tension maximale spécifiée pour le cordon d'alimentation.
- N'utiliser l'instrument que si une prise secteur appropriée est disponible pour le branchement du cordon d'alimentation.
- Brancher après avoir vérifié que l'interrupteur d'alimentation de l'instrument est sur OFF.

- **Batteries**

Ne pas mélanger des batteries neuves et des batteries usagées, ni des batteries de marques ou de types différents. Les batteries risquent de fuir, de chauffer ou d'éclater en raison de leurs différentes caractéristiques.

Ne jamais remplacer les batteries lorsque la mesure est en cours."

-
- **Ne pas utiliser dans un environnement explosif**

Ne pas utiliser l'instrument en présence de gaz ou de vapeurs inflammables. Cela pourrait être extrêmement dangereux.
 - **Ne pas retirer le capot, ni démonter ou modifier l'instrument**

Seul le personnel YOKOGAWA qualifié est habilité à retirer le capot et à démonter ou modifier l'instrument. Certains composants à l'intérieur de l'instrument sont à haute tension et par conséquent, représentent un danger.
 - **Installer et utiliser l'instrument aux emplacements appropriés**
 - L'instrument est prévu pour une utilisation en intérieur. Ne pas l'installer, ni l'utiliser à l'extérieur.
 - Installer l'instrument de manière à pouvoir immédiatement le débrancher du secteur en cas de fonctionnement anormal ou dangereux.
 - Ne jamais effectuer de mesure de l'intensité sur un circuit dans lequel le potentiel électrique dépasse 300 V CA dans la catégorie de mesure IV, 600 V CA dans la catégorie de mesure III, et 1000 V CA dans la catégorie de mesure II utilisant CW500.
 - Ne pas utiliser l'instrument s'il est mouillé ou si vos mains sont mouillées. Sinon, un choc électrique peut se produire.
 - Ne pas appliquer de signaux dépassant la plage de la mesure.
 - Ne jamais ouvrir le cache de la batterie lorsque la mesure est en cours.
 - L'entrée d'alimentation, lorsque l'instrument est en cours d'utilisation sur les batteries, est isolée, mais il ne faut jamais la toucher.
 - **Sonde de tension**
 - S'assurer d'utiliser les sondes fournies avec cet instrument.
 - Raccorder les caches de sondes en fonction de la catégorie de la mesure.
 - Si la sonde et la catégorie de mesure de l'unité principale ne correspondent pas, c'est la catégorie de mesure inférieure qui prévaut. S'assurer que la tension de mesure et la valeur d'évaluation sont comparées.

-
- Ne jamais relier les sondes de tension qui ne sont pas nécessaires pour la mesure que vous effectuez.
 - Ne pas relier au câble de mesure si la sonde n'est pas reliée à l'unité principale.
 - Lors d'une prise de mesure, faire en sorte que vos doigts ou autres ne dépassent pas la barrière.
Barrière : repère sécurisant le fluage requis minimal et la distance spatiale minimale pour empêcher un choc électrique en cours de fonctionnement.
 - Ne jamais retirer la sonde du connecteur d'unité principale lors de la mesure (alimentation provenant du câble de mesure).
 - Ne pas laisser la pièce métallique au niveau de l'embout faire contact entre les deux câbles de mesure.
 - Ne jamais toucher la pièce métallique au niveau de l'embout.
 - **Sonde à serrer**
 - Utiliser les sondes à serrer uniquement pour cet instrument.
 - Vérifier que l'intensité de mesure et la valeur évaluée sont comparés et utiliser cette comparaison sur un circuit électrique dont la tension est inférieure ou égale à la tension évaluée maximale à la masse.
 - Ne jamais relier les sondes qui ne sont pas nécessaires pour la mesure que vous effectuez.
 - Ne pas relier au câble de mesure si la sonde n'est pas reliée à l'unité principale.
 - Lors d'une prise de mesure, faire en sorte que vos doigts ou autres ne dépassent pas la barrière.
 - Ne jamais retirer la sonde du connecteur d'unité principale lors de la mesure (alimentation provenant du câble de mesure).
 - Bien relier au côté secondaire du disjoncteur. La capacité de courant est importante sur le côté primaire et est dangereuse.
 - Lorsque le noyau est ouvert, ne pas laisser la pièce métallique faire contact entre les deux câbles de mesure.
-

ATTENTION

- Limitations relatives à l'environnement opérationnel
Ce produit est un produit de classe A (pour environnements industriels). L'utilisation de ce produit dans un zone résidentielle peut entraîner une interférence radio que l'utilisateur sera tenu de rectifier.
 - Le conducteur à mesurer peut être chaud. Faire attention aux brûlures.
 - Ne pas appliquer une intensité ou une tension dépassant la plage de mesure de chaque paramétrage de plage de mesure pendant une longue période.
 - Ne pas appliquer une intensité ou une tension à la sonde de tension ou à la sonde à serrer si l'alimentation est coupée.
 - Ne pas utiliser l'instrument à proximité d'objets générant d'importantes ondes électromagnétiques ou à proximité d'objets chargés.
 - Ne pas faire de vibration ou de choc.
 - Après utilisation, bien couper l'alimentation et retirer le cordon d'alimentation, la sonde de tension et la sonde à serrer.
 - Si l'instrument ne doit pas être utilisé pendant une période prolongée, retirer les batteries de l'instrument.
-

The notes and cautions in this manual are categorized using the following symbols.



Improper handling or use can lead to injury to the user or damage to the instrument. This symbol appears on the instrument to indicate that the user must refer to the user's manual for special instructions. The same symbol appears in the corresponding place in the user's manual to identify those instructions. In the manual, the symbol is used in conjunction with the word "WARNING" or "CAUTION."

WARNING

Calls attention to actions or conditions that could cause serious or fatal injury to the user, and precautions that can be taken to prevent such occurrences.

CAUTION

Calls attention to actions or conditions that could cause light injury to the user or damage to the instrument or user's data, and precautions that can be taken to prevent such occurrences.

Note

Calls attention to information that is important for the proper operation of the instrument.

French



Une manipulation ou une utilisation incorrectes risquent de blesser l'utilisateur ou d'endommager l'instrument. Ce symbole apparaît sur l'instrument pour indiquer à l'utilisateur qu'il doit se reporter au manuel de l'utilisateur afin d'y lire les instructions spécifiques correspondantes. Ce même symbole apparaît à la section correspondante du manuel de l'utilisateur pour signaler lesdites instructions. Dans le manuel de l'utilisateur, ce symbole est accompagné des termes AVERTISSEMENT et ATTENTION.

AVERTISSEMENT

Attire l'attention sur des gestes ou des conditions susceptibles de provoquer des blessures graves (voire mortelles), et sur les précautions de sécurité pouvant prévenir de tels accidents.

ATTENTION

Attire l'attention sur des gestes ou des conditions susceptibles de provoquer des blessures légères ou d'endommager l'instrument ou les données de l'utilisateur, et sur les précautions de sécurité susceptibles de prévenir de tels accidents.

Sales in Each Country or Region

Waste Electrical and Electronic Equipment



Waste Electrical and Electronic Equipment (WEEE), Directive
(This directive is valid only in the EU.)

This product complies with the WEEE directive marking requirement. This marking indicates that you must not discard this electrical/electronic product in domestic household waste.

Product Category

With reference to the equipment types in the WEEE directive, this product is classified as a “Monitoring and control instruments” product.

When disposing products in the EU, contact your local Yokogawa Europe B.V. office.

Do not dispose in domestic household waste.

EU Battery Directive

(This directive is valid only in the EU.)



Batteries are included in this product. This marking indicates they shall be sorted out and collected as ordained in EU Battery Directive.

Battery type:

1. Lithium battery

You cannot replace batteries by yourself. When you need to replace batteries, contact your local Yokogawa Europe B.V.office.

2. Alkaline battery

When disposing of alkaline batteries, follow the domestic law concerning disposal. Take the proper action to dispose batteries in accordance with the established collection system in the European Economic Area. For the battery removal procedure, see page 7.

Authorized Representative in the EEA

Yokogawa Europe B.V. is the authorized representative of Yokogawa Test & Measurement Corporation for this product in the EEA. To contact Yokogawa Europe B.V., see the separate list of worldwide contacts, PIM 113-01Z2.

Compliance with the Radio Waves Act (Republic of Korea)

CW500-B0 complies with the Radio Waves Act (Republic of Korea). Note the following when using the product in Republic of Korea.

The product is for business use (Class A) and meets the electromagnetic compatibility requirements. The seller and the user must note the above point and use the product in a place except for home.

Registration No: KCC-REM-IMY-EEN396
Equipment Name: Power Quarity Analyzer
Trade Name: Yokogawa Test & Measurement Corporation
Manufacturer: Yokogawa Test & Measurement Corporation
Country of Origin: Japan

Contents

List of Manuals.....	i
Checking the Contents of the Package.....	iii
Safety Precautions.....	vii
Sales in Each Country or Region.....	xix
Component Names and Functions.....	1
Front Panel.....	1
Top (Connector area).....	2
Side.....	3
Back.....	3
Voltage Probe and Clamp-on Probe.....	4
Making Preparations for Measurements.....	5
Power Supply.....	7
Installing Batteries.....	7
Connecting to an AC Power Supply.....	10
Turning the Power On and Off.....	12
Inserting and Removing the SD Memory Card.....	13
Connecting a Voltage Probe and Clamp-on Probe.....	15
Connecting the I/O Terminals.....	18
Functional Overview.....	21
Starting and Stopping Recording.....	25
Displaying the Measured Values.....	29
Setup.....	32
Specifications.....	37
General Specifications.....	37
Wiring.....	40
Measurement Specifications.....	41
External Dimensions.....	62
Appendix Correspondence to radio law of each country.....	63

Component Names and Functions

Front Panel

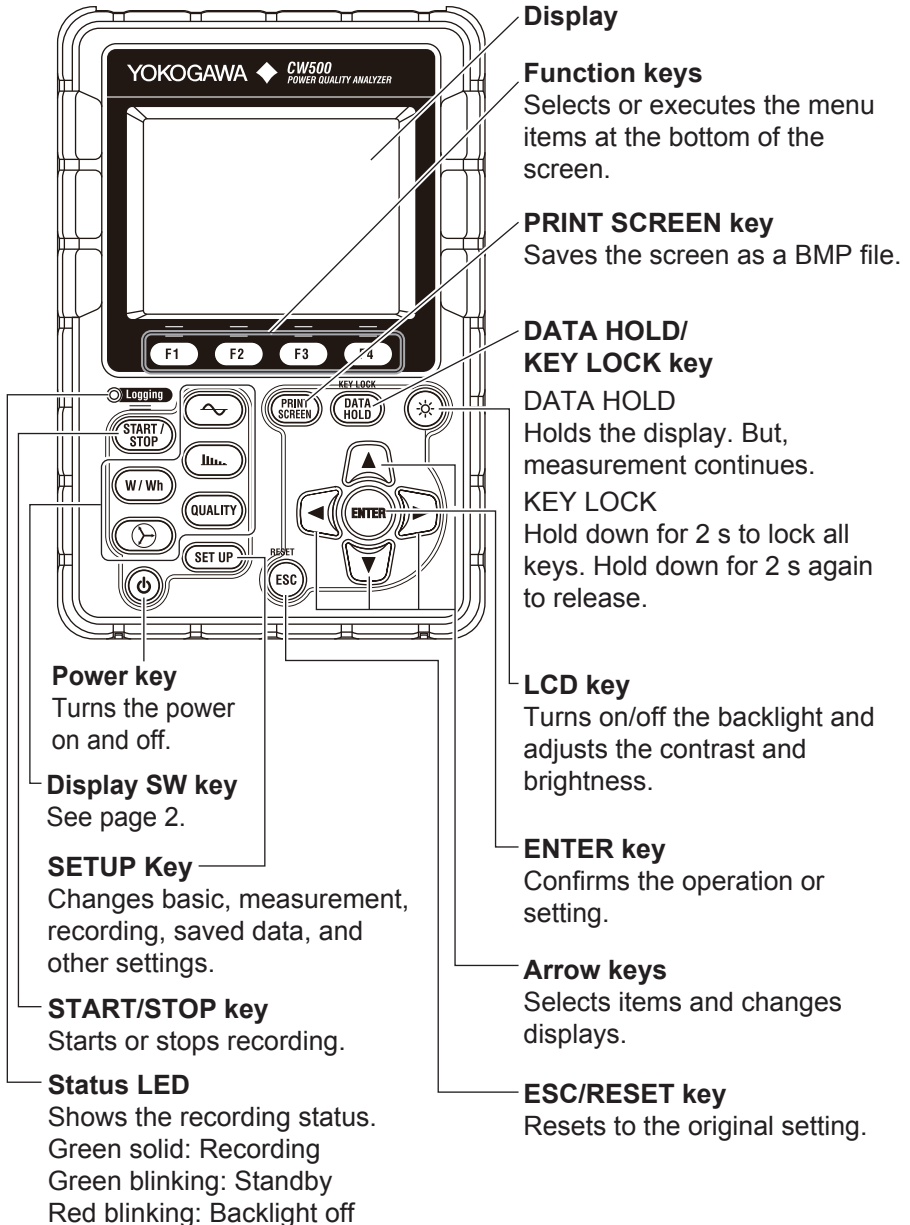

Component Names and Functions

Display Switch Key

W/Wh key

Displays instantaneous values, integrated values, and “demand”



Vector key

Displays phases

Waveform key

Displays voltage and current waveforms

Harmonic analysis key

Displays harmonic voltage, harmonic current, and harmonic power

QUALITY key

Displays the occurrence of swell, dip, interruption, transient, inrush current, and flicker

Top (Connector area)

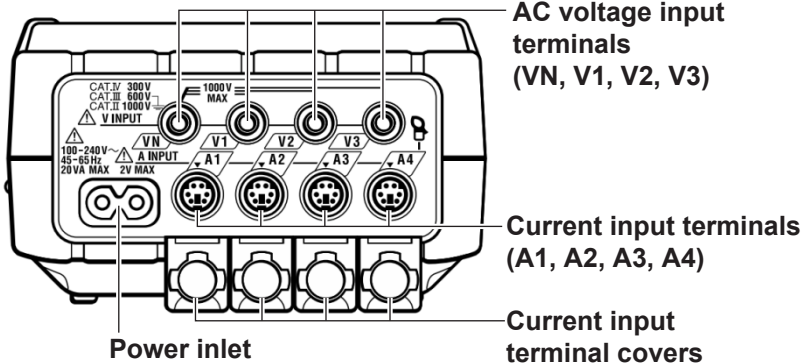

Wiring System		AC Voltage Input Terminal	Current Input Terminal*
Single-phase two-wire (1 system)	1P2W×1	VN, V1	A1
Single-phase two-wire (2 system)	1P2W×2	VN, V1	A1, A2
Single-phase two-wire (3 system)	1P2W×3	VN, V1	A1, A2, A3
Single-phase two-wire (4 system)	1P2W×4	VN, V1	A1, A2, A3, A4
Single-phase three-wire (1 system)	1P3W×1	VN, V1, V2	A1, A2
Single-phase three-wire (2 system)	1P3W×2	VN, V1, V2	A1, A2, A3, A4
Three-phase three-wire (1 system)	3P3W×1	VN, V1, V2	A1, A2
Three-phase three-wire (2 system)	3P3W×2	VN, V1, V2	A1, A2, A3, A4
Three-phase three-wire 3A	3P3W3A	V1, V2, V3	A1, A2, A3
Three-phase four-wire	3P4W×1	VN, V1, V2, V3	A1, A2, A3

* Current terminals that are not used in wiring can measure only rms values and harmonics.

Side

Output terminals

Output high or low level signals depending on the power supply quality.

Analog input terminals

Used to monitor voltage signals from temperature sensors or the like.

USB type-B port (mini-B)

Used to control the CW500 from the PC using the accompanying software.

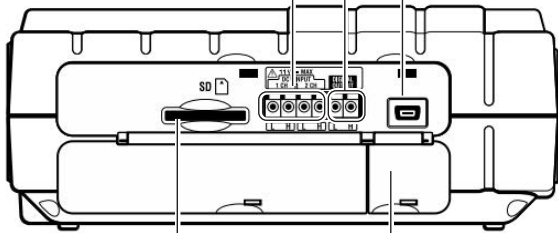

SD memory card slot

Used to save measured data to an SD memory card.

Terminal cover

Back

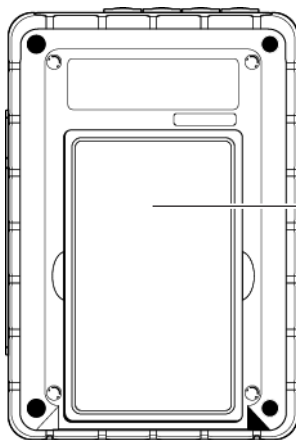

Battery cover

Voltage Probe and Clamp-on Probe

Alligator Clip (the end of the voltage probe)

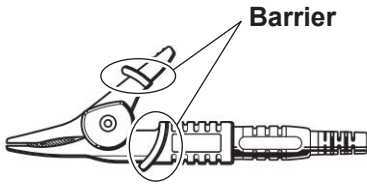

Clamp-on Probe

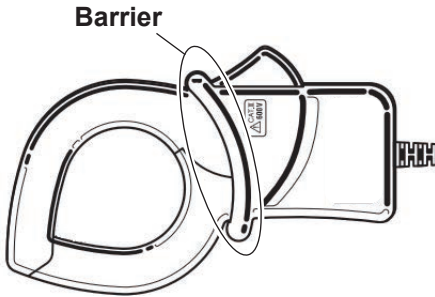

Barrier: A mark for securing the minimum required creep and spatial distance to prevent electric shock during operation.

When taking a measurement, be careful that your finger or the like does not cross over the barrier.

Making Preparations for Measurements

Affixing an Input Terminal Plate

Before affixing a plate, wipe dirt and dust off the connector area of the CW500 top panel.

From the supplied input terminal plates, select an input terminal plate that matches the wire colors, and affix the plate to the connector area of the top panel.

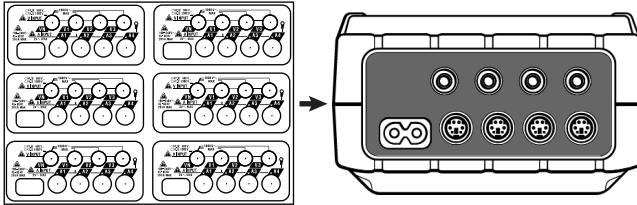

	VN	V1/A1	V2/A2	V3/A3	A4
TYPE 1	Blue	Red	Green	Black	Yellow
TYPE 2	Blue	Brown	Black	Gray	Yellow
TYPE 3	Black	Yellow	Green	Red	White
TYPE 4	Blue	Black	Red	White	Yellow
TYPE 5	White	Black	Red	Blue	Yellow
TYPE 6	Black	Red	Yellow	Blue	White

Affixing ID Markers

Affix ID markers with the same colors as the input terminals to both ends of the voltage probes and clamp-on probes.

ID markers come in eight colors (red, blue, yellow, green, brown, gray, black, white). For each color, there are four markers (32 markers total).

ID markers (32 pcs.)

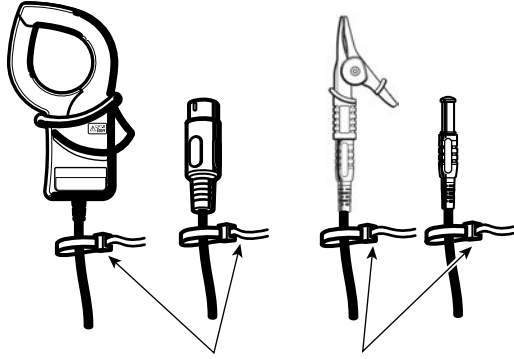
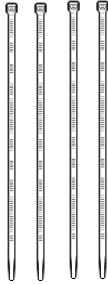

Attach to both ends of the current clamp sensors and voltage probes.

Power Supply

The CW500 can run on AC power or batteries.

Installing Batteries

Even when AC power supply is cut off such as due to a power failure, the power supply can be switched to batteries to continue measurements. AA alkaline batteries (LR6) or AA nickel-metal hydride batteries (Ni-MH) can be used.

For rechargeable batteries, use the battery manufacturer's charger to charge them. You cannot charge the batteries with the CW500.

* The batteries included with the CW500 are AA alkaline batteries (LR6).



WARNING

- Never replace the batteries while measurement is in progress.
- Insert batteries with the correct polarity. Otherwise, the batteries may leak, heat up, or burst.
- Do not mix new and old batteries or mix different brands or types of batteries. The batteries may leak, heat up, or burst due to their characteristic differences.
- The power inlet when the instrument is running on batteries is isolated, but never touch it.
- When replacing batteries, be sure to turn the power off, and remove the power cord, voltage probe, and current clamp-on probe from the CW500.

CAUTION

- If you do not intend to use the instrument for a long time, remove the batteries from the instrument. Leaving the batteries in the instrument may cause the batteries to leak.
- If the batteries go flat during use, the measurement data will not be saved. We recommend that you replace the batteries as soon as they start to run low.



AVERTISSEMENT

- Ne jamais remplacer les batteries lorsque la mesure est en cours.
 - Insérer les batteries en observant la polarité correcte. À défaut, les batteries risquent de fuir, de chauffer ou d'éclater.
 - Ne pas mélanger des batteries neuves et des batteries usagées, ni des batteries de marques ou de types différents. Les batteries risquent de fuir, de chauffer ou d'éclater en raison de leurs différentes caractéristiques.
 - L'entrée d'alimentation, lorsque l'instrument est en cours d'utilisation sur les batteries, est isolée, mais il ne faut jamais la toucher.
 - Lors du remplacement des batteries, bien couper l'alimentation et retirer le cordon d'alimentation, la sonde de tension et la sonde à serrer du CW500.
-
-

ATTENTION

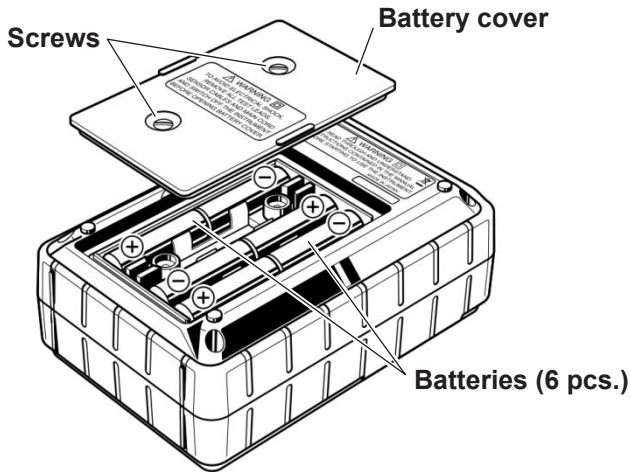

- Si l'instrument ne doit pas être utilisé pendant une période prolongée, retirer les batteries de l'instrument. Si les batteries ne sont pas retirées de l'instrument, elles risquent de fuir.
 - En cas de décharge complète des batteries en cours d'utilisation, les données de mesure ne sont pas enregistrées. Il est recommandé de remplacer les batteries dès que leur charge commence à être basse.
-

1. Check that the power is turned off and that cables are not connected.
2. Using a flathead screwdriver, unfasten the screws holding the battery cover on the rear panel, and open the battery cover.
3. Insert batteries into the battery holder. Pay attention to their polarity.
Batteries that can be used:
 - AA alkaline batteries (LR6, 1.5 V) 6 pcs.
 - AA nickel-metal hydride batteries (Ni-MH) 6 pcs.
4. Close the battery cover, and fasten it with the screws.



Battery Level Indicator

Depending on the battery level, the following indicators appear on the screen.

	<p>With alkaline batteries, measurement is possible for about 3 hours. With nickel-metal hydride batteries (1900 mA/h), measurement is possible for about 4.5 hours (reference value with the LCD turned off).</p>
	<p>Normal measurement Because the voltage of a fully charged nickel-metal hydride battery is less than that of alkaline battery, the indicator may not go higher than these indications.</p>
	<p>Measurement continues, but data saving is stopped. (The measured data up to when data saving is stopped will be saved.)</p>

Connecting to an AC Power Supply



WARNING

- Make sure that the power supply voltage matches the instrument's rated supply voltage and that it does not exceed the maximum voltage range specified for the power cord.
 - Connect the power cord after checking that the instrument is turned off.
 - To prevent electric shock and fire, use a power cord for this instrument provided by YOKOGAWA.
 - If an AC outlet that conforms to the supplied power cord is unavailable and you cannot ground the instrument, do not use the instrument.
-

French



AVERTISSEMENT

- Avant de brancher le cordon d'alimentation, vérifier que la tension source correspond à la tension d'alimentation nominale du CW500 et qu'elle est compatible avec la tension nominale maximale du cordon d'alimentation.
 - Brancher le cordon d'alimentation après avoir vérifié que l'interrupteur d'alimentation de l'instrument est sur OFF.
 - Pour éviter tout risque de choc électrique ou d'incendie, utiliser le cordon d'alimentation fourni par YOKOGAWA et prévu pour l'instrument.
 - N'utiliser l'instrument que si une prise secteur appropriée est disponible pour le branchement du cordon d'alimentation.
-

Connecting the Power Cord

1. Check that the power is turned off and that cables are not connected.
2. Connect the power cord plug to the power inlet on the top panel.
3. Connect the other end of the cord to an outlet that meets the following conditions.

Rated supply voltage*	100 VAC to 240 VAC
Permitted supply voltage range	90 VAC to 264 VAC
Rated supply frequency	50/60 Hz
Permitted supply frequency range	45 Hz to 65 Hz
Maximum power consumption	Approx. 7 VA

* This instrument can use a 100 V or a 200 V power supply. The maximum rated voltage differs according to the type of power cord. Before you use the instrument, check that the voltage supplied to it is less than or equal to the maximum rated voltage of the power cord provided with it (see page iii for the maximum voltage rating).

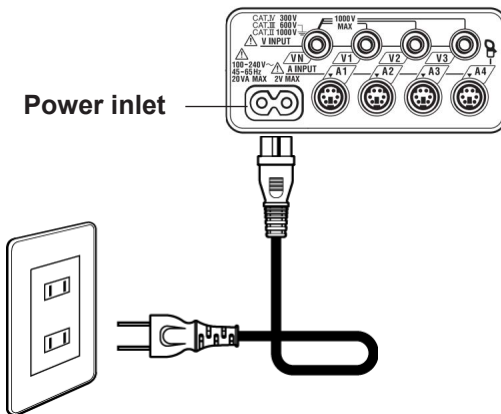

Turning the Power On and Off

Turning the Power On

1. Hold down the power key until the model name and version are displayed on the screen.

After a few moments, the screen that was displayed the last time you turned the power off appears.

If the CW500 does not start properly, stop using it immediately, and see “Troubleshooting” in the manual in the CD.

Note

If you connect a different current clamp-on probe from the previous time and turn the power on, the current clamp-on probe connected currently will be displayed for 5 seconds, but the CW500 will not be automatically configured to use it. Change the current clamp-on probe connection setting on the basic setup screen.

If you turn the power on without connecting a current clamp-on probe, the previous settings remain.

Turning the Power Off

1. Hold down the power key for at least 2 seconds.

Inserting and Removing the SD Memory Card



CAUTION

- Insert SD memory cards in the correct orientation. Inserting in the incorrect orientation can damage the SD memory card or the CW500.
 - Before removing the SD memory card, make sure that the card is not being accessed.
Removing the SD memory card while it is being accessed can damage the saved data or the CW500.
 - Do not remove the card while recording. Doing so can damage the saved data or the CW500. When removing it, be sure to stop recording, and wait for the message “Recording stopped” to disappear.
-

French



ATTENTION

- Insérer des cartes mémoire SD dans le bon sens. Le fait de les insérer dans le mauvais sens risque d'endommager la carte mémoire SD ou le CW500.
 - Avant de retirer la carte mémoire SD, vérifier que personne n'est en train d'y accéder. Le fait de retirer la carte mémoire SD alors que quelqu'un est en train d'y accéder risque d'endommager les données enregistrées ou le CW500.
 - Ne pas retirer la carte lors de l'enregistrement. En effet, cela risquerait d'endommager les données enregistrées ou le CW500. Lors du retrait de la carte, s'assurer que l'enregistrement est arrêté et attendre que le message « Enregistrement arrêté » s'affiche.
-

Inserting and Removing the SD Memory Card

Note

- Before using a new SD memory card, be sure to format it on the CW500. Proper recording may not be possible if you format it on a PC. For details, see “Formatting” in the manual in the CD.
 - Frequently used SD memory cards or those used over a long period may lose their ability to record data due to the service life of the flash memory. Replace such cards with new ones.
 - Data recorded on SD memory cards may be lost or corrupted due to accidents or failures. Regularly back up recorded data. Yokogawa will not be liable for damages incurred by lost or corrupt data, regardless of the cause or content.
-

Inserting an SD Memory Card

1. Open the connector cover.
2. Face the front side of the SD memory card up, and insert it in the direction of the arrow in the figure until it clicks.
3. Close the connector cover. Be sure to close the connector cover unless there is a special reason not to.

Removing the SD Memory Card

1. Open the connector cover.
2. Gently push the SD memory card further into the slot. The latch will disengage, and the SD memory card will pop out.
3. Remove the card from the slot.
4. Close the connector cover. Be sure to close the connector cover unless there is a special reason not to.

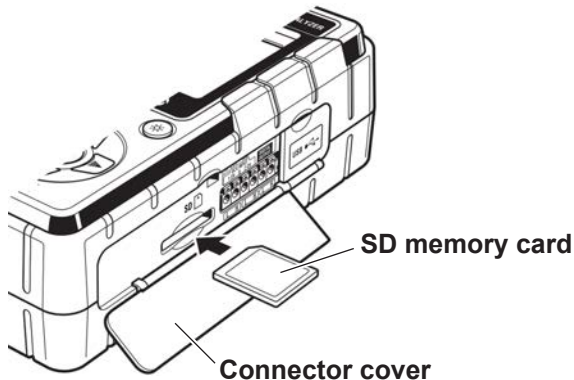

Connecting a Voltage Probe and Clamp-on Probe



WARNING

- Use the supplied voltage probes.
- Use exclusive current clamp-on probes for the CW500. And, be sure to check that the measurement current and rating are matched.
- Never connect voltage probes or current clamp-on probes that are not necessary for the measurement that you are taking.
- When connecting a probe, be sure to connect the CW500 end first. Firmly insert the probe up to the base. Do not connect to the measurement line when the probe is not connected to the CW500.
- Never remove the probe from the main unit connector while measuring (power running from the measurement line).
- Connect the probe after checking that the instrument is turned off.
- If the probe and the measurement category of the main unit are mismatched, measure using the measurement category with the lower measurement voltage.
- Be careful not to short the power supply line with the metal section of the voltage probe tip when wiring. Never touch the metal part at the tip.
- Be sure to use the CW500 on the secondary side of the VT (voltage transformer) and CT (current transformer).
- While current is flowing, be sure not to open the secondary side of the CT. If it is opened, high voltage will appear at the secondary side, making it extremely dangerous.
- Operate according to the user's manual for the current clamp-on probe that you are using.

French



AVERTISSEMENT

- Utiliser les sondes de tension fournies.
- Utiliser les sondes de tension fournies. Utiliser les sondes à serrer exclusivement pour le CW500. S'assurer également que l'intensité de mesure et la valeur d'évaluation sont comparées.
- Ne jamais relier les sondes de tension ou les sondes à serrer qui ne sont pas nécessaires pour la mesure que vous effectuez.
- Lors du raccordement d'une sonde, bien relier tout d'abord l'extrémité du CW500. Insérer solidement la sonde jusqu'à la base.
- Ne pas relier au câble de mesure si la sonde n'est pas reliée au CW500.
- Ne jamais retirer la sonde du connecteur d'unité principale lors de la mesure (alimentation provenant du câble de mesure).
- Relier la sonde après avoir vérifié que l'instrument est allumé.
- Si la sonde et la catégorie de mesure de l'unité principale ne correspondent pas, effectuer la mesure avec la catégorie de mesure de tension de mesure inférieure.
- Faire attention de ne pas raccourcir le tuyau d'alimentation avec la partie métallique de l'embout de la sonde de tension lors du raccordement. Ne jamais toucher la pièce métallique au niveau de l'embout.
- Bien utiliser le CW500 sur le côté secondaire du transformateur de tension (TT) et du transformateur de courant (TC).
- Lorsque le courant circule, ne pas ouvrir le côté secondaire du TC. Si cela se produisait, la haute tension se déplacerait du côté secondaire, le rendant extrêmement dangereux.
- Opérer selon le manuel utilisateur pour la sonde à serrer utilisée.

Connecting a Voltage Probe and Clamp-on Probe

Connect voltage probes and current clamp-on probes as follows.

1. Check that the CW500 is turned off.
2. Connect the necessary voltage probes to the AC voltage input terminals of the CW500.
3. Connect the necessary current clamp-on probes to the current input terminals of the CW500. Make sure that the arrow of the current clamp-on probe output terminals and that of the main unit's current input terminals are aligned with each other.

The number of voltage probes and current clamp-on probes that you need and where to connect them vary depending on the wiring system. For details, see “Wiring Diagrams” in the manual in the CD.

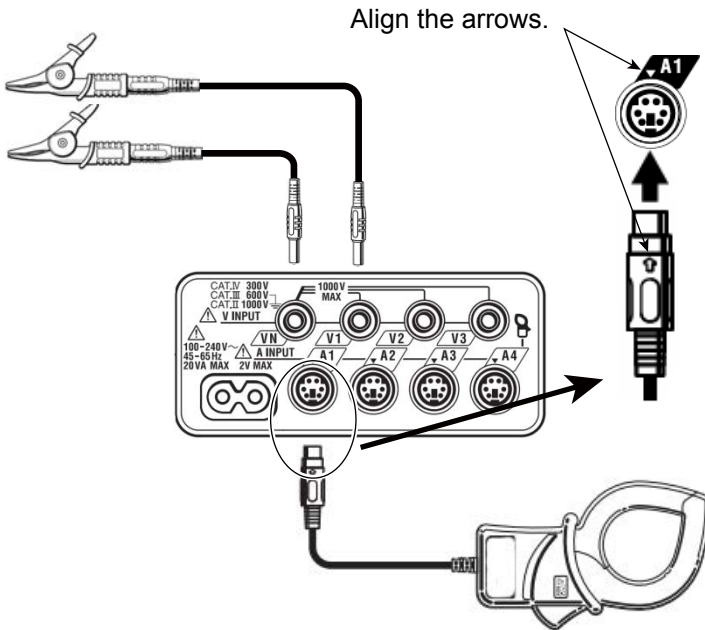

Connecting the I/O Terminals



CAUTION

- Apply voltage in the range of ± 11 V DC to the input terminals. Exceeding range can damage the CW500.
 - The L terminals of each channel are connected internally. Do not simultaneously connect different ground levels to the L terminals.
-

French



ATTENTION

- Appliquer une tension comprise dans la plage de ± 11 V CC aux bornes d'entrée. Le fait de dépasser la plage risque d'endommager le CW500.
 - Les bornes L de chaque canal sont raccordées en interne. Ne pas raccorder simultanément différents niveaux de masse aux bornes L.
-

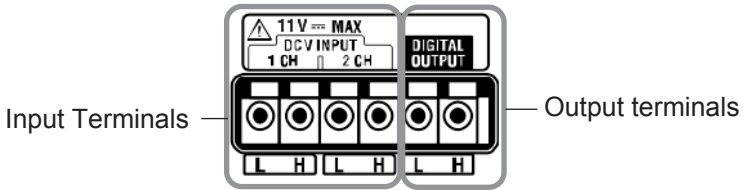

Do not mistake input terminals for output terminals or vice versa.

Connectable signal wire sizes are as follows.

Compliant wire: Single wire $\phi 1.2$ mm (AWG16)

Stranded wire 1.25 mm² (AWG16) strand diameter
0.18 mm or more

Usable wire: Single wire $\phi 0.4$ to $\phi 1.2$ mm (AWG26 to 16)

Stranded wire 0.2 to 1.25 mm² (AWG24 to 16)
Strand diameter 0.18 mm or more

Standard length of stripped wire: 11 mm

1. Open the connector cover.
2. While pressing the rectangular area above the appropriate terminal with a flat-bladed screwdriver or the like, insert a signal wire.
3. Pull out the screwdriver. The signal wire is fixed in place.

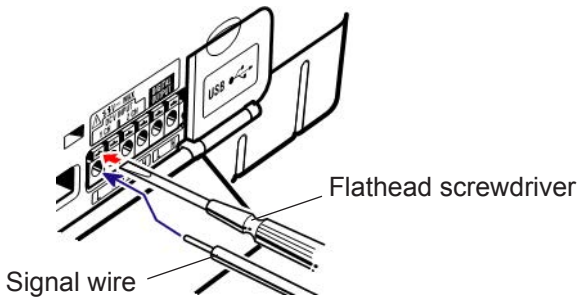

Input Terminals

Input terminals are used to monitor voltage output signals from temperature sensors or the like. They are useful when you need to simultaneously measure a signal output from another device and the anomalies that occur on that power supply.

Number of channels: 2

Input resistance: Approx. 225.6 k Ω

Output Terminals

The output terminals normally output high level signals, but when a power supply quality event occurs, they output low level signals while the event persists.

Note

- If the event persists less than 1 second, a low level signal is output for 1 second.
 - The output target event is the event with the highest priority among the specified events. If you want the output to synchronize with a lower priority event, turn off events that are higher priority.
-

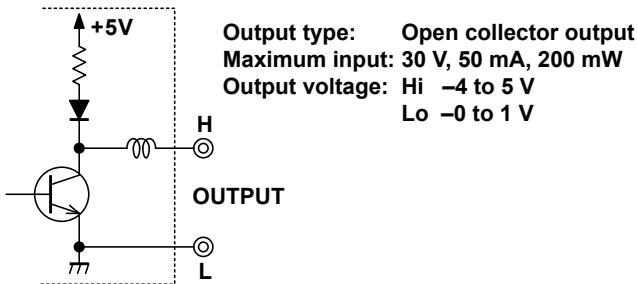

Functional Overview

Guide
2013/02/04
22:50:30

Start recording

Quick start guide

Start now

[ESC]:CANCEL
[ENTER]:OK

Starting and Ending Recording
 Start recording normally or start by following the Quick Start Navigation, which guides you through the necessary setup for recording.
 See “Starting and Stopping Recording.”

Displaying Instantaneous, Integrated, and Demand

Displays instantaneous, average, maximum and minimum values for current, voltage, active power, apparent power, and reactive power. Switch the screen to display integrated values. Set a demand target value and display the demand values from start to finish.
 See “Displaying Instantaneous, Integrated, and Demand.”

W/Wh
2013/06/05
13:42:06

	1ch	2ch	3ch	
V :	596.7	445.6	499.1	V
A :	49.9	39.6	44.8	A
P :	29.78	17.68	26.78	kW
Q :	20.03	10.65	20.39	kvar
S :	29.78	17.68	26.78	kVA
PF :	0.798	0.785	0.793	

P :	91.95	kW	f :	60.00	Hz
Q :	57.23	kvar			
S :	91.95	kVA			
PF :	0.809	A4 :	39.6	A	
DC1 :	0	mV	DC2 :	-0	mV

Inst
Avg
Max
Min

Wh
Zoom
Trend
Customize

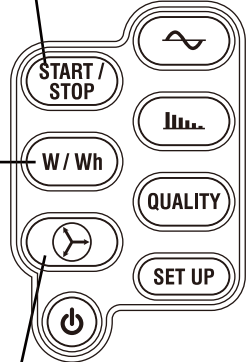

2013/07/17
19:37:14

V1	199.8	V	-0.0°
V2	200.0	V	119.9°
V3	198.9	V	-120.0°
A1	500.2	A	5.1°
A2	499.0	A	125.1°
A3	500.2	A	-114.7°

f	55.00	Hz
Unbalance		
V	0.1%	
A	0.2%	

V x 2
A x 1
Diagram
Check

Displaying Vectors and Checking the Wiring
 Displays a vector diagram of voltage and current for the measurement channel and checks the wiring.
 See “Vector.”

Displaying Waveforms

Displays waveforms of voltage and current for the measurement channel. See “Waveforms.”

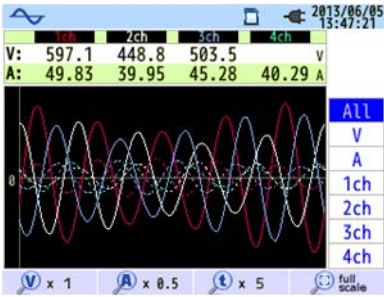

Harmonic Analysis

Displays harmonic components superimposed on the voltage and current for the measurement channel. See “Harmonic Analysis.”

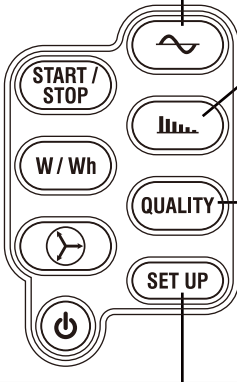
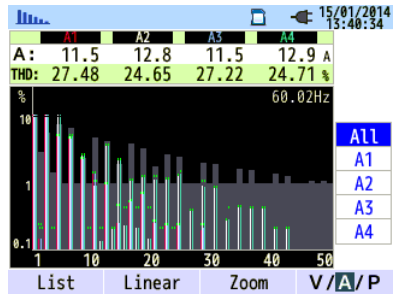

Displaying Power Supply Quality Events

Displays the swell, dip, interruption, transient, inrush current, and flicker of the voltage. See “Power Supply Quality.”







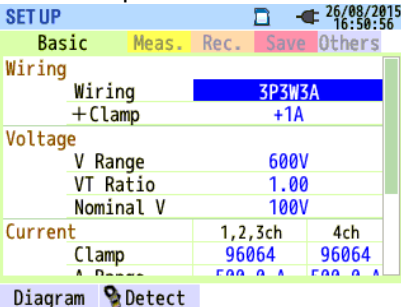









Event	Occurrence
101.0 V	2013/07/18 10:45:43.136
50.4 V	2013/07/18 10:45:43.136
87.1 V	2013/07/18 10:45:35.136
128.5 V	2013/07/18 10:45:27.136
-217.1 V	2013/07/18 10:45:27.136
50.4 V	2013/07/18 10:45:18.136
87.1 V	2013/07/18 10:45:10.136
128.5 V	2013/07/18 10:45:02.136

Setup (SET UP)

Configures the CW500 and measurement. See “Setup.”



Marks Appearing on the Top of the Screen

Mark	Description
	Running on batteries. Shows the battery level using four levels.
	Running on AC power.
	Screen updating is held.
	Keys are locked.
	The buzzer is turned off.
	SD memory card can be used.
	Recording to SD memory card.
	Not enough space in SD memory card to record.
	Unable to access SD memory card.
	Possible to record to internal memory. This appears when recording is started without an SD memory card inserted.
	Recording to internal memory.
	Not enough space in internal memory to record.
	Waiting to record.
	Recording measurement values.
	Recording medium is full.
	USB can be used.

Displayed Symbols

V ¹	Phase voltage	VL ¹	Line voltage	A	Current
P	Active power +: Consumption -: Regeneration	Q	Reactive power +: Lag -: Lead	S	Apparent power
PF	Power factor +: Lag -: Lead	f	Frequency		
DC1	Analog input channel 1 voltage	DC2	Analog input channel 2 voltage		
An ²	Neutral line current	PA ³	Phase angle +: Lag -: Lead	C ³	Phase advance capacitor capacitance
WP+	Active energy (consumption)	WS+	Volt-ampere hours (consumption)	WQi+	Reactive energy (lag)
WP-	Active energy (regeneration)	WS-	Volt-ampere hours (regeneration)	WQc+	Reactive energy (lead)
THD	Voltage/current distortion				
Pst (1min)	1-minute voltage flicker	Pst	Short term voltage flicker	Plt	Long term voltage flicker

- 1 The V and VL displays can be customized when 3P4W is selected.
- 2 “An” appears only when 3P4W is selected.
- 3 PA and C can be displayed by customization.

Starting and Stopping Recording

Quick Start Navigation Flowchart

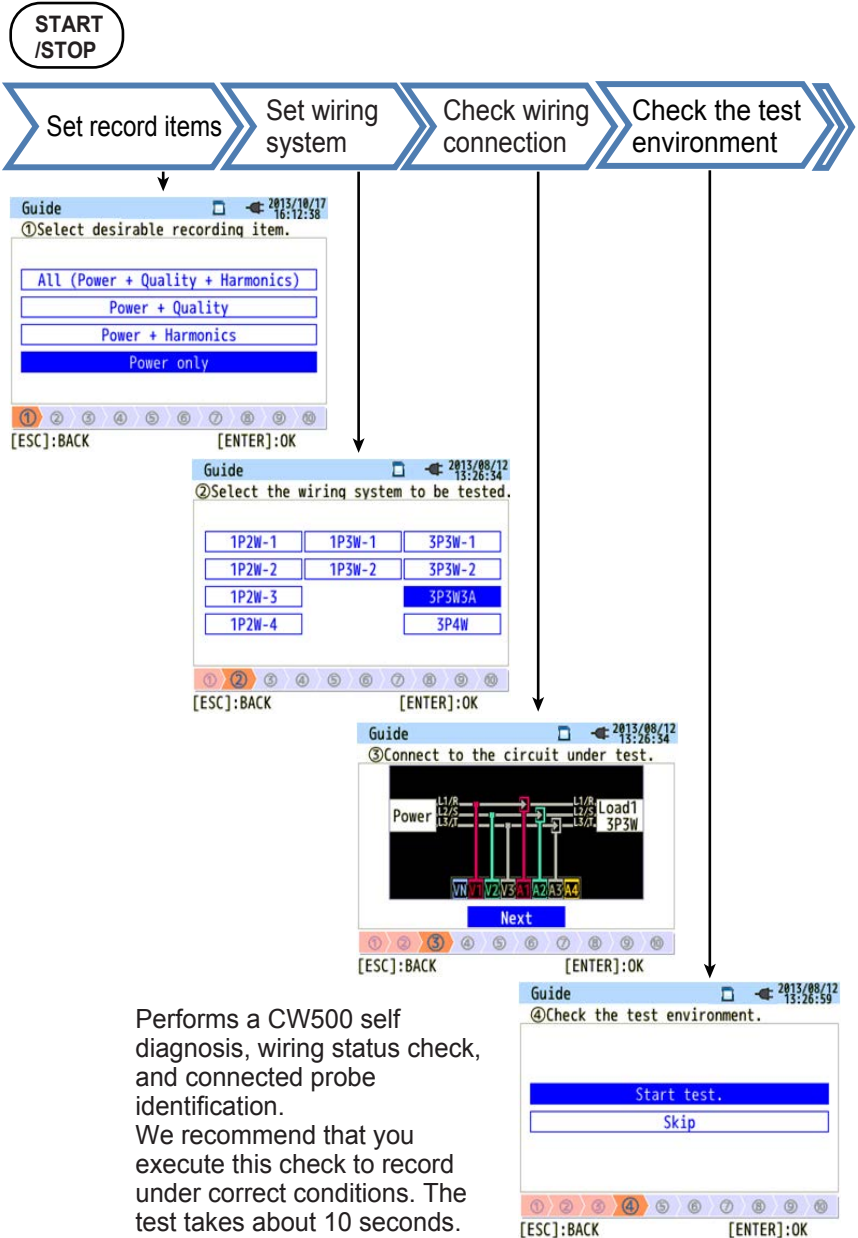

Starting and Stopping Recording

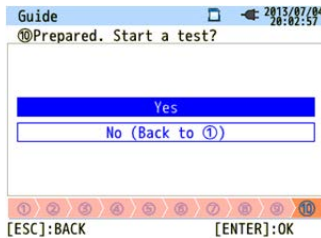
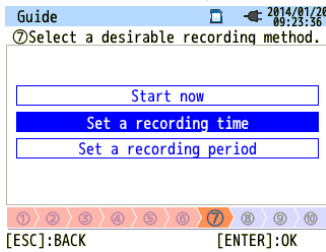
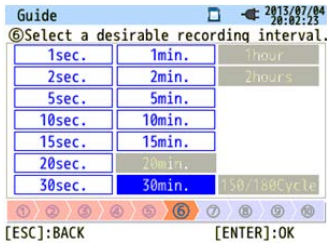

When recording starts, the screen shows REC, and the Logging LED turns green.

Stopping a Recording

To stop recording in the middle of the operation, press START/STOP, and follow the instructions on the screen.

Setting the Wiring System

You can select from the following wiring systems.

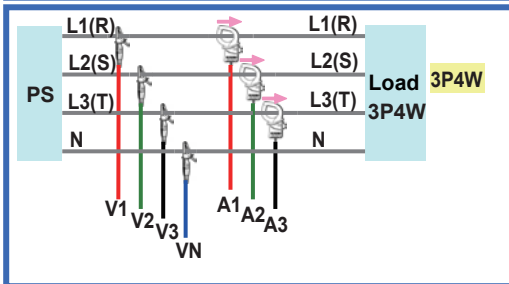
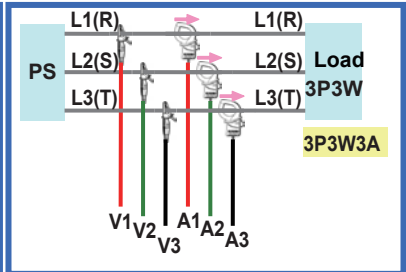
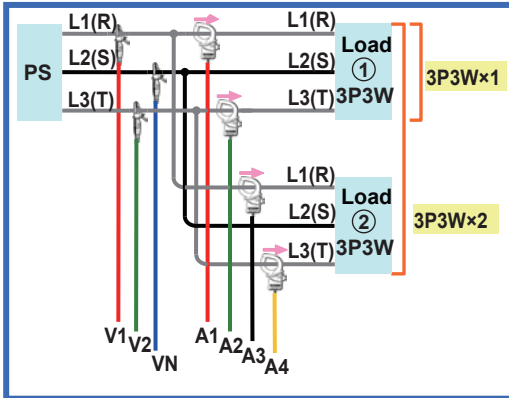
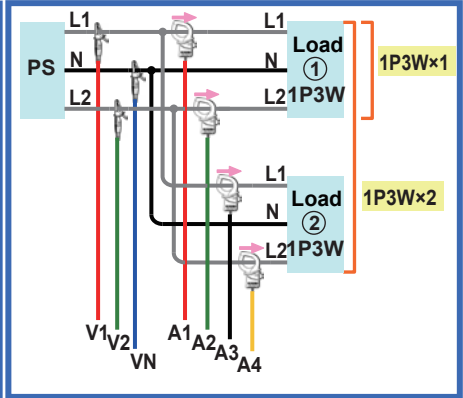
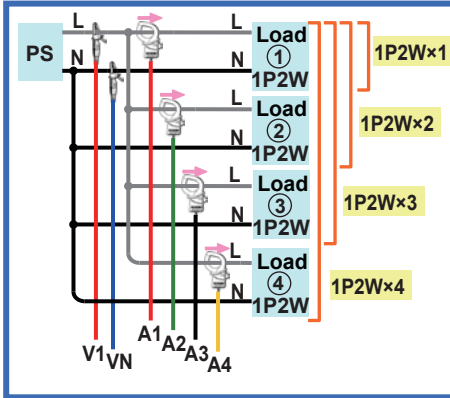

Direction to apply the current clamp-on probe

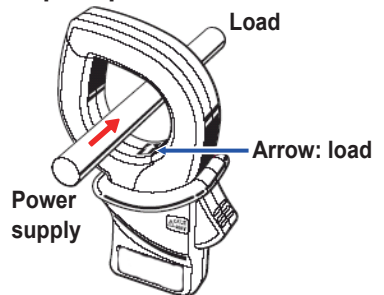

* If the clamp-on probe is applied in the reverse direction, the polarity of the active power (P) value will be reversed.

Test Environment Check

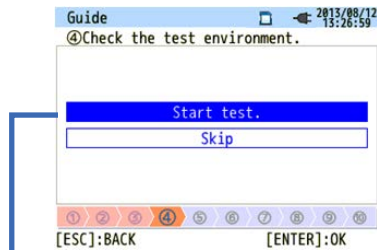

Wiring check details

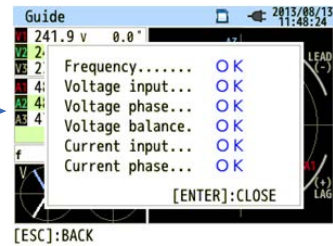

Judgment result

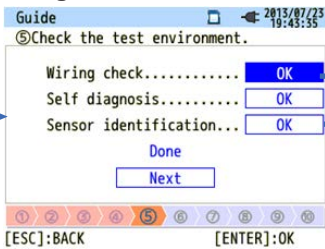

Self diagnosis details

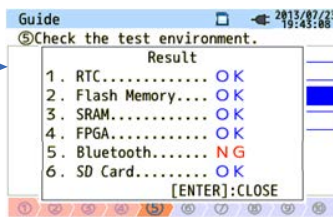

Sensor identification details

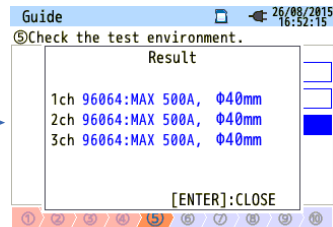

* Automatically set to the maximum ranges of the identified sensors

Displaying the Measured Values

Displaying the Power and Integrated Values (W/Wh)

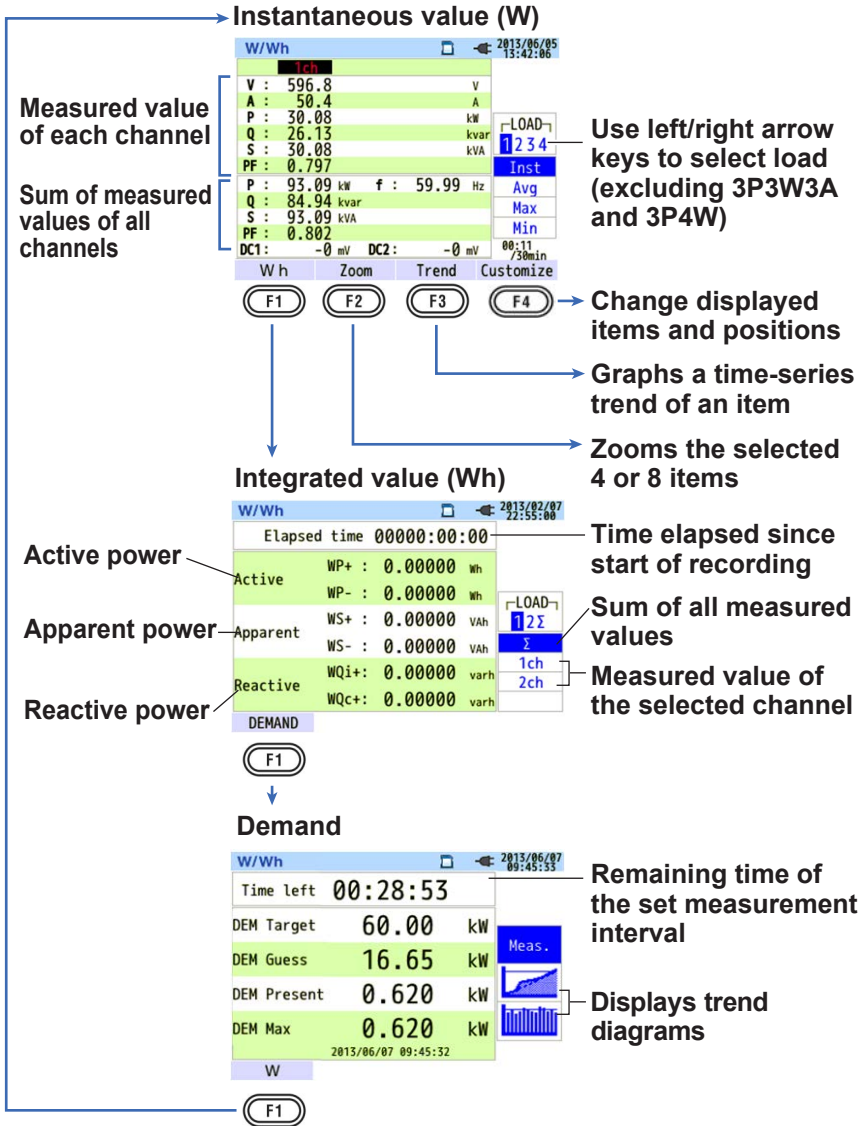

Displaying the Measured Values

Displaying Vectors (⊙)

Measured value of each item (rms value and angle of voltage and current)

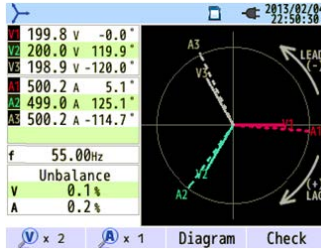

Checks wiring

Displays the set wiring

Switch line lengths in voltage and current vector diagrams

Displaying Waveforms (⊂)

Measured value of each channel

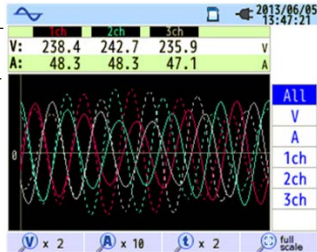

Use the up/down arrow keys to select the waveform to display.



Set to the optimum scale.

Set the time scale.

Set the vertical scale of current waveforms.

Set the vertical scale of voltage waveforms.

Displaying Harmonics ()

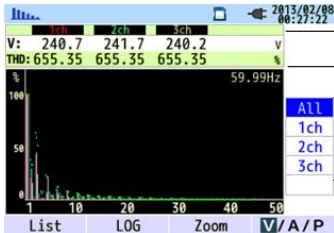

Measured value of each channel

Use the up/down arrow keys to select the waveform to display.

F1 F2 F3 F4

Switch between voltage, current, and power.

Zoom



Logarithmic

List display

	V	V1	V2	V3	THD
1	100.0	100.0	100.0		%
2	16.2	10.5	3.6		%
3	54.7	29.8	48.8		%
4	0.7	3.7	2.4		%
5	11.2	6.5	3.7		%
6	2.1	4.7	0.6		%
7	6.0	1.5	8.9		%
8	0.4	1.5	0.9		%
9	7.9	4.3	4.8		%
10	1.0	0.3	1.0		%

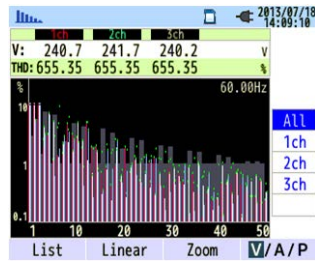

Setup

Press **SETUP** to display the following setup screen.

The screenshot shows the SETUP screen with the following menu items and values:

Category	Item	Value
Wiring	Wiring	3P3W3A
	+Clamp	+1A
Voltage	V Range	600V
	VT Ratio	1.00
	Nominal V	100V
Current	1, 2, 3ch	4ch
	Clamp	96064 96064

Callouts from the text to the right point to the following categories in the menu:

- Basic:** Common measurement items.
- Meas.:** Measurement-specific items.
- Rec.:** Save method items.
- Save:** Recorded data or CW500 setup data.
- Others:** Environment settings

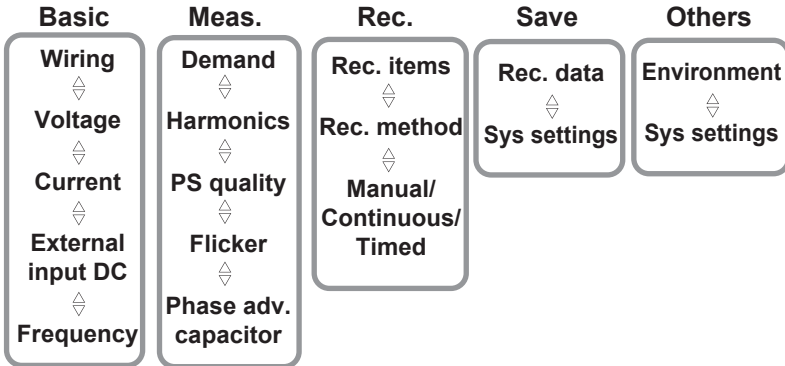

Basic setup

Setting	Description
Wiring	1P2W×1 1P3W×1 3P3W×1 1P2W×2 1P3W×2 3P3W×2 1P2W×3 3P3W3A 1P2W×4 3P4W* Current terminals that are not used in wiring can measure only rms values and harmonics.
Voltage range	600 V*/1000 V
VT ratio	0.01 to 9999.99 (default value: 1.00)
Nominal voltage	50 V to 600 V (default value: 100 V)
Clamp/Current range	Power measurement clamp-on probe 96061: 5/50A/AUTO 96062: 10/100A/AUTO 96063: 20/200A/AUTO 96064: 50/500A/AUTO* 96065: 100/1000A 96066: 300/1000/3000 A Leak current measurement clamp-on probe 96060: 2000 mA
CT ratio	0.01 to 9999.99 (default value: 1.00)
DC range	100 mV/1.000 V*/10 V
Frequency	50 Hz*/60 Hz

* Default value

Measurement Setup

Setting			Description
Demand	Measurement interval		Off/10 min/15 min/30 min*
	Judgment interval	Measurement interval 10 min/15 min	1 min/2 min/5 min
		Measurement interval 30 min	1 min/2 min/5 min/10 min*/15 min
	Target value		0.001 mW to 999.9 TW (default value: 100.0 kW)
Harmonics	THD (total harmonic distortion) calculation method		THD-F (fundamental waveform as reference)*/THD-R (total rms value as reference)
	Tolerance setting		Specified value*/customize (voltage/current)
	MAX hold		ON*/OFF
Power supply quality	Hysteresis		1 to 10% of the nominal voltage (default value: 5%)
	Transient		±50 to ±2200 V _{peak} of the nominal voltage (default value: 300%)
	Swell		100 to 200% of the nominal voltage (default value: 110%)
	Dip		0 to 100% of the nominal voltage (default value: 90%)
	Interruption		0 to 100% of the nominal voltage (default value: 10%)
	Inrush current		0 to 110% of the current range (default value: 100%)
Flicker	Filter coefficient (ramp)		230 V*/220 V/120 V/100 V
Phase advance capacitor	Target power factor		0.5 to 1 (default value: 1.000)

* Default value

Recording Setup

Setting		Description
Record items	Harmonics	Record*/Not record
	Power supply quality (events)	Record*/Not record
Record method	Interval	1 s/2 s/5 s/10 s/15 s/20 s/30 s/ 1 min/2 min/5 min/10 min/15 min/20 min/30 min*/ 1 h/2 h/150, 180 cycle (approx. 3 s)
	Start mode	Manual*/Continuous/Time
Continuous recording	Start date/time	year/month/day hour:minute (0000/00/00 00: 00)
	End date/time	year/month/day hour:minute (0000/00/00 00: 00)
Timed recording	Recording period Start—end	year/month/day (YYYY/MM/DD)— year/month/day (YYYY/MM/DD)
	Recording time slot Start—end	hour:minute (hh:mm)— hour:minute (hh:mm)

* Default value

Saved Data

Setting	Description
Recorded data	Delete data
	Transfer data
	Format
System settings	Save settings
	Load settings

Other Setup

Setting			Description
Environ. settings	Language		English*/Japanese/French/Spanish/Polish/Korean/Chinese
	Time format		YYYY/MM/DD* / MM/DD/YYYY / DD/MM/YYYY
	CH colors		White/Yellow/Orange/Red/Gray/Blue/Green The VN color only appears in the wiring diagram.
System settings	Current time		yyyy/mm/dd hh:mm:ss
	ID number		00-001 to 99-999 (default value: 00-001)
	Buzzer sound		On*/Off
	Power supply	AC power supply	OFF after 5 min/No auto power-off*
		Batteries	OFF after 5 min
	Backlight	AC power supply	OFF after 5 min*/No auto power-off
		Batteries	OFF after 2 min
System reset		Resets the system after displaying a confirmation screen.	

* Default value

The environmental settings and current time are not initialized even when the system is reset.

Specifications

General Specifications

Bluetooth function		CW500-B0: Not available CW500-B1: Available
Measurement line		Single-phase two-wire (up to four systems), single-phase three-wire, three-phase three-wire, three-phase four-wire
Measured and computed items		Voltage, current, frequency, active power, reactive power, apparent power, active energy, reactive energy, volt-ampere hours, power factor, neutral line current, demand, harmonics, power supply quality (swell, dip, interruption, transient overvoltage, inrush current, unbalance factor, IEC flicker)
Other functions		Digital output, analog DCV input
Voltage (RMS)	Range	600.0/1000 V
	Accuracy	Measurement waveform Sine wave 40 to 70 Hz at 600 V range 10% to 150% for nominal voltage 100 V or higher: nominal voltage \pm 0.5% Outside the above range and 1000 V range: \pm 0.2% rdg \pm 0.2%rng
	Effective input range	1% to 120% (rms) of each range and 200% (peak) of each range
	Display range	0.15% to 130% of each range (displays 0 for less than 0.15%)
	Crest factor	3 or less
	Voltage transient sampling speed	24 μ s
Current (RMS)	Range	96060(2A type): 2A 96061 (50A type): 5/50A/AUTO 96062 (100A type): 10/100A/AUTO 96063 (200A type): 20/200A/AUTO 96064 (500A type): 50/500A/AUTO 96065 (1000A type): 100/1000A/AUTO 96066 (3000A type): 300/1000/3000A
	Accuracy	\pm 0.2% rdg \pm 0.2% rng + current clamp-on probe accuracy (sine wave, 40 to 70 Hz)
	Effective input range	1% to 110% (rms) of each range and 200% (peak) of each range
	Display range	0.15% to 130% of each range (displays 0 for less than 0.15%)
	Crest factor	3 or less

Specifications

Active power	Accuracy	$\pm 0.3\%$ rdg $\pm 0.2\%$ rng + current clamp-on probe accuracy (power factor 1, sine wave, 40 to 70 Hz)
	Power factor influence	$\pm 1.0\%$ rdg (40 to 70 Hz, power factor 0.5 reading)
Frequency range		40 to 70 Hz
Time accuracy		within ± 5 sec/ day
Power supply		100 to 240 VAC/50 to 60 Hz, 7 VA max.
Battery type		AA type (alkaline or Ni-MH) $\times 6$ (when alkaline batteries is used with backlight turned off: approx. 3 hours, when Ni-MH batteries is used with backlight turned off: approx. 4.5 hours)
Internal memory		Flash memory (4 MB)
External memory card		SD memory card (2 GB) Format: FAT16
PC communication		CW500-B0: USB Ver. 2.0 compliant CW500-B1: USB Ver. 2.0 compliant /Bluetooth Ver. 2.1 + EDR compliant Class 2
Display		3.5 inch color TFT LCD (320 \times 240 pixels)
LCD updating		1 s ¹
Recommended calibration period		1 year
Accuracy-guaranteed temperature and humidity		23 \pm 5 °C, relative humidity: 85% RH or less (no condensation)
Operating temperature and humidity		0 to 45 °C, relative humidity: 85% RH or less (no condensation)
Storage temperature and humidity		-20 to 60 °C, relative humidity: 85% RH or less (no condensation)

Compliant standards	<p>EN 61010-1:2010 Measurement Category IV 300 V Measurement Category III 600 V Measurement Category II 1000 V Pollution degree 2² EN 61010-2-030 EN 61010-2-033 EN 61010-031:202A/A1 EN 61326-1 Class A Table2 EMC standards of Australia and New Zealand EN55011 Class A, Group 1 Korea Electromagnetic Conformity Standard (한국 전자파적합성기준) This instrument is a Class A (for industrial environment) product. Operation of this product in a residential area may cause radio interference in which case the user will be required to correct the interference. IEC 61000-4-30 Ed.2 Class S IEC 61000-4-15 IEC 61000-4-7</p>
External dimensions	120 (W) ×175 (H)×68 (D) mm
Weight	Approx. 900 g (including batteries)
Standard accessories	Voltage probe, USB cable, power cord, carrying case, SD memory card 2 GB, Getting Started Guide, AA alkaline batteries, input terminal plate, PC software, cable markers

- 1 Due to the measurement calculation processing, there may be a delay of up to 2 s until the actual measurement is reflected on the screen. There are no delays in the recorded data or timestamps.
- 2 Pollution degree refers to the degree of adhesion of a solid, liquid, or gas which deteriorates withstand voltage or surface resistivity. Pollution degree 2 applies to normal indoor atmospheres (with only non-conductive pollution).

Specifications

Wiring

Current channels (A2 to A4) not related to the wiring can be measured independently.

Wiring	Input channel	
	Voltage	Current
Single-phase two-wire, 1 system (1P2W-1)	VN-V1	A1
Single-phase two-wire, 2 systems (1P2W-2)	VN-V1	A1 A2
Single-phase two-wire, 3 systems (1P2W-3)	VN-V1	A1, A2, A3
Single-phase two-wire, 4 systems (1P2W-4)	VN-V1	A1, A2, A3, A4
Single-phase three-wire, 1 system (1P3W-1)	VN-V1, V2	A1, A2
Single-phase three-wire, 2 systems (1P3W-2)	VN-V1, V2	A1, A2, A3, A4
Three-phase three-wire, 1 system (3P3W-1)	VN-V1, V2	A1, A2
Three-phase three-wire, 2 systems (3P3W-2)	VN-V1, V2	A1, A2, A3, A4
Three-phase three-wire (3P3W3A)	V1-V2, V2-V3, V3-V1	A1, A2, A3
Three-phase four-wire (3P4W)	VN-V1, V2, V3	A1, A2, A3

External communication function

USB (USB cable length: 2m max.)

Connector	mini-B
Communication method	USB Ver2.0
USB identification no.	Vendor ID: 0B21(Hex) Product ID: 005C(Hex) Serial no.: 0+7 digit individual no.
Communication speed	12Mbps (full-speed)

Bluetooth® (Option)

Transmission mode	Bluetooth® Ver2.1+EDR Class2
Profile	SPP
Frequency	2402 to 2480 MHz
Modulation	GFSK (1 Mbps), $\pi/4$ -DQPSK (2 Mbps), 8DPSK (3 Mbps)
Transmission system	Frequency hopping

Digital Output Terminals

Connector type	Feed-through screwless terminal block 6 poles (black/red/gray ML800-S1H-6P)
Output type	Open collector output, low active
Input voltage	0 to 30 V, 50 mAmax, 200 mW
Output voltage	High: 4.0 V to 5.0 V Low: 0.0 to 1.0 V

Measurement Specifications

Number of Analysis Data Values of Each Measurement Item

Items whose measurement time period is 200 ms (50 Hz: 10 cycles, 60 Hz: 12 cycles) and calculated using 8192 points of data
Frequency, rms voltage, rms current, active power, apparent power, reactive power, power factor, phase advance capacitor

Items whose measurement time period is 200 ms (50 Hz: 10 cycles, 60 Hz: 12 cycles) and calculated using 2048 points of data
Voltage unbalance factor, current unbalance factor, rms harmonic voltage (percentage content), rms harmonic current (percentage content), harmonic reactive power, total harmonic voltage distortion (THDV-F/R), total harmonic current distortion (THDA-F/R), harmonic voltage phase angle, harmonic current phase angle, harmonic voltage-current phase difference

Items calculated using about 819 data points for 50 Hz and about 682 data points for 60 Hz where one measurement period is a single waveform that overlaps every half a waveform.
Voltage dip, voltage swell, interruption, inrush current

Items whose instantaneous measurements at 40.96 ksps are displayed
Voltage waveform, current waveform, external input voltage

Instantaneous Measurement Items

Frequency f [Hz]

Display digits	4 digits
Accuracy	±2 dgt (40.00 Hz to 70.00 Hz, V1 range 10% to 110%, sine wave)
Display range	10.00 to 99.99 Hz
Signal source	V ₁ (fixed)

10-second average frequency f10 [Hz]

Display digits	4 digits
Measurement system	Complies with IEC61000-4-30
Accuracy	±2 dgt (40.00 Hz to 70.00 Hz, V1 range 10% to 110%, sine wave)
Display range	10.00 to 99.99 Hz
Signal source	V ₁ (fixed)

Specifications

Rms voltage V [Vrms]

Range	600.0/1000 V
Display digits	4 digits
Effective input range	1% to 120% (rms) of range and 200% (peak) of range
Display range	0.15% to 130% of range (displays 0 for less than 0.15%)
Crest factor	3 or less
Measurement system	Complies with IEC61000-4-30
Accuracy	Measurement waveform Sine wave 40 to 70 Hz at 600 V range 10% to 150% for nominal voltage 100 V or higher: nominal voltage $\pm 0.5\%$ Outside the above range and 1000 V range: $\pm 0.2\%$ rdg $\pm 0.2\%$ rng
Input impedance	Approx. 1.67 M Ω
Equation	$V_c = \sqrt{\left(\frac{1}{n} \left(\sum_{i=0}^{n-1} (V_{ci})^2 \right) \right)}$ i: sampling point No* n: number of samples over 10 cycles, 12 cycles c: measurement channel * For 50 Hz, calculation is performed on 10 waveforms (8192 points). For 60 Hz, calculation is performed on 12 waveforms (8192 points).
1P2W-1 to 4	V_1
1P3W-1, 2	V_1, V_2
3P3W-1, 2	Line voltage $V_{12}, V_{23}, V_{31} = \sqrt{(V_{23}^2 + V_{12}^2 + 2 \times V_{23} \times V_{12} \times \cos \theta V)}$ $\theta V = \text{relative angle } V_{12}, V_{23}$
3P3W3A	Line voltage V_{12}, V_{23}, V_{31}
3P4W	Phase voltage V_1, V_2, V_3 Line voltage $V_{12} = \sqrt{(V_1^2 + V_2^2 - 2 \times V_1 \times V_2 \times \cos \theta V_1)}$ $V_{23} = \sqrt{(V_2^2 + V_3^2 - 2 \times V_2 \times V_3 \times \cos \theta V_2)}$ $V_{31} = \sqrt{(V_3^2 + V_1^2 - 2 \times V_3 \times V_1 \times \cos \theta V_3)}$ $\theta V_1 = \text{phase angle } V_1, V_2, \theta V_2 = \text{phase angle } V_2, V_3, \theta V_3 = \text{phase angle } V_3, V_1$

Rms current A [Arms]

Range	96060 (2A type) 2A 96061 (50A type) 5/50A/AUTO 96062 (100A type) 10/100A/AUTO 96063 (200A type) 20/200A/AUTO 96064 (500A type) 50/500A/AUTO 96065 (1000A type) 100/1000A/AUTO 96066 (3000A type) 300/1000/3000A
Display digits	4 digits
Effective input range	1% to 110% (rms) of range and 200% (peak) of range
Display range	0.15% to 130% of each range (displays 0 for less than 0.15%)
Crest factor	3 or less
Measurement system	Complies with IEC61000-4-30
Accuracy	Measurement waveform Sine wave 40 to 70 Hz ±0.2% rdg ± 0.2% rng + current clamp-on probe accuracy
Input impedance	Approx. 100 kΩ
Equation	$A_c = \sqrt{\left(\frac{1}{n} \left(\sum_{i=0}^{n-1} (A_{ci})^2 \right) \right)}$ <p>c: measurement channel A1 , A2 , A3 , A4 i: sampling point No* n: number of samples over 10 cycles, 12 cycles</p> <p>* For 50 Hz: calculation is performed on 10 waveforms (8192 points). For 60 Hz, calculation is performed on 12 waveforms (8192 points).</p> <p>* A₃ for 3P3W-1, 2 wiring is calculated from the rms current. $A_3 = \sqrt{A_1^2 + A_2^2 + 2 \times A_1 \times A_2 \times \cos\theta A}$ $\theta A = \text{relative angle } A_1, A_2$</p>

Specifications

Active power P [W]

		Range				
Current		96060		96061		96062
	Voltage	2.000 A		50.00 A	5.000 A	100.0 A 10.00 A
1000V		2000		50.00 k	5000	100.0 k 10.00 k
600.0V		30.00 k		30.00 k	3000	60.0 k 6000
Current		96063		96064		96065
	Voltage	200.0 A	20.00 A	500 A	50.00 A	1000 A 100.0 A
1000V		200.0 k	20.00 k	500 k	50.00 k	1000 k 100.0 k
600.0V		120.0 k	12.00 k	300.0 k	30.00 k	600.0 k 60.00 k
Current		96066				
	Voltage	3000 A	1000 A	300.0 A		
1000V		3000 k	1000 k	300.0 k		
600.0V		1800 k	600.0 k	180.0 k		
Display digits		4 digits				
Accuracy		±0.3% rdg ± 0.2% rng+ current clamp-on probe accuracy (power factor 1, sine wave, 40 to 70 Hz) * The sum value is the total value of all used channels.				
Power factor influence		±1.0% rdg (40 Hz to 70 Hz, power factor 0.5)				
Polarity display		Consumption (inflow): + (no sign), regeneration (outflow):-				
Equation		$P_c = \frac{1}{n} \left(\sum_{i=0}^{n-1} (V_{ci} \times A_{ci}) \right)$			c: measurement channel i: sampling point No* n: Number of samples	
		*For 50 Hz: calculation is performed on 10 waveforms (8192 points). For 60 Hz, calculation is performed on 12 waveforms (8192 points).				
1P2W-1 to 4		$P_1, P_2, P_3, P_4, P_{sum} = P_1+P_2+P_3+P_4$				
1P3W(3P3W)-1 to 2		$P_1, P_2, P_{sum1} = P_1+P_2$				
		$P_3, P_4, P_{sum2} = P_3+P_4$				
		$P_{sum} = P_{sum1} + P_{sum2}$				
3P3W3A		$P_1, P_2, P_3, P_{sum} = P_1+P_2+P_3$ * Use the phase voltage.				
3P4W		$P_1, P_2, P_3, P_{sum} = P_1+P_2+P_3$				

External input voltage DCi [V]

Range	100.0mV/1000mV/10.00V
Display digits	4 digits
Effective input range	1% to ±100% (DC) of each range
Display range	0.3% to ±110% of range (displays 0 for less than 0.3%)
Accuracy	±0.5%f.s (DC)
Input impedance	Approx. 225.6 kΩ
Saved item	External input voltage

Computed Items

Apparent power S [VA]

Range	Same as active power
Display digits	Same as active power
Accuracy	Computed value from each measured value ± 1 dgt (the total value is ±3 dgt)
Sign	No polarity
Equation	$S_c = V_c \times A_c$ When $P_c > S_c$, $P_c = S_c$. c: measurement channel
1P2W-1 to 4	$S_1, S_2, S_3, S_4, S_{sum} = S_1 + S_2 + S_3 + S_4$
1P3W-1, 2	$S_1, S_2, S_{sum1} = S_1 + S_2$
	$S_3, S_4, S_{sum2} = S_3 + S_4$
	$S_{sum} = S_{sum1} + S_{sum2}$
3P3W-2	$S_1, S_2, S_{sum1} = \sqrt{3}/2 (S_1 + S_2)$
	$S_3, S_4, S_{sum2} = \sqrt{3}/2 (S_3 + S_4)$
	$S_{sum} = S_{sum1} + S_{sum2}$
3P3W3A	$S_1, S_2, S_3, S_{sum} = S_1 + S_2 + S_3$ * Use the phase voltage.
3P4W	$S_1, S_2, S_3, S_{sum} = S_1 + S_2 + S_3$

Specifications

Reactive power Q [Var]

Range	Same as active power
Display digits	Same as active power
Accuracy	Computed value from each measured value ± 1 dgt (the total value is ± 3 dgt)
Sign	Minus sign: Leading phase (current phase relative to the voltage) Plus sign (no sign): Lagging phase (") For the polarity sign, the harmonic reactive power is determined for each measurement channel, and a sign opposite to the fundamental waveform is attached.
Equation	$Q_c = sign \sqrt{S_c^2 - P_c^2}$ sign: polarity sign, c: measurement channel
1P2W-1 to 4	$Q_1, Q_2, Q_3, Q_4, Q_{sum} = Q_1+Q_2+Q_3+Q_4$
1P3W(3P3W) -1 to 2	$Q_1, Q_2, Q_{sum1} = Q_1+Q_2$
	$Q_3, Q_4, Q_{sum2} = Q_3+Q_4$
	$Q_{sum} = Q_{sum1}+Q_{sum2}$
3P3W3A(3P4W)	$Q_1, Q_2, Q_3, Q_{sum} = Q_1+Q_2+Q_3$

Power factor PF

Display range	-1.000 to 0.000 to 1.000
Accuracy	Computed value from each measured value ± 1 dgt (the total value is ± 3 dgt)
Sign	Minus sign: Leading phase Plus sign (no sign): Lagging phase * For the polarity sign, the harmonic reactive power is determined for each measurement channel, and a sign opposite to the fundamental waveform is attached.
Equation	$PF_c = sign \left \frac{R_c}{S_c} \right $ sign: polarity sign, c: measurement channel,
1P2W-1 to 4	$PF_1, PF_2, PF_3, PF_4, PF_{sum}$
1P3W(3P3W) -1 to 2	PF_1, PF_2, PF_{sum1}
	PF_3, PF_4, PF_{sum2}
	PF_{sum}
3P3W3A(3P4W)	$PF_1, PF_2, PF_3, PF_{sum}$

Neutral current An [A] *Only for 3P4W wiring

Range	Same as rms current
Display digits	Same as rms current
Display range	Same as rms current
Equation	
$A_n = \sqrt{\{A_1 + A_2 \cos(\theta_2 - \theta_1) + A_3 \cos(\theta_3 - \theta_1)\}^2 + \{A_2 \sin(\theta_2 - \theta_1) + A_3 \sin(\theta_3 - \theta_1)\}^2}$	
* $\theta_1, 2,$ and 3 denote the phase difference between V_1 and $A_1, 2, 3,$ respectively.	

Voltage unbalance factor Uunb [%]

Display digits	5 digits
Display range	0.00% to 100.00%
Wiring	3P3W, 3P4W
Measurement system	Complies with IEC61000-4-30
Accuracy	Measurement waveform $\pm 0.3\%$ for a 50 to 60 Hz sine wave (0% to 5% for IEC61000-4-30 testing)
Equation	$V_{umb} = \sqrt{\left(\frac{1 - \sqrt{3 - 6\beta}}{1 + \sqrt{3 - 6\beta}}\right)} \times 100 \quad \beta = \frac{V_{12}^4 + V_{23}^4 + V_{31}^4}{(V_{12}^2 + V_{23}^2 + V_{31}^2)^2}$ <p>* Uses the first harmonic of the harmonic voltage. * For 3P4W, phase voltage is converted to line voltage for calculation. $V_{12} = V_1 - V_2, V_{23} = V_2 - V_3, V_{31} = V_3 - V_1$</p>

Current unbalance factor Aunb [%]

Display digits	5 digits
Display range	0.00% to 100.00%
Wiring	3P3W, 3P4W
Equation	$I_{umb} = \sqrt{\left(\frac{1 - \sqrt{3 - 6\beta}}{1 + \sqrt{3 - 6\beta}}\right)} \times 100 \quad \beta = \frac{A_{12}^4 + A_{23}^4 + A_{31}^4}{(A_{12}^2 + A_{23}^2 + A_{31}^2)^2}$ <p>* Uses the first harmonic of the harmonic current. * For 3P4W, phase current is converted to line current for calculation. $A_{12} = A_1 - A_2, A_{23} = A_2 - A_3, A_{31} = A_3 - A_1$</p>

Specifications

Phase advance capacitor

Display digits	4 digits, unit: nF, μF, mF, kvar
Display range	0.000 nF to 9999 F, 0.000 kvar to 9999 kvar
Equation	$C_c = P_c \times \left(\sqrt{\frac{1}{PF_c^2} - 1} - \sqrt{\frac{1}{PF_{c_Target}^2} - 1} \right) [kvar]$ $= \frac{P_c \times 10^9}{2\pi f \times V_c^2} \times \left(\sqrt{\frac{1}{PF_c^2} - 1} - \sqrt{\frac{1}{PF_{c_Target}^2} - 1} \right) [\mu F]$ <p> C_c : capacitance needed for improvement P_c : load power (active power) [kW] f : frequency V_c : rms voltage PF_c : measured power factor PF_{c_Target} : power factor after improvement (target) c : measurement channel </p>
1P2W-1 to 4	$C_1, C_2, C_3, C_4, C_{sum} = C_1 + C_2 + C_3 + C_4$
1P3W(3P3W)	$C_1, C_2, C_{sum1} = C_1 + C_2$
-1 to 2	$C_1, C_2, C_{sum2} = C_3 + C_4$
	$C_{sum} = C_{sum1} + C_{sum2}$
3P3W3A(3P4W)	$C_1, C_2, C_3, C_{sum} = C_1 + C_2 + C_3$

Integrated Measurement Items

Power Consumption (When P≥0)

Active energy +WP [Wh]

Display digits	6 digits, unit: m, k, M, G, T (match with +WS)
Display range	0.00000 mWh to 9999.99 TWh (match with +WS) *OL is displayed when the display range is exceeded.
Equation	$+WP_c = \frac{1}{h} \left(\sum_i (+P_{ci}) \right)$ <p> h: integration time (3600 s), c: measurement channel, i: data point No. </p>
1P2W-1 to 4	$+WP_1, +WP_2, +WP_3, +WP_4, +WP_{sum}$
1P3W(3P3W)	$+WP_1, +WP_2, +WP_{sum1}$
-1 to 2	$+WP_3, +WP_4, +WP_{sum2}$
	$+WP_{sum}$
3P3W3A(3P4W)	$+WP_1, +WP_2, +WP_3, +WP_{sum}$

Volt-ampere hours +WS [VAh]

Display digits	6 digits, unit: m, k, M, G, T
Display range	0.00000 mVAh to 9999.99 TVAh * OL is displayed when the display range is exceeded.
Equation	$+WS_c = \frac{1}{h} \left(\sum_i (S_{ci}) \right)$ <p>h: integration time (3600 s), c: measurement channel, i: data point No.</p>
1P2W-1 to 4	+WS ₁ , +WS ₂ , +WS ₃ , +WS ₄ , +WS _{sum}
1P3W(3P3W)	+WS ₁ , +WS ₂ , +WS _{sum1}
-1 to 2	+WS ₃ , +WS ₄ , +WS _{sum2}
	+WS _{sum}
3P3W3A(3P4W)	+WS ₁ , +WS ₂ , +WS ₃ , +WS _{sum}

Reactive energy +WQ [Varh]

Display digits	6 digits, unit: m, k, M, G, T (match with +WS)
Display range	0.00000 mvarh to 9999.99 Tvarh (match with +WS) * OL is displayed when the display range is exceeded.
Equation	<p>Leading phase</p> $+WQ_{c_c} = \frac{1}{h} \left(\sum_i (+Q_{ci}) \right),$ <p>Lagging phase</p> $+WQ_{i_c} = \frac{1}{h} \left(\sum_i (-Q_{ci}) \right),$ <p>h: integration time (3600 s), n: system No., c: measurement channel, i: data point No., * Lagging phase: when Q ≥ 0, leading phase: when Q < 0</p>
1P2W-1 to 4	+WQ ₁ , +WQ ₂ , +WQ ₃ , +WQ ₄ , +WQ _{sum}
1P3W(3P3W)	+WQ ₁ , +WQ ₂ , +WQ _{sum1}
-1 to 2	+WQ ₃ , +WQ ₄ , +WQ _{sum2}
	+WQ _{sum}
3P3W3A(3P4W)	+WQ ₁ , +WQ ₂ , +WQ ₃ , +WQ _{sum}

Specifications

Regenerative Power (when P<0)

Active energy -WP [Wh]

Display digits	6 digits, unit: m, k, M, G, T (match with +WS)
Display range	0.00000 mWh to 9999.99 TWh (match with +WS) * OL is displayed when the display range is exceeded.
Equation	$-WP_c = \frac{1}{h} \left(\sum_i (-P_{ci}) \right)$ <p>h: integration time (3600 s), c: measurement channel, i: data point No.</p>
1P2W-1 to 4	$-WP_1, -WP_2, -WP_3, -WP_4, -WP_{sum}$
1P3W(3P3W) -1 to 2	$-WP_1, -WP_2, -WP_{sum1}$ $-WP_3, -WP_4, -WP_{sum2}$ $-WP_{sum}$
3P3W3A(3P4W)	$-WP_1, -WP_2, -WP_3, -WP_{sum}$

Volt-ampere hours -WS [VAh]

Display digits	6 digits, unit: m, k, M, G, T (match with +WS)
Display range	0.00000 mVAh to 9999.99 TVAh (match with +WS) * OL is displayed when the display range is exceeded.
Equation	$-WS_c = \frac{1}{h} \left(\sum_i (S_{ci}) \right)$ <p>h: integration time (3600 s), c: measurement channel, i: data point No.,</p>
1P2W-1 to 4	$-WS_1, -WS_2, -WS_3, -WS_4, -WS_{sum}$
1P3W(3P3W) -1 to 2	$-WS_1, -WS_2, -WS_{sum1}$ $-WS_3, -WS_4, -WS_{sum2}$ $-WS_{sum}$
3P3W3A(3P4W)	$-WS_1, -WS_2, -WS_3, -WS_{sum}$

Reactive energy -WQ [Varh]

Display digits	6 digits, unit: m, k, M, G, T (match with +WS)
Display range	0.00000 mvarh to 9999.99 Tvarh (match with +WS) * OL is displayed when the display range is exceeded.
Equation	Leading phase $-WQc_c = \frac{1}{h} \left(\sum_i (+Q_{ci}) \right)$
	Lagging phase $-WQi_c = \frac{1}{h} \left(\sum_i (-Q_{ci}) \right)$
	h: integration time (3600 s), n: system No., c: measurement channel, i: data point No., *Lagging phase: <i>when Q ≥ 0</i> , leading phase: <i>when Q < 0</i>
1P2W-1 to 4	$-WQ_1, -WQ_2, -WQ_3, -WQ_4, -WQ_{sum}$
1P3W(3P3W) -1 to 2	$-WQ_1, -WQ_2, -WQ_{sum1}$
	$-WQ_3, -WQ_4, -WQ_{sum2}$
	$-WQ_{sum}$
3P3W3A(3P4W)	$-WQ_1, -WQ_2, -WQ_3, -WQ_{sum}$

Integration time

Display range	00:00:00 (0 s) to 99:59:59 (99 hours 59 minutes 59 seconds), 0100: 00 to 9999:59 (9999 hours 59 minutes), 010000 to 999999 (999999 hours) * The display switches between these modes as necessary.
----------------------	---

DEMAND Measurement Items

Target value (DEM_{Target})

Display digits	4 digits
Displayed unit	m, k, M, G, T
Display range	0.000 mW (VA) to 999.9 TW (VA) * Fixed to the specified value

Specifications

Estimated value (DEM_{Guess})

Display digits	6 digits
Displayed unit	m, k, M, G, T (match with DEM _{Target})
Display range	0.00000 mW (VA) to 99999.9 TW (VA) * Match the decimal place with DEM _{Target} . * OL is displayed when the display range is exceeded.
Equation	DEM _{Guess} = ΣDEM × measurement interval time/time from measurement start to present

Current value, demand measurement (ΣDEM)

Display digits	6 digits, unit: m, k, M, G, T *Match with DEM _{Target}
Displayed unit	m, k, M, G, T *Match with DEM _{Target}
Display range	0.00000 mW (VA) to 99999.9 TW (VA) * Match the decimal place with DEM _{Target} . * OL is displayed when the display range is exceeded.
Equation	ΣDEM = (Integrated value of "+WPsum (+WSsum)" from measurement start to present) × $\frac{1 \text{ hour}}{\text{Measurement interval time}}$

Load factor

Display digits	6 digits
Display range	0.00 to 9999.99% * OL is displayed when the display range is exceeded.
Equation	ΣDEM / DEM _{Target}

Estimation

Display digits	6 digits
Display range	0.00 to 9999.99% * OL is displayed when the display range is exceeded.
Equation	DEM _{Guess} / DEM _{Target}

Harmonic Measurement Items

Measurement system	Digital PLL synchronization
Measurement method	Adds the intermediate harmonic component adjacent to integer-order harmonics after harmonic analysis and displays the result
Effective frequency range	40 to 70 Hz
Harmonics analyzed	1 to 50 harmonic order
Window span	10 cycles for 50 Hz, 12 cycles for 60 Hz
Window type	Rectangular
Number of analyzed points	2048
Analysis rate	Once every 200 ms at 50 or 60 Hz

Rms harmonic voltage V_k [V_{rms}]

Range	Same as rms voltage
Display digits	Same as rms voltage
Display range	Same as rms voltage * Percentage content 0.0% to 100.0% Percentage to the fundamental waveform
Measurement system	Complies with IEC61000-4-30, IEC61000-4-7, IEC61000-2-4 The analysis window span is 10/12 cycles at 50/60 Hz. The measurement includes the intermediate harmonic component adjacent to the harmonics being analyzed.
Accuracy	The IEC61000-2-4 Class3 accuracy is defined in the 10% to 100% input range at the 600 V range. 3% or higher for nominal voltage 100 V or higher: ±10%rdg Less than 3% for nominal voltage 100 V or higher: nominal voltage ± 0.3% 1000 V Range: ±0.2%rdg±0.2% rng
Equation	$V_{ck} = \sqrt{\sum_{n=-1}^1 (V_c(10k+n)_r)^2 + (V_c(10k+n)_i)^2}$ $\text{Percentage content} = \frac{V_{ck} \times 100}{V_{c1}}$ <p>c: measurement channel, k: harmonic order, V_r: real component after taking the FFT of the voltage, V_i: imaginary component after taking the FFT of the voltage The measurement interval of the equation is 10 cycles. For 12 cycles, replace "10k+n" with "12k+n" in the equation.</p>
1P2W-1 to 4	V _{1k}
1P3W-1, 2	V _{1k} , V _{2k}
3P3W-1, 2	Line voltage V _{12k} , V _{32k}
3P3W3A	Line voltage V _{12k} , V _{23k} , V _{31k}
3P4W	V _{1k} , V _{2k} , V _{3k}

Specifications

Rms harmonic current Ak [Arms]

Range	Same as rms current
Display digits	Same as rms current
Display range	Same as rms current * Percentage content 0.0% to 100.0% Percentage to the fundamental waveform
Measurement system	Complies with IEC61000-4-7, IEC61000-2-4 The analysis window span is 10/12 cycles at 50/60 Hz. The measurement includes the intermediate harmonic component adjacent to the harmonics being analyzed.
Accuracy	The IEC61000-2-4 Class3 accuracy is defined in the 10% to 100% input range of the measurement range. 10% or higher of the range maximum: ±10% rdg + current clamp-on probe accuracy Less than 10% of the range maximum: Range maximum ± 1.0% + current clamp-on probe accuracy
Equation	$A_{ck} = \sqrt{\sum_{n=-1}^1 (A_c(10k+n)_r)^2 + (A_c(10k+n)_i)^2}$ $\text{Percentage content} = \frac{A_{ck} \times 100}{A_{c1}}$ <p>c: measurement channel $A_{1k}, A_{2k}, A_{3k}, A_{4k}$, k: harmonic order r: real component after taking the FFT, i: imaginary component after taking the FFT The measurement interval of the equation is 10 cycles. For 12 cycles, replace “10k+n” with “12k+n” in the equation.</p>

Harmonic power Pk [W]

Range	Same as active power
Display digits	Same as active power
Display range	Same as active power * Percentage content 0.0% to 100.0% Percentage to the absolute value of the fundamental waveform
Measurement system	Complies with IEC61000-4-7
Accuracy	±0.3% rdg ± 0.2% rng + current clamp-on probe accuracy (power factor 1, sine wave, 50/60 Hz) * The sum value is the total value of all used channels.
Equation	$P_{Ck} = V_{C(10k)r} \times A_{C(10k)r} - V_{C(10k)i} \times A_{C(10k)i}$ $\text{Percentage content} = \frac{P_{Ck} \times 100}{P_{C1}}$ <p>c: measurement channel, k: harmonic order, r: real component after taking the FFT, i: imaginary component after taking the FFT The measurement interval of the above equation is 10 cycles. For 12 cycles, replace "(10k)" with "(12k)" in the equation.</p>
1P2W-1 to 4	$P_{1k}, P_{2k}, P_{3k}, P_{4k}, P_{sumk} = P_{1k} + P_{2k} + P_{3k} + P_{4k}$
1P3W-1, 2	$P_{1k}, P_{2k}, P_{sum1k} = P_{1k} + P_{2k}$
	$P_{3k}, P_{4k}, P_{sum2k} = P_{3k} + P_{4k}$
	$P_{sumk} = P_{sum1k} + P_{sum2k}$
3P3W-1, 2	$P_{1k}, P_{2k}, P_{sum1k} = P_{1k} + P_{2k}$
	$P_{3k}, P_{4k}, P_{sum2k} = P_{3k} + P_{4k}$
	$P_{sumk} = P_{sum1k} + P_{sum2k}$
3P3W3A	Phase voltage $P_{1k}: V_1 = (V_{12} - V_{31})/3, P_{2k}: V_2 = (V_{23} - V_{12})/3,$ $P_{3k}: V_3 = (V_{31} - V_{23})/3, P_{sumk} = P_{1k} + P_{2k} + P_{3k}$
3P4W	$P_{1k}, P_{2k}, P_{3k}, P_{sumk} = P_{1k} + P_{2k} + P_{3k}$

Specifications

Harmonic reactive power Qk [var] (used only in internal computation)

Equation	$P_{Ck} = V_{c(10k)r} \times A_{c(10k)i} - V_{c(10k)i} \times A_{c(10k)r}$ <p>c: measurement channel, k: harmonic order, r: real component after taking the FFT, i: imaginary component after taking the FFT The measurement interval of the above equation is 10 cycles. For 12 cycles, replace "(10k)" with "(12k)" in the equation.</p>
1P2W-1 to 4	$Q_{1k}, Q_{2k}, Q_{3k}, Q_{4k}, Q_{sumk} = Q_{1k} + Q_{2k} + Q_{3k} + Q_{4k}$
1P3W-1, 2	$Q_{1k}, Q_{2k}, Q_{sum1k} = Q_{1k} + Q_{2k}$
	$Q_{3k}, Q_{4k}, Q_{sum2k} = Q_{3k} + Q_{4k}$
	$Q_{sumk} = Q_{sum1k} + Q_{sum2k}$
3P3W-1, 2	$Q_{1k}, Q_{2k}, Q_{sum1k} = Q_{1k} + Q_{2k}$
	$Q_{3k}, Q_{4k}, Q_{sum2k} = Q_{3k} + Q_{4k}$
	$Q_{sumk} = Q_{sum1k} + Q_{sum2k}$
3P3W3A	Phase voltage $Q_{1k}: V_1 = (V_{12} - V_{31}) / 3, Q_{2k}: V_2 = (V_{23} - V_{12}) / 3,$ $Q_{3k}: V_3 = (V_{31} - V_{23}) / 3, Q_{sumk} = Q_{1k} + Q_{2k} + Q_{3k}$
3P4W	$Q_{1k}, Q_{2k}, Q_{3k}, Q_{sumk} = Q_{1k} + Q_{2k} + Q_{3k}$

Total harmonic voltage distortion THDVF [%]

Display digits	4 digits
Display range	0.0% to 100.0%
Equation	$THDVF_c = \frac{\sqrt{\sum_{k=2}^{50} (V_{ck})^2}}{V_{c1}} \times 100$ <p>c: measurement channel V: harmonic voltage k: harmonic order</p>
1P2W-1 to 4	$THDVF_1$
1P3W-1, 2	$THDVF_1, THDVF_2$
3P3W-1, 2	Line voltage $THDVF_{12}, THDVF_{32}$
3P3W3A	Line voltage $THDVF_{12}, THDVF_{23}, THDVF_{31}$
3P4W	$THDVF_1, THDVF_2, THDVF_3$

Total harmonic current distortion THDAF [%]

Display digits	4 digits
Display range	0.0% to 100.0%
Equation	$THDAF_c = \frac{\sqrt{\sum_{k=2}^{50} (A_{ck})^2} \times 100}{A_{c1}}$ <p>c: measurement channel <i>THDAF₁, THDAF₂, THDAF₃, THDAF₄</i> A: harmonic current k: harmonic order</p>

Total harmonic voltage distortion THDVR [%]

Display digits	4 digits
Display range	0.0% to 100.0%
Equation	$THDAR_c = \frac{\sqrt{\sum_{k=2}^{50} (A_{ck})^2} \times 100}{\sqrt{\sum_{k=1}^{50} (A_{ck})^2}}$ <p>c: measurement channel V: harmonic voltage k: harmonic order</p>
1P2W-1 to 4	<i>THDVR₁</i>
1P3W-1, 2	<i>THDVR₁, THDVR₂</i>
3P3W-1, 2	Line voltage <i>THDVR₁₂, THDVR₃₂</i>
3P3W3A	Line voltage <i>THDVR₁₂, THDVR₂₃, THDVR₃₁</i>
3P4W	<i>THDVR₁, THDVR₂, THDVR₃</i>

Total harmonic current distortion THDAR [%]

Display digits	4 digits
Display range	0.0% to 100.0%
Equation	$THDAR_c = \frac{\sqrt{\sum_{k=2}^{50} (A_{ck})^2} \times 100}{\sqrt{\sum_{k=1}^{50} (A_{ck})^2}}$ <p>c: measurement channel <i>THDAR₁, THDAR₂, THDAR₃, THDAR₄</i> A: harmonic current k: harmonic order</p>

Specifications

Harmonic voltage phase angle θV_k [deg]

Display digits	4 digits	
Display range	0.0° to ±180.0°	
Equation	$\theta V_{ck} = \tan^{-1} \left\{ \frac{V_{ckr}}{-V_{cki}} \right\}$	c: measurement channel V: harmonic voltage k: harmonic order r: real component after taking the FFT i: imaginary component after taking the FFT
1P2W-1 to 4	θV_{1k}	
1P3W-1, 2	$\theta V_{1k}, \theta V_{2k}$	
3P3W-1, 2	$\theta V_{12k}, \theta V_{32k}$ * Uses the line voltage	
3P3W3A	$\theta V_{12k}, \theta V_{23k}, \theta V_{31k}$ *Uses the line voltage	
3P4W	$\theta V_{1k}, \theta V_{2k}, \theta V_{3k}$	

Harmonic current phase angle θA_k [deg]

Display digits	4 digits	
Display range	0.0° to ±180.0°	
Equation	$\theta A_{ck} = \tan^{-1} \left\{ \frac{A_{ckr}}{-A_{cki}} \right\}$	c: measurement channel $\theta A_{1k}, \theta A_{2k}, \theta A_{3k}, \theta A_{4k}$ A: harmonic current k: harmonic order r: real component after taking the FFT i: imaginary component after taking the FFT

Harmonic voltage-current phase difference θ_k [deg]

Display digits	4 digits
Display range	0.0° to ±180.0°
Equation	c: measurement channel, k: harmonic order
1P2W-1 to 4	$\theta_{1k}, \theta_{2k}, \theta_{3k}, \theta_{4k}, \theta_{sumk} = \tan^{-1} \left\{ \frac{Q_{sumk}}{P_{sumk}} \right\}$
1P3W(3P3W)-1, 2	$\theta_{1k}, \theta_{2k}, \theta_{sum1k} = \tan^{-1} \left\{ \frac{Q_{sum1k}}{P_{sum1k}} \right\}$
	$\theta_{3k}, \theta_{4k}, \theta_{sum2k} = \tan^{-1} \left\{ \frac{Q_{sum2k}}{P_{sum2k}} \right\}$
	$\theta_{sumk} = \tan^{-1} \left\{ \frac{Q_{sumk}}{P_{sumk}} \right\}$
3P3W3A(3P4W)-1	$\theta_{1k}, \theta_{2k}, \theta_{3k}, \theta_{sumk} = \tan^{-1} \left\{ \frac{Q_{sumk}}{P_{sumk}} \right\}$

Power Supply Quality Measurement Items

Voltage Transient

Measurement system	Determines the presence of events at approx. 40.96 kpsps (24 μs interval) without gaps (50 Hz/60 Hz)
Display digits	4 digits
Effective input range	50 V to 2200 V (DC)
Display range	50 V to 2200 V (DC)
Accuracy	0.5% rdg * Defined for 1000 V (DC)
Input impedance	Approx. 1.67 MΩ
Threshold	Specify the absolute peak voltage.
Detection channel (ch)	
1P2W-1 to 4	V ₁
1P3W-1, 2	V ₁ , V ₂
3P3W-1, 2	Line voltage V ₁₂ , V ₃₂
3P3W3A	Line voltage V ₁₂ , V ₂₃ , V ₃₁
3P4W	V ₁ , V ₂ , V ₃

Specifications

Voltage Swell, Dip, Interruption

Range	Same as rms voltage
Display digits	Same as rms voltage
Effective input range	Same as rms voltage
Display range	Same as rms voltage
Crest factor	Same as rms voltage
Input impedance	Same as rms voltage
Threshold	Specify as a percentage of the nominal voltage.
Measurement system	Complies with IEC61000-4-30 The rms value is calculated on a single waveform that overlaps every half a waveform. Multi-phase system swell, dip judgment condition: The start of an event is assumed when any of the channel starts an event, and the end of the event is assumed when all the channels finished their events. Multi-phase system interruption judgment condition: The start of an event is assumed when all that channels start their events, and the end of the event is assumed when any of the channel finishes its event.
Accuracy	10% to 150% for nominal voltage 100 V or higher: nominal voltage \pm 1.0% Outside the above range: \pm 0.4%rdg \pm 0.4% rng Measurement error in the event persistence time in the frequency range of 40 to 70 Hz: within 1 cycle
Detection channel (ch)	
1P2W-1 to 4	V_1
1P3W-1, 2	V_1, V_2
3P3W-1, 2	Line voltage V_{12}, V_{32}
3P3W3A	Line voltage V_{12}, V_{23}, V_{31}
3P4W	V_1, V_2, V_3

Inrush current

Range	Same as rms current
Display digits	Same as rms current
Effective input range	Same as rms current
Display range	Same as rms current
Crest factor	Same as rms current
Input impedance	Same as rms current
Threshold	Specify as a percentage of the range.
Measurement system	The rms value is calculated on a single waveform that overlaps every half a waveform.
Accuracy	\pm 0.4% rdg \pm 0.4% rng + current clamp-on probe accuracy
Detection channel (ch)	A_1, A_2, A_3, A_4

Appendix Correspondence to radio law of each country

FCC Authorization

FCC CAUTION

Changes or modifications not expressly approved by the party responsible for compliance could void the user's authority to operate the equipment.

Note: This equipment has been tested and found to comply with the limits for a Class B digital device, pursuant to Part 15 of FCC Rules. These limits are designed to provide reasonable protection against harmful interference in a residential installation. This equipment generates, uses, and can radiate radio frequency energy. If not installed and used in accordance with the instructions, it may cause harmful interference to radio communications. However, there is no guarantee that interference will not occur in a particular installation. If this equipment does cause harmful interference to radio or television reception, which can be determined by tuning the equipment off and on, the user is encouraged to try and correct the interference by one or more of the following measures:

- Reorient or relocate the receiving antenna
- Increase the distance between the equipment and the receiver.
- Connect the equipment to outlet on a circuit different from that to which the receiver is connected.
- Consult the dealer or an experienced radio/TV technician for help.

This transmitter must not be co-located or operated in conjunction with any other antenna or transmitter.

This equipment complies with FCC radiation exposure limits set forth for an uncontrolled environment and meets the FCC radio frequency (RF) Exposure Guidelines. This equipment has very low levels of RF energy that it deemed to comply without maximum permissive exposure evaluation (MPE).

Appendix Correspondence to radio law of each country

IC Authorization

This Class B digital apparatus complies with Canadian ICES003.

Cet appareil numérique de la classe B est conforme à la norme NMB-003 du Canada.

This device complies with Industry Canada licence-exempt RSS standard(s). Operation is subject to the following two conditions: (1) this device may not cause interference, and (2) this device must accept any interference, including interference that may cause undesired operation of the device.

Le présent appareil est conforme aux CNR d'Industrie Canada applicables aux appareils radio exempts de licence.

L'exploitation est autorisée aux deux conditions suivantes : (1) l'appareil ne doit pas produire de brouillage, et (2) l'utilisateur de l'appareil doit accepter tout brouillage radioélectrique subi, même si le brouillage est susceptible d'en compromettre le fonctionnement.

This equipment complies with IC radiation exposure limits set forth for an uncontrolled environment and meets RSS-102 of the IC radio frequency (RF) Exposure rules. This equipment has very low levels of RF energy that it is deemed to comply without maximum permissive exposure evaluation (MPE). [But it is desirable that it should be installed and operated keeping the radiator at least 20 cm or more away from person's body.]

Cet équipement est conforme aux limites d'exposition aux rayonnements énoncées pour un environnement non contrôlé et respecte les règles d'exposition aux fréquences radioélectriques (RF) CNR-102 de l'IC. Cet équipement émet une énergie RF très faible qui est considérée conforme sans évaluation de l'exposition maximale autorisée. *Cependant, il est souhaitable qu'il devrait être installé et utilisé en gardant une distance de 20 cm ou plus entre le dispositif rayonnant et le corps.]