

Unit : mm

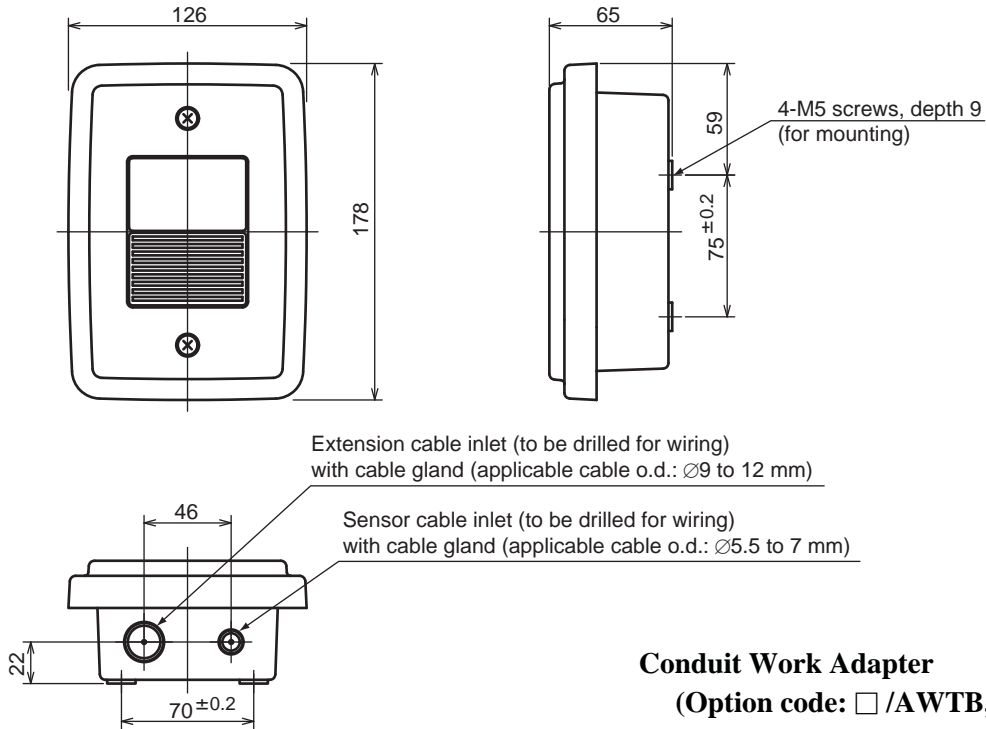

Weight : Approx. 0.5kg

Conduit Work Adapter (Option code: □ /AWTB, □ /ANSI)

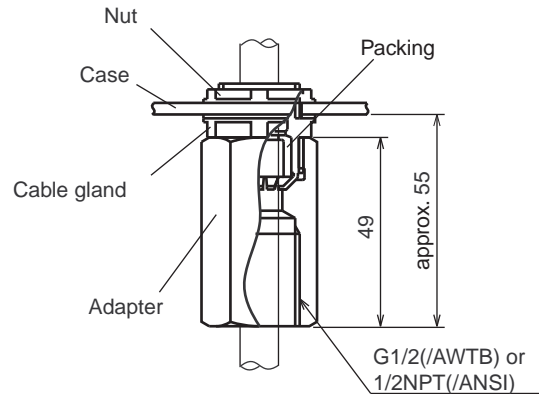

Note: This part (1 set) is used when the dedicated extension cable is protected by a conduit.
Attach it to the cable gland of the converter sensor cable inlet port and the cable gland of the terminal box extension cable.
Note that the converter adapter is supplied with a JIS A15 cable gland. Use this gland to replace the cable gland on the converter (DIN PG13.5).

Wiring Connection

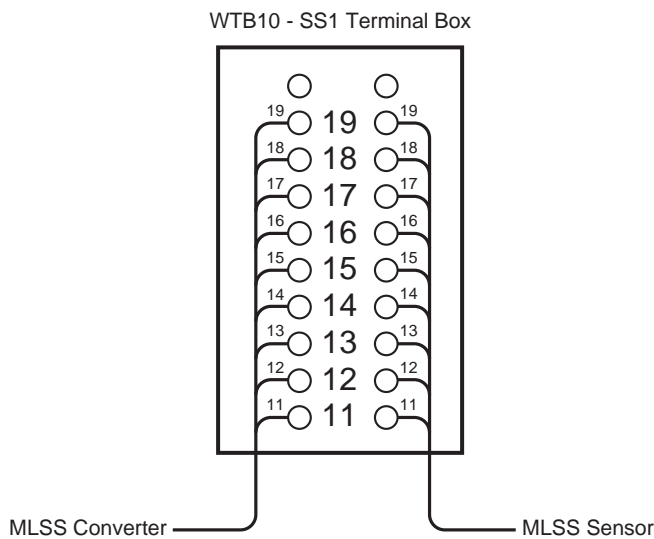

Unless otherwise specified, differences in the dimensions are specified as : General tolerance=(Criteria of tolerance class IT18 in JIS B0401-1986)/2.

Dedicated Extension Cable (not supplied suffix code: -00 is specified.)

Unit : mm

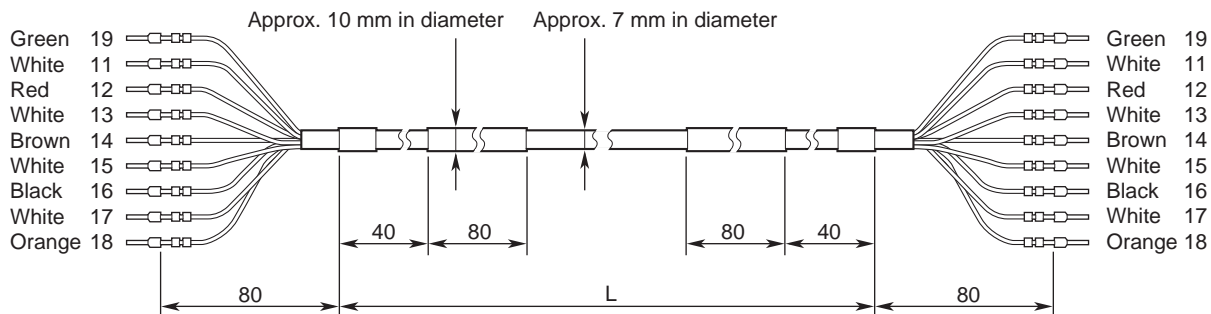

Models and Suffix codes	L
WTB10 - SS1 - NN - 05	Approx. 5 000
WTB10 - SS1 - NN - 10	Approx. 10 000
WTB10 - SS1 - NN - 20	Approx. 20 000
WTB10 - SS1 - NN - 30	Approx. 30 000
WTB10 - SS1 - NN - 40	Approx. 40 000

Pipe Mounting Bracket (option)
(Option code: /P)

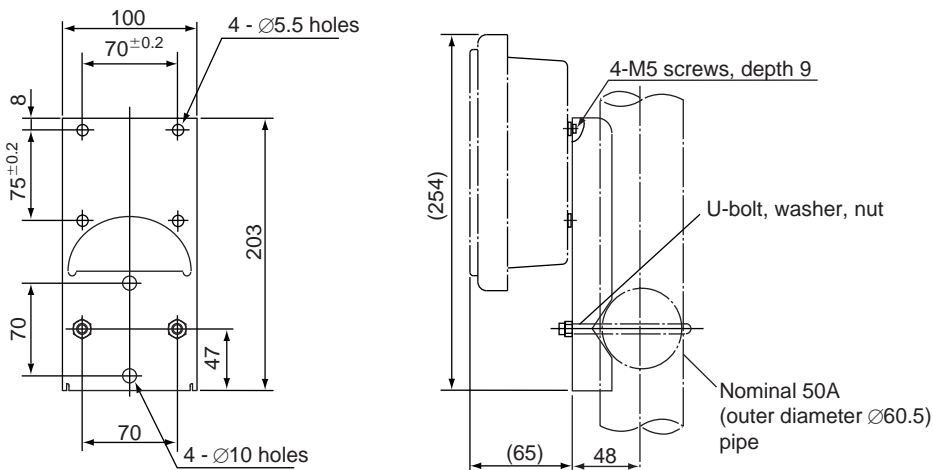

Weight : Approx. 700g

Wall Mounting Bracket (option)
(Option code: /W)

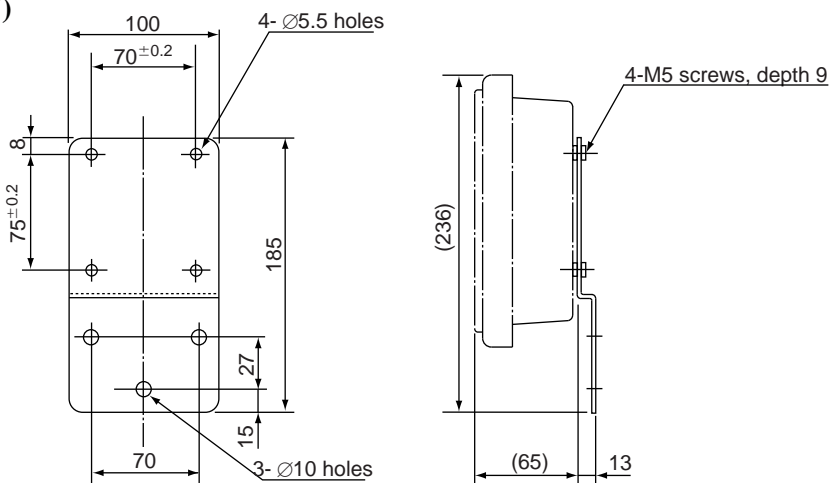

Weight : Approx. 300g

Unless otherwise specified, differences in the dimensions are specified as : General tolerance=(Criteria of tolerance class IT18 in JIS B0401-1986)/2.