



Performance, Design, and Versatility
MT8000iE/XE • mTV Series



Ultra-slim form factor

Enables HMI can be installed in any industrial control environment.



Dual Ethernet ports

Dual Ethernet ports offers you to set up WAN/LAN or two different LAN/LAN network configurations. (MT8073iE)



Built-in Wi-Fi

802.11 b/g/n wireless communication standards. (MT8103iE)



Power isolation protection

Effectively avoids surges and ensures the reliability of HMI. (MT8050iE/ MT8071iE/ MT8073iE/ MT8102iE/ MT8103iE)

Equipped with powerful Cortex A8 600 MHz CPU



Not only the MT8000iE Series performs fast booting speed and JPEG display speed, but also greatly improves the communication speed between HMI and PLC.



Provides the most common sizes of HMIs in industrial control applications

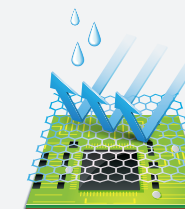

PCB coating protection

Increases the strength of damp-proof, dust-proof, and corrosion resistance in any harsh environment.

Built-in isolated RS-485



Effectively avoids the ground potential difference problem and ensures your HMI durable in any complicated grounding environment. (MT8070iE)

- COM [RS-485] supports MPI 187.5K.
- All iE Series models comply with IP65 rating and CE testing standards.
- Configuration software, EasyBuilder Pro offers more than 250 drivers for Weintek HMI to connect with various and numerous controllers.

iE Series

iE Series, easily installed in any industrial control environment

- Ultra-slim form factor and new color design.
- Isolated RS-485 and PCB coating protections.





Dual Ethernet ports

Dual Ethernet ports offers you to set up WAN/LAN or two different LAN/LAN network configurations. (MT8092XE)



Silver side

Elegant silver side and streamlined styling form factor shows aesthetic sense. (MT8090XE/ MT8092XE)

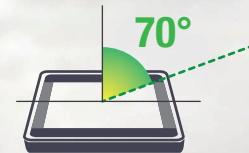

Wide viewing angle

Up to 70° wide viewing angle makes HMI monitoring less limited. (MT8090XE/ MT8092XE)

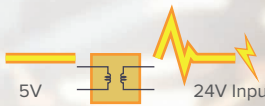

Power isolation protection

Effectively avoids surges and ensures the reliability of HMI.

Equipped with powerful Cortex A8 1GHz CPU



Sets benchmark records of HMI performance, such as booting speed, JPEG file display speed, and speed of PLC data read/write. Greatly improves graphics performance and database operation efficiency.



Provides the most popular sizes of HMIs in large and complicated industrial applications

High-resolution HMIs (9.7", 12", 15")



Displays the most detailed information and objects with high-resolution (1024x768) LCD.



Aluminum Enclosure

Greatly improves durability and reliability. (MT8121XE/MT8150XE)

PCB coating protection

Increases the strength of damp-proof, dust-proof, and corrosion resistance in any harsh environment.

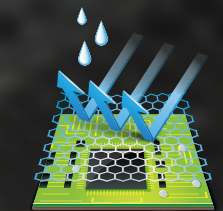

Built-in isolated RS-485

Effectively avoids the ground potential difference problem and ensures your HMI durable in any complicated grounding environment. (MT8121XE/MT8150XE)

- COM [RS-485] supports MPI 187.5K.
- All XE Series models comply with IP65/IP66(MT8121XE) rating and CE testing standards.
- Configuration software, EasyBuilder Pro offers more than 250 drivers for Weintek HMI to connect with various and numerous controllers.

XE Series

XE Series, optimal for industrial control application in various harsh environments

- 9.7" high-resolution(1024 x 768 pixels) HMI.
- 12" /15" large sizes of HMIs with aluminum enclosure.
- Isolated RS-485, PCB coating, and Power isolation protections.

HDTV supported

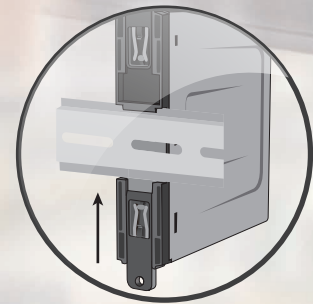

Compact design and DIN-rail mountable

Easily installed in any industrial control environment.



10/100/1000 Base-T x 1

COM1 RS-232
COM2 RS-485 2W/4W
COM3 RS-485 2W



HDMI cable



HMI device SMALLER, display range BIGGER

Perfectly fitted in any size of control cabinet and flexibly connected to any large size of HDTV.

mTV Series

mTV Series, creates a new HMI vision

- HDMI output allows displaying projects on any size of TV monitors with the HDMI interface.
- PCB coating and power isolation protections.

- COM [RS-485] supports MPI 187.5K.
- mTV Series comply with CE testing standards.
- Configuration software, EasyBuilder Pro offers more than 250 drivers for Weintek HMI to connect with various and numerous controllers.

EasyBuilder Pro

EasyBuilder Pro - Innovators in Software

EasyBuilder Pro features an extremely intuitive user interface and satisfies diverse application demands such as data/event log, recipe database, alarm handling, tag management, macro computing and pass-through for editing data of a remote PLC. During the project development phase, on-line simulation greatly facilitates verification of parameters. EasyBuilder Pro is the comprehensive HMI configuration software.

Easy to Use Configuration Software

With a talented R&D team and experienced in HMI manufacturing, Weintek has developed the most advanced and easy-to-use configuration software in the industrial automation field.

Support more than 250 communication drivers

EasyBuilder Pro supports more than 250 communication drivers to connect to different brands of PLC, Servo, Inverter, Temperature controller, Barcode scanner, and etc.

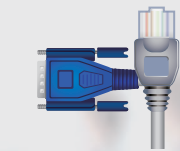

Excellent User Interface

EasyBuilder Pro walks you through the HMI project editing process all with ease, and accomplishes the project management, such as privilege management, device management, file management, or log management.

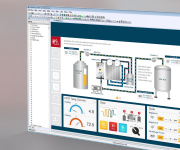

Extensive Graphics Libraries

EasyBuilder Pro provides sufficient high-quality graphics libraries with a wide selection of different industrial applications such as packing machine, processing factory, water treatment plant, and many more that greatly reduce your project display designing time.



Versatile Application Tools

Weintek Software R&D Center develops various stand-alone application tools, such as Recipe Editor, EasyDiagnoser, EasySimulator, EasyConverter, and etc. These tools can help you analyze different data records and troubleshoot abnormal issues for your application.



Utility Manager



EasyDiagnoser



EasyPrinter



AB Data Type Editor



EasySimulator



EasyAccess



Pass Through



VNC



EasyWatch



EasyConverter



Database Editor



Recipe Editor

- Extremely intuitive project editing experience.
- Connect with over 250 communication drivers.

The Comparison of Software Features Between Different Models



Software Feature

	mTV-100	MT8050iE	MT8070iE	MT8071iE	MT8073iE	MT8102iE	MT8103iE	MT8090XE	MT8092XE	MT8121XE	MT8150XE
Project Size	64MB	16MB	16MB	16MB	16MB	16MB	16MB	64MB	64MB	64MB	64MB
History Data Size	64MB	16MB	16MB	16MB	16MB	16MB	16MB	120MB	120MB	64MB	64MB
Embed Pictures in Project	✓	✓	✓	✓	✓	✓	✓	✓	✓	✓	✓
Embed PLC Tag Information in Project	✓	✓	✓	✓	✓	✓	✓	✓	✓	✓	✓
Project Protection	✓	✓	✓	✓	✓	✓	✓	✓	✓	✓	✓
Enhanced Security	✓	✓	✓	✓	✓	✓	✓	✓	✓	✓	✓
Recipe Database / View Database	✓	✓	✓	✓	✓	✓	✓	✓	✓	✓	✓
Operation Log / Operation View	N/A	✓	✓	✓	✓	✓	✓	✓	✓	✓	✓
e-Mail	✓	✓	✓	✓	✓	✓	✓	✓	✓	✓	✓
Media Player	N/A	N/A	N/A	N/A	N/A	N/A	N/A	✓	✓	✓	✓
Audio Output	*✓	N/A	N/A	N/A	N/A	N/A	N/A	N/A	N/A	N/A	N/A
Video Input	N/A	N/A	N/A	N/A	N/A	N/A	N/A	N/A	N/A	N/A	N/A
USB CAM	✓	N/A	N/A	N/A	N/A	N/A	N/A	✓	✓	✓	✓
Flow Block	✓	✓	✓	✓	✓	✓	✓	✓	✓	✓	✓
Combo Button	✓	✓	✓	✓	✓	✓	✓	✓	✓	✓	✓
Circular Trend Display	✓	✓	✓	✓	✓	✓	✓	✓	✓	✓	✓
Picture View	✓	✓	✓	✓	✓	✓	✓	✓	✓	✓	✓
CAN Bus	N/A	N/A	N/A	N/A	N/A	N/A	N/A	N/A	✓	N/A	N/A
VNC	✓	✓	✓	✓	✓	✓	✓	✓	✓	✓	✓
Download Project via USB Cable	N/A	N/A	N/A	N/A	N/A	N/A	N/A	N/A	N/A	✓	✓
Download Project via USB Disk	✓	✓	✓	✓	✓	✓	✓	✓	✓	✓	✓
Download Project via Ethernet	✓	✓	✓	✓	✓	✓	✓	✓	✓	✓	✓
User-Defined Boot Screen	✓	✓	✓	✓	✓	✓	✓	✓	✓	✓	✓
EasySystemSetting	✓	✓	✓	✓	✓	✓	✓	✓	✓	✓	✓

* HDMI Audio Output

mTV Series



Specification	Model	mTV-100	
Display	Display	Display to HDTV	
	Resolution	HDTV supported	
	Brightness (cd/m ²)	HDTV supported	
	Contrast Ratio	HDTV supported	
	Backlight Type	HDTV supported	
	Backlight Life Time	HDTV supported	
Memory	Colors	HDTV supported	
	Flash	256 MB	
	RAM	256 MB	
Processor		32 bits RISC Cortex-A8 600MHz	
I/O Port	SD Card Slot	SD/SDHC	
	USB Host	USB 2.0 x 1	
	Ethernet	10/100/1000 Base-T x 1	
	COM Port	COM1:	RS-232
		COM2:	RS-485 2W/4W
		COM3:	RS-485 2W
HDMI	Resolution 1280 x 720		
Audio Output	HDMI Audio Output		
RTC		Built-in	
Power	Input Power	24±20%VDC	
	Power Isolation	Built-in	
	Power Consumption	230mA@24VDC	
	Voltage Resistance	500VAC (1 min.)	
	Isolation Resistance	Exceed 50MΩ at 500VDC	
	Vibration Endurance	10 to 25Hz (X, Y, Z direction 2G 30 minutes)	
Specification	PCB Coating	Yes	
	Enclosure	Plastic	
	Dimensions WxHxD	130 x 115 x 27 mm	
	Weight	Approx. 0.18 kg	
	Mount	35mm DIN rail mounting	
Environment	Protection Structure	IP20	
	Storage Temperature	-20° - 70°C (-4° - 158°F)	
	Operating Temperature	-20° - 55°C (-4° - 131°F)	
	Relative Humidity	10% - 90% (non-condensing)	
Certificate	CE	CE marked	
	UL	cULus Listed	
Software		EasyBuilder Pro	

Dimensions

mTV-100

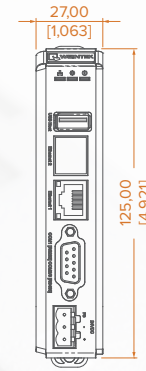

Front View

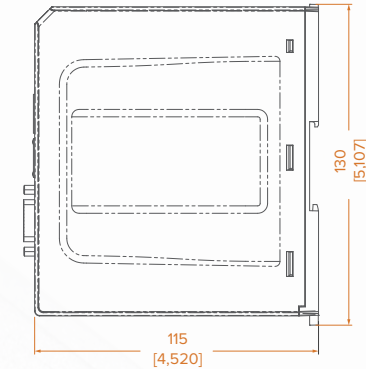

Side View



Top View



Bottom View

iE Series



Specification	Model	MT8050iE	MT8070iE / MT8071iE		MT8073iE	MT8102iE / MT8103iE NEW	
Display	Display	4.3" TFT	7" TFT		7" TFT	10.1" TFT	
	Resolution	480 x 272	800 x 480		800 x 480	1024 x 600	
	Brightness (cd/m ²)	400	350	400	400	350	
	Contrast Ratio	500:1	500:1		500:1	500:1	
	Backlight Type	LED	LED		LED	LED	
	Backlight Life Time	>30,000 hrs.	>30,000 hrs.		>30,000 hrs.	>50,000 hrs.	
	Colors	16.7M	16M	16.7M	16.7M	16.7M	
Touch Panel	Type	4-wire Resistive Type		4-wire Resistive Type	4-wire Resistive Type		
	Accuracy	Active Area Length(X)±2%, Width(Y)±2%		Active Area Length(X)±2%, Width(Y)±2%	Active Area Length(X)±2%, Width(Y)±2%		
Memory	Flash	128 MB		128 MB	128 MB		
	RAM	128 MB		128 MB	128 MB		
Processor		32 bits RISC Cortex-A8 600MHz		32 bits RISC Cortex-A8 600MHz	32 bits RISC Cortex-A8 600MHz		
I/O Port	USB Host	USB 2.0 x 1		USB 2.0 x 1	USB 2.0 x 1		
	Ethernet	10/100 Base-T x 1		10/100 Base-T x 1	10/100/1000 Base-T x 2		
	WiFi	N/A		N/A	N/A		
	COM Port	COM1: RS-232/RS-485 2W/4W COM3: RS-485 2W		COM1: RS-232/RS-485 2W/4W COM3: RS-485 2W	COM1: RS-232 COM2: RS-485 2W/4W COM3: RS-485 2W COM3: RS-485 2W/RS-232*	COM1: RS-232 COM2: RS-485 2W/4W COM3: RS-485 2W/RS-232*	
RTC	Isolated RS-485	N/A		Yes	N/A		
	Built-in	Built-in		Built-in	Built-in		
Power	Input Power	24±20%VDC		24±20%VDC	24±20%VDC		
	Power Isolation	Built-in		N/A	Built-in		
	Power Consumption	300mA@24VDC		350mA@24VDC	450mA@24VDC	600mA@24VDC*	
	Voltage Resistance	500VAC (1 min.)		500VAC (1 min.)	500VAC (1 min.)		
	Isolation Resistance	Exceed 50MΩ at 500VDC		Exceed 50MΩ at 500VDC	Exceed 50MΩ at 500VDC		
	Vibration Endurance	10 to 25Hz (X, Y, Z direction 2G 30 minutes)		10 to 25Hz (X, Y, Z direction 2G 30 minutes)	10 to 25Hz (X, Y, Z direction 2G 30 minutes)		
	PCB Coating	Yes		Yes	Yes		
Specification	Enclosure	Plastic		Plastic	Plastic		
	Dimensions WxHxD	128 x 102 x 32 mm		200.3 x 146.3 x 34 mm	200.3 x 146.3 x 34 mm		
	Panel Cutout	119 x 93 mm		192 x 138 mm	192 x 138 mm		
	Weight	Approx. 0.25 kg		Approx. 0.6 kg	Approx. 0.6 kg		
	Mount	Panel mount		Panel mount	Panel mount		
Environment	Protection Structure	UL Type 4X (indoor use only) / NEMA4 / IP65 Compliant Front Panel		UL Type 4X (indoor use only) / NEMA4 / IP65 Compliant Front Panel	NEMA4 / IP65 Compliant Front Panel		
	Storage Temperature	-20° - 60°C (-4° - 140°F)		-20° - 60°C (-4° - 140°F)	-20° - 60°C (-4° - 140°F)		
	Operating Temperature	0° - 50°C (32° - 122°F)		0° - 50°C (32° - 122°F)	0° - 50°C (32° - 122°F)		
	Relative Humidity	10% - 90% (non-condensing)		10% - 90% (non-condensing)	10% - 90% (non-condensing)		
Certificate	CE	CE marked		CE marked	CE marked		
	ATEX	N/A		N/A	ATEX Zone 2/22 Category 3 G/D		
	UL	cULus Listed		cULus Listed	cULus Listed		
Software	EasyBuilder Pro	EasyBuilder Pro		EasyBuilder Pro	EasyBuilder Pro		
	Built-in EasyAccess 2.0	Built-in EasyAccess 2.0		Built-in EasyAccess 2.0	Built-in EasyAccess 2.0		

* MT8073iE/ MT8102iE/ MT8103iE: Only Tx & Rx (no RTS/CTS) may be used for COM1 RS-232 when COM3 RS-232 is also used.

* MT8073iE: Includes power consumption of USB device.

Dimensions

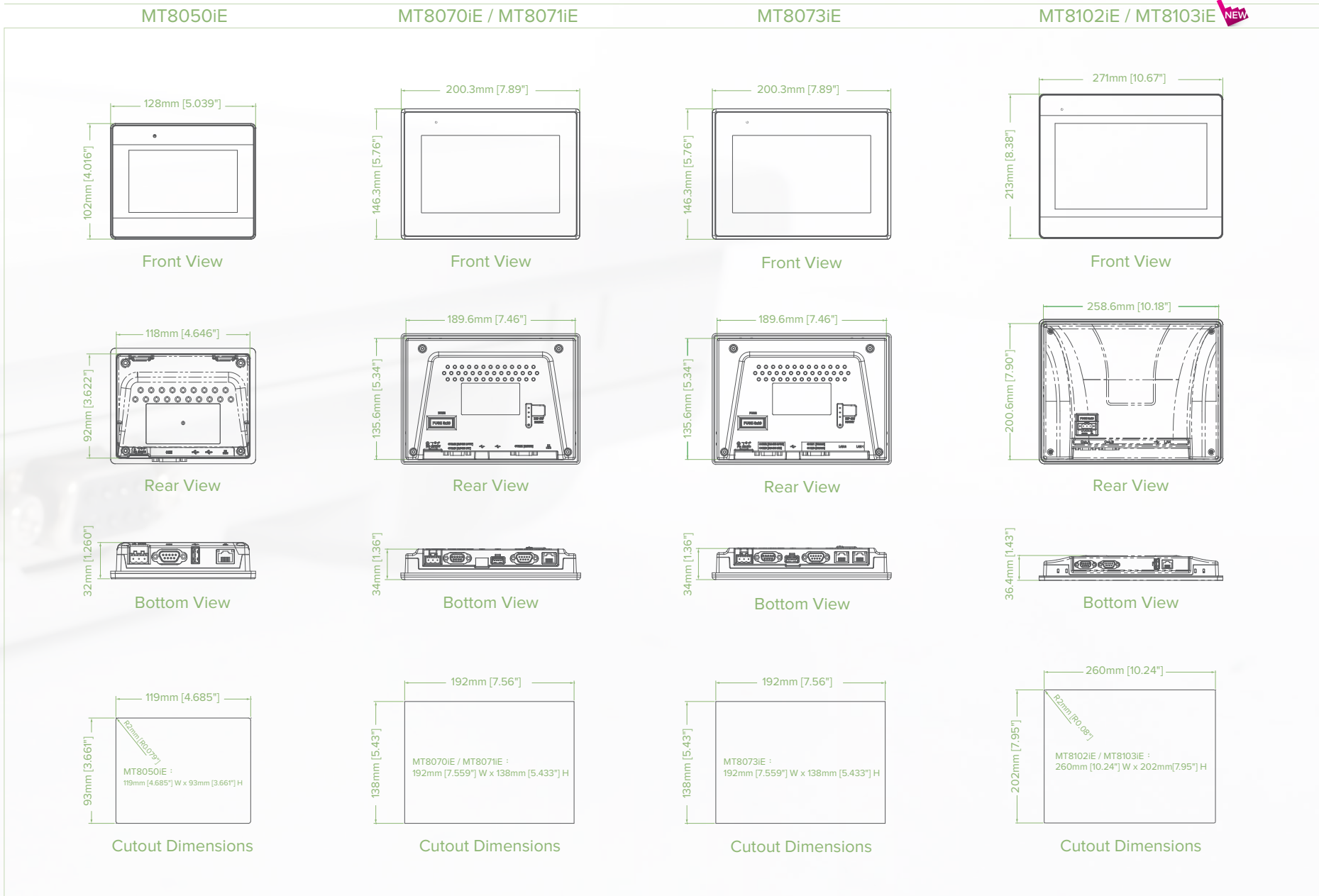

XE Series



Specification	Model	MT8090XE	MT8092XE	MT8121XE	MT8150XE
Display	Display	9.7" TFT	9.7" TFT	12.1" TFT	15" TFT
	Resolution	1024 x 768	1024 x 768	1024 x 768	1024 x 768
	Brightness (cd/m ²)	350	350	500	400
	Contrast Ratio	500:1	500:1	700:1	700:1
	Backlight Type	LED	LED	LED	LED
	Backlight Life Time	>30,000 hrs.	>30,000 hrs.	>50,000 hrs.	>50,000 hrs.
	Colors	262K	262K	16.2M	16.2M
Touch Panel	Type	4-wire Resistive Type	4-wire Resistive Type	4-wire Resistive Type	4-wire Resistive Type
	Accuracy	Active Area Length(X)±2%, Width(Y)±2%	Active Area Length(X)±2%, Width(Y)±2%	Active Area Length(X)±2%, Width(Y)±2%	Active Area Length(X)±2%, Width(Y)±2%
Memory	Flash	512 MB	512 MB	256 MB	256 MB
	RAM	256 MB	256 MB	256 MB	256 MB
Processor		32 bits RISC Cortex-A8 1GHz	32 bits RISC Cortex-A8 1GHz	32 bits RISC Cortex-A8 1GHz	32 bits RISC Cortex-A8 1GHz
I/O Port	SD Card Slot	N/A	N/A	SD/SDHC	SD/SDHC
	USB Host	USB 2.0 x 1	USB 2.0 x 1	USB 2.0 x 1	USB 2.0 x 1
	USB Client	N/A	N/A	USB 2.0 x 1	USB 2.0 x 1
	Ethernet	10/100 Base-T x 1	10/100/1000 Base-T x 2	10/100 Base-T x 1	10/100 Base-T x 1
	COM Port	COM1: RS-232 COM2: RS-485 2W/4W COM3: RS-485 2W	COM1: RS-232 COM2: RS-485 2W/4W COM3: RS-485 2W/RS-232*	COM1: RS-232/RS-485 2W/4W COM3: RS-485 2W	COM1: RS-232/RS-485 2W/4W COM3: RS-485 2W
	Isolated RS-485	N/A	N/A	Yes	Yes
	CAN Bus	N/A	Yes	N/A	N/A
	RTC	Built-in	Built-in	Built-in	Built-in
Power	Input Power	24±20%VDC	24±20%VDC	24±20%VDC	24±20%VDC
	Power Isolation	Built-in	Built-in	Built-in	Built-in
	Power Consumption	500mA@24VDC	650mA@24VDC*	800mA@24VDC	1000mA@24VDC
	Voltage Resistance	500VAC (1 min.)	500VAC (1 min.)	500VAC (1 min.)	500VAC (1 min.)
	Isolation Resistance	Exceed 50MΩ at 500VDC	Exceed 50MΩ at 500VDC	Exceed 50MΩ at 500VDC	Exceed 50MΩ at 500VDC
	Vibration Endurance	10 to 25Hz (X, Y, Z direction 2G 30 minutes)	10 to 25Hz (X, Y, Z direction 2G 30 minutes)	10 to 25Hz (X, Y, Z direction 2G 30 minutes)	10 to 25Hz (X, Y, Z direction 2G 30 minutes)
	Specification	PCB Coating	Yes	Yes	Yes
Enclosure		Plastic	Plastic	Aluminum	Aluminum
Dimensions WxHxD		260.6 x 203.1 x 36.5 mm	260.6 x 203.1 x 36.5 mm	317 x 244 x 46 mm	366 x 293 x 57 mm
Panel Cutout		250 x 192 mm	250 x 192 mm	305 x 231 mm	352 x 279 mm
Weight		Approx. 0.85 kg	Approx. 0.85 kg	Approx. 2.1 kg	Approx. 2.75 kg
Mount		Panel mount, VESA mount 75 x 75 mm	Panel mount, VESA mount 75 x 75 mm	Panel mount, VESA mount 75 x 75 mm	Panel mount, VESA mount 75 x 75 mm
Environment	Protection Structure	NEMA4 / IP65 Compliant Front Panel	NEMA4 / IP65 Compliant Front Panel	UL Type 4X (indoor use only) / NEMA4 / IP66 Compliant Front Panel	UL Type 4X (indoor use only) / NEMA4 / IP65 Compliant Front Panel
	Storage Temperature	-20° - 60°C (-4° - 140°F)	-20° - 60°C (-4° - 140°F)	-20° - 60°C (-4° - 140°F)	-20° - 60°C (-4° - 140°F)
	Operating Temperature	0° - 50°C (32° - 122°F)	0° - 50°C (32° - 122°F)	0° - 50°C (32° - 122°F)	0° - 50°C (32° - 122°F)
	Relative Humidity	10% - 90% (non-condensing)	10% - 90% (non-condensing)	10% - 90% (non-condensing)	10% - 90% (non-condensing)
Certificate	CE	CE marked	CE marked	CE marked	CE marked
	ATEX	ATEX Zone 2/22 Category 3 G/D	ATEX Zone 2/22 Category 3 G/D	N/A	ATEX Zone 2/22 Category 3 G/D
	UL	N/A	cULus Listed	cULus Listed	cULus Listed
Software		EasyBuilder Pro	EasyBuilder Pro	EasyBuilder Pro	EasyBuilder Pro
			Built-in EasyAccess 2.0		

* MT8092XE: Only Tx & Rx (no RTS/CTS) may be used for COM1 RS-232 when COM3 RS-232 is also used.

* MT8092XE: Includes power consumption of USB device.

Dimensions

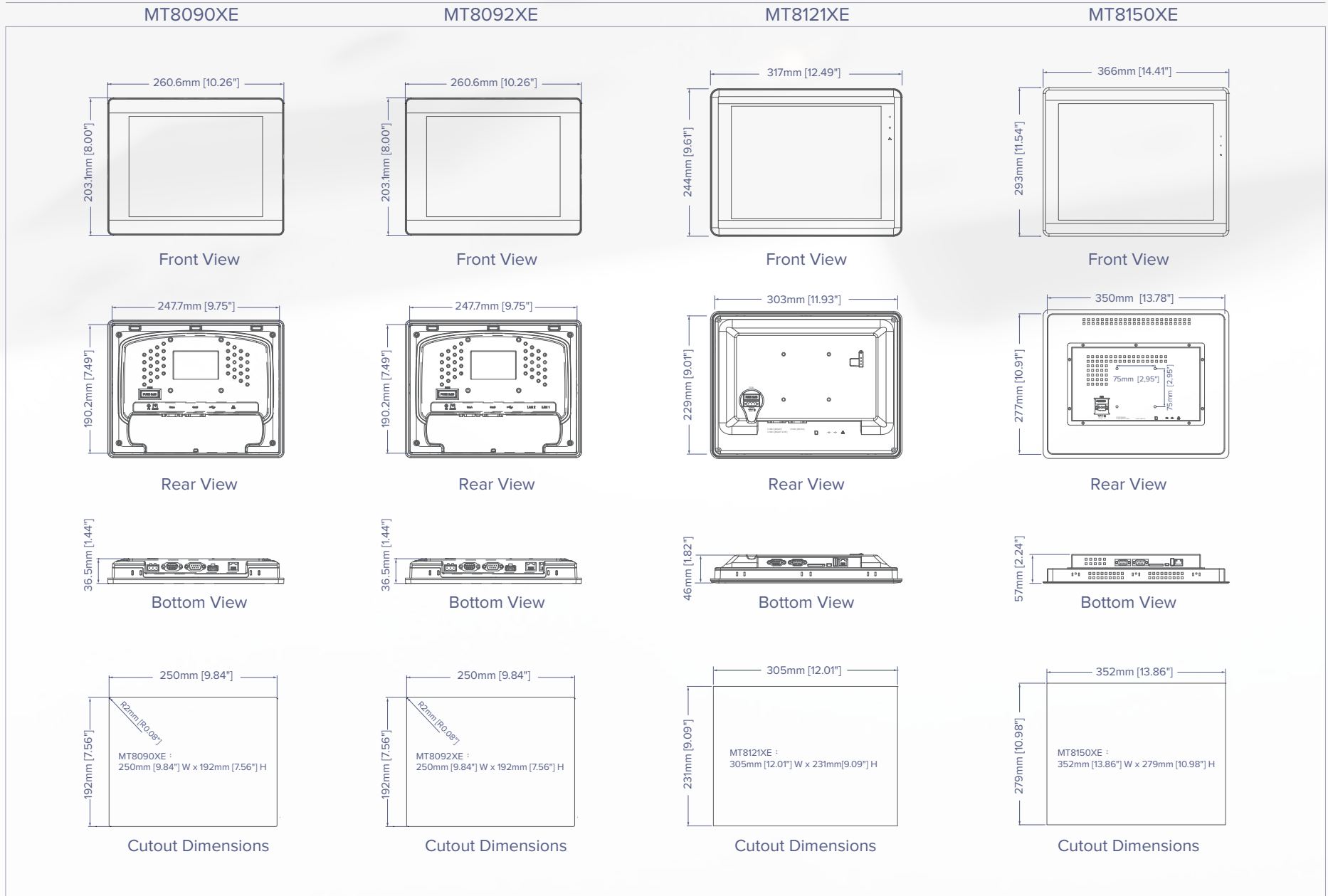



Weintek Distributed by KEP | *Sales, Service, and Support of all Weintek Products*

Contact

Kessler-Ellis Products, Co.
10 Industrial Way East
Eatontown, NJ 07724

Toll Free: 800-631-2165
Tel: 732-935-1320
Fax: 732-935-9344

www.kep.com