

MODELS
ES756 INT-69RT

ES-756
INSTALLATION & OPERATING INSTRUCTIONS



KESSLER-ELLIS PRODUCTS

10 Industrial Way East
Eatontown, NJ 07724

800-631-2165 • 732-935-1320

Fax: 732-935-9344



<http://www.kep.com>

CERTIFIED
ISO 9001



Proprietary Notice

The information contained in this publication is derived in part from proprietary and patent data. This information has been prepared for the expressed purpose of assisting operating and maintenance personnel in the efficient use of the instrument described herein. Publication of this information does not convey any rights to use or reproduce it or to use for any purpose other than in connection with the installation, operation and maintenance of the equipment described herein.

Copyright 2004
Printed in USA. All Rights Reserved.

WARNING

This instrument contains electronic components that are susceptible to damage by static electricity. Proper handling* procedures must be observed during the removal, installation, or handling of internal circuit boards or devices.

*Handling Procedure

1. Power to unit must be removed.
2. Personnel must be grounded, via wrist strap or other safe, suitable means, before any printed circuit board or other internal device is installed, removed or adjusted.
3. Printed circuit boards must be transported in a conductive bag or other conductive container. Boards must not be removed from protective enclosure until the immediate time of installation. Removed boards must be placed immediately in protective container for transport, storage, or return to factory.

Comments

This instrument is not unique in its content of EDS (electrostatic discharge sensitive) components. Most modern electronic designs contain components that utilize metal oxide technology (NMOS, CMOS, etc.). Experience has proven that even small amounts of static electricity can damage or destroy these devices. Damaged components, even though they appear to function properly, exhibit early failure.

TABLE OF CONTENTS

DESCRIPTION & SPECIFICATIONS.....	1
MOUNTING.....	2
WIRING.....	3
TYPICAL WIRING HOOKUPS.....	4
OPEN COLLECTOR.....	5
PROGRAMMING FLOWCHART.....	6
DEFINITIONS.....	7
FRONT PANEL OPERATIONS.....	10
PROGRAMMING.....	10
SETTING PRESETS & PANEL LOCK.....	15
TROUBLESHOOTING GUIDE.....	16
WARRANTY.....	17
DECODING PART NUMBER.....	19
APPENDIX I - UNITS CONVERSION CHART.....	18

DESCRIPTION & SPECIFICATIONS

Description:

Featuring 6 digits of bright, 7-segment LED displays, this unit is an integrating totalizer/ratemeter which accepts analog signal inputs. The unit can be field programmed to accept 0-20mA, 4-20mA, 0-5V, 0-10V or 1-5V signals. A 4-20mA output option is available to control strip recorders or other peripherals. Two assignable set points are standard for two stage shut off. The full scale setting is programmable from the front panel. By pressing the "view" button, the unit will display: integrated total, rate, peak or valley.

Specifications:

Display: 6 digit, .55" high, 7 segment, red orange, LED.

Input Power: 110 VAC \pm 15% or 12 to 24VDC.

Current: maximum 300 mA DC or 8.0 VA at rated AC voltage.

Output Power: (AC powered units only) + 24VDC @ 100mA regulated \pm 5%

Temperature:

Operating: +41°F (5°C) to +130°F (+54°C).

Storage: -40°F (-40°C) to +200°F (93°C).

Memory: EEPROM stores data for ten years if power is lost.

Reset:

Front Panel: resets displayed values and control outputs.

Remote: 4-30VDC positive edge, resets totalizer and control outputs.

Output:

Type: Open collector sinks 250mA from 30VDC when active.

Usage: rate alarm, total alarm, scaled pulse output for remote totalizers.

Analog Out: The full scale setting is programmable from the front panel. A sinking driver generates a corresponding linear current through the external devices. The output updates with each update of the rate. Accuracy is \pm 0.25% FS worst case. Compliance voltage must be 3 to 30 VDC non inductive. (The unit can provide the DC source as long as the drop across the devices being driven does not exceed 21V).

Input:

Type: Linear 0-20mA, 4-20mA, 0-5V, 0-10V or 1-5V selectable from the front panel.

Input Impedance: Current: 100 Ω ; Voltage: 115K Ω

Calibration: The unit does all of the calibrations internally. There are no potentiometers to adjust and the unit never needs to be removed from the case.

Set Points: Two control set points are provided. The set point outputs can be assigned to rate or total or pulse scaling. The unit comes standard with two open collector control outputs. The outputs are programmable from 0.01 to 599.99 sec or latched until reset when assigned to the total or pulse and a hysteresis (alarm range) when assigned to the rate.

Rate Display: Updates 5 times per second, Accurate to 4.5 digits.

Totalizer: Integrates from the rate reading and accumulates up to 6 digits of total count. The time base (seconds, minutes, hours or days) and totalize conversion factor are field programmable from the front panel.

Programming: Decimal points, Scaling from 0 to 59999 units per selected time base, set points, input type, security lock code, and assigning outputs are all programmable from the front panel.

Housing: Standard 1/8 DIN, high impact ABS plastic case (NEMA 4/IP65 front panel).

Shipping Weight: 2 lbs.

Overvoltage Protection:
50 V

Overcurrent Protection:
50 mA

Resolution: 14.5 Bits

Accuracy:

<u>RANGE</u>	<u>% FS ERROR</u> (worst case)	<u>% FS ERROR</u> (typical)
4-20 mA	0.1%	.05%
0-10 VDC	0.2%	0.1%
0-5 VDC	.25%	.15%
1-5 VDC	.25%	.15%

Square Law: (above 5% of bottom range) 0.1%
(5V inputs .4%) Worst case over complete range: 2%

Temperature Stability: Will not drift more than 20 parts per million per °C from 5°C to 54°C

MOUNTING

HOW TO MOUNT:

Slide the body of the unit through the rubber gasket. Insert the unit into the panel. Slide the brackets up the groove to press against the back of the panel, as shown in "FIG. A". Insert the screws into the rear of the brackets.

Tighten the screws evenly and alternately. A panel less than 0.1" may distort if the clamps are screwed too tightly. Do not over tighten! A normal level of torque is required. Maximum torque should be 3" pounds.

FIG. A

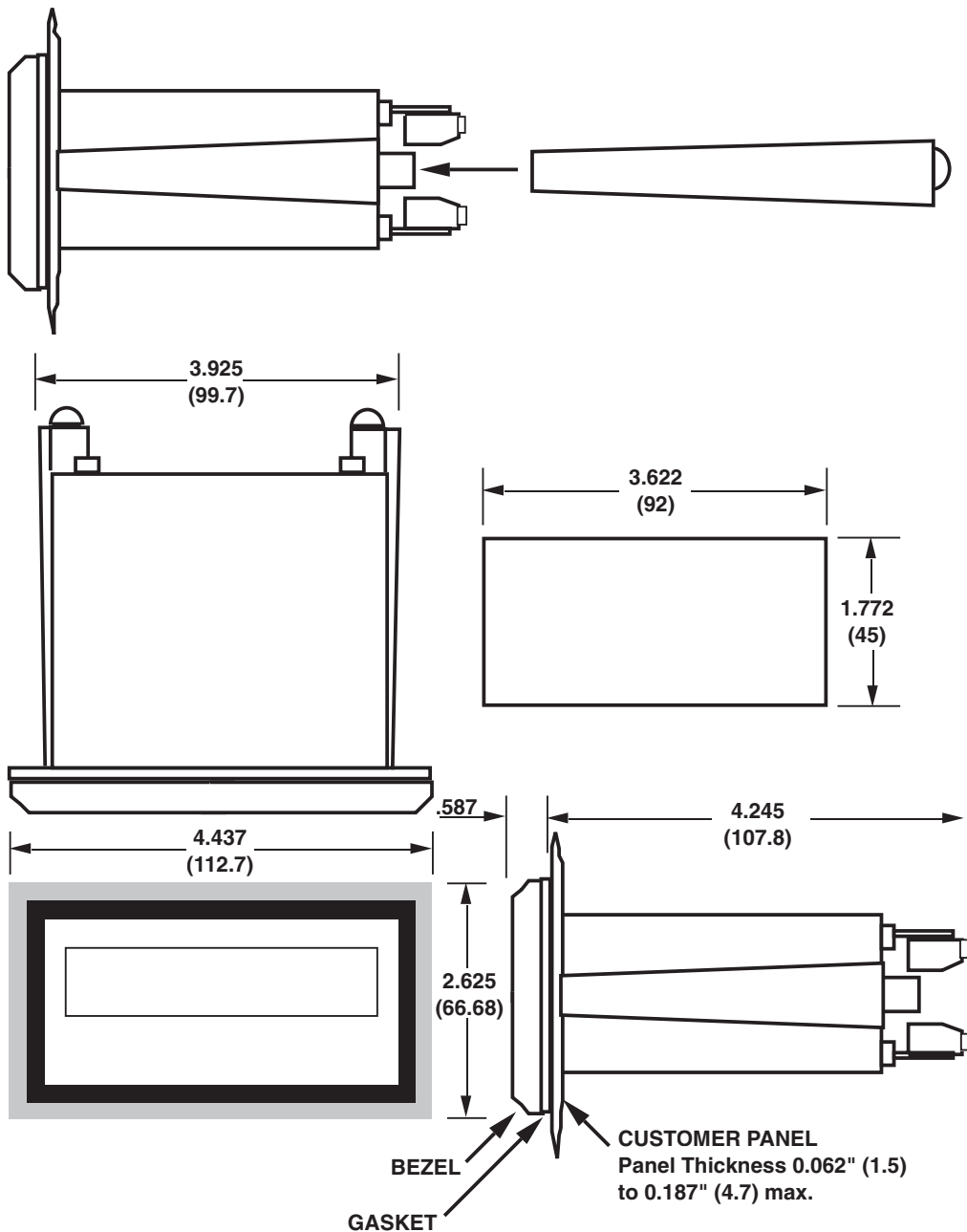

WIRING

AC / DC CONNECTIONS:

NOTE: Connect power only after other connections are finished. Do not touch the live AC power terminals. The unit has been designed with an isolated AC input, therefore polarity is not a concern for the AC power. The chassis is plastic, therefore earth ground is not used. For DC operation, connect +DC to terminal 10 and -DC to terminal 3.

Although the unit is designed to be immune from line or RF interference, the unit is controlled by a microprocessor and an electrically "noisy" environment could cause operating problems. The input power lines should not be common to power lines for motors, pumps, contactors, etc.

Four sources of noise can occur:

1) AC power line noise- If the unit cannot be connected to an electrically clean power source, an inductive load suppressing device (MOV as GE#V130LA1 or Resistor Capacitor as Paktron# .2uf/220 ohm @ 400V) can be installed. Although locating the suppressor across the AC supply at the unit should help, best results are obtained by connecting the suppressor across the leads of the "load" at the device causing the spikes.

2) Input line noise- The noise is carried on the input and DC ground lines. Make sure the input wires are not run into the unit in a bundle with power input lines. We recommend using shielded cable. Connect the shield to DC signal ground of the unit and "earth" at one point in the circuit preferably at the DC ground terminal of the unit.

3) Output lines- The unit has two open collector outputs. When these outputs are used to run external relays or solenoids, spikes can be generated upon activation. This noise can spread through the instrument causing operating problems. If the source is a D.C. operated device, a general purpose diode (IN4004) placed across the solenoid prevents electrical noise spikes. Connect the cathode (banded side) to the more positive side of the coil. If the source is an A.C. operated device, use a Resistor Capacitor or MOV across the coil.

4) 24 VDC output supply- Noise can be generated on the 24 VDC output supply if it is used to drive inductive loads or if the current draw exceeds 50mA. Insure that all inductive loads have a diode (such as IN4004) across the coil and that the current does not exceed 50mA.

WIRING CONNECTIONS

- 1• Reset In
- 2• Analog Out (Sink)
- 3• Signal GRD (-DC)
- 4• (Current) +I in
- 5• (Voltage) +V in
- 6• Not Used
- 7• +24V Out
- 8• Preset B Collector
- 9• Preset A Collector
- 10• +DC In
- 11• AC Neutral
- 12• AC Line

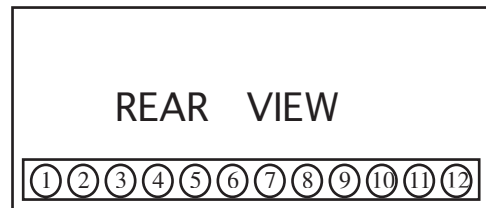

TYPICAL WIRING HOOKUPS

DC Powered

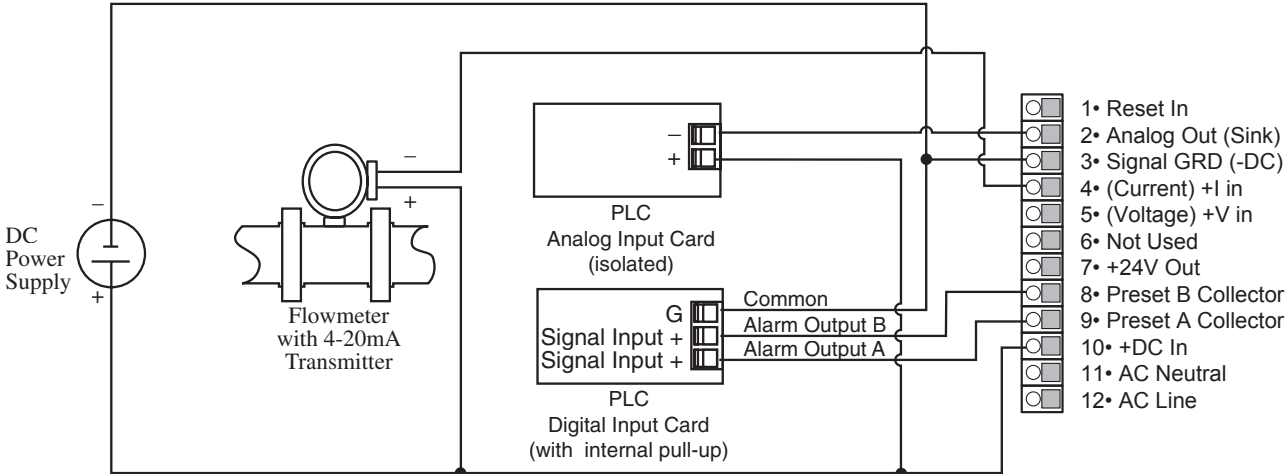

AC Powered

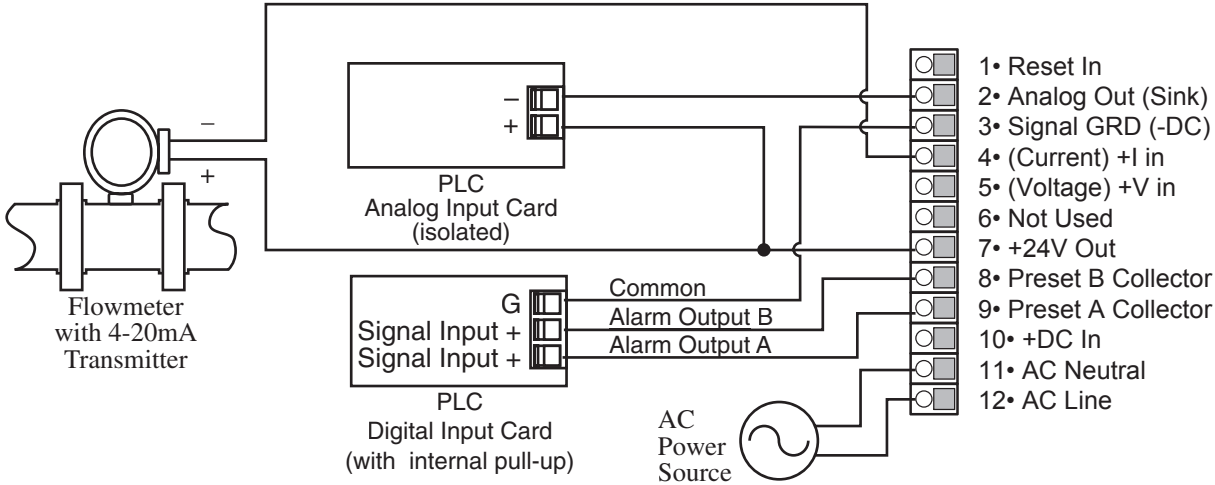

TYPICAL WIRING HOOKUPS (continued)

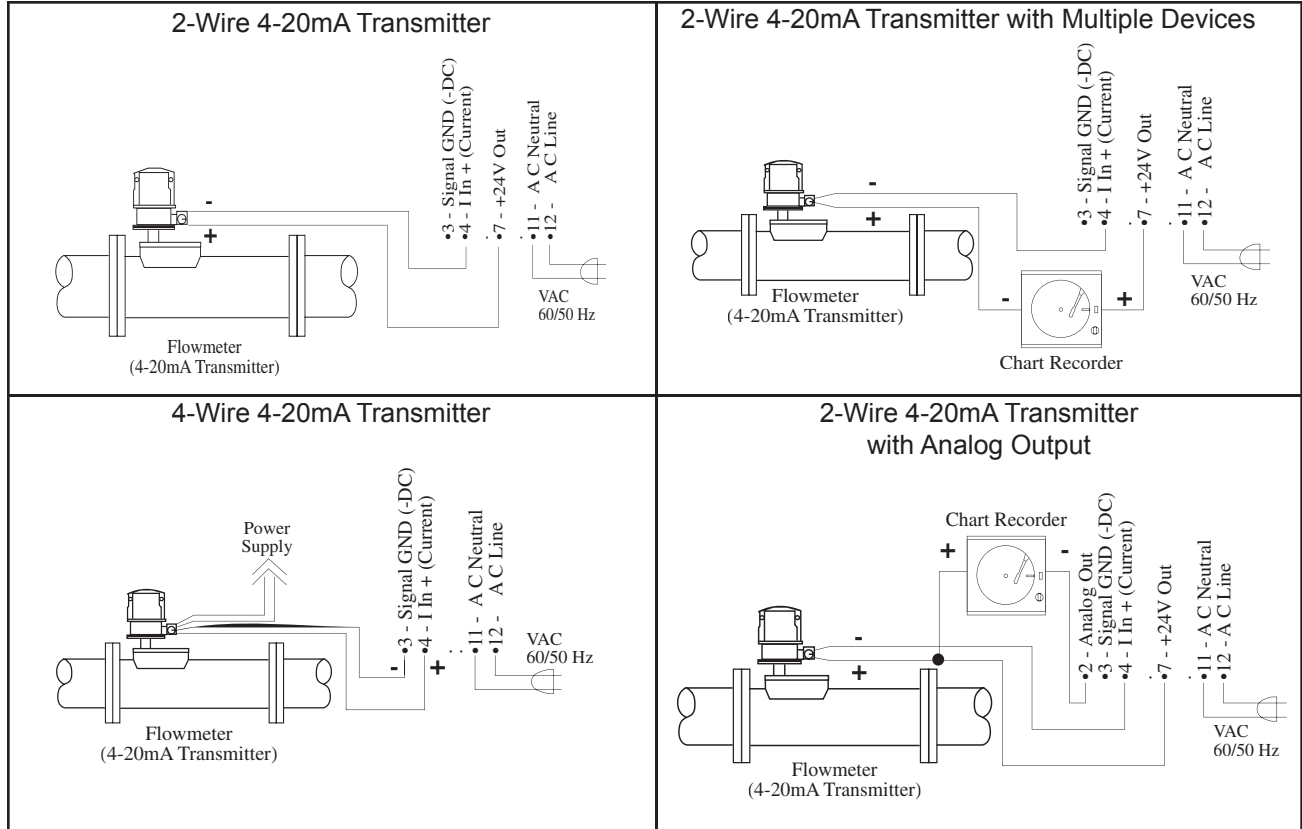

OPEN COLLECTOR

The open collector outputs trigger when the total or rate (assignable; see programming step 2) equals the corresponding Preset (A or B). When the output is assigned to "PUL" (pulse output) the outputs trigger with each count of the total (or multiples).

When the outputs are assigned to the "total", the operator can assign a duration of time (.01 to 599.99 sec.) that the output will remain energized. If 0.00 is assigned, the output will latch until reset. If output A is set at a duration (other than 0.00), the totalizer will autorecycle when Preset A is reached. At this time, output B will de-energize (if it was energized). Preset A is the final preset and should be set higher than Preset B, when both outputs are assigned to the total. If output A is set at a duration other than 0.00 and Preset A is set less than Preset B, Preset B will be ignored (provided that they are both assigned to total). The totalizer will never autorecycle at Preset B.

When the outputs are assigned to the "rate", the outputs can be assigned a hysteresis (alarm range). The hysteresis is the number of units below the preset that the output will remain energized. EXAMPLE: Preset set @ 100; Hysteresis set @ 10. The output will energize when the rate equals 100 and de-energize when the rate falls below 90 (10 below Preset).

Select "PUL" (pulse output) to use the output for remote totalizers. When set to "PUL", a minimum duration in seconds (0.00 to 599.99) can be assigned to the time the output will remain energized and de-energized. If 0.00 is chosen the relay or open collector is disabled. The pulse output follows the total and the relay or open collector will output a "pulse" on every multiple of the Preset Setpoint. (ie. Preset is set to 10. A pulse will be generated for total values 10, 20, 30, 40, ... , etc).

NOTE: If unit is setup to autorecycle then pulse output should not be used.

PROGRAMMING FLOWCHART

NOTE:

SEVERAL PROGRAMMING SELECTIONS WILL NOT APPEAR WITH "RATE ONLY" & "TOTAL ONLY" UNITS OPTIONS NOT ORDERED WILL NOT APPEAR IN PROGRAM SELECTIONS

	This symbol indicates any key.
	Press this key to step through Menu choices
	Press this key to enter displayed value.

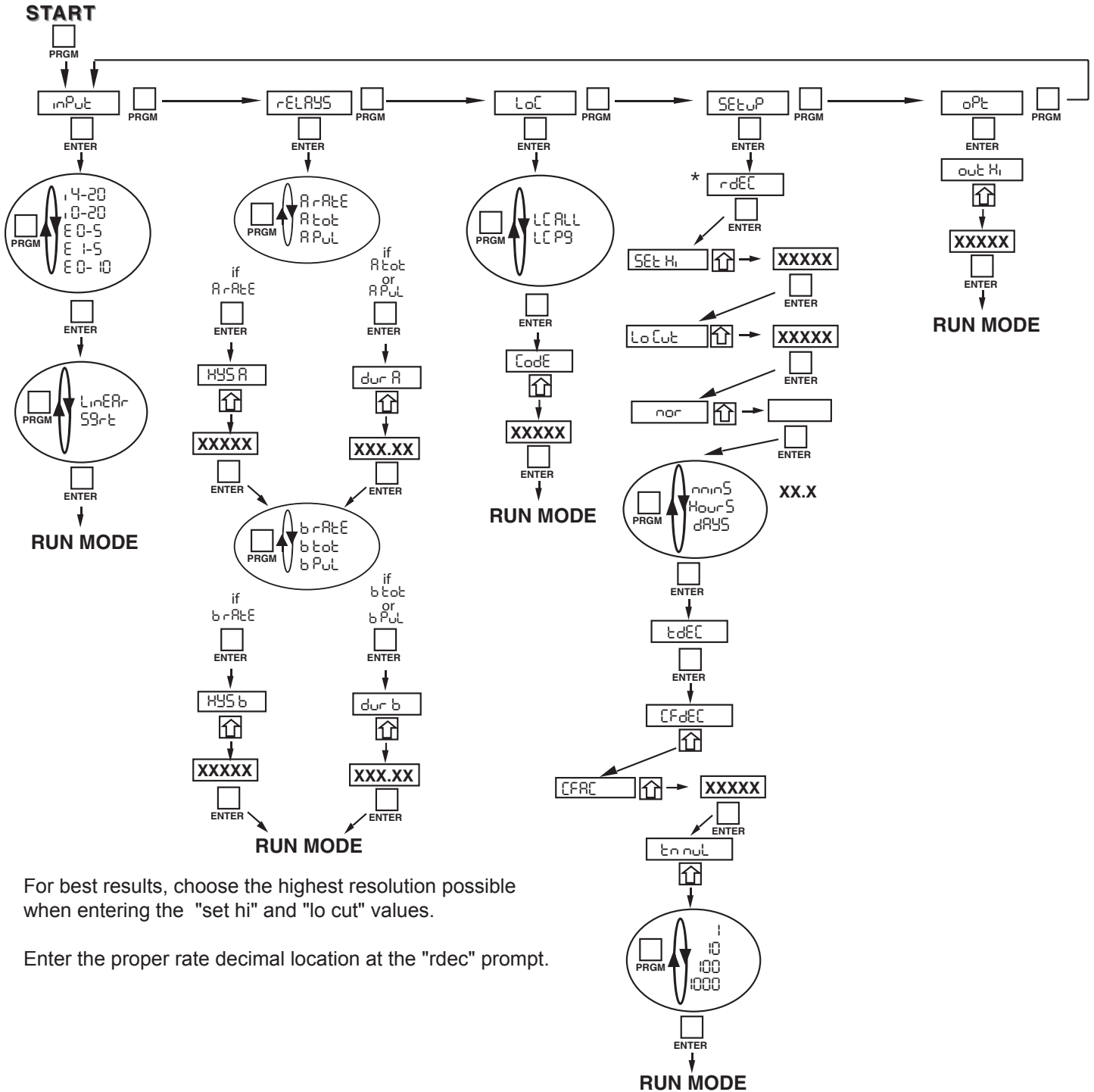

For best results, choose the highest resolution possible when entering the "set hi" and "lo cut" values.

Enter the proper rate decimal location at the "rdec" prompt.

DEFINITIONS

INPU - INPUT; This section of the program menu assigns the type of input the unit will be using (0-20 mA, 4-20 mA, 0-5 V, 0-10 V, 1-5 V, Linear or square root extraction).

I4-20 - I 4-20; This sets the unit for a current input of 4 to 20 mA.

I0-20 - I 0-20; This sets the unit for a current input of 0 to 20 mA.

E 1-5 - E 1-5; This sets the unit for a voltage input of 1 to 5 volts.

E 0-5 - E 0-5; This sets the unit for a voltage input of 0 to 5 volts.

E 0-10 - E 0-10; This sets the unit for a voltage input of 0 to 10 volts.

LINEAR - LINEAR; This sets the unit for linear input.

SQR - SQUARE ROOT; This sets the unit for square root extraction.

RELAYS - RELAYS; This section of the program menu sets the control output variables (open collector).

RAFR - OUTPUT A FOR RATE; This assigns the A output to the rate.

HYS A - HYSTERESIS FOR OUTPUT A; This value is the number of units below Preset A that the output will remain "ON". EXAMPLE: Preset A set at 100, Hys set at 10. Output A will activate (turn on) when the rate equals 100; Output A will deactivate (turn off) when the rate falls below 90 (10 below Preset A)

RAOT - OUTPUT A FOR TOTAL; This assigns the A output to the totalizer.

RAUL - Relay A assigned to pulse output.

dur A - OUTPUT A DURATION; This is the duration of time (.01 to 599.99 sec) that Output A will remain energized. If 0.00 is entered the output will latch until reset. If a value other than 0.00 is entered the unit will autorecycle at Preset A.

BAFR - OUTPUT B FOR RATE; This assigns the B output to the rate.

HYS b - HYSTERESIS FOR OUTPUT B; Same as HYS A.

BAOT - OUTPUT B FOR TOTAL; This assigns the B output to the totalizer.

BAUL - Relay B assigned to pulse output.

dur b - OUTPUT B DURATION; This is the duration of time (.01 to 599.99 sec) that Output B will remain energized. If 0.00 is entered the output will latch until reset.

L o C - LOCK; This section of the program menu sets up the lockout type and code.

L C A L L - LOCK ALL; When this is selected the lockout will lock the program as well as the Presets and reset button. The presets can be viewed but not changed.

L C P G - LOCK PROGRAM; When this is selected the lockout will lock only the program. The Reset can be activated and the presets can be viewed and changed.

C o d E - CODE; This is a 5-digit code which will be used to lock and unlock the front panel.

S E T U P - SETUP; This section of the program menu sets up the operating variables.

r d E C - RATE DECIMAL LOCATION; This allows the user to program a decimal point for the rate display.

S E T H i - SET HIGH; This is the rate value for the highest input (5 or 10 Volts; 20 mA). (i.e. 20 mA = 500 lbs/hr.)

L o C u t - LOW CUT-OFF; This is the lowest rate value to be recognized. All rate readings below this value will assume the "set lo" value.

n o r - NORMALIZING FACTOR; This is an averaging factor (00.0 to 99.9). Higher settings provide more normalizing (averaging) for a more stable display. Derived from the equation:
$$\frac{(\text{OLD DATA} \times \text{"NOR"} + \text{NEW DATA})}{(\text{"NOR"} + 1)}$$

S E C - SECONDS; This tells the unit that the High input value is entered in units per second.

m i n S - MINUTES; This tells the unit that the High input value is entered in units per minute.

H o u r S - HOURS; This tells the unit that the High input value is entered in units per hour.

d A Y S - DAYS; This tells the unit that the High input value is entered in units per day.

t d E C - TOTALIZER DECIMAL LOCATION; This allows the user to enter a decimal for the totalizer display. This decimal is not a dummy decimal and will scale the totalizer display accordingly. (i.e. if the tdec is set in the tenths position (#####.#), 100 will be displayed as 100.0)

C F d E C - CONVERSION FACTOR DECIMAL; This menu allows users to select a decimal location for the conversion factor

C F R C - CONVERSION FACTOR; This is a conversion divider factor that will be applied to convert from rate volume units to total volume units (i.e. rate is gal/(units time) to ft³ Conversion factor = 7.4805 (gal/ft³).

TOTAL - TOTALIZER FACTOR; This factor divides the totalizer display by 1, 10, 100 or 1000.

OPT - OPTIONS; This section of the program menu is for setting up optional features (analog out)

OUT HI - OUT HIGH; The displayed rate value at which the unit will output 20 mA (2000 lbs./hr = 20 mA out).

PXXXXX - P; This will appear in the 6th (furthest to the left) digit when viewing the Peak. The peak value is the highest rate reading that the unit had displayed since the peak had been reset. The peak is not retained in memory when power is lost.

UXXXXX - U; This will appear in the 6th (furthest to the left) digit when viewing the Valley. The valley value is the lowest rate reading that the unit had displayed since the valley had been reset. The valley is not retained in memory when power is lost.

RXXXXX - R; This will appear in the 6th (furthest to the left) digit when viewing the Rate.

FRONT PANEL OPERATIONS

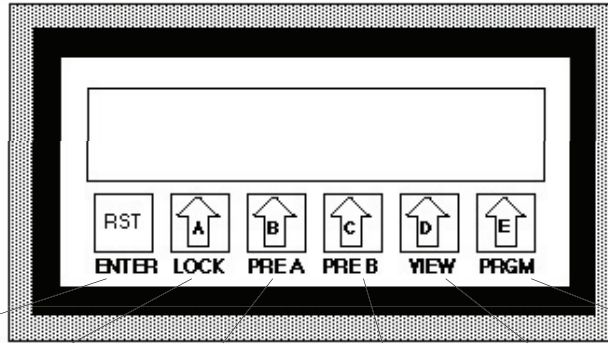

Press to RESET in operating mode; Press to "ENTER" in programming mode.

Press once to freeze display. Press any key to update display normally. Press rapidly (3 times within 5 seconds) to "enter" LOCK code for panel lock.

Press to view or change Preset A

Press to view or change Preset B

Press to alternately view Rate, Total, Peak & Valley.

Press to cycle through PROGRAM choices; Press to step through set up choices in program mode.

PROGRAMMING

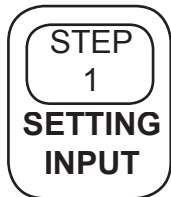

PRESS



DISPLAY

inPut

REMARKS

This section of the menu is used to set up the type of signal the unit will be receiving.



, 4-20, 10-20
E 1-5, E 0-5 or
E 0-10

Press the PRGM key to step through choices. Press the RST/ENTER key to enter the displayed choice.













LinEAR
or
SgRt

Press the PRGM key to toggle between the choices and press the RST/ENTER key to enter the desired choice.

NOTE: Always choose LINEAR

STEP
2
SETTING
RELAYS

NOTE: If outputs are not used, set **dur A** & **dur B** at "0.00" to prevent the counters from resetting at the presets.

<u>PRESS</u>	<u>DISPLAY</u>	<u>REMARKS</u>
 PRGM	inPut	This section of the menu sets up the open collector outputs.
 PRGM	rELAYS	
  PRGM ENTER	A rATE, A tot or A PUL	Output A assigned to the rate, total or pulse output. Press the PRGM key to toggle between choices, press the RST/ENTER key to enter the displayed choice.
 ENTER	(IF TOT or PUL SELECTED) dur A (hit any key to view or change existing dur A value XX.X)	dur A = the duration of time (0.01 to 599.99 sec) that output A will remain on or energized. When dur A is displayed, hit any key to view or change dur A. Press the RST/ENTER key to enter displayed value. When dur A is set at 0.00, output A will latch until reset; when dur A is set other than 0.00 the counter will autorecycle at Preset A.
 ENTER	(IF RATE SELECTED) HYS A (hit any key to view or change existing HyS A value XXXXX)	Hys (hysteresis)= The number of units below the preset that the output will remain "ON". EXAMPLE: Preset set @ 100; HyS set @ 10. Output will activate (turn on) when rate = 100 and turn off when rate falls below 90 (10 below preset).
  PRGM ENTER	b rATE, b tot or b PUL	Follow instructions for A RATE, A TOT & A PUL
 ENTER	(IF TOT or PUL SELECTED) dur b	Follow instructions for dur A
 ENTER	(IF RATE SELECTED) HYS b	Follow instructions for hys A



PRESS

DISPLAY

REMARKS



inPut
rELAYS
LoC

This section of the menu is used to set up the lockout type and code.



LC PG or LC ALL

LC PG = Locks program but presets are accessible.
LC ALL= Locks program & presets. Press the PRGM button to toggle between choices; Press RST/ENTER to enter displayed choice.



CoDE
Press any key to view or change the lock code

When CODE is displayed, press any key to view existing lock code. To change the code press the key under each digit to be changed. Press RST/ENTER to enter displayed value.



inPut
rELAYS
LoC
SEtUP

This section of the menu is used to set up important operating variables.



rDEC

RDEC= rate decimal location; Press the key under the digit with the desired location. Press the "E" key if a decimal is not desired. Press RST/ENTER to enter the displayed location.













SEt HI
Press any key to view or change existing value

SET HI= Rate value for the highest input (5 or 10V; 20mA).(i.e. 20mA = 500 lbs/hr.). Key in the desired high value and press RST/ENTER to enter displayed value.

CONTINUED ON NEXT PAGE

STEP
4
CONT...

**SETTING
SETUP**

<u>PRESS</u>	<u>DISPLAY</u>	<u>REMARKS</u>
 ENTER	LoCUT Press any key to view or change existing value	LO CUT= Low cut-off; Lowest rate value to be recognized. All rate readings below the "cutoff" will assume the "set lo" value. Key in the desired value and press RST/ENTER to enter displayed value.
 ENTER	nor Press any key to view or change existing value	NOR= Normalizing (averaging) factor (00.0 to 99.9); Key in the desired value and press RST/ENTER to enter displayed value. Higher settings provide more normalizing (averaging) for a more stable display.
  PRGM ENTER	SEC, minS, HourS or dAYS	This section tells the unit that the high setting is entered in units per Second, Minute, Hour or Day. Press the PRGM key to step through choices. Press RST/ENTER to enter displayed choice.
 ENTER	tDEC	TDEC= Totalizer Decimal; Press the arrow keys to enter in the desired totalizer decimal. Press RST/ENTER to enter displayed choice. Entering a decimal will add resolution to the total. (i.e. tdec=#####.#; 100 will be displayed as 100.0)
 ENTER	CFDEC	CFDEC= Conversion Factor Decimal; Press the arrow keys to enter in the desired conversion factor decimal. Press RST/ENTER to enter displayed choice.
 ENTER	CFAC	CFAC= Conversion Factor; The conversion factor allows you to convert rate to total volume units.
 ENTER	TMUL Press any key to view or change existing value	TMUL= Totalizer Multiplier; This factor allows you to divide the totalizer by 1, 10, 100, 1000
  PRGM ENTER	1, 10, 100 or 1000	Press the PRGM key to step to the desired factor. Press RST/ENTER to enter displayed choice.





NOTE:
See Appendix i (PG17) for a chart containing common conversion factors



<u>PRESS</u>	<u>DISPLAY</u>	<u>REMARKS</u>	
 PRGM	inPut		
 PRGM	rELAYS		
 PRGM	LoC		
 PRGM	SEtUP	This section of the menu is for setting up the variables for any options which were ordered (Analog out or Serial communications).	
 PRGM	oPt		
 ENTER	out Hi Press any key to view or change existing value		
			OUT HI= The rate value represented by the 20 mA end of the 4-20 mA output. Key in the desired value and press RST/ ENTER to enter displayed value. Press PRGM to recycle through list choices.

THE PROGRAM SETUP IS COMPLETE! YOU ARE NOW READY TO SET THE PRESETS.

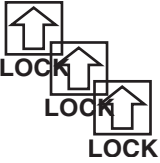
SETTING THE PRESETS & PANEL LOCK

	<u>PRESS</u>	<u>DISPLAY</u>	<u>REMARKS</u>
<div style="border: 1px solid black; border-radius: 15px; padding: 10px; width: fit-content; margin: auto;"> SETTING THE PRESETS </div>	 PRE A	P-r-E A Press any key to view or change existing value	PRE A = Preset A (Final Preset); The set point at which output A will trigger. If the displayed value is not the desired preset, press the key(s) under the digit to be changed.
	 PRE B	P-r-E b Press any key to view or change existing value	PRE B = Preset B (Prewarn); The set point at which output B will trigger. If the displayed value is not the desired preset, press the key(s) under the digit to be changed.
<div style="border: 1px solid black; border-radius: 15px; padding: 10px; width: fit-content; margin: auto;"> SETTING THE LOCK STATUS </div>		LoCkE Press any key to enter the 5-digit lock code.	Key in the lock code (see programming step 3) by pressing the keys under the digits to be changed. Each time a key is pressed the digit will increment one. Press the RST/ENTER key to enter the displayed code.
	 ENTER	LoC or un LoC	After the code is entered the unit will display LOC (unit is locked) or UN LOC (unit is un-locked). This message will be displayed for approximately 3 seconds before the unit returns to the run mode. If an invalid code is entered, no message is displayed; try again.

Press LOCK 3 times within 5 seconds
 (If LOCK is pressed once, unit freezes display)

TROUBLESHOOTING GUIDE

PROBLEM	POSSIBLE CAUSES	SOLUTIONS
Power is applied to unit but the display does not light.	1. AC or DC power wiring is incorrect.	1. Recheck power wiring.
Unit works but occasionally the display freezes or skips counts.	1. Line noise is effecting the processor due to a current spike or surge.	1. Use a different power supply or install a surge suppressor.
Input signal is connected but the unit does not totalize or rate.	1. Input wiring is incorrect 2. High scaling or Low cutoff settings are incorrect. 3. Transmitting device is defective. 4. Unit is defective.	1. Recheck input wiring. 2. Recheck high scaling and low cutoff settings. 3. Replace transmitting device. 4. To confirm set meter for 0-10V input, low @ 0; high @ 10. Apply a 0-10V signal to the voltage input (pin 5). When viewing the rate the meter should display the voltage value that is applied. If not call factory for an RMA#.
Display reading is inaccurate.	1. Input wiring is incorrect.	1. Be sure that voltage signals are connected to voltage input (pin 5) and current signals are connected to current input (pin 4).
Ratemeter works properly but totalizer is incorrect.	1. Time base is incorrect. 2. Conversion factor is incorrect 3. Total multiplier is incorrect	1. Recheck time base setting in setup section of the program menu. 2. Recheck conversion factor settings. 3. Recheck total multiplier factor settings.

IF YOU HAVE ANY OTHER PROBLEMS, PLEASE CALL THE FACTORY.

We hope you will be pleased with our product. If you have any questions concerning our warranty, repair, modification or returned goods process, please contact your local distributor.

WARRANTY

This product is warranted against defects in materials and workmanship for a period of two (2) years from the date of shipment to Buyer.

The Warranty is limited to repair or replacement of the defective unit at the option of the manufacturer. This warranty is void if the product has been altered, misused, dismantled, or otherwise abused.

ALL OTHER WARRANTIES, EXPRESSED OR IMPLIED, ARE EXCLUDED, INCLUDING BUT NOT LIMITED TO THE IMPLIED WARRANTIES OF MERCHANTABILITY AND FITNESS FOR A PARTICULAR PURPOSE.

Kessler - Ellis Products Co.
10 Industrial Way East
Eatontown, NJ 07724
(732) 935 - 1320
Toll Free 800 - 631 - 2165
Fax (732) - 935 - 9344
www.kep.com

DECODING PART NUMBER

SAMPLE: ES756 INT69RT A L 1 A

<p>Series _____ ES756 INT69RT= Ratemeter / Totalizer</p> <p>Operating Voltage _____ A= 110 VAC ± 15% or 12 to 24 VDC B= 220 VAC ± 15% or 12 to 24 VDC</p> <p>Inputs _____ L= Linear (standard) S= Square Law (optional)</p> <p>Control outputs _____ 1= 2 - Open Collector Outputs (standard) 2= 2 - 10 Amp Form C Relays (optional)</p> <p>Options _____ A= Analog Output (4-20 mA)</p>			
---	--	--	--

Accessories

Separate non keyboard panel order # 34235
 Separate keyboard panel order # 34237
 NEMA 4X wall mount enclosure available, see LCN4X & NEMA-1/8DIN
 XHV 7/4 Explosion Proof Housing available, see XHV7/4

Appendix i - Units Conversion Chart

Engineering Units		Total Factor	Total Multiplier	Totalizer	
Rate Unit	Total Unit	(EFAC)	(EMUL)	LSD Value	
Gallons	Gallons	10	1	10	GAL
			100	100	
			1000	1000	
			10000	10,000	
Gallons	Cubic Feet	7.481	1	1	CF
			10	10	
			100	100	
			1000	1000	
Gallons	Acre-Feet	32.59	1	.0001	AFT
			10	.001	
			100	.01	
			1000	.1	
Cubic Feet	Acre-Feet	.2295	1	.0001	AFT
			10	.001	
			100	.01	
			1000	.1	
Liters	Liters	10	10	100	LTR
	Cubic Meters	10	1	100	CM
Cubic Meters	Cubic Meters	1	1	1	CM
			10	10	
			100	100	
			1000	1000	

Consult the factory for total factors and multipliers for engineering units not shown.