**User's
Manual**

**Model RAMC
Metal Short Stroke ROTAMETER**

IM 01R01B02-00E-E

vigilantplant.™

Blank Page

Contents

1. Introduction	1-1
1.1 For Safe Use of Rotameter RAMC.....	1-2
1.2 Warranty.....	1-3
1.3 Notices regarding EMC.....	1-3
1.4 General description.....	1-4
1.5 Principle of measurement	1-4
1.6 Overview.....	1-5
2. Precautions	2-1
2.1 Transportation and storage.....	2-1
2.2 Installation	2-1
2.3 Pipe connections	2-1
3. Installation	3-1
3.1 Installation in the pipeline	3-1
3.2 Wiring of electronic transmitter (-E, -H, -J) and limit switches (/K _□)	3-2
4. Start of operation	4-1
4.1 Hints on flow rate measurement.....	4-1
4.2 Pulsation and pressure shock.....	4-1
4.3 Start of operation of electronic transmitter	4-1
5. Limit switches (Option /K_□)	5-1

6. Electronic Transmitter (-E)	6-1
6.1 Operation principle.....	6-1
6.2 Parameter setting.....	6-1
6.2.1 Selection of indication function (F11)	6-4
6.2.2 Setting the unit (F12 / F13)	6-5
6.2.3 Totalizer reset (F14)	6-7
6.2.4 Selection of temperature unit (F15)	6-7
6.2.5 Setting of damping (F2-).....	6-8
6.2.6 Selection / Adjustment 4-20 mA / 0-20 mA (F3-).....	6-8
6.2.7 Pulse output (F34) (Option /CP).....	6-9
6.2.8 Error messages (F4-).....	6-12
6.2.9 Manual adjustment (F5-)	6-13
6.2.10 Revision indication (F61/F62).....	6-16
6.2.11 Current output test (F63).....	6-16
6.2.12 Switching between standard / Indicator on extension (F64)	6-17
6.2.13 Master Reset (F65).....	6-17
6.2.14 Float blocking indication (F7-).....	6-18
7. HART - Communication	7-1
7.1 General	7-1
7.1.1 Multidrop Mode in the case of using HART 5	7-1
7.1.2 Multidrop Mode in the case of using HART 7	7-2
7.2 Connection	7-3
7.3 HART 5 - Menu (Rev 01 DD rev 02)	7-4
7.4. Description of the HART 5 - Parameter	7-7
7.4.1 Process variables	7-8
7.4.2 Diagnostic- and Service-Menu.....	7-8
7.4.3 Basic-Setup Menu	7-14
7.4.4 Detailed-Setup Menu.....	7-14
7.4.5 Review	7-16

7.5 HART 7 - Menu (Rev 10 DD rev 01)	7-17
7.6. Description of the HART 7 - Parameter	7-29
7.6.1 Process variables	7-29
7.6.2 Diagnostic- and Service-Menu	7-30
7.6.3 Basic- Setup Menu	7-37
7.6.4 Detailed- Setup Menu	7-37
7.6.5 Write protect menu	7-40
7.6.6 Review Menu	7-40
7.6.7 Burst Mode (Only available in HART 7)	7-40
7.6.8 Event Notification (Only available in HART 7).....	7-45
7.6.9 Trend configuration (Only available in HART 7).....	7-48
7.7 Maintenance	7-49
7.7.1 Function test.....	7-49
7.7.2 Troubleshooting.....	7-49
8. Service	8-1
8.1 Maintenance	8-1
8.1.1 Function test.....	8-1
8.1.2 Measuring tube, float	8-1
8.1.3 Explosion drawing.....	8-2
8.1.4 Electronic transmitter	8-3
8.1.5 Exchange of EEPROM and scale	8-3
8.1.6 Exchange of indicator.....	8-4
8.1.7 Troubleshooting.....	8-4
8.2 Template for sending back to service	8-6

9. Technical Data	9-1
9.1 Model- and suffix-codes	9-1
9.2 Options	9-2
9.3 Specifications.....	9-5
9.4 Dimensions and weights.....	9-19
9.5 Temperature graphs for RAMC metal design, standard and intrinsic safe....	9-22
10. Explosion-protected Type Instruments	10-1
10.1 General.....	10-2
10.1.1 Intrinsic safety	10-2
10.1.2 Flame proof	10-2
10.2 Intrinsically safe ATEX certified components (/KS1).....	10-3
10.2.1 Technical data	10-3
10.2.2 Installation	10-4
10.2.3 Marking	10-4
10.3 Intrinsically safe ATEX certified components for category 3G (/KS3).....	10-5
10.3.1 Technical data	10-5
10.3.2 Marking	10-6
10.4 Intrinsically safe IECEx- certified components (/ES1).....	10-7
10.4.1 Technical data	10-7
10.4.2 Installation	10-8
10.4.3 Marking	10-8
10.5 Intrinsically safe IECEx- components for category 3G (/ES3)	10-9
10.5.1 Technical data	10-9
10.5.2 Marking	10-9
10.6 Intrinsically safe INMETRO (Brazil) components (/US1)	10-10
10.6.1 Technical data	10-10
10.6.2 Installation	10-10
10.6.3 Marking	10-10

10.7 Intrinsically safe FM / CSA (USA + Canada) components (/FS1, /CS1)..... 10-11

- 10.7.1 Electronic transmitter (/FS1 for USA, /CS1 for Canada)..... 10-11**
- 10.7.2 Limit switches option /K1 ... /K10 (/FS1 for USA).....10-14**
- 10.7.3 Limit switches option /K1 ... /K3 (/CS1 for Canada)10-14**

10.8 Intrinsically safe NEPSI (China) certified RAMC (/NS1) 10-20

10.9 Intrinsically safe EAC (Russia, Belarus, Kazakhstan)certified RAMC (/GS1) 10-21

10.10 Intrinsically safe PESO (India) certified RAMC 10-21

10.11 Flame proof and dust proof ATEX certified RAMC (/KF1) 10-22

- 10.11.1 Technical data 10-22**
- 10.11.2 Installation..... 10-23**
- 10.11.3 Operation..... 10-23**

10.12 Flame proof and dust proof IECEx certified RAMC (/EF1)..... 10-24

- 10.12.1 Technical data..... 10-24**
- 10.12.2 Installation 10-25**
- 10.12.3 Operation 10-25**

10.13 Intrinsically safe ATEX certified components in dust proof RAMC-housing (/KS2) 10-26

10.14 Intrinsically safe IECEx certified components in dust proof RAMC- housing (/ES2) 10-26

10.15 Flame proof and dust proof NEPSI (China) certified RAMC (/NF1) 10-27

- 10.15.1 Technical data..... 10-27**
- 10.15.2 Installation 10-27**
- 10.15.3 Operation 10-28**

10.16 Flame proof EAC (Russia, Belarus, Kazakhstan) certified RAMC (/GF1) . 10-28

- 10.16.1 Technical data..... 10-28**
- 10.16.2 Installation10-28**
- 10.16.3 Operation10-28**

10.17 ATEX registered non-electrical RAMC (/KC1)	10-29
10.17.1 Technical data	10-29
10.17.2 Safety Instructions	10-29
10.17.3 Marking	10-29
10.18 EAC certified non-electrical RAMC (/GC1)	10-30
10.18.1 Technical data.....	10-30
10.18.2 Safety Instructions.....	10-30
10.18.3 Marking	10-30
10.19 Flame proof and dust proof RAMC with Taiwan	10-31
10.20 Flame proof and dust proof PESO (India) certified RAMC	10-31
11. Instructions for PED	11-1
APPENDIX 1. SOFTWARE CHANGE HISTORY	A1-1
APPENDIX 2. Safety Instrumented Systems Installation	A2-1
A2.1 Scope and Purpose	A2-1
A2.2 Using RAMC for a SIS Application	A2-1
A2.2.1 Safety Function.....	A2-1
A2.2.2 Diagnostic Response Time.....	A2-2
A2.2.3 Setup.....	A2-2
A2.2.4 Proof Testing.....	A2-2
A2.2.5 Repair and replacement	A2-2
A2.2.6 Startup Time.....	A2-3
A2.2.7 Reliability data	A2-3
A2.2.8 Lifetime limits	A2-3
A2.2.9 Environmental limits	A2-3
A2.2.10 Application limits.....	A2-3
A2.3 Definitions and Abbreviations	A2-4
A2.3.1 Definitions.....	A2-4
A2.3.2 Abbreviations.....	A2-4
A2.4 Assessment results	A2-4
A2.4.1 Safety related parameters	A2-4

1. Introduction

Before use, read this manual thoroughly and familiarize yourself fully with the features, operations and handling of Rotameter RAMC to have the instrument deliver its full capabilities and to ensure its efficient and correct use.

Notices Regarding This Manual

- This manual should be passed to the end user.
- The contents of this manual are subject to change without prior notice.
- All rights reserved. No part of this document may be reproduced or transmitted in any form or by any means without the written permission of Rota Yokogawa (hereinafter simply referred to as Yokogawa).
- This manual neither does warrant the marketability of this instrument nor it does warrant that the instrument will suit a particular purpose of the user.
- Every effort has been made to ensure accuracy in the contents of this manual. However, should any questions arise or errors come to your attention, please contact your nearest Yokogawa sales office that appears on the back of this manual or the sales representative from which you purchased the product.
- This manual is not intended for models with custom specifications.
- Revisions may not always be made in this manual in conjunction with changes in specifications, constructions and/or components if such changes are not deemed to interfere with the instrument's functionality or performance.

Notices Regarding Safety and Modification

- For the protection and safety of personnel, the instrument and the system comprising the instrument, be sure to follow the instructions on safety described in this manual when handling the product. If you handle the instrument in a manner contrary to these instructions, Yokogawa does not guarantee safety.
- If this instrument is used in a manner not specified in this manual, the protection provided by this instrument may be impaired.
- As for explosion proof model, if you yourself repair or modify the instrument and then fail to return it to its original form, the explosion protected construction of the instrument will be impaired, creating a hazardous condition. Be sure to consult Yokogawa for repairs and modifications.

The following safety symbols and cautionary notes are used on the product and in this manual:



WARNING

This symbol is used to indicate that a hazardous condition will result which, if not avoided, may lead to loss of life or serious injury. This manual describes how the operator should exercise care to avoid such a risk..



CAUTION

This symbol is used to indicate that a hazardous condition will result which, if not avoided, may lead to minor injury or material damage. This manual describes how the operator should exercise care to avoid a risk of bodily injury or damage to the instrument.



IMPORTANT

This symbol is used to call your attention to a condition that must be observed in order to avoid the risk of damage to the instrument or system problems.



NOTE

This symbol is used to call your attention to information that should be referred to in order to know the operations and functions of the instrument.



This sign on the instrument denotes information in the instruction manual.

1.1 For Safe Use of Rotameter RAMC



WARNING

(0) General

- Working with bare skin should not be done.
- Working with wet hand, body should not be done.

(1) Installation

- Installation of the RAMC variable area flowmeter must be performed by expert engineer or skilled personnel. No operator shall be permitted to perform procedures relating to installation.
- The RAMC flowmeter is a heavy instrument. Be careful that no damage is caused to personnel through accidentally dropping it, or by exerting excessive force on the RAMC flowmeter.
- All procedures relating to installation must comply with the electrical code of the country where it is used.

(2) Wiring

- The wiring of the RAMC flowmeter must be performed by expert engineer or skilled personnel. No operator shall be permitted to perform procedures relating to wiring.
- When connecting the wiring, check that the supply voltage is within the range of the voltage specified for this instrument before connecting the power cable. In addition, check that no voltage is applied to the power cable before connecting the wiring.
- The protective grounding must be connected securely at the terminal with the  mark to avoid danger to personnel (only AC type).

(3) Operation

- Do not open the cover until the power has been off for at least 10 minutes because of electric shock and hot temperatures inside. Only expert engineer or skilled personnel are permitted to open the cover.
- When the RAMC flowmeter is processing hot fluids, the instrument itself may become extremely hot. Take sufficient care not to get burnt.
- If the fluid temperature is above 65° C it has to be ensured, that an easy touch by humans is prohibited (e.g. by installation, by a barrier, by a warning).

- Where the fluid being processed is a toxic substance, avoid contact with the fluid and avoid inhaling any residual gas, even after the instrument has been taken off the line for maintenance and so forth.

(4) Maintenance

- Maintenance on the RAMC flowmeter should be performed by expert engineer or skilled personnel. No operator shall be permitted to perform any operations relating to maintenance.
- Always conform to maintenance procedures outlined in this manual. If necessary, contact Yokogawa.
- Care should be taken to prevent the build up of dirt, dust or other substances on the display panel glass. If these surfaces do get dirty, wipe them clean with a soft dry cloth.
- Don't open the cover in rainy weather
- Don't open the cover as long as the power is connected because of electric shock.
- The electronic assembly contains sensitive parts. Take care so as not to directly touch the electronic parts or circuit patterns on the board, and by preventing static electrification using grounded wrist straps when handling the assembly.

(5) European Pressure Equipment Directive (PED)

- When using the instrument as a PED-compliant product, be sure to read Chapter 11 before use.

(6) Hazardous Duty Type Instruments

- For explosion proof type instruments the description in chapter 10 "EXPLOSION PROTECTED TYPE INSTRUMENT" has priority to the other descriptions in this instruction manual.
- All instruction manuals for ATEX Ex related products are available in English, German and French. Should you require Ex related instructions in your local language, you should contact your nearest Yokogawa office or representative.
- Only trained personnel should install and maintain instruments in hazardous areas.

1.2 Warranty

- The warranty of this instrument shall cover the period noted on the quotation presented to the Purchaser at the time of purchase. The Seller shall repair the instrument free of charge when the failure occurred during the warranty period.
- All inquiries on instrument failure should be directed to the Seller's sales representative from whom you purchased the instrument or your nearest sales office of the Seller.
- Should the instrument fail, contact the Seller specifying the model and instrument number of the product in question. Be specific in describing details on the failure and the process in which the failure occurred. It will be helpful if schematic diagrams and/or records of data are attached to the failed instrument.
- Whether or not the failed instrument should be repaired free of charge shall be left solely to the discretion of the Seller as a result of an inspection by the Seller.

The Purchaser shall not be entitled to receive repair services from the Seller free of charge, even during the warranty period, if the malfunction or damage is due to:

- improper and/or inadequate maintenance of the instrument in question by the Purchaser.
- handling, use or storage of the instrument in question beyond the design and/or specifications requirements.
- use of the instrument in question in a location not conforming to the conditions specified in the Seller's General Specification or Instruction Manual.
- retrofitting and/or repair by an other party than the Seller or a party to whom the Seller has entrusted repair services.
- improper relocation of the instrument in question after delivery.
- reason of force measure such as fires, earthquakes, storms/ floods, thunder/lightning, or other reasons not attributable to the instrument in question.

1.3 Notices regarding EMC

The Rotameter RAMC is conform to the European EMC Guideline and fulfills the following standards:

- EN 61326-1
- EN 55011
- NAMUR recommandation NE 21

The RAMC is a class A product and should be used and installed properly according to the EMC Class A requirements.

Requirement during immunity tests:

The output signal fluctuation is specified within the ± 4 % output span.

Although the transmitter has been designed to resist high frequency electrical noise, if a radiotransceiver is used near the transmitter or its external wiring, the transmitter may be affected by high frequency noise pickup. To test for such effects, bring the transceiver in use slowly from a distance of several meters from the transmitter and observe the measurement loop for noise effects. Thereafter, always use the transceiver outside the area affected by noise.

Mount the attached ferrite core as shown in chapter 3.2.

1.4 General description

This manual describes installation, operation and maintenance of the RAMC. Please read it carefully before using this device.

Further, please note that customer features are not described in this manual. When modifying specifications, construction or parts, this manual is not necessarily revised unless it can be assumed that these changes will impair RAMC functions or performance.

All units are thoroughly tested before shipping. Please check the received units visually to ensure that they have not been damaged during transport. In case of defects or questions please contact your nearest YOKOGAWA service centre or sales office. Please describe any defect precisely and indicate model code as well as serial number.

YOKOGAWA refuses any liability for units which have been repaired by the user without prior consent and do not meet the specifications as a consequence.

1.5 Principle of measurement

The RAMC is a Variable Area Flow Meter for volume and mass measurements of gases and liquids. A float, whose movement is nearly independent of viscosity is guided concentrically in a specially shaped cone. The position of the float is transferred magnetically to the indicator, which shows the measurement values by a pointer on a scale. The indicator can be equipped with limit switches and an electronic transmitter.

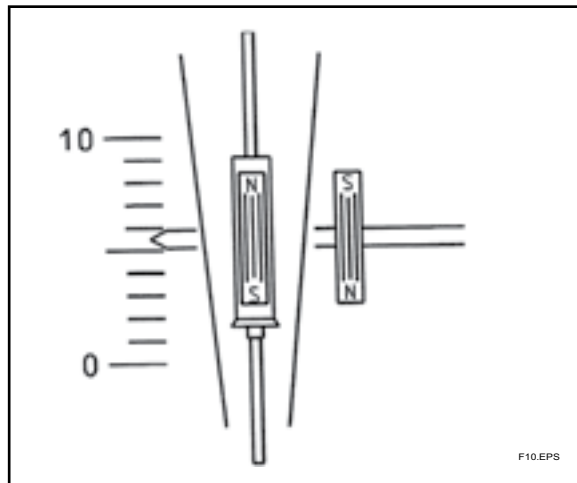

Fig. 1-1

All units are calibrated with water by the manufacturer. By adjusting the calibration values to the measured substance's state of aggregation (density, viscosity), the flow rate scale for each measuring tube can be determined.

Indication units can be exchanged without impairment of precision. However, the scale for the tube must be mounted on the new indicator (and in case of an electronic transmitter the calibration EEPROM, too).

1.6 Overview

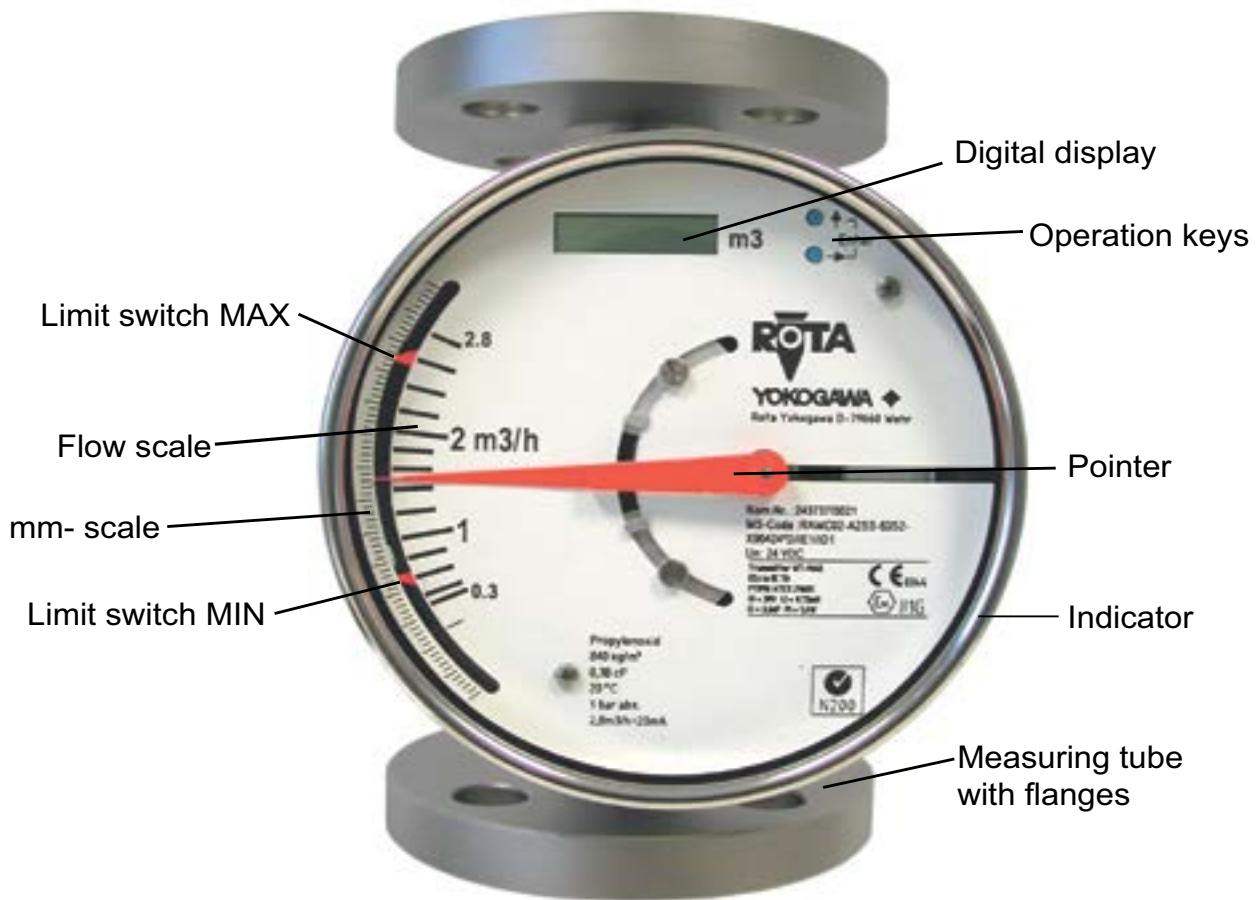

Fig. 1-2

Explanations of specifications on flanges

- type of flange e.g. DIN
- size of flange e.g. DN15
- Pressure range of flange and measuring tube e.g. PN40
- Material of wetted parts e.g. 1.4404
- Manufacturing code of flange manufacturer
- Lot. No.

Scale examples

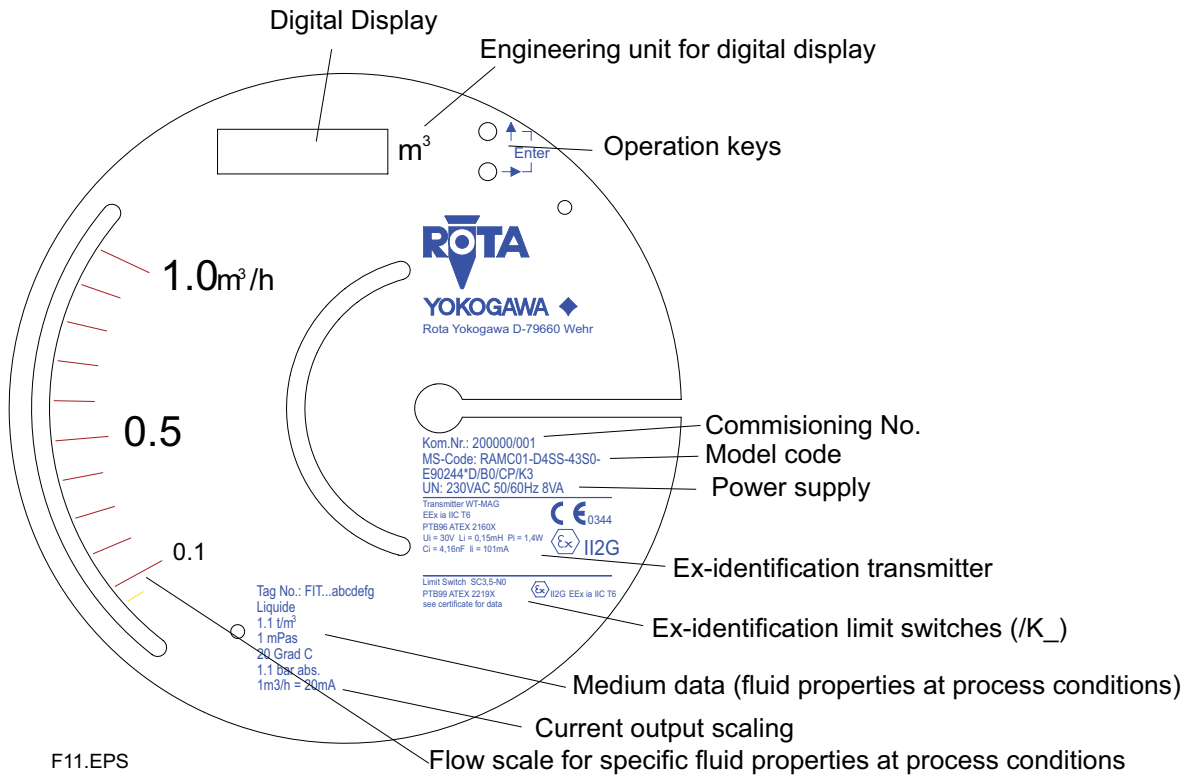

Fig. 1-3 Scale example for -E / -H / -J -type (electronic transmitter)

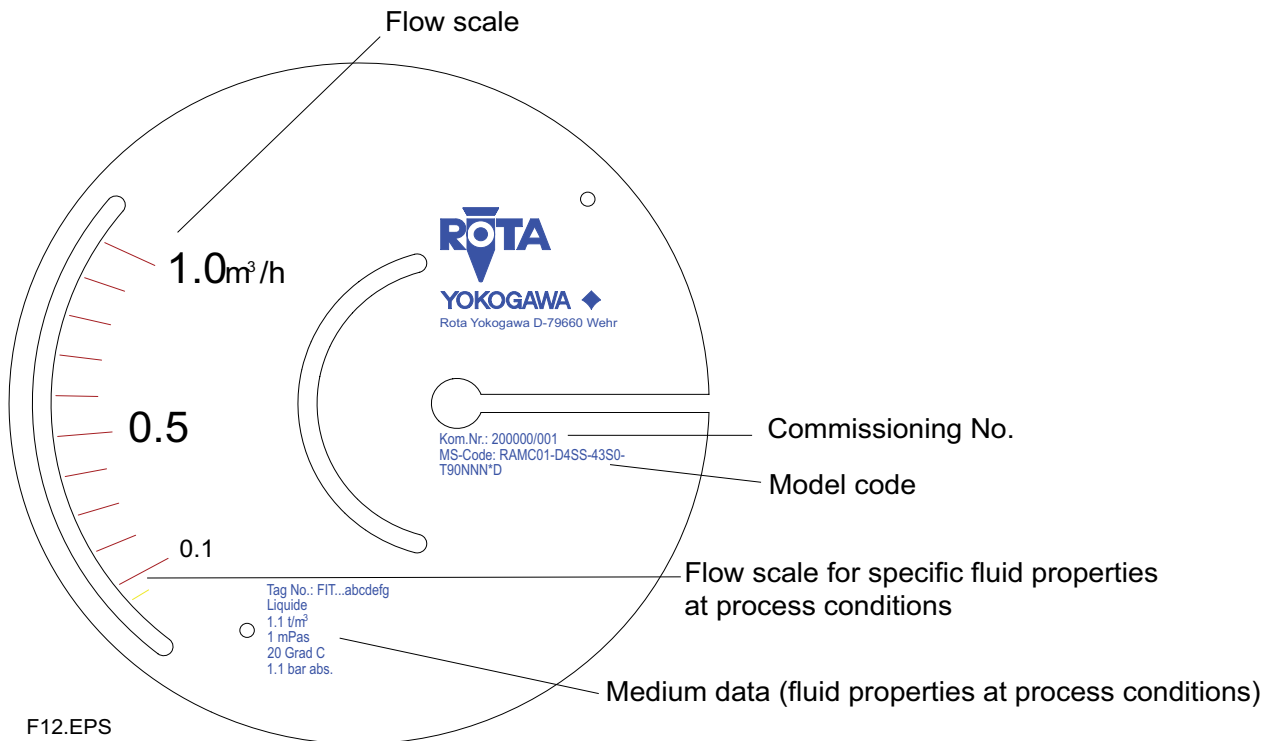

Fig. 1-4 Scale example for -T -type

2. Precautions

2.1 Transportation and storage

Before transporting the unit, it is recommended to fix the float with a card-board strip in the same way as when shipped from factory. Prevent foreign objects from entering the tube (e.g. by covering openings). To protect the unit and especially the tube's interior from soiling, store it only at clean and dry locations

2.2 Installation

Ambient temperature and humidity of the installation location must not exceed the specified ranges. Avoid locations in corrosive environments. If such environments are unavoidable, ensure sufficient ventilation. Although the RAMC features a very solid construction, the instrument should not be exposed to strong vibration or impact stress.

Please note that the RAMC's magnetic sensing system can be influenced by external inhomogeneous magnetic fields (such as solenoid valves). Alternating magnetic fields (≥ 10 Hz) as well as homogeneous, static magnetic fields (in the area of the RAMC), like the geomagnetic field have no influence. Asymmetric ferromagnetic bodies of considerable mass (e.g. steel girders) should be kept at a distance of at least 250 mm from the RAMC.

To avoid interference, the distance between two adjacent RAMC must be at least 300 mm.

2.3 Pipe connections

Ensure that the bolts of the flanges are tightened properly and that the gaskets are tight.

Do not expose the unit to pressures higher than the indicated maximum operating pressure (refer to specifications).

While the system is pressurized the flange bolts must not be tightened or loosened.

Blank Page

3. Installation

3.1 Installation in the pipeline

Be sure to remove the transport lock card-board strip from the measuring tube. Check that no cardboard remains in the tube.

The RAMC flow rate meter must be installed in a vertical pipeline, in which the medium flows upwards. The vertical position has to be checked at the outer edge of the flanges. Bigger nominal diameters (DN80/DN100) require straight pipe sections of at least 5D in front and behind the RAMC.

The nominal diameter of the RAMC should correspond to the nominal diameter of the pipeline.

To avoid stress in the connecting pipes, the connecting flanges must be aligned in parallel and axial direction.

Bolts and gaskets have to be selected according to the maximum operating pressure, the temperature range and corrosion conditions. Center gaskets and tighten nuts with a torque appropriate for the pressure range.

If contamination or soiling of the RAMC is to be expected, a bypass should be installed to allow the removal of the instrument without interruption of the flow.

Please read also chapter 2.2. For further instructions on installation please refer to VDI/VDE3513.

Tightening of the flange threads for RAMC with PTFE- liner with the following torques:

Nominal Size				Bolts			Maximum Torque			
EN 1092-1		ASME B 16.5		EN 1092-1	ASME		EN 1092-1		ASME 150 lbs	
DN	PN	Inches	lbs		150 lbs	300 lbs	Nm	ft*lbf	Nm	ft*lbf
15	40	½	150/300	4 x M12	4 x ½"	4 x ½"	9.8	7.1	5.2	3.8
25	40	1	150/300	4 x M12	4 x ½"	4 x ½"	21	15	10	7.2
50	40	2	150/300	4 x M16	4 x 5/8"	8 x 5/8"	57	41	41	30
80	16	3	150/300	4 x M16	4 x 5/8"	8 x ¾"	47	34	70	51
100	16	4	150/300	4 x M16	8 x 5/8"	8 x ¾"	67	48	50	36

3.2 Wiring of electronic transmitter (-E, -H, -J) and limit switches (/K□)

Please regard the drawings on the following pages.

On the rear of the RAMC are two cable glands for round cables with a diameter of 6 to 9 mm (not for Ex-d-type option /□F1). Unused glands must be closed with a blind plug M16x1.5.

For wiring of RAMC with option/□F1 see chapter 10.10.2, 10.11.2, 10.14.2.

Wires should not be bent directly at terminal screws. Do not expose wires to mechanical pressure. Wires must be arranged according to common installation rules, especially signal and power lines must not be bundled together. Cables should not be bent directly after the cable gland. Do not fix cable at the measuring tube.

The RAMC terminals accept wires with a maximum sectional area of 1.5 mm².

The attached ferrite core must be mounted on the cable as shown on the below picture. Distance "L" < 2 cm.



Measuring and indicating instruments, connected in series to the output of the electronic transmitter, must not exceed a load impedance of $R_L = (U - 13.5 \text{ V}) / 20 \text{ mA}$ — for 2-/3-wire RAMC or 500 Ω for 4-wire RAMC.

2- or 3-wire units are connected to the terminals marked "+", "-", and "A" of the power connector.

For 2-wire instruments the terminals "-" and "A" have to be shorted with a jumper. Take care not to loose that jumper when mounting wires.

Wiring inside the case should be kept as short as possible to avoid that moving parts are blocked.

Attention: Hints for Unit Safety (according DIN EN 61010-1)

- Do not connect cables outdoors in wet weather in order to prevent damage from condensation and to protect the insulation, e.g. inside the terminal box of the flowmeter.
- Heed the nominal voltage indicated on the scale.
- Use the cables which fulfill specification and check before wiring.
- The electrical connections have to be executed according to VDE0100 "Errichten von Starkstromanlagen mit Nennspannungen bis 1000 V" (Installation of high current assemblies with nominal voltages of up to 1000 V) or equivalent national regulations.
- For units with a nominal voltage of 115 V or 230 V the correspondingly marked terminal has to be connected to protective earth (PE).
- Units with a nominal voltage of 24 V may only be connected to a protected low voltage circuit (SELV-E according to VDE0100/VDE 0106 or IEC 364/IEC 536).
- The RAMC indicator housing must be grounded to ensure electromagnetic interference protection. This can be done by grounding the pipeline.
- Once all wiring is complete, check the connections before applying power to the instrument. Improper arrangements or wiring may cause a unit malfunction or damage.
- This unit does not include a power switch. Therefore, a switch has to be prepared at the installation location in the vicinity of the unit. The switch should be marked as the power separation switch for the RAMC.

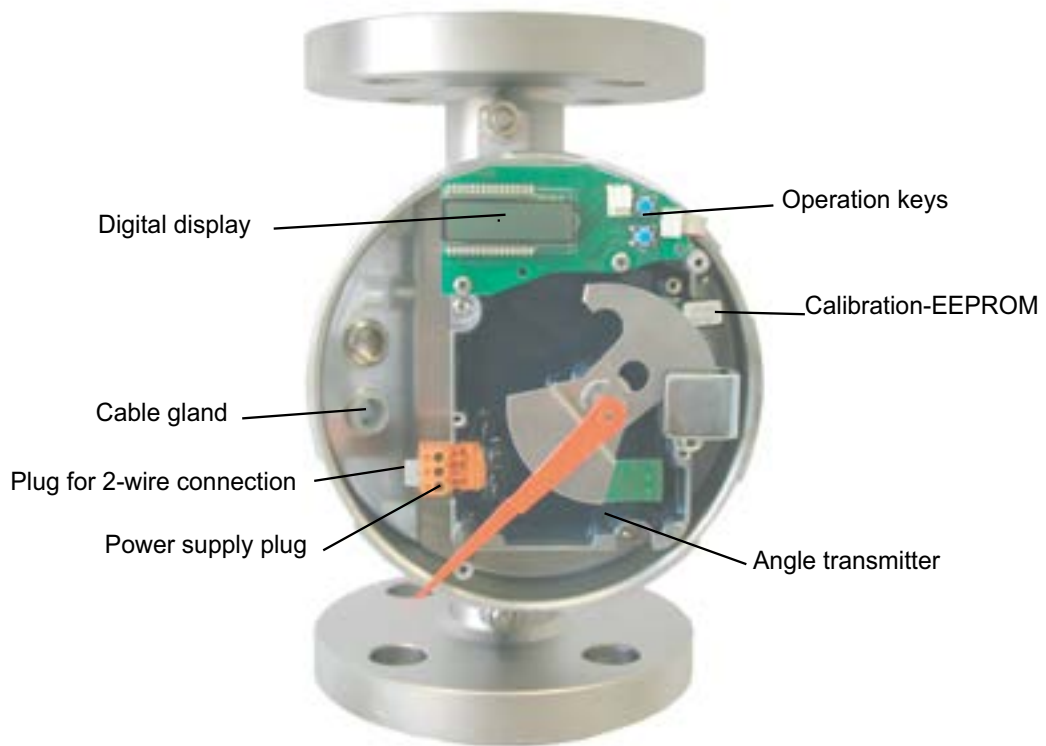

Fig. 3-1 2-wire unit

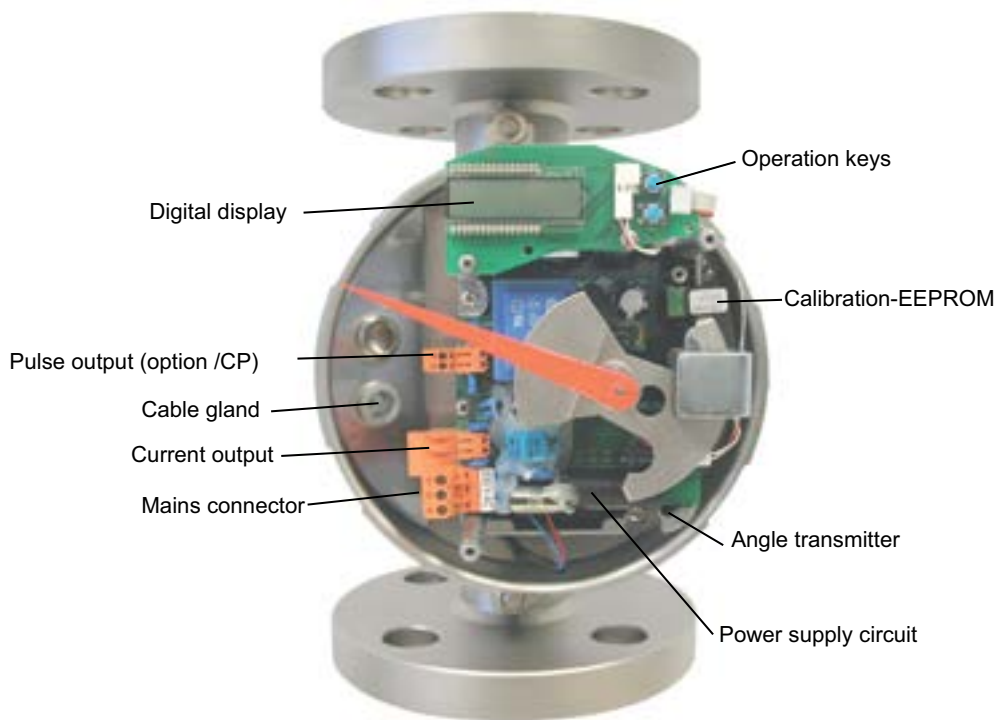

Fig. 3-2 4-wire unit

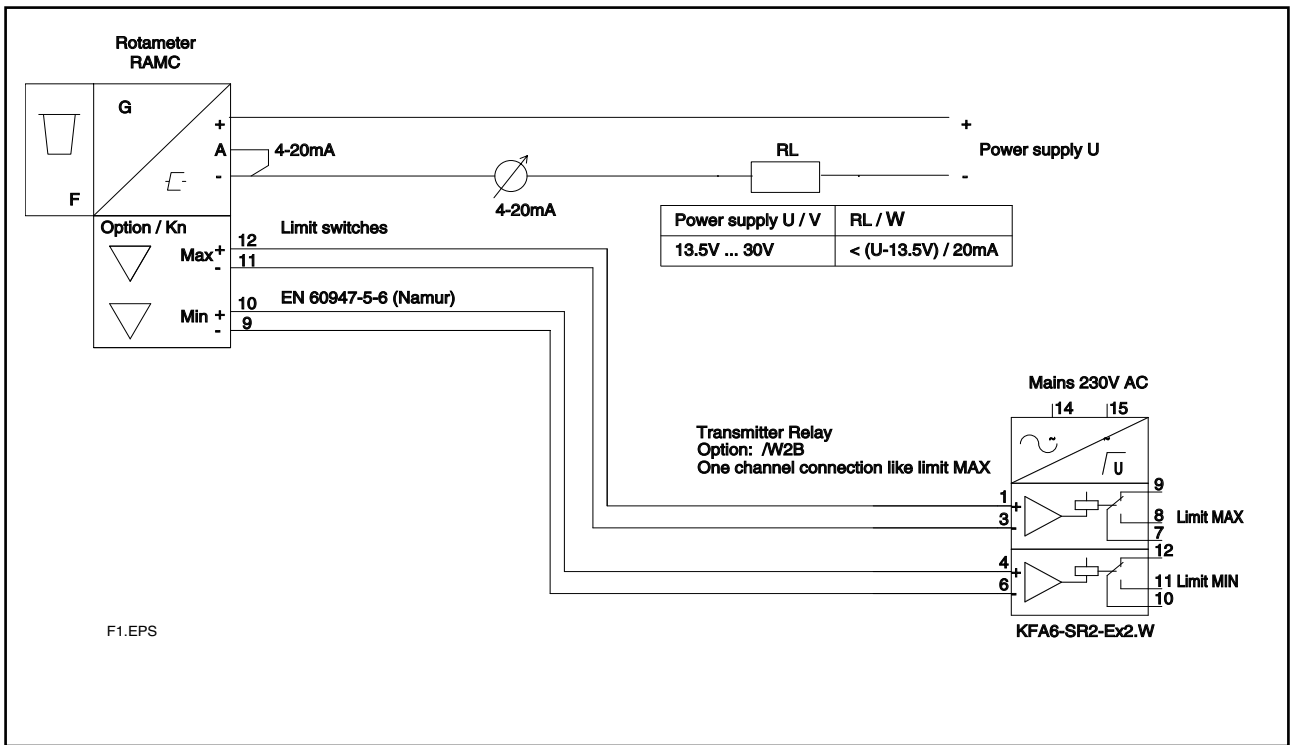

Fig. 3-3 RAMC 2-wire unit with limit switches and transmitter relay

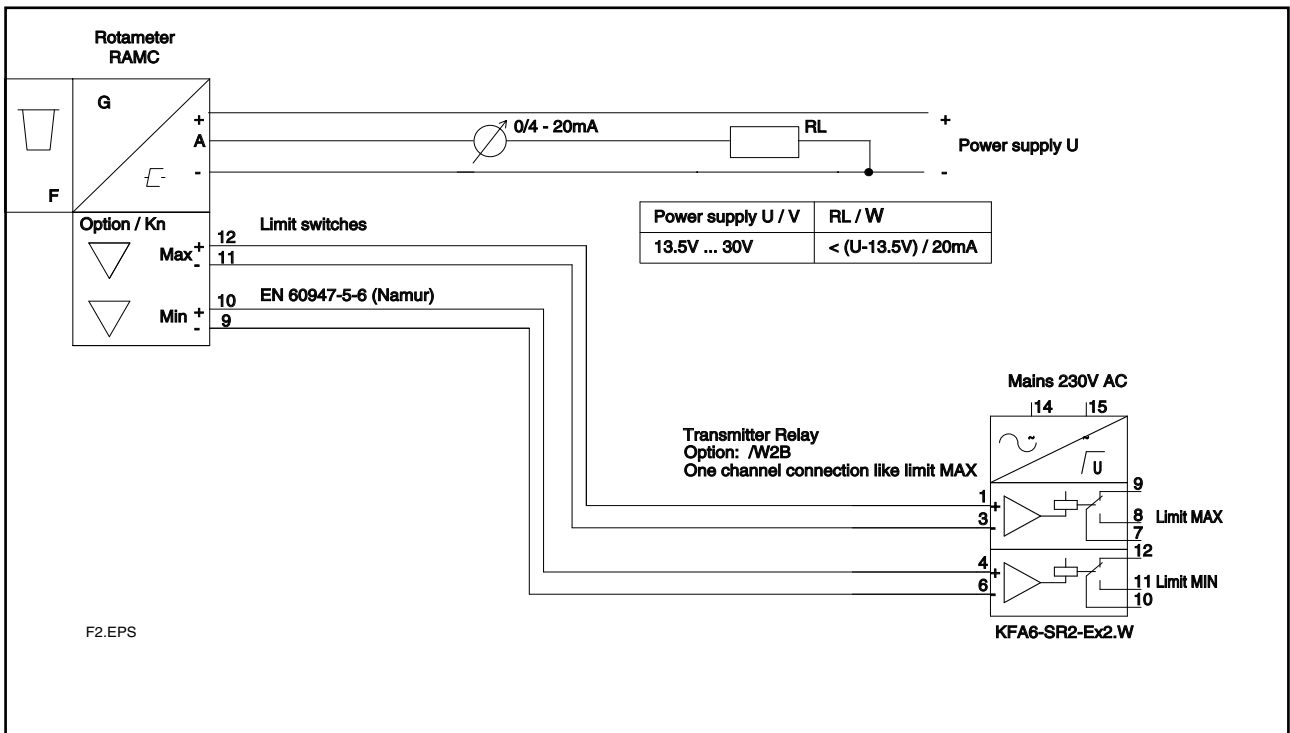

Fig. 3-4 RAMC 3-wire unit with limit switches and transmitter relay

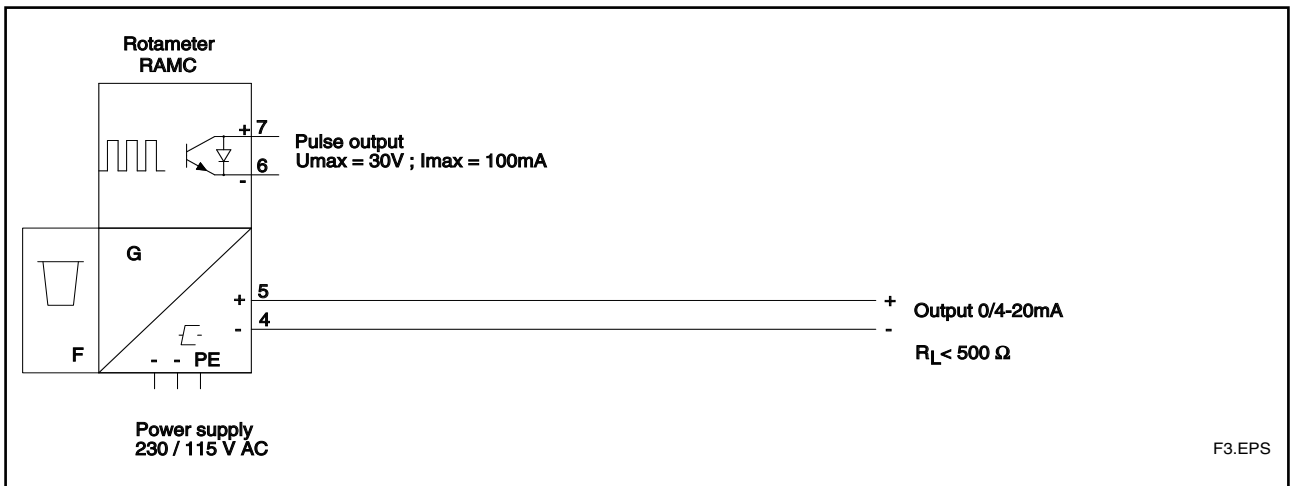

Fig. 3-5 RAMC 4-wire unit with pulse output

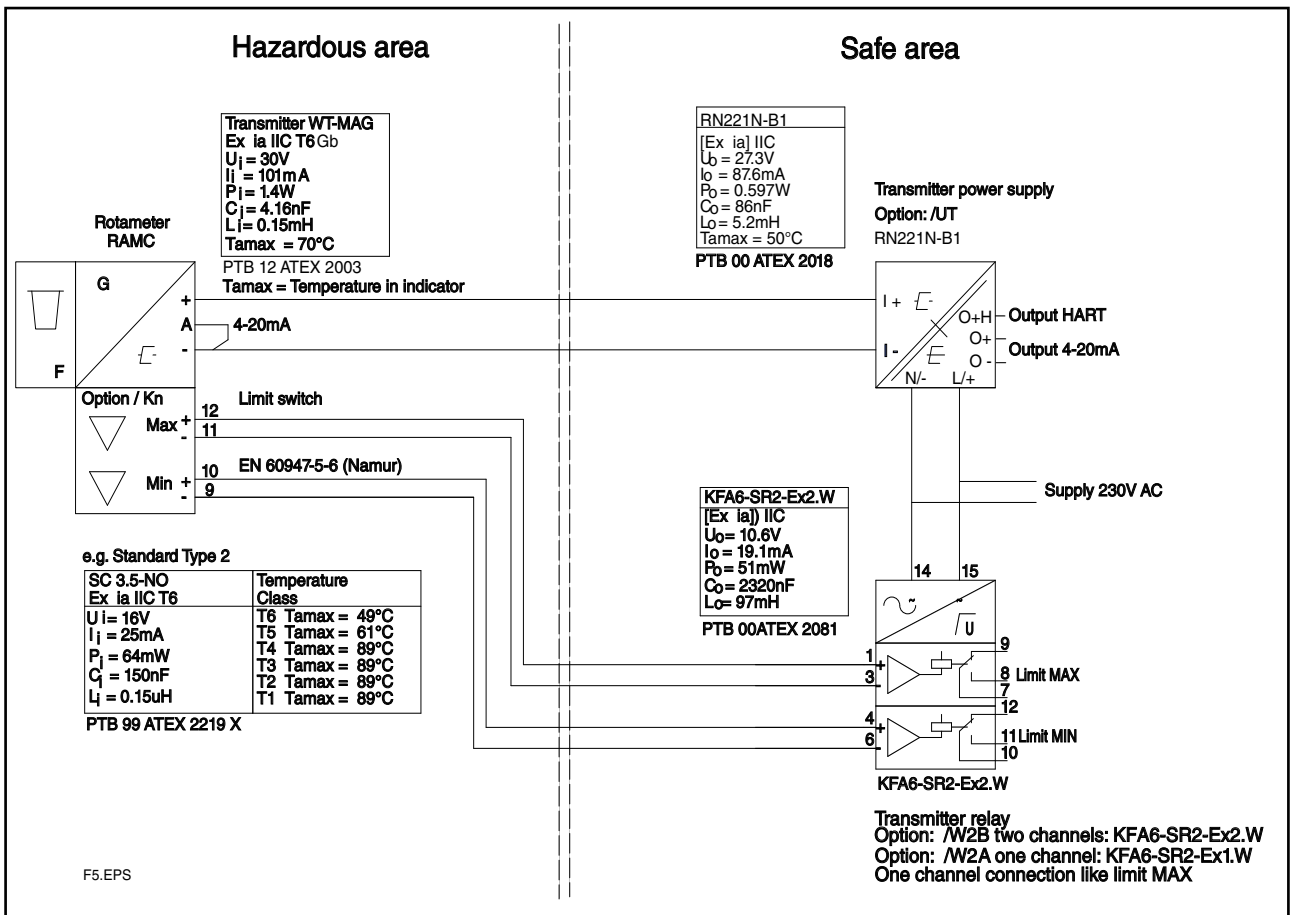

Fig. 3-6 Ex-version acc. to ATEX (Option /KS1 and /KS2) : RAMC 2-wire unit with power supply, limit switches and transmitter relay

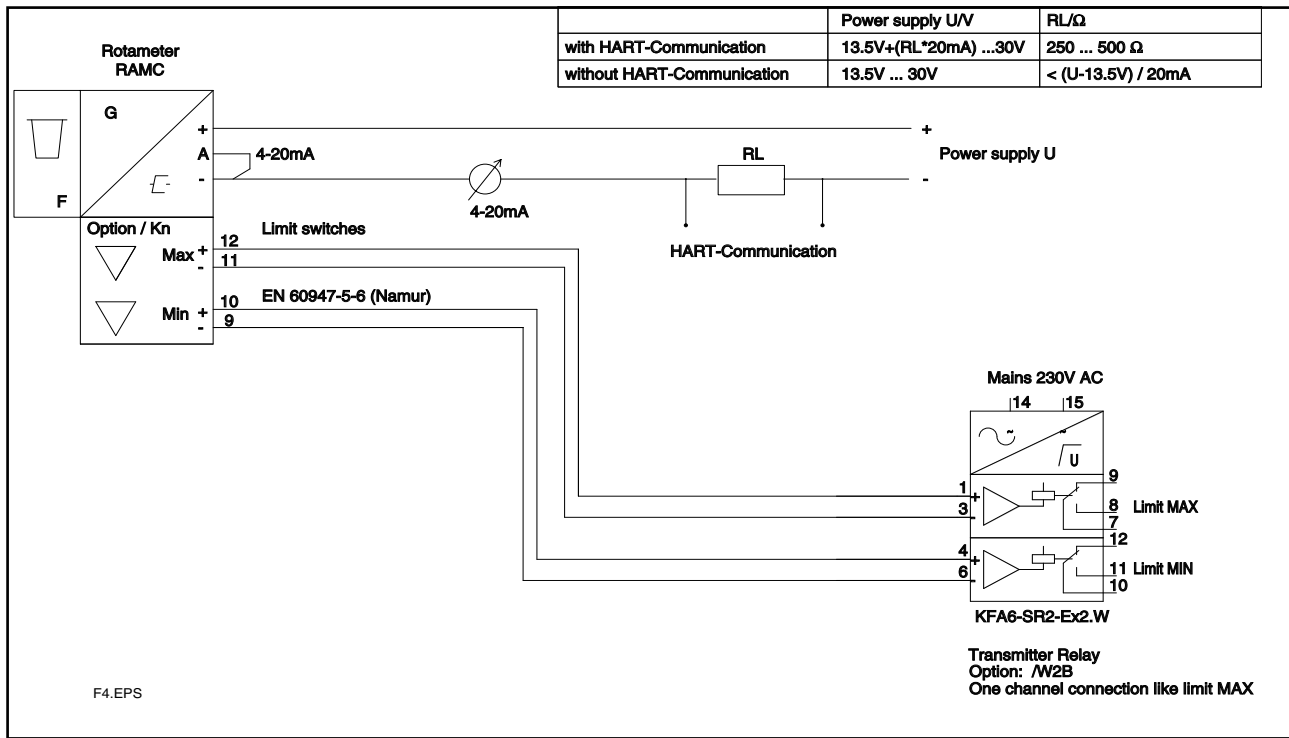

Fig. 3-7 RAMC 2-wire unit with HART-communication, with limit switches and transmitter relay

4. Start of operation

4.1 Hints on flow rate measurement

The measured fluid should neither consist of a multi-phase mixture nor contain ferrite ingredients or large solid mass particles.

The **RAMC** scale is adjusted to the state of operation/aggregation of the measured fluid by the manufacturer. If the state of operation changes, it might become necessary to establish a new scale. This depends on several factors:

- If the **RAMC** is operated in the given viscosity independent range, only the density of the float as well as the operational density of the previous and new substance have to be considered. In case the operational density only changes marginally ($\leq 0.5\%$), the present scale can be used.
- If the **RAMC** is operated outside the given viscosity independent range, the viscosities at the previous and new state of operation as well as the mass and diameter of the float have to be taken into account.

4.2 Pulsation and pressure shock

Pressure shock waves and pulsating flow influence measurement significantly or can destroy the meter. Surge conditions should be avoided. (open valves slowly, raise operating pressure slowly)

If float bouncing occurs in gases increase the line pressure until the phenomena stops. If this is not possible provide the float with a damper. A damping kit is available as spare part.

4.3 Start of operation of electronic transmitter

Ensure that the device has been connected correctly according to section 3-2 and that the used power supply meets the requirements indicated on the scale.

Switch on the power supply.

The digital display gives the totalizer value in the measuring unit, indicated on the right side of the display.

The **RAMC** is now ready for operation.

Unit graduation, measuring unit, damping, etc. can be adjusted by an operating menu (refer to section 6.2). In case of an error, the bars beneath the 8 digits of the display will flash. The corresponding error message can be checked using the operating menu and then taking the appropriate counter measures (refer to section 6-2-8 "Error Messages").

The transmitter has been prepared and calibrated according to the model code as a 2-, 3- or 4-wire unit.

In 2-wire units, a jumper connects "A" and "-." When switching from a 2- to a 3-wire configuration, this jumper should be removed. The current output should then be adjusted as explained in section 6-2-6.

When changing from a 3- to 2-wire configuration, the jumper should be set in place, and the current output has to be adjusted according to section 6-2-6.

Blank Page

5. Limit switches (Option /K□)

The optional limit switches are available as maximum or minimum type switches. They are proximity switches according to EN 60947-5-6 (NAMUR). Maximum two switches can be installed. The option (/W□□) includes the respective transmitter relay.

These switches have been specified for hazardous area. However, the transmitter relay must be installed in safe area.

The limit switches are connected to the transmitter relays as indicated in chapter 3.2.

The terminals for the limit switches are on a small board on top of the transmitter case.

Use of 2 standard limit switches (option /K3):

The MIN-MIN and MAX-MAX functions have been integrated at the factory as MIN-MAX switches in the RAMC. The MIN-MIN or MAX-MAX function is set by adjusting the switching direction of the transmitter relay. The concerning 2- channel transmitter relays are:

Option /W1B: KFA5-SR2-Ex2.W

Option /W2B: KFA6-SR2-Ex2.W

Option /W4B: KFD2-SR2-Ex2.W

The following table shows the assignment:

Function		Switching direction of transmitter relay *	
Channel 1	Channel 2	Channel 1	Channel 2
MIN	MAX	S1 position I	S2 position I
MIN	MIN	S1 position I	S2 position II (ON)
MAX	MAX	S1 position II (ON)	S2 position I

* see following figure for S1 and S2 on transmitter relay.

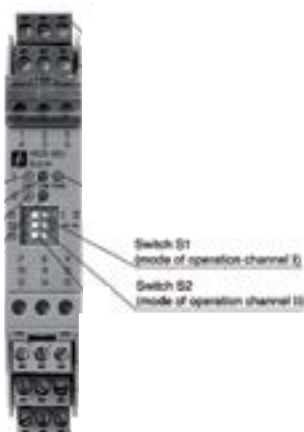

Use of Fail Safe limit switches (option /K6.../K10):

For Fail Safe application only 1- channel transmitter relays are available.

Option /W2E: KHA6-SH-Ex1.W

Option /W2F: 2 x KHA6-SH-Ex1.W

Option /W4E: KFD2-SH-Ex1.W

Option /W4F: 2 x KFD2-SH-Ex1.W

If other transmitter relays are used as the above mentioned types, the transmitter relay has to be applied as protection technology to ensure functional safety.

Please notice chapter 9.3 "Standard specifications".

For questions regarding protection technology, please consult your YOKOGAWA service center.

Blank Page

6. Electronic Transmitter (-E)

6.1 Operation principle

The position of the float is magnetically transferred to a magnetic follow up system. The position angle of this magnetic rocker is detected by magnet sensors. A micro controller determines the angle by means of a combining reference value table in the memory and calculates the flow rate by the angle with calibration and operation parameters the calibration EEPROM. The flow rate is given as a current, either 0-20 mA or 4-20 mA, and, in addition, indicated on the digital display (refer also to section 6-2). The electronic transmitters have been electronically adjusted before shipping and, therefore, are mutually exchangeable.

Calibration data of the metering tube as well as customer specific data are entered into a calibration EEPROM, inserted on the board. This calibration EEPROM and the indication scale are assigned to the respective metering tube.

When replacing an indicator (e.g. because of a defect) the scale and calibration EEPROM of the old unit have to be inserted in the new unit. Then, no calibrations or adjustments are necessary.

If an indicator with electronic transmitters is installed to a new metering tube, the calibration EEPROM of that tube has to be inserted into the transmitter and the indicator scale for that particular tube has to be mounted.

A change in the fluid data (e.g. specific gravity, pressure, etc.) requires the preparation and mounting of a new calibration EEPROM and scale.

Normally the range of the current output is equal to the rounded measuring range of the tube (end value on scale). The customer can position the 20 mA point between 60% and 100% of the end value on scale. The set of the 20 mA point is shown on the scale (refer to Fig. 1-4). The flow cut off is positioned at 5 % of the end value. Below 5 % flow the current output shows 0 mA (4 mA).

6.2 Parameter setting

The displays allows indication of various parameters:

- Flow rate (8 mass or volume units in combination with 4 time units)
- Counter (8 mass or volume units)
- Flow rate indication in percent
- Special functions
- Setting of different damping times
- Switching of current output 0-20 mA / 4-20 mA or vice versa
- Indication of error messages
- Manual adjustment
- Service functions
- Detection of float blockage

The setting of these parameters is done by two buttons.

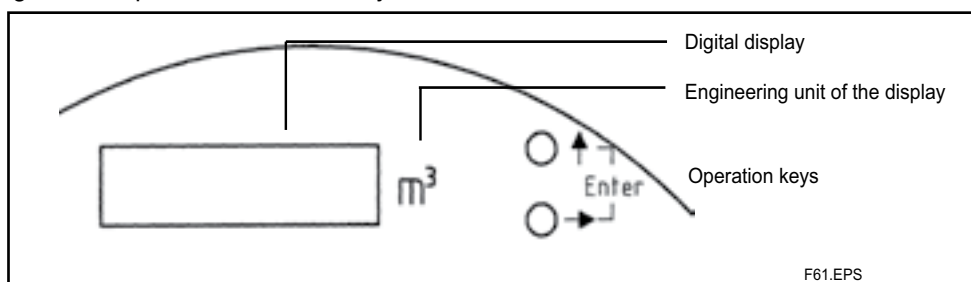

Fig. 6-1 Operation keys

The buttons access three functions:

- upper button (↑) : Exit setting mode
- lower button (→) : Scroll through menu/selection of parameters
- both buttons (↑ + →) = Enter : Entering parameters/selecting setting mode

If no button is pressed for one minute while the operating menu is active, the indication reverts to the measuring indication. This does not apply to subfunctions F32, F33, F52, F63.

For indication of volume or mass values at maximum 6 digits in front of the decimal point and 7 decimals are used. This format allows an indication range for flow rates from 0.0000001 unit/time to 106000 unit/time. Flow rate values exceeding 106000 are shown as '————' on the display. In this case the next bigger flow rate unit (next smaller time unit) has to be selected.

For the indication of totalizers values 8 digits are used at maximum of which 7 digits can be assigned for decimal values. The decimal point setting is determined by selecting the unit. Therefore, possible totalizer offsets are:

Unit *1

Unit *1/10

Unit *1/100

The totalizer counts up to 99999999 or 9999999.9 or 999999.99 and is reset to zero.

The next page shows the operating menu.

The following describes selection and execution of functions.

Menu:

Indication meas .val	F1- : Indication	F11: Selection	F11-1 : Flow rate F11-2 : Totalizer F11-3 : % F11-4 : Temperature
			Euro / US
		F12 : Flow rate unit	F12-1 : m ³ / m ³ F12-2 : l / acf F12-3 : Nm ³ / Nm ³ F12-4 : NL / scf F12-5 : t / ton F12-6 : kg / kg F12-7 : scf / lb F12-8 : gal / usg
			Euro / US
		F13 : Time unit	F13-1 : h / h F13-2 : min / min F13-3 : s / s F13-4 : day / day
		F14 : Reset Totalizer	F14-1 : Execute
		F15 : Temperature unit	F15-1 : degC F15-2 : DegF
	F2- : Damping	F21 : Selection	F21 0 : 0 s F21 1 : 1 s F21 5 : 5 s F21 10 : 10 s

F3- : Output	F31 : Selection	F31 0-20 : 0-20 mA F31 4-20 : 4-20 mA
	F32 : Offset adjustment	F32 00
	F33 : Span adjustment	F33 00
	F34 : Pulse output *)	F34-1 : not active F34-2 : last digit F34-3 : last but one digit
	F4- : Error messages	F41 : Indication
F5- : Manual adjustment	F51 : On/Off	F51-1 : off F51-2 : on
	F52 : Adjustment table	F52 5 : 5 % point
		F52 15 : 15 % point
		F52 25 : 25 % point
		F52 35 : 35 % point
		F52 45 : 45 % point
		F52 55 : 55 % point
		F52 65 : 65 % point
		F52 75 : 75 % point
		F52 85 : 85 % point
		F52 95 : 95 % point
F52 105 : 105 % point		
F6- : Service	F61 : Revision indicator	H.. F..
	F62 : EEPROM revision	A.. C..
	F63 : Current output test	F63 04 : 0 or 4 mA
		F63 20 : 20 mA
	F64 : Calibration table	F64-1 : Standard
		F64-2 : Remote version
F65 : Master Reset	F65-1 : Execute	
F7- : Float Block. Ind.	F71 : Off/On	F71-1 : Off/On
		F71-2 : On/Off
	F72 : Lower limit	F72-1 : 5 % of Qmax
		F72-2 : 15 % of Qmax
		F72-3 : 30 % of Qmax
	F73 : Supervision time	F73-1 : 5 Minutes
		F73-2 : 15 Minutes
F74 : Autozero	F74-1 : Execute	

Bold type = Factory Pre-setting

*) Option /CP

6.2.1 Selection of indication function (F11)

The function F11 selects the display's indication function.

The following indications can be set: flow rate, totalizer, % value or temperature.

At the factory the display is preset to totalizer indication.

Description	Selection	Key	Indication
Change to setting mode		Enter	Display mode F1-
Setting function		Enter	F11
Selection	Flow rate	Enter	F11 -1
or	Totalizer	→	F11 -2
or	%	Enter	F11
or	Temperature	2 x →	F11 -3
		Enter	F11
		3 x →	F11 -4
		Enter	F11
Back to display mode		↑	F1-
		↑	Display mode

Note: If you press “↑” instead of “Enter,” you can return from the selected point to the previous menu without activating the displayed parameter.

When selecting “Flow rate” the measuring unit is set with function F12 and F13. When selecting “Totalizer” the measuring unit is set with F12. If % indication is selected, F12 and F13 have no effect. The internal totalizer is updated, if “Flow rate” or “Counter” is selected. In case of setting to “%” the internal counter is not updated and keeps its previous value.

If “Temperature” is selected the unit can be set by function F15. The indicated value is the temperature in the indication unit.

After changing the indicating function and measuring units the corresponding measuring unit label should be fixed on the right side next to the display.

6.2.2 Setting the unit (F12 / F13)

When ordering the transmitter two sets of metering units are available. It is not possible to switch between them. These two sets comprise the following metering units:

European unit set, Standard

	Standard	Description	Unit	Menu / Index
Flow rate unit	SI	Cubic meter	m ³	-1
	SI	Liter	l	-2
	SI	Norm cubic meter (0 °C; 1 Atm.abs = 1.013 bar)	Nm ³	-3
	SI	Norm Liter	Nl	-4
	SI	Ton	t	-5
	SI	Kilogram	kg	-6
	---	Standard cubic feet (60 °F; 1 Atm.abs = 14,69 psi)	scf	-7
	---	Gallon (imperial, UK)	gal	-8
Time unit	SI	Hour	h	-1
	SI	Minute	min	-2
	SI	Second	s	-3
	---	Day	d	-4

US unit set, Option /A12

	Standard	Description	Unit	Menu / Index
Flow rate unit	SI	Cubic meter	m ³	-1
	---	Actual cubic feet	acf	-2
	SI	Norm cubic meter (0 °C; 1 Atm.abs = 1.013 bar)	Nm ³	-3
	---	Standard cubic feet (60 °F; 1 Atm.abs = 14.69 psi)	scft	-4
	---	Long ton	ton	-5
	SI	Kilogram	kg	-6
	---	Pound	lb	-7
	---	Gallon (US)	usg	-8
Time unit	SI	Hour	h	-1
	SI	Minute	min	-2
	SI	Second	s	-3
	---	Day	d	-4

With functions F12 and F13, the measuring unit for displayed value is selected. F12 selects volume and mass units, while F13 sets the corresponding time unit. When selecting the indication function "totalizer" the set time unit is not taken into account and only the selected mass or volume unit is effective. When choosing the "%" indication F12 and F13 have no effect. The selection of the measuring unit is performed as follows:

Description	Selection	Key	Indication
Change to setting mode		Enter	Display mode F1-
Setting Masse/Volume unit	unit set Euro US	Enter → Enter	F11 F12 F12 -1
Selection unit or or or or or or	m3 m3 l acf Nm3 Nm3 Nl scf t ton kg kg scf lb gal usg	Enter → Enter 2 x → Enter 3 x → Enter 4 x → Enter 5 x → Enter 6 x → Enter 7 x → Enter	F12 F12 -2 F12 F12 -3 F12 F12 -4 F12 F12 -5 F12 F12 -6 F12 F12 -7 F12 F12 -8 F12
Setting Time unit		→ Enter	F13 F13 -1
Selection time unit or or or	h h min min s s day day	Enter → Enter 2 x → Enter 3 x → Enter	F13 F13 -2 F13 F13 -3 F13 F13 -4 F13
Back to display mode		↑ ↑	F1- Display mode

Note: If you press "↑" instead of "Enter", you can return from the selected point to the previous menu without activating the displayed parameter.

After changing the measuring unit the corresponding measuring unit label should be fixed on the right side next to the display. A sheet with stickers is included.

Attention: When switching the mass/volume unit the totalizer is reset to zero.
When changing the time unit the totalizer value remains unchanged.

6.2.3 Totalizer reset (F14)

Function F14 resets the totalizer to zero.

The counter reset is performed as follows:

Description	Selection	Key	Indication
Change to setting mode		Enter	Display mode F1-
Setting mode		Enter 3 x → Enter	F11 F14 F14 -1
Selection	Reset	Enter	F14
Back to display mode		↑ ↑	F1- Display mode

Note: If you press “↑” instead of “Enter”, you can return from the selected point to the previous menu without activating the displayed parameter.

6.2.4 Selection of temperature unit (F15)

The function F15 sets the unit of temperature indication.

The following indications can be set: degC (Celsius) or degF (Fahrenheit).

At the factory the display is set to degC indication.

The selection of the indication is as follows:

Description	Selection	Key	Indication
Change to setting mode		Enter	Display mode F1-
Setting mode		Enter 4 x → Enter	F11 F15 F15 -1
Selection	degC degF	Enter → Enter	F15 F15 -2 F15
Back to display mode		↑ ↑	F1- Display mode

Note: If you press “↑” instead of “Enter”, you can return from the selected point to the previous menu without activating the displayed parameter.

6.2.5 Setting of damping (F2-)

Function F21 allows damping the output with a certain time constant (63 % value). Normally the time constant is set to 1 sec.

The selection of the time constant is as follows:

Description	Selection	Key	Indication
Change to setting mode		Enter	Display mode F1-
Setting mode		→ Enter	F2- F21
Selection damping constant or or or	0 s 1 s 5 s 10 s	Enter Enter → Enter 2 x → Enter 3 x → Enter	F21 0 F21 F21 1 F21 5 F21 10 F21
Back to display mode		↑ ↑	F2- Display mode

Note: If you press “↑” instead of “Enter”, you can return from the selected point to the previous menu without activating the displayed parameter.

6.2.6 Selection / Adjustment 4-20 mA / 0-20 mA (F3-)

Function F3- sets the current output to 4-20 mA or 0-20 mA. In addition, offset and span have to be readjusted. Offset compensation is for fine tuning the 0 or 4 mA point. Span or range compensation is for precise adjustment of the 20 mA point.

For compensating the output, an ampere metre (mA) should be connected to the circuit loop. For wiring refer to the diagrams in chapter 3.

The current output is set according to customer specifications at the factory.

Switching the output is executed as follows:

Description	Selection	Key	Indication
Change to setting mode		Enter	Display mode F1-
Setting mode Output selection		2 x → Enter Enter	F3- F31 F31 0-20
Selection or	0-20 4-20	Enter → Enter	F31 F31 4-20 F31
Setting function Offset-Adjustment		→ Enter	F32 F32 00
Offset-Adjustment (Setting current to 0/4 mA)	Increase Decrease if 0/4 mA	↑ → Enter	F32 in steps of +1 (+20 μA) F32 in steps of -1 (-20 μA) F32
Setting function Span setting		Enter	F33 F33 0
Span setting (Setting current to 20 mA)	Increase Decrease if 20 mA	↑ → Enter	F33 in steps of +1 (+20 μA) F33 in steps of -1 (-20 μA) F33
Back to display mode		↑ ↑	F3- Display mode

An adjusting step corresponds to 20 μ A. The complete adjusting range is \pm 0.62 mA (31 steps). If the adjusting range does not suffice, change to display F32 or F33 by pressing ENTER when display shows F32 31 or F33 31, press ENTER again and continue adjusting at F32 00 or F33 00.

3 wire connection:

At this the ranges 0-20 mA and 4-20 mA are possible. At a switch over between the two ranges with F31 the current output is automatically adjusted at equipment as of firmware version 1.4 . (s.F 61). A perhaps necessary fine adjustment can be carried out with F32 or F33.

2 wire connection:

At this only the range of 4-20 mA is meaningful. The range of 0-20 mA is not closed however. At the change to 0-20 mA with F31 the equipment assumes a remodelling on 3 wire connection and the current output is adjusted according to this. A perhaps necessary fine adjustment can be carried out with F32 or F33.



WARNING

Since YOKOGAWA doesn't have any influence on the custom-designed connection the current output is not automatically adapted, if the connection is changed from 2 wire to 3 wire or vice versa .This must be manually carried out with the functions F32 and F33.

Preset values :

Current range	Connection	2- wire	3-wire
0 - 20 mA		-----	$I_0 = 0$ mA $I_{20} = 20$ mA
4 - 20 mA		$I_4 = 0.4$ mA + 3.6 mA $I_{20} = 16.4$ mA + 3.6 mA	$I_0 = 4$ mA $I_{20} = 20$ mA
Note		Do not use F31	Use F31 for changing

6.2.7 Pulse output (F34) (Option /CP)

With the function F34 the optional pulse output can be activated and adjusted.

Description	Selection	Key	Indication
Change to setting mode		Enter	Display mode F1-
Setting mode		2 x → Enter 3 x →	F3- F31 F34
Selection or or	Activation Resolution last digit Resolution last but one digit	Enter Enter → Enter 2 x → Enter	F34 -1 F34 F34 -2 F34 F34 -3 F34
Back to display mode		↑ ↑	F3- Display mode

6.2.7.1 General

The volume totalizer function in the electronic transmitter is available with a potential free pulse contact.

The connection is supported only at 4-wire-units on the power supply at pins 6, 7.

The pulse output is activated and selected by function F34 in the menu structure.

Two different pulse rates can be selected. The lower pulse rate (higher resolution) corresponds to the last (least significant) digit of the totalizer. The higher pulse rate (lower resolution) corresponds to the last but one digit of the totalizer.

6.2.7.2 Connection

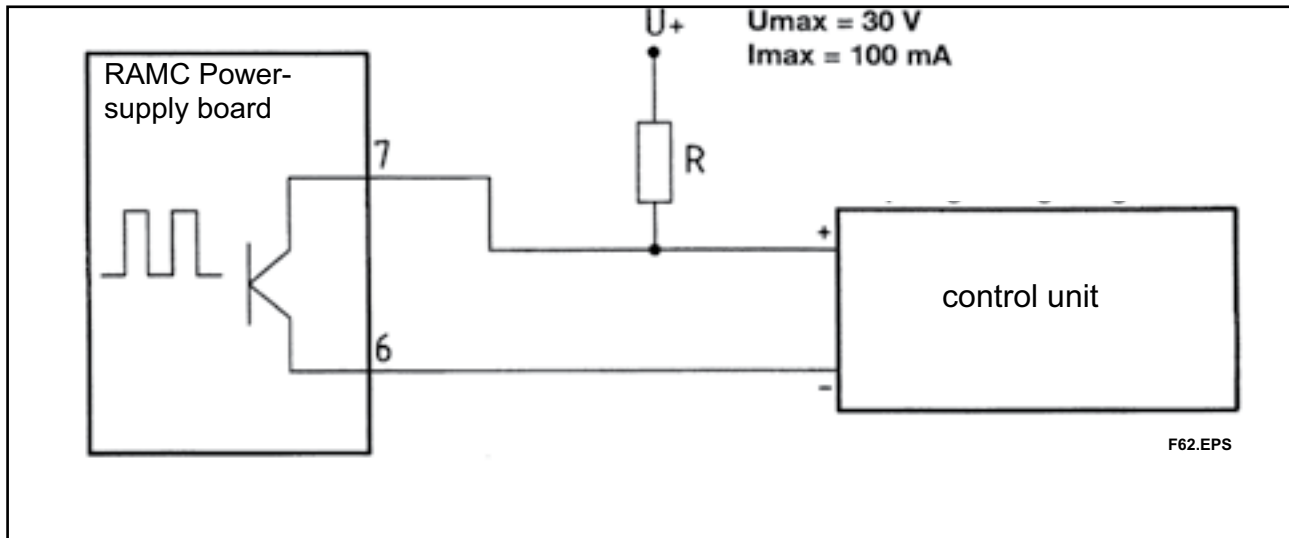

6.2.7.3 Adjustments

The function F34 is added to the menu structure.

With the selection of F34 -1 the pulse output is switched off. With the selection of the functions F34 -2 or F34 -3 the pulse output is activated with the concerning resolution.

- F34 -1 not active
- F34 -2 last totalizer digit
- F34 -3 last but one totalizer digit

Special case: If Q_{max} is higher than 10000, the pulse rate is **decreased** by factor 10 in both cases. That means:

- F34 -2 last but one totalizer digit
- F34 -3 third totalizer digit from the right

6.2.7.4 Calculation of pulse rate

Concerning the final flow-value (Q_{max}), which was declared in the customers order, the pulse rate is calculated in factory and is written onto the sheet 'Data of Pulse Output (Option /CP)', which is included. This value can be transferred to a blank label of the also included sheet with unit-stickers and then fixed on the scale. After changing the flow rate unit with F12 the pulse rate must be recalculated.

Calculation of pulse rate:

- Read the value of Q_{max} from the scale or recalculate it.
- Search for the concerning range in the first row of the table below.
- Read the concerning pulse rates in the second and third row.
- The measuring unit is equal to the flow

Maximum flow Q_{max} without unit	Pulse rate for F34-2 without unit	Pulse rate for F34-3 without unit
$Q_{max} \leq 1$	0.0001	0.001
$1 < Q_{max} \leq 10$	0.001	0.01
$10 < Q_{max} \leq 100$	0.01	0.1
$100 < Q_{max} \leq 1000$	0.1	1
$1000 < Q_{max} \leq 10000$	1	10
$10000 < Q_{max} \leq 100000$	10	100

e.g.: Final value (Q_{max}) = 400 m³/h

→ Pulse rate 0.1 m³ for F34-2 and 1 m³ for F34-3



NOTE

- The factory default is F34 -2 (solution: 1 last digit).
- After Master Reset F34 -1 (Pulse output not active) is selected.
- After changing the flow rate unit with F12 the pulse-register is deleted and the pulse rate is automatically redefined according to the new unit.
- After totalizer Reset with F14 the pulse output does not change.
- When changing the indication with F11 -3 to '%', the totalizer stops and the pulse output is switched off.
- After switching power on one pulse is generated at the output.
- For 2- respectively 3-wire-units the function F34 is not supported.

6.2.8 Error messages (F4-)

If the 8 bars beneath the digits start flashing, an error has occurred in the measuring transmitter/current output. Since the pointer indication is independent from the electric measuring transmitter, it may show the correct measuring value even if the transmitter is defective. Function F41 allows checking of assigned error codes.

Error codes are called onto the display as follows:

Description	Selection	Key	Indication
Change to setting mode		Enter	Display mode F1-
Setting mode		3 x → Enter Enter Enter	F4- F41 F41 Enn F41
Back to display mode		↑ ↑	F4- Display mode

List of error messages:

Code	Meaning	Remedy
01	RAM-error	Indication unit needs service
02	ADC-error	Indication unit needs service
03	Internal EEPROM faulty	Indication unit needs service
04	Calibration-EEPROM faulty	If EEPROM is missing insert, -otherwise order new EEPROM
05	Wrong totalizer value in EEPROM	Reset totalizer
06	Overflow (flow rate too high)	Reduce flow rate
07	Internal EEPROM faulty	Indicator unit needs service
08	Float blocking indication realized, supervision time gone off	Deactivate float-blocking-indication or run Autozero function

In case of error the appropriate remedy has to be taken.

6.2.9 Manual adjustment (F5-)

During manufacturers adjustment and calibration process the relation between flow rate with water (or with air) and float position (indicated as angle on the mm-scale) is determined. Based on the properties of the customers fluid at expected operating conditions the flow scale and the corresponding EEPROM is then calculated.

If the fluid properties are changing (by change of the fluid or by change of the process conditions) the scale as well as the EEPROM has to be adapted. Easiest and recommended way to do this is to order new scale and EEPROM for the new properties from manufacturer and to replace both.

A second possibility is to readjust the meter by the user. This readjustment procedure will only adjust the current output and the display indication (but only in % of the new flow range), At least the readjustment by the user is possible by two different procedures:

1 Manual “dry” readjustment based on recalculated original scale:

The following steps have to be performed:

- 1.a) Calculate the new of flow rate to mm (on scale) relation based on original manufacturers calibration certificate.
- 1.b) Place the RAMC (with the measuring tube) horizontally on a table (Note: the distance to any ferro-magnetic parts must be at least higher than 25 cm!).
- 1.c) Go to menu function F51 and press ENTER to switch to manual adjustment mode. (Switching back to the original adjustment is possible by pressing ENTER again).
- 1.d) Go to menu function F52 in order to start the manual adjustment.
- 1.e) Move the float to a position where the pointer is indicating on mm-scale the mm-value belonging to 5 % of the new flow rate (Note: these values have to be calculated in step a first!)
- 1.f) Press ENTER to adjust the first 5 % point.
- 1.g) Repeat steps 1.e) to 1.f) for the 15 %; 25 %; 35 %; 45 %; 55 %; 65 %; 75 %; 85 %; 95 % and 105 % points. (Note: The whole loop from 5 % to 105 % has to be adjusted in the requested order without interruption. It is not possible to skip or stop and restart the adjustment.)
- 1.h) The adjustment has to be finished and stored by pressing “ ↑ ”:

After storage the new adjustment is permanently available and can be switched “on” or “off” by function F51.



NOTE

When manually adjustment is active, the user is responsible for the measurement accuracy.

Activating/deactivating manual adjustment table (F51)

Description	Selection	Key	Indication
Change to setting mode		Enter	Display mode F1-
Setting mode		4 x → Enter	F5- F51
Selection	Change state Take state	Enter → Enter	F51 -1 or -2 (*) F51 -2 or -1 F51
Back to display mode		↑ ↑	F5- Display mode

(*) -1 : manual adjustment OFF; -2 : manual adjustment ON

Input of manual adjustment table (F52)

The manual adjustment table is input as follows:

Description	Selection	Key	Indication
Change to setting mode		Enter	Display mode F1-
Setting mode		4 x → Enter →	F5- F51 F52
Selection	5 %- point 15 %- point 25 %- point 35 %- point 45 %- point 55 %- point 65 %- point 75 %- point 85 %- point 95 %- point 105 %- point	Enter Enter Enter Enter Enter Enter Enter Enter Enter Enter Enter	F52 F52 -5 F52 -15 F52 -25 F52 -35 F52 -45 F52 -55 F52 -65 F52 -75 F52 -85 F52 -95 F52 -105
Back to display mode		↑ ↑	F5- Display mode

- 2 Manual “wet” adjustment by comparison to a reference master meter with the real process fluid at operating conditions:

This adjustment is useful under the following conditions:

- The original manufacturer’s calibration is not available or needs to be renewed.
- Or
- The user is not able to recalculate the new mm to flow rate table.
- And
- The user has the possibility to compare the meter indication with a master meter with the process fluid at process conditions.

In these cases the following steps have to be performed:

- 2.a) Place the RAMC in line with the master meter in an installation allowing controlled flow with the process fluid at process conditions in a flow range from 5 % to 105 % of the expected flow range.
- 2.b) Go to menu function F51 and press ENTER to switch to manual adjustment mode. (Switching back to the original adjustment is possible by pressing ENTER again).
- 2.c) Go to menu function F52 in order to start the manual adjustment.
- 2.d) Set the flow to 5 % of the new flow rate indicated by the master.
- 2.e) Press ENTER to adjust the first 5 % point.
- 2.f) Repeat steps 2.d) to 2.e) for the 15 %; 25 %; 35 %; 45 %; 55 %; 65 %; 75 %; 85 %; 95 % and 105 % points. (Note: The whole loop from 5 % to 105 % has to be adjusted in the requested order without interruption. It is not possible to skip or stop and restart the adjustment.)
- 2.g) The adjustment has to be finished and stored by pressing “ ↑ “.

After storage the new adjustment is permanently available and can be switched “on” or “off” by function F51.

For the manual adjustment procedure according to the two cases described the following remarks have to be taken into account:

- After manual adjustment the flow-scale of the indicator is no longer valid.
- The display will only indicate in % of the new flow range.
- Switching of units is impossible.
- The indicator can be always resetted to the original adjustment according to manufacturers calibration at any time.
- The given procedures will only adjust the current output and the display to the new measuring range for a different fluid and/or new process conditions.
- The result of this adjustment is NOT a calibration! If proof of the new adjustment is requested a real calibration by comparison to a standard has to be made after adjustment!
- The following interactions with other functions apply:

Interaction with other functions:

	Action	Function	Effect
1.	Setting of manual adjustment values	F52 -5...	Manual adjustment table is overwritten
2.	Activating of manual adjustment table	F51 -2	- Manual adjustment table active - %-indication only - Totalizer does not count - No other flow rate unit selectable - Function F64 for option /A2 has no effect, with manual adjustment
3.	Deactivating of manual adjustment table	F51 -1	- Standard adjustment table active - F11 is set to flow rate - Flow unit is the same as before activating manual adjustment - Totalizer value is the same as before activating manual adjustment

Due to the limitations described it is strongly recommended to order a new scale and EEPROM from manufacturer (this gives a real new flow scale without new calibration) or to order a new calibration by the manufacturer together with a new scale and EEPROM for the new fluid and/or new process conditions (this gives new adjustment plus new calibration).

6.2.10 Revision indication (F61/F62)

Functions F61 and F62 enable the indication of revision states for hardware, software of calibration EEPROM and internal EEPROM.

The indication is called up as follows:

Description	Selection	Key	Indication
Change to setting mode		Enter	Display mode F1-
Setting mode Revision		5 x → Enter 2 x →	F6- F61 Hhh ¹ Fff ²
Setting mode EEPROM Revision		↑ → Enter	F61 F62 Aaa ³ Ccc ⁴
Back to display mode		↑ ↑	F6- Display mode

¹ H = Hardware ² F = Firmware ³ A = Internal EEPROM ⁴ C = Calibration-EEPROM

6.2.11 Current output test (F63)

Function F63 sets the output current to 0/4 mA or 20 mA respectively.

With this you can determine whether output current correction by function F32 is required.

The adjustment of the current output is as follows:

Description	Selection	Key	Indication
Change to setting mode		Enter	Display mode F1-
Setting mode		5 x → Enter Enter	F6- F61 F63
Selection or	Output 0/4 mA Output 20 mA	Enter → Enter	F63 0/4 F63 20 F63
Back to display mode		↑ ↑	F6- Display mode

Note: During selection you can switch between 0/4 mA and 20 mA with the "→"-key.
If you press "↑" instead of "Enter", you can return from the selected point to the previous menu item without activating the displayed parameter.

6.2.12 Switching between standard / Indicator on extension (F64)

F64 allows switching between the standard calibration table and a calibration table of the remote version (option /A16 for high temperatures). The adjustment has to be performed according to the RAMC type (MS code).

This is done as follows:

Description	Selection	Key	Indication
Change to setting mode		Enter	Display mode F1-
Setting mode		5 x → Enter 3 x →	F6- F61 F64
Selection or	Standard Remote Version	Enter → Enter	F64 -1 F64 -2 F64
Back to display mode		↑ ↑	F6- Display mode

Note: If you press “↑” instead of “Enter”, you can return from the selected point to the previous menu without activating the displayed parameter.

6.2.13 Master Reset (F65)

If the unit shows aberrant behavior or does not execute functions any longer, function F65 allows a master reset of the micro controller.

Attention: All parameter settings are reset to factory settings (see operation menu).

The master reset is executed as follows:

Description	Selection	Key	Indication
Change to setting mode		Enter	Display mode F1-
Setting mode		5 x → Enter 4 x →	F6- F61 F65
Selection	Reset	Enter Enter	F65 -1 F65
Back to display mode		↑ ↑	F6- Display mode

Note: If you press “↑” instead of “Enter”, you can return from the selected point to the previous menu without activating the displayed parameter.

6.2.14 Float blocking indication (F7-)

6.2.14.1 Function

Float

Pulsating movements of the flow medium (gasses, liquids) lead to fluctuations of the float and with that to fluctuations of the tap system/pointer. Therefore the electrical measuring signal permanently changes and with that the display value and the output current value.

The fluctuations can be reduced with the help of the damping function "F21". That shows however that the medium still flows and the float/the tap system is not blocked. This means that in most applications there is a permanently changing measuring signal which can be used for the recognition of the movement or the blockade of the float.

Basic noise

Since it is an electronic evaluation circuit, permanently minimal fluctuations of the measuring signal appear. The basic noise is caused by vibrations in the plant as well as by temperature influences or external magnetic fields. The basic noise also appears, if

- no medium flows through the measuring pipe
- the float and with that the tap system are in the rest position
- the float/the tap system is blocked.

Float-Blocking-Indication

The function of the Float-Blocking-Indication allows the electronic transmitter to distinguish the fluctuations, which are caused by a moving float, with the fluctuations of the basic noise to state a fault status. If the measuring signal does not exceed the autozero value during a defined supervision time, this is recognized as blockade and an error condition is shown.

6.2.14.2 Operation

Switching on

At delivery of the equipment the Float-Blocking-Indication is turned off. By the function "F71 2" the Float-Blocking-Indication can be activated.

Autozero function

The autozero function is called to find out the level of basic noise in the application. This is started with the function "F74 1" and lasts for 90 seconds. While the autozero function is running the value "0.000" is displayed and the 4 bars will flash below the numbers. After approx. 80 seconds the current autozero value appears on the display. This value gets stored and will not be lost after power off / on the RAMC or after switching off / on the Float-Move-Detection-function. The stored value is typed over first after a renewed autozero.

Autozero without flow

To execute the autozero function the following expiry is recommended:

- Plant in operation (measuring tube filled with medium)
- Drive flow to zero (place float into rest position)
- Raise the pointer to 10 % to 20 % of the flow and fix it on the scale with adhesive tapes or underlaid paper stripe .
- Start Autozero function by menu.
- Check Autozero value after approx. 80 seconds.

During the Autozero function it absolutely has to be respected that:

- **the RAMC is not moved by touching or using the 2 buttons.**
- **the pointer is protected against slipping.**
- **the tube is not exposed to strong tremors**

If these prerequisites are not adhered, it comes to the inquiry of too high autozero results. This leads that a relatively quiet flow can trigger the Float-Blocking-Indication.

Autozero with flow

The Autozero function can be carried out also under flow, if the flow cannot be switched off. To this the following expiry is recommended:

- Plant in operation (measuring tube filled with medium)
- Move flow to constant value (preferably between 10 % and 40 %)
- Fix pointer on the oriented scale factor with adhesive tapes or underlaid paper stripe
- Start Autozero function by menu.
- Check Autozero value after approx. 80 seconds.

It has to be respected on this absolutely, for this the flow is constant during the Autozero duration!
Normally at this variant higher Autozero results must be expected !

Autozero range

The factory default autozero value is zero (0.000).

At the inquiry of the autozero value it has to be respected that the pointer / tap system are not in the rest position. In this case the autozero value is zero and the Float-Move-Detection does not work.

Normally the autozero value is smaller than 0.200. If higher results should appear in the application, a multiple inquiry of the autozero value is recommended to confirm the value.

Supervision range (measuring range)

The measuring range in which Float-Move-Detection is active lies between 5 % and 105 % of the maximum flow Q_{max} (Factory Setting). With the help of the function "F72" this range can be reduced if a supervision is not possible or not desired in the lower flow range. The range can be restricted to 15 % or 30 % to 105 % (see point 3.1 to 3.3).

Supervision time (Time Out)

The supervision time of the measuring signal is 5 minutes (Factory Setting). If the measuring signal should not exceed the autozero value during this period, this is recognized as blockade and an error condition is shown. The supervision time can be increased with the function "F73" up to 15 minutes.

Indication of a blocking condition

After the recognition of the blockade the error code "08" is produced and the bars under the displayed measurement value are flashing (see fault behavior). Simultaneously the current output is set to a value, which enables a clear fault detection of a connected evaluation unit:

- 2 - wire 4-20 mA: Error condition: IA (IG) < 3.6 mA
- 3 - wire 4-20 mA: Error condition: IA < 0.0 mA
- 3 - wire 0-20 mA: Error condition: IA = 0.0 mA

6.2.14.3 Unsuitable applications

It is possible, that the Float-Blocking-Indication - Function does not work satisfactory. This can be caused with different factors which are explained briefly here. In these cases the function of the Float-Blocking-Indication is not suitable for the respective application and it should be turned off.

Applications with gases

At applications with gases and float-damping it can happen, that the pulsating movements of the medium (and with that of the float) are damped so strongly in the measuring tube, that the measuring signal lies under the autozero value and a Float-Blocking-Indication is not possible.

Applications with high viscous media

If a high viscous medium should be used in the plant, the damping can get so high by the high viscosity of the flow that the measuring signal lies below the autozero value, and a Float-Blocking-Indication is not possible.

Applications with quiet flow

If the plant has an extremely quiet flow (gases or liquids), the supervision range can be limited in the lower flow range. Normally greater flow (> 30 %) causes greater medium flow deviations. The duration of the supervision can be put to 15 minutes to reach a longer supervision time.

6.2.13.4 Parameter setting

Error message (F41)

Code	Meaning	Remedy
08	Float blockage Supervision time gone off	Check float in tube, clean tube if necessary. Deactivate float blocking indication or run Autozero function.

Factory defaults / Master Reset (F65)

The RAMC is adjusted at delivery (Factory Setting):

- F71 - 1 **Float-Move-Detection OFF**
- F72 - 1 **Lower limit value of the supervision area 5 %**
- F73 - 1 **Supervision time (Time Out) 5 min**
- F74 **Autozero inactive Autozero value = 0**

After Master Reset the following attitudes are given :

- F71 - 1 **Float-Blocking-Indication OFF**
- F72 - 1 **Lower limit value of the supervision area 5 %**
- F73 - 1 **Supervision time (Time Out) 5 min**
- F74 **Autozero inactive Autozero value not changed**

Damping (F21)

The selection of the damping value has no influence on the autozero value or the measurement value of the Float-Blocking-Indication!

Float-Blocking-Indication (F7x)

Function F71: On-/Off- switching of the float-blocking-indication

Description	Selection	Key	Indication
Change to setting mode		Enter	Display mode F1-
Setting mode		6 x → Enter	F7- F71
Selection or	FBI OFF/ON FBI ON/OFF	Enter → Enter	F71 F72 F71
Back to display mode		↑ ↑	F7- Display mode

Function F72: Selection of the lower limit value of the supervision range

Description	Selection	Key	Indication
Change to setting mode		Enter	Display mode F1-
Setting mode		6 x → Enter →	F7- F71 F72
Selection or or	5 % of Qmax 15 % of Qmax 30 % of Qmax	Enter Enter → Enter → Enter	F72 -5 F72 -15 F72 -30 F72
Back to display mode		↑ ↑	F7- Display mode

Function F73: Selection of the supervision time

Description	Selection	Key	Indication
Change to setting mode		Enter	Display mode F1-
Setting mode		6 x → Enter 2 x →	F7- F71 F73
Selection or	5 Minutes 15 Minutes	Enter Enter → Enter	F73 -5 F73 -15 F73
Back to display mode		↑ ↑	F7- Display mode

Function F74: Start Autozero function and storage

Description	Selection	Key	Indication
Change to setting mode		Enter	Display mode F1-
Setting mode		6 x → Enter 3 x →	F7- F71 F74
Selection Inquire autozero value (80 s) Display autozero value (10 s)	Autozero	Enter Enter	F74 -1 0.000 0.xxx
Back to display mode		↑ ↑	F7- Display mode

Blank Page

7. HART - Communication

7.1 General

RAMC with indication unit type -H or -J have, additional to the current output, the possibility for HART-Communication. Also without HART-Communication the units are fully able to work. The HART-Communication does not influence the current output, except in Multidrop-Mode (see below).

There exists no difference between the not-Ex and the Ex versions. For use in the hazardous area a HART-able transmitter power supply is required.



NOTE

The HART-Communication is only available with plugged calibration-EEPROM



NOTE

The HART-Communication is only available for 2-wire units, 4...20mA. Therefore the short-circuit bridge must be connected between 'A' and '1'.

Deviations in the RAMC- Menu

In HART devices the operating menu according chapter 6 is not available.

HART 5: Pressing the ↑-button the indication can be changed between flow, totalizer and temperature.

HART 7: Pressing the ↑-button the indication can be changed between flow, totalizer, percent and temperature. Factory default is totalizer.

Pressing → button an error indication appears on display.

00000000 or 00000000

A detailed explanation see chapter 7.4.2 and 7.6.2.

7.1.1 Multidrop Mode in the case of using HART 5

"Multidropping" transmitters refer to the connection of several transmitters to a single communication transmission line. Up to 15 transmitters can be connected when set in the multidrop mode. To activate multidrop communication, the transmitter address must be changed to a number from 1 to 15. This change deactivates the 4 to 20 mA analog output, setting it to 4 mA. The alarm current is also disabled.

Setting of Multidrop Mode

Device Setup

Detailed setup

Device Information

Poll addr

Enter the number from 1 to 15(Def.: 0)

Enabling the Multidrop Mode

About the procedure to call up the Polling display, please refer to the User's Manual of each configuration tool.



NOTE

When the same Polling address is set for two or more transmitters in multidrop mode, communication with these transmitters is disabled.

Communication when set in multidrop mode

The HART configuration tool searches for a transmitter that is set in multidrop mode when it is turned on. When the HART configuration tool is connected to the transmitter, the polling address and the tag will be displayed.

Select the desired transmitter. After that, normal communication to the selected transmitter is possible.

To release multidrop mode, call up the Poll addr display and set the address to "0".

7.1.2 Multidrop Mode in the case of using HART 7

“Multidropping” transmitters refer to the connection of several transmitters to a single communication transmission line. Up to 63 transmitters can be connected when set in the multidrop mode. To activate multidrop communication, the transmitter address must be changed to a number from 1 to 63. This change does not deactivate the 4 to 20 mA analog output.

The level at current output can be set by Lop current mode.

Setting of Multidrop Mode

Device Setup

Detailed setup

Configure output

HART output

Poll addr

Enter the number from 1 to 63 (Def.: 0)

Enabling the Multidrop Mode

About the procedure to call up the Polling display, please refer to the User’s Manual of each configuration tool. When Loop current mode is set to “Enabled”, an analog signal output is available for one device in a loop.

Device Setup

Detailed setup

Configure output

Analog output

Loop Current mode

Enable mode of variable output current



NOTE

When the same Polling address is set for two or more transmitters in multidrop mode, communication with these transmitters is disabled.

Communication when set in multidrop mode

The HART configuration tool searches for a transmitter that is set in multidrop mode when it is turned on. When the HART configuration tool is connected to the transmitter, the polling address and the tag will be displayed.

Select the desired transmitter. After that, normal communication to the selected transmitter is possible. To release multidrop mode, call up the Poll addr display and set the address to “0”.

7.2 Connection

The connection is carried out in accordance with below figure. Please note, that the load resistor must have a value between 250 and 500 Ω .

The minimum power supply is $13.5\text{ V} + (R_L \cdot 20\text{ mA})$; R_L = load resistor

The maximum power supply is 30 V.

As connection cable a protected twisted cable pair is recommended.

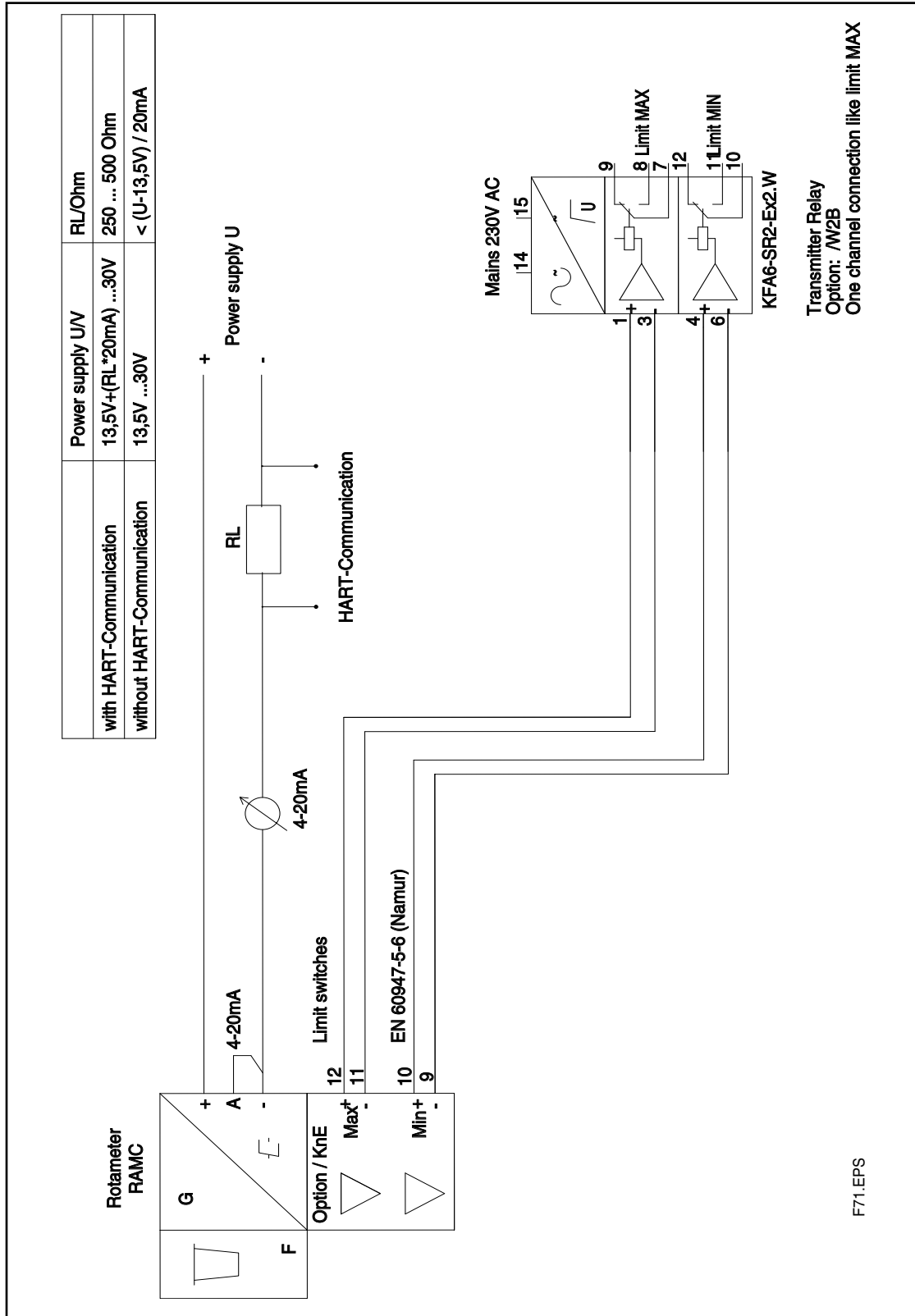

		Diagnostics	Temp max log	Temp max log	ON / OFF	p
				Duration/value	Days Hours Minutes Temp max	R R R R
				Old durat/value	Days Hours Minutes Temp max	R R R R
				Clear values	clear	p
			Flow URV log	Flow URV log	ON / OFF	p
				URV overrun time	Days Hours Minutes	R R R
				URV underrun time	Days Hours Minutes	R R R
				Min overrun time	15 sec 30 sec 1 min 5 min 10 min	R/S R/S R/S R/S R/S
				Clear values	clear	p
			Float blocking	Float blocking	ON / OFF	p
				Set lower limit	5 % 15 % 30 %	R/S R/S R/S
				Set supervis time	Turbulent flow Smooth flow	R/S R/S
				Start autozero	Start	p
				Autozero value		R
		Power monitoring	Operation time	Days; Hours; Minutes		R
			Oper time shadow	Days; Hours; Minutes		R
			Reset power fail	Reset		p
Basic Setup	Tag					R/W
	Flow unit [unit]					R/W
	Temp unit [unit]					R/W
	Set damping					R/W
	Long tag					R/W
Detailed Setup	Characterize meter	Snsr unit				R
		Scale USL				R
		Snsr s/n				R
		Final assy no				R
		MS-Code				R
	Configure signal	Flow damping	Flow damp			R
			Set damping	0.25 sec 1.00 sec 5.00 sec 10.00 sec		R/S R/S R/S R/S

		EU /US	EU	US	R
	Flow unit table	EU /US			
	Flow units select	Cum / h	*	*	R/S
		L / h	*		R/S
		NmlCum / h	*	*	R/S
		NmL / h	*		R/S
		MetTon / h	*		R/S
		Kg / h	*	*	R/S
		StdCuFt / h	*	*	R/S
		Imp Gal / h	*		R/S
		Cum / min	*	*	R/S
		L / min	*		R/S
		NmlCum / min	*	*	R/S
		NmL / min	*		R/S
		MetTon /min	*		R/S
		Kg / min	*	*	R/S
		StdCuft / min	*	*	R/S
		Imp gal / min	*		R/S
		Cum / h	*	*	R/S
		NmlCum / h	*	*	R/S
		Kg / h	*	*	R/S
		StdCuFt / h	*	*	R/S
		CuFt / h		*	R/S
		LTon / h		*	R/S
		Lb / h		*	R/S
		gal / h		*	R/S
		Cum / min	*	*	R/S
		NmlCum / min	*	*	R/S
		Kg / min	*	*	R/S
		StdCuFt / min	*	*	R/S
		CuFt / min		*	R/S
		LTon / min		*	R/S
		Lb / min		*	R/S
		gal / min		*	R/S
	Total reset	perform			p
	Temperature unit	degC			R/S
		degF			R/S
	Configure output	Analog output	Flow AO		R
			AO alrm typ		R
			Loop test		T
			D/A trim		T
		HART output	Poll addr		R/W
			Num req preams		R
			Num resp preams		W
	Display selection	Standard	ManCal		
		Flow	Percent		R/S
		Totalizer	Temperature		R/S
		Temperature			R/S
	Device information	Model			R
		Dev Id			R
		Manufacturer			R
		Distributor			R
		Snsr s/n			R
		Final assy no			R
		Write protect			R
		Tag			R/W
		Descriptor			R/W
		Message			R/W
		Date			R/W
		Poll addr			R/W
		Num req preams			R
		Num resp preams			W
		Long tag			R/W
		MS Code			R

			Revisions #'s	Universal rev. Fld Dev. rev. HW rev.: FW rev.: ADJ-EE rev.: CAL-EE rev.:	R R R R R R
	Review	Model Dev Id Manufacturer Distributor Flow Snsr s/n Final assy no Write protect Tag Descriptor Message Date Poll addr Num req preams Num resp preams Long tag MS Code Universal rev. Fld. Dev. rev. HW rev.: FW rev.: ADJ-EE rev.: CAL-EE rev.:			R R R R R R R R R R/W R/W R/W R/W R W R/W R R R R R R

The generic menu structure differs to the implemented menu structure. The generic mode does not support all implemented commands. The parameters with purple background are also contained in generic mode.

7.4. Description of the HART 5 - Parameter

HOT KEY	Write protect	Read Status of write protection
	Enable wrt 10min	Enable writing for 10 minutes by entering password. After writing a parameter the time of 10 minutes starts again.
	New password	Selection of a new password by entering up to 8 character If 8 blanks are entered as new password, write protection is disabled. If the user password is lost, a joker password is available from the YOKOGAWA service department.

Online

This shows current process data.

Flow	Flow in selected measurement unit
Flow AO	Current output in mA
Flow URV	Upper range value related to the current output
Flow LRV	Lower range value related to the current output

7.4.1 Process variables

Device setup

Process variables

Flow value [cum/h]	Flow in oriented measurement unit
Flow % range [%]	%-value related to 20 mA
Flow AO value [mA]	Current output in mA
Totalizer value [kg]	Totalizer
% span value	%-Value related to flow final value
Temperature value [°C]	Temperature in transmitter

7.4.2 Diagnostic- and Service-Menu

Device setup

Diag/Service

Test device

Device status

Status group 1		
Error indication:		
RAM Error	OFF/ON	Memory error
ADC Error	OFF/ON	Error A/D converter
ADJ-EE-Error	OFF/ON	Error adjustment-EEPROM
CAL-EE Error	OFF/ON	Error calibration-EEPROM
Totalizer false	OFF/ON	Totalizer value false
Flow Overrun	OFF/ON	Flow too high
ADJ Error 2	OFF/ON	Adjustment-EEPROM fault
Float blocked	OFF/ON	Float-Move-Detection recognized, supervision time passed

Device setup

Diag/Service

Test device

Device Status

Status group 2		
Error indication:		
Temp over limit	OFF/ON	Temperature exceed 70 °C
Max flow1 active	OFF/ON	URV overrun
Max flow2 active	OFF/ON	URV underrun
FB autoz active	OFF/ON	Float blocking autozero on
Power fail warn	OFF/ON	Power off has happened
Oper timer error	OFF/ON	Operation timer fault
Mancal active	OFF/ON	Manual calibration activated

Error description :

Status	Type	Current value	Bars blinking	Error on Display	Self Test	HHT475	Reset Function by	Clear all
Status group 1	RAM error	3.6 mA / > 21 mA	-----	00000001	check	ON/OFF	NO (RAMC to service !)	no
	ADC error	3.6 mA / > 21 mA	-----	00000010	check	ON/OFF	NO (RAMC to service !)	no
	ADJ-EE error	3.6 mA / > 21 mA	-----	00000100	check	ON/OFF	NO (RAMC to service !)	no
	CAL-EE error	3.6 mA / > 21 mA	-----	00001000	check	ON/OFF	Insert new EEPROM	no
	Totalizer false	no change	-----	00010000	check	ON/OFF	Reset Counter	yes
	Flow overrun	no change	-----	00100000	no check	ON/OFF	NO (active during overflow)	yes
	ADJ error 2	no change	-----	01000000	no check	ON/OFF	NO (RAMC to service !)	yes
	FB time elapsed	3.6 mA / > 21 mA	-----	10000000	no check	ON/OFF	NO (RAMC to service !)	yes
Status group 2	Temp over limit	no change	-----	00000001	no check	ON/OFF	Switch off Temp Log Funct./Clear Values	yes
	Max flow 1 active	no change	-----	00000010	no check	ON/OFF	Clear Values at Flow Log Function	yes
	Max flow 2 active	no change	-----	00000100	no check	ON/OFF	Clear Values at Flow Log Function	yes
	FB autoz active	no change	-----	00001000	no check	ON/OFF	NO (active during autozero)	yes
	Power fail warning	no change	1)	00010000	no check	ON/OFF	Clear warning at operation monitor	yes
	Operate timer error	no change	-----	00100000	no check	ON/OFF	NO (RAMC to service !)	yes
	Mancal active	no change	2)	01000000	no check	ON/OFF	Switch off manual calibration	yes

- Type: The information will be divided into errors and warnings.
 Current: An error will change the output current to the selected error current level.
 The level is selectable by „Alarm select” in HART (default: LOW)!
- Bars: All 8 bars are blinking in case of an error or warning.
 Self test: Only the checked errors will be treated by the self test function.
 HHT475: The marked errors/warnings are displayed on the HHT475.
 Reset: The indicated error/warning can be reset or disabled by the listed operation.
- 1): On every Power Up, this warning occurs; it is NOT SHOWN ON DISPLAY.
 2): If this function is active, the bars are NOT BLINKING ON DISPLAY.

Device setup**Diag/Service****Test device****Reset all errors**

Reset all errors and warnings

Device setup**Diag/Service****Test device****Self test**

Execute a self test to find existing errors.

Device setup**Diag/Service****Test device****Master reset**

Execute master reset. All parameters are set to default.

Device setup**Diag/Service****Loop Test**Set the analogue output fix to 4 mA, 20 mA or arbitrary current.
Finish with 'End'.**Device setup****Diag/Service****Calibration****Apply URV/LRV**

4 mA

Assignment of 4 mA

Set as 4 mA value:

Current flow is set to 4 mA.

Read new value:

Read current flow for 4 mA.

Leave as found:

No change

20 mA

Assignment of 20 mA

Set as 20 mA value:

Current flow is set to 20 mA.

Read new value:

Read current flow for 20 mA.

Leave as found:

No change

Exit

Leave parameter

Device setup

Diag/Service

Calibration

Reset URV/LRV

Reset 4 mA	Set 4 mA to factory set LRV
Reset 20 mA	Set 20 mA to factory set URV
Exit	Leave parameter

Device setup

Diag/Service

Calibration

D/A Trim

Adjustment of current output to 4 mA and 20 mA.

Device setup

Diag/Service

Calibration

Calib table

Selection of calibration table: Standard / Distance version

Device setup

Diag/Service

Calibration

Manual calib

Status manual	ON/OFF	Show status of manual adjustment table
Activate/deactivate	ON/OFF	Activate or deactivate manual adjustment table
Set manual points	5 %...105 %	Set manual adjustment points
See description of manual adjustment in chapter 6.2.9		

Device setup

Diag/Service

Diagnostics

Temp max log

Temp max log	ON/OFF	Activate or deactivate Temp max Logging function
Duration/value	Days Hours Minutes Temp max	Time since appearance of maximum temperature Max. temperature value
Old durat/value	Days Hours Minutes Temp max	Time since appearance of maximum temperature before clear or reset Max.temperature value before clear or reset
Clear values		The values in parameter Duration/value are written to parameter Old durat/value . Parameter Duration/value is cleared and temp max is set to actual temperature.

Description of temperature maximum logging function:

The temperature value is supervised constantly. As soon as the value exceeds the actual maximum value, the time measurement starts. The minutes are added up, the period can be requested by the user any time. The actual maximum value is overwritten by a higher value automatically, if it lasts more than 30 seconds; the time measurement starts once more. The determined values (max temperature/period) can be cleared by the user. They are written into the parameter Old durat/value after Clear values or after power off/on, the actual time value is deleted, the max temperature value is set on the actual temperature value. By switching Temp max log off the values are not cleared.

When exceeding the maximum temperature of 70 °C the error message "Temp over limit" appears.

Device setup

Diag/Service

Diagnostics

Flow URV log

Flow URV log	ON/OFF	Activate or deactivate Flow URV Logging function
URV overrun time	Days/Hours Minutes	Time since... ... exceeding URV
URV underrun time	Days/Hours Minutes	Time since... ... fall below URV
Min overrun time	Selection of hysteresis time	
Clear values	Clears the values in URV overrun time and URV underrun time	

Description of Flow URV logging function :

The flow value is supervised constantly. As soon as the value reaches the upper limit value (103 %; 20.5 mA) (event 1), the time is measured, during the flow value is over the limit value. If this error condition remains actively longer than the hysteresis value, the limiting value recognition is activated and the condition stored. As soon as the flow value falls below the limit value, the supervision (event 2) ends, for a new cycle the hysteresis time must pass.

After the recognition you can request the passed time:

Time from event1 till query time: delta-T1

Time from event2 till query time: delta-T2

The time difference is the time the upper limit was exceeded.

$\text{hysteresis} \leq t \leq (\text{delta-t1} - \text{delta-t2})$

The stored values remain unchanged after power off and must be cleared by the user. The actual cycle is overwritten automatically by a new one. Therefore only the last cycle is always stored.

The default value for hysteresis is 30 seconds.

Temperature MAX function

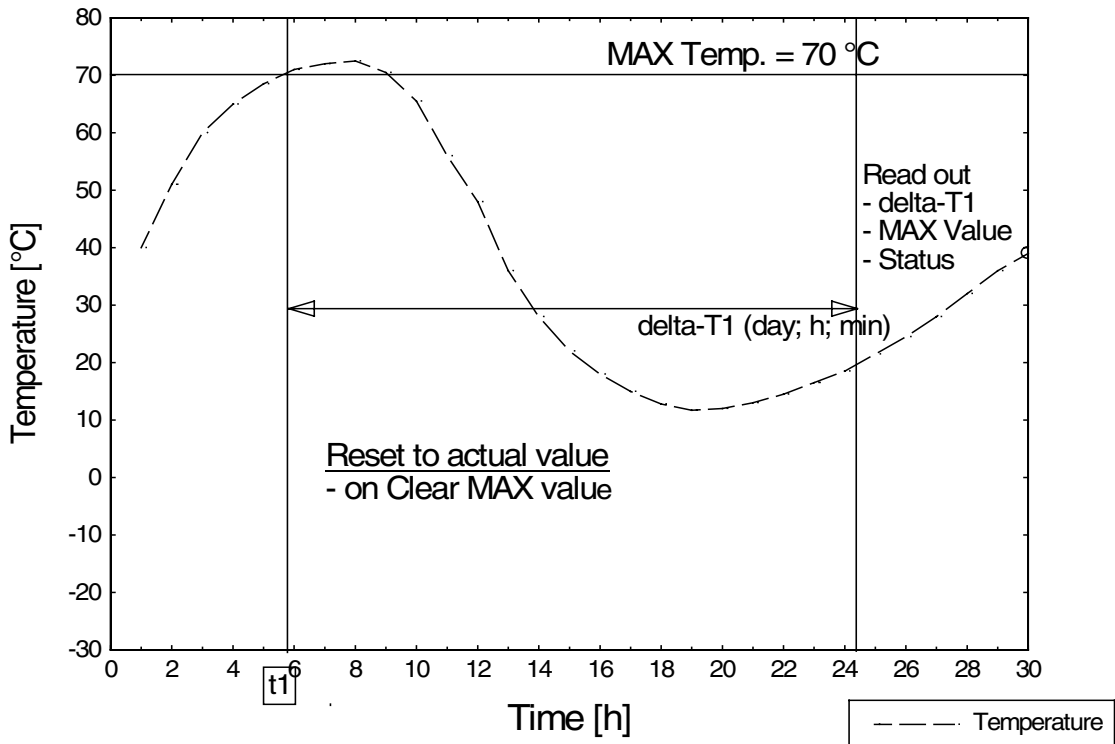

Flow URV Funktion

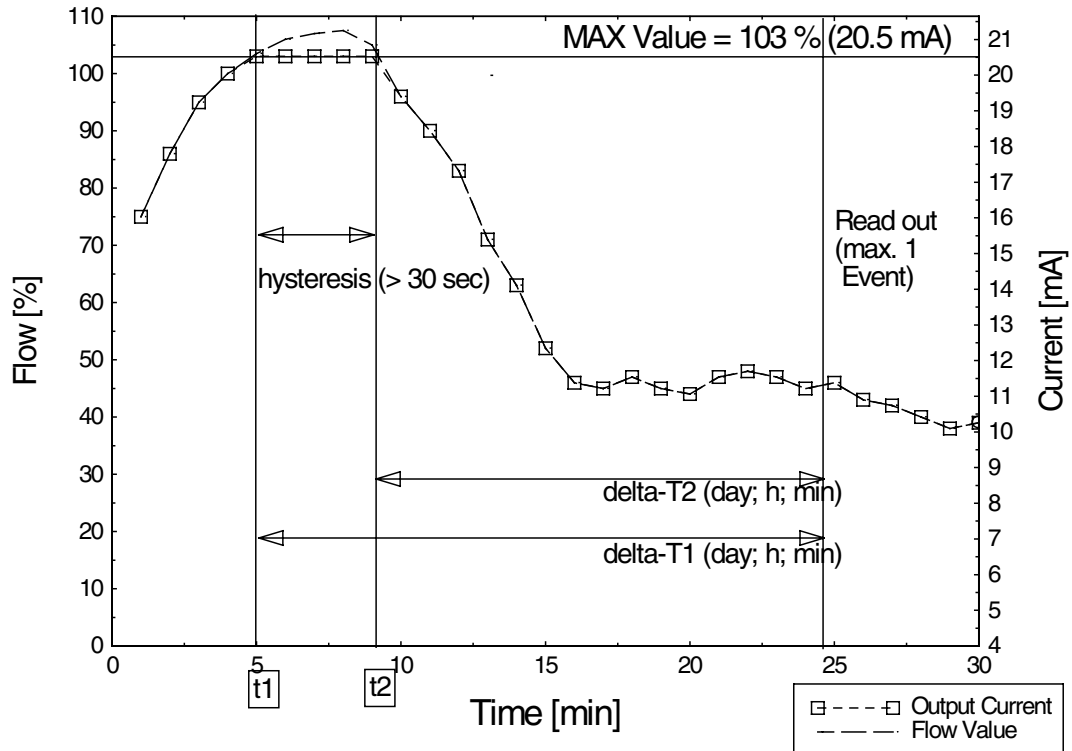

F73.EPS

Device setup

Diag/Service

Diagnostics

Float blocking

Float blocking	ON/OFF	Activate or deactivate float blocking
Set lower limit	5 %/15 %/30 %	Set lower limit of supervision range
Set supervise time	Turbulent flow Smooth flow	
Start autozero	Start	
Autozero value	Shows autozero value	
Detailed description of float blocking function see chapter 6.2.14.		

Device setup

Diag/Service

Power monitoring

Operation time	Days Hours Minutes	Time since last power on.
Oper time shadow	Days Hours Minutes	Time from... ... previous power on... ... to power off.
Reset power fail	Power fail warning is cleared.	

Description of power monitoring function:

After power on the minutes are counted in parameter Operation time.

At power off the time from parameter Operation time is stored in parameter Over time shadow.

After power off/on the power fail warning is set. It can be cleared by Reset power fail.

7.4.3 Basic-Setup Menu

Device setup

Basic setup

Tag	Tag Number (8 characters)
Flow unit	Flow measurement unit
Temp unit	Temperature measurement unit
Set damping	Obtained damping
Long tag	Long Tag Number (24 characters)

7.4.4 Detailed-Setup Menu

Device setup

Detailed setup

Characterize meter

Details on the measuring tube.

Snsr unit	Flow measurement unit in accordance with scale
Scale USL	Upper sensor limit related to flow
Snsr s/n	Serial number of the measuring tube
Final assy no.	Number of final assembly
MS Code	Ordering code of the device

Device setup

Detailed setup

Configure signal

Flow damping

Flow damping	Read damping value
Set damping	0.25 s/1.00 s/5.00 s/10.00 s

Device setup

Detailed setup

Configure signal

Flow unit table

EU/US	Read preset unit set (see chapter 6.2.2)
-------	--

Device setup

Detailed setup

Configure signal

Flow unit select

Selectable flow units:

EU	US
Cum/h	Cum/h
L/h	NmlCum/h
NmlCum/h	Kg/h
NmlL/h	StdCuFt/h
MeiTon/h	CuFt/h
Kg/h	Lton/h
StdCuFt/h	Lb/h
ImpGal/h	gal/h
Cum/min	Cum/min
L/min	NmlCum/min
NmlCum/min	Kg/min
NmlL/min	StdCuFt/min
MeiTon/min	CuFt/min
Kg/min	Lton/min
StdCuFt/min	Lb/min
ImpGal/min	gal/min

Device setup

Detailed setup

Configure signal

Total reset

Reset totalizer

Device setup

Detailed setup

Configure signal

Temperature unit

degC / degF Select temperature unit

Device setup

Detailed setup

Configure output

Analog output

Indication, test and adjustment of current output :

Flow AO Read Current output in mA

AO Alm typ Lo current < 3,6 mA at error

Hi current > 21.0 mA at error

Loop Test Set the analogue output fix to 4 mA, 20 mA or arbitrary current. Finish with 'End'.

D/A Trim Adjustment of current output at 4 mA and 20 mA.

Device setup

Detailed setup

Configure output

HART output

HART specific parameter :

Poll Addr Poll Address (Function see above) (Def.: 0)

Num req preams Number of leading FF to HART unit (Def.: 5)

Num resp pream Number of leading FF from HART unit (Def.:5)

Device setup

Detailed setup

Display selection

Selection of measuring value on display,
Different if manual calibration is activated.

For standard calibration table: Flow / Totalizer / Temperature

For manual calibration table: Percent / Temperature

Device setup**Detailed setup****Device Information****Unit specific data:**

Model	Model name	
Dev ID	Device ID	
Manufacturer	Manufacturer	
Distributor	Distributor	
Snsr s/n	Serial number of the measuring tube	
Final assy no	Number of final assembly	
Write protect	Write protection	
Tag	Type in Tag-Number	
Descriptor	Type in description	
Message	Type in message	
Date	Type in Date	
Poll addr	Type Poll Address	
Num req pream	Number of leading FF to HART unit	
Num rsp pream	Number of leading FF from HART unit	
Long tag	Type in Long Tag-number	
MS Code	Ordering code of the device	
Revision #'s	Revision numbers:	
	Universal rev.:	HART Universal Revision (5)
	Fld. Dev. rev.:	Field device Revision
	HW rev.:	Hardware Revision
	FW rev.:	Firmware Revision
	ADJ-EE rev.:	Adjustment-EEPROM Revision
	CAL-EE rev.:	Calibration-EEPROM Revision

7.4.5 Review**Device Setup****Review**

Model	Model name	
Dev id	Device ID	
Manufacturer	Manufacturer	
Distributor	Distributor	
Flow Snsr s/n	Serial number of the measuring tube	
Final assy no	Number of final assembly	
Write Protect	Write protection	
Tag	Tag Number	
Descriptor	Description	
Message	Message	
Date	Date	
Poll address	Poll address	
Num req pream	Number of leading FF to HART unit	
Num rsp pream	Number of leading FF from HART unit	
Long tag	Type in Long Tag-number	
MS Code	Ordering code of the device	
Universal rev.:	HART Universal Revision	(5)
Fld. Dev. rev.:	Field device Revision	
HW rev.:	Hardware Revision	
FW rev.:	Firmware Revision	
ADJ-EE rev.:	Adjustment-EEPROM Revision	
CAL-EE rev.:	Calibration-EEPROM Revision	

7.5 HART 7 - Menu (Rev 10 DD rev 01)

Chapter 7.5 New

Device Setup	Process Variables	Flow [unit] Flow Data Quality Flow Limit Status Total [kg] Total Data Quality Total Limit Status Percent [%] Percent Data Quality Percent Limit Status Temp [°C] Temp Data Quality Temp Limit Status Loop current [mA] Loop current Data Quality Loop current Limit Status Time Stamp				R R R R R R R R R R R R R R
	PV PV Data Quality PV Limit Status PV % range PV Loop current PV LRV PV URV					R R R R R R
	Diag/Service	Test device	Device status	Device Status	PV Out of Limits Non-PV Out of Limits PV Analog Channel Saturated PV Analog Channel Fixed More Status Available Cold Start Configuration Changed Device Malfunction	R R R R R R R R
				Ext dev status	Maintenance required Device variable alert Critical Power Failure	R R R
				Device Diagnostic Status 0	Simulation active Non-Volatile memory failure Volatile memory error Watchdog reset executed Voltage conditions out of range Environmental conditions out of range Electronic failure Device configuration locked	R R R R R R R
				Status group 0	RAM error ADC error ADJ-EE error CAL-EE error Totalizer false Flow Overrun ADJ-EE error 2 Float blocked	R R R R R R R R
				Status group 1	Temp over limit Max flow1 active Max flow2 active FB autozero active Power fail warning Operate timer error Man. adjust act. FB indicat. act.	R R R R R R R R
				Cfg chng count		R
			Event Status	Event Status	Configuration changed event pending Device status event pending More status available event pending	R R R
				First time Unack Event Triggered		R

	Reset all errors	perform		p	
	Self test	perform		p	
	Master reset	perform		p	
	Squawk	perform		P	
	Device reset	perform		p	
	Lock/Unlock device	perform		p	
	Reset Cfg chng flag	perform		p	
Loop test	4/20/other/end			T	
Calibration	Apply URV/LRV	4 mA	Set as 4 mA value Read new value Leave as found	S S S	
		20 mA	Set as 20 mA value Read new value Leave as found	S S S	
		Exit			
	Reset URV/LRV	LRV (4 mA)	Perform		p
		URV (20 mA)	Perform		p
		Exit			
	D/A trim	4 mA/ 20 mA		S	
	Calib table	Standard version			R
		Distance version			R
	Manual adjustment	Status man. adjustment	ON / OFF		R
		Activate/deactiv	ON / OFF		S
		Selected adjustm. point			R
Set adjustm. points		5 %			S
		15 %			S
		25 %			S
	35 %			S	
	45 %			S	
	55 %			S	
	65 %			S	
75 %			S		
85 %			S		
95 %			S		
105 %			S		
Reset adjustment table	Perform			p	
Diagnostics	Temp max log	Temp max log	ON / OFF	p	
		Time/value	Days		R
			Hours		R
			Minutes		R
	Temp max			R	
	Old time/value	Days		R	
		Hours		R	
		Minutes		R	
		Temp max		R	
	Clear values	perform			p
	Flow URV log	Flow URV log	ON OFF		R/S R/S
		URV overrun time	Days		R
Hours				R	
Minutes				R	
URV underrun time		Days		R	
		Hours		R	
	Minutes		R		
Min overrun time	15 sec			R/S	
	30 sec			R/S	
	1 min			R/S	
	5 min			R/S	
10 min				R/S	
Clear values	perform			p	

		Float blocking	Float blocking	ON OFF	R/S R/S
			Set lower limit	5 % 15 % 30 %	R/S R/S R/S
			Set supervis. time for	Turbulent flow Smooth flow	R/S R/S
			Start autozero	Perform	P
			Autozero value		R
	Power monitoring	Operation time	Days; Hours; Minutes		R
		Oper time shadow	Days; Hours; Minutes		R
		Reset power fail	perform		P
	Real-Time Clock	Current Date	MM/DD/YYYY		R
		Current Time	HH:MM:SS		R
		Set Clock Date	MM/DD/YYYY		R
		Set Clock Time	HH:MM:SS		R
		Real Time Clock Flags	Non-Volatile Clock Clock Uninitialized		R R
		Set Real-time Clock	perform		P
Basic Setup	Tag	Long tag			R/S
		Flow units select [unit]	(See Detailed Setup/Configure Signal/Flow units select)		R/S
		Temperature unit [unit]	(See Detailed Setup/Configure Signal/Temperature unit)		R/S
		Flow damp			R/S
Detailed Setup	Characterize meter	Operating conditions	Density [Unit] Viscosity [Unit] Temperature [Unit] Pressure [Unit] Reference Pressure [Unit]		R R R R R
			Pressure Conditions	Absolute Gage Vacuum	R R R
		Medium data	Fluid Name		
			Fluid Phase	Liquid Gas in Operation Gas in Normal Cond Gas in Standard Cond	R R R R
			Flow Reference	Volume Flow Mass Flow	R R
		Flow scale unit			
		Scale USL [Unit]			R
		MS-Code			R
		RAMC s/n			R
		RAMC firmware rev.			R

Configure output	Analog output	PV Loop current [Unit]			R
		PV LRV [Unit]			R/S
		PV URV [Unit]			R/S
		PV Alrm typ	Hi		R/S
			Lo		R/S
		Loop current mode	Disabled		R/S
			Enabled		R/S
		Loop test			T
		D/A trim			T
	HART output	Poll addr			R/W
		Num req preams			R
		Num resp preams			W
		Burst Configuration	Burst Message 1		
			Burst 1 mode	Off	R/S
				Wired HART Enabled	R/S
			Burst 1 Command	Cmd 1: PV	R/S
				Cmd 2: %range/ current	R/S
				Cmd 3: Dyn vars/ current	R/S
				Cmd 9: Device vars /w status	R/S
				Cmd 33: Device variables	R/S
				Cmd 48: Read Additional Device Status	R/S
			Classification	Device Variable not classified Temperature	R
			Update Period		R
			Max Update Periode		R
			Trigger Mode	Continuous	R
				Window	R
				Rising	R
				Falling	R
				On-change	R
			Trigger Units		R
			Trigger Level		R
			Set Burst 1 Period	Perform	P
			Set Burst 1 Trigger	Perform	P
			Burst 1 variables	Burst Variable Code 1...8	R/S
				Flow	R/S
				Total	R/S
				Percent	R/S
				Temp	R/S
				Percent range	R/S
				Loop current	R/S
				Primary variable	R/S
				Secondary variable	R/S
				Tertiary variable	R/S
				Quaternary variable	R/S
				Not used	R/S

					Burst Message 2	Burst 2 mode	Off	R/S
						Wired HART Enabled	R/S	
					Burst 2 Command	Cmd 1: PV	R/S	
						Cmd 2: %range/current	R/S	
						Cmd 3: Dyn vars/current	R/S	
						Cmd 9: Device vars/w status	R/S	
						Cmd 33: Device variables	R/S	
						Cmd 48: Read Additional Device Status	R/S	
					Classification	Device Variable not classified Temperature	R	
							R	
					Update Period		R/W	
					Max Update Period		R/W	
					Trigger Mode	Continuous	R	
						Window	R	
						Rising	R	
						Falling	R	
						On-change	R	
					Trigger Units		R	
					Trigger Level		R	
					Set Burst 2 Period	Perform	P	
Set Burst 2 Trigger	Perform	P						
Burst 2 variables	Burst Variable Code 1...8	Flow	R/S					
		Total	R/S					
		Percent	R/S					
		Temp	R/S					
		Percent range	R/S					
		Loop current	R/S					
		Primary variable	R/S					
		Secondary variable	R/S					
		Tertiary variable	R/S					
		Quaternary variable	R/S					
		Not used	R/S					

					Burst Message 3	Burst 3 mode	Off	R/S
						Wired HART Enabled	R/S	
					Burst 3 Command	Cmd 1: PV	R/S	
						Cmd 2: %range/current	R/S	
						Cmd 3: Dyn vars/current	R/S	
						Cmd 9: Device vars/w status	R/S	
						Cmd 33: Device variables	R/S	
						Cmd 48: Read Additional Device Status	R/S	
					Classification	Device Variable not classified	R	
						Temperature	R	
					Update Period		R/W	
					Max Update Period		R/W	
					Trigger Mode	Continuous	R	
						Window	R	
						Rising	R	
						Falling	R	
						On-change	R	
					Trigger Units		R	
					Trigger Level		R	
					Set Burst 3 Period	Perform	P	
Set Burst 3 Trigger	Perform	P						
Burst 3 variables	Burst Variable Code 1..8	Flow	R/S					
		Total	R/S					
		Percent	R/S					
		Temp	R/S					
		Percent range	R/S					
		Loop current	R/S					
		Primary variable	R/S					
		Secondary variable	R/S					
		Tertiary variable	R/S					
		Quaternary variable	R/S					
		Not used	R/S					

					Event Notification	Event Notification Control	Off	R/S
							Enable event notification on token-passing data link layer	R/S
						Event Notification Retry Time		R/W
						Max Update Time		R/W
						Event Debounce Interval		R/W
					Event Mask	Device Status Mask	PV Out of Limits Non-PV Out of Limits PV Analog Channel Saturated PV Analog Channel Fixed More Status Available Cold Start Configuration Changed Device Malfunction	R/S R/S R/S R/S R/S R/S R/S R/S
						Ext Dev Status Mask	Maintenance required Device variable alert Critical Power Failure	R/S R/S R/S
						Device Diagnostic Status 0 Mask	Simulation active Non-Volatile memory failure Volatile memory error Watchdog reset executed Voltage conditions out of range Environmental conditions out of range Electronic failure Device configuration locked	R/S R/S R/S R/S R/S R/S R/S R/S

									Device Diagnostic Status 0	Simulation active	R
									Latched Value	Non-Volatile memory failure	R
										Volatile memory error	R
										Watchdog reset executed	R
										Voltage conditions out of range	R
										Environmental conditions out of range	R
										Electronic failure	R
										Device configuration locked	R
									Device Specific Status 0 Latched Value	RAM error	R
										ADC error	R
										ADJ-EE error	R
										CAL-EE error	R
										Totalizer false	R
										Flow overrun	R
										ADJ-EE error 2	R
										Float blocked	R
									Device Specific Status 1 Latched Value	Temp over limit	R
										Max flow1 active	R
										Max flow2 active	R
										FB autozero active	R
										Power fail warning	R
										Operate timer error	R
										Man. adjust act. FB indicat. act.	R
									Time First Unack Event Triggered	HH:MM:SS	R
									Config Change Counter Latched Value		R
									Event Status	Configuration changed event pending	R
										Device status event pending	R
										More status available event pending	R
									Read Event Data	perform	p
									Clear Event Data	perform	p

					Flow Update Time Period		R
					Total Update Time Period		R
					Percent Update Time Period		R
					Temp Update Time Period		R
				Trend Configuration	Number of Trends supported		R
					Trend Control	<input type="checkbox"/> Disable <input type="checkbox"/> Enable single data point trending <input type="checkbox"/> Enable filtered trending <input type="checkbox"/> Enable average trending	R/S R/S
					Trend Device Variable	<input type="checkbox"/> Flow <input type="checkbox"/> Percent <input type="checkbox"/> Temp	R/S R/S R/S
					Trend Sample Interval	<input type="text" value="HH:MM:SS"/>	R/W
					Trend data	<input type="button" value="Refresh Trend Data"/> <input type="button" value="perform"/> Trend Device Variable Trend Units Trend Classification Trend 0 Date Stamp <input type="text" value="MM:DD:YYYY"/> Trend 0 Time Stamp <input type="text" value="HH:MM:SS"/> Trend Value (1, newest to 12, oldest) Trend Value (x) Data Quality Trend Value (x) Limit Status	p R R R R R R
					PV is		R
					SV is		R
					TV is		R
					QV is		R
	Display selection		Standard	ManCal	<input type="checkbox"/> Flow <input type="checkbox"/> Totalizer <input type="checkbox"/> Percent <input type="checkbox"/> Temperature	<input type="checkbox"/> Percent <input type="checkbox"/> Temperature	R/S R/S R/S R/S
	Device information		Model Dev Id Manufacturer Distributor Final asmbly num Write protect Cfg chng count Tag Long tag Descriptor Message Date Poll addr Loop current mode	<input type="checkbox"/> Enabled <input type="checkbox"/> Disabled	Num req preams Num resp preams MS-Code RAMC s/n RAMC firmware rev. Device Profile Revisions # 's	<input type="checkbox"/> Universal rev <input type="checkbox"/> Fld Dev. rev <input type="checkbox"/> Hardware rev <input type="checkbox"/> Software rev <input type="checkbox"/> ADJ-EE rev <input type="checkbox"/> CAL-EE rev	R R R R R/W R R/W R/W R/W R/W R/S R/S R W R R R R R R

Write protect Menu	Write protect				R	
	Enable wt 10min New password				W W	
Review	Model				R	
	Dev Id				R	
	Manufacturer				R	
	Distributor				R	
	Final asmbly num				R	
	Write protect				R	
	Cfg chng count				R	
	Max dev vars				R	
	Tag				R	
	Long tag				R	
	Descriptor				R	
	Message				R	
	Date				R	
	Poll addr				R	
	AO Alrm typ				R,W	
	Loop current mode				R,W	
	Num req preams				R	
	Num resp preams				R	
	MS-Code				R	
	RAMC s/n				R	
	RAMC firmware rev.				R	
	Universal rev				R	
	Fid. Dev. rev				R	
	Hardware rev				R	
	Software rev				R	
	ADJ-EE rev				R	
	CAL-EE rev				R	
	Operating conditions	Density				R
		Viscosity				R
		Temperature				R
		Pressure				R
		Reference Pressure				R
		Pressure Conditions	Absolute			
Gage						R
Vacuum						R
Medium data		Fluid Name				R
		Fluid Phase	Liquid			R
	Gas in Operation					R
	Gas in Normal Cond					R
Gas in Standard Cond				R		
Flow Reference	Volume Flow				R	
	Mass Flow				R	
R=Read, T=Test, p=perform W=Write,S=Set						
HOT KEY	Write protect				R	
	Wrt enable 10 min New password				W W	

7.6. Description of the HART 7 - Parameter

Chapter 7.6 New

Online

This menu shows current process data

Device Setup	Device setup menu
PV	Flow in measurement unit
PV Data Quality	Quality of flow value
PV Limit Status	Limit status of flow value
PV % rng	%-value related to 20 mA
PV Loop current	Current output in mA
PV LRV	Lower range value related to the current output
PV URV	Upper range value related to the current output

7.6.1 Process variables

Device Setup

Process variables

Flow	Flow in measurement unit
Flow Data Quality	Quality of flow value
Flow Limit Status	Limit status of flow value
Total	Totalized value
Total Data Quality	Quality of total
Total Limit Status	Limit status of total
Percent	Percent value of flow
Percent Data Quality	Quality of percent
Percent Limit Status	Limit status of percent
Temp	Temperature in transmitter
Temp Data Quality	Quality of temperature
Temp Limit Status	Limit status of temperature
Loop current	Current output in mA
Loop current Data Quality	Quality of current value
Loop current Limit Status	Limit status of current value
Time stamp	Real-Time clock time stamp

7.6.2 Diagnostic- and Service-Menu

Device Setup

Diag/Service

Test device

Device status

Device status

Process applied to primary variable is outside the operating limits of the field device

Process applied to non-primary variable is outside the operating limits of the field device

PV Analog Channel Saturated

PV Analog Channel Fixed

Field Device has more status available

A reset or self test of the field device has occurred, or power has been removed or reapplied

A modification has been made to the configuration of the field device

Field device has malfunction due to a hardware error or failure

Ext dev status

Maintenance required

Device variable alert

Critical Power failure

Device Diagnostic Status 0

Simulation active

Non-Volatile memory failure

Volatile memory error

Watchdog Reset executed

Voltage condition out of range

Environmental condition out of range

Electronic failure

Device configuration locked

Status group 0

RAM Error	OFF/ON	Memory error
ADC Error	OFF/ON	Error at A/D converter
ADJ-EE-Error	OFF/ON	Error in adjustment-EEPROM
CAL-EE Error	OFF/ON	Error in calibration-EEPROM
Totalizer false	OFF/ON	Totalizer value fault
Flow Overrun	OFF/ON	Flow too high
ADJ-EE Error 2	OFF/ON	Adjustment-EEPROM fault
Float blocked	OFF/ON	Float-Move-Detection recognized, supervision time passed

Status group 1

Temp over limit	OFF/ON	Temperature exceeds 70° C
Max flow1 active	OFF/ON	URV overrun
Max flow2 active	OFF/ON	URV underrun
FB autoz active	OFF/ON	Float blocking autozero on
Power fail warn	OFF/ON	Power off has happened
Oper timer error	OFF/ON	Operation timer fault
Man adjust act.	OFF/ON	Manual adjustment activated
FB indicat. act.	OFF/ON	Float-Move-Detection activated

Cfg chng count

Actual configuration changed counter value

Legend for table on next page:

1): On every Power Up, this warning occurs; it is NOT SHOWN ON DISPLAY.

2): If this function is active, the bars are NOT BLINKING ON DISPLAY.

Type: The information will be divided into errors and warnings.

Current: An error will change the output current to the selected error current level.

The level is selectable by „Alarm select“ in HART (default: LOW)!

Bars blinking: All 8 bars are blinking in case of an error or warning if not otherwise denoted.

HART: The marked errors/warnings are displayed on the HHT375/475 and DD/DTM.

Clear all: The indicated error/warning can be reset or disabled by the clear all function.

Status	Type	Current output Current value	Display		Clear all	Device status	Ext. device status	Device diag. status 0	PV Value	PV Data Quality	PV Limit Status	
			Bars blinking	Error on Display								
Status group 0												
RAM error	error	<3.6 mA / >21 mA	-----	00000001	no	More status available Device malfunction	no change	Volatile memory error	Flow: meas. Total: hold Percent: meas. Temp: meas.	Flow: Bad Total: Bad Percent: Bad Temp: Bad	Flow: Not limited Total: Constant Percent: Not limited Temp: Not limited	
ADC error	error	<3.6 mA / >21 mA	-----	00000010	no	More status available Device malfunction	no change	Electronic failure	Flow: meas. Total: hold Percent: meas. Temp: meas.	Flow: Bad Total: Bad Percent: Bad Temp: Bad	Flow: Not limited Total: Constant Percent: Not limited Temp: Not limited	
ADJ-EE error	error	<3.6 mA / >21 mA	-----	00000100	no	More status available Device malfunction	no change	Non-Volatile memory failure	Flow: meas. Total: hold Percent: meas. Temp: meas.	Flow: Bad Total: Bad Percent: Bad Temp: Bad	Flow: Not limited Total: Constant Percent: Not limited Temp: Not limited	
CAL-EE error	error	<3.6 mA / >21 mA	-----	00001000	no	More status available Device malfunction	no change	Non-Volatile memory failure	Flow: meas. Total: hold Percent: meas. Temp: meas.	Flow: Bad Total: Bad Percent: Bad Temp: no change	Flow: Not limited Total: Constant Percent: Not limited Temp: no change	
Totalizer false	warning	no change	-----	00010000	yes	More status available	no change	no change	measured	no change	no change	
Flow overrun	warning	no change	-----	00100000	yes	PV out of limits More status available	Device variable alert	no change	Flow: hold Total: measured Percent: hold Temp: meas.	Flow: Bad Total: Bad Percent: Bad Temp: no change	Flow: High limited Total: Not limited Percent: High limited Temp: no change	
ADJ-EE error 2	warning	no change	-----	01000000	no	More status available	no change	Non-Volatile memory failure	measured	no change	no change	
FB time elapsed	error	<3.6 mA / >21 mA	-----	10000000	yes	More status available Device malfunction	no change	no change	Flow: meas. Total: hold Percent: meas. Temp: meas.	Flow: Bad Total: Bad Percent: Bad Temp: no change	Flow: Not limited Total: Constant Percent: Not limited Temp: no change	
Status group 1												
Temp over limit	warning	no change	-----	00000001	yes	Non-PV out of limits More status available	Device variable alert	Environmental conditions out of range	measured	no change	no change	
Max flow 1 active	warning	no change	-----	00000010	yes	More status available	no change	no change	measured	no change	no change	
Max flow 2 active	warning	no change	-----	00000100	yes	More status available	no change	no change	measured	no change	no change	
FB autozero active	warning	no change	-----	00001000	yes	no change	no change	no change	measured	no change	no change	
Power fail warning	warning	no change	*1)	00010000	yes	no change	no change	no change	measured	no change	no change	
Operate timer error	warning	no change	-----	00100000	yes	More status available	no change	no change	measured	no change	no change	
Man. Adjust act.	warning	no change	*2)	01000000	no	no change	no change	no change	Flow: zero Total: zero Percent: meas. Temp: meas.	Flow: Manual/Fixed Total: Manual/Fixed Percent: no change Temp: no change	Flow: Low limited Total: Low limited Percent: no change Temp: no change	
FB indicat. act.	warning	no change	*2)	10000000	no	no change	no change	no change	measured	no change	no change	

Device Setup**Diag/Service****Test device****Event Status**

Configuration changed event pending

Device status event pending

More status available event pending

Device Setup**Diag/Service****Test device****Reset all errors**

Reset all resettable errors and warnings according to table on page 7-31

Device Setup**Diag/Service****Test device****Self test**

Execute a self-test to find existing errors.

Device Setup**Diag/Service****Test device****Squawk**

Indicates squaking by blinking bars on display ("-- --").

Device Setup**Diag/Service****Test device****Master reset**

Execute master reset. Selected parameters are set to default.

Parameter	Data form	Data range	R: read; W: Write	After Master Reset
Disp select	Select	Flow, Totalizer, Percent, Temperature	R/W	Totalizer
Temperature unit	Select	degC, degF	R/W	degC
Flow damp	Decimal	0 ... 10 sec	R/W	1.0 sec
PV URV	Decimal	Flow unit	R/W	100%
PV LRV	Decimal	Flow unit	R/W	0%
Float Blocking	Select	OFF, ON	R/W	OFF
Set lower limit	Select	5%, 15%, 30%	R/W	5%
Set supervision time	Select	Turbulent Flow, Smooth Flow	R/W	Turbulent Flow
Autozero value	Decimal	0.000 - 9.999	R	0.000

Device Setup**Diag/Service****Test device****Device reset**

Execute device reset. No parameters are changed.

Device Setup**Diag/Service****Lock/Unlock device**

Locks the upper selection key on the display and the write access of a second master. Changes can only be made by the connected HART master.

The first master can switch to normal operation by unlock the device.

Device Setup

Diag/Service

Reset Cfg chng flag

Resets the Configuration changed flag.

Device Setup

Diag/Service

Loop Test

Set the analogue output fix to 4 mA, 20 mA or arbitrary current.
Finish with 'End'.

Device Setup

Diag/Service

Calibration

Apply URV/LRV

4 mA	Assignment of the 4 mA value		
	Set as 4 mA value:	Current flow is set to 4 mA.	
	Read new value:	Read current flow for 4 mA.	
	Leave as found:	No change	
20 mA	Assignment of the 20 mA value		
	Set as 20 mA value:	Current flow is set to 20 mA.	
	Read new value	Read current flow for 20 mA	
	Leave as found:	No change	
Exit	Leave parameter		

Device Setup

Diag/Service

Calibration

Reset URV/LRV

Reset 4 mA	Set 4 mA to factory set LRV
Reset 20 mA	Set 20 mA to factory set URV
Exit	Leave parameter

Device Setup

Diag/Service

Calibration

D/A Trim

Adjustment of the current output to 4 mA and 20 mA.

Device Setup

Diag/Service

Calibration

Calib table

Selection of calibration table: Standard / Distance version
(Depends on ordered device; only readable)

Device Setup

Diag/Service

Calibration

Manual adjustment

Status man.adjustment	ON/OFF	Show status of manual adjustment table
Activate/deactivate	ON/OFF	Activate or deactivate manual adjustment table
Set adjustm. points	5 %...105 %	Set manual adjustment points
See description of manual adjustment in chapter 6.2.9		
Reset adjustment table	Resets manual adjustment table to factory defaults	

Device Setup

Diag/Service

Diagnostics

Temp max log

Temp max log	ON/OFF	Activate or deactivate Temp max Logging function
Time/value	Days Hours Minutes	Time stamp of appearance of ... maximum temperature
Temp max	Max.temperature value	
Old time/value	Days Hours Minutes Temp max	Time stamp of appearance of... ... maximum temperature before... ... clear or reset Max. temperature value before clear or reset
Clear values	The values in parameter Time/value are written to parameter Old time/value.	

Parameter Time/value is set to actual time stamp and temp max is set to actual temperature.

Description of temperature maximum logging function:

The temperature value is supervised constantly. As soon as the value exceeds the actual maximum value, the point of time will be recognized. The actual maximum value is overwritten by a higher value automatically, if it lasts more than 30 seconds.

The determined values (max temperature/time stamp) can be cleared by the user. They are written into the parameter "Old time/value" after "Clear values" or after power off/on, "Master Reset" or "Device Reset". The time/value is set to the actual time stamp, the max temperature value is set to the actual temperature value.

By switching Temp max log off the values are not cleared, but the displayed values are set to zero.

When exceeding the maximum temperature of 70° C the error message "Temp over limit" appears.

By changing the unit (from degC to degF or vice versa) the Temp max log values are cleared.

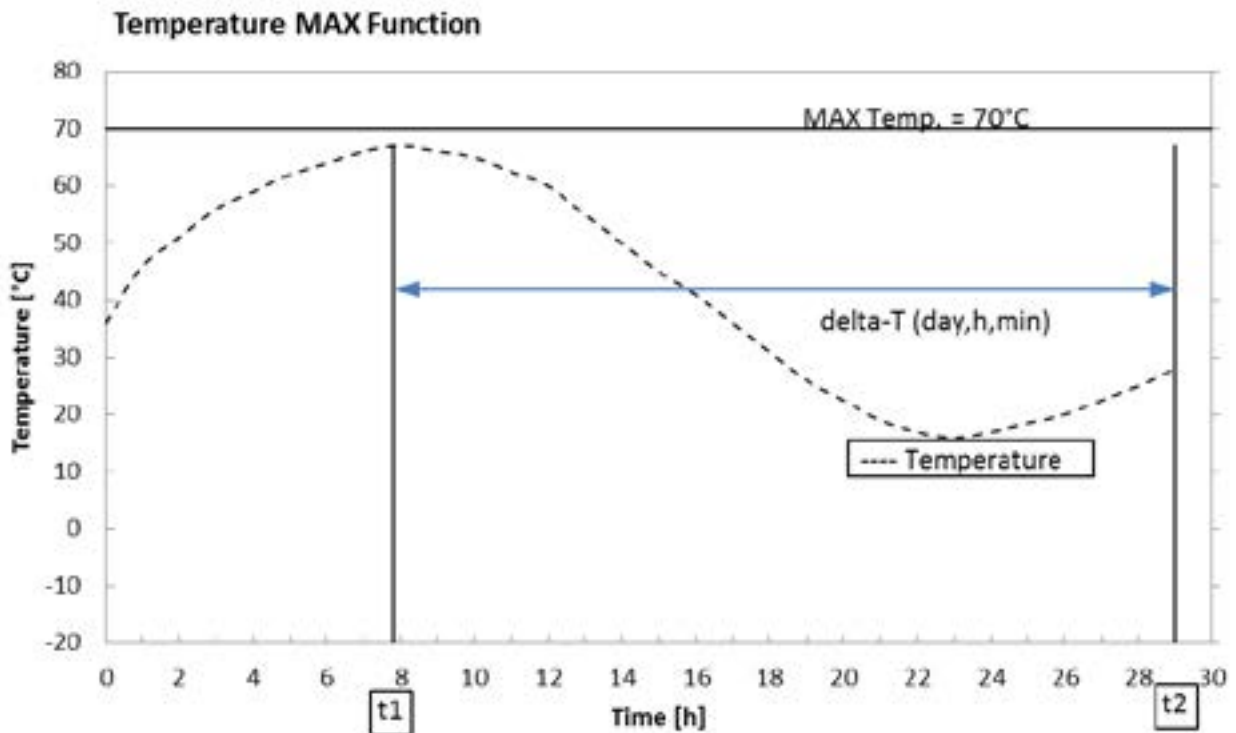

Device Setup

Diag/Service

Diagnostics

Flow URV log

Flow URV log	ON/OFF	Activate or deactivate Flow URV Logging function
URV overrun time	Days/Hours Minutes	Time since... ... exceeding URV
URV underrun time	Days/Hours Minutes	Time since... ... fall below URV
Min overrun time	Selection of hysteresis time	
Clear values	Clears the values in URV overrun time and URV underrun time	

Description of Flow URV logging function

The flow value is supervised constantly. As soon as the value reaches the upper limit value (103 %; 20.5 mA) event 1 is recognized. If this error condition remains actively longer than the hysteresis value, the limiting value recognition is activated, the overrun condition and the time stamp is stored.

As soon as the flow value falls below the limit value, the supervision ends, the underrun condition and the event 2 time stamp is stored. For a new cycle the hysteresis time must pass.

After the recognition you can request the passed time:

Time stamp from event1 till time stamp from event2: delta-Time

The time difference is the time the upper limit was exceeded: hysteresis <= t <= delta-time

The actual cycle is overwritten automatically by a new one. The stored values will be cleared after power off. The default value for hysteresis is 30 seconds.

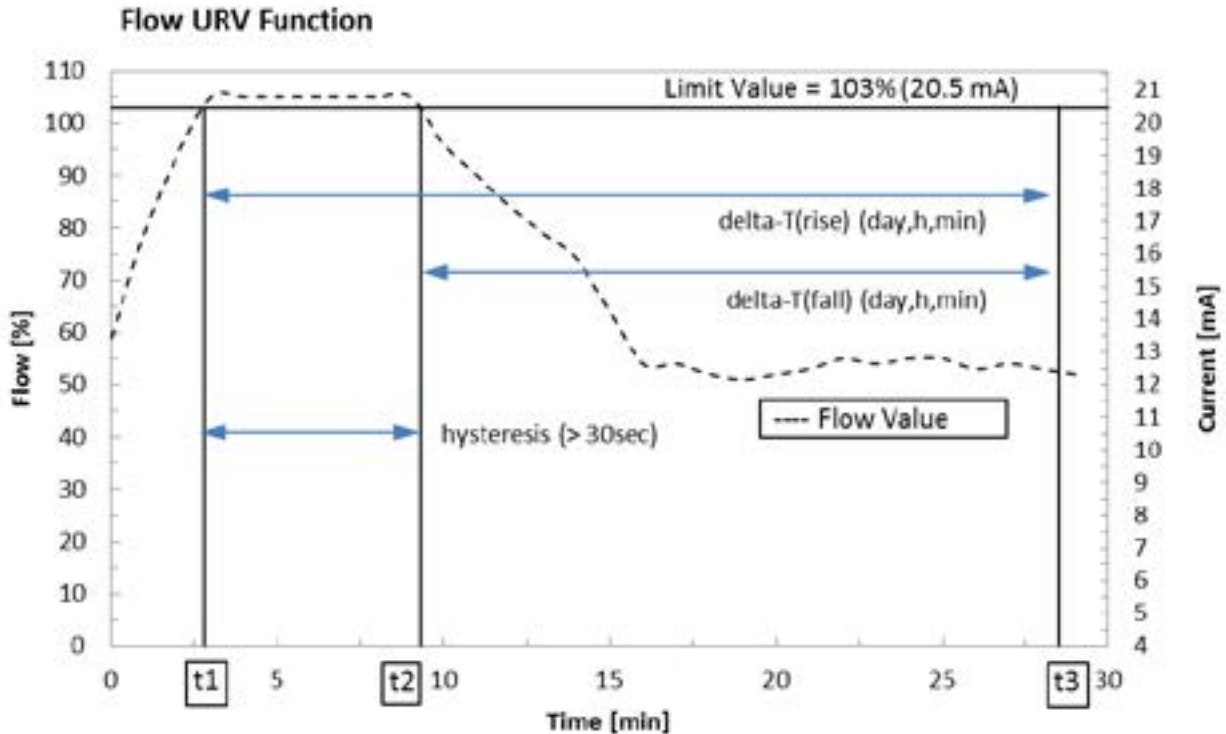

Device Setup**Diag/Service****Diagnostics****Float blocking**

Float blocking	ON/OFF	Activate or deactivate float blocking
Set lower limit	5 %/ 15 %/ 30 %	Set lower limit of supervision range
Set supervise time	Turbulent flow Smooth flow	
Start autozero	Start	
Autozero value	Shows autozero value	
See description of float blocking function in chapter 6.2.14		

Device Setup**Diag/Service****Power monitoring**

Operation time	Days	Count of days since operation starts.
	Hours	Count of hours since operation starts.
	Minutes	Count of minutes since operation starts.
Oper time shadow	Days	Counts of days until last reset.
	Hours	Counts of hours until last reset.
	Minutes	Counts of minutes until last reset.
Reset power fail	Power fail warning is cleared.	

Description of power monitoring function:

This function counts up the operation minutes and stores the time in the parameter "Operation time". After "Power on", "Master Reset" or "Device Reset" the actual time stamp is stored in parameter "Oper time shadow". The time difference to "Operation Time" gives the last point in time of reset.

After power off/on the power fail warning is set. It can be cleared by "Reset power fail" or "Reset all errors".

The "Operation time" is the base for the time stamps of "Temp max log" and "Flow URV log".

Device Setup**Diag/Service****Real-Time Clock**

Current Date	Current calendar date
Current Time	Current day time
Set Clock Date	Last entered current calendar date
Set Clock Time	Last entered current day time
Real Time Clock flags	Counts changes on Real-time Clock.
Set Real-time Clock	Enter current calendar date and day time.

Description of real time clock function:

The real-time clock has to be set by the parameter "Set Real-time Clock"

This function counts up the operating time and stores the values in the parameter "Current Date" and "Current Time". "Set Clock Date" and "Set Clock Time" stores the last entered date/time.

The time value is reset to "00:00:00" after 24 hours (23:59:59).

After "Power on", "Master Reset" or "Device Reset" the Real-time Clock is set to its initial value:

01/01/1900 00:00:00

7.6.3 Basic- Setup Menu

Device Setup

Basic setup

Tag	Tag Number (8 characters)
Long tag	Long Tag Number (32 characters)
Flow unit select	Flow measurement unit
Temperature unit	Temperature measurement unit
Flow damp	Damping time for flow value

7.6.4 Detailed- Setup Menu

Device Setup

Detailed setup

Characterize meter

Operating Conditions

Density	User's density on scale
Viscosity	User's viscosity on scale
Temperature	User's temperature on scale
Pressure	User's pressure on scale
Reference Pressure	User's pressure reference
Pressure conditions	User's pressure conditions

Medium data

Fluid name	User's fluid name
Fluid phase	User's fluid phase
Flow Reference	User's flow reference
Flow scale unit	Flow measurement unit in accordance with scale
Scale USL	Upper sensor limit related to scale unit
MS Code	Ordering code of the device
RAMC s/n	Serial number of the measuring tube
RAMC firmware rev	Firmware revision of the device

Device Setup

Detailed setup

Configure signal

Flow damp	Set damping time for flow value
Flow unit select	Select flow measurement unit
Total reset	Set totalized value to zero
Temperature unit	Select temperature unit degC / degF

Device Setup**Detailed setup****Configure signal****Flow unit select**

L/s	L/min	L/h	
Cum/s	Cum/min	Cum/h	Cum/d
gal/s	gal/min	gal/h	gal/d
Impgal/s	Impgal/min	Impgal/h	Impgal/d
Cuft/s	Cuft/min	Cuft/h	Cuft/d
bbbl/s	bbbl/min	bbbl/h	bbbl/d
	NL/min	NL/h	
	NCum/min	NCum/h	
	StdL/min	StdL/h	
	StdCum/min	StdCum/h	
	StdCuft/min	StdCuft/h	
g/s	g/min	g/h	
kg/s	kg/min	kg/h	kg/d
	t/min	t/h	t/d
lb/s	lb/min	lb/h	lb/d
	LTon/min	LTon/h	LTon/d

Device Setup**Detailed setup****Configure output****Analog output**

PV Loop current	Current output in mA
PV LRV	Lower range value related to the current output
PV URV	Upper range value related to the current output
PV Alrm typ	Current level at error
Loop Current mode	Enable mode of variable output current
Loop Test	Set the analogue output fix to 4 mA, 20 mA or arbitrary current.
D/A Trim	Adjustment of current output to 4 mA and 20 mA.

Device Setup**Detailed setup****Configure output****HART output**

Poll addr	Poll Address (Function see above) (Def.: 0)
Num req preams	Number of leading FF to HART unit (Def.: 5)
Num resp pream	Number of leading FF from HART unit (Def.:5)
Burst configuration	See chapter 7.6.7
Trend configuration	See chapter 7.6.9
PV is	Assignment of primary variable
SV is	Assignment of secondary variable
TV is	Assignment of tertiary variable
QV is	Assignment of quaternary variable

Device Setup

Detailed setup

Configure output

HART output

Burst configuration

See chapter 7.6.7

Burst Message 1

Burst Message 2

Burst Message 3

Event Notification

See chapter 7.6.8

Flow Update Time Period

Time between 2 measurements

Total Update Time Period

Time between 2 measurements

Percent Update Time Period

Time between 2 measurements

Temp Update Time Period

Time between 2 measurements

Device Setup

Detailed setup

Configure output

HART output

Trend configuration

See chapter 7.6.9

Number of trends supported

Trend Control

Trend Device Variable

Trend Sample Interval

Trend Data

Device Setup

Detailed setup

Display selection

Selection of measuring value on display:

For standard calibration table: Flow - Totalizer - Percent - Temperature

For manual calibration table: Percent - Temperature

Device Setup

Detailed setup

Device Information

Model	Model name
Dev ID	Device ID
Manufacturer	Manufacturer
Distributor	Distributor
Final assembly no	Number of final assembly
Write protect	Write protection
Cfg chng count	Number of configuration changes
Tag	Type in Tag-Number
Long tag	Type in Long Tag-Number
Descriptor	Type in description
Message	Type in message
Date	Type in Date
Poll addr	Type Poll Address
Loop Current mode	Enable mode of variable output current
Num req pream	Number of leading FF to HART unit
Num rsp pream	Number of leading FF from HART unit
MS Code	Ordering code of the device
RAMC s/n	Serial number of the measuring tube
RAMC firmware rev	Firmware Version of the Device
Device Profile	Process automation device
Revision #'s	Revision numbers
Universal rev	HART Universal Revision (7)
Fld. dev. rev	Field device Revision
Hardware rev	Hardware Revision
Software rev	Software Revision
ADJ-EE rev	Adjustment-EEPROM Revision
CAL-EE rev	Calibration-EEPROM Revision

7.6.5 Write protect menu

Write protect menu

Write protect	Read Status of write protection
Enable wrt 10min	Enable writing for 10 minutes by entering password. After writing a parameter the time of 10 minutes starts again.
New password	Selection of a new password by entering up to 8 character If 8 blanks are entered as new password, write protection is disabled. If the user password is lost, a joker password is available from the YOKOGAWA service department.

7.6.6 Review Menu

Review

Model	Model name	(RAMC)
Dev id	Device ID	
Manufacturer	Manufacturer	(Yokogawa)
Distributor	Distributor	(Yokogawa)
Final asmbly num	Number of final assembly	
Write Protect	Write protection	
Cfg chng count	Number of configuration changes	
Max dev vars	Max number of device variables	
Tag	Tag Number	
Long tag	Long Tag Number	
Descriptor	Description	
Message	Message	
Date	Date	
Poll address	Poll address	
AO Alrm typ	Current level at error (PV Alrm typ)	
Loop Current mode	Enable mode of variable output current	
Num req pream	Number of leading FF to HART - unit	
Num rsp pream	Number of leading FF from HART - unit	
MS Code	Ordering code of the device	
RAMC s/n	Serial number of the measuring tube	
RAMC firmware rev	Firmware Version of the Device	
Universal rev	HART Universal Revision	(7)
Fld. dev. rev	Field device Revision	
Hardware rev	Hardware Revision	
Software rev	Software Revision	
ADJ-EE rev	Adjustment-EEPROM Revision	
CAL-EE rev	Calibration-EEPROM Revision	

7.6.7 Burst Mode (Only available in HART 7)

When the **Burst mode** is set to "Wired HART Enabled", the transmitter continuously sends up to three data listed in table on page 7-42 Refer to the chapter 7.6.7.1 Burst Message for details.

When the **Burst mode** is set to "Wired HART Enabled", the transmitter can continuously sends alarm signal also. Refer to chapter 7.6.8 Event Notification for activating this function.

When changing the setting of **Burst mode**, set "Off" to the **Burst mode**. Default setting is "Off"

(1) **Burst message**

RAMC transmitter can transmit three burst messages at the maximum. The parameters for **Burst Message** are as follows.

- Burst Command
- Update Period and Max Update Period
- Burst Msg Trigger Mode

(2) **Burst mode setting procedure**

DD (HART 7)	[Root Menu] → Device setup → Detailed setup → Configure output → HART output → Burst configuration → Burst Message 1,2 or 3 → Burst Command
-------------	---

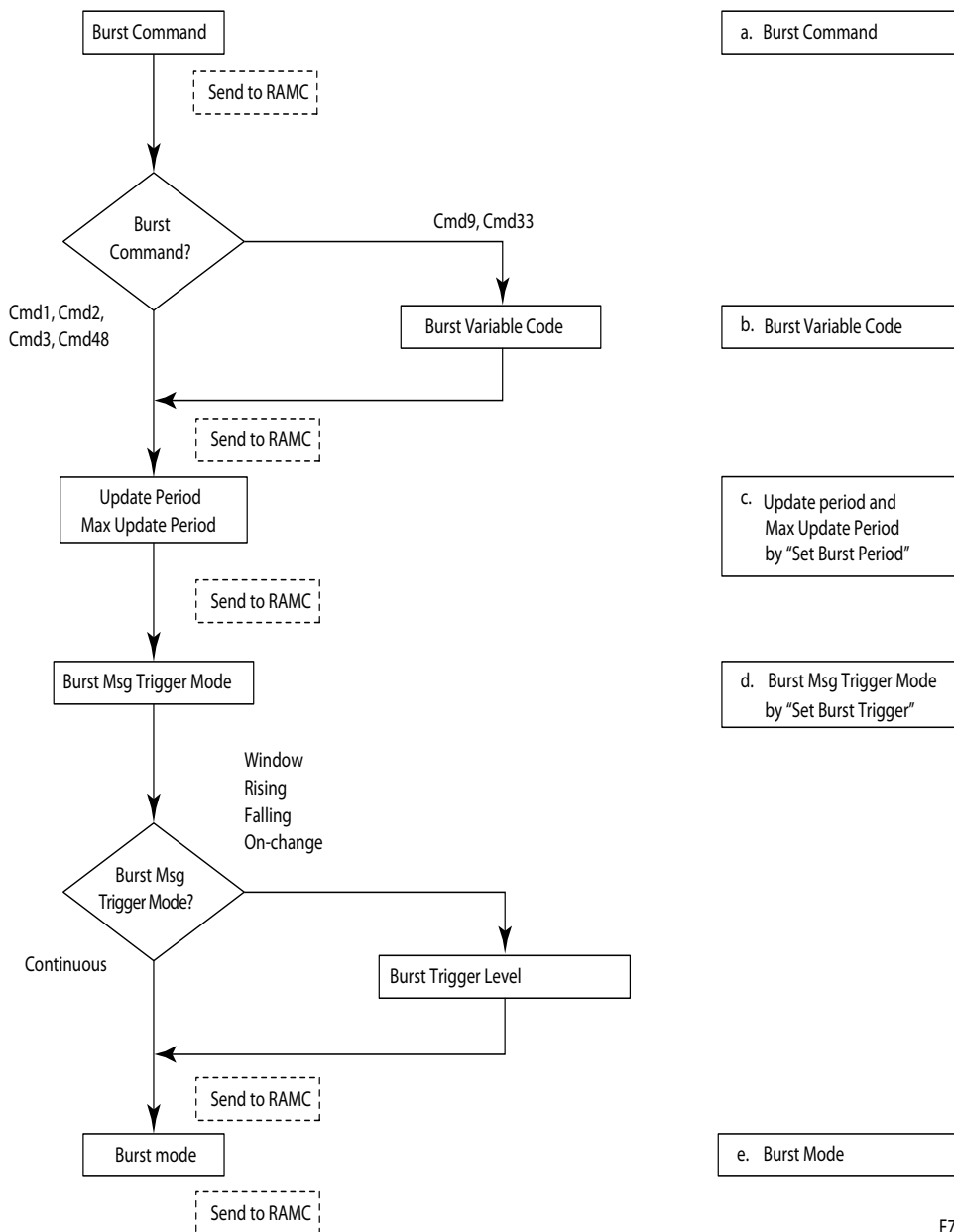

F77.EPS

a) **Burst Command**

Select the transmission data at **Burst Command** parameter.

Burst Command	Command Parameter
Cmd1: PV	Variable assigned to PV
Cmd2: % range/current	% range/current (Percent range, Loop current)
Cmd3: Dyn vars/current	Process vars/current (Loop current, PV, SV, TV,QV)
Cmd9: Device vars w/ Status	Process vars/% range/ current with status Mapping by user
Cmd33: Device variables	Process vars (PV, SV, TV,QV)
Cmd48: Read Additional Device Status	Self-diagnosis information

Burst parameters

Command parameter	Burst Command	Burst Msg Trigger Mode	Burst Trigger Source	Burst Trigger Units
PV (Either of from flow, total, percent, temp)	Cmd1: PV	Continuous	---	---
		Window	PV	Depend on the assigned variable to PV
		Rising		
		Falling		
		On-change		
% range/current (Percent range, Loop current)	Cmd2: % range/current	Continuous	---	---
		Window	% range	%
		Rising		
		Falling		
		On-change		
Process vars/current (Loop current, PV, SV, TV,QV)	Cmd3: Dyn vars/current	Continuous	---	---
		Window	PV	Depend on the assigned variable to PV
		Rising		
		Falling		
		On-change		
Process vars/% range/ current with status *1 (Select up to eight variables from flow, total, percent, temp, percent range, loop current)	Cmd9: Device vars w/ Status	Continuous	---	---
		Window	Top of Burst Device Variables	Depends on mapping
		Rising		
		Falling		
		On-change		
Process vars (Select up to four variables from flow, total, percent, temp)	Cmd33: Device variables	Continuous	---	---
		Window	Top of Burst Device Variables	Depends on mapping
		Rising		
		Falling		
		On-change		
Self-diagnosis information	Cmd48: Read Additional Device Status	Continuous	---	---

*1: Output the data with time and status.

b) Burst Variable Code

This parameter need to be set when **Burst Command** is Cmd9:

Device variables with status (up to eight items).

DD (HART 7)	[Root Menu] → Device setup → Detailed setup → Configure output → HART output → Burst configuration → Burst Message 1,2 or 3 → Burst device variables → Burst variables
Display item	Contents
Flow	Select the flow rate
Total	Select the totalized flow
Percent	Select the flow % rate
Temp	Select the onboard temperature
Percent range	Select the current % rate
Loop current	Select the output current value
Not used	All items up to this selection are transmitted

c) Burst Update Period and Max Update Period

Set the **Update Period** and the **Max Update Period**.

The **Update Period** specifies the rate at which data is transmitted as long as the trigger conditions of the **Burst Msg Trigger Mode** are met. The **Max Update Period** specifies the rate at which data is transmitted as long as the trigger conditions of the **Burst Msg Trigger Mode** are not met.

DD (HART 7)	[Root Menu] → Device setup → Detailed setup → Configure output → HART output → Burst configuration → Burst Message 1,2 or 3 → (Max) Update Period
Update Period / Max Update Period	0.5 s
	1 s
	2 s
	4 s
	8 s
	16 s
	32 s
	60 s – 3600 s any value

d) Burst Msg Trigger Mode

Set the **Burst Msg Trigger Mode** from the parameters shown below. When **Burst Msg Trigger Mode** is Window, Rising or Falling, set the **Burst Trigger Level**.

DD (HART 7)	[Root Menu] → Device setup → Detailed setup → Configure output → HART output → Burst configuration → Burst Message 1,2 or 3 → Burst Msg Trigger Mode
Display item	Contents
Continuous	Burst message is transmitted continuously
Window	In “Window” mode, the Trigger Value must be a positive number and is the symmetric window around the last communicated value
Rising	In “Rising” mode, the Burst Message must be published when the source value exceeds the threshold established by the trigger value.
Falling	In “Falling” mode, the Burst Message must be published when the source value fall below the threshold established by the trigger value.
On-change	In “On-change” mode, the Burst Message must be published when the source value on change established by the trigger value.

e) **Burst Mode**

DD (HART 7)	[Root Menu] → Device setup → Detailed setup → Configure output → HART output → Burst configuration → Burst Message 1,2 or 3 → Burst mode → Wired HART Enabled
--------------------	--

When the **Burst mode** is set to “Wired HART Enabled,” the transmitter starts to send the data.

Detailed Burst Menu Structure

Device Setup

Detailed setup

Configure output

HART output

Burst configuration

Burst Message 1

Burst 1 Mode R/S

Burst 1 Command R/S

Update Period R

Max Update Period R

Classification R

Trigger Mode R

Trigger Units R

Trigger Level R

Set Burst 1 Period Perform

Method to select update/max update period

Set Burst 1 Trigger Perform

Method to select trigger conditions

Burst 1 variables R/S

Burst Message 2

Burst 2 Mode R/S

Burst 2 Command R/S

Update Period R

Max Update Period R

Classification R

Trigger Mode R

Trigger Units R

Trigger Level R

Set Burst 2 Period Perform

Method to select update/max update period

Set Burst 2 Trigger Perform

Method to select trigger conditions

Burst 2 variables R/S

Burst Message 3

Burst 3 Mode R/S

Burst 3 Command R/S

Update Period R

Max Update Period R

Classification R

Trigger Mode R

Trigger Units R

Trigger Level R

Set Burst 3 Period Perform

Method to select update/max update period

Set Burst 3 Trigger Perform

Method to select trigger conditions

Burst 3 variables R/S

7.6.8 Event Notification (Only available in HART 7)

When a setting change and a change of the Self- diagnostics occur, the device detects it as an event and can transmit an alarm signal continuously. Up to three events that occurred can be stored. When using this function, set to **Burst mode** as “Wired HART Enabled”.

(1) Set Event Notification

- Procedure to call up the display

DD (HART 7)	[Root Menu] → Device setup → Detailed setup → Configure output → HART output → Burst configuration → Event Notification →
→ Event Notification Control	Stop the event monitor: Off Shift to the monitor state: Enable event notification on token- passing data link layer
→ Event Notification Retry Time	Set the retry time when the event occurs.
→ Max Update Time	Set the retry time when the event does not occur.
→ Event Debounce Interval	The setting of the minimum event duration
→ Event Mask	Set the status to detect

a) Event Notification Control

Select “Enable event notification on token-passing data link layer” in the **Event Notification Control** parameter to shift to the monitor state.

b) Event Notification Retry Time/ Max Update Time/ Event Debounce Interval

Set to Event Notification Retry Time, Max Update Time and Event Debounce Interval. For **Event Notification Retry Time**, set the value that is smaller than **Max Update Time**.

Event Notification Retry Time / Max Update Time	Event Debounce Interval
0.5 s	0.5 s
1 s	1 s
2 s	2 s
4 s	4 s
8 s	8 s
16 s	16 s
32 s	32 s
>60 s – 3600 s any value	>60 s – 3600 s any value

c) Event Status

Indicates the type of the pending events. The bits will be cleared after the appropriate latched value and the trigger time is acknowledged by **Clear Event Data**.

Event Status	Code	Description
Configuration changed event pending	0x01	The pending event is caused by a configuration change
Device status event pending	0x02	The pending event is caused by a device status change
More status available event pending	0x04	The pending event is caused by a more status available change

d) Event Mask

Set the status to be detected in the **Event Mask** parameter.

Device Status Mask	Bit mask assignment (see table on page 7-47)
Ext Dev Status Mask	
Device Diagnostic Status 0 Mask	
Device Specific Status 0 Mask	
Device Specific Status 1 Mask	

e) Event Report

Read the detected status in the appropriate Event Report parameter.

Device Status Latched Value	Latched value assignment (see table on page 7-47)
Ext dev status Latched Value	
Device Diagnostic Latched Value	
Device Specific Status 0 Latched Value	
Device Specific Status 1 Latched Value	
Time First Unack Event Triggered	Time of event trigger (Default when cleared: 13:16:57)
Config Change Counter Latched Value	Latched configuration changed counter value
Event Status	Status of pending events
Read Event Data	Perform reading of the oldest pending event data
Clear Event Data	Acknowledge of the oldest pending event data

Detailed Event Notification Menu Structure

Device Setup

Detailed setup

Configure output

HART output

Burst configuration

Event Notification

Event Notification Control	R/S
Event Notification Retry Time	R/S
Max Update Time	R/S
Event Debounce Interval	R/S

Event Mask

Device Status Mask	S
Ext Dev Status Mask	S
Device Diagnostic Status 0 Mask	S
Device Specific Status 0 Mask	S
Device Specific Status 1 Mask	S

Event Report

Device Status Latched Value	R
Ext Dev Status Latched Value	R
Device Diag. Status 0 Latched Value	R
Device Spec. Status 0 Latched Value	R
Device Spec. Status 1 Latched Value	R

Time First Unack Event Triggered	R
Cfg Change Counter Latched Val	R
Event Status	R

Read Event Data	Perform
Clear Event Data	Perform

Table: Status bit (code) assignment

Device status	Code	Mask	Latched Value
Process applied to primary variable is out of range	0x01	OFF/ON	OFF/ON
Process applied to non-primary variable is out of range	0x02	OFF/ON	OFF/ON
PV Analog Channel Saturated	0x04	OFF/ON	OFF/ON
PV Analog Channel Fixed	0x08	OFF/ON	OFF/ON
Field Device has more status available	0x10	OFF/ON	OFF/ON
A reset or self test of the field device has occurred	0x20	OFF/ON	OFF/ON
A modification has been made to the configuration	0x40	OFF/ON	OFF/ON
Field device has malfunction due to a hardware problem	0x80	OFF/ON	OFF/ON

Ext dev status	Code	Mask	Latched Value
Maintenance required	0x01	OFF/ON	OFF/ON
Device variable alert	0x02	OFF/ON	OFF/ON
Critical Power failure	0x04	OFF/ON	OFF/ON
PV Analog Channel Fixed	0x08	OFF/ON	OFF/ON

Device Diagnostic Status 0	Code	Mask	Latched Value
Simulation active	0x01	OFF/ON	OFF/ON
Non-Volatile memory failure	0x02	OFF/ON	OFF/ON
Volatile memory error	0x04	OFF/ON	OFF/ON
Watchdog Reset executed	0x08	OFF/ON	OFF/ON
Voltage condition out of range	0x10	OFF/ON	OFF/ON
Environmental condition out of range	0x20	OFF/ON	OFF/ON
Electronic failure	0x40	OFF/ON	OFF/ON
Device configuration locked	0x80	OFF/ON	OFF/ON

Status group 0		Code	Mask	Latched Value
RAM Error	Memory error	0x01	OFF/ON	OFF/ON
ADC Error	Error at A/D converter	0x02	OFF/ON	OFF/ON
ADJ-EE-Error	Error in adjustment-EEPROM	0x04	OFF/ON	OFF/ON
CAL-EE Error	Error in calibration-EEPROM	0x08	OFF/ON	OFF/ON
Totalizer false	Totalizer value fault	0x10	OFF/ON	OFF/ON
Flow Overrun	Flow too high	0x20	OFF/ON	OFF/ON
ADJ-EE Error 2	Adjustment-EEPROM fault	0x40	OFF/ON	OFF/ON
Float blocked	Float-Move-Detection recognized	0x80	OFF/ON	OFF/ON

Status group 1		Code	Mask	Latched Value
Temp over limit	Temperature exceeds 70°C	0x01	OFF/ON	OFF/ON
Max flow1 active	URV overrun	0x02	OFF/ON	OFF/ON
Max flow2 active	URV underrun	0x04	OFF/ON	OFF/ON
FB autoz active	Float blocking autozero on	0x08	OFF/ON	OFF/ON
Power fail warn	Power off has happened	0x10	OFF/ON	OFF/ON
Oper timer error	Operation timer fault	0x20	OFF/ON	OFF/ON
Man adjust act.	Manual adjustment activated	0x40	OFF/ON	OFF/ON
FB indicat. act.	Float-Move-Detection activated	0x80	OFF/ON	OFF/ON

7.6.9 Trend configuration (Only available in HART 7)

Data Trending is intended to reduce the number of transmissions to get data from a device. This can be useful for monitoring applications that do not need to get all data with low latency.

The RAMC supports the transmission of 1 trend information of a desired device variable.

When the **Trend control** is set from “Disabled,” to one of the following three settings the transmitter continuously calculates the trend data to be transmitted to the host.

Trend Control	Function
Disabled	No trend information will be calculated
Enable single data point trending	Only the value that was read during the occurrence of the sampling will be kept in the ring buffer.
Enable filtered trending	A filtered trend uses a time constant equal to one-third of the trend sample period to smooth the data. Consider a step change in the device variable value, this averaging time constant allows the returned trend value to reach 95 % of the step change in one trend sample period.
Enable average trending	The device averages the values that were taken during the trend sample period.

The values to be transmitted are the following:

Trend Device Variable	Parameter
Flow	Flow in measurement unit
Percent	Percent value of flow
Temperature	Temperature in transmitter

The sampling interval is selectable in the range of 1 s up to 2 h. The internal measurement cycle is 250 ms. The RAMC supports one ring buffer with 12 samples in length. The ring buffer is updated with samples of the desired device variable value at the rate indicate by the sample period.

The trend data can be displayed in the following menu by applying the parameter “Refresh Trend Data” to the device.

All 12 trend data values will be displayed.

When a Trend is not used it transmits NAN for the values and as status “bad / constant”

Device Setup

Detailed setup

Configure output

HART output

Trend configuration

Trend Data

Refresh Trend Data	Perform
Trend Device Variable	R/S
Trend Classification	R
Trend Units	R
Trend 0 Date Stamp	R
Trend 0 Time Stamp	R
Trend Value (x)	R
Trend Value (x) Data Quality	R
Trend Value (x) Limit Status	R

(x) = 12 values

7.7 Maintenance

7.7.1 Function test

- Wire the unit according to the connection diagram.
- Check HART- communication with HART- communicator or with PC with HART- ability communication program.
- Setting: Device setup / Process variables.
- PV AO shows the current value; compare this value with the measured current.

7.7.2 Troubleshooting

Do the following test if problems with HART units appear:

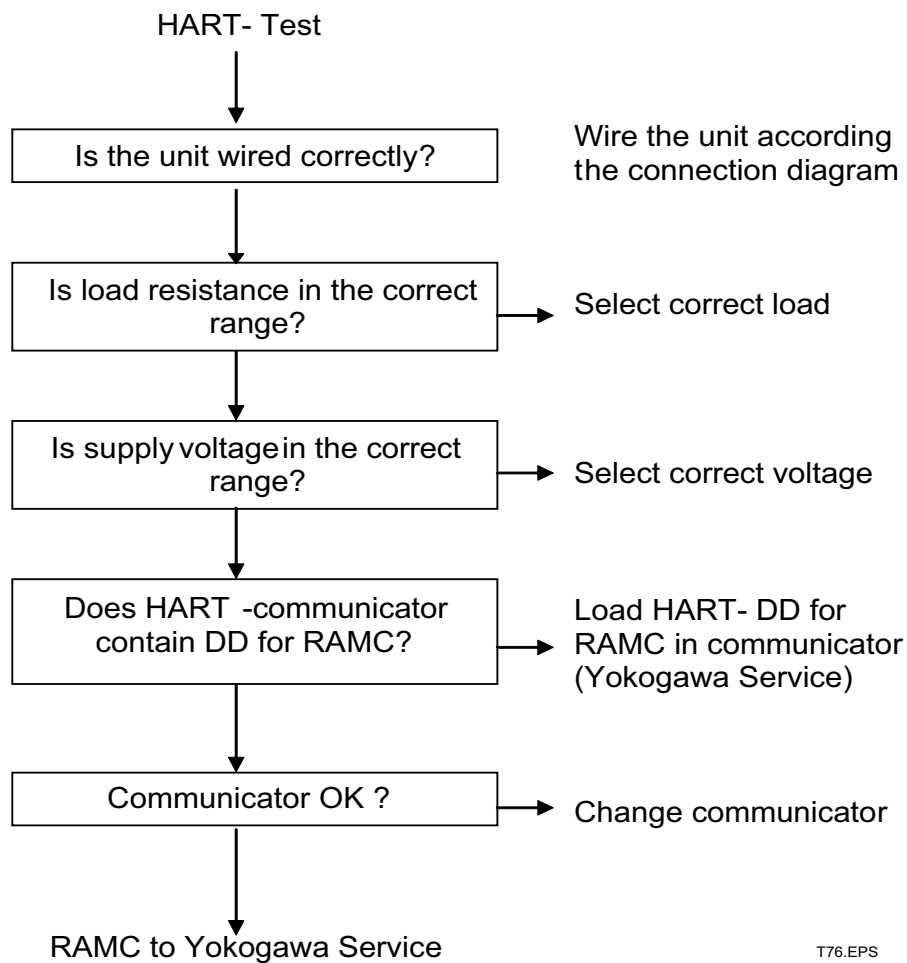

T76.EPS

Blank Page

8. Service

8.1 Maintenance

8.1.1 Function test

Checking free movement of pointer:

- Remove housing cover.
- After deflecting the pointer by hand, it must return to measurement value. If the pointer pivots to different values upon repeated deflections, there is too much friction in the bearings. In this case, send indication unit to service.

Checking free movement of float:

- First, free movement of pointer has to be ascertained.
- Check visually if pointer follows each flow rate change. If not, clean float and measuring tube.

Unit with electronic transmitter:

- The display must show values corresponding to indication function and measuring unit settings.
- The bars under the 8 digits must not flash. If an error occurs, the corresponding countermeasure (refer to chapter 6.2.8 error messages) has to be taken or the unit has to be sent to service.
- Without flow, the output current must be 0 or 4 mA. At a flow rate of 100 % the current must be 20 mA.

Additional function test for HART units (-H, -J)

- check HART communication using a HART Handheld terminal or a PC with HART communication software.
- Setting: Device setup / Process variables
- PV AO shows the current value that should be delivered at output – Check this value using a multimeter.

8.1.2 Measuring tube, float

The RAMC is maintenance-free. If contamination of the measuring tube impairs the mobility of the float, the tube and the float have to be cleaned. To do this, the RAMC has to be removed from the pipe.

Replacement or cleaning of the float:

- Remove RAMC from the pipe.
- Remove upper retainer from metering tube.
- Take float stopper and float out through the top of metering tube.
- Clean float and metering cone.
- Insert float and float stopper into the metering tube.
- Set retainer into tube.
- Check float for free movement.
- Install RAMC to the pipe.

Attention: Do not expose float to strong alternating magnetic fields. The float and especially its measuring edge must not be damaged.

8.1.3 Explosion drawing

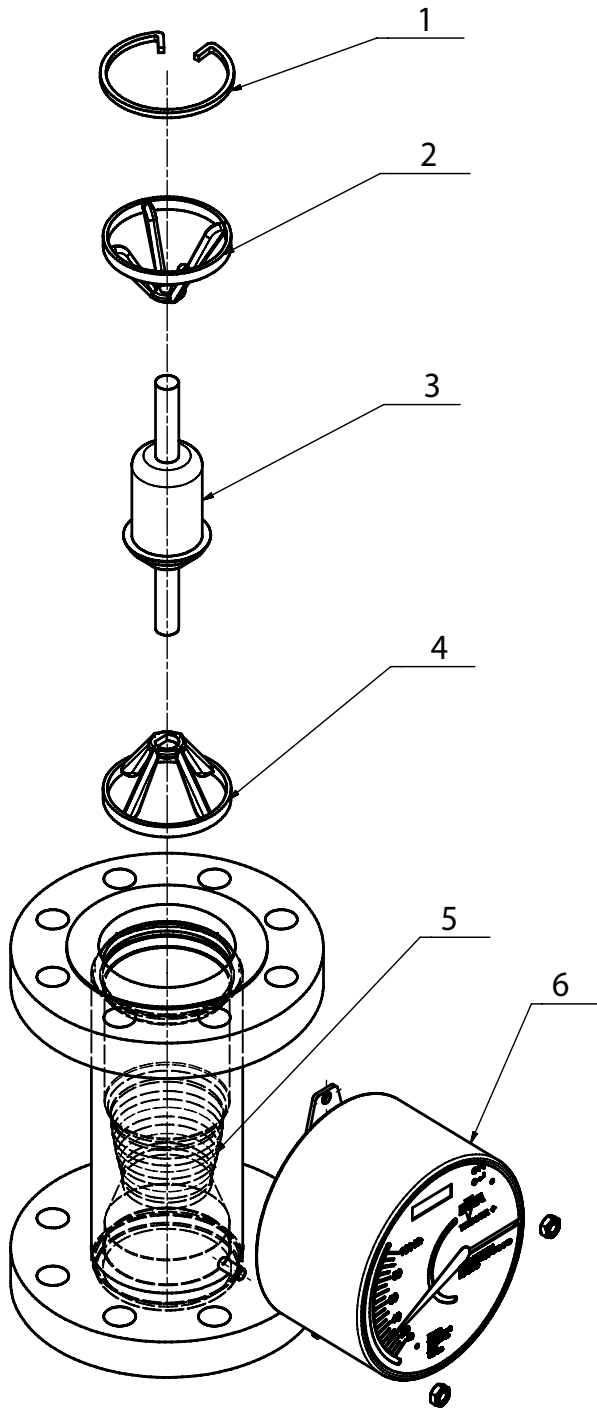

Number	Part
1	Circlip
2	Float stop
3	Float
4	Float stop welded in
5	Cone
6	Indicator

8.1.4 Electronic transmitter

The electronic transmitter is maintenance-free. The electronic section is sealed and cannot be repaired. Since the transmitter has been adjusted fully to the mechanical components at the factory, single components can only be replaced with a reduction of the accuracy.

Solely the display and operation unit (LCD PCB) can be replaced. For this the unit has to be sent to Yokogawa service.

The current output can be adjusted by means of software. The current output test in chapter 6.2.11 determines whether an adjustment is necessary. The adjustment is carried out according to chapter 6.2.6. The power supply PCB of 4-wire units includes a fuse. For fuse replacement be sure to switch off the power supply. Only use fuses with the capacity and characteristic as indicated in the specifications in section 9.5 or as imprinted on the fuse holder.

8.1.5 Exchange of EEPROM and scale

Preparations:

- Check the commissioning-no., the key-code and the data of the new parts.
- Switch off power supply.
- For units with option /KF1 wait more than 2 minutes before opening the indicator.
- For RAMC with housing type 91 unlock the safety screw at the cover.
- Remove the cover of the indicator unit.
- Make sure that all accessible parts are not under voltage.



IMPORTANT

The pointer may not be twisted or bent on the axis!

Exchange of EEPROM:



WARNING

The calibration-EEPROM can be damaged by electro-static discharge (ESD) . Therefore, only touch insulated parts and never terminals.

The EEPROM is plugged in on the right side of the electrical angle transmitters and safeguarded with a latch (s. fig 3-1 / 3-2).

- Unscrew the screw of the securing latch, but only a few turns!
- Turning the securing latch up, so that the EEPROM can be pulled out.
- Put in the new EEPROM (no wrong positioning possible).
- Turn the securing latch to below above the EEPROM and fix it with the screw.

Exchange of scale at units without limit switches:

- Unscrew the 2 screws of the scale.
- Pulling out the scale of the indicator unit to the left by raising the scale above the 4 corners for units with housing 66. For units with electronic transmitter the scale must additional raised above the 2 buttons.
- Sliding the new scale from the left under the pointer correspondingly until the 4 corner holes click in the footbridges for units with housing type 66 and the 2 buttons click in in the accompanying holes for unit with electronic transmitter.
- Fasten the scale with the 2 screws.

Exchange scale at units with limit switches:

Please, consult to this the service department of ROTA YOKOGAWA.

Final jobs :

- Connect the cover of the indicator
- For RAMC with housing type 91 lock the safety screw
- Switch on power supply
- Check function of the unit

8.1.6 Exchange of indicator

The indication units may be replaced by units of the same type, on the condition that the scale of the measuring tube as well as the calibration EEPROM (in case of electronic transmitter) are mounted on the new unit.

Operation for units with electronic transmitter (-E, -H, -J):

- Switch off power.
- For units with option /KF1 wait more than 2 minutes before opening the indicator.
- For RAMC with housing type 91 unlock the safety screw at the cover.
- Unscrew cover of indication unit.
- Disconnect cables and pull them through the cable glands out of the RAMC.
- Remove scale and calibration EEPROM from old indication unit and mount them to new indication unit.



WARNING

The calibration-EEPROM can be damaged by electrostatic discharge (ESD). Therefore, only touch insulated parts and never terminals.

- Do not bend pointer when mounting.
- Mount cover of indication unit.
- Dismount old indication unit from the measuring tube and replace it with a new one. Be sure to mount shims and distance rollers in the same sequence as before disassembled.

8.1.7 Troubleshooting

In case the RAMC does not work properly, use the following flow charts for troubleshooting, then check, isolate and remedy the fault.

Precision problems with "T" unit: execute test 1

Precision problems with "E" or "H" or "J" unit: execute test 1 and test 2

HART communication problems with "H" or "J" unit: execute test 3 and see chapter 7.7.

If the indicated countermeasure do not remedy the fault or in case of troubles which cannot be remedied by the user, please contact your YOKOGAWA service centre.

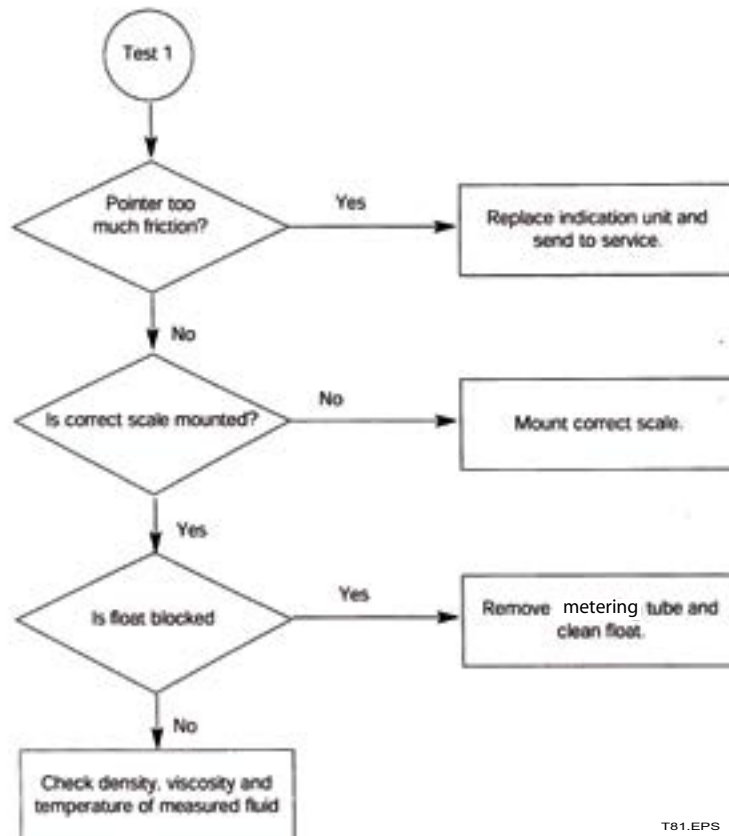

T81.EPS

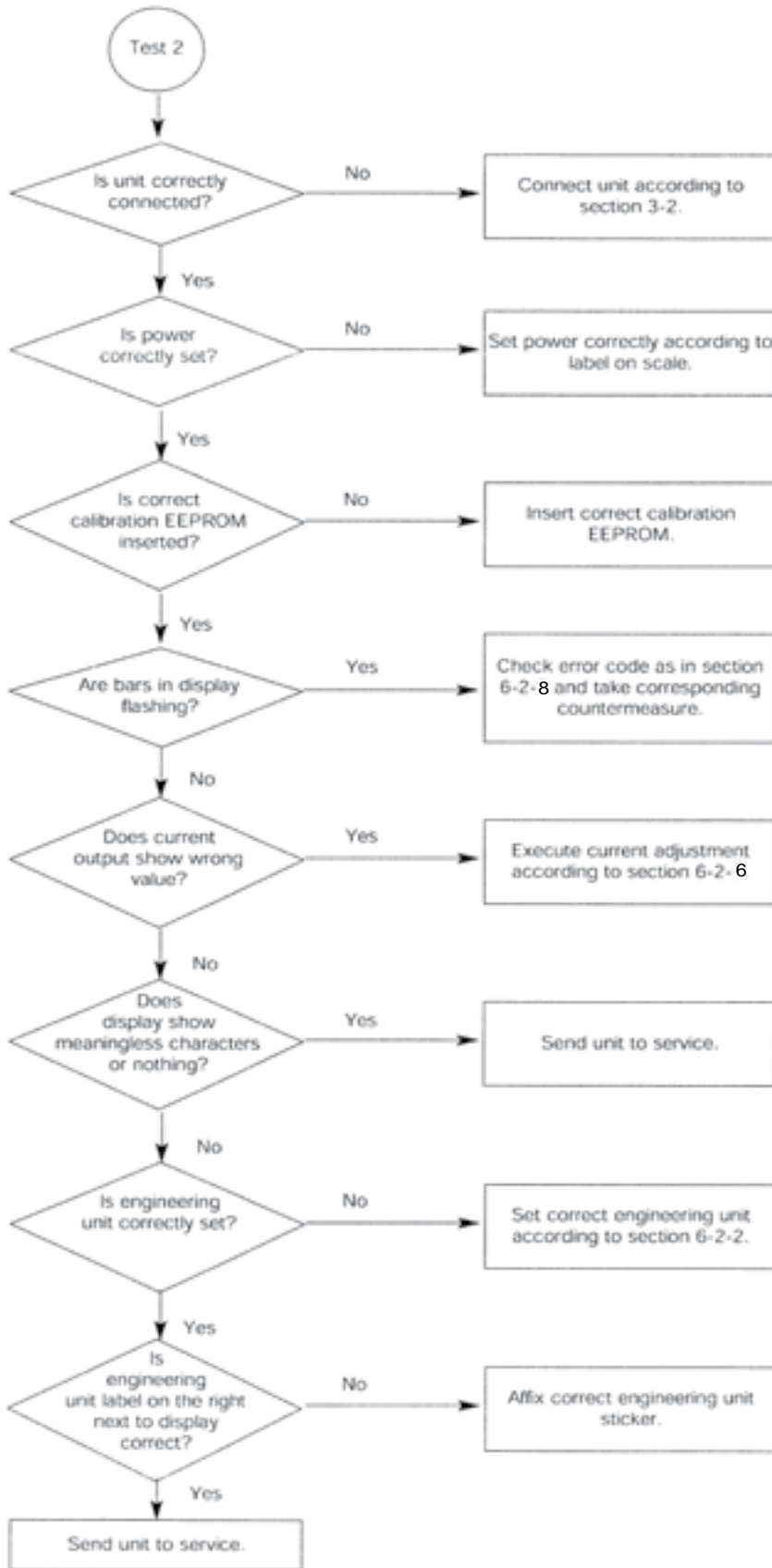

T82.EPS

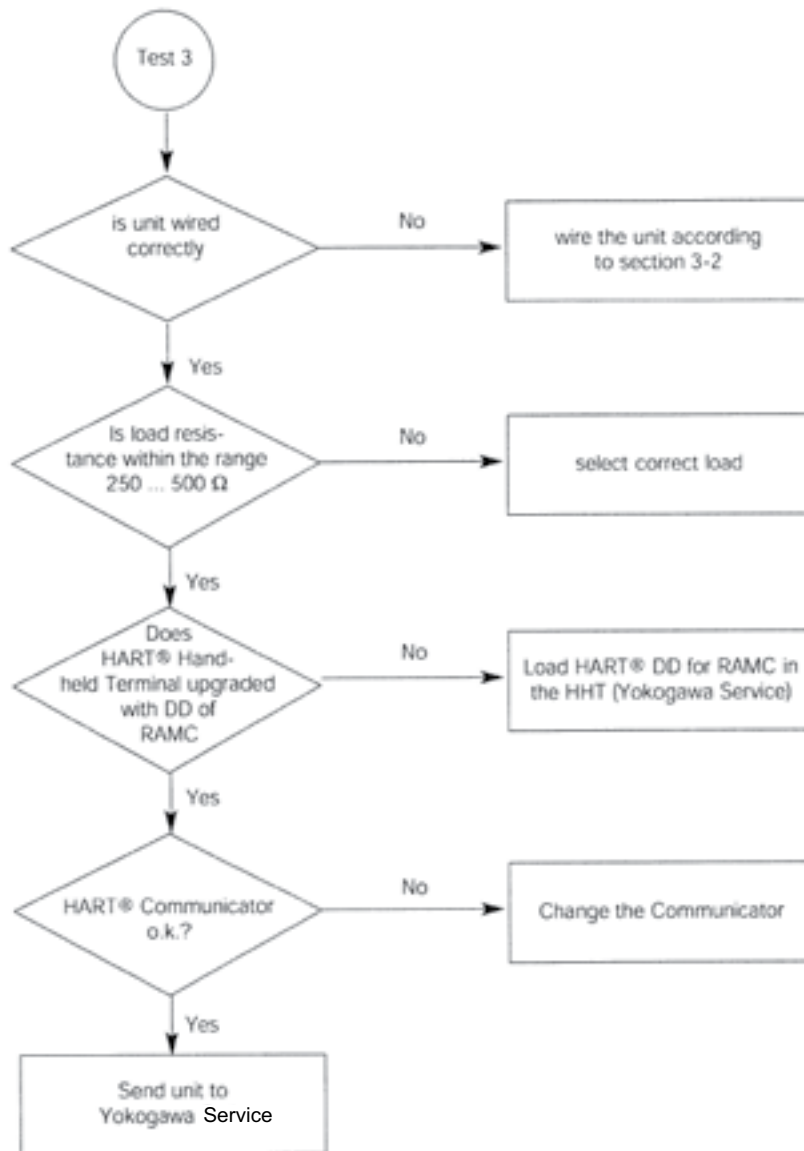

T83.EPS

8.2 Template for sending back to service

Sending an instrument back to service

Installation and operation of the Rotameter RAMC in compliance with this manual is generally trouble-free. In case a RAMC has to be sent for repairs or checking to our service, please observe the following: Due to legislation for the protection of the environment and for the safety of our staff, YOKOGAWA may only ship, repair and check sent devices on the condition that this does not constitute any risk to environment and staff.

YOKOGAWA can only process your returned RAMC if you attach a certificate of harmlessness according to the following sample.

If the unit has been in contact with corrosive, poisonous, flammable or water polluting substances, you must

- ensure that all parts and hollow spaces of the unit are free of these dangerous substances.
- attach a certificate of harmlessness to the returned unit.

Please understand that YOKOGAWA cannot process your returned unit without such a certificate.

ROTA YOKOGAWA GmbH & Co. KG
 Service & Repair Department
 Rheinstraße 8; D - 79664 Wehr
 Phone no.: +49 (0)7761-567-190
 Fax no.: +49 (0)7761-567-285
 e-Mail: services.flow@de.yokogawa.com



Declaration of Decontamination

Legal regulations for the safety of our employees and operating equipment determine that we need the declaration of decontamination before your order can be handled.
Please make sure to include it with the shipping documents, attached to the outside of the packaging you use for shipment.

Customer data		
Company:		
Address:		
Contact person:		E-Mail:
Phone no.:		Fax no.:
Reference/Order no.:		
Instrument data*		
Type:	Serial no.:	
Type:	Serial no.:	
<small>*If not enough, note on separate sheet</small>		
Process data		
Process medium:		
Medium is:	<input type="checkbox"/> toxic <input type="checkbox"/> corrosive <input type="checkbox"/> explosive <input type="checkbox"/> biological hazardous <input type="checkbox"/> unknown if dangerous <input type="checkbox"/> non hazardous	Remarks:
Cleaning agent:		
Kind of cleaning :		
Other remarks / Reason of return:		

We hereby confirm that this statement is filled in completely and truthfully. The returned instruments were carefully cleaned and are thus free from product residue and dirt. I agree that if this arrangement does not match with the instruments, they will be sent back to the above mentioned customer address at our expenses.

Name	Date	Signature
------	------	-----------

Blank Page

9.2 Options

Options	Code	Description	Restriction
Indicator	/A5	Thread for cable gland ASME ½" NPT female	Not with /A13
	/A12	US- engineering units	Only for indicator E, H
	/A13	Thread for cable gland ISO M20 x 1,5 female	Only for housing 90
	/A16	Indicator on 95 mm extension	Only for housing 90, 91
	/A20	Scale for type T66	Not with hazardous approval type; not with indicator
	/A21	Scale and EEPROM for type E66, H66, G66	Not with hazardous approval type not with indicator; not with /A16
	/A22	Scale for type T90, T91	Not with hazardous approval type; not with indicator
	/A23	Scale and EEPROM for type E90, H90, G90, J90, E91, H91, G91, J91	Not with hazardous approval type; not with indicator; not with /A16
	/A25	Pressure balance element	Not with /KS2, /ES2, /KF1, /EF1, /NF1, /GF1 and housing 91 with /A5 or /A13
	/A26	Indicator for -40 °C ambient temperature	Not with /K1, /K2, /K3, /K9, /K10, /KF1, /EF1, /NF1, /KS2, /ES2, power supply 14n + 24n; /FS1, /CS1 not with -E, -H, -J
Marking	/B0	Tag plate (1.4404/316L) on flange and marking on scale	Plate 9 x 40 mm; max. 45 digits
	/B1	Tag plate (1.4404/316L) fixed by wire and marking on scale	Plate 9 x 40 mm; max. 45 digits
	/BT2	Software tag, bus address for Profibus PA	32 digits for tag; 4 digits bus address; only indicator G
	/B4	Neutral version	Not with hazardous approval type
	/B8	Customer provided marking on label	
	/B10	Percent scale	
	/BG	Customer specific notes on scale	Max. 45 digits
/BD	Dual scale	Adjustment only for the first mentioned fluid	
Limit switches	/K1	MIN- contact	Not for power supply 14n + 24n
	/K2	MAX- contact	Not for power supply 14n + 24n
	/K3	MIN-MAX- contact, MIN-MIN- contact, MAX-MAX- contact	Not for power supply 14n + 24n
	/K6	MIN- contact "Fail safe" version	Not for power supply 14n + 24n
	/K7	MAX- contact "Fail safe" version	Not for power supply 14n + 24n
	/K8	MIN-MAX- contact "Fail safe" version	Not for power supply 14n + 24n
	/K9	MIN-MIN- contact "Fail safe" version	Not for power supply 14n + 24n
/K10	MAX-MAX- contact "Fail safe" version	Not for power supply 14n + 24n	
Pulse output	/CP	Pulse output isolated	Only for power supply 14n + 24n
Flange Facing	/D10	Form B2 acc. to EN 1092-1	Only for EN- flanges (D2, D4)
	/D11	Form D acc. to EN 1092-1	Only for EN- flanges (D2, D4)
Damping	/SD	Float damping system	Only for SS; not for cone 81, 82; only for gas application
Flange protection	/QK	Flange covers	Only for flanges A1, A2, A3, D2, D4, D5, D6
Delivery to Korea	/KC	With KC-mark for Korea	Not with /VE or /CN
Eurasian Conformity	/VE	With EAC- mark	Not with /KC or /CN
Delivery to China	/CN	For delivery to China	Not with /VE or /KC
Housing Coating	/X1	Single layer epoxy coating system for housing type 91; Cover green RAL 6001, Bottom green RAL 6001	Not for housing 90; not with /KC1 or /GC1
	/X2	High Anti Corrosion coating (3 layers) for housing type 91; /A16 will also be coated; Cover yellow RAL 1021, Bottom white RAL 9001	Not for housing 90; not with /KC1 or /GC1
Heat tracing	/T1	Heat tracing, process connection G ¼" PN 40 female thread	Only for SS material of wetted parts
	/T2	Heat tracing, process connection DN 15 PN 40	Only for SS material of wetted parts
	/T3	Heat tracing, process connection DN 25 PN 40	Only for SS material of wetted parts
	/T4	Heat tracing, process connection ASME ½" 150#	Only for SS material of wetted parts
	/T5	Heat tracing, process connection ASME 1" 150#	Only for SS material of wetted parts
	/T6	Heat tracing, process connection ¼" PN 40 NPT female thread	Only for SS material of wetted parts
Power supply for electronic transmitter	/UT	RN221N-B1, 20...250V DC/AC, Ex i, HART compatible	Only for indicator E, H, J

Options	Code	Description	Restriction
Test and certificates	/H1	Oil + fat free for wetted surfaces acc. ASTM G93-03 level C	
	/H3	Certificate pure water application	
	/P2	Certificate of compliance with the order acc. EN 10204: -2.1	
	/P3	As /P2 + Test report acc. EN 10204 -2.2	
	/P6	Material certificate acc. EN 10204 -3.1	only for metallic pressurized parts
	/PM3	PAMI test (3 points: Process connection inlet, measuring tube, process connection outlet)	only for SS material of wetted parts
	/PP	Pressure test report measuring system	according to EN 12266-1
	/PT	Flow table for conversion	
	/P9	Dye Penetration test acc. DIN EN ISO 3452-1 at the welding of the process connection, with certificate	Not for connection RAMC01-T6SS-□□ S0-..., RAMC01-G6SS-□□ S0-...; not for /T□; not with /P15 or /P16
	/P10	Combination of /P3 + /P6 + /PP	see individual options
	/P11	Combination of /P3 + /P6 + /PM3	see individual options
	/P12	Combination of /P3 + /P6 + /P9 + /PP	see individual options; not with /P15 or /P16
	/P13	Combination of /P3 + /P6 + /P9 + /PM3 + /PP + /WP	see individual options; not with /P15 or /P16
	/P14	Dye Penetrant test of flange welding acc. ASME V	only for SS- wetted part material; Not for connection RAMC01-T6SS-□□ S0-..., RAMC01-G6SS-□□ S0-...; not for /T□
	/P15	ASME B31.3 compliance NORMAL FLUID SERVICE	only RAMC□-A1SS, RAMC□-A2SS, RAMC□-A3SS, not for /T□
	/P16	ASME B31.3 compliance Category M FLUID SERVICE	only RAMC□-A1SS, RAMC□-A2SS, RAMC□-A3SS, not for /Tx; only with /RTA or /P20
/P20	Combination of ASME package /P14, /WPA, /RTA	see individual options; only with /P15 or /P16	
/WP		WPS acc. DIN EN ISO 15609-1 (Welding Procedure Specification)	not for connection RAMC01-T6SS-□□ S0-..., RAMC01-G6SS-□□ S0-...; not for /T□; not with /P15 or /P16
		WPQR acc. DIN EN ISO 15614-1 (Welder Performance Qualification Record)	
		WQC acc. DIN EN 1418 (Welder Qualification Certificate), robot welding	
		WQC acc. DIN EN 287-1 (Welder Qualification Certificate), manual welding (SS)	
		WQC acc. DIN EN ISO 6906-4 (Welder Qualification Certificate), manual welding (nickel alloy)	
		WQC acc. DIN EN ISO 6906-4 (Welder Qualification Certificate), manual welding (nickel alloy)	
/WPA	Welding procedures and certificates acc. ASME IX	only with /P15 or /P16	
/RTA	X-ray test acc. ASME V	only with /P15 or /P16	
Gost approval	/QR2	Primary Calibration and Test Confirmation valid in Kazakhstan	See page 4; only with /VE
	/QR3	Primary Calibration and Test Confirmation valid in Uzbekistan	See page 4

Options	Code	Description	Restriction
Hazardous area approvals	/KS1	ATEX intrinsically safe "ia"	Only for power supply 424, 430, 434, 429; for indicator T only with limit switches
	/KS2	ATEX intrinsically safe "ia" + dust proof "tb"	Only for power supply 424, 430, 434; for indicator T only with limit switches; only for housing 91
	/KS3	ATEX intrinsically safe "ic" for use in category 3G	Only for power supply 424, 430, 434; for indicator T only with limit switches
	/ES1	IECEX intrinsically safe "ia"	Only for power supply 424, 430, 434; for indicator T only with limit switches
	/ES2	IECEX intrinsically safe "ia" + dust proof "tb"	Only for power supply 424, 430, 434; for indicator T only with limit switches; only for housing 91
	/ES3	IECEX intrinsically safe "ic"	Only for power supply 424, 430, 434; not with limit switches
	/FS1	FM intrinsically safe/ non incendive electr. transmitter (USA) FM intrinsically safe/ non incendive limit switches (USA)	Only for power supply 424 (electronic transmitter); for indicator T only with limit switches
	/CS1	FM intrinsically safe/ non incendive electronic transmitter (Canada), CSA intrinsically safe limit switches (Canada)	Only for power supply 424 (electronic transmitter); for indicator T only with limit switches; limit switches only /K1, /K2, /K3, only in combination with power supply /W□A or /W□B
	/NS1	NEPSI intrinsically safe approval (China)	Only for power supply 424, 430, 434; for indicator T only with limit switches; not with indicator J; only with /CN
	/GS1	EAC intrinsically safe "ia"	Only for power supply 424, 430, 434; only with /VE
	/US1	INMETRO intrinsically safe "ia"	Only for power supply 424, 430, 434; not with limit switches
	/KF1	ATEX flame proof "d"/ dust proof "tb"	Only for power supply 424, 430, 434; for indicator T only with limit switches; only with housing 91
	/EF1	IECEX flame proof "d"/ dust proof "tb"	Only for power supply 424, 430, 434; for indicator T only with limit switches; only with housing 91
	/NF1	NEPSI flame proof "d"/ dust proof approval (China)	Only for power supply 424, 430, 434; for indicator T only with limit switches; only for housing 91; only with /CN
	/GF1	EAC flame proof "d"	Only for power supply 424, 430, 434; for indicator T only with limit switches; only for housing 91; only with /VE
/KC1	ATEX non- electrical type	Only for indicator T without limit switches	
/GC1	EAC non- electrical type	Only for indicator T without limit switches; only with /VE	
Power supply for limit switches (transmitter relay)	/W1A	KFA5-SR2-Ex1.W/ 115 V AC, 1 channel	Only for limit switches /K1, /K2, /K3
	/W1B	KFA5-SR2-Ex2.W/ 115 V AC, 2 channel	Only for limit switches /K1, /K2, /K3
	/W2A	KFA6-SR2-Ex1.W/ 230 V AC, 1 channel	Only for limit switches /K1, /K2, /K3
	/W2B	KFA6-SR2-Ex2.W/ 230 V AC, 2 channel	Only for limit switches /K1, /K2, /K3
	/W2E	KHA6-SH-Ex1/ 115/230 V AC, 1 channel, Fail Safe	Only for limit switches /K6.../K7
	/W2F	2x KHA6-SH-Ex1/ 115/230 V AC, 1 channel, Fail Safe	Only for limit switches /K8.../K10
	/W4A	KFD2-SR2-Ex1.W/ 24 V DC, 1 channel	Only for limit switches /K1, /K2, /K3
	/W4B	KFD2-SR2-Ex2.W/ 24 V DC, 2 channel	Only for limit switches /K1, /K2, /K3
	/W4E	KFD2-SH-Ex1/ 24 V DC, 1 channel, Fail Safe	Only for limit switches /K6.../K7
/W4F	2x KFD2-SH-Ex1/ 24 V DC, 1 channel, Fail Safe	Only for limit switches /K8.../K10	
Instruction manuals	/IEn	Quantity of instruction manuals in English	n = 1...9 selectable*)
	/IDn	Quantity of instruction manuals in German	n = 1...9 selectable*)
	/IFn	Quantity of instruction manuals in French	n = 1...9 selectable*)
Special order	/Z	Special design must be specified separately. If /Z is selected, several Suffix of Model-Suffix Code can be changed to Z.	

*) if no instruction manual is selected, only a DVD with instruction manuals is shipped with the flowmeter

Specify the following when ordering:

- 1) Model, suffix code and option code
- 2) Fluid name; Process temperature; Process density; Process pressure; Process viscosity
- 3) For gases: Condition of the scale (st. or actual)
- 4) Options: Tag No.; Customer specific notes

9.3 Specifications

STANDARD SPECIFICATIONS

MEASURING TUBE

Materials of wetted parts:

- Stainless steel AISI 316L (1.4404)
- PTFE
- Aramide fibres / NBR binder (Gasket for process connection R4 or T4)
- Other materials on request

Fluids to be measured:

suitable for a variety of liquids, gas and steam

Measuring range:

See table 9-11 and 9-12

Measuring range ratio:

10:1

Process connections / Stainless steel:

- Flanges : - acc. EN1092-1
 - DN100 – DN150 PN16
 - DN15 – DN100 PN40
 - DN50 – DN80 PN63
 - DN15 – DN50 PN100
- acc. ASME B 16.5 (AISI 316/316L dual certified)
 - ½" – 6" Class 150 raised face
 - ½" – 6" Class 300 raised face
 - ½" – 3" Class 600 raised face
- Roughness of sealing
 - Form B1 : RA 3.2 - 6.3
 - Form B2 : RA 0.8 - 3.2
 - ASME : RA 3.2 - 6.3
- Threaded connection :
 - male acc. DIN 11851
 - NPT- female
 - G- female
 - Clamp acc. DN25 / 1" – DN100 / 4"

Process pressure :

Depends on process connection, see table 10 to 12 higher pressure (up to 700 bar) on request

Process temperature :

- medium wetted parts made of stainless steel
 - : -196 ... +370 °C
- medium wetted parts made of PTFE
 - : -80 ... +130 °C

See fig. 7a to 7c

Measuring accuracy :

Table 9-1

Material of wetted parts	Size	Measuring accuracy acc. Directive VDI/ VDE 3513 sheet 2 (q _G =50%)
SS	DN 15 - 100	1.6%
SS	DN 125 - 150	2.5%
PTFE	DN 15 - 100	2.5%

Pressure Equipment Directive (PED):

- Tubes :
 - Modul : H
 - Fluid Group : 1 (dangerous fluids)
 - Produced acc. to category : III
 - Classification : Table 6 of PED directive
- Heating (options /T1 to /T6) :
 - Art. 3 section 3 : (Volume < 1L)
 - Fluid Group : 2 (non-dangerous fluids)
 - Classification : Table 2 of PED directive

CANADIAN REGISTRATION NUMBERS (CRN) available upon request

Installation:

- Mounting direction : vertical
- Flow direction : upwards
- Mounting length : see tables 10, 12, 13, 14
- Straight pipe inlet length : DN 80/100 at least 5D, not necessary for smaller sizes

Weight :

See table 9-16

LOCAL INDICATOR

(Indicator/Transmitter Code -T)

Principle :

The indication is made by magnetic coupling of a magnet enclosed in the float and a magnet in the indication unit, which follows the movements of the float, with a pointer.

Indicator housing :

- Materials : - Stainless steel (1.4404/316L) (housing type 90)
- painted aluminium casting acc. EN 13195 AC 44200 material (housing type 91) each with safety-glass window
- Degree of protection :
 - IP66/67
 - NEMA 4, 4X, 6 (not for flame proof housing)

Scales :

- Standard : removable aluminium plate with scale (double scale as option)
- Marking : direct readable units or percentage of Qmax.

Transportation- and Storage condition :

-40°C to +110°C

ELECTRONIC TRANSMITTER

(Indicator/Transmitter Code -E, -H, -J, -G)

Standard type (Code -E) :

Power supply :

- 4- wire units with galvanic isolation :
 - 230 V AC +10 %/-15 %, 50/60 Hz, fuse 0.063 A, time lag, (5x20) mm
 - 115 V AC +10 %/-15 %, 50/60 Hz, fuse 0.125 A, time lag, (5x20) mm
- 2/3- wire units : - U = 14 V ... 30 V DC

Output signal :

- 4- wire units :
 - 0 - 20 mA, 4 – 20 mA
 - pulse output (option /CP) max. frequency 4 Hz see fig. 3-5
- 3- wire units : 0 - 20 mA, 4 - 20 mA
- 2- wire units : 4 - 20 mA

The 20 mA point is selectable between 60 % and 100% of Qnom.

Load resistance :

- 4- wire units : ≤ 500 Ω
- 2/3- wire unit : ≤ (U - 14 V) / 20 mA, max. 500 Ω

HART- communication type (Code -H, -J):

Power supply :

- 2-wire units : U = 14 V ... 30 V DC

Output signal :

- 2- wire units : 4 – 20 mA

Load resistance :

- HART-version : 250 ... 500 Ω

Profibus PA - communication type (Code -G) :

- 2- wire bus connection not polarity sensitive : 9 ... 32 V DC acc. to IEC 61568-2 and FISCO model
- Basic current : 14 mA
- Failure current (FDE) : 10 mA additional to basic current
- Transmission rate : 31.25 kBAud
- AI block for volume flow or mass flow
- Configurable with PDM DD
- Supports I&M- functions

Digital display :

8- digits 7- segment-LC-display character height 6 mm

Process-/ Ambient temperature :

The dependency of the process temperature from the ambient temperature is shown in fig. 7a to fig. 7c.

The internal temperature of the electronic transmitter can be indicated on the display or checked via HART communication.

Measurement of the internal transmitter temperature :

- Range : -25 °C to +70 °C

- Accuracy : ± 5 °C

Transportation- and Storage condition :

-40 °C to +70 °C

Linearity ¹⁾ :

± 0.2 % f.s.

Hysteresis ¹⁾ :

± 0.1 % f.s.

Repeatability ¹⁾ :

± 0.1 % f.s.

Influence of power supply ¹⁾ :

± 0.1 % f.s.

Temperature coefficient of the output signal ¹⁾ :

± 0.5 % /10 K f.s.

AC-part of output signal ¹⁾ :

± 0.15 % f.s.

Long-time stability ¹⁾ :

± 0.2 % /year

Max. output signal :

21.5 mA

Output signal in case of failure :

≤ 3.6 mA (acc. NE 43)

Response time (99%) :

About 1.5 s (damping 1s)

Electromagnetic compatibility (EMC) :

- Acc. EN 61326-1, Class A, Table 2
EN 61326-2-3

Criterion A, restriction: HF- immunity between 500 MHz and 750 MHz : criterion B

RAMC with Profibus PA :

Criterion A: Burst, Surge, HF- Immunity

Criterion B: ESD

In case of single sided grounding of the cable shield it is possible that for all tests criterion B is reached.

Unit safety acc. EN 61010-1:

- Over voltage category : II (acc. to EN 60664-1)

- Pollution degree : I

- Safety class : I (with 115 / 230V AC power supply)

III (with 24V DC power supply and
Fieldbus type)

POWER SUPPLY FOR ELECTRONIC TRANSMITTER

(Option /UT)

Type :

Power supply with galvanically separated input and output
- RN221N-B1, HART- compatible

Supply voltage :

20 ... 250 V DC / AC 50/60 Hz

Maximum load :

700 Ω

Output signal :

4 - 20 mA

CABLE GLAND (for transmitter -E, -H, -J and -G) :**Size :**

- M16x1.5 (standard)

- Thread M20x1.5 (option /A13; standard for option /KF1)

- Thread ½" NPT (option /A5)

Cable diameter :

6 – 9 mm

Maximum cross section of core :

Ø 1.5 mm²

LIMIT SWITCHES IN STANDARD VERSION

(option /K1 to /K3)

Type :

Inductive proximity switch SC3.5-N0 acc. DIN EN 60947-5-6

Nominal voltage :

8 V DC

Output signal :

≤ 1 mA or ≥ 3 mA

LIMIT SWITCHES IN FAIL SAFE VERSION

(option /K6 to /K10)

Type :

Inductive proximity switch SJ3.5-SN; SJ3.5-S1N

acc. DIN EN 60947-5-6 (NAMUR)

Nominal voltage :

8 V DC

Output signal :

≤ 1 mA or ≥ 3 mA

HYSTERESIS OF LIMIT SWITCHES**Min-contact / Max-contact :**

- pointer movement ≈ 0.8 mm

- float movement ≈ 0.8 mm

Minimum distance between 2 contacts :

≈ 2 mm

CABLE GLAND (option /K1 to /K10)**Size :**

- M16x1.5 (standard for type 90)

- Thread M20x1.5 (option /A13; standard for type 91)

- Thread ½" NPT (option /A5)

Cable diameter :

6 – 9 mm

Maximum cross section of core :

Ø 1.5 mm²

POWER SUPPLY FOR LIMIT SWITCHES (Option /W__)**Type :**

acc. DIN EN 60947-5-6 (NAMUR)

- KFA5-SR2-Ex*-W (115 V AC), * = 1 or 2

- KFA6-SR2-Ex*-W (230 V AC), * = 1 or 2

- KFD2-SR2-Ex*-W (24 V DC), * = 1 or 2

- KHA6-SH-Ex1 (115/230 V AC), Fail Safe, 1 channel

- KFD2-SH-Ex1 (24 V DC), Fail Safe, 1 channel

Power supply :

- 230 V AC ± 10 %, 45-65Hz

- 115 V AC ± 10 %, 45-65Hz

- 24 V DC ± 25 %

Relay output :

1 or 2 potential-free changeover contact(s)

Switching capacity :

max. 250 V AC, max. 2 A

Note :

If Fail-Safe limit switch option /K6 or /K7 is ordered, for power supply option /W2E or /W4E must be selected.

If Fail-Safe limit switch option /K8, /K9 or /K10 is ordered, for power supply option /W2F or /W4F must be selected.

¹⁾ referenced to 20°C ambient temperature

SWITCHING LEVELS FOR LIMIT SWITCHES

Table 9-2 Min, Max and Min-Max-contact in standard version

		Option /K1	Option /K2	Option /K3
Function	Pointer	Signal	Signal	Signal
		SC3,5-N0	SC3,5-N0	SC3,5-N0
MAX	above LV	----	1 mA	1 mA
	below LV	----	3 mA	3 mA
		Signal	Signal	Signal
Function	Pointer	SC3,5-N0	SC3,5-N0	SC3,5-N0
MIN	above LV	3 mA	----	3 mA
	below LV	1 mA	----	1 mA

Note: LV = Limit value

Table 9-3 Min, Max and Min-Max-contact in fail-safe version

		Option /K6	Option /K7	Option /K8
Function	Pointer	Signal	Signal	Signal
		SJ3,5-SN	SJ3,5-SN	SJ3,5-SN
MAX	above LV	----	1 mA	1 mA
	below LV	----	3 mA	3 mA
	Fail Safe	----	1 mA	1 mA
		Signal	Signal	Signal
Function	Pointer	SJ3,5-SN	SJ3,5-SN	SJ3,5-SN
MIN	above LV	3 mA	----	3 mA
	below LV	1 mA	----	1 mA
	Fail Safe	1 mA	----	1 mA

Note: LV = Limit value

Table 9-4 Limit switch as Min-Min-contact in fail-safe version

		Option /K9
Function	Pointer	Signal
		SJ3,5-S1N
MIN	above LV	3 mA
	below LV	1 mA
	Fail Safe	1 mA
		Signal
Function	Pointer	SJ3,5-SN
MIN	above LV	3 mA
	below LV	1 mA
	Fail Safe	1 mA

Note: LV = Limit value

Table 9-5 Limit switch as Max-Max-contact in fail-safe version

		Option /K10
Function	Pointer	Signal
		SJ3,5-SN
MAX	above LV	1 mA
	below LV	3 mA
	Fail Safe	1 mA
		Signal
Function	Pointer	SJ3,5-S1N
MAX	above LV	1 mA
	below LV	3 mA
	Fail Safe	1 mA

Note: LV = Limit value

FOLLOWING IEC 61508

RAMC with fail safe limit switches (/K6.../K10)
Suitable for application in safety functions up to and including SIL2.

RAMC with standard limit switches (/K1.../K3)
Suitable for application in safety functions up to and including SIL1.

Details see FMEDA report.

FOLLOWING ISO 13849-1

Safety Metrics available for:
RAMC with fail safe limit switches (/K6.../K10)
RAMC with standard limit switches (/K1.../K3)

Details see FMEDA report.

METROLOGICAL REGULATION IN CIS AND EAC COUNTRIES

Russia, Kazakhstan, Uzbekistan, Belorussia and Turkmenistan are members of CIS.

RAMC has "Pattern Approval Certificate of Measuring Instruments" and is registered as a measuring instrument in Russia, Kazakhstan, Uzbekistan, Belorussia and Turkmenistan.

Option /QR2 is for Kazakhstan.

Option /QR3 is for Uzbekistan.

For the Ukraine the test certificate of Rota Yokogawa is sufficient.

Therefore no special option exists."

Russia, Kazakhstan and Belorussia are covered by EAC.

For export to CIS and EAC countries please contact your Yokogawa representative.

HAZARDOUS AREA SPECIFICATIONS

Overview hazardous area certified instruments:

Location	Europe	Global	USA	Canada	India	Korea	China	Russia, Belorussia, Kazakhstan	Brazil	Taiwan
Certificate	ATEX	IECEx	FM	FM	PESO	KOSHA	NEPSI	EAC	INMETRO	TS
Electronic transmitter (WT-MAG)										
Protection	ia	ic	ia/tb	IS/NI	ia	-	-	ia	ia	-
Option	/KS1	/KS3	/KS2	/FS1	/KS1	-	-	/GS1	/US1	-
Comments	*2	*1	*1	*3	*4	-	-	-	-	-
See page	6	6	9	6	6	-	-	6	6	-
Limit switches										
Protection	ia	ic	ia/tb	IS/NI	ia	-	-	ia	ia	-
Option	/KS1	/KS3	/KS2	/FS1	/CS1	-	-	/GS1	/US1	-
Comments	*2	*1	*1	*5	*6	-	-	-	-	-
See page	7	7	9	7	7	-	-	7	7	-
RAMC indicator										
Protection	d/tb	-	db/tb	-	d	d/tb	d/DIP	d	-	d/tb
Option	/KF1	-	/KF1	-	/KF1	/EF1	/NF1	/GF1	/GC1	/EF1
Comments	*7	-	*7	-	*4	-	*7	*7	*8	*7
See page	8	-	9	-	8	8	8	8	9	8
Power supplies for intrinsic safe components (see page 7)										
Option /UT	yes	yes	yes	yes	no	no	yes	yes	no	-
Option /W1A,B	yes	yes	yes	yes	yes	yes	no	yes	no	-
Option /W2A,B	yes	yes	yes	yes	yes	yes	no	yes	no	-
Option /W4A,B	yes	yes	yes	yes	yes	yes	yes	yes	no	-
Option /W2E,F	yes	yes	yes	no	no	no	no	yes	no	-
Option /W4E,F	yes	yes	yes	no	no	no	yes	yes	no	-
Notation	IS = intrinsic safe; NI = non incandive; DIP = dust ignition proof									
Comment *1)	Dust proof by RAMC housing									
Comment *2)	For use in category 3G									
Comment *3)	Same certification for USA and Canada									
Comment *4)	PESO certificate available from Yokogawa Sales Office									
Comment *5)	Only for USA; power supply free selectable									
Comment *6)	For USA and Canada; power supply must be option /WxA or /WxB (x=1 or 2 or 4)									
Comment *7)	Only with housing 91									
Comment *8)	Only indicator type T without limit switches									

ELECTRONIC TRANSMITTER

Attention :

The maximum ambient temperature of the transmitter or of the limit switches according to the temperature class may not be exceeded because of heat transmission from the medium.

Table 9-6 Entity parameters of electronic transmitter

	U _i [V]	I _i [mA]	P _i [W]	C _i [nF]	L _i [mH]	T _{amax} [°C]
KS1/2/3	30	101	1.4	4.16	0.15	70
ES1/2/3	30	101	1.4	4.16	0.15	70
FS1/CS1	30	100	1.4	40	0.15	70
NS1	30	101	1.4	4.16	0.15	70
GS1	30	101	1.4	4.16	0.15	70
US1	30	101	1.4	4.16	0.15	70

Intrinsically safe electronic transmitter 4 - 20mA (with/without HART-communication) with ATEX-certification (option /KS1) :

Certificate :

PTB 12ATEX 2003X

Output signal :

4-20 mA (2- wire unit, 3- wire unit) ; 0-20mA (3- wire unit)

Explosion proof :

Ex ia IIC T6 Gb; group II ; category 2G

Entity parameter :

see table 9-6

Intrinsically safe electronic transmitter Profibus PA - communication with ATEX- certification (option /KS1) :

Certificate:

PTB 96ATEX 2160X

Output signal :

Profibus PA

Explosion proof :

Ex ia IIB/IIC T4; group II; category 2G

Table 9-7 Entity parameters

	IIC	IIB	FISCO IIB/IIC
U _i	24 V	17.5 V	acc. IEC 60079-27
I _i	250 mA	280 mA	
L _i	negligible small	negligible small	
C _i	negligible small	negligible small	

Intrinsically safe electronic transmitter 4 - 20mA (with/without HART-communication) with IECEx-certification (option /ES1) :

Certificate :

IECEx PTB 12.0020

Output signal :

4-20 mA (2- wire unit, 3- wire unit) ; 0-20mA (3- wire unit)

Explosion proof :

Ex ia IIC T6 Gb; group II ; category 2G

Entity parameter :

see table 9-6

Intrinsically safe electronic transmitter 4 - 20mA (with/without HART-communication) with ATEX- or IECEx- certification for use in category 3G (option /KS3 or /ES3) :

Output signal :

4-20 mA (2- wire unit, 3- wire unit) ; 0-20mA (3- wire unit)

Explosion proof :

Ex ic IIC T6 Gc; group II ; category 3G

Entity parameter :

see table 9-6

Intrinsically safe / non incensive electronic transmitter with FM - certification (USA + Canada) (USA: option /FS1; Canada: option /CS1) :

Certificate :

No. : 3027471

Output signal :

4-20 mA (2-wire unit)

Explosion proof :

Intrinsic safe Cl. I, Div. 1, GP. A, B, C, D T6

Intrinsic safe Cl. 1, Zone 0, AEx ia IIC T6

Non incensive Cl. I, Div. 2, GP. A, B, C, D T6

Entity parameter of electronic transmitter :

see table 9-6

Intrinsically safe electronic transmitter with PESO- certification (India)

Option /KS1 must be selected.

Same data as ATEX-certified type (/KS1).

PESO- certificate is available at your Yokogawa Sales Office.

Intrinsically safe electronic transmitter with EAC- certification (Russia, Belarus, Kazakhstan) (option /GS1) :

Certificate :

RU C-DE.ГБ08.B.01183

Output signal :

4-20 mA (2- wire unit, 3- wire unit) ; 0-20mA (3- wire unit)

Explosion proof :

0Ex ia IIC T6 X

Entity parameter :

see table 9-6

Intrinsically safe electronic transmitter 4 - 20mA (with/without HART-communication) with INMETRO-certification (Brazil) (option /US1) :

Certificate :

DEKRA 15.0006 X

Output signal :

4-20 mA (2- wire unit, 3- wire unit) ; 0-20mA (3- wire unit)

Explosion proof :

Ex ia IIC T6 Gb; group II ; category 2G

Entity parameter :

see table 9-6

LIMIT SWITCHES**Intrinsically safe limit switches with ATEX-certification (option /K1 ... /K10 with /KS1) :****Certificate:**

PTB 99 ATEX 2219X (SC3.5-NO) (/K1 ... /K3)
PTB 00 ATEX 2049X (SJ 3.5-S.N) (/K6 ... /K10)

Explosion proof :

Ex ia IIC T6, group II category 2G

Entity parameter :

see certificate of conformity

Intrinsically safe limit switches with ATEX-certification for use in category 3G (option /K1 ... /K10 with /KS3) :**Explosion proof :**

Ex ic IIC T6 X, group II category 3G

Entity parameter :

see specification of SC3,5-NO Blue (P&F)* (/K1 ... /K3)
see specification of SJ3,5-SN (P&F)* (/K6 ... /K10)
* P&F = Pepperl & Fuchs

Intrinsically safe limit switches with IECEx-certification (option /K1 ... /K10 with /ES1) :**Certificate:**

IECEx PTB11.0091 (SC3.5-NO) (/K1 ... /K3)
IECEx PTB11.0092 (SJ 3.5-S.N) (/K6 ... /K10)

Explosion proof :

Ex ia IIC T6 Gb

Entity parameter :

see certificate of conformity

Intrinsically safe / non incendive limit switches with FM- certification (USA) (option /K1 ... /K10 with /FS1) :**Explosion proof :**

IS : Cl. I, Div. 1, Gp. ABCD, T6, Ta = 60°C,
NI : Cl. I, Div. 2, Gp. ABCD, T5, Ta = 50°C
Cl. II, Div. 1, Gp. EFG
Cl. III, Div. 1

Entity parameter :

see FM-control drawing 116-0165 for IS
see FM-control drawing 116-0155 for NI

Intrinsically safe limit switches with CSA- certification (Canada) (option /K1 ... /K3 with /CS1) :**Explosion proof :**

Cl. I, II, III, Div. 1, Gp. ABCDEFG

Entity parameter :

see drawing 116-0047

Only in combination with option /WxA or /WxB.

Intrinsically safe limit switches with EAC-certification (Russia, Belorussia, Kazakhstan) (option /K1 .. /K10 with /GS1):**Certificate :**

RU C-DE.ГБ08.B.01183

Explosion proof :

0Ex ia IIC T16...T1 X

Entity parameter :

see certificate

Intrinsically safe limit switches with INMETRO-certification (option /K1 ... /K10 with /US1) :**Certificate:**

TÜV 13.1131 X

Explosion proof :

Ex ia IIC T6/T1 Ga

Entity parameter :

see certificate of conformity

RAMC**Intrinsically safe RAMC with NEPSI- certification (China) (option /NS1) :****Certificate :**

GYJ15.1064

Electronic transmitter :

Output signal: 4–20 mA (2- wire unit, 3- wire unit) ;
0-20mA (3- wire unit)

Explosion proof: Ex ia IIC T6

Max. Tamb.: 70 °C

Entity parameter: see table 9-6

Limit switches :

Option /K1 to /K3 acc. certificate GYJ11.1505X

Option /K6 to /K10 acc. certificate GYJ11.1507X

Flame proof and dust proof RAMC with ATEX-certification (option /KF1):**Certificate :**

IBExU 05 ATEX 1086

Flame proof :

Ex d IIC T1 ... T6 Gb ; group II ; category 2G

Dust proof :

Ex tb IIIC TX Db IP6X; group III ; category 2D

Max. surface temperature TX :corresp. process temperature

Housing :

Painted aluminium casting, type 91

Output signal (with electronic transmitter -E, -H, -J):

4–20 mA (2- wire unit, 3- wire unit) ; 0-20 mA (3- wire unit)

Power supply (with electronic transmitter -E, -H, -J):

2- or 3- wire unit

Limit switches :

Options /K1 to /K10 possible

Ambient temperature :

-20 °C to 60 °C

Minimum process temperature :

-20 °C

Threads for cable glands :

- M20x1.5 (standard)

- ½" NPT (option /A5)

Temperature classification :

see table 9-8

Flame proof and dust proof RAMC with IECEx-certification (option /EF1):**Certificate :**

IECEx IBE12.0007

Flame proof :

Ex db IIC T1 ... T6 Gb

Dust proof :

Ex tb IIIC TX Db IP6X

Max. surface temperature TX :corresp. process temperature

Housing :

Painted aluminium casting, type 91

Output signal (with electronic transmitter -E, -H, -J):

4–20 mA (2- wire unit, 3- wire unit) ; 0-20 mA (3- wire unit)

Power supply (with electronic transmitter -E, -H, -J):

2- or 3- wire unit

Limit switches :

Options /K1 to /K10 possible

Ambient temperature :

-20 °C to 60 °C

Minimum process temperature :

-20 °C

Threads for cable glands :

- M20x1.5 (standard)

- ½" NPT (option /A5)

Temperature classification :

see table 9-8

Flame proof and dust proof RAMC with PESO-certificate (India) :

Option /KF1 must be selected. PESO- certificate is available at your Yokogawa Sales Office.

Flame proof and dust proof RAMC with KOSHA-certificate (Korea) (option /EF1):**Certificate :**

12-AV4BO-0721X

Option /EF1 must be selected.

Same data as IECEx-certified type (/EF1)

Flame proof RAMC with EAC- certificate (Russia, Belorussia, Kazakhstan) (option /GF1):**Certificate :**

RU C-DE.ГБ08.B.01183

Flame proof :

1Ex d IIC T1 ... T6

Housing :

Painted aluminium casting, type 91

Output signal (with electronic transmitter -E, -H, -J):

4-20 mA (2- wire unit, 3- wire unit) ; 0-20 mA (3- wire unit)

Power supply (with electronic transmitter -E, -H, -J):

2- or 3- wire unit

Limit switches :

Options /K1 to /K10 possible

Ambient temperature :

-40 °C to 60 °C

Minimum process temperature :

-20 °C

Threads for cable glands :

- M20x1.5 (standard)
- 1/2" NPT (option /A5)

Temperature classification :

see table 9-8

Flame proof and dust proof RAMC with NEPSI-certificate (China) (option /NF1):**Certificate :**

GYJ13.1018X

Flame proof :

Ex d IIC T1~T6 Gb

Dust proof :

DIP A20 T_A, T1~T6 IP67

Max. surface temperature T_A: corresponding process temperature

Housing :

Painted aluminium casting type 91

Output signal (with electronic transmitter -E, -H, -J):

4-20 mA (2- wire unit, 3- wire unit) ; 0-20 mA (3- wire unit)

Power supply (with electronic transmitter -E, -H, -J):

2- or 3- wire unit

Limit switches :

Options /K1 to /K10 possible

Ambient temperature :

-20 °C to 60 °C

-20 °C to 55 °C (for use in zone 20)

Minimum process temperature :

-20 °C

Threads for cable glands :

- M20x1.5 (standard)
- 1/2" NPT (option /A5)

Temperature classification :

see table 9-8

Flame proof and dust proof RAMC with Taiwan Safety Label:**Registration Document:**

ML041200702782

Option /EF1 must be selected.

Same data as IECEx-certified type (/EF1)

For export to Taiwan please contact your Yokogawa representative regarding Taiwan Safety Label

Table 9-8

Temp. class	Max. Process temperature		
	No extension	On Extension	On extension with insulation
T6	85 °C	85 C	85 °C
T5	100 °C	100 °C	100 °C
T4	120 °C	135 °C	135 °C
T3	120 °C	200 °C	200 °C
T2	120 °C	300 °C	300 °C
T1	120 °C	370 °C	350 °C

NON-ELECTRICAL RAMC**ATEX registered RAMC (option /KC1):****Registration no. :**

IBExU 099/15

Explosion proof :

II 2GD IIC TX

Max. surface temperature :

TX : corresponding process temperature

Ambient temperature :

-40 °C to 90 °C

Max. process temperature :

standard: 220 °C

indicator on distance: 370 °C

RAMC with EAC- certification (option /GC1):**Certificate no. :**

RU C-DE.ГБ08.B.01183

Explosion proof :

II Gb IIC T* X

III Db IIIC T*°C X

Max. surface temperature :

TX : corresponding process temperature

Ambient temperature :

-40 °C to 90 °C

Max. process temperature :

standard: 220°C

indicator on distance: 370°C

INTRINSIC SAFE COMPONENTS WITH DUSTPROOF**ATEX- certified intrinsically safe electronic transmitter 4 - 20mA, with/without limit switches with dust proof RAMC (option /KS2):****Certificate :**

PTB 12 ATEX2003 (Intrinsic safe electronic transmitter)
 PTB 99 ATEX2219X (Intrinsic safe limit switch SC3.5-N0)
 PTB 00 ATEX2049X (Intrinsic safe limit switch SJ 3.5-S.N)
 IBEu 05 ATEX1086 (Dust proof)

Output signal electronic transmitter:

4-20 mA (2-wire unit, 3-wire unit) ; 0-20mA (3-wire unit)

Explosion proof :

Ex ia IIC T6 Gb; group II ; category 2G

Dust proof :

Ex tb IIIC TX Db IP6X; group III ; category 2D
 Max. surface temperature TX : corresponding process temperature

Entity parameter :

see table 6 for electronic transmitter (/KS1)
 see certificates for limit switches

Housing :

Painted aluminium casting, type 91

Ambient temperature :

-20 °C to 60 °C

Minimum process temperature :

-20 °C

Threads for cable glands :

- M20x1.5 (standard)
 - ½" NPT (option /A5)

IECEX- certified intrinsically safe electronic transmitter 4 - 20mA, with/without limit switches with dust proof RAMC (option /ES2):**Certificate :**

IECEX PTB12.0020 (Intrinsic safe electronic transmitter)
 IECEX PTB11.0091 (Intrinsic safe limit switch SC3.5-N0)
 IECEX PTB11.0092 (Intrinsic safe limit switch SJ 3.5-S.N)
 IECEX IBE12.0007 (Dust proof)

Output signal electronic transmitter:

4-20 mA (2-wire unit, 3-wire unit) ; 0-20mA (3-wire unit)

Explosion proof :

Ex ia IIC T6 Gb; group II ; category 2G

Dust proof :

Ex tb IIIC TX Db IP6X; group II ; category 2D
 Max. surface temperature TX : corresponding process temperature

Entity parameter :

see table 6 for electronic transmitter (/KS1)
 see certificates for limit switches

Housing :

Painted aluminium casting, type 91

Ambient temperature :

-20 °C to 60 °C

Minimum process temperature :

-20 °C

Threads for cable glands :

- M20x1.5 (standard)
 - ½" NPT (option /A5)

POWER SUPPLIES FOR INTRINSIC SAFE COMPONENTS**Power Supply for the intrinsically safe electronic transmitter (option /UT)****Type :**

Power supply with galvanically separated input and output
 - RN221N-B1, HART- compatible

Certificate :

ATEX: PTB 00 ATEX 2018
 IECEX: PTB06.0089
 FM: 3007835, Control Drawing 02 02 00 111
 CSA: 1067708, Control Drawing 02 02 00 112
 EAC: RU C-DE.ГБ05.B.00213

Supply voltage :

20 ... 250 V DC / AC 50/60 Hz

Maximum load impedance :

700 Ω

Output signal :

4 - 20 mA

Control circuit :

Intrinsically safe [Ex ia] IIC; group II ; category (1)GD

Entity parameters :

see fig. 9-4

Power supply for intrinsically safe limit switches (option W__):**Type :**

acc. DIN EN 50227 (NAMUR)
 - KFA5-SR2-Ex*-W (115 V AC)
 - KFA6-SR2-Ex*-W (230 V AC)
 - KFD2-SR2-Ex*-W (24 V DC)
 - KHA6-SH-Ex1 (115/230 V AC), Fail Safe, 1 channel
 - KFD2-SH-Ex1 (24 V DC), Fail Safe, 1 channel

Certificates :

KFA5-SR2-Ex*-W:	ATEX	: PTB 00 ATEX 2081
	CSA	: 1029981 (LR 36087-19)
	FM	: ID 3011578
	IECEX	: PTB11.0031
	PESO	: P333188/1
	KOSHA	: 2009-BO-0157
	NEPSI	: GYJ12.1079
	EAC	: RU C-П.ГБ05.B.00718
KFA6-SR2-Ex*-W:	ATEX	: PTB 00 ATEX 2081
	CSA	: 1029981 (LR 36087-19)
	FM	: ID 3011578
	IECEX	: PTB11.0031
	PESO	: P333188/1
	KOSHA	: 2009-BO-0157
	NEPSI	: GYJ12.1079
	EAC	: RU C-П.ГБ05.B.00718
KHA6-SH-Ex1:	ATEX	: PTB 00 ATEX 2043
	EAC	: RU C-П.ГБ05.B.00718
KFD2-SR2-Ex*-W:	ATEX	: PTB 00 ATEX 2080
	CSA	: 1029981 (LR 36087-19)
	FM	: ID 3011578
	IECEX	: PTB11.0034
	PESO	: P333188/2
	KOSHA	: 2009-BO-0157
	NEPSI	: GYJ12.1081
	EAC	: RU C-П.ГБ05.B.00718
KFD2-SH-Ex1:	ATEX	: PTB 00 ATEX 2042
	EAC	: RU C-П.ГБ05.B.00718

Control circuit (ATEX) :

[Ex ia] IIC; group II ; category (1)GD

Entity parameter :

see fig. 4 (ATEX) and certificate

FLOW TABLES FOR METAL TUBES

Table 9-11

Pos.	Measuring range for water and liquids										Measuring range for air and gases									
	Recommended combination					Alternative combination					Recommended combination					Alternative combination				
	Max. flow		Cone-Float-combin.	Pressure loss ^{a)}	Viscosity ^{b)}	Cone-Float-combin.	Pressure loss ^{a)}	Viscosity ^{b)}	Max. flow		Cone-Float-combin.	Pressure loss ^{a)}	Cone-Float-combin.	Pressure loss ^{a)}	Max. flow		Cone-Float-combin.	Pressure loss ^{a)}		
m ³ /h ^{c)}	gpm ^{d)}	Code	mbar	mPa's	Code	mbar	mPa's	m ³ /h ^{e)}	m ³ /h i.N. ^{f)}	Code	mbar	Code	mbar	m ³ /h ^{e)}	m ³ /h i.N. ^{f)}	Code	mbar			
1	0.025	0.11	43 S0	40	10	-	-	0.75	0	43 S0	45	-	-	0.44	0	43 S0	45			
	0.04	0.18	44 S0	40	80	-	-	1.2	1.1	44 S0	45	-	-	0.7	1.1	44 S0	45			
2	0.063	0.28	47 S0	40	80	-	-	1.8	1.7	47 S0	45	-	-	1.05	1.7	47 S0	45			
	0.1	0.44	51 S0	40	80	-	-	3	2.8	51 S0	45	-	-	1.75	2.8	51 S0	45			
3	0.13	0.57	53 L1	12	50	-	-	4	3.6	53 L1	13	-	-	2.3	3.6	53 L1	13			
	0.16	0.7	-	-	-	53 M1	15	100	5.5	5	-	-	-	3.2	5	53 M1	21			
4	0.22	1.0	54 L1	12	50	-	-	-	-	-	-	-	-	-	-	-	-			
	0.25	1.1	53 S1	40	100	54 M1	15	50	6.5	6	54 L1	13	-	3.8	6	54 L1	13			
5	0.32	1.4	-	-	-	57 L1	12	50	9	8.5	5	-	-	5	8.5	54 M1	21			
	0.4	1.8	54 S1	40	50	57 M1	15	50	10	9	57 L1	13	-	5.7	9	57 L1	13			
6	0.5	2.2	-	-	-	61 L1	12	50	14	13	8	-	-	8	13	57 M1	21			
	0.63	2.8	57 S1	40	50	61 M1	15	100	16	15	9	61 L1	13	-	9	61 L1	13			
7	0.8	3.5	-	-	-	62 L1	12	50	22	20	12	-	-	12	20	61 M1	21			
	1.0	4.4	61 S1	40	100	62 M1	15	100	25	23	14	62 L1	13	-	14	62 L1	13			
8	1.6	7.0	62 S1	40	100	-	-	34	32	20	-	-	-	20	32	62 M1	21			
	2.2	10.1	-	-	-	62 V1	45	50	50	45	28	-	-	28	45	62 S1	45			
9	1.3	5.7	63 L2	17	50	-	-	40	36	23	63 L2	19	-	23	36	-	-			
	2.1	9.2	-	-	-	64 L2	17	50	50	47	29	-	-	29	47	63 M2	23			
10	2.5	11.0	63 S2	42	30	64 M2	17	10	60	55	35	64 L2	19	-	35	64 L2	19			
	4	17.6	64 S2	42	10	-	-	85	80	50	-	-	-	50	80	64 M2	23			
11	6	26.4	-	-	-	64 V2	43	50	120	110	70	-	-	70	110	64 S2	47			
	3.2	14	67 L5	13	50	-	-	100	90	57	67 L5	16	-	57	90	-	-			
12	5.0	22	-	-	-	71 L5	13	50	130	120	75	-	-	75	120	67 M5	25			
	6.3	28	67 S5	47	30	-	-	160	150	90	71 L5	16	-	90	150	-	-			
13	8.5	37	-	-	-	72 L5	13	50	200	180	115	-	-	115	180	71 M5	25			
	10	44	71 S5	47	5	72 M5	19	5	250	230	140	72 L5	16	140	230	-	-			
14	16	70	72 S5	47	5	-	-	340	320	200	-	-	-	200	320	72 m5	25			
	25	110	-	-	-	72 V5	63	5	500	470	290	-	-	290	470	72 S5	54			
15	25	110	73 V8	60	10	-	-	550	500	320	73 L8	30	-	320	500	-	-			
	40	176	74 V8	60	10	-	-	850	800	500	74 L8	30	-	500	800	-	-			
16	63	277	77 V8	60	10	-	-	1400	1300	800	77 L8	30	-	800	1300	-	-			
	100	440	81 L1	70	10	-	-	-	-	-	-	-	-	-	-	-	-			
17	130	572	82 L1	70	10	-	-	-	-	-	-	-	-	-	-	-	-			

- a) Pressure loss at the float with water or air.
- b) For higher viscosity the specified precision is no more guaranteed.
- c) Flow is referred to 20 °C and 1 bar abs .
- d) Flow in US Gallons per minute at 70 °F .
- e) Flow referred to 0 °C and 1.013 bar abs at operation conditions of 20 °C and 1,013 bar abs.
- f) Flow in Standard cubic feet per minute referred to 60 °F and 14,7 PSI at operation conditions of 70 °F und 14,7 PSI abs.

For your special application please use the Rota Yokogawa Sizing-Program.

PROCESS CONNECTION- AND FLOW-TABLE FOR TUBES WITH PTFE LINING

Table 9-12

Pos.	Process connection				Measuring range for water and liquids				Measuring range for air and gases				
	EN-Flange		ASME-Flange		Max. Flow m ³ /h ^{e)}	Cone- Float- combination	Pressure loss ^{a)} mbar	Visco- sity ^{b)} mPa*s	Max. Flow m ³ /h ^{c)}	Cone- Float- combination	Pressure loss ^{a)} mbar	Max. Flow	
	PN 16 Code	PN 40 Code	L ⁽¹⁾ mm	150 lbs Code								300 lbs Code	L ⁽¹⁾ mm
	D2	D4	mm	A1	A2	0.1	51 A1	16	50	3.5	51 A1	2	20
2	-	DN15 DN25	250	3/4" 1"	3/4" 1"	0.16	52 A1	16	50	5	52 A1	2.9	20
	-	DN25 DN40 DN50	250	1 1/4" 1 1/2"	1 1/4" 1 1/2"	0.25	53 A1	16	50	8.5	53 A1	5	20
	-	DN50 DN65 DN80	250	2 1/2" 3"	2 1/2" 3"	0.4	54 A1	16	50	13	54 A1	7.5	20
	-	DN80 DN100	250	3 1/2" 4"	3 1/2" 4"	0.63	57 A1	16	50	20	57 A1	11	20
3	-	DN25 DN40 DN50	250	1 1/4" 1 1/2"	1 1/4" 1 1/2"	1	61 V1	18	50	34	61 V1	20	22
	-	DN50 DN65 DN80	250	2 1/2" 3"	2 1/2" 3"	1.6	62 A2	20	30	50	62 A2	29	25
4	-	DN80 DN100	250	3 1/2" 4"	3 1/2" 4"	2.5	63 A2	20	10	85	63 A2	50	25
	-	DN100	250	4"	4"	4	63 V2	22	50	-	-	-	-
5	-	DN100	250	4"	4"	4	64 A5	20	30	130	64 A5	75	25
	-	DN100	250	4"	4"	6.3	67 A5	20	30	200	67 A5	115	25
6	-	DN100	250	4"	4"	10	71 A5	20	5	350	71 A5	200	25
	-	DN100	250	4"	4"	16	71 V5	22	10	-	-	-	-
						16	72 V8	25	10	500	72 V8	290	27
						25	73 V8	25	10	850	73 V8	500	27
						40	74 V8	25	10	-	-	-	-
						63	77 10	30	10	-	-	-	-

(1) L = Mounting length

- a) Pressure loss at the float with water or air.
- b) As from this viscosity the specified precision is no more guaranteed.
- c) Flow is referred to 20 °C and 1 bar abs.
- d) Flow in US Gallons per minute at 70 °F.
- e) Flow referred to 0 °C and 1.013 bar abs at operation conditions of 20 °C and 1,013 bar abs.
- f) Flow in Standard cubic feet per minute referred to 60 °F and 14,7 PSI at operation conditions of 70 °F und 14,7 PSI abs.

For your special application please use the Rota Yokogawa Sizing-Program.

INSTALLATION

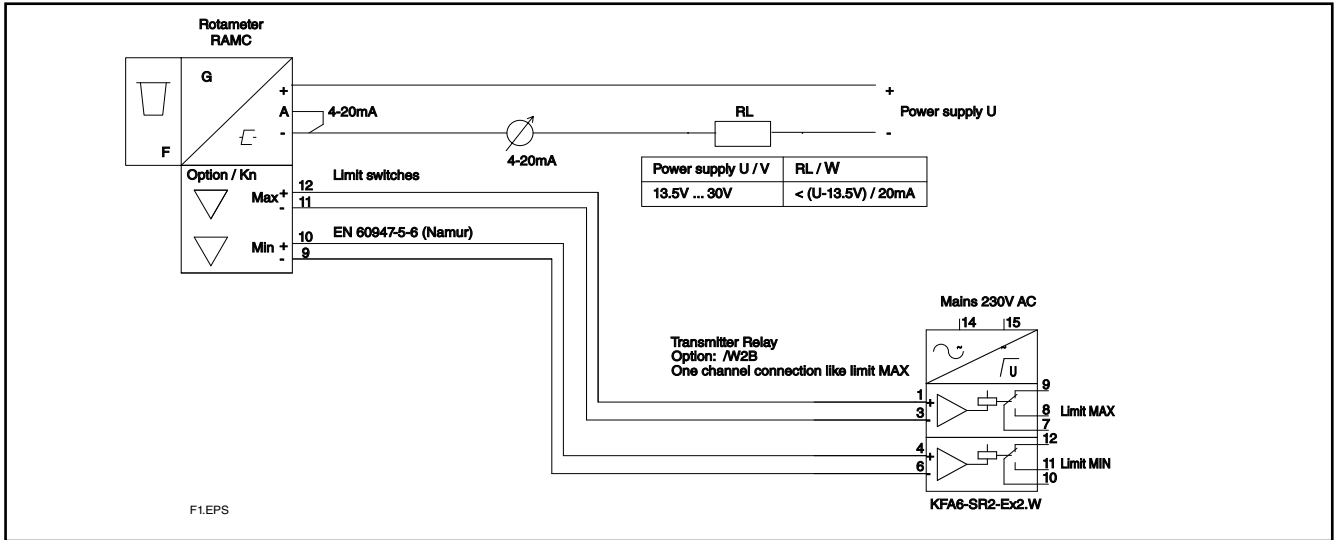

fig. 9-1 RAMC 2- wire unit with inductive limit switches and transmitter relay

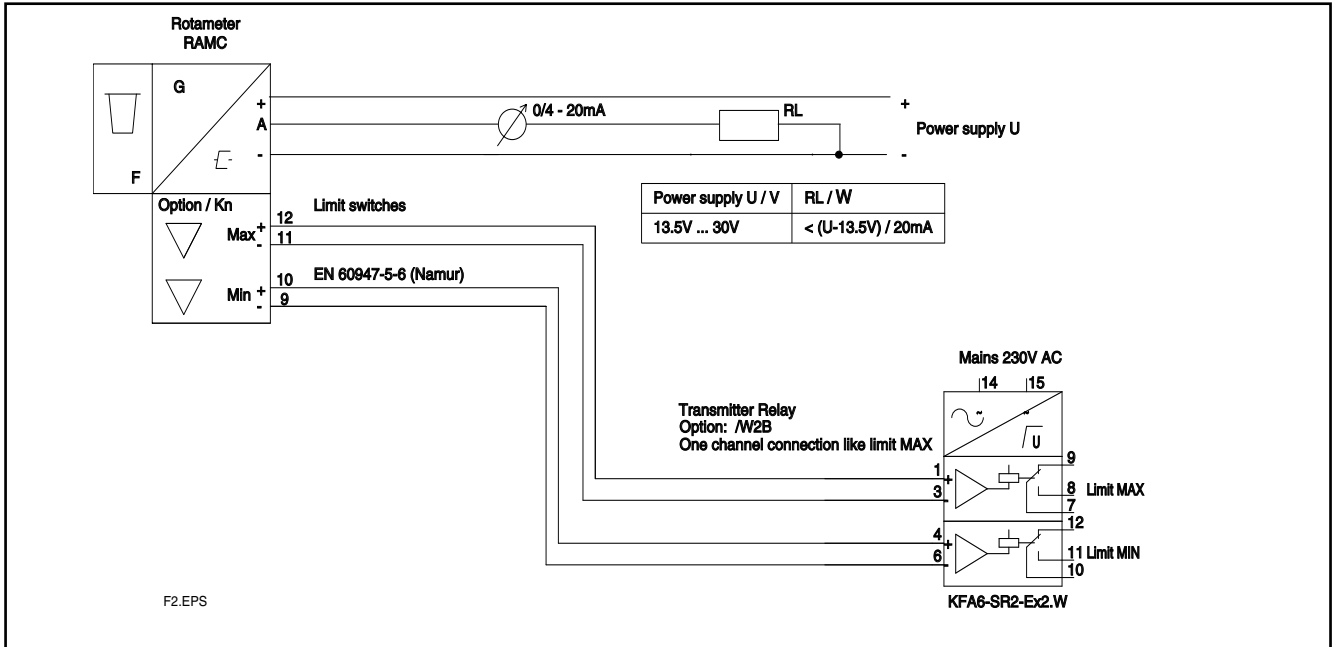

fig. 9-2 RAMC 3- wire unit with inductive limit switches and transmitter relay

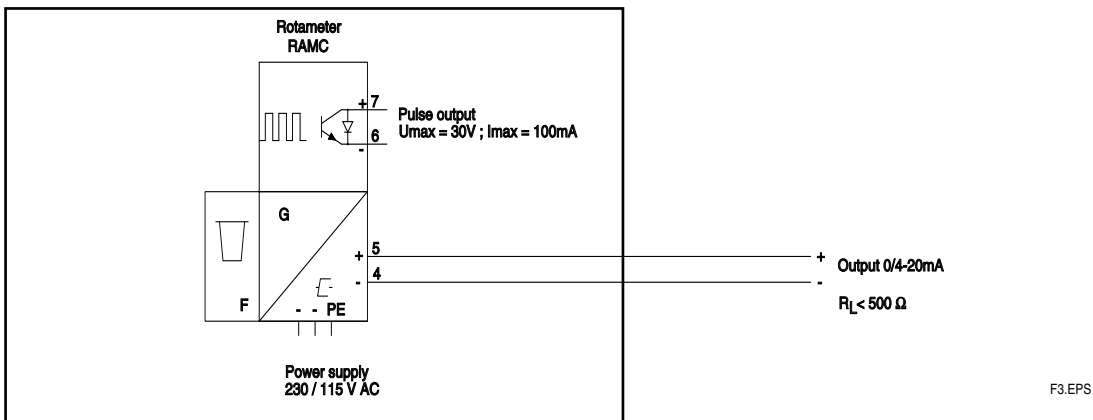

fig. 9-3 RAMC 4-wire unit with pulse output

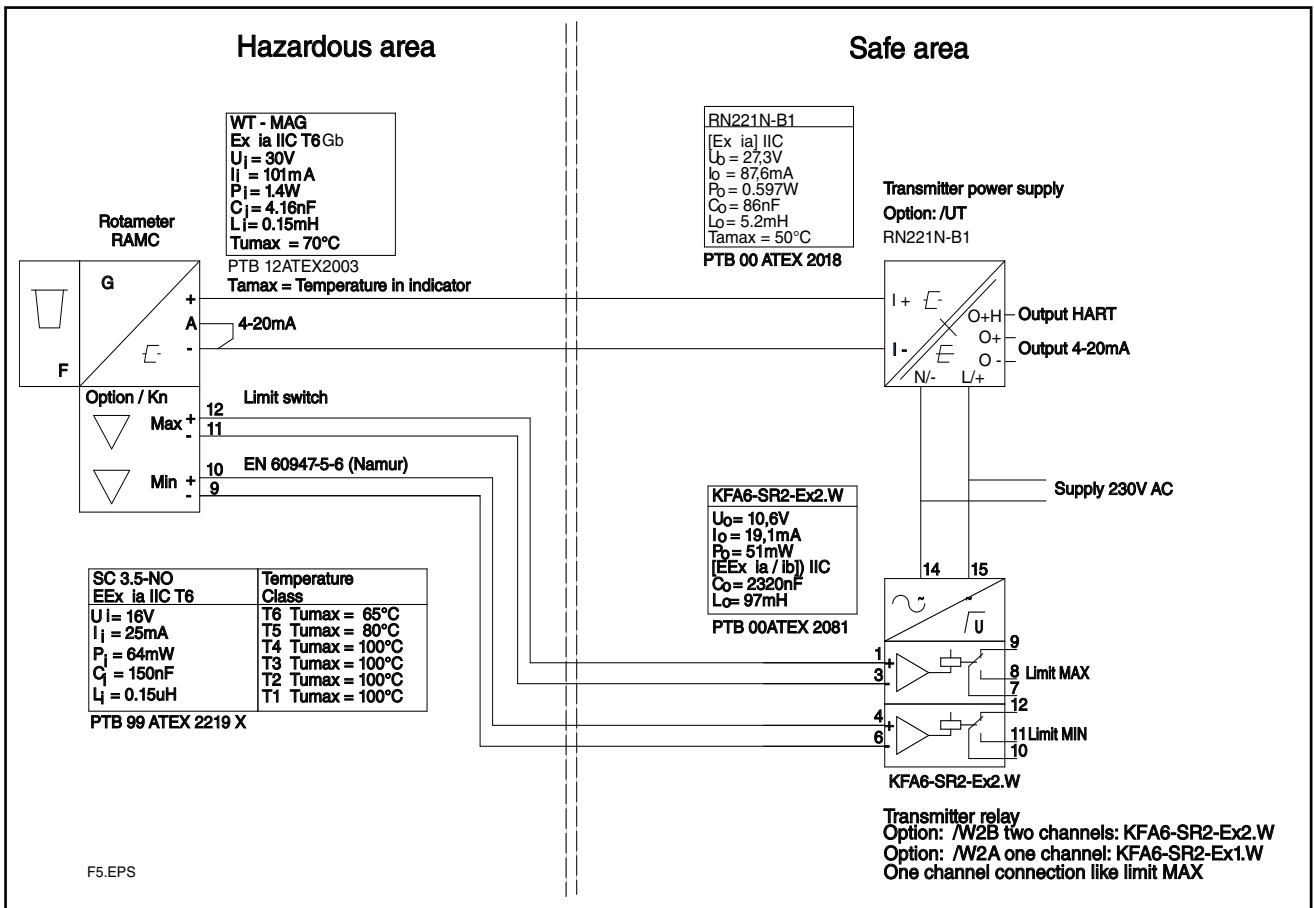

fig. 9-4 Intrinsic safe version according ATEX (option /KS1 or /KS2) : RAMC 2- wire unit with power supply, inductive limit switches and transmitter relay

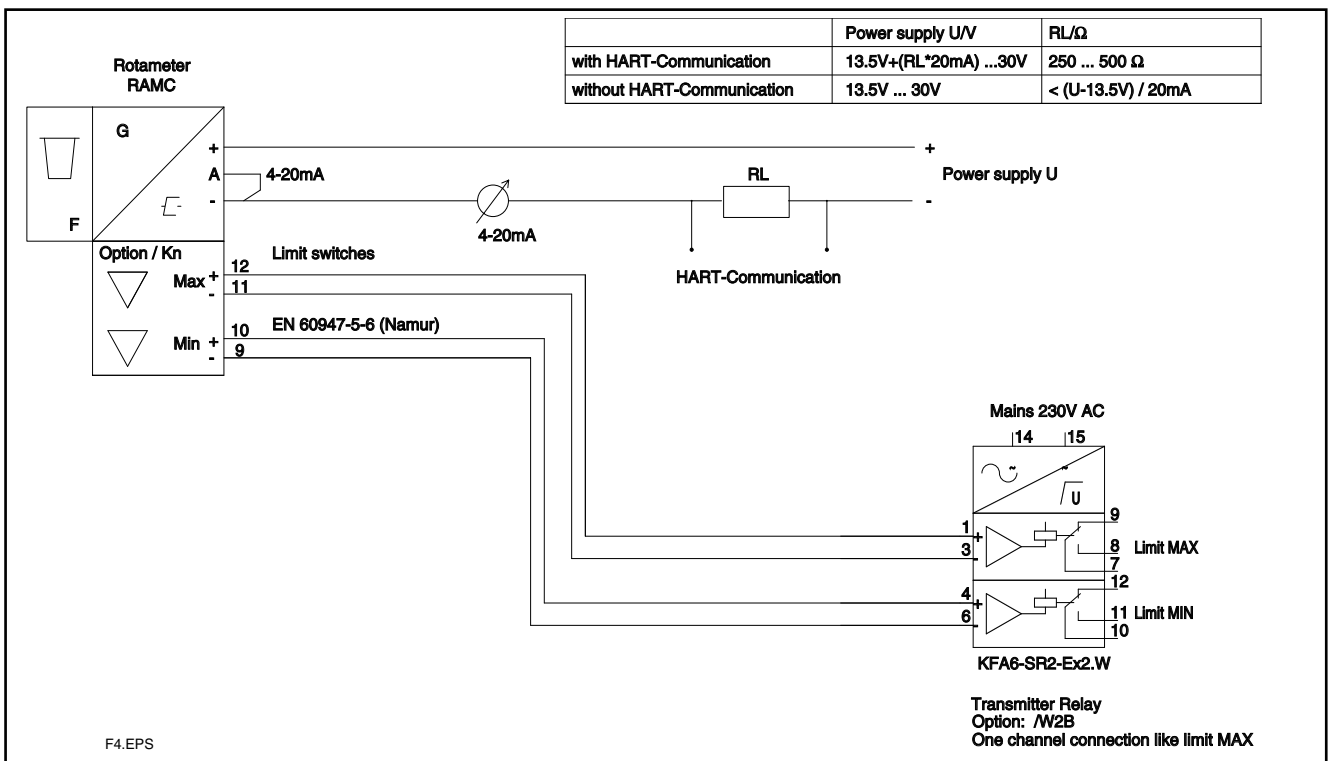

fig. 9-5 RAMC 2- wire unit with HART-communication, inductive limit switches and transmitter relay

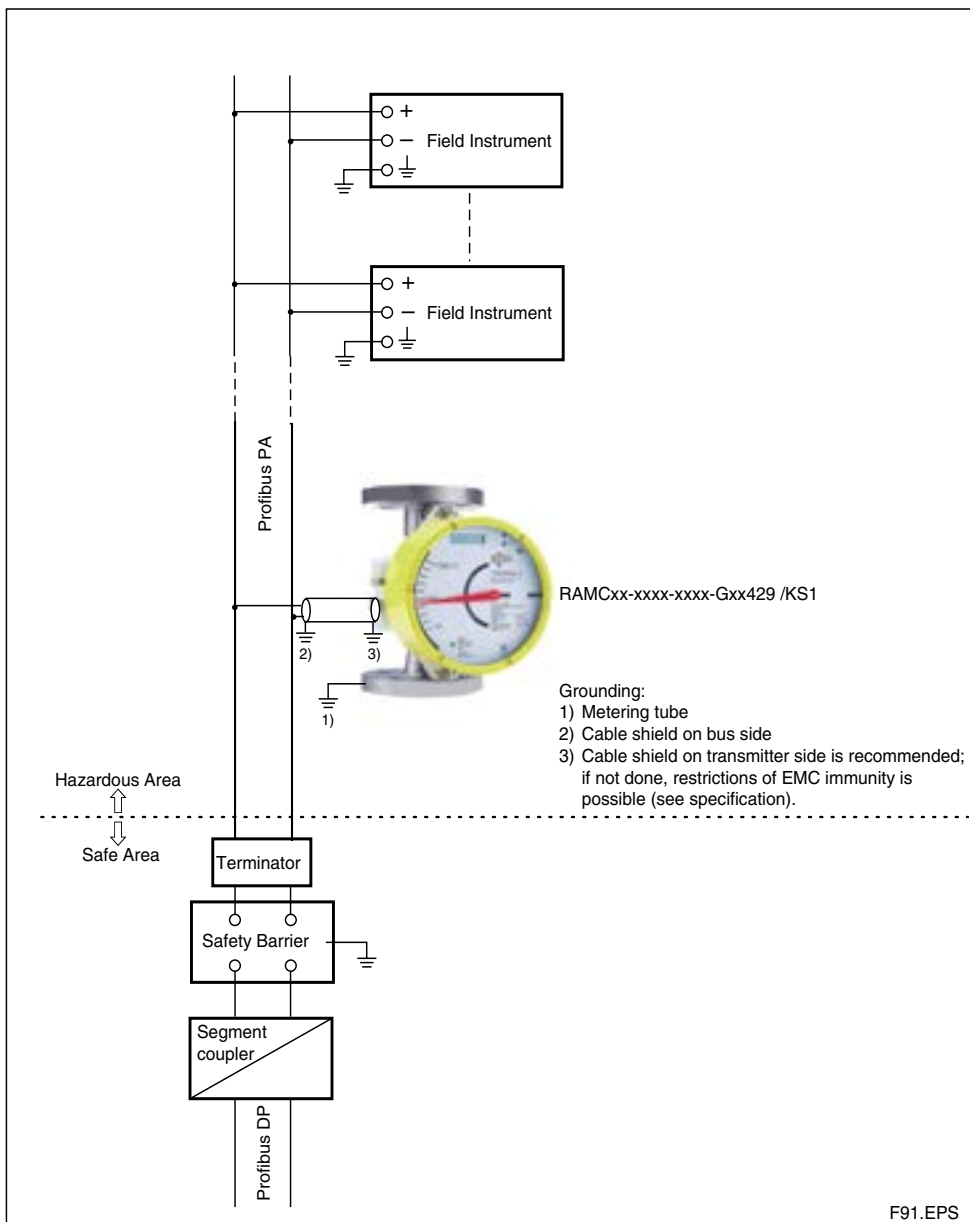

fig. 9-6 RAMC Profibus PA - communication

Planning and Installation Hints

- The user is responsible for the use of our flow meters regarding suitability and use as agreed.
- The actual operation pressure must be lower as the specified pressure limits of the Rotameter.
- Make sure that the wetted parts are resistant against the process medium.
- Ambient- and process temperature must be lower than the specified maximum values.
- If dirt accumulation is to be expected, we recommend to install a bypass pipe
- To avoid float bouncing in case of gas application notice the recommendations of VDI/VDE 3513 Sheet 3.
- To avoid mutual magnetic influence in case of parallel design of several Rotameters take care that the distance between the tube middle axes is not less than 300 mm. The distance to other ferric materials should not be less than 250 mm.
- Avoid static magnetic fields next to the Rotameter.

9.4 Dimensions and weights

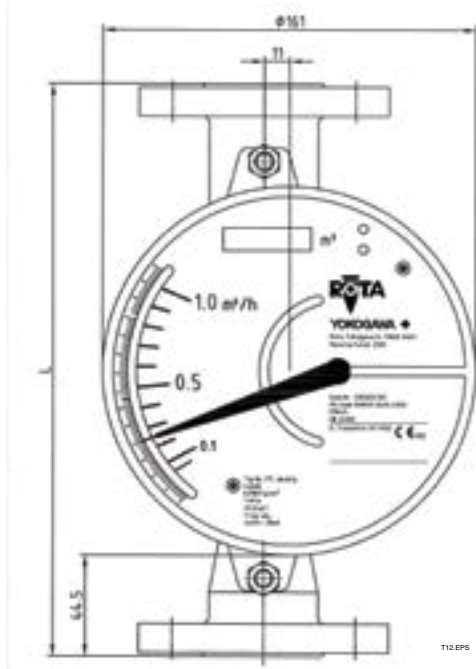

Fig. 9-7 Front view RAMC type 90

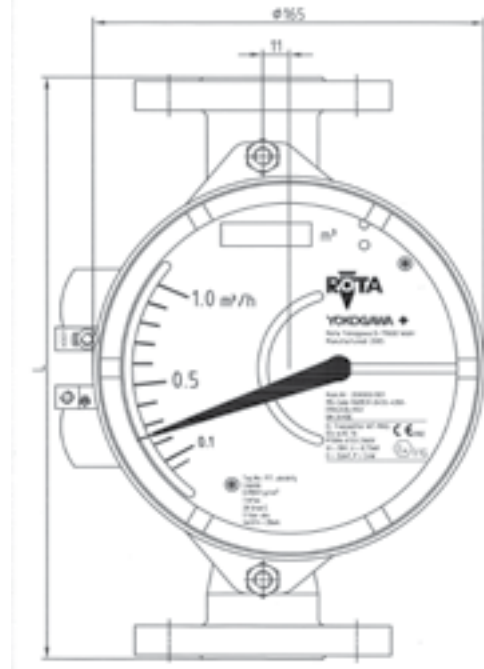
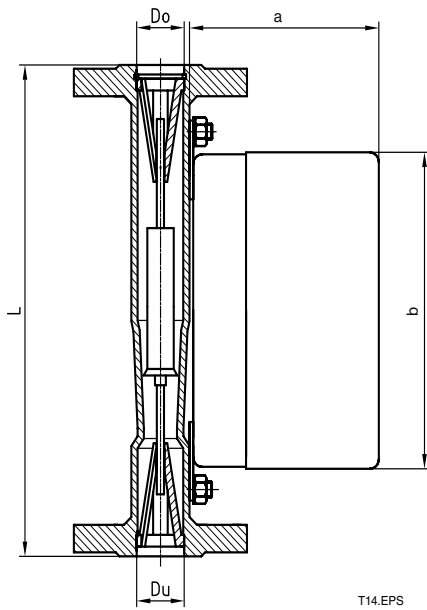
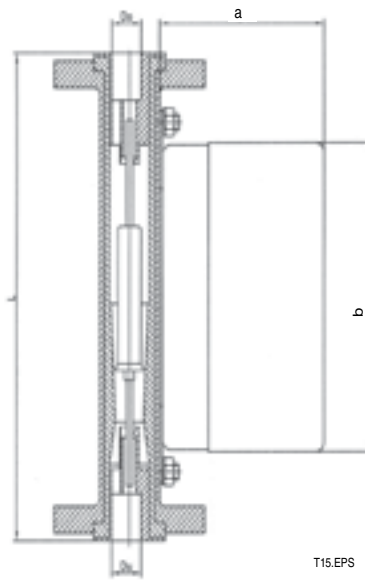

Fig. 9-8. Front view RAMC type 91



T14.EPS

Fig. 9-13 RAMC metal measuring tube



T15.EPS

Fig. 9-10 RAMC metal measuring tube with lining

	a mm	b mm
Housing type 90	104	161
Housing type 91 standard	110	165
Housing type 91 flame proof , option /KF1	118	165
Housing type 66	110	161

RAMC Flange dimensions

Table 9-14

Inner diameter of stainless steel flanges								Inner diameter of flanges with PTFE- lining			
Pos. ¹⁾	EN-flange without groove			ASME-flange			Rosita-flange	Pos. ¹⁾	EN- flange	ASME-flange	Du = Do mm
	Size	Du mm	Do mm	Size	Du mm	Do mm	Du=Do mm		Size	Size	
1	DN15-DN50	20.7	20.7	½" - 1"	20.7	20.7	20.7	----	----	----	----
2	DN15-DN50	29.5	29.5	½"	20.7	20.7	29.5	2	DN15-DN25	¾" - 1"	23.5
				¾" - 2"	29.5	29.5					
3	DN25-DN50	45.2	45.2	1"	32.2	32.2	45.2	3	DN25-DN50	1¼" - 1½"	36.0
				1¼" - 2"	45.2	45.2					
4	DN50-DN100	62.0	76.0	2"	62.0	65.5	----	4	DN50-DN80	2½" - 3"	66.0
				2½" - 3"	62.0	76.0					
5	DN80-DN150	94.0	94.0	3" - 6"	94.0	94.0	----	5	DN80-DN100	3½" - 4"	82.0
6	DN100-DN150	116.0	116.0	4" - 6"	116.0	116.0	----	6	DN100	4"	110.0

¹⁾see table 9.10, 9.11, 9.12

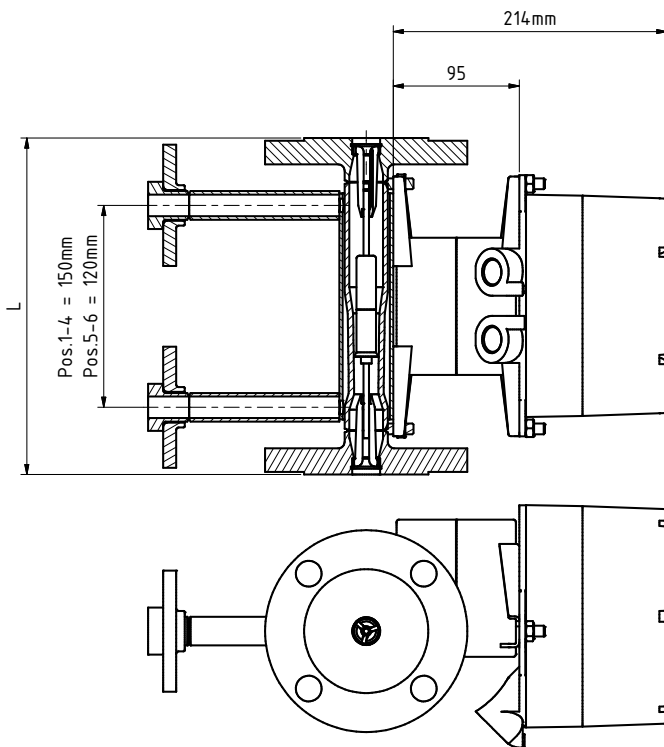

Fig. 9-11 RAMC type 91 and option /A16 and /T2

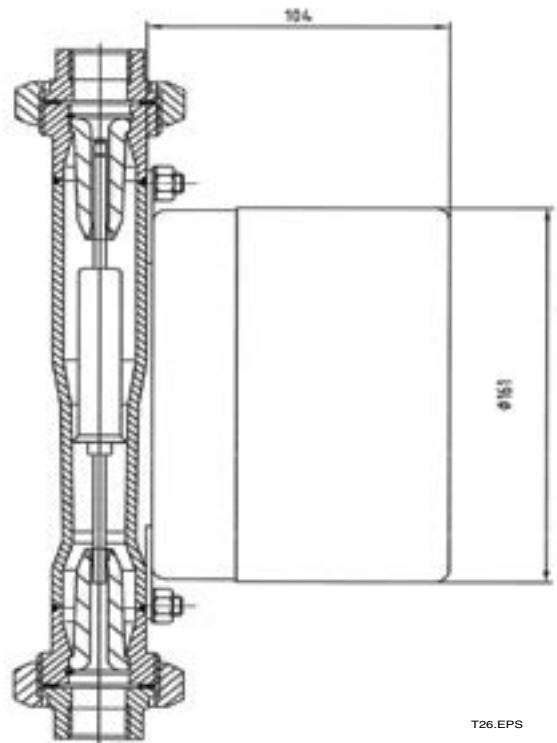

Fig. 9-12 RAMC with connection R4 / T4

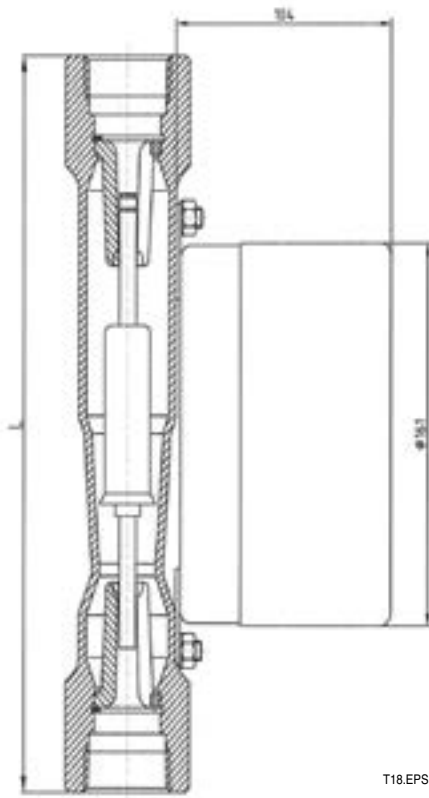

Fig. 9-13 RAMC with connection T6/ G6

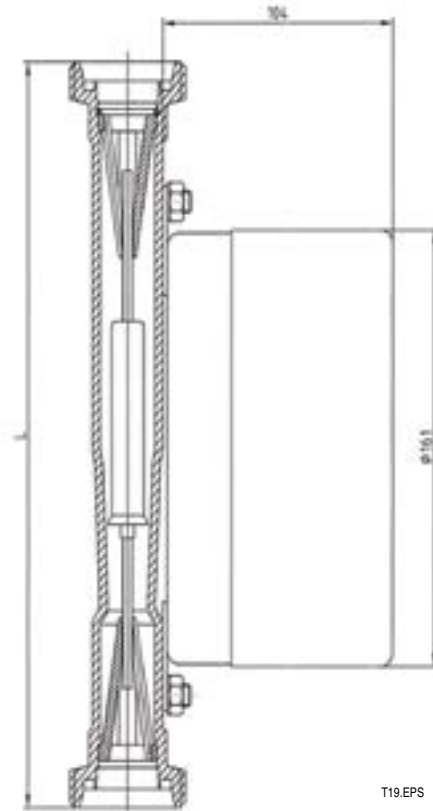

Fig. 9-14 RAMC with connection S2

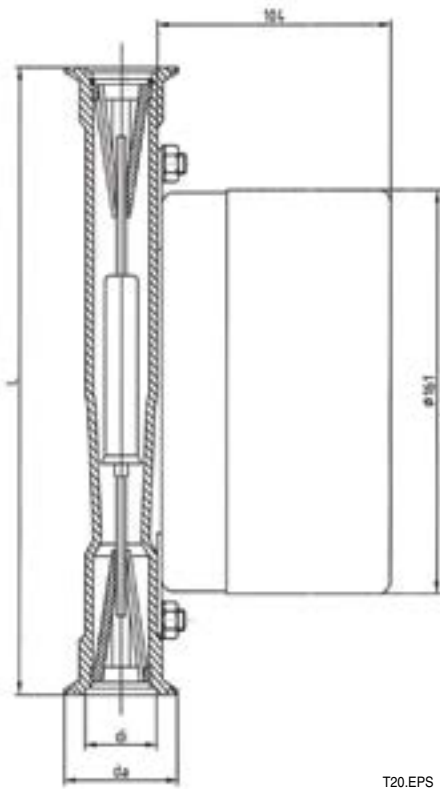

fig. 9-15 RAMC with connection S4

Table 9.15 Diameter for RAMC connection sizes S4

Position *)	Size [mm]	di [mm]	da [mm]
1	DN25 / 1''	36	50.5
	DN32	36	50.5
	DN40 / 1 1/2''	36	50.5
2	DN25 / 1''	36	50.5
	DN32	36	50.5
	DN40 / 1 1/2''	36	50.5
3	DN50 / 2''	47.8	64
4	DN65 / 3''	72.1	95
5	DN100 / 4''	97.6	119

*) see table 9-10, 9-11, 9-12

Table 9.16 RAMC Weights

Position *)	Weight [kg]
1	3 - 5
2	3 - 5
3	6.5 - 8
4	8.6 - 11
5	13 - 16
6	17 - 20

*) see table 9-10, 9-11, 9-12

Indicator on distance (option /A16) additional 1kg

9.5 Temperature graphs for RAMC metal design, standard and intrinsic safe

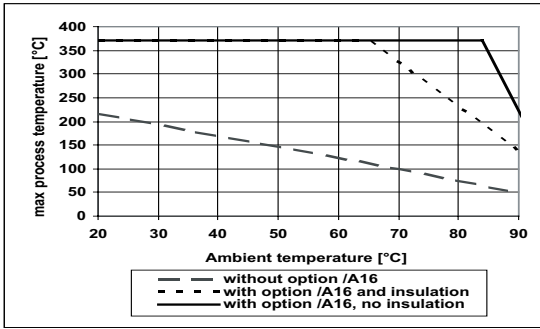

fig. 7a RAMC : - type 90 / 91
- only with indicator

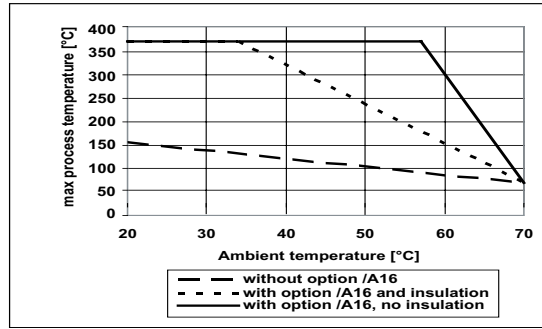

fig. 7b RAMC : - type 90 / 91
- with limit switches
- with electronic transmitter

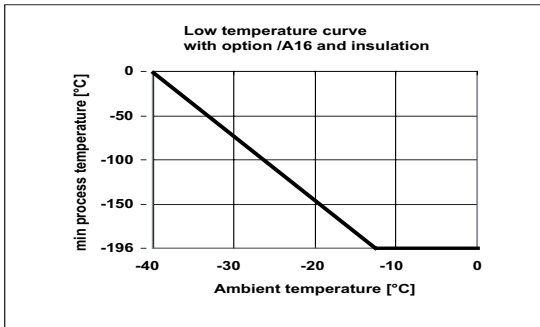

fig. 7c RAMC : - type 90 / 91
- with or without limit switches
- with or without electronic transmitter

T10.EPS

The temperature graphs are reference values for size DN100. They may be influenced negative by trapped heat, external heat sources or radiated heat and influenced positive for smaller sizes.
 Insulation means rock wool between tube and indicator.
 Units with electronic transmitter can show the temperature of the internal transmitter on the display or HART- type can show and supervise the internal temperature by HART-communication.
 Units with PTFE lining are usable up to 130°C.
 For units with explosion proof certification the temperature limits according the certificate of conformity must be regarded (see also page 9-8 to 9-12).

PRESSURE RATING

The pressure relevant temperature limits of the RAMC are:

-196 to 370°C for units with SS wetted parts

-80 to 130°C for units with PTFE wetted parts.

These limits are reduced by metrological boundary conditions (see temperature curves and table).

Process connection			Process temperature									
			-196 °C	RT (20C)	50 °C	100 °C	150 °C	200 °C	250 °C	300 °C	350 °C	370 °C
A1)	Flange ASME 150lbs		19 bar	19 bar	18.4 bar	16.2 bar	14.8 bar	13.7 bar	12.1 bar	10.2 bar	8.4 bar	7.4 bar
A2)	Flange ASME 300lbs		49.6 bar	49.6 bar	48.1 bar	42.2 bar	38.5 bar	35.7 bar	33.4 bar	31.6 bar	30.3 bar	29.9 bar
A3)	Flange ASME 600lbs		99.3 bar	99.3 bar	96.2 bar	84.4 bar	77 bar	71.3 bar	66.8 bar	63.2 bar	60.7 bar	59.8 bar
D2	Flange EN PN16		16 bar	16 bar	15.6 bar	14.2 bar	12.8 bar	11.7 bar	10.9 bar	10.3 bar	9.9 bar	9.6 bar
D4	Flange EN PN40		40 bar	40 bar	39.1 bar	35.6 bar	32 bar	29.3 bar	27.2 bar	25.8 bar	24.7 bar	24 bar
D5	Flange EN PN63		63 bar	63 bar	61.6 bar	56 bar	50.4 bar	46.2 bar	42.8 bar	40.6 bar	38.9 bar	37.8 bar
D6	Flange EN PN100		100 bar	100 bar	97.8 bar	88.9 bar	80 bar	73.3 bar	68 bar	64.4 bar	61.8 bar	60 bar
R4/T4	Internal Thread	RAMC01..	25 bar	25 bar	25 bar	25 bar	20 bar	20 bar	20 bar	20 bar	-----	-----
R4/T4	Internal Thread	RAMC23..	25 bar	25 bar	25 bar	25 bar	20 bar	20 bar	20 bar	20 bar	-----	-----
R4/T4	Internal Thread	RAMC02..	16 bar	16 bar	16 bar	16 bar	16 bar	16 bar	16 bar	16 bar	-----	-----
R4/T4	Internal Thread	RAMC03..	16 bar	16 bar	16 bar	16 bar	16 bar	16 bar	16 bar	16 bar	-----	-----
R4/T4	Internal Thread	RAMC05..	10 bar	10 bar	10 bar	10 bar	10 bar	10 bar	10 bar	10 bar	-----	-----
R4/T4	Internal Thread	RAMC06..	10 bar	10 bar	10 bar	10 bar	10 bar	10 bar	10 bar	10 bar	-----	-----
G6/T6	Internal Thread	RAMC01..	40 bar	40 bar	40 bar	40 bar	40 bar	40 bar	40 bar	40 bar	-----	-----
G6/T6	Internal Thread	RAMC23..	40 bar	40 bar	40 bar	40 bar	40 bar	40 bar	40 bar	40 bar	-----	-----
G6/T6	Internal Thread	RAMC02..	40 bar	40 bar	40 bar	40 bar	40 bar	40 bar	40 bar	40 bar	-----	-----
G6/T6	Internal Thread	RAMC03..	40 bar	40 bar	40 bar	40 bar	40 bar	40 bar	40 bar	40 bar	-----	-----
G6/T6	Internal Thread	RAMC06..	40 bar	40 bar	40 bar	40 bar	40 bar	40 bar	40 bar	40 bar	-----	-----
			Process temperature									
			-196 °C	RT (20C)	50 °C	100°C	140°C	see corresponding standard for the connection				
S2	Clamp DIN 11851	RAMC02..		40 bar	40 bar	40 bar	40 bar					
S2	Clamp DIN 11851	RAMC05..		25 bar	25 bar	25 bar	25 bar					
S2	Clamp DIN 11851	RAMC06..		25 bar	25 bar	25 bar	25 bar					
S2	Clamp DIN 11851	RAMC08..		25 bar	25 bar	25 bar	25 bar					
S2	Clamp DIN 11851	RAMC10..		25 bar	25 bar	25 bar	25 bar					
S2	Clamp DIN 11851	RAMC12..		16 bar	16 bar	16 bar	16 bar					
			Process temperature									
			-196 °C	RT (20C)	50 °C	100°C	150°C	see corresponding standard for the connection				
S4	Tri- Clamp DIN 32676	RAMC02..		16 bar	16 bar	16 bar	16 bar					
S4	Tri- Clamp DIN 32676	RAMC03..		16 bar	16 bar	16 bar	16 bar					
S4	Tri- Clamp DIN 32676	RAMC04..		16 bar	16 bar	16 bar	16 bar					
S4	Tri- Clamp DIN 32676	RAMC05..		16 bar	16 bar	16 bar	16 bar					
S4	Tri- Clamp DIN 32676	RAMC06..		10 bar	10 bar	10 bar	10 bar					
S4	Tri- Clamp DIN 32676	RAMC08..		10 bar	10 bar	10 bar	10 bar					
S4	Tri- Clamp DIN 32676	RAMC10..		10 bar	10 bar	10 bar	10 bar					
S5	Rosista Flange	RAMC02..		10 bar	see corresponding standard for the connection							
S5	Rosista Flange	RAMC04..		10 bar								

) Dual certified AISI 316/316L

10. Explosion-protected Type Instruments

This is only applicable to the countries in European Union.

- GB** All instruction manuals for ATEX Ex related products are available in English, German and French. Should you require Ex related instructions in your local language, you are to contact your nearest Yokogawa office or representative.
- DK** Alle brugervejledninger for produkter relateret til ATEX Ex er tilgængelige på engelsk, tysk og fransk. Skulle De ønske yderligere oplysninger om håndtering af Ex produkter på eget sprog, kan De rette henvendelse herom til den nærmeste Yokogawa afdeling eller forhandler.
- I** Tutti i manuali operativi di prodotti ATEX contrassegnati con Ex sono disponibili in inglese, tedesco e francese. Se si desidera ricevere i manuali operativi di prodotti Ex in lingua locale, mettersi in contatto con l'ufficio Yokogawa più vicino o con un rappresentante.
- E** Todos los manuales de instrucciones para los productos antiexplosivos de ATEX están disponibles en inglés, alemán y francés. Si desea solicitar las instrucciones de estos artículos antiexplosivos en su idioma local, deberá ponerse en contacto con la oficina o el representante de Yokogawa más cercano.
- NL** Alle handleidingen voor producten die te maken hebben met ATEX explosiebeveiliging (Ex) zijn verkrijgbaar in het Engels, Duits en Frans. Neem, indien u aanwijzingen op het gebied van explosiebeveiliging nodig hebt in uw eigen taal, contact op met de dichtstbijzijnde vestiging van Yokogawa of met een vertegenwoordiger.
- SF** Kaikkien ATEX Ex -tyyppisten tuotteiden käyttöohjeet ovat saatavilla englannin-, saksan- ja ranskan kielisinä. Mikäli tarvitsette Ex -tyyppisten tuotteiden ohjeita omalla paikallisella kielellänne, ottakaa yhteyttä lähimpään Yokogawa-toimistoon tai -edustajaan.
- P** Todos os manuais de instruções referentes aos produtos Ex da ATEX estão disponíveis em Inglês, Alemão e Francês. Se necessitar de instruções na sua língua relacionadas com produtos Ex, deverá entrar em contacto com a delegação mais próxima ou com um representante da Yokogawa.
- F** Tous les manuels d'instruction des produits ATEX Ex sont disponibles en langue anglaise, allemande et française. Si vous nécessitez des instructions relatives aux produits Ex dans votre langue, veuillez bien contacter votre représentant Yokogawa le plus proche.
- D** Alle Betriebsanleitungen für ATEX Ex bezogene Produkte stehen in den Sprachen Englisch, Deutsch und Französisch zur Verfügung. Sollten Sie die Betriebsanleitungen für Ex-Produkte in Ihrer Landessprache benötigen, setzen Sie sich bitte mit Ihrem örtlichen Yokogawa-Vertreter in Verbindung.
- S** Alla instruktionsböcker för ATEX Ex (explosionssäkra) produkter är tillgängliga på engelska, tyska och franska. Om Ni behöver instruktioner för dessa explosionssäkra produkter på annat språk, skall Ni kontakta närmaste Yokogawakontor eller representant.
- GR** Όλα τα εγχειρίδια λειτουργίας των προϊόντων με ATEX Ex διατίθενται στα Αγγλικά, Γερμανικά και Γαλλικά. Σε περίπτωση που χρειάζεστε οδηγίες σχετικά με Ex στην τοπική γλώσσα παρακαλούμε επικοινωνήστε με το πλησιέστερο γραφείο της Yokogawa ή αντιπρόσωπο της.

- SK** Všetky návody na obsluhu pre prístroje s ATEX Ex sú k dispozícii v jazyku anglickom, nemeckom a francúzskom. V prípade potreby návodu pre Ex-prístroje vo Vašom národnom jazyku, skontaktujte prosím miestnu kanceláriu firmy Yokogawa.
- CZ** Všechny uživatelské příručky pro výrobky, na něž se vztahuje nevybušné schválení ATEX Ex, jsou dostupné v angličtině, němčině a francouzštině. Požadujete-li pokyny týkající se výrobků s nevybušným schválením ve vašem lokálním jazyku, kontaktujte prosím vaši nejbližší reprezentační kancelář Yokogawa.
- LT** Visos gaminių ATEX Ex kategorijos Eksploatavimo instrukcijos teikiama anglų, vokiečių ir prancūzų kalbomis. Norėdami gauti prietaisų Ex dokumentaciją kitomis kalbomis susisiekiate su artimiausiu bendrovės "Yokogawa" biuru arba atstovu.
- LV** Visas ATEX Ex kategorijas izstrādājumu Lietošanas instrukcijas tiek piegādātas angļu, vācu un franču valodās. Ja vēlaties saņemt Ex ierīšu dokumentāciju citā valodā, Jums ir jāsazinās ar firmas Jokogava (Yokogawa) tuvāko ofisu vai pārstāvi.
- EST** Kõik ATEX Ex toodete kasutamisyhendid on esitatud inglise, saksa ja prantsuse keeles. Ex seadmete muukeelse dokumentatsiooni saamiseks pöörduge lähima lokagava (Yokogawa) kontori või esindaja poole.
- PL** Wszystkie instrukcje obsługi dla urządzeń w wykonaniu przeciwwybuchowym Ex, zgodnych z wymaganiami ATEX, dostępne są w języku angielskim, niemieckim i francuskim. Jeżeli wymagana jest instrukcja obsługi w Państwa lokalnym języku, prosimy o kontakt z najbliższym biurem Yokogawy.
- SLO** Vsi predpisi in navodila za ATEX Ex sorodni pridelki so pri roki v angleščini, nemščini ter francoščini. Če so Ex sorodna navodila potrebna v vašem tujejnem jeziku, kontaktirajte vaš najbliži Yokogawa office ili predstavnika.
- H** Az ATEX Ex műszerek gépkönyveit angol, német és francia nyelven adjuk ki. Amennyiben helyi nyelven kéri az Ex eszközök leírásait, kérjük keressék fel a legközelebbi Yokogawa irodát, vagy képviselőt.
- BG** Всички упътвания за продукти от серията ATEX Ex се предлагат на английски, немски и френски език. Ако се нуждаете от упътвания за продукти от серията Ex на родния ви език, се свържете с най-близкия офис или представителство на фирма Yokogawa.
- RO** Toate manualele de instructiuni pentru produsele ATEX Ex sunt in limba engleza, germana si franceza. In cazul in care doriti instructiunile in limba locala, trebuie sa contactati cel mai apropiat birou sau reprezentant Yokogawa.
- M** Il-manwali kollha ta' l-istruzzjonijiet għal prodotti marbuta ma' ATEX Ex huma disponibbli bl-Ingliż, bil-Ġermaniż u bil-Franċiż. Jekk tkun teħtieġ struzzjonijiet marbuta ma' Ex fil-lingwa lokali tiegħek, għandek tikkuntatta lill-egreb rappreżentant jew uffičċju ta' Yokogawa.

10.1 General



WARNING

- Only trained persons may use the instrument in industrial location.
- The instrument modification or parts replacement by other than an authorized Representative of Yokogawa is prohibited and will void the certification.
- Electrostatic charge on painted or other non-metallic surfaces may cause an explosion hazard. Avoid any actions that cause the generation of electrostatic charge, such as rubbing with a dry cloth on painted surface of the indicator or on potting of electronic transmitter.
- If the meter is mounted in an area where the use of category 2D apparatus is required, it shall be installed in such a way that the risk from electrostatic discharges and propagating brush discharges caused by rapid flow of dust is avoided.

10.1.1 Intrinsic safety



WARNING

To ensure intrinsic safety it is not permitted to repair or to modify the electronic transmitter, the display, the limit switches or the calibration EEPROM.

The electronic transmitters type -E /KS1, -H /KS1, -J /KS1, -E /KS2, -H /KS2, -J /KS2, -E /KS3, -H /KS3, -J /KS3, -E /ES1, -H /ES1, -J /ES1, -E /ES3, -H /ES3, -J /ES3, -E /ES2, -H /ES2, -J /ES2, -E /FS1, -H /FS1, -J /FS1, -E /NS1, -H /NS1, -J /NS1, -E /CS1, -H /CS1, -J /CS1, -E /GS1, -H /GS1, -J /GS1, -E /US1, -H /US1, -J /US1, as well as the limit switches option /K□ with option /KS1, /KS2, /KS3, /FS1, /CS1, /NS1, /GS1 are intrinsically safe devices.

Power supply for the electronic transmitter and transmitter relay for the limit switches are associated apparatus and should be installed outside any hazardous area.

The electronic transmitter must be connected to an intrinsically safe, certified power supply with a maximum voltage and output power below the maximum values of the electronic transmitter (refer to Technical data, in the concerning chapters). The combined internal inductance and capacity of the electronic transmitter and connecting cables must be less than the permitted external inductance and capacity of the power supply.

Accordingly, the limit switches have to be connected to intrinsically safe, certified isolating switching amplifiers. The relevant maximum safety values must be heeded at all times.

Especially in the case of high fluid temperatures, heated metering tubes or heat radiation by heat tracing, make sure that the temperature in the indicator housing does not exceed the permissible maximum ambient temperature of the transmitter (refer to Technical data, chapter 9).

10.1.2 Flame proof

In the RAMC with option /KF1, /EF1, /NF1, /GF1 the transmitter and the limit switches are mounted in a flame proof housing.

Wait 2 minutes after switching power off before opening the cover.

The cover can only be opened after loosening the safety screw.

After closing the cover the safety screw must be fixed before switching power on.

The RAMC with option /KF1, /EF1, /NF1, /GF1 shall be connected up via suitable cable glands and / or conduit systems that satisfy the requirements of 60079-1 sections 13.1 and 13.2 and for which a separate test certificate is available. Cable glands and entry fittings (screwed conduit entries) as well as blanking plugs of simple design may not be used. On connection of the RAMC /KF1, /EF1, /NF1, /GF1 using a conduit entry approved for the purpose, the associated sealing facility must be arranged directly on the housing.

Unused openings must be closed off as defined in EN 60079-1 section 11.9 (e.g. certified blanking elements).

The RAMC with option /KF1, /EF1, /NF1, /GF1 shall be connected to the local equipotentially grounding system.

Especially in the case of high fluid temperatures, heated metering tubes or heat radiation by heat tracing, make sure that the temperature in the indicator housing does not exceed the permissible maximum ambient temperature of the transmitter (refer to Technical data, chapter 9).

10.2 Intrinsically safe ATEX certified components (/KS1)

10.2.1 Technical data

Data of electronic transmitter type -E, -H or -J):

The electronic transmitter is an intrinsically safe device. This device is certified for hazardous areas of zone 1 (category 2) und zone 2 (category 3). It is not homologized for zone 0 (category 1). The classifications in brackets are given according to EU- Directive 2014/34/EU (ATEX).

EC-Type Examination Certificate Nr.: PTB 12ATEX2003 X

Applicable standards: EN 60079-0: 2012/A11: 2013

EN 60079-11: 2012

Identification in accordance with Directive 2014/34/EU (ATEX) :



Type of protection	: Intrinsically safe Ex ia IIC T6 Gb
Ambient temperature	: -40 °C ... +70 °C
Safety relevant maximum values:	
Maximum voltage	: $U_i = 30 \text{ V}$
Maximum current (IIC)	: $I_i = 101 \text{ mA}$
Maximum power	: $P_i = 1.4 \text{ W}$
Inner inductance	: $L_i = 0.15 \text{ mH}$
Inner capacity	: $C_i = 4.16 \text{ nF}$

Data of electronic transmitter type -G :

See IM 01R01B02-01E-E.

Data of limit switches :

The following table shows the maximum safety parameters for intrinsic safe limit switches according the certificates PTB 99 ATEX 2219X (Standard) and PTB 99 ATEX 2049X (Fail Safe).

Table 10.1

	Standard / K1.../ K3 Ex ia IIC T6		Fail Safe /K6 .../K10 Ex ia IIC T6	
	Type 2	Type 3	Type 2	Type 3
U_i [V]	16	16	16	16
I_i [mA]	25	52	25	52
P_i [mW]	64	169	64	169
C_i [nF]	150	150	30	30
L_i [μ H]	150	150	100	100
max. ambient temp. [°C] for T6	49	28	49	28
max. ambient temp. [°C] for T5	61	40	61	40
max. ambient temp. [°C] for T4 - T1	89	68	89	68

Intrinsic safe power supply for the electronic transmitter:

The power supply for the electronic transmitter is an associated apparatus that may not be installed in the hazardous area, and it may not exceed the safety relevant maximum values for voltage, current and power of the electronic transmitter as specified above.

For example option /UT can be used.

Intrinsic safe power supply for the limit switches:

The power supply (transmitter relay) for the limit switches is an associated apparatus that may not be installed in the hazardous area, and it may not exceed the safety relevant maximum values for voltage, current and power of the connected limit switch as specified above.

For example the type KFA6-SR2-Ex... (option /W2□) according certificate PTB 00 ATEX 2081 (230V AC supply) or the type KFD2-SR2-Ex... (option /W4□) according certificate PTB 00 ATEX 2080 (24V DC supply) can be used.

10.2.2 Installation

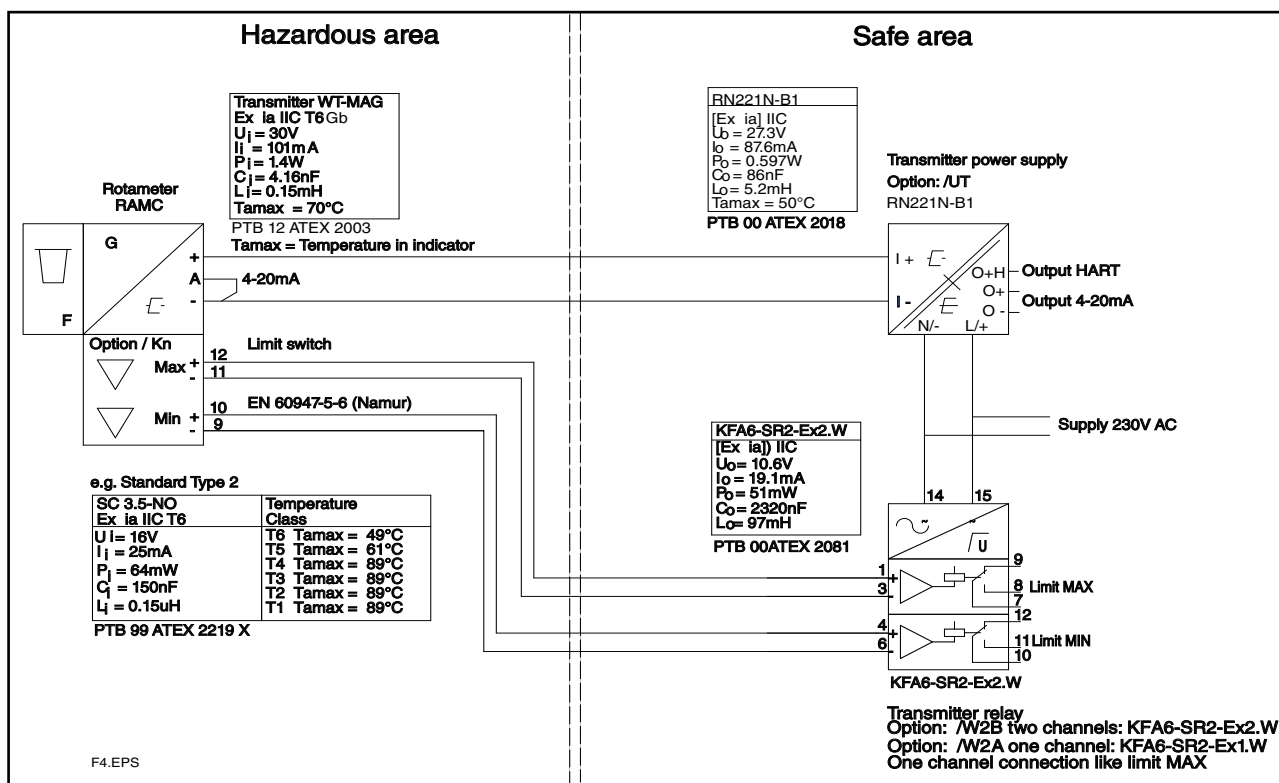

Fig. 10.1 Ex-Version according ATEX (Option /KS1) with electronic transmitter, power supply and limit switches with transmitter relay

10.2.3 Marking

Name plates of electronic transmitter :

Rota Yokogawa
Rheinstr. 8
D-79664 Wehr
WT-MAG Mat. No. 16-8040
Serial No. xxxxxxxx

Ex ia IIC T6 Gb
PTB 12ATEX2003 X
U_i=30V I_i=101mA P_i=1.4W
L_i=0.15mH C_i=4.16nF
CE II 2G

10.3 Intrinsically safe ATEX certified components for category 3G (/KS3)

10.3.1 Technical data

Data of electronic transmitter type -E, -H or -J):

The electronic transmitter is an intrinsically safe device. This device is certified for hazardous areas of zone 2 (category 3D)). The classifications in brackets are given according to EU-Directive 2014/34/EU (ATEX).

Applicable standards: EN 60079-0: 2012/A11: 2013
EN 60079-11: 2012

Identification in accordance with Directive 2014/34/EU (ATEX) :



Type of protection	: Intrinsically safe Ex ic IIC T6 Gc
Ambient temperature	: -40 °C...+70 °C
Safety relevant maximum values:	
Maximum voltage	: $U_i = 30 \text{ V}$
Maximum current (IIC)	: $I_i = 101 \text{ mA}$
Maximum power	: $P_i = 1.4 \text{ W}$
Inner inductance	: $L_i = 0.15 \text{ mH}$
Inner capacity	: $C_i = 4.16 \text{ nF}$

Data of limit switches :

The limit switches are apparatus with the type of protection "ic"

They can be mounted or installed in the hazardous areas of zone 2 (category 3G).

The classification in brackets is given according to the new EU regulation 94/9/EG (ATEX) .

This versions are identically constructed as the corresponding intrinsically safe (ia) versions.

Type of protection : Ex ic IIC T6 X

The following table shows the maximum safety parameters:

Table 10-2

	Standard / K1.../ K3		Fail Safe / K6.../ K10	
	Type 2	Type 3	Type 2	Type 3
Ui [V]	16	16	16	16
Ii [mA]	25	52	25	52
Pi [mW]	64	169	64	169
Ci [nF]	150	150	30	30
Li [μH]	150	150	100	100
max. ambient temp. [°C] for T6	49	28	49	28
max. ambient temp. [°C] for T5	61	40	61	40
max. ambient temp. [°C] for T4 - T1	89	68	89	68

Intrinsic safe power supply for the electronic transmitter:

The power supply for the electronic transmitter may not be installed in the hazardous area, and it may not exceed the safety relevant maximum values for voltage, current and power of the electronic transmitter as specified above.

Intrinsic safe power supply for the limit switches:

The power supply (transmitter relay) for the limit switches may not be installed in the hazardous area, and it may not exceed the safety relevant maximum values for voltage, current and power of the connected limit switch as specified above.

10.3.2 Marking

Name plates of electronic transmitter:

<p>Rota Yokogawa Rheinstr. 8 D-79664 Wehr WT-MAG Mat. No. 16-8040 Serial No, xxxxxxxx</p>	<p>Ex ic IIC T6 Gc</p> <p>Ui=30V li=101mA Pi=1.4W Li=0.15mH Ci=4.16nF</p> <p>CE II 3G</p>
--	---

10.4 Intrinsically safe IECEx- certified components (/ES1)

10.4.1 Technical data

Data of electronic transmitter type -E, -H or -J):

The electronic transmitter is an intrinsically safe device. This device is certified for hazardous areas of zone 1 (category 2) und zone 2 (category 3). It is not homologized for zone 0 (category 1).

Certificate Nr.: IECEx PTB 12.0020 X

Applicable standards: IEC 60079-0: 2011 edition 6
IEC 60079-11: 2011 edition 6

Type of protection	: Intrinsically safe Ex ia IIC T6 Gb
Ambient temperature	: -40 °C...+70 °C
Safety relevant maximum values:	
Maximum voltage	: $U_i = 30 \text{ V}$
Maximum current (IIC)	: $I_i = 101 \text{ mA}$
Maximum power	: $P_i = 1.4 \text{ W}$
Inner inductance	: $L_i = 0.15 \text{ mH}$
Inner capacity	: $C_i = 4.16 \text{ nF}$

Data of limit switches :

The following table shows the maximum safety parameters for intrinsic safe limit switches according the certificates IECEx PTB 11.0091X (Standard) and IECEx PTB 11.0092X (Fail Safe).

Table 10.3

	Standard / K1.../ K3 Ex ia IIC T6		Fail Safe / K6.../ K10 Ex ia IIC T6	
	Type 2	Type 3	Type 2	Type 3
U _i [V]	16	16	16	16
I _i [mA]	25	52	25	52
P _i [mW]	64	169	64	169
C _i [nF]	150	150	30	30
L _i [μH]	150	150	100	100
max. ambient temp. [°C] for T6	49	28	49	28
max. ambient temp. [°C] for T5	61	40	61	40
max. ambient temp. [°C] for T4 - T1	89	68	89	68

Intrinsic safe power supply for the electronic transmitter:

The power supply for the electronic transmitter is an associated apparatus that may not be installed in the hazardous area, and it may not exceed the safety relevant maximum values for voltage, current and power of the electronic transmitter as specified above.

For example option /UT can be used.

Intrinsic safe power supply for the limit switches:

The power supply (transmitter relay) for the limit switches is an associated apparatus that may not be installed in the hazardous area, and it may not exceed the safety relevant maximum values for voltage, current and power of the connected limit switch as specified above.

For example the type KFA6-SR2-Ex... (option (W2□) according certificate IECEx PTB 11.0031 (230V AC supply) or the type KFD2-SR2-Ex... (option (W4□) according certificate IECEx PTB 11.0032 (24V DC supply) can be used.

10.4.2 Installation

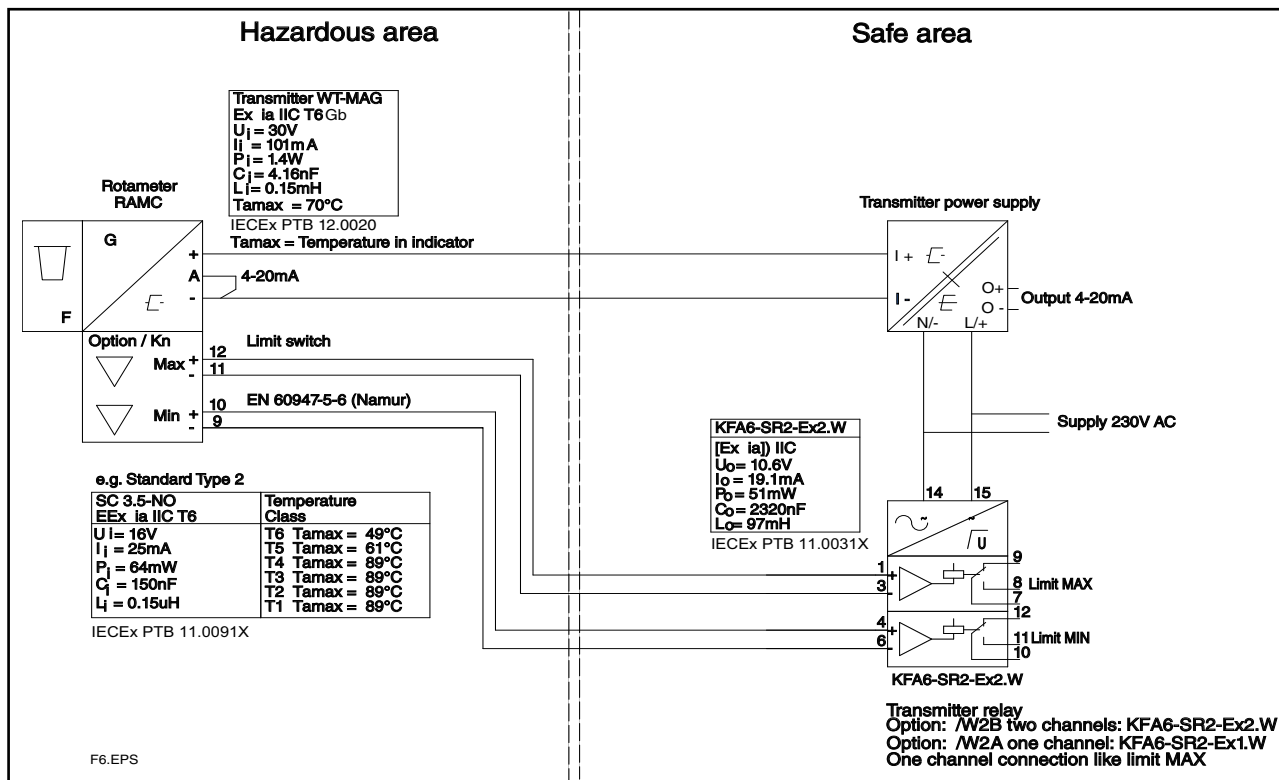

Fig. 10.2 Ex-Version according IECEx (Option /ES1) with electronic transmitter, power supply and limit switches with transmitter relay

10.4.3 Marking

Name plates of electronic transmitter:

Rota Yokogawa
Rheinstr. 8
D-79664 Wehr
WT-MAG Mat. No. 16-8040
Serial No, xxxxxxxx

Ex ia IIC T6 Gb
IECEX PTB 12.0020 X
 $U_i=30V$ $I_i=101mA$ $P_i=1.4W$
 $L_i=0.15mH$ $C_i=4.16nF$

10.5 Intrinsically safe IECEx- components for category 3G (/ES3)

10.5.1 Technical data

Data of electronic transmitter type -E, -H or -J):

The electronic transmitter is an intrinsically safe device. This device is use for hazardous areas of category 3.

Applicable standards: IEC 60079-0: 2011 edition 6
IEC 60079-11: 2011 edition 6

Type of protection : Intrinsically safe Ex ic IIC T6 Gc

Ambient temperature : -40 °C...+70 °C

Safety relevant maximum values:

- Maximum voltage : $U_i = 30 \text{ V}$
- Maximum current (IIC) : $I_i = 101 \text{ mA}$
- Maximum power : $P_i = 1.4 \text{ W}$
- Inner inductance : $L_i = 0.15 \text{ mH}$
- Inner capacity : $C_i = 4.16\text{nF}$

Data of limit switches :

The following table shows the maximum safety parameters for intrinsic safe limit switches according the certificates IECEx PTB 11.0091X (Standard) and IECEx PTB 11.0092X (Fail Safe).

Table 10.4

	Standard / K1../ K3 Ex ic IIC T6 TX		Fail Safe / K6../ K10 Ex ic IIC T6 TX	
	Type 2	Type 3	Type 2	Type 3
Ui [V]	16	16	16	16
Ii [mA]	25	52	25	52
Pi [mW]	64	169	64	169
Ci [nF]	150	150	30	30
Li [µH]	150	150	100	100
max. ambient temp. [°C] for T6	49	28	49	28
max. ambient temp. [°C] for T5	61	40	61	40
max. ambient temp. [°C] for T4 - T1	89	68	89	68

Intrinsic safe power supply for the electronic transmitter:

The power supply for the electronic transmitter is an associated apparatus that may not be installed in the hazardous area, and it may not exceed the safety relevant maximum values for voltage, current and power of the electronic transmitter as specified above.

For example option /UT can be used.

Intrinsic safe power supply for the limit switches:

The power supply (transmitter relay) for the limit switches is an associated apparatus that may not be installed in the hazardous area, and it may not exceed the safety relevant maximum values for voltage, current and power of the connected limit switch as specified above.

For example the type KFA6-SR2-Ex... (option (W2□) according certificate IECEx PTB 11.0031 (230 V AC supply) or the type KFD2-SR2-Ex... (option (W4□) according certificate IECEx PTB 11.0032 (24 V DC supply) can be used.

10.5.2 Marking

Name plates of electronic transmitter :

<p>Rota Yokogawa Rheinstr. 8 D-79664 Wehr WT-MAG Mat. No. 16-8040 Serial No, xxxxxxxx</p>	<p>Ex ic IIC T6 Gc</p> <p>Ui=30V Ii=101mA Pi=1.4W Li=0.15mH Ci=4.16nF</p>
--	---

10.6 Intrinsically safe INMETRO (Brazil) components (/US1)

Used standards:

ABNT NBR IEC 60079-0: 2013 (errata 1: 2014, Versão Corrigida: 2014)

ABNT NBR IEC 60079-11: 2013

10.6.1 Technical data

Data of electronic transmitter type -E, -H or -J):

The electronic transmitter is an intrinsically safe device. This device is certified for hazardous areas of zone 1 and zone 2. It is not homologized for zone 0.

Certificate Nr.: DEKRA 15.0006 X

Type of protection : Intrinsically safe Ex ia IIC T6 Gb

Ambient temperature : -40 °C...+70 °C

Safety relevant maximum values:

Maximum voltage : $U_i = 30\text{ V}$
 Maximum current (IIC) : $I_i = 101\text{ mA}$
 Maximum power : $P_i = 1.4\text{ W}$
 Inner inductance : $L_i = 0.15\text{ mH}$
 Inner capacity : $C_i = 4.16\text{ nF}$

10.6.2 Installation

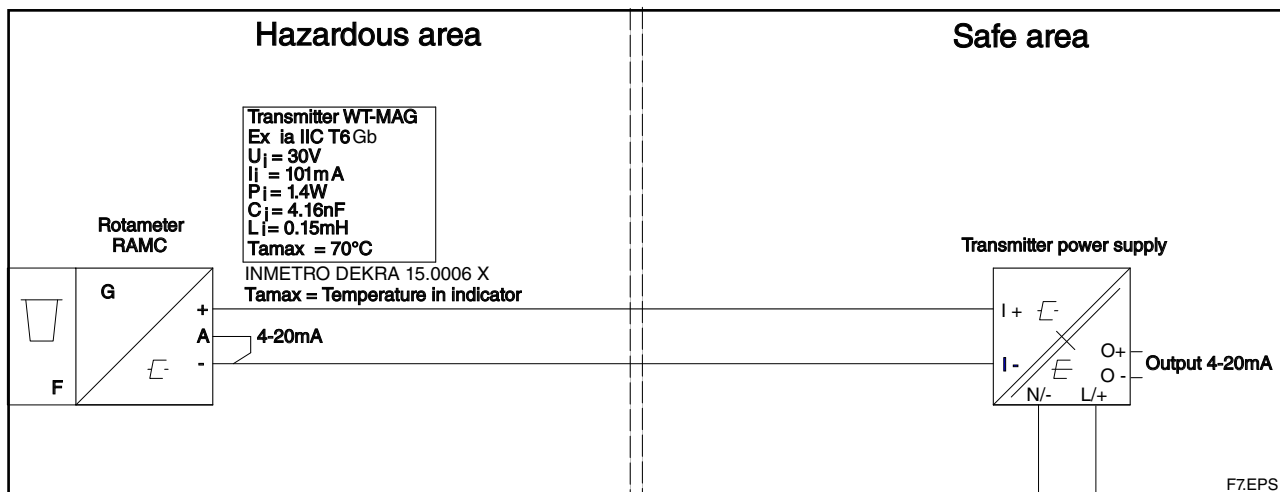

Fig. 10.3 Ex-Version according INMETRO (Option /US1) with electronic transmitter, power supply

10.6.3 Marking

Name plates of electronic transmitter:

Rota Yokogawa
Rheinstr. 8
D-79664 Wehr
WT-MAG Mat. No. 16-8040
Serial No, xxxxxxxx

Ex ia IIC T6 Gb
 $U_i=30\text{V}$ $I_i=101\text{mA}$ $P_i=1.4\text{W}$
 $L_i=0.15\text{mH}$ $C_i=4.16\text{nF}$
DEKRA 15.0006 X

Segurança

INMETRO DEKRA

10.7 Intrinsically safe FM / CSA (USA + Canada) components (/FS1, /CS1)

10.7.1 Electronic transmitter (/FS1 for USA, /CS1 for Canada)

Technical data:

Certificate: No. 3027471
 Applicable Standards:
 FM3600, FM3610, FM3611, FM3810
 C22.2 No. 157, C22.2 No. 213

Type of protection:

intrinsic safe Cl. I, Div. 1, GP. A, B, C, D T6
 intrinsic safe Cl. I, Zone 0, AEx ia IIC T6
 non incandive Cl. I, Div. 2, GP. A, B, C, D T6

Ambient temperature: -25 °C...+70 °C

Maximum Entity and Non incandive Field Wiring Parameters:

$V_i = 30 \text{ V}$
 $I_i = 100 \text{ mA}$
 $P_i = 1.4 \text{ W}$
 $C_i = 40 \text{ nF}$
 $L_i = 150 \text{ }\mu\text{H}$

Installation:

For installation see Control Drawings on page 10-12 and 10-13.



WARNING

- Installation should be in accordance with National Electrical Code, ANSI / NPFA70.
- For intrinsic safe application a safety barrier or FM approved power supply must be used which meet the above mentioned entity parameters.
- For non incandive application the general purpose equipment must be FM approved which non field wiring which meet the above mentioned non incandive field wiring parameters.
- The FM Approved Hand Held Communicator may be connected at any point in the loop between the electronic transmitter and the Control Equipment.

Maintenance and repair:



WARNING

The instrument modification or part replacements by other than authorized representative of Rota Yokogawa is prohibited and will void the approval of FM Approvals.

Marking:

Name plates of electronic transmitter:

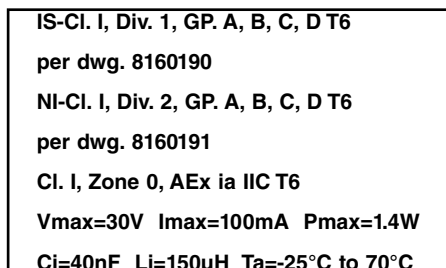
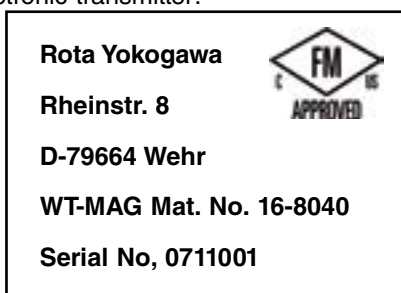

Control Drawings:
Electronic transmitter intrinsically safe

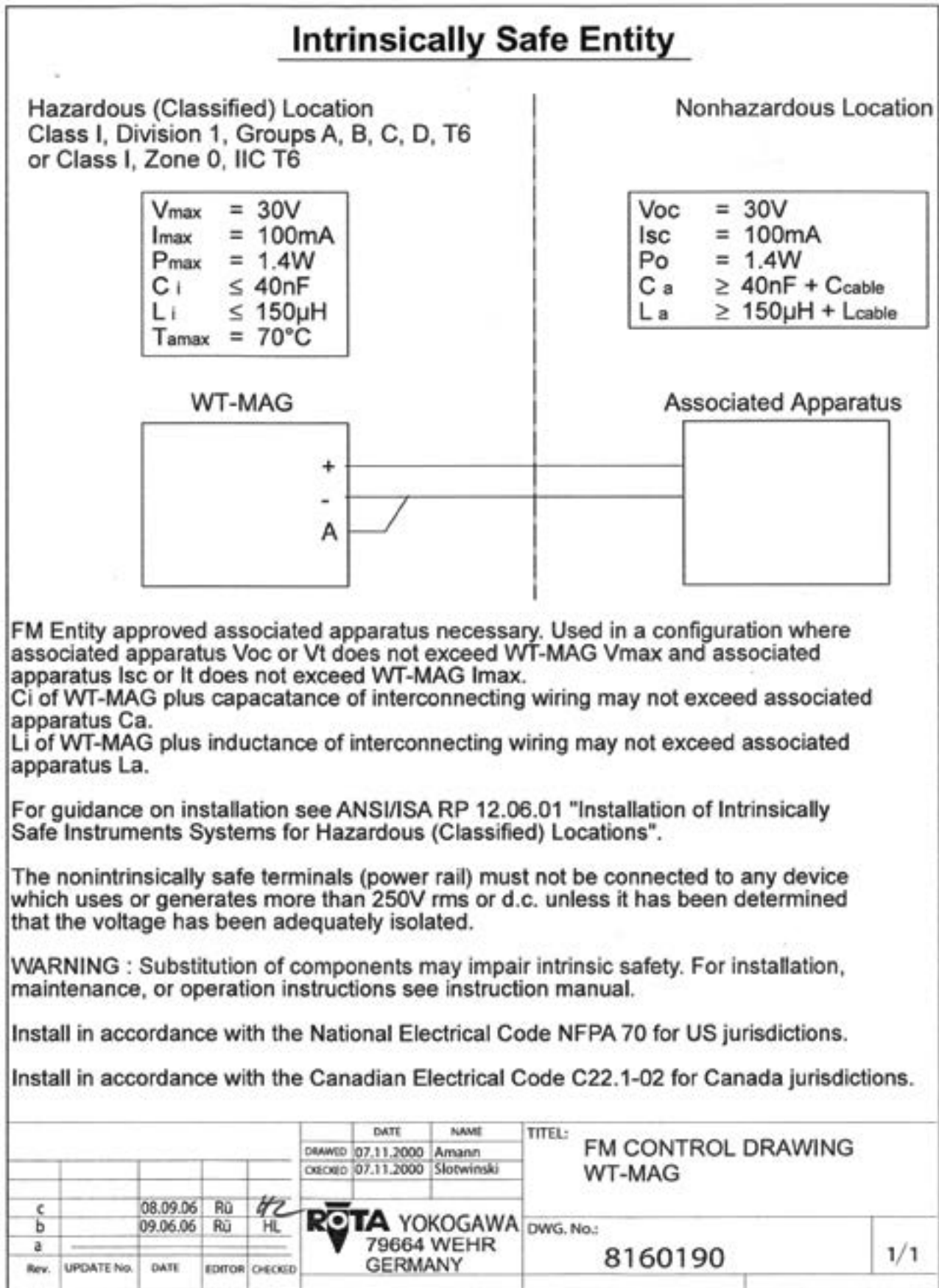

Electronic transmitter non incendive

Nonincendive

Hazardous (Classified) Location
Class I, Division 2, Groups A, B, C, D, T6

$V_{max} = 30V$
 $I_{max} = 100mA$
 $P_{max} = 1.4W$
 $C_i \leq 40nF$
 $L_i \leq 150\mu H$
 $T_{amax} = 70^{\circ}C$

WT-MAG

+
-

A

Nonhazardous Location

$V_{oc} = 30V$
 $I_{sc} = 100mA$
 $P_o = 1.4W$
 $C_a \geq 40nF + C_{cable}$
 $L_a \geq 150\mu H + L_{cable}$

Associated Nonincendive
field wiring apparatus

The nonincendive field wiring circuit concept allows interconnections of nonincendive field wiring apparatus with associated nonincendive field wiring apparatus, using any of the wiring methods permitted for unclassified locations.

$V_{max} \geq V_{oc}$ or V_t

$C_a \geq C_i + C_{cable}$

$L_a \geq L_i + L_{cable}$

For this current controlled circuit the parameter I_{max} is not required and need not be aligned with parameter I_{sc} or I_t of the barrier or associated field wiring apparatus.

For guidance on installation see ANSI/ISA RP 12.06.01 "Installation of Intrinsically Safe Instruments Systems for Hazardous (Classified) Locations".

Install in accordance with the National Electrical Code NFPA 70 for US jurisdictions.
Install in accordance with the Canadian Electrical Code C22.1-02 for Canada jurisdictions.

WARNING : Substitution of components may impair intrinsic safety. For installation, maintenance, or operation instructions see instruction manual.

					DATE	NAME	TITEL: FM CONTROL DRAWING WT-MAG		
					DRAWN	07.11.2000			Amann
					CHECKED	07.11.2000			Slotwinski
c		08.09.06	Rü		ROTA YOKOGAWA 79664 WEHR GERMANY			DWG. No.: 8160191	
b		09.06.06	Rü	HL					
a									
Rev.	UPDATE No.	DATE	EDITOR	CHECKED				1/1	

10.7.2 Limit switches option /K1.../K10 (/FS1 for USA)

Data of limit switches (FM-approval):

The limit switches are intrinsically safe devices. They are certified by Pepperl & Fuchs for:

Intrinsically safe: Cl. I, Div. 1, GP. A, B, C, D T6 Ta=60°C
Cl. II, Div. 1, GP. E, F, G
Cl. III, Div. 1

Non incendive: Cl. I, Div. 2, GP. A, B, C, D T5 Ta=50°C
Cl. II, Div. 1, GP. E, F, G
Cl. III, Div. 1

Maximum Entity Field Wiring Parameters:

see FM-control drawing 116-0165 on page 10-15 and 10-16 for intrinsic safety
see FM-control drawing 116-0155 on page 10-17 for non incendive

10.7.3 Limit switches option /K1.../K3 (/CS1 for Canada)

Data of limit switches (CSA-approval):

The limit switches are intrinsically safe devices. They are certified by Pepperl & Fuchs for:

Intrinsically safe: Cl. I, Div. 1, GP. A, B, C, D
Cl. II, Div. 1, GP. E, F, G
Cl. III, Div. 1

Maximum Entity Field Wiring Parameters:

see CSA drawing 116-0047 on page 10-18 and 10-19

**WARNING**

Only in combination with power supply option /W□A or /W□B.

Limit switches FM intrinsically safe (1)

<p>HAZARDOUS (CLASSIFIED) LOCATION Class I, Division 1, Groups A, B, C, D Class II, Division 1, Groups E, F, G Class III, Division 1 or Class I, Zone 0, Groups IIC T6 (Ta = 60°C)</p>	<p>NONHAZARDOUS LOCATION</p> <div style="border: 1px solid black; padding: 5px; margin: 10px auto; width: 80%;"> <p>Any FM certified associated apparatus with applicable division and group or zone and group approval and with entity parameters:</p> <table border="0"> <tr> <td>DIVISIONS</td> <td>ZONES</td> </tr> <tr> <td>Voc ≤ Vmax</td> <td>Uo ≤ Ui</td> </tr> <tr> <td>Isc ≤ Imax</td> <td>Io ≤ Ii</td> </tr> <tr> <td>Ca ≥ Ci+Ccable</td> <td>Co ≥ Ci+Ccable</td> </tr> <tr> <td>La ≥ Li+Lcable</td> <td>Lo ≥ Li+Lcable</td> </tr> </table> </div>	DIVISIONS	ZONES	Voc ≤ Vmax	Uo ≤ Ui	Isc ≤ Imax	Io ≤ Ii	Ca ≥ Ci+Ccable	Co ≥ Ci+Ccable	La ≥ Li+Lcable	Lo ≥ Li+Lcable
DIVISIONS	ZONES										
Voc ≤ Vmax	Uo ≤ Ui										
Isc ≤ Imax	Io ≤ Ii										
Ca ≥ Ci+Ccable	Co ≥ Ci+Ccable										
La ≥ Li+Lcable	Lo ≥ Li+Lcable										

Pepperl+Fuchs, Inc. "NAMUR" output proximity sensor. See Tables for entity parameters

Notes:

- For installation in a Division 1 hazardous (classified) location, the wiring must be in accordance with the National Electrical Code, NFPA 70, Article 504. For installation in a Zone 0 hazardous (classified) location, the wiring must be in accordance with the National Electrical Code, NFPA 70, Article 505. For additional information refer to ISA RP-12.6.
- The Entity Concept allows interconnection of intrinsically safe and associated apparatus not specifically examined in combination as a system when the approved values of Voc (or Uo) and Isc (or Io) for the associated apparatus are less than or equal to Vmax (or Ui) and Imax (or Ii) for the intrinsically safe apparatus and the approved values of Ca (or Co) and La (or Lo) for the associated apparatus are greater than Ci + Ccable, Li + Lcable, respectively for the intrinsically safe apparatus.
- Barriers shall not be connected to any device that uses or generates in excess of 250V rms or DC unless it has been determined that the voltage is adequately isolated from the barrier.
- Note associated apparatus with only Zone 1 approved connections limits the mounting of the sensors to Zone 1.
- 'a' in model number indicates option not affecting safety.
- NAMUR sensors are also nonincendive for Class I, Division 2, Groups A,B,C, and D; Class II, Division 1, Groups E,F, and G; Class III, Division 1; Class I, Zone 2, Groups IIC, IIB, IIA T5 hazardous (classified) locations and need not be connected to an associated apparatus when installed in accordance with Control Drawing 116-0155.
- The correlation between Typee of connected circuit, maximum permissible ambient temperature and temperature class are indicated at the top of each Table.
- Model number NMB8-SAE16GM27-N1-FE-V1 approved for Class I, Division 1, Groups C and D T4 (Ta = 85°C). See Table 12.
- Warning** - Equipment with non-metallic enclosures shall not be installed in a location where the external conditions are conducive to the build-up of electrostatic charge on such surfaces. The equipment shall only be cleaned with a damp cloth.

Dieses Dokument enthält sicherheitsrelevante Angaben. Es darf nicht ohne Absprache mit dem Normenfachmann geändert werden!			
This document contains safety-relevant information. It must not be altered without the authorization of the norm expert!			
Confidential according to ISO 16016	Only valid as long as released in EDM or with a valid production documentation!	scale: 1:1	date: 2015-Dec-08
 Twinsburg	Control Drawing	change notice tbd	respons. PJU
	NAMUR SENSORS – FM	approved	UEH
		norm	PJU
		116-0165G	sheet 1 of 11

Limit switches FM intrinsically safe (2)

TABLE 11 – INDUCTIVE SLOT SENSORS (SC..., SJ...)

Model	Ci	Li	Type 1 Ui = 16 V li = 25 mA Pi = 34 mW			Type 2 Ui = 16 V li = 25 mA Pi = 64 mW			Type 3 Ui = 16 V li = 52 mA Pi = 169 mW			Type 4 Ui = 16 V li = 76 mA Pi = 242 mW		
			T6	T5	T4-T1	T6	T5	T4-T1	T6	T5	T4-T1	T6	T5	T4-T1
Maximum permissible ambient temperature for application in temperature class														
SC2-N0a	150 nF	150 µH	55°C	67°C	95°C	48°C	60°C	88°C	23°C	35°C	63°C	6°C	18°C	46°C
SC3,5a-N0a	150 nF	150 µH	56°C	68°C	96°C	49°C	61°C	89°C	28°C	40°C	68°C	13°C	25°C	53°C
SC3,5-N0-Ya	150 nF	150 µH	55°C	67°C	95°C	48°C	60°C	88°C	23°C	35°C	63°C	6°C	18°C	46°C
SJ1,8-N-Ya	30 nF	100 µH	73°C	88°C	100°C	67°C	82°C	100°C	45°C	60°C	78°C	30°C	45°C	57°C
SJ2-Na	30 nF	100 µH	56°C	68°C	96°C	49°C	61°C	89°C	28°C	40°C	68°C	13°C	25°C	53°C
SJ2-SNa	30 nF	100 µH	73°C	88°C	100°C	66°C	81°C	100°C	45°C	60°C	78°C	30°C	45°C	57°C
SJ2-S1Na	60 nF	100 µH	73°C	88°C	100°C	66°C	81°C	100°C	45°C	60°C	78°C	30°C	45°C	57°C
SJ2,2-Na	30 nF	100 µH	73°C	88°C	100°C	67°C	82°C	100°C	45°C	60°C	78°C	30°C	45°C	57°C
SJ3,5-a-Na	50 nF	250 µH	56°C	68°C	96°C	49°C	61°C	89°C	28°C	40°C	68°C	13°C	25°C	53°C
SJ3,5-H-a	50 nF	250 µH	73°C	88°C	100°C	66°C	81°C	100°C	45°C	60°C	89°C	30°C	45°C	74°C
SJ3,5-SNa	30 nF	100 µH	73°C	88°C	100°C	66°C	81°C	100°C	45°C	60°C	89°C	30°C	45°C	74°C
SJ3,5-S1Na	30 nF	100 µH	73°C	88°C	100°C	66°C	81°C	100°C	45°C	60°C	89°C	30°C	45°C	74°C
SJ5-a-Na	50 nF	250 µH	56°C	68°C	96°C	49°C	61°C	89°C	28°C	40°C	68°C	13°C	25°C	53°C
SJ5-Ka	50 nF	550 µH	55°C	67°C	95°C	48°C	60°C	88°C	25°C	37°C	65°C	9°C	21°C	49°C
SJ10-Na	50 nF	100 µH	55°C	67°C	95°C	48°C	60°C	88°C	25°C	37°C	65°C	9°C	21°C	49°C
SJ15-Na	150 nF	1200 µH	55°C	67°C	95°C	48°C	60°C	88°C	25°C	37°C	65°C	9°C	21°C	49°C
SJ30-Na	150 nF	1250 µH	55°C	67°C	95°C	48°C	60°C	88°C	25°C	37°C	65°C	9°C	21°C	49°C

TABLE 12 – INDUCTIVE SENSORS (NMB...)

Model	Vmax ,Ui	I _{max} , li	Pi	Ci	Li
NMB8-SAE16GM27-N1-FE-V1	16 V	25 mA	100 mW	2 µF	8 mH

Dieses Dokument enthält sicherheitsrelevante Angaben. Es darf nicht ohne Absprache mit dem Normenfachmann geändert werden!

This document contains safety-relevant information. It must not be altered without the authorization of the norm expert!

Confidential according to ISO 16016

Only valid as long as released in EDM or with a valid production documentation!

scale: 1:1

date: 2015-Dec-08



Control Drawing

change notice
tbd

respons.

PJU

approved

UEH

116-0165G

Twinsburg

NAMUR SENSORS – FM

norm

PJU

sheet 11 of 11

Limit switches FM non incendive

HAZARDOUS (CLASSIFIED) LOCATION
 CLASS I, ZONE 2, GROUPS IIC, IIB, IIA (Ta = 50°C) T5
 CLASS I, DIVISION 2, GROUPS A, B, C and D
 CLASS II, DIVISION 1, GROUPS E, F and G
 CLASS III DIVISION 1 HAZARDOUS LOCATIONS

NON-HAZARDOUS LOCATION

PROXIMITY SENSORS

Models C (Capacitive), I (Analog Inductive), M (Magnetic), N (Discrete Inductive), S (Slot), R (Ring) followed by combination of numbers and letters. "-" dashes and/or "+" pluses may be included.

② ⑩

⑤ ⑥ ⑦

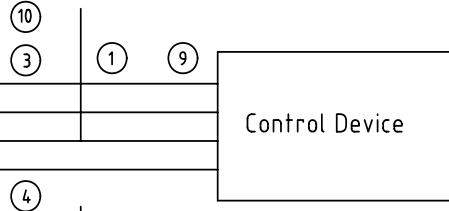

See Table 1. for sensors with nonincendive field wiring parameters.
 See Table 2. for sensors with exceptions.

NOTES:

- ① Wiring methods must be in accordance with the National Electrical Code, ANSI/NFPA 70, Article 501-4(b) for Class I, Division 2; 502-4(a) for Class II, Division 1; 502-4(b) for Class II, Division 2; 503-3(a) for Class III, Division 1; 503-3(b) for Class III, Division 2. Zone 2 wiring requirements are equivalent to Division 2 wiring requirements. See manufacturer's instructions for connection of devices and electrical data.
- ② These proximity sensors are rated "Nonincendive". Proximity sensors without a provision for conduit connection (i.e. via a conduit adapter) or a sensor with a plastic base must be mounted in a tool secured enclosure meeting the requirements of ANSI/ISA S82. Alternatively, sensors in accordance with Table 1 may be wired according to nonincendive field wire methods (a conduit connection or enclosure is not needed).
- ③ Proximity sensors, conduit, enclosures, and exposed noncurrent-carrying metal parts must be grounded and bonded in accordance with the National Electrical Code, ANSI/NFPA 70, Article 250.
- ④ WARNING - DO NOT CONNECT OR DISCONNECT WHILE CIRCUIT IS LIVE UNLESS LOCATION IS KNOWN TO BE NONHAZARDOUS.
- ⑤ The relay outputs of a proximity sensor must be supplied by a nonincendive source.
- ⑥ Sensitivity adjustment should only be done when the area is known to be nonhazardous.
- ⑦ A temperature rating of T5 applies for all nonincendive proximity sensors. SEE TABLE 2 for exceptions
- ⑧ The nonincendive field wiring concept allows interconnection of nonincendive circuits with a nonincendive source when the approved values of Voc and Isc of the nonincendive source are less than or equal to Vmax and Imax of the nonincendive circuit and the approved values of Ca and La for the nonincendive source are greater than Ci + Ccable and Li + Lcable, respectively, for the nonincendive circuit.
- ⑨ All Nonincendive sources must be approved.
- ⑩ Sensors using V93, V94, V95 connectors ("mini" 7/8") with the locking clamp (P+F model V9-CL-D2) and V1, V12 connectors with locking clamp (P & F model V1-Clip) are suitable to be mounted outside the protective enclosure. Wiring methods must be in accordance to the National Electrical Code, ANSI/NFPA 70.
- ⑪ NJa-b-c-d-e. Inductive Cylinder Position Sensor is suitable for Class I, Div 2 only.
 NI/1/2/ABCD/T5 Ta=50°C
 a=1.5, 2, 3
 b=C, D, F, PD, FD1
 c=US, E02, E2, E0
 d=any diameter
 e=V1, V12, V93, V94, V95 connectors
 NEMA 4X

TABLE 1 - NONINCENDIVE PARAMETERS ⑧

MODEL NUMBER	Vmax (V)	Imax (mA)	C _i (UF)	L _i (mH)
NJ2-12GM40-E2	60.0	200	0	0
NJ5-18GM50-E2	60.0	200	0	0

TABLE 2 - EXCEPTIONS

MODEL NUMBER	RESTRICTION
NBN3-F25-E8	Do not use in a Class II, Division 1, Group E Hazardous Location
V9-CL-D2 & V1-Clip	Not Approved for use in Class II or III locations
NJ type SENSOR See Note ⑪	Class I, Div 2 ONLY
NJ2-FD1 type SENSOR See Note 11	Class I, Div 2 ONLY / Ta = 85C /T4A

Certification Status		
Agency	Pending	Final
FM	X	X
CSA		
UL		

Dieses Dokument enthält sicherheitstechnische Angaben. Es darf nicht ohne Absprache mit dem Normenfachmann geändert werden!

This document contains safety-relevant information. It must not be altered without the authorization of the norm expert!

Confidential according to ISO 16016	Only valid as long as released in EDM or with a valid production documentation!	change notice	respos.	scale: none	date: 2009-Feb-25
 Twinsburg	CONTROL DRAWING Nonincendive sensors FM	150-1681	approved	US.DRL	116-0155E
			norm	US.GAP	

Limit switches CSA

■ Connections

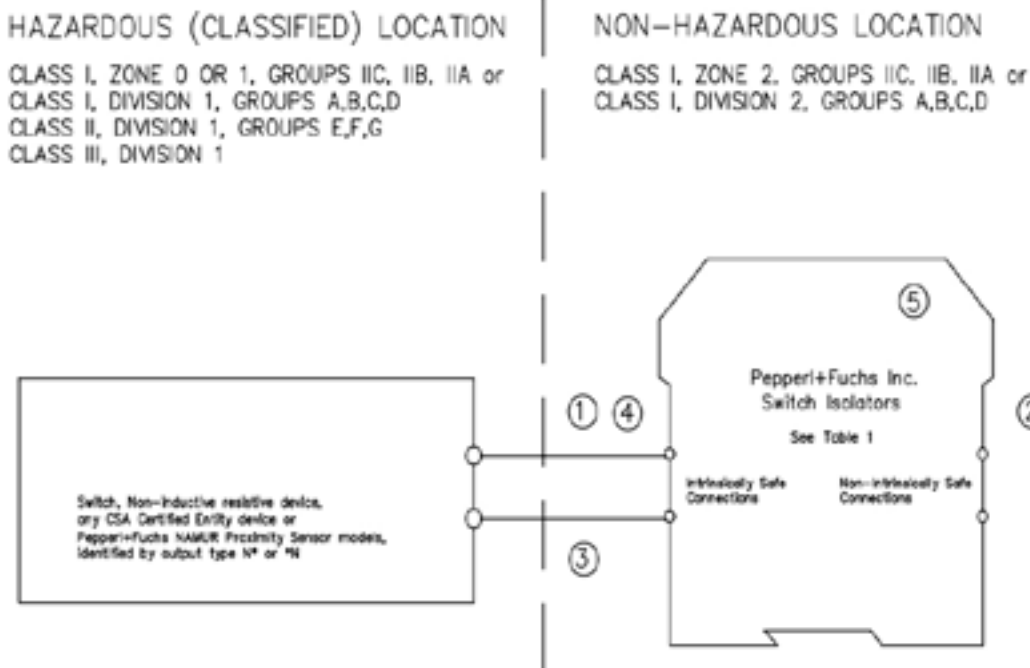

■ Notes

1. The intrinsically safe wiring must be installed in accordance with the Canadian Electrical Code CSA C22.1, Part 1, Appendix F
2. Barrier listed in the Table 1 shall not be connected to any device that uses or generate in excess of 250Vrms or DC unless it has been determined that the voltage is adequately isolated from the barrier. Barriers listed in Table 2 shall not be connected to any device that uses or generates in excess of 60Vrms or DC unless the voltage is limited by an adequate means
3. Any combination of up to 10 channels of the barriers listed in Table 1 or Table 2 may be connected in parallel and connected to a switch in a hazardous location.
4. The Entity concept allows interconnection of intrinsically safe apparatus with associated apparatus not specifically examined in combination as a system when the approved values of Voc and Isc for the associated apparatus are less than or equal to Vmax or Imax for the intrinsically safe apparatus and the approved values of Ca and La for the associated apparatus are greater than Ci + Ccable and Li + Lcable, respectively, for the intrinsically safe apparatus.
5. The following models with part number greater than 100000 are approved for mounting in Class I, Zone 2, Groups IIC, IIB and IIA or Class I, Division 2, Groups A,B,C,D hazardous (classified) location: KF**-SR2-EX1.W, KF**-SR2-EX1.W.LB, KF**-SR2-EX2.W, KF**-SR2-EX2.2S, KFD2-ST2-EX1.*, KFD2-ST2-EX2.*, KFD2-SOT2-EX1.*, KFD2-SOT2-EX2.*

WARNING: Substitution of components may impair intrinsic safety and suitability for use in Class I, Division 2 / Zone 2

AVERTISSEMENT - La substitution de composants peut compromettre la sécurité intrinsèque et l'adéquation à une utilisation en Classe I, Div. 2/Zone 2.

This document contains safety-relevant information. It must not be altered without the authorization of a NE EX		
	Only valid as long as released in EDM	date: 05-08-2015
	Control Drawing	116-0047K
	Switch Isolators	sheet 1 of 2
Global		

Entity Parameters

Table 1: Barrier Certified to CSA Standard C22.2 No. 157 (Um = 250 V)

Model Numbers	Terminals	System		ENTITY							
		Vmax(V)	Res. (Ω)	Uo Voc	Io Isc	Co(μF) GRPS			Lo(mH) GRPS		
						IIC A,B	IIB C,E,F,G	IIA D	IIC A,B	IIB C,E,F,G	IIA D
KFA5-SR2-Ex1.* KFA5-SR2-Ex2.* KFA6-SR2-Ex1.* KFA6-SR2-Ex2.* KFD2-SR2-Ex1.* KFD2-SR2-Ex2.*	1-3 2-3 4-6 5-6	12.6	650	12.9	19.8	1.273	3.820	10.18	84.88	298.7	744.4
KFA5-SOT2-Ex1.* KFA5-SOT2-Ex2.* KFA6-SOT2-Ex1.* KFA6-SOT2-Ex2.*	1-3 2-3 4-6 5-6	10.5	811	10.5	13.0	2.66	7.9	21.3	192	671	1000

Table 2: Barrier Certified to CSA Standard E79-11 (Um = 60 V)

Model Numbers	Terminals	Load Parameters							
		Uo (Voc)	Io (Isc)	Co(μF) GRPS			Lo(mH) GRPS		
				IIC A,B	IIB C,E,F,G	IIA D	IIC A,B	IIB C,E,F,G	IIA D
KFD2-SOT2-Ex1.* KFD2-SOT2-Ex2.* KFD2-ST2-Ex1.* KFD2-ST2-Ex2.*	1-3 2-3 4-6 5-6	10.5	13.0	2.66	7.9	21.3	192	671	1000

The values of Lo and Co listed in the table above are allowed if one of the following conditions is met:

- The total Li of the external circuit (excluding the cable) is < 1% of the Lo value or
- The total Ci of the external circuit (excluding the cable) is < 1% of the Co value.

The values of Lo and Co listed in the table above shall be reduced to 50% when both of the following conditions are met:

- the total Li of the external circuit (excluding the cable) is > 1% of the Lo value and
- the total Ci of the external circuit (excluding the cable) is > 1% of the Co value.

Note: the reduced capacitance of the external circuit (including cable) shall not be greater than 1uF for IIA, IIB and 600nF for IIC.

This document contains safety-relevant information. It must not be altered without the authorization of a NE EX

Only valid as long as released in EDM

date: 05-08-2015



Control Drawing

Switch Isolators

116-0047K

Global

sheet 2 of 2

10.8 Intrinsically safe NEPSI (China) certified RAMC (/NS1)

The RAMC with electronic transmitter (-E, -H or -J) with or without limit switches is certified as intrinsic safe unit with NEPSI approval.

Certificate Nr. : GYJ101551
 Type of protection : Intrinsically safe Ex ia
 Group : IIC
 Temperature Class : T6
 Ambient temperature : -25 °C ... +70 °C
 Safety relevant maximum values of electronic transmitter:
 Maximum voltage : $U_i = 30 \text{ V}$
 Maximum current : $I_i = 101 \text{ mA}$
 Maximum power : $P_i = 1.4 \text{ W}$
 Inner inductance : $L_i = 150 \mu\text{H}$
 Inner capacity : $C_i = 4.16 \text{ nF}$

Data of limit switches option /K1../K10:

The following table shows the maximum safety parameters for intrinsic safe limit switches according the certificate NEPSI GYJ03201X:

	Standard /K1../K3 Ex ia IIC T6		Fail Safe /K6../K10 Ex ia IIC T6	
	Type 2	Type 3	Type 2	Type 3
Ui [V]	16	16	16	16
Ii [mA]	25	52	25	52
Pi [mW]	64	169	64	169
Ci [nF]	150	150	30	30
Li [μH]	150	150	100	100
max. ambient temp. [°C] for T6	49	28	49	28
max. ambient temp. [°C] for T5	61	40	61	40
max. ambient temp. [°C] for T4 - T1	89	68	89	68

10.9 Intrinsically safe EAC (Russia, Belarus, Kazakhstan) certified RAMC (/GS1)

The RAMC with electronic transmitter (-E, -H or -J) with or without limit switches is certified as intrinsic safe unit with EAC approval.

Certificate Nr.	: RU C-DE.ГБ08.B.01183
Explosion proof	: 0Ex ia IIC T6 X
Ambient temperature	: -40 °C...+70 °C
Safety relevant maximum values of electronic transmitter :	
Maximum voltage	: $U_i = 30$ V
Maximum current	: $I_i = 101$ mA
Maximum power	: $P_i = 1.4$ W
Inner inductance	: $L_i = 150$ μ H
Inner capacity	: $C_i = 4.16$ nF

Data of limit switches option /K1.../K10:

The following table shows the maximum safety parameters for intrinsic safe limit switches according the EAC-certificate RU C-DE.ГБ05.B.01183:

	Standard /K1.../K3 0Ex ia IIC T6...T1 X		Fail Safe /K6.../K10 0Ex ia IIC T6...T1 X	
	Type 2	Type 3	Type 2	Type 3
Ui [V]	16	16	16	16
Ii [mA]	25	52	25	52
Pi [mW]	64	169	64	169
Ci [nF]	150	150	30	30
Li [μ H]	150	150	100	100
max. ambient temp. [°C] for T6	49	28	49	28
max. ambient temp. [°C] for T5	61	40	61	40
max. ambient temp. [°C] for T4 - T1	89	68	89	68

10.10 Intrinsically safe PESO (India) certified RAMC

Identification No.:

P333935/1

Option /KS1 must be selected.

Same data as ATEX-certified type (/KS1)

Please contact your Yokogawa representative regarding Peso certificate.

10.11 Flame proof and dust proof ATEX certified RAMC (/KF1)

10.11.1 Technical data

Certificate:

IBExU 05 ATEX 1086

Flame proof:

Ex db IIC T6 Gb

Dust proof:

Ex tb IIIC TX Db

Max. surface temperature TX :corresp. process temperature

Housing:

Painted aluminium casting, type 91

Output signal (with electronic transmitter -E, -H or -J):

4-20 mA (2- wire unit, 3- wire unit) ; 0-20 mA (3- wire unit)

Power supply (with electronic transmitter -E, -H or -J):

2- or 3- wire unit

Limit switches:

Options /K1 to /K10 possible

Ambient temperature:

-20 °C to 60 °C

Minimum process temperature:

-20°C

Threads for cable glands:

- M20x1.5 (standard)
- ½" NPT (option /A5)

Degree of protection:

IP66 / 67

Marking:

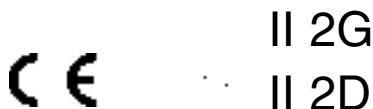

Temperature classification for gas application :

Temperature class	Standard	On extension (option /A16)	On extension (option /A16) and thermal insulation
T6	85 °C	85 °C	85 °C
T5	100 °C	100 °C	100 °C
T4	120 °C	135 °C	135 °C
T3	120 °C	200 °C	200 °C
T2	120 °C	300 °C	300 °C
T1	120 °C	370 °C	350 °C

10.11.2 Installation

For use in category 2G or 3G the electrical connections to the electronic transmitter and to the limit switches must be made via suitable cable glands and / or conduit systems that satisfy the requirements of EN 60079-1 sections 13.1 and 13.2 and for which a separate test certificate is available. The cables, cable glands and stopping plugs must be specified for an ambient temperature of 100 °C. Cable glands and entry fittings (screwed conduit entries) as well as stopping plugs of simple design may not be used. On connection of the RAMC /KF1 using a conduit entry approved for the purpose, the associated sealing facility must be arranged directly on the housing.

For use in category 2D or 3D the electrical connections to the electronic transmitter and to the limit switches must be made via suitable cable glands certified to the concerning dust category.

Unused openings shall be closed with certified stopping plugs in type of protection flame proof enclosure "d" (100 °C) or dust proof depending on the existing category.

Secure cable glands, stopping plugs and the safety screw for the cover against twisting.

For installation in areas with combustible dust EN 61241-17 must be considered.

CAUTION

The RAMC with option /KF1 shall be connected to the local equipollently grounding system. Therefore a grounding screw is available outside on the indicator housing and inside the indicator.

The electronic transmitter and the limit switches shall be wired as described in chapter 3.2.

10.11.3 Operation

If the cover of the indicator unit has to be opened, following instructions must be followed.

CAUTION

-
1. Switch off the power supply.
 2. Wait 15 minutes after power is turned off before opening the cover.
 3. The cover is fixed with a special screw.
 4. Be sure to lock the cover with special screw after tightening the cover.
 5. Before starting the operation again, be sure to lock the cover with the locking screw.
 6. Users are prohibited from making any modifications of specifications or physical configuration, such as adding or changing the configuration of external wiring ports.
-

WARNING

The instrument modification or parts replacement by other than authorized representatives of YOKOGAWA is prohibited and will void the certification.

WARNING

If the window of the cover is damaged the RAMC must be set out of operation.

10.12 Flame proof and dust proof IECEx certified RAMC (/EF1)

10.12.1 Technical data

Certificate :

IECEX IBE12.0007

Flame proof:

Ex db IIC T1-T6 Gb

Dust proof:

Ex tb IIIC TX Db

Max. surface temperature TX:corresp. process temperature

Housing:

Painted aluminium casting, type 91

Output signal (with electronic transmitter -E, -H or -J):

4-20 mA (2- wire unit, 3- wire unit) ; 0-20 mA (3- wire unit)

Power supply (with electronic transmitter -E, -H or -J):

2- or 3- wire unit

Limit switches:

Options /K1 to /K10 possible

Ambient temperature:

-20 °C to 60 °C

Minimum process temperature:

-20 °C

Threads for cable glands:

- M20x1.5 (standard)
- ½" NPT (option /A5)

Degree of protection:

IP66 / 67

Temperature classification for gas application:

Temperature class	Standard	On extension (option /A16)	On extension (option /A16) and thermal insulation
T6	85 °C	85 °C	85 °C
T5	100 °C	100 °C	100 °C
T4	120 °C	135 °C	135 °C
T3	120 °C	200 °C	200 °C
T2	120 °C	300 °C	300 °C
T1	120 °C	370 °C	350 °C

10.12.2 Installation

For use in category 2G or 3G the electrical connections to the electronic transmitter and to the limit switches must be made via suitable cable glands and / or conduit systems that satisfy the requirements of IEC 60079-1 and for which a separate test certificate is available. The cables, cable glands and stopping plugs must be specified for an ambient temperature of 100 °C. Cable glands and entry fittings (screwed conduit entries) as well as stopping plugs of simple design may not be used. On connection of the RAMC /EF1 using a conduit entry approved for the purpose, the associated sealing facility must be arranged directly on the housing.

For use in category 2D or 3D the electrical connections to the electronic transmitter and to the limit switches must be made via suitable cable glands certified to the concerning dust category.

Unused openings shall be closed with certified stopping plugs in type of protection flame proof enclosure "d" (100 °C) or dust proof depending on the existing category.

Secure cable glands, stopping plugs and the safety screw for the cover against twisting.



CAUTION

The RAMC with option /EF1 shall be connected to the local equipollently grounding system. Therefore a grounding screw is available outside on the indicator housing and inside the indicator.

The electronic transmitter and the limit switches shall be wired as described in chapter 3.2.

10.12.3 Operation

If the cover of the indicator unit has to be opened, following instructions must be followed.



CAUTION

1. Switch off the power supply.
 2. Wait 15 minutes after power is turned off before opening the cover.
 3. The cover is fixed with a special screw.
 4. Be sure to lock the cover with special screw after tightening the cover.
 5. Before starting the operation again, be sure to lock the cover with the locking screw.
 6. Users are prohibited from making any modifications of specifications or physical configuration, such as adding or changing the configuration of external wiring ports.
-



WARNING

The instrument modification or parts replacement by other than authorized representatives of YOKOGAWA is prohibited and will void the certification.



WARNING

If the window of the cover is damaged the RAMC must be set out of operation..

10.13 Intrinsically safe ATEX certified components in dust proof RAMC-housing (/KS2)

Certificate:

PTB 12 ATEX 2003 (Intrinsically safe electronic transmitter)
PTB 99 ATEX 2219X (Intrinsically safe limit switches) (Pepperl&Fuchs)
PTB 00 ATEX 2049X (Intrinsically safe fail safe limit switches) (Pepperl&Fuchs)
IBExU 05 ATEX 1086 (Dust proof RAMC)

Intrinsic safety:

Group II; category 2G
See chapter 10.1

Dust proof:

Group II; category 2D
See chapter 10.10

**CAUTION**

RAMC with /A5 (threads for cable gland 1/2" NPT) are delivered without cable glands. Please install suitable cable glands or blind stopper according to the dust category where the flowmeter is installed.

10.14 Intrinsically safe IECEx certified components in dust proof RAMC- housing (/ES2)

Certificate:

IECEX PTB12.0020 (Intrinsically safe electronic transmitter)
IECEX PTB11.0091X (Intrinsically safe limit switches) (Pepperl&Fuchs)
IECEX PTB11.0092X (Intrinsically safe fail safe limit switches) (Pepperl&Fuchs)
IECEX IBE12.0007 (Dust proof RAMC)

Intrinsic safety:

Group II; category 2G
See chapter 10.6

Dust proof:

Group II; category 2D
See chapter 10.10

**CAUTION**

RAMC with /A5 (threads for cable gland 1/2" NPT) are delivered without cable glands. Please install suitable cable glands or blind stopper according to the dust category where the flowmeter is installed.

10.15 Flame proof and dust proof NEPSI (China) certified RAMC (/NF1)

10.15.1 Technical data

Certificate:

GYJ071430

Flame proof:

Ex d IIC T6

Dust proof:

DIP A20 TA T1 - T6 IP67

Max. surface temperature

TA: corresponding process temperature

Housing:

Painted aluminium casting type 91

Output signal (with electronic transmitter-E, -H or -J):

4-20 mA (2- wire unit, 3- wire unit) ; 0-20 mA (3- wire unit)

Power supply (with electronic transmitter -E, -H or -J):

2- or 3- wire unit

Limit switches:

Options /K1 to /K10 possible

Ambient temperature:

-20 °C to 60 °C

-20 °C to 55 °C (for use in zone 20)

Minimum process temperature:

-20 °C

Threads for cable glands:

- M16x1.5 (standard)

- ½" NPT (option /A5)

Temperature classification for gas application:

see chapter 10.10

10.15.2 Installation

For use in category 2G or 3G the electrical connections to the electronic transmitter and to the limit switches must be made via suitable cable glands and / or conduit systems that satisfy the requirements of IEC 60079-1 and for which a separate test certificate is available. The cables, cable glands and stopping plugs must be specified for an ambient temperature of 100 °C. Cable glands and entry fittings (screwed conduit entries) as well as stopping plugs of simple design may not be used. On connection of the RAMC /NF1 using a conduit entry approved for the purpose, the associated sealing facility must be arranged directly on the housing.

For use in category 2D or 3D the electrical connections to the electronic transmitter and to the limit switches must be made via suitable cable glands certified to the concerning dust category.

Unused openings shall be closed with certified stopping plugs in type of protection flame proof enclosure "d" (100 °C) or dust proof depending on the existing category.

Secure cable glands, stopping plugs and the safety screw for the cover against twisting.

**CAUTION**

The RAMC with option /NF1 shall be connected to the local equipollently grounding system. Therefore a grounding screw is available outside on the indicator housing and inside the indicator.

The electronic transmitter and the limit switches shall be wired as described in chapter 3.2.

10.15.3 Operation

If the cover of the indicator unit has to be opened, following instructions must be followed.



CAUTION

1. Switch off the power supply.
2. Wait 15 minutes after power is turned off before opening the cover.
3. The cover is fixed with a special screw.
4. Be sure to lock the cover with special screw after tightening the cover.
5. Before starting the operation again, be sure to lock the cover with the locking screw.
6. Users are prohibited from making any modifications of specifications or physical configuration, such as adding or changing the configuration of external wiring ports.



WARNING

The instrument modification or parts replacement by other than authorized representatives of YOKOGAWA is prohibited and will void the certification.



WARNING

If the window of the cover is damaged the RAMC must be set out of operation.

10.16 Flame proof EAC (Russia, Belarus, Kazakhstan) certified RAMC (/GF1)

10.16.1 Technical data

Certificate:

RU C-DE.ГБ08.B.01183

Explosion proof:

1Ex d IIC T1...T6

Housing:

Painted aluminium casting type 91

Output signal (with electronic transmitter -E, -H or -J):

4–20 mA (2- wire unit, 3- wire unit) ; 0-20 mA (3- wire unit)

Power supply (with electronic transmitter -E, -H or -J):

2- or 3- wire unit

Limit switches:

Options /K1 to /K10 possible

Ambient temperature:

-20 °C to 60 °C

Minimum process temperature:

-20 °C

Threads for cable glands:

- M16x1.5 (standard)
- ½" NPT (option /A5)

Temperature classification for gas application:

see chapter 10.10

10.16.2 Installation

see 10.10.2

10.16.3 Operation

see 10.10.3

10.17 ATEX registered non-electrical RAMC (/KC1)

10.17.1 Technical data

Applicable Standards:

EN 13463-1: 2009

Archive No.:

IBEXU 099/15

Explosion proof:

II 2GD IIC TX

TX = max. surface temperature determined by the process temperature

Ambient temperature:

-25 °C to +90 °C

-40 °C to +90 °C with option /A26

Process temperature:

see chapter 9.5

Heat tracing:

same as process temperature

**NOTE**

The maximum surface temperature depends on the process temperature and for meters with option /T1 to /T6 additional on the heat tracing temperature.

Protection:

IP66/67

10.17.2 Safety Instructions

Identified hazards:

- flammable products inside tube
- static electricity

**WARNING**

Operation with flammable products is only permitted as long as no explosive mixture builds up on the inside of the flowmeter under operating conditions. The operator is responsible for ensuring that the flowmeter is operated safely as regards the temperature and pressure of the products used. In case of operation with flammable products the measuring units must be included in the periodic pressure tests of the system.

If conductive fluids are used with stainless steel as material of wetted parts the Rotameter must be connected to the potential equalization.

If conductive fluids are used with Teflon as material of wetted parts use a medium with minimum conductivity of 1nS/m.

**CAUTION**

1. Supply grounding connection by the process connections or earthing terminal.
2. In hazardous areas, only operate the indicator with a closed cover.
3. Ignition risks caused by process pressure surges, impact or friction must be avoided.
4. Use of the equipment is not permitted in areas where the following occur: processes that generate strong charges, machine grinding and separation processes, electronic spraying (e.g. near electrostatic painting systems) or pneumatically conveyed dust.

10.17.3 Marking

Archive no. IBEXU 99/15_E1
II 2GD IIC TX
T_{amb.} -25 °C to +90 °C

10.18 EAC certified non-electrical RAMC (/GC1)

10.18.1 Technical data

Applicable Standards:

EN 13463-1: 2009

Certificate number:

RU C-DE.ГБ08.B.001183

Explosion proof:

II 2GD IIC TX

TX = max. surface temperature determined by the process temperature

Ambient temperature:

-25 °C to +90 °C

-40 °C to +90 °C with option /A26

Process temperature:

see chapter 9.5

Heat tracing:

same as process temperature



NOTE

The maximum surface temperature depends on the process temperature and for meters with option /T1 to /T6 additional on the heat tracing temperature.

Protection:

IP66/67

10.18.2 Safety Instructions

Identified hazards:

- flammable products inside tube
- static electricity



WARNING

Operation with flammable products is only permitted as long as no explosive mixture builds up on the inside of the flowmeter under operating condition. The operator is responsible for ensure that the flowmeter is operated safely as regards the temperature and pressure of the products used. In case of operation with flammable products the measuring units must be included in the periodic pressure tests of the system.

If conductive fluids are used with stainless steel as material of wetted parts the Rotameter must be connected to the potential equalization.

If conductive fluids are used with Teflon as material of wetted parts use a medium with minimum conductivity of 1nS/m.



CAUTION

1. Supply grounding connection by the process connections or earthing terminal.
2. In hazardous areas, only operate the indicator with a closed cover.
3. Ignition risks caused by process pressure surges, impact or friction must be avoided.
4. Use of the equipment is not permitted in areas where the following occur: processes that generate strong charges, machine grinding and separation processes, electron spraying (e.g. near electrostatic painting systems) or pneumatically conveyed dust.

10.18.3 Marking

Certificate No. RU C-DE.ГБ08.B.01183

IIC TX

T_{amb.} -40 °C to +90 °C

10.19 Flame proof and dust proof RAMC with Taiwan Safety Label

Registration Document:

ML041200702782

Option /EF1 must be selected.

Same data as IECEx-certified type (/EF1)

For export to Taiwan please contact your Yokogawa representative regarding Taiwan Safety Label.

10.20 Flame proof and dust proof PESO (India) certified RAMC

Identification No.:

P209233/1

Option /KF1 must be selected.

Same data as ATEX-certified type (/KF1)

Please contact your Yokogawa representative regarding Peso certificate.

Blank Page

11. Instructions for PED

RAMC is produced according the determinations of directive 2014/68/EU (Directive for Pressure Equipment PED). The units are classified as pipe according article 4 number c), letter, i) first dash or according diagram 6 after appendix II:

Classification as pipe

For Fluid Group 1 and 2 (article 13 chapter (1)); For fluid group 2 with a max. partial pressure of 1.5bar at Tmax. Medium liquid and gas

The basic safety requests (for design, production and testing) for all units according to category I to III are generally determined for the requests of category III. The units, which are not included by PED, article 4 paragraph 3, are checked by a conformity-valuation–method according appendix III “module H”

The complete quality assurance system according PED appendix III module H was certified by the notified body:

Lloyd's Register Verification Limited, 71 Fenchurch Street London EC3M 4BS UK

ID-No. 0038



IMPORTANT

The user is responsible for the use of our flowmeters regarding suitability and use as agreed.

PED-Data on RAMC

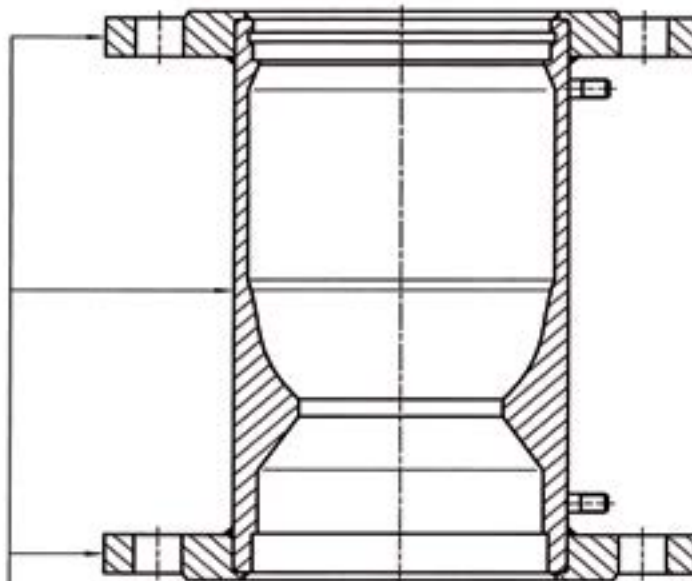

Marking	Example
Cone	e.g. 82
Material	1.4404 / AISI 316L
Flowdirection	←
made by	RY
CE marking	CE 0038
Charge	e.g. ch. 123456
Commissioning No.	e.g. Kom.Nr. 20000
nominal size	e.g. DN 100
nominal pressure	e.g. PN 40
year of production	e.g. 2002
temperature data	e.g. TS-180°C/+370 see Instruction Manual

F110.EPS

Dependence of the permissible max. effective pressure of the operating temperature:

The pressure relevant temperature limits of the RAMC are: -200...370 °C for units made from 1.4571/1.4404.
-80...130 °C for units made from PTFE.

These limits are reduced by metrological boundary conditions. (see temperature curves and table).

Process connection			Process temperature									
			-196 °C	RT (20 °C)	50 °C	100 °C	150 °C	200 °C	250 °C	300 °C	350 °C	370 °C
A1	Flange ASME 150lbs		19 bar	19 bar	18.4 bar	16.2 bar	14.8 bar	13.7 bar	12.1 bar	10.2 bar	8.4 bar	7.4 bar
A2	Flange ASME 300lbs		49.6 bar	49.6 bar	48.1 bar	42.2 bar	38.5 bar	35.7 bar	33.4 bar	31.6 bar	30.3 bar	29.9 bar
A3	Flange ASME 600lbs		99.3 bar	99.3 bar	96.2 bar	84.4 bar	77 bar	71.3 bar	66.8 bar	63.2 bar	60.7 bar	59.8 bar
D2	Flange EN PN16		16 bar	16 bar	15.6 bar	14.2 bar	12.8 bar	11.7 bar	10.9 bar	10.3 bar	9.9 bar	9.6 bar
D4	Flange EN PN40		40 bar	40 bar	39.1 bar	35.6 bar	32 bar	29.3 bar	27.2 bar	25.8 bar	24.7 bar	24 bar
D5	Flange EN PN63		63 bar	63 bar	61.6 bar	56 bar	50.4 bar	46.2 bar	42.8 bar	40.6 bar	38.9 bar	37.8 bar
D6	Flange EN PN100		100 bar	100 bar	97.8 bar	88.9 bar	80 bar	73.3 bar	68 bar	64.4 bar	61.8 bar	60 bar
R4/T4	Internal Thread	RAMC01...	25 bar	25 bar	25 bar	25 bar	20 bar	20 bar	20 bar	20 bar	-----	-----
R4/T4	Internal Thread	RAMC23...	25 bar	25 bar	25 bar	25 bar	20 bar	20 bar	20 bar	20 bar	-----	-----
R4/T4	Internal Thread	RAMC02...	16 bar	16 bar	16 bar	16 bar	16 bar	16 bar	16 bar	16 bar	-----	-----
R4/T4	Internal Thread	RAMC03...	16 bar	16 bar	16 bar	16 bar	16 bar	16 bar	16 bar	16 bar	-----	-----
R4/T4	Internal Thread	RAMC05...	10 bar	10 bar	10 bar	10 bar	10 bar	10 bar	10 bar	10 bar	-----	-----
R4/T4	Internal Thread	RAMC06...	10 bar	10 bar	10 bar	10 bar	10 bar	10 bar	10 bar	10 bar	-----	-----
G6/T6	Internal Thread	RAMC01...	40 bar	40 bar	40 bar	40 bar	40 bar	40 bar	40 bar	40 bar	-----	-----
G6/T6	Internal Thread	RAMC23...	40 bar	40 bar	40 bar	40 bar	40 bar	40 bar	40 bar	40 bar	-----	-----
G6/T6	Internal Thread	RAMC02...	40 bar	40 bar	40 bar	40 bar	40 bar	40 bar	40 bar	40 bar	-----	-----
G6/T6	Internal Thread	RAMC03...	40 bar	40 bar	40 bar	40 bar	40 bar	40 bar	40 bar	40 bar	-----	-----
G6/T6	Internal Thread	RAMC06...	40 bar	40 bar	40 bar	40 bar	40 bar	40 bar	40 bar	40 bar	-----	-----
			Process temperature									
			-196 °C	RT (20 °C)	50 °C	100 °C	140 °C	see corresponding standard for the connection				
S2	Clamp. DIN 11851	RAMC02...		40 bar	40 bar	40 bar	40 bar					
S2	Clamp. DIN 11851	RAMC05...		25 bar	25 bar	25 bar	25 bar					
S2	Clamp. DIN 11851	RAMC06...		25 bar	25 bar	25 bar	25 bar					
S2	Clamp. DIN 11851	RAMC08...		25 bar	25 bar	25 bar	25 bar					
S2	Clamp. DIN 11851	RAMC10...		25 bar	25 bar	25 bar	25 bar					
S2	Clamp. DIN 11851	RAMC12...		16 bar	16 bar	16 bar	16 bar					
			Process temperature									
			-196 °C	RT (20 °C)	50 °C	100 °C	150 °C	see corresponding standard for the connection				
S4	Clamp	RAMC02...		16 bar	16 bar	16 bar	16 bar					
S4	Clamp	RAMC03...		16 bar	16 bar	16 bar	16 bar					
S4	Clamp	RAMC04...		16 bar	16 bar	16 bar	16 bar					
S4	Clamp	RAMC05...		16 bar	16 bar	16 bar	16 bar					
S4	Clamp	RAMC06...		10 bar	10 bar	10 bar	10 bar					
S4	Clamp	RAMC10...		10 bar	10 bar	10 bar	10 bar					
S5	Rosista Flange	RAMC02...		10 bar	see corresponding standard for the connection							
S5	Rosista Flange	RAMC04...		10 bar								

For special connections with Z-No. other values may be valid.

The data are marked on the flowmeter.

Special connection	Process temperature									
	-196 °C	RT (20 °C)	50 °C	100 °C	150 °C	200 °C	250 °C	300 °C	350 °C	370 °C
Flange ASME > 300lbs	100 %	100 %	94.20 %	83.30 %	75.80 %	69.50 %	64.30 %	60.80 %	58.00 %	56 %
Flange EN PN...	100 %	100 %	97.70 %	89 %	80 %	73.20 %	68 %	64.50 %	61.70 %	60 %
Other connections *)	100 %	100 %	97.70 %	89 %	80 %	73.20 %	68 %	64.50 %	61.70 %	60 %

*) The figures relate only to the connection on the meter. Further restrictions by gaskets and customer connected parts are to be considered separately.

Change of the process connections:

The flanges change from

DIN 2526 facing form C into
DIN-EN 1092-1 facing form B1

The connection measurements of the flanges remain the same. That means that DIN and EN fit one to another.

The facing of the flanges has changed. This may effect the gaskets.

Operation reductions:

The operator is responsible, that no corrosion and/or erosion is caused by the medium, which reduces the safety of the unit as pressure vessel. In addition one has to take care, that no decomposition of unstable fluids may happen. Corrosion and erosion make the unit fail and can lead to the endangering of persons and facilities. If corrosion and erosion are possible, this has to be checked by control at the removed unit.

Note	In the following only the dangers, which may appear with the pressure load of the unit, are considered. In connection with the accompanying electronics additional risks may appear, which requires corresponding precautions. Also precautions to reach the measuring precision are not considered.		
	Endangering by:	Description	Remarks
Medium	Surface temperature	Surface temperature is hot in case of high process temperature. It is the sole responsibility of the user to establish proper means to prevent touching of the measuring tube.	
	max. / min. process temperature	see chapter 9.3 and 11	
	max. process pressure	see chapter 9.3 and 11	
	Tightness of the wetted, PED relevant volume	A factory test is done before delivery	
	Corrosion and erosion effects	It is the sole responsibility of the user to select proper wetted materials for the medium intended to use (see chapter 11)	
	Life time evaluation	Experience shows that the lifetime of the measuring tube within the allowed operation conditions is more than 10 years.	Without erosion and corrosion.
	Temperature shock	Permanent temperature cycles of more than 100°C temp. difference have to be avoided. Tube failure can occur because of material wearing.	
Installation	Instable fluids	If instable fluids are transported it is the sole responsibility of the user that in case of decomposition the design limits are not exceeded. (see chapter 11)	
	Process pressure / temp. relation	see chapter 11	
	Piping and support forces	see chapter 2.3 and 3.1	
	Choice of gaskets and pre-stress of the process connections	It is the sole responsibility of the user to select suitable gaskets and to screw the process connections with the necessary torques.	Refer to EN 1591 -1
	Use of closing and openings	see chapter 2.3	
	Pressure shock, water hammer and pressure surges	Dynamical exceeding of the given max. pressure at process temp. has to be avoided.	Water hammer can lead to tube failures.
	Filling and emptying of the pipe work	The measuring tube is part of a pipe work. The pipe work has to be filled slowly (see chapter 4.2)	
	Disposal, cleaning and return	see chapter 1.1	
	Flow direction of the unit	upwards	
	Installation position of the unit	see chapter 2.2 and 3.1	A wrong installation position gives only measuring disturbances
Outer influence	Pipe stress by weight of the instrument	see chapter 9.4, table 9.6 through 9.10	
	Permitted ambient conditions (temperature, humidity)	see chapter 2.2 and 9.3	
	External fire	External fire can result in - Rise in pressure by temperature - Damage of gaskets It is in the sole responsibility of the user to implement suitable means to prevent large damage in the case of fire.	The instrument itself does not contain flammable materials.
	Earthquake resistance	- Damage of the mounting screws	Check by user

T111.EPS

The following usages of the instruments are not permitted:

- use as climbing aid (e.g during assembling work on pipe system)
- use as support for external load (e.g. support for piping) or tray surface for heavy tools (e.g. during piping work)
- Material removal by any kind of machining (e.g. drilling, sawing etc.)
- Painting of the name-plate/scale
- Brazing or welding of parts to the instrument
- Any repair, modification or supplements or the installation of spare-parts is only permitted if it is done in accordance to this instruction manual. Other work must be agreed by YOKOGAWA beforehand. YOKOGAWA will not take over any liability for damages caused by unauthorized work on the instrument or prohibited usage of the instrument.

Blank Page

APPENDIX 1. SOFTWARE CHANGE HISTORY

Table A1-1 Software Change History for electronic transmitter without HART - Communication

Release date	Material number ¹⁾	Index ¹⁾	SW Rev ²⁾	Changes	Instruction Manual
24.10.1996	16-8039	B	1.00	Initial Firmware	IM 1R1B2-E-H ed. 1
03.12.1996	16-8039	C	1.10	Angle adjustment improved	IM 1R1B2-E-H ed. 1
25.03.1997	16-8039	D	1.20	Measuring range changed	IM 1R1B2-E-H ed. 1
08.08.1997	16-8039	E	1.30	Totalizer value saving debugged	IM 1R1B2-E-H ed. 1
20.10.1997 11.11.1997	16-8039	F G	1.40	Totalizer saving concept improved	IM 1R1B2-E-H ed. 1
03.08.1998	16-8039	I	1.50	Pulse output as option implemented	IM 1R1B2-E-H ed. 2
21.10.1998	16-8039	J	1.60	Support of new micro controller	IM 1R1B2-E-H ed. 2
16.02.1999	16-8039	K	1.70	Float- Blocking- Detection function implemented	IM 1R1B2-E-H ed. 2
11.12.2001	16-8040	C	2.00	Support of new micro controller	IM 1R1B2-E-H ed. 3
07.03.2002	16-8040	E	2.20	3- wire version improved	IM 1R1B2-E-H ed. 4
07.11.2002	16-8040	G	2.30	Temperature measurement implemented	IM 1R1B2-E-H ed. 5
06.09.2007 11.01.2011 21.05.2013	512-16-8040	H 1 2	2.50	Support of new COG display	IM 01R01B02-00E-E ed. 9

¹⁾ on label of electronic transmitter

²⁾ in software parameter F61: display e.g. F2.50, see also chapter 6.2.10

Table A1-2 Software Change History for electronic transmitter with HART 5 - Communication

Release date	Material number ¹⁾	Index ¹⁾	SW Rev ²⁾	DD Rev ³⁾	Changes	Instruction Manual
05.12.2001	16-8041	C	2.10	Rev 01, DD 01	HART Communication added, Basic HART function implemented	IM 1R1B2-E-H ed. 3
27.03.2003 01.12.2003	16-8041	F G	3.00	Rev 01, DD 02	Enhanced HART Functionality, support of Float- Blocking- Detection and diagnosis function	IM 1R1B2-E-H ed. 5
06.09.2007	16-8041	H	4.00		Support of new COG display	IM 01R01B02-00E-E ed. 9
11.01.2011 21.05.2013 28.06.2016	512-16-8041	1 2 3	5.00		Support of new HART modem chip	IM 01R01B02-00E-E ed. 9

¹⁾ on label of electronic transmitter

²⁾ in HART - Parameter „Detailed Setup / Device information / Revision #’s / FW Rev.”: xx (e.g. xx = 5), see also chapter 7.4.4

³⁾ in HART - Communicator

Table A1-3 Software Change History for electronic transmitter with HART 7 - Communication

Release date	Material number ¹⁾	Index ¹⁾	SW Rev ²⁾	DD Rev ³⁾	Changes	Instruction Manual
18.04.2016	M3811HY	8	1.30	Dev Rev 10 DD Rev 01	HART 7 functionality added	IM 01R01B02-00E-E ed. 14

¹⁾ on label of electronic transmitter

²⁾ in HART - Parameter „Detailed Setup / Device information / RAMC firmware rev.” : Vx.xx (e.g.Vx.xx = V1.30), see also chapter 7.6.4

³⁾ in HART - Communicator

Blank Page

APPENDIX 2. Safety Instrumented Systems Installation

WARNING
 The contents of this appendix are cited from exida.com safety manual on the Rotameter RAMC Flowmeter specifically observed for the safety transmitter purpose. When using the RAMC for Safety Instrumented Systems (SIS) application, the instructions and procedures in this section must be strictly followed in order to preserve the meter for that safety level.

A2.1 Scope and Purpose

This document provides an overview of the user responsibilities for installation and operation of the Rota Yokogawa RAMC variable area flow meter in order to maintain the designed safety level. Items that will be addressed are proof testing, repair and replacement of the flow meter, reliability data, lifetime, environmental and application limits, and parameter settings.

A2.2 Using RAMC for a SIS Application

A2.2.1 Safety Function

Suitable for use in Safety Instrumented Systems are the versions listed in table A2.1 only. The safety related data listed in this manual does not apply to other versions of RAMC.

Table A2.1 Versions of RAMC suitable for Safety Instrumented Systems

[V1]	RAMC with fail safe inductive limit switches
[V2]	RAMC with standard inductive limit switches

Table 1 Versions of RAMC suitable for Safety Instrumented Systems

This variable area flow meter is intended for use as a volume flow monitoring component in a Safety Instrumented System. It has either fail safe inductive limit switches [V1] or standard inductive limit switches [V2]. The flow meter may be used with the limit switches to feed signals to a logic solver that is part of the safety instrumented function (SIF) as shown in Figure A2.1. The fault annunciation mechanism is a trip of one of the limit switches [V1] or [V2].

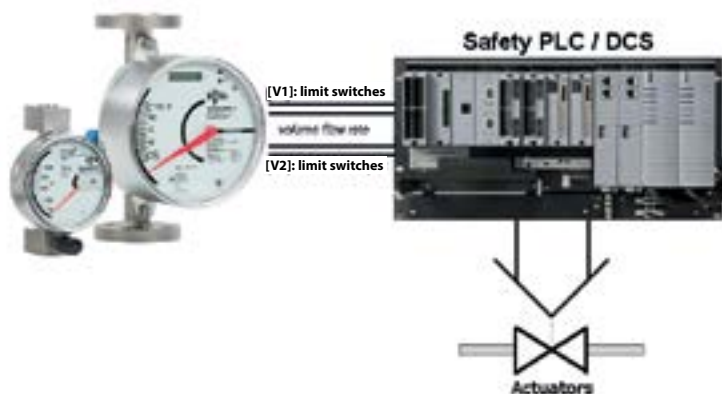

Figure A2.1 Example Safety Instrumented Function

A2.2.2 Diagnostic Response Time

[V1] or [V2]: The limit switch will go to its safe fail state immediately.

A2.2.3 Setup

A setup of the flow meter is not required. Installation shall be done according to the manual.

A2.2.4 Proof Testing

The objective of proof testing is to detect failures within the flow meter that are not detected by the diagnostics of the flow meter. Of main concern are undetected failures that prevent the safety instrumented function from performing its intended function.

The frequency of the proof tests (or the proof test interval) is to be determined in the reliability calculations for the safety instrumented functions for which the flow meter is applied. The actual proof tests must be performed more frequently or as frequently as specified in the calculation in order to maintain required safety integrity of the safety instrumented function.

The following tests need to be specifically executed when a proof test is performed. The results of the proof test need to be documented and this documentation should be part of a plant safety management system. Failures that are detected should be reported to Yokogawa.

Proof test for variable area flow meter RAMC with inductive limit switches

Step	Action
1	Take appropriate action to avoid a false trip
2	Inspect the device for any visible damage, corrosion or contamination
3	Force the variable area flow meter RAMC to reach a defined "MAX" threshold value and verify that the inductive limit switch goes into the safe state.
4	Force the variable area flow meter RAMC to reach a defined "MIN" threshold value and verify that the inductive limit switch goes into the safe state
5	Restore the loop to full operation
6	Restore normal operation

When all the tests listed above are executed a proof test coverage of approximately 99% of possible DU failures in the variable area flow meter RAMC can be claimed.

The following tools need to be available to perform proof testing:

- Measurement instrument to verify output status [V1] or [V2]

The person(s) performing the proof test of the Yokogawa RAMC variable area flow meter should be trained in SIS operations including bypass procedures, flow meter maintenance and company management of change procedures.

A2.2.5 Repair and replacement

Maintenance information can be found in section 8, Maintenance of the User's Manual Model RAMC Short Stroke ROTAMETER, IM 01R01B02-00E-E.

If repair is to be performed with the process online the Rota Yokogawa RAMC variable area flow meter will need to be bypassed during the repair. The user should setup appropriate bypass procedures for that. Contact the Yokogawa sales office if this instrument requires repair

The person(s) performing the repair and / or replacement of the Rota Yokogawa RAMC variable area flow meter should have a sufficient skill level.

A2.2.6 Startup Time

The flow meter will generate a valid signal within 3 seconds of power-on startup with the default 1 second dampening time. Increasing the configurable dampening time adds to the startup time.

A2.2.7 Reliability data

A detailed Failure Mode, Effects, and Diagnostics Analysis (FMEDA) report is available from Rota Yokogawa with all failure rates and failure modes. Rota Yokogawa RAMC variable area flow meter is intended for use in a Low Demand Mode. Low Demand Mode means the average interval between dangerous conditions occurs infrequently.

The Rota Yokogawa RAMC variable area flow meter is suitable for application in safety functions up to and including SIL2 for use in a simplex (1oo1) configuration, depending on the PFDAVG calculation of the entire Safety Instrumented Function.

A2.2.8 Lifetime limits

The expected lifetime of the Yokogawa Rota Yokogawa RAMC variable area flow meter is 10 years. The reliability data listed in A2.2.8 is only valid for this period. The failure rates of the Rota Yokogawa RAMC variable area flow meter may increase sometime after this period. Reliability calculations based on the data listed in A2. 2.8 for Rota Yokogawa RAMC variable area flow meter lifetimes beyond 10 years may yield results that are too optimistic, i.e. the calculated Safety Integrity Level will not be achieved.

A2.2.9 Environmental limits

The environmental limits of Rota Yokogawa RAMC variable area flow meter are specified in the User's Manual, Model RAMC Short Stroke ROTAMETER IM 01R01B02-00E-E.

A2.2.10 Application limits

The application limits of the Rota Yokogawa RAMC variable area flow meter are specified in the User's Manual, Model RAMC Short Stroke ROTAMETER, IM 01R01B02-00E-E. If the flow meter is used outside of the application limits the reliability data listed in A2.2.9 becomes invalid.

A2.3 Definitions and Abbreviations

A2.3.1 Definitions

Safety Freedom from unacceptable risk of harm

Functional Safety The ability of a system to carry out the actions necessary to achieve or to maintain a defined safe state for the equipment / machinery / plant / apparatus under control of the system

Basic Safety The equipment must be designed and manufactured such that it protects against risk of damage to persons by electrical shock and other hazards and against resulting fire and explosion. The protection must be effective under all conditions of the nominal operation and under single fault condition

Verification The demonstration for each phase of the life-cycle that the (output) deliverables of the phase meet the objectives and requirements specified by the inputs to the phase. The verification is usually executed by analysis and / or testing:

Validation The demonstration that the safety-related system(s) or the combination of safety-related system(s) and external risk reduction facilities meet, in all respects, the Safety Requirements Specification. The validation is usually executed by testing

Safety Assessment The investigation to arrive at a judgment - based on evidence - of the safety achieved by safety-related systems

Further definitions of terms used for safety techniques and measures and the description of safety related systems are given in IEC 61508-4.

A2.3.2 Abbreviations

FMEDA Failure Mode, Effects and Diagnostic Analysis

SIF Safety Instrumented Function

SIL Safety Integrity Level

SIS Safety Instrumented System

SLC Safety Lifecycle

A2.4 Assessment results

A2.4.1 Safety related parameters

The following results have been obtained from the assessment report Report No.: ROTA YOKOGAWA 05/04-20 R001 Version V5, Revision R0; May 2014 issued by exida.

Average PFD values have been calculated considering a proof test coverage of 99 %, a mission time of 10 years and a Mean Time To Restoration of 24 hours.

Table A2.2: Summary for RAMC ([V1]) with fail-safe limit switches ³ – Failure rates

	Profile 3
Fail Safe Detected (λ_{SD})	0 FIT
Fail Safe Undetected (λ_{SU})	45 FIT
Fail Dangerous Detected (λ_{DD})	10 FIT
Fail Dangerous Undetected (λ_{DU})	35 FIT
SFF ⁴	
	61 %
MTBF	
	530 years
SIL AC ⁵	
	SIL2

Safety metrics according to ISO 13849-1 ⁶:

MTTF_d (years)	2556
DC	23 %
Category (CAT)	CAT 1
Performance Level (required)	PL _r = c
Performance Level (calculated)	3.45E-08 1/h

T[Proof] = 1 year	T[Proof] = 5 years	T[Proof] = 10 years
PFD _{AVG} = 1.65E-04	PFD _{AVG} = 7.63E-04	PFD _{AVG} = 1.51E-03

Table A2.3: Summary for RAMC ([V2]) with standard limit switches ⁷ – Failure rates

	Profile 3
Fail Safe Detected (λ_{SD})	0 FIT
Fail Safe Undetected (λ_{SU})	45 FIT
Fail Dangerous Detected (λ_{DD})	10 FIT
Fail Dangerous Undetected (λ_{DU})	73 FIT
SFF ⁴	
	42 %
MTBF	
	401 years
SIL AC ⁵	
	SIL1

Safety metrics according to ISO 13849-1 ⁶:

MTTF_d (years)	1371
DC	12 %
Category (CAT)	CAT 1
Performance Level (required)	PL _r = c
Performance Level (calculated)	7.32E-08 1/h

T[Proof] = 1 year	T[Proof] = 5 years	T[Proof] = 10 years
PFD _{AVG} = 3.49E-04	PFD _{AVG} = 1.62E-03	PFD _{AVG} = 3.20E-03

³ The switching contact output is connected to a fail-safe NAMUR amplifier (e.g. Pepperl+Fuchs KF**·SH-Ex1). The failure rates of the amplifier are not included in the listed failure rates

⁴ The complete sensor subsystem will need to be evaluated to determine the overall Safe Failure Fraction. The number listed is for reference only.

⁵ SIL AC (architectural constraints) means that the calculated values are within the range for hardware architectural constraints for the corresponding SIL but does not imply all related IEC 61508 requirements are fulfilled.

⁶ Depending on the application and possible external diagnostics a higher DC_o and therefore also a higher category might be possible to achieve.

⁷ The switching contact output is connected to a standard switching amplifier (e.g. Pepperl+Fuchs KF**·SR2-Ex*.W). The failure rates of the amplifier are not included in the listed failure rates.

Blank Page

REGISTERED TRADEMARKS

Rotameter™ is a trademark of Rota Yokogawa GmbH & Co. KG, a subsidiary of Yokogawa Electric Corporation, Japan.
In the United Kingdom Rotameter™ is a trademark of Emerson Electric Co.

HART® : Registered trademark of HART Communication Foundation, Austin, TX, USA
TRI-CLAMP® : Registered trademark of Ladish & Co., Inc., Kenosha, USA



YOKOGAWA ELECTRIC CORPORATION

Headquarters

2-9-32, Nakacho, Musashino-shi, Tokyo, 180-8750 JAPAN
Phone : 81-422-52-5555

Branch Sales Offices

Osaka, Nagoya, Hiroshima, Kurashiki, Fukuoka, Kitakyusyu

YOKOGAWA CORPORATION OF AMERICA

Head Office

12530 West Airport Blvd, Sugar Land, Texas 77478, USA
Phone : 1-281-340-3800 Fax : 1-281-340-3838

Georgia Office

2 Dart Road, Newnan, Georgia 30265, USA
Phone : 1-800-888-6400/ 1-770-253-7000 Fax : 1-770-254-0928

YOKOGAWA AMERICA DO SUL LTDA.

Praca Acapulco, 31 - Santo Amaro, São Paulo/SP, BRAZIL, CEP-04675-190
Phone : 55-11-5681-2400 Fax : 55-11-5681-4434

YOKOGAWA EUROPE B. V.

Euroweg 2, 3825 HD Amersfoort, THE NETHERLANDS
Phone : 31-88-4641000 Fax : 31-88-4641111

YOKOGAWA ELECTRIC CIS LTD.

Grokholskiy per 13 Building 2, 4th Floor 129090, Moscow, RUSSIA
Phone : 7-495-737-7868 Fax : 7-495-737-7869

YOKOGAWA CHINA CO., LTD.

3F Tower D Cartelo Crocodile Building, No.568 West Tianshan Road,
Shanghai 200335, CHINA
Phone : 86-21-62396262 Fax : 86-21-62387866

YOKOGAWA ELECTRIC KOREA CO., LTD.

(Yokogawa B/D, Yangpyeong-dong 4-Ga), 21, Seonyu-ro 45-gil, Yeongdeungpo-gu,
Seoul, 150-866, KOREA
Phone : 82-2-2628-6000 Fax : 82-2-2628-6400

YOKOGAWA ENGINEERING ASIA PTE. LTD.

5 Bedok South Road, Singapore 469270, SINGAPORE
Phone : 65-6241-9933 Fax : 65-6241-2606

YOKOGAWA INDIA LTD.

Plot No.96, Electronic City Complex, Hosur Road, Bangalore - 560 100, INDIA
Phone : 91-80-4158-6000 Fax : 91-80-2852-1442

YOKOGAWA AUSTRALIA PTY. LTD.

Tower A, 112-118 Talavera Road, Macquarie Park NSW 2113, AUSTRALIA
Phone : 61-2-8870-1100 Fax : 61-2-8870-1111

YOKOGAWA MIDDLE EAST & AFRICA B.S.C.(C)

P.O. Box 10070, Manama, Building 577, Road 2516, Busaiten 225, Muharraq,
Kingdom of BAHRAIN
Phone : 973-17358100 Fax : 973-17336100

Apr. '15