

SD 01C50C03-01E

Unit: mm (approx. inch)

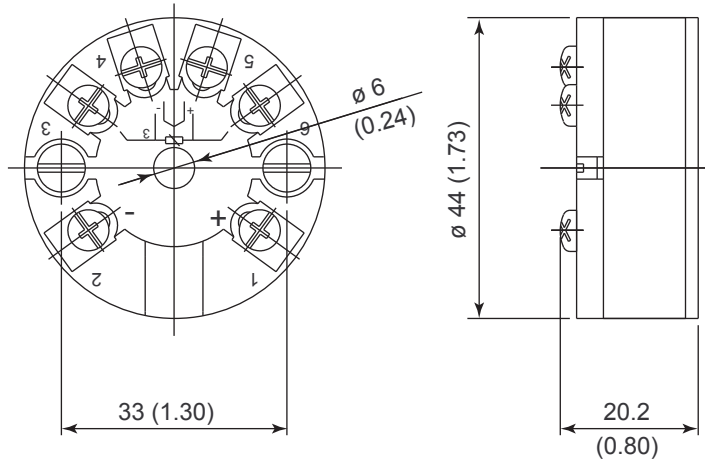

● Sensor Connections

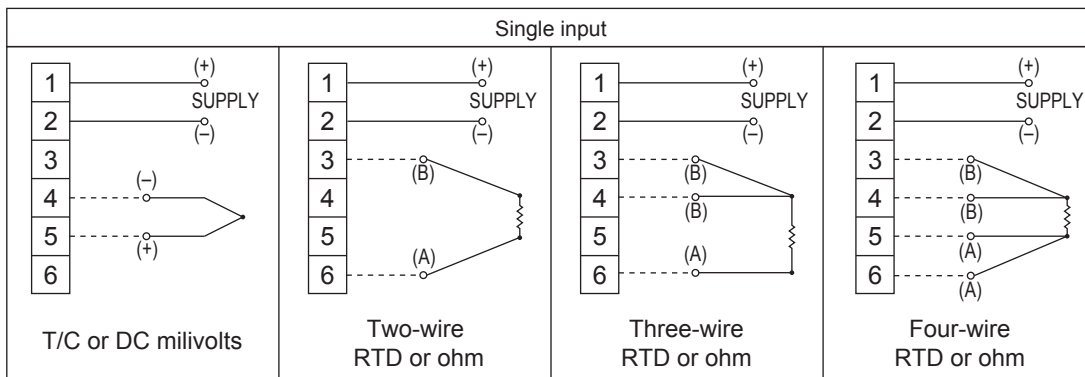

- Weight
50 g (0.11 lbs.)