

MC100
Pneumatic Pressure Standard
USER'S MANUAL

Product Registration

Thank you for purchasing YOKOGAWA products.

YOKOGAWA provides registered users with a variety of information and services. Please allow us to serve you best by completing the product registration form accessible from our website.

<http://tmi.yokogawa.com/>

Thank you for purchasing the Pneumatic Pressure Standard MC100.

This User's Manual contains useful information about the functions, operating procedure, and handling precautions of the Pneumatic Pressure Standard. To ensure correct use, please read this manual thoroughly before operation.

Keep this manual in a safe place for quick reference in the event a question arises.

Notes

- The contents of this manual are subject to change without prior notice as a result of continuing improvements to the instrument's performance and functions.
- Every effort has been made in the preparation of this manual to ensure the accuracy of its contents. However, should you have any questions or find any errors, please contact your nearest YOKOGAWA dealer as listed on the back cover of this manual.
- Copying or reproducing all or any part of the contents of this manual without YOKOGAWA's permission is strictly prohibited.

Trademarks

- MS-DOS is a registered trademark of Microsoft Corporation.
- Other company and product names are trademarks or registered trademarks of their respective holders.

Revisions

1st Edition:	June 2000
2nd Edition:	October 2017
3rd Edition:	September 2018
4th Edition:	August 2019

Checking the Contents of the Package

Unpack the box and check the contents before operating the instrument. If some of the contents are not correct or missing or if there is physical damage, contact the dealer from which you purchased them.

MC100

The model name and other information are written on the name plate located on the rear panel of the instrument (see the figure below). Check that your order is correct with the code table below. When inquiring about the product, please quote the model name, suffix code, and instrument number (NO.).

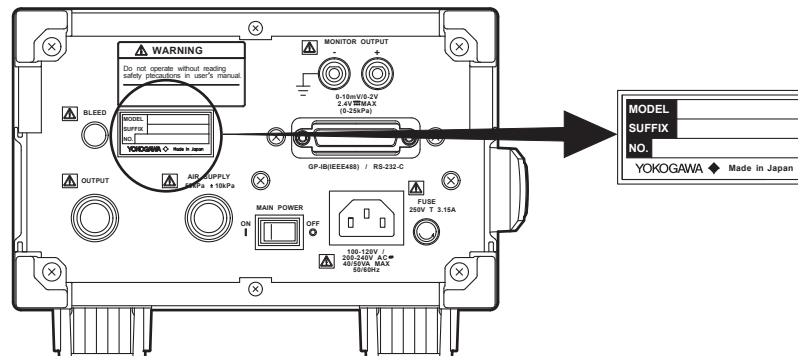

MODEL (Model name)

Model Code	Notes
767401	Output range: 0 to 25 kPa
767402	Output range: 0 to 200 kPa

SUFFIX (Suffix code)

Suffix Code	Specifications
Pressure unit	-U1 Displayed unit: kPa
	-U2 Displayed unit: kPa, kgf/cm ² , mmH ₂ O, and mmHg
	-U3 Displayed unit: kPa, psi, inH ₂ O, and inHg
Communication	-C1 GP-IB interface
	-C2 Serial (former EIA-232 (RS-232)) interface
I/O connection section	-P1 Rc1/4
	-P2 1/4NPT internal thread
Power cord ¹	-D UL/CSA Standard Power Cord (Maximum Rated Voltage: 125 V, Maximum Rated Current: 7 A)
	-F VDE Standard Power Cord (Maximum Rated Voltage: 250 V, Maximum Rated Current: 10 A)
	-R AS Standard Power Cord (Maximum Rated Voltage: 250 V, Maximum Rated Current: 10 A)
	-Q BS Standard Power Cord (Maximum Rated Voltage: 250 V, Maximum Rated Current: 5 A)
	-H GB Standard Power Cord (complies with the CCC) (Maximum Rated Voltage: 250 V, Maximum Rated Current: 10 A)
	-N Brazilian Standard Power Cord (Maximum Rated Voltage: 250 V, Maximum Rated Current: 10 A)
	-T Taiwanese Standard Power Cord (Maximum Rated Voltage: 125 V, Maximum Rated Current: 10 A)
	-B Indian Standard Power Cord (Maximum Rated Voltage: 250 V, Maximum Rated Current: 10 A)
	-U IEC Plug Type B Power Cord (Maximum Rated Voltage: 250 V, Maximum Rated Current: 7 A)
	-Y No Power Cord Included. ²

¹ Make sure that the attached power cord meets the designated standards of the country and area that you are using it in.

² Prepare a power cord that complies with the standard specified by the country or region that the instrument will be used in.

Note

We recommend you keep the packing box. The box is useful when you need to transport the instrument.

Standard Accessories

The following standard accessories are supplied with the instrument. Check that all contents are present and that they are undamaged. If you detect any problems, contact your nearest YOKOGAWA dealer.

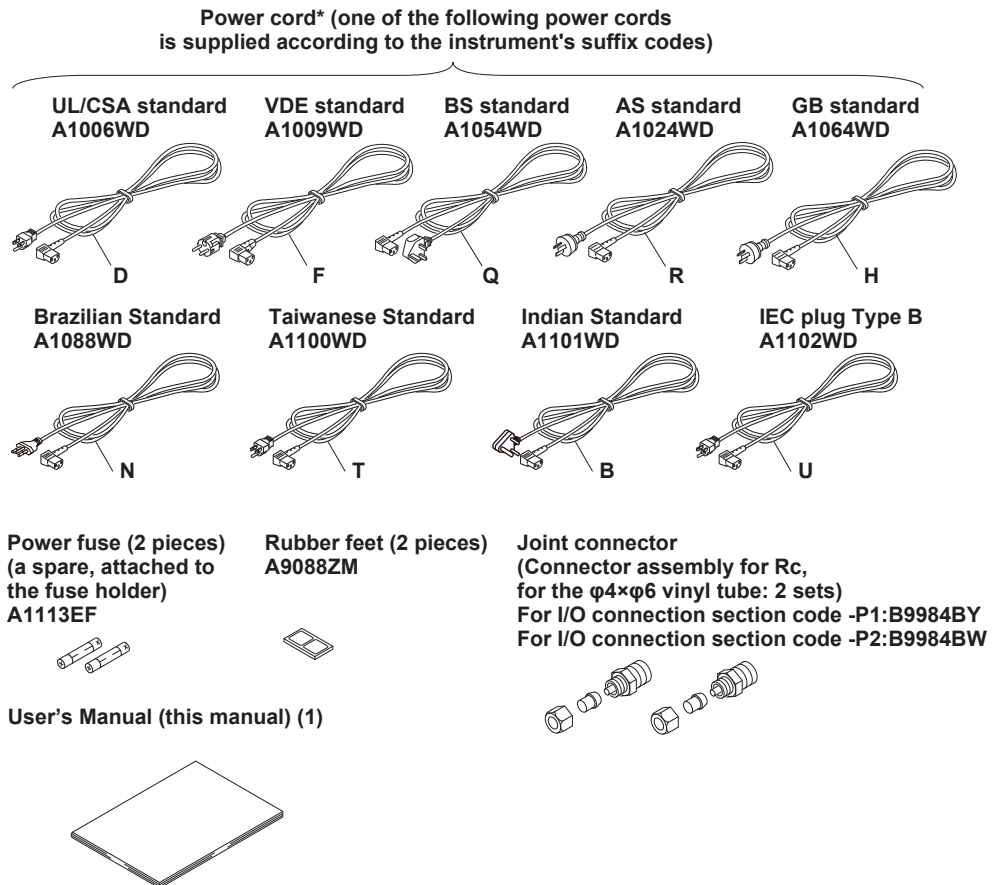

Standard accessories are not covered by warranty of this instrument.

* Make sure that the attached power cord meets the designated standards of the country and area that you are using it in. If the suffix code is -Y, a power cord is not included.

Checking the Contents of the Package

Optional Accessories

The following optional accessories are available for purchase separately. When you receive the order, check that all contents are present and that they are undamaged. For information and ordering, contact your nearest YOKOGAWA dealer.

Part Name	Part Number	Quantity
Connector assembly for Rc (for the $\phi 4 \times \phi 6$ vinyl tube) (For I/O connection section code -P1)	B9984BY	1
Connector assembly for Rc (for the $\phi 4 \times \phi 6$ vinyl tube) (For I/O connection section code -P2)	B9984BW	1
Simple connector assembly (for the $\phi 4 \times \phi 6$ vinyl tube)	B9310ZH	1
Adapter (JIS, R1/4-Rc1/8)	G9612BG	1
Adapter (ANSI, R1/4-1/4NPT internal thread)	G9612BJ	1
Adapter (ANSI, R1/4-1/8NPT internal thread)	G9612BW	1

Optional accessories (sold separately) are not covered by warranty of this instrument.

**Connector assembly for Rc
for the $\phi 4 \times \phi 6$ vinyl tube: 2 sets**
For I/O connection section code -P1: B9984BY
For I/O connection section code -P2: B9984BW

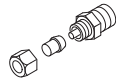

**Simple connector assembly
B9310ZH**

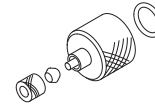

**Adapter (JIS)
G9612BG**



**Adapter (ANSI)
G9612BJ**



**Adapter (ANSI)
G9612BW**



關於在台灣銷售

This section is valid only in Taiwan.

關於在台灣所販賣的符合其相關規定的電源線 A1100WD 的限用物質含量信息，請至下麵的網址進行查詢

<https://tmi.yokogawa.com/support/service-warranty-quality/product-compliance/>

Safety Precautions

This product is designed to be used by a person with specialized knowledge.

This instrument is an IEC safety class I instrument (provided with terminal for protective earth grounding).

The general safety precautions described herein must be observed during all phases of operation. If the instrument is used in a manner not specified in this manual, the protection provided by the instrument may be impaired.

This manual is part of the product and contains important information. Store this manual in a safe place close to the instrument so that you can refer to it immediately. Keep this manual until you dispose of the instrument.

YOKOGAWA assumes no liability for the customer's failure to comply with these requirements.

For your safety, the following symbols are used on this instrument.



"Handle with care." (To avoid injury, death, or damage to the instrument, the operator must refer to the explanation in the User's Manual or Service Manual.)



"Functional ground terminal." Do not use this terminal as a protective ground terminal.



Alternating current



DC



ON (power)



OFF (power)



ON (power) state



OFF (power) state

French



À manipuler délicatement. Toujours se reporter aux manuels d'utilisation et d'entretien. Ce symbole a été apposé aux endroits dangereux de l'instrument pour lesquels des consignes spéciales d'utilisation ou de manipulation ont été émises. Le même symbole apparaît à l'endroit correspondant du manuel pour identifier les consignes qui s'y rapportent.



Borne de terre ou borne de terre fonctionnelle (ne pas utiliser cette borne comme prise de terre.)



Courant alternatif



Courant direct



Marche (alimentation)



Arrêt (alimentation)



Marche



Arrêt

Make sure to comply with the following safety precautions. Not complying might result in injury or death.

WARNING

- **Use the Instrument Only for Its Intended Purpose**

This instrument is designed to output the pressure. Use this instrument only as a pressure output.
- **Check the Physical Appearance**

Do not use the instrument if there is a problem with its physical appearance.
- **Use the Correct Power Supply**

Make sure that the power supply voltage matches the instrument's rated supply voltage and that it does not exceed the maximum voltage range of the power cord to use.
- **Use the Correct Power Cord and Plug**

To prevent the possibility of electric shock or fire, be sure to use the power cord for the instrument. The main power plug can only be plugged into an outlet with a protective grounding terminal. Do not invalidate this protection by using an extension cord without protective earth grounding. Further, do not use this power cord with other instruments.
- **Connect the Protective Grounding Terminal**

Make sure to connect the protective earth to prevent electric shock before turning on the power. The power cord that you can use for the instrument is a three-prong cord. Connect the power cord to a properly grounded three-prong outlet.
- **Do Not Impair the Protective Grounding**

Never cut off the internal or external protective earth wire or disconnect the wiring of the protective earth terminal. Doing so may result in electric shock or damage to the instrument.
- **Do Not Use When the Protection Functions Are Defective**

Before using this instrument, check that the protection functions, such as the protective grounding and fuse, are working properly. If you suspect a defect, do not use the instrument.
- **Fuse**

To avoid fire, only use a fuse that has a rating (current, voltage, and type) that is specified by the instrument. When replacing the fuse, turn OFF the power switch and remove the power cord from the outlet beforehand. Do not use a fuse that is outside the specifications or short the fuse holder.
- **Do Not Operate in an Explosive Atmosphere**

Do not operate the instrument in the presence of flammable gasses or vapors. Doing so is extremely dangerous.
- **Restrictions on the fluids that can be used**
 - Do not apply gases that are flammable, explosive, poisonous, or corrosive or gases at high-temperature to the pipe section.
 - Liquids cannot be used with this instrument.
- **Restrictions on the input pressure**

Applying a pressure exceeding the prescribed allowable input can damage the instrument. In addition, the applied pressure may be passed on to the device that is connected to the output connector, and cause secondary accidents.

- **Do Not Remove the Covers or Disassemble or Alter the Instrument**
Only qualified YOKOGAWA personnel may remove the covers and disassemble or alter the instrument. The inside of the instrument is dangerous because parts of it have high voltages.
 - **External connection**
Connect the protective grounding before connecting to the item under measurement or to an external control unit.
-

French

AVERTISSEMENT

- **Utilisez l'instrument uniquement pour son usage prévu**
Cet instrument est conçu pour produire une pression. Utilisez cet instrument uniquement comme sortie de pression.
- **Inspecter l'apparence physique**
Ne pas utiliser l'instrument si son intégrité physique semble être compromise.
- **Vérifier l'alimentation**
Assurez-vous que la tension d'alimentation correspond à la tension d'alimentation nominale de l'appareil et qu'elle ne dépasse pas la plage de tension maximale du cordon d'alimentation à utiliser.
- **Utiliser le cordon d'alimentation et la fiche adaptés**
Pour éviter tout risque de choc électrique, utiliser exclusivement le cordon d'alimentation prévu pour cet instrument. La fiche doit être branchée sur une prise secteur raccordée à la terre. En cas d'utilisation d'une rallonge, celle-ci doit être impérativement reliée à la terre. Par ailleurs, ne pas utiliser ce cordon d'alimentation avec d'autres instruments.
- **Brancher la prise de terre**
Avant de mettre l'instrument sous tension, penser à brancher la prise de terre pour éviter tout choc électrique. Le cordon d'alimentation que vous utilisez pour l'instrument est un cordon à trois broches. Brancher le cordon d'alimentation sur une prise de courant à trois plots et mise à la terre.
- **Ne pas entraver la mise à la terre de protection**
Ne jamais neutraliser le fil de terre interne ou externe, ni débrancher la borne de mise à la terre. Cela pourrait entraîner un choc électrique ou endommager l'instrument.
- **Ne pas utiliser lorsque les fonctions de protection sont défectueuses**
Avant d'utiliser l'instrument, vérifier que les fonctions de protection, telles que le raccordement à la terre et le fusible, fonctionnent correctement. En cas de dysfonctionnement possible, ne pas utiliser l'instrument.
- **Fusible**
Pour éviter un incendie, veillez à utiliser un fusible avec les valeurs nominales spécifiées (courant, tension et type). Avant de remplacer le fusible, tournez le commutateur POWER et le commutateur MAIN POWER sur OFF et débranchez le cordon d'alimentation. N'utilisez pas de fusible autre que celui spécifié. Ne court-circuitiez pas non plus le porte-fusible.
- **Ne pas utiliser dans un environnement explosif**
Ne pas utiliser l'instrument en présence de gaz ou de vapeurs inflammables. Cela pourrait être extrêmement dangereux.

- **Des restrictions sur les liquides peuvent être utilisées**
 - N'appliquez pas de gaz inflammables, explosifs, toxiques ou corrosifs, ni de gaz à haute température sur la section du tuyau.
 - Les liquides ne peuvent pas être utilisés avec cet instrument.
 - **Limite de pression**

Appliquer une pression dépassant l'entrée autorisée préconisée peut endommager l'instrument. En outre, la pression appliquée peut être transmise à l'appareil branché au connecteur de sortie, et provoquer des accidents secondaires.
 - **Ne pas retirer le capot, ni démonter ou modifier l'instrument**

Seul le personnel YOKOGAWA qualifié est habilité à retirer le capot et à démonter ou modifier l'instrument. Certains composants à l'intérieur de l'instrument sont à haute tension et par conséquent, représentent un danger.
 - **Connexion externe**

Branchez correctement la mise à la terre protectrice avant de brancher l'élément à mesurer ou l'unité de commande.
-

How to Use This Manual

Structure of the Manual

This User's Manual consists of the following 6 chapters and an appendix.

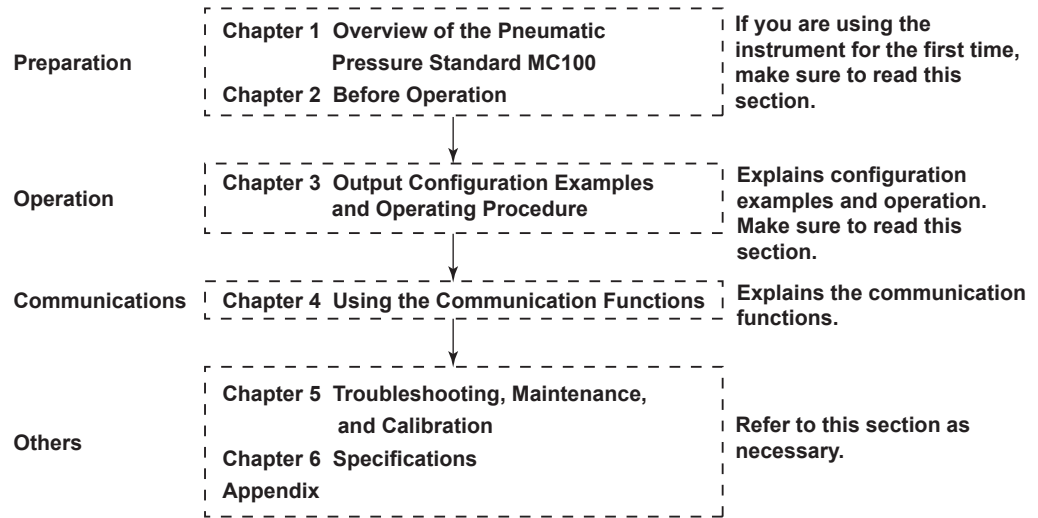

Conventions

Symbols

The following symbols are used in this manual.



A symbol mark affixed to the instrument. Indicates danger to personnel or instrument and the operator must refer to the User's Manual. The symbol is used in the User's Manual to indicate the reference.

WARNING

Calls attention to actions or conditions that could cause serious or fatal injury to the user, and precautions that can be taken to prevent such occurrences.

CAUTION

Calls attention to actions or conditions that could cause light injury to the user or damage to the instrument or user's data, and precautions that can be taken to prevent such occurrences.

French

AVERTISSEMENT

Attire l'attention sur des gestes ou des conditions susceptibles de provoquer des blessures graves (voire mortelles), et sur les précautions de sécurité pouvant prévenir de tels accidents.

ATTENTION

Attire l'attention sur des gestes ou des conditions susceptibles de provoquer des blessures légères ou d'endommager l'instrument ou les données de l'utilisateur, et sur les précautions de sécurité susceptibles de prévenir de tels accidents.

Note

Provides important information for the proper operation of the instrument.





Symbols used on pages in which operating procedures are given.

On pages that describe the operating procedures in Chapter 2 through 4, the following symbols are used to distinguish the procedures from their explanations.

Explanation	Describes the details of the settings and the restrictions that exist with the operating procedure.
Example	Indicates configuration examples when operating the MC100.
Procedure	Carry out the procedure according to the step numbers. The procedure is given with the premise that the user is carrying out the procedure for the first time. Therefore, if you are modifying the settings, you may not need to carry out all the steps.

In this manual, pressure units that are not specifically noted signify gauge pressure.

Contents

Checking the Contents of the Package.....	ii
Safety Precautions.....	v
How to Use This Manual.....	ix
Chapter 1 Overview of the Pneumatic Pressure Standard MC100	
1.1 Operating Principles	1-1
1.2 Functions	1-2
1.3 Outline of the Operation.....	1-3
1.4 Names and Function of Parts	1-4
Chapter 2 Before Operation	
2.1 Precautions on the Use of the Instrument	2-1
2.2 Installation.....	2-2
 2.3 Connecting the Power Supply	2-3
2.4 Turning ON/OFF the Power Switch	2-5
 2.5 Pressure Output Preparation.....	2-8
2.6 Setting the Pressure Display Unit, Output Pressure, Divider Ratio and Turning ON/OFF the Pressure Output.....	2-11
2.7 Setting the Load Capacity.....	2-13
2.8 Setting the Interval.....	2-14
2.9 Alarm Function.....	2-15
 2.10 Monitor Output.....	2-17
2.11 Turning ON/OFF the Beep Sound	2-19
2.12 Output Monitor and Offset Monitor	2-20
Chapter 3 Output Configuration Examples and Operating Procedure	
3.1 Manual Output (Divider Output).....	3-1
3.2 Auto-Step Output.....	3-2
3.3 Sweep Output.....	3-4
3.4 Repeating the Output.....	3-14
3.5 Holding the Output.....	3-15
Chapter 4 Using the Communication Functions	
4.1 GP-IB Interface	4-1
4.2 Serial (RS-232) Interface.....	4-4
4.3 Communication Commands	4-11
4.4 Description of Commands	4-12
4.5 Sample Program.....	4-19
Chapter 5 Troubleshooting, Maintenance, and Calibration	
5.1 Troubleshooting	5-1
 5.2 Storing the MC100 and Replacing the Fuse.....	5-3
5.3 Calibration.....	5-5
5.4 Recommended Replacement Parts.....	5-6

Chapter 6 Specifications

6.1 Specifications.....6-1
6.2 Dimensional Drawings.....6-3

Appendix

Appendix 1 Calibrating a Pneumatic Industrial Instrument..... App-1
Appendix 2 ASCII Character Codes..... App-2
Appendix 3 Communication Format..... App-3

Index

1.1 Operating Principles

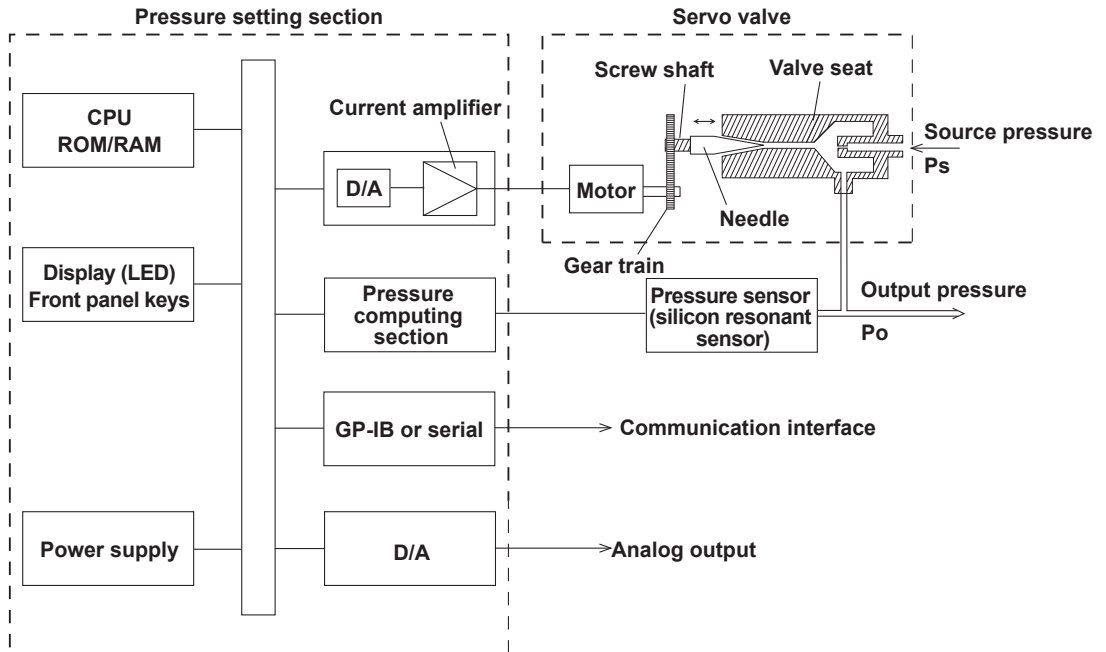

The MC100 is a pressure servo system comprised of a pressure setting section, a needle-type servo valve, and a silicon resonant sensor.

The pressure setting section computes the command value that is to be passed to the motor based on the pressure value specified through the operation keys or communication commands and the pressure value derived by the pressure computing section. The value is converted into an electric signal by the D/A converter. The electric signal passes through the current amp to drive the motor.

The servo valve consists of a needle valve, a valve seat, and a drive mechanism that includes the motor and gear train. Part of the pneumatic supply pressure (P_s) escapes through the gap between the needle valve and the valve seat. The motor rotation is speed-reduced and transmitted to the screw shaft by the gear train. Then, screw shaft rotation causes the needle valve to move in the direction indicated by the arrow in the above figure so as to vary the cross-sectional area between the needle valve and valve seat, thereby controlling output pneumatic pressure (P_o). Part of the output pneumatic pressure enters the pressure sensor and is fed back to the pressure computing section above.

If the output pressure is greater than the specified pressure, the pressure setting section controls the motor so that the cross-sectional area of the needle valve is decreased, and vice versa. In other words, the pressure setting section controls the motor so that the difference between the specified pressure and the output pressure is reduced to zero. Consequently, stable output pressure corresponding to the specified value can be obtained.

1.2 Functions

Pressure Output

The MC100 has three pressure output modes.
You can switch the mode only when the output is turned OFF.

- **Manual output mode (divider output)**

The output pressure range, from 0 to the specified value, is equally divided into any number from 1 to 20 (m divisions) and an arbitrary pressure (n level) is output continuously.

The output mode is reset to manual output mode when pressure output is turned OFF with the **OUTPUT key** or when the MC100 is turned ON.

- **Auto-step output mode**

The divider output equal to $(n/m \times \text{the specified pressure})$ is automatically output in a specified step pattern using specified intervals.

The value of n is the start step (the initial pressure when the output is started).

The MC100 outputs different levels of pressure in the following order: n/m (start) $\rightarrow (n+1)/m \rightarrow \dots \rightarrow m/m$ (maximum output) $\rightarrow \dots \rightarrow (n-1)/m \rightarrow n/m$ (end). You can use the repeat function to repeat the auto-step output.

- **Sweep output mode**

In this mode, pressure output changes from 0% to 100% or 100% to 0% of the specified pressure within the specified interval. You can use the repeat function to repeat the sweep output.

Zero Calibration

Compensates the influence received from the varying environment in order to maintain the accuracy of the pressure output.

Alarm

Lights the ALARM indication LED and turns OFF the pressure output, if abnormal source pressure is detected during operation.

Monitor Output

Outputs voltage signals in accordance with the pressure setting condition (up to the maximum setting).

Communication Function

Provides remote control and data output via the specified interface (GP-IB or serial (former EIA-232 (RS-232))).

1.3 Outline of the Operation

The following flow chart shows the operation of the MC100.

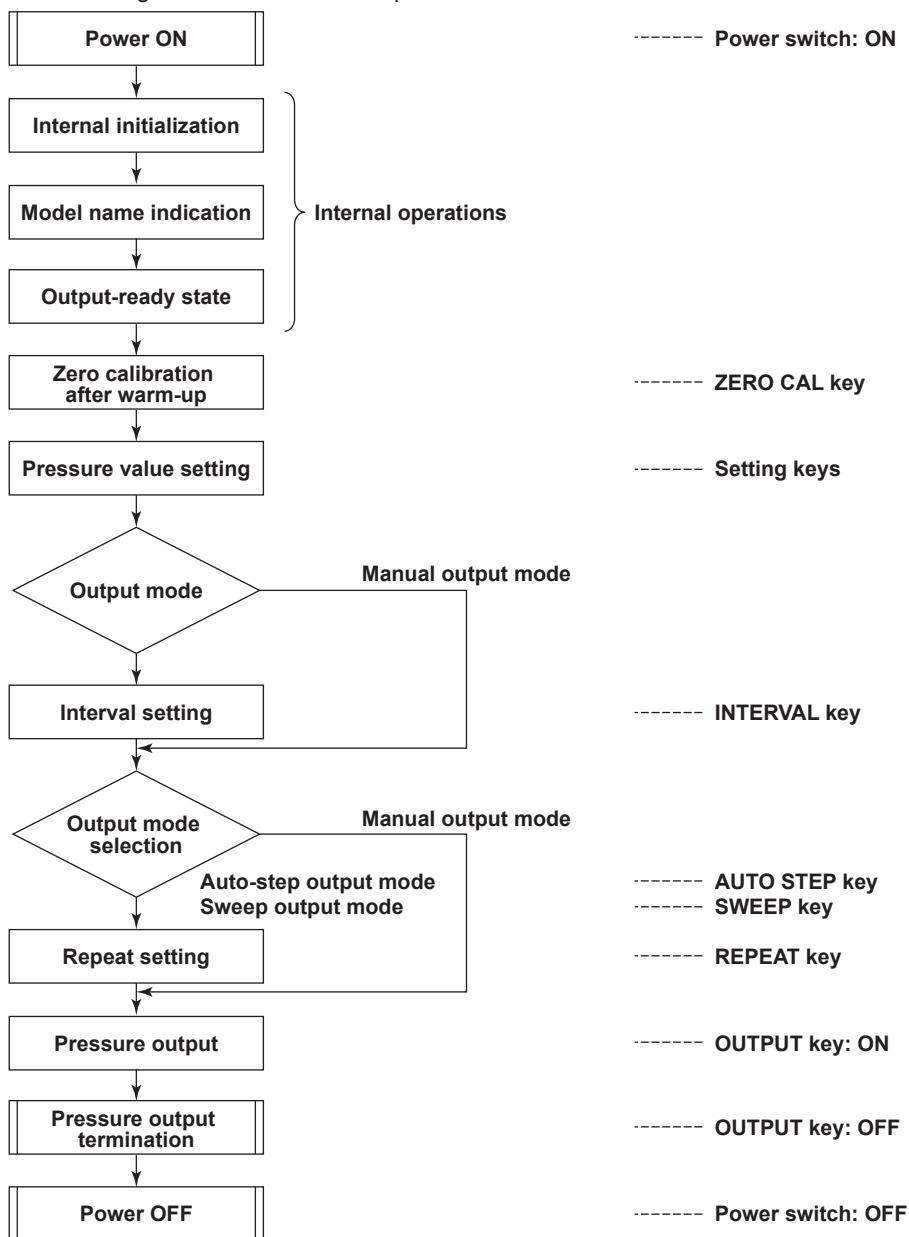

1.4 Names and Function of Parts

Front Panel

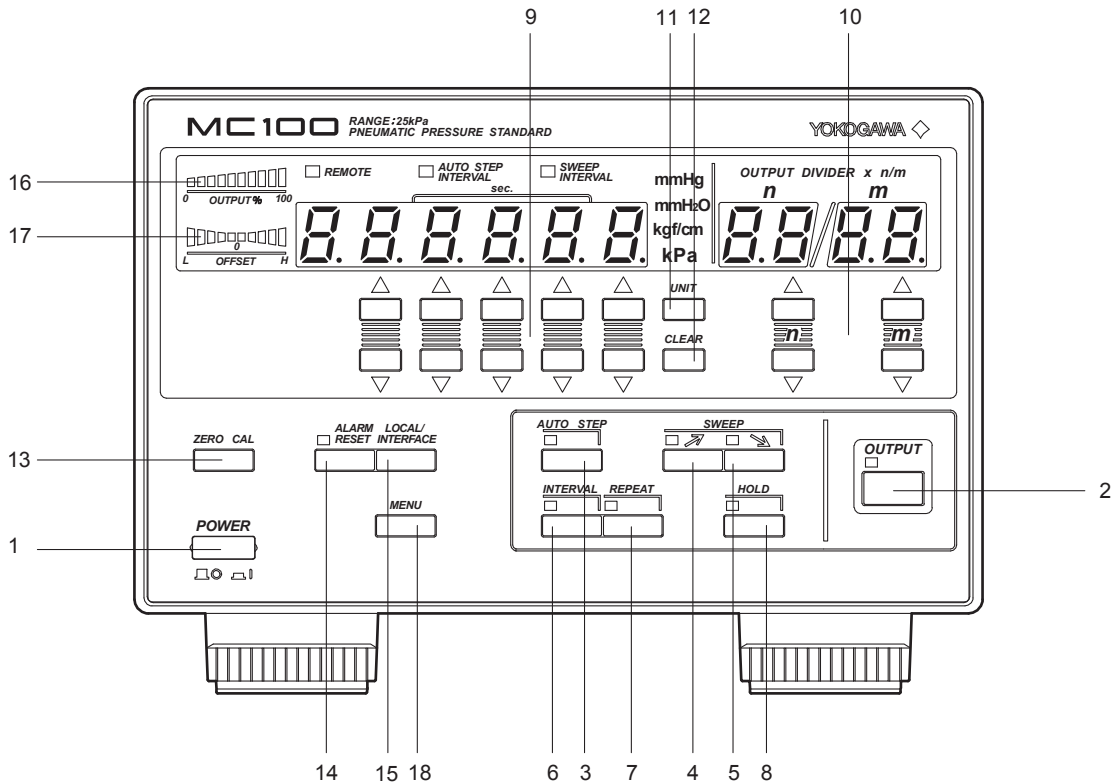

- 1 Power switch**
Switch used to turn ON/OFF the power.
- 2 OUTPUT key**
Key used to turn ON/OFF the pressure output. When the output is turned ON, the LED lights and the specified pressure is output from the output connector of the rear panel.
- 3 AUTO STEP key (operable only when the OUTPUT key is OFF.)**
Key used to turn ON/OFF the auto-step output mode. The LED located above and to the left of the key lights when this mode is turned ON.
- 4 SWEEP ↗ key**
Key used to turn ON/OFF the rising sweep mode. The LED located above and to the left of the key lights when this mode is turned ON. While outputting pressure in the falling sweep mode, you can press this key to switch to the rising sweep mode.
- 5 SWEEP ↘ key**
Key used to turn ON/OFF the falling sweep output mode. The LED located above and to the left of the key lights when this mode is turned ON. While outputting pressure in the rising sweep mode, you can press this key to switch to the falling sweep mode.
- 6 INTERVAL key**
Key used to set the interval for the auto-step output mode and sweep output mode. When you press this key, the display shows values in the following order: the interval for the auto-step output mode, the interval for the sweep output mode, and the specified pressure value. The LED lights when the interval is being displayed. The interval is set using UP (Δ) and DOWN (∇) **pressure setting keys** that are provided for each digit.

7 REPEAT key

Key used to turn ON/OFF the repeat function. The LED located above and to the left of the key lights when this mode is turned ON.

When you press this key, pressure output in the auto-step output mode or sweep output mode is repeated.

8 HOLD key

If you press this key while outputting pressure in the auto-step output mode or sweep output mode, the MC100 temporarily stops its operation and holds the pressure level.

When you press the key again, the auto-step operation or sweep operation resumes from the point where it was stopped. The LED located above and to the left of the key lights when the hold function is turned ON.

9 Pressure setting keys

Keys used to set the output pressure values. Each digit is provided with UP (Δ) and DOWN (∇) keys that increment or decrement the value. This key is also used to set the interval for the auto-step output mode and sweep output mode.

In the auto-step mode and sweep mode, you cannot change the pressure value or the interval.

10 Divider ratio setting keys (operable when AUTO STEP and SWEEP keys are OFF.)

Keys used to set the divider ratio n/m. UP (Δ) and DOWN (∇) keys are available. Range: denominator m = 1 to 20, numerator n = 0 to m.

11 UNIT key

Key used to switch the displayed pressure unit.

12 CLEAR key

Sets the pressure value to zero. You cannot do this while outputting pressure in the auto-step output mode or sweep mode.

13 ZERO CAL key

Key used to carry out zero calibration. You cannot carry out zero calibration while the output is ON.

14 ALARM RESET key

Key used to reset the source pressure alarm function. The LED lights when an alarm occurs. It turns OFF when you reset the alarm.

15 LOCAL/INTERFACE key

When the MC100 is in the remote control mode via the GP-IB or serial (former EIA-232 (RS-232)) interface, you can press this key to release the remote control mode.

When the MC100 is in the local mode (REMOTE indicator LED is OFF), you can set communication parameters.

16 Output monitor

Indicates the output condition with respect to the specified value (100%).

17 Offset monitor

Indicates the stability of the final output value in terms of deviation.

18 MENU key

Key used to set the load capacity, monitor output range, and beep sound (ON/OFF).

Rear Panel

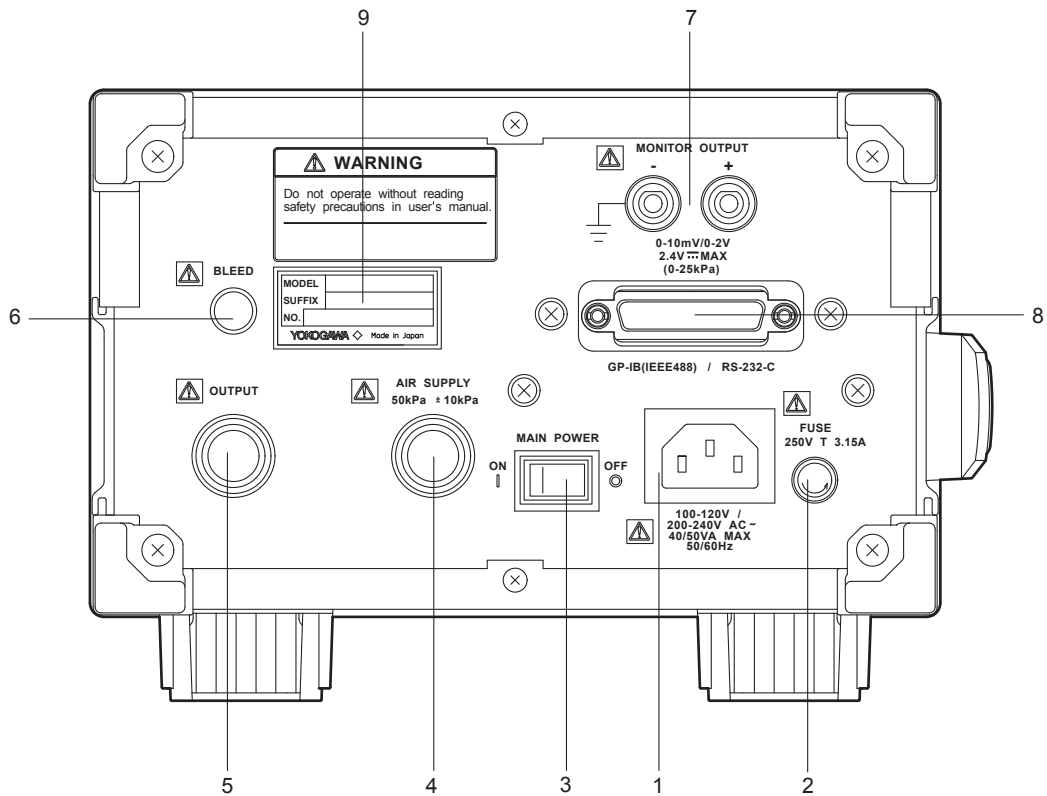

1 Power connector

Three-pin connector with a protective grounding terminal. Connect the power cord to this connector. Make sure to perform protective grounding to prevent the possibility of electric shock. Ensure that the power supply matches voltage and frequency requirements.

2 Fuse

Time lag fuse rated for 250 V and 3.15 A.

3 Main power switch

Turns ON/OFF the commercial power supply input. When you turn OFF this switch, the primary side of the power circuit is cut off.

4 Pressure source connector

The size is Rc1/4 internal thread (SUFFIX (suffix code):P1) or 1/4NPT internal thread (SUFFIX (suffix code):P2). A connector is preinstalled at the factory. A vinyl, nylon, or other tube ($\phi 4$ mm i/d \times $\phi 6$ mm o/d) can be connected to it. The pressure source must be applied through a filtered reducing valve or similar apparatus.

5 Output connector

The size is Rc1/4 internal thread (SUFFIX (suffix code): P1) or 1/4NPT internal thread (SUFFIX (suffix code): P2). A connector is preinstalled at the factory. A vinyl, nylon, or other tube ($\phi 4$ mm i/d \times $\phi 6$ mm o/d) can be connected to it.

6 Bleed outlet

Air from the servo valve is discharged from this outlet. Do not obstruct this outlet.

7 Monitor output terminal

Outputs either 0 to 10 mV/full scale or 0 to 2 V/full scale according to the setting. The output voltage corresponds to the following specified pressure:

For the 76740: 0 to 25 kPa.

For the 767402: 0 to 200 kPa.

8 Communication interface connector

GP-IB or serial (former EIA-232 (RS-232)) interface connector used to connect a controller (PC) using a communication cable.

9 Name plate**Digital Numbers and Characters**

Because the MC100 uses a 7-segment LED display, numbers, alphabets, and operation symbols are represented using special characters as follows. Some of the characters are not used.

0 → 0	A → A	K → K	U → U
1 → 1	B → b	L → L	V → V
2 → 2	C → C lowercase c → c	M → M	W → W
3 → 3	D → d	N → n	X → X
4 → 4	E → E	O → o	Y → Y
5 → 5	F → F	P → P	Z → Z
6 → 6	G → G	Q → Q	+ → +
7 → 7	H → H lowercase h → h	R → r	- → -
8 → 8	I → I	S → S	x → x
9 → 9	J → J	T → T	÷ → ÷

2.1 Precautions on the Use of the Instrument

Safety Precautions

- Before using the instrument, make sure to read the “Safety Precautions” given on pages iv, v, and vi.
- Do not remove the cover from the instrument.
Some sections inside the instrument have high voltages that are extremely dangerous. For internal inspection or adjustment, contact your nearest YOKOGAWA dealer as listed on the back cover of this manual.
- Never continue to use the instrument if there are any symptoms of trouble such as strange odors or smoke coming from the instrument. In such cases, immediately turn OFF the power switch and the main power switch and unplug the power cord. In addition, cut off the power supply and source pressure of instruments that are connected to the I/O sections and remove connections such as tubes. If such abnormal symptoms occur, contact your nearest YOKOGAWA dealer as listed on the back cover of this manual.
- Nothing should be placed on top of the power cord. The power cord should also be kept away from any heat sources. When unplugging the power cord from the outlet, never pull by the cord itself. Always hold and pull by the plug. If the power cord is damaged or if you are using the instrument in a location where the power supply specifications are different, purchase a power cord that matches the specifications of the region that the instrument will be used in.

General Handling Precautions

- When carrying the instrument, first disconnect the power cord and connection cables, and then lift the instrument by the handle on the left side panel.
- Do not bring charged objects near the input terminals. This can damage the internal circuitry.
- Do not pour volatile agents on the case or operation panel nor leave them in contact with rubber or PVC products for long periods of time. This can cause discoloration.
- Make sure heating elements such as soldering bits do not come in contact with the operation panel.
- If you are not going to use the instrument for a long period of time, unplug the power cord from the outlet.
- When cleaning the case or the operation panel, first remove the power cord from the outlet. Then, wipe with a dry, soft cloth. Do not use volatile chemicals as this may cause discoloring and deformation.

2.2 Installation

Installation Condition

Install the instrument in a place that meets the following conditions.

- **Ambient temperature and humidity**

Use the instrument in the following environment.

- Ambient temperature: 5 to 40°C
- Ambient humidity: 20 to 80%RH, no condensation.

Note

- Condensation may occur if the instrument is moved to another place where the ambient temperature is higher, or if the temperature changes rapidly. In this case, let the instrument adjust to the new environment for at least an hour before using the instrument.
 - There are vent holes on the top and bottom sides of the instrument. Do not cover these vents or the bleed hole on the rear side. Allow at least 2 cm of space above the vents on the top side.
-

Do not install the instrument in the following places:

- In direct sunlight or near heat sources.
- Where an excessive amount of soot, steam, dust, or corrosive gases are present.
- Near magnetic field sources.
- Near high voltage equipment or power lines.
- Where the level of mechanical vibration is high.
- In an unstable location.
- In a location where the altitude exceeds 2000 m.

Installation Position

Place the instrument in a horizontal position or inclined position using the stand (see the figure below).

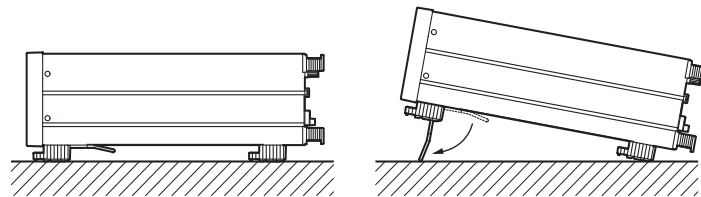

2.3 Connecting the Power Supply

Before Connecting the Power Supply

Follow the warnings and cautions below when connecting the power supply to avoid the danger of electric shock and damage to the instrument.



WARNING

- Make sure that the power supply voltage matches the instrument's rated supply voltage and that it does not exceed the maximum voltage range of the power cord to use.
- Connect the power cord after confirming that both the MAIN POWER switch (rear panel) and the POWER switch (front panel) are OFF.
- To prevent electric shock or fire, use the power cord for the instrument.
- Make sure to connect protective earth grounding to prevent electric shock. Connect the power cord to a three-prong power outlet with a protective earth terminal.
- To prevent fire, only use a fuse with the specified rating (current, voltage, and type). For fuse replacement, see section 5.2, "Storing the MC100 and Replacing the Fuse" (page 5-3).
- Do not use an extension cord without protective earth ground. The protective features of the instrument will be rendered ineffective.



CAUTION

- Before turning OFF the power, set the pressure output value to zero using the **pressure setting keys** or the **CLEAR key**. (See section 2.5, "Pressure Output Preparation" (page 2-8).)
 - If you have turned ON the power and operated the setting keys and **OUTPUT key**, do not inadvertently turn OFF the power. This may cause the source pressure to be output directly when you connect the source pressure.
-

2.3 Connecting the Power Supply

French



AVERTISSEMENT

- Assurez-vous que la tension d'alimentation correspond à la tension d'alimentation nominale de l'appareil et qu'elle ne dépasse pas la plage de tension maximale du cordon d'alimentation à utiliser.
- Branchez le cordon d'alimentation après avoir confirmé que l'interrupteur MAIN POWER (à l'arrière du panneau) et l'interrupteur POWER (à l'avant du panneau) sont sur OFF.
- Pour éviter tout risque de choc électrique, utiliser exclusivement le cordon d'alimentation prévu pour cet instrument.
- Relier l'instrument à la terre pour éviter tout risque de choc électrique. Brancher le cordon d'alimentation sur une prise de courant à trois plots reliée à la terre.
- Pour éviter tout risque d'incendie, utilisez uniquement un fusible de la cote spécifiée (courant, tension, et type). Pour le remplacement du fusible, voir la section 5.2, « Storing the MC100 and Replacing the Fuse » (page 5-3).
- Toujours utiliser une rallonge avec broche de mise à la terre, à défaut de quoi l'instrument ne serait pas relié à la terre.



ATTENTION

- Avant la mise hors tension, réglez la valeur de sortie de la pression sur zéro en utilisant les **touches de réglage de la pression** ou la **touche CLEAR**. (Voir la section 2.5, « Pressure Output Preparation » (page 2-8).)
- Si vous avez mis l'instrument sous tension et utilisé les touches de réglage et la **touche OUTPUT**, ne mettez l'instrument hors tension par inadvertance. Ceci pourrait produire directement la pression de source lorsque vous branchez la pression de source.

Connection Procedure

1. Confirm that the main power switch located on the rear panel and the power switch on the front panel are turned OFF.
2. Connect the power cord plug to the power connector on the rear panel.
3. Connect the other end of the cord to an outlet that meets the following conditions.

Rated supply voltage	100-120 VAC/200-240 VAC
Permitted supply voltage range	90-120 VAC/180-240 VAC
Rated supply voltage frequency	50/60 Hz
Permitted supply voltage frequency range	47 to 63 Hz

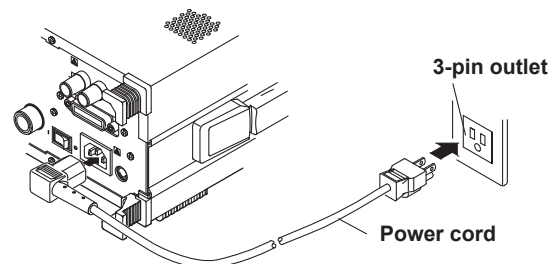

2.4 Turning ON/OFF the Power Switch

Things to Check before Turning ON the Power

- Is the instrument properly installed? → See section 2.2, “Installation” (page 2-2).
- Is the power cord properly connected? → See section 2.3, “Connect the Power Supply” (page 2-3).

Position of the Power Switch

There are two power switches. One is the main power switch located at the center of the rear panel. The other is the power switch located at the lower left corner of the front panel. Normally, you will leave the main power switch turned ON, and use only the power switch to turn ON/OFF the MC100.

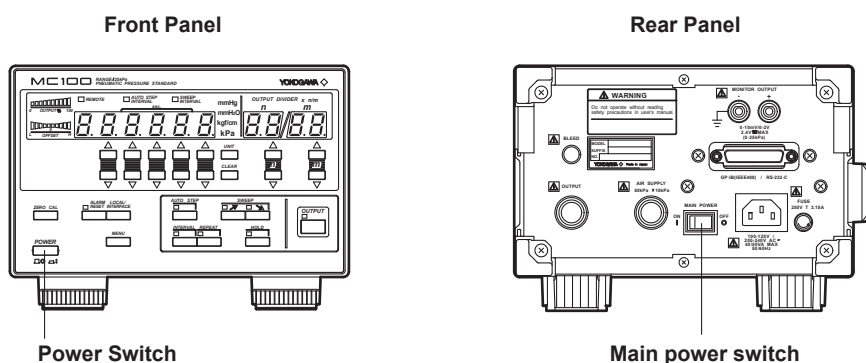

Operation to Turn ON/OFF the Power Switch

Main power switch on the rear panel

Press the switch to the “| (ON)” side to turn it ON.

Power switch on the front panel

The power switch is a push button. Press once to turn it “ON” and press again to turn it “OFF.”

CAUTION

Before turning OFF the power switch, press the **pressure setting keys** or **CLEAR key** to set the output pressure to zero, confirm that the output pressure is zero, and turn OFF the **OUTPUT key**.

French

ATTENTION

Avant de mettre l'interrupteur hors tension, appuyez sur les **touches de réglage de la pression** ou sur la **touche CLEAR** pour régler la pression de sortie sur zéro, confirmez que la pression de sortie est zéro, puis mettez la **touche OUTPUT** hors tension

2.4 Turning ON/OFF the Power Switch

Power Down Operation

The MC100 backs up the setup data existing immediately before the power is turned OFF. The MC100 starts up using the stored setup data the next time the power is turned ON. However, some of the information are not backed up. For details, see “A List of Factory Default Values” (page 2-7).

Note

- The life of the lithium battery that is used to store the settings is approximately five years when the MC100 is used in an ambient temperature of 23°C. When the battery performance deteriorates, the MC100 will no longer be able to save the setup data. In such case, you must quickly replace the lithium battery. The user cannot replace the lithium battery. Contact your nearest YOKOGAWA dealer for replacement.
- The warm-up time required to satisfy all specifications is approximately five minutes.

Power Up Operation and Display

When you turn ON the power switch, the MC100 automatically performs a self-test. The self-test entails checking the pressure sensor and memory. If the pressure sensor and memory are operating normally, the MC100 shows the following opening message and enters the output-ready state.

If an error code remains on the display as a result of the self-test, the MC100 will not operate properly. In this case, turn OFF the power switch and the main power switch, and contact your nearest YOKOGAWA dealer as listed on the back cover of this manual. When contacting your dealer, notify the model name and instrument No. on the name plate on the rear panel and the error code that was displayed.

Note

For error information corresponding to the error code, see section 5.1, “Troubleshooting” (page 5-1).

Opening Message

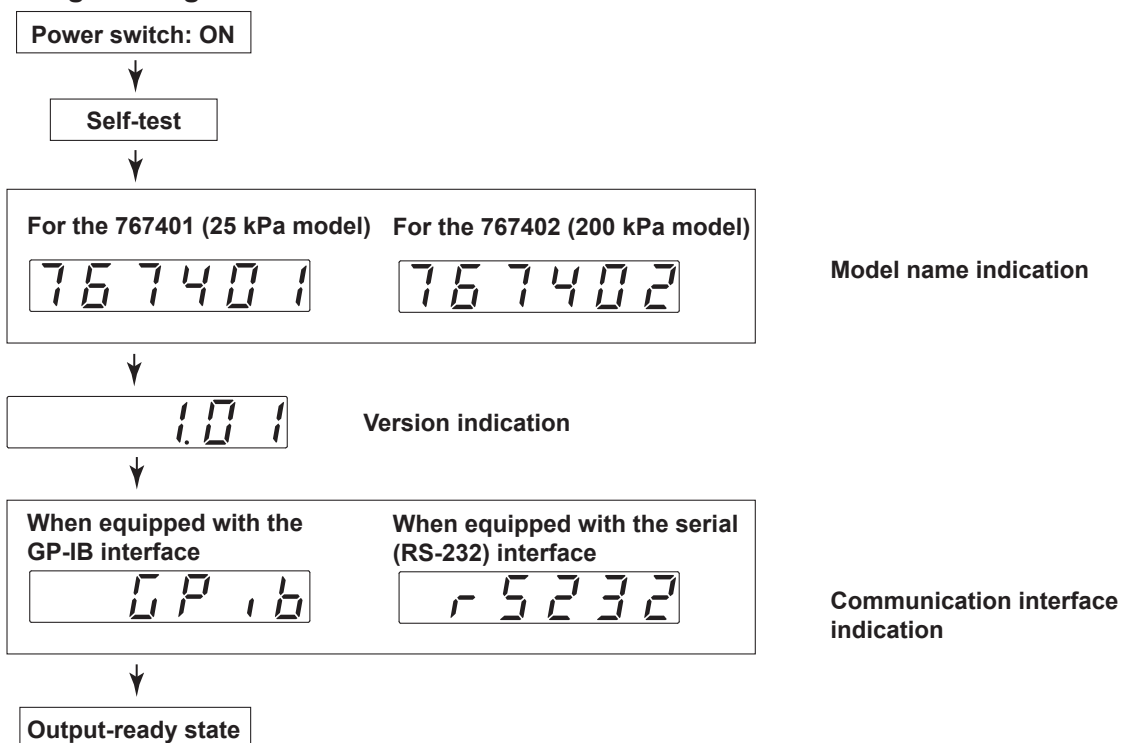

A List of Factory Default Values

Item	Factory Default Value	Backup * ¹
Pressure zero CAL value	0	Yes
Pressure unit	kPa	Yes
Pressure value	0	No
Divider ratio value	1/1	No
Pressure output	OFF	No
Output mode	Manual (divider ratio)	No
Auto-step interval	10 s	Yes
Sweep interval	15 s	Yes
Repeat output	OFF	No
Hold	OFF	No
Load capacity	small	Yes
Monitor output	L (10 mV)	Yes
Beep sound	ON	Yes
Communication settings (common to GP-IB and serial)		
(Output data) header	Yes	Yes (command H)
Status byte mask value	29	Yes (command MS)
When equipped with the GP-IB interface		
GP-IB board	Addressable mode only	Yes
Address	1	Yes
Delimiter	0 (CR+LF+EOI)	Yes (command DL)
When equipped with the serial interface		
Serial (RS-232) mode	Normal mode only	Yes
Handshaking mode	0	Yes
Format	0	Yes
Baud rate	9600	Yes
Delimiter	0 (CR+LF)	Yes (command DL)

*¹ Yes: Backed up. No: Not backed up.

Initializing Setup Data

The following two methods are available in initializing the setup data to their factory default values:

- Keep pressing the **CLEAR key** until the model name and version indication appears when you turn ON the power switch.
- Transmit the "RC" communication command from the controller (however, communication settings will not be initialized).

2.5 Pressure Output Preparation

Connecting the Source Pressure

1. Confirm that the main power switch and the main power switch are turned OFF.
2. Confirm that the instrument output connector is open.
3. Securely connect the pressure source to the pressure source connector on the rear panel via the filtered reducing valve.

Use a $\phi 4$ mm i/d \times $\phi 6$ mm o/d vinyl tube for piping, and connect it with the supplied joint connector.

4. Gradually open the reducing valve and set the source pressure to 50 ± 10 kPa (for the 767401) or 280 ± 20 kPa (767402).

CAUTION

- Use a stable pressure source with minimum pressure variations.
- Use a filtered reducing valve or attach a filter to the reducing valve.
- If you are operating multiple MC100s in parallel from a single pressure source, connect them as follows in order to stabilize the output.

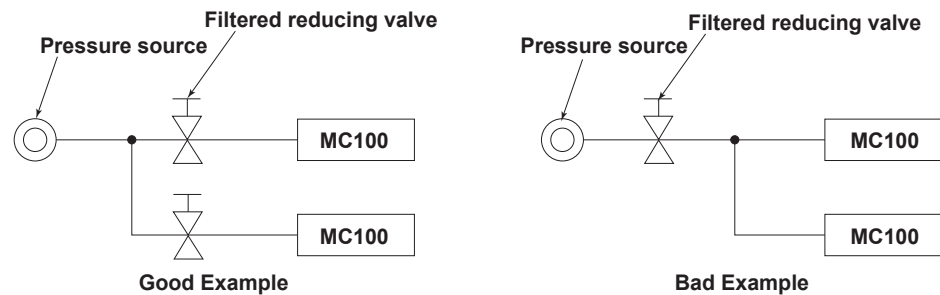

French

ATTENTION

- Utilisez une source de pression stable avec des variations de pression minimum.
- Utilisez un réducteur de pression filtré ou attachez un filtre au réducteur de pression.
- Si vous utilisez plusieurs MC100 en parallèle depuis une source de pression unique, branchez-les comme suit afin de stabiliser la sortie.

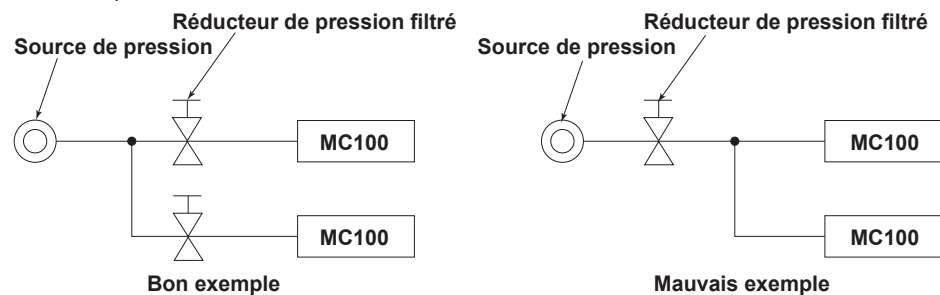

Connecting the Output Connector



CAUTION

- Before connecting the MC100 and the device to be calibrated, press the **pressure setting keys** or **CLEAR key** to set the output pressure to zero and confirm that the output pressure is zero.
- Do not obstruct the bleed outlet of the rear panel (with your fingers, for example). Otherwise, proper output will be hindered.

French



ATTENTION

- Avant de brancher le MC100 et l'appareil à étalonner, appuyez sur les **touches de réglage de la pression** ou sur la **touche CLEAR** pour régler la pression de sortie sur zéro et confirmez que la pression de sortie est zéro.
- Ne bouchez pas la vanne de purge à l'arrière de l'appareil (avec vos doigts, par exemple). Sinon, la sortie correcte sera entravée.

Connect the output connector on the rear panel and the input of the device.
For connection, use the same $\phi 4$ mm i/d \times $\phi 6$ mm o/d vinyl tube as with the pressure source (or something similar).
For setting the load capacity, see section 2.7, "Setting the Load Capacity" (page 2-13).

Note

Confirm that there are no leaks in the device that is to be connected.

2.5 Pressure Output Preparation

Zero Calibration

Turn ON the power switch. With the **OUTPUT key** on the front panel turned OFF, warm up the instrument for five minutes. Then, press the **ZERO CAL key** and confirm that the offset monitor is at the green level.

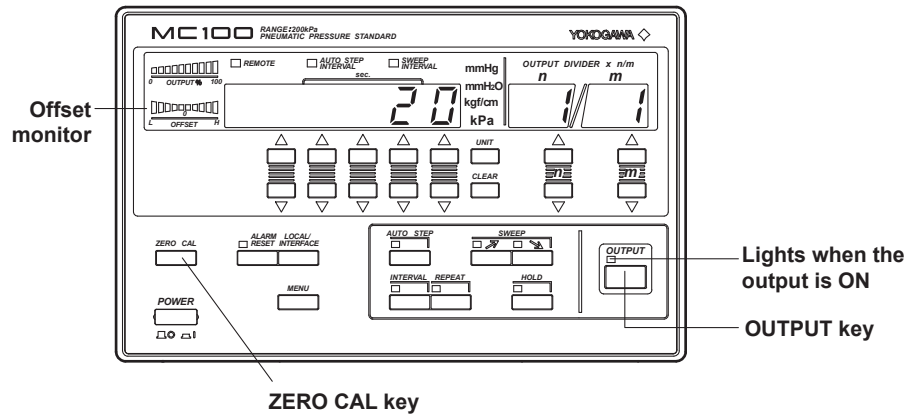

Note

- When performing zero calibration, if the input pressure value and the initial value differ by more than the value specified below, an error code appears.
767401: 5 kPa
767402: 20 kPa
- It takes approximately 2 s for zero calibration to finish after you press the **ZERO CAL key**.

Cutting Off the Source Pressure

Always turn OFF the power switch and the **OUTPUT key** before cutting off the source power.

CAUTION

- If you cut off the source pressure before you turn OFF the **OUTPUT key**, the MC100 will detect abnormal source pressure, and the ALARM indication LED will light. (See section 2.9, "Alarm Function" (page 2-15).)

French

ATTENTION

- Si vous interrompez la pression source avant de mettre la **touche OUTPUT** hors tension, le MC100 détectera une pression de source anormale, et la LED ALARM s'allumera. (Voir la section 2.9, « Alarm Function » (page 2-15).)

2.6 Setting the Pressure Display Unit, Output Pressure, Divider Ratio and Turning ON/OFF the Pressure Output

Setting the Pressure Display Unit

Using the **UNIT key**, select the desired unit of pressure to be displayed.

The pressure unit varies depending on the suffix code.

- When SUFFIX (suffix code) is U1: kPa (The displayed unit will not change even if you press the **UNIT key**.)
- When SUFFIX (suffix code) is U2: kPa→kgf/cm²→mmH₂O→mmHg→kPa...
- When SUFFIX (suffix code) is U3: kPa→psi→inH₂O→inHg→kPa...

Note

Switching to a pressure display unit with different display resolution can cause an error in the displayed output pressure value due to the effects from the conversion coefficient. For details related to the display resolution (selectable range) and conversion coefficient, see "Selectable range for each pressure display unit and conversion coefficient to kPa" below.

Setting the Output Pressure

• Setting the output pressure

A one-to-one correspondence exists between each digit of the specified value on the display and the key immediately below the digit.

The decimal point is fixed according to the type of unit.

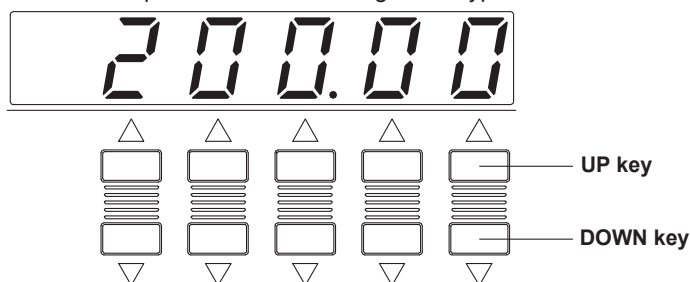

• Selectable range for each pressure display unit and conversion coefficient to kPa

Pressure Display Unit	Selectable Range (767401)	Selectable Range (767402)	Conversion Coefficient to kPa
kPa	0.000 to 30.000	0.00 to 240.00	1
kgf/cm ²	0.00000 to 0.30591	0.0000 to 2.4473	9.80665×10^{-1}
mmH ₂ O	0.0 to 3059.1	0 to 24473	9.80665×10^{-3}
mmHg	0.00 to 225.01	0.0 to 1800.1	1.333224×10^{-1}
psi	0.0000 to 4.3511	0.000 to 34.809	6.894757
inH ₂ O	0.00 to 120.43	0.00 to 963.51	2.490889×10^{-1}
inHg	0.0000 to 8.8589	0.000 to 70.871	3.386388

2.6 Setting the Pressure Display Unit, Output Pressure, Divider Ratio and Turning ON/OFF the Pressure Output

Setting the Divider Ratio

Specify the value to be output using a fractional value with respect to the specified value.

Pressure value actually output = the specified value $\times \frac{n}{m}$
Range: $m = 1$ to 20 , $n = 0$ to m

Value n cannot exceed value m .

A one-to-one correspondence exists between each digit of the value shown in the n and m display section and the key immediately below the digit.

Use these **divider ratio setting keys** to set the divider output.

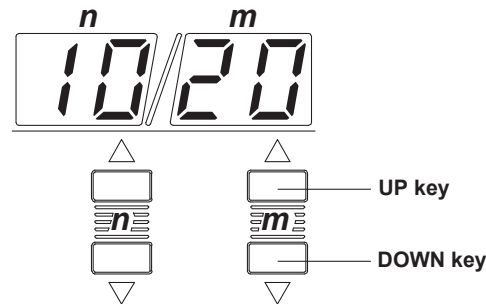

Turning ON/OFF the Pressure Output

Use the **OUTPUT key** to turn ON/OFF the pressure output. Press once to turn it “ON” and press again to turn it “OFF.” When you press the **OUTPUT key** and the pressure output is ON, the OUTPUT indication LED located above and to the left of the key lights. When turning OFF the **OUTPUT key**, set the output to zero.

- **During manual (divider ratio) output**
Press the pressure setting keys or the **CLEAR key** to set the value to 0, wait for the offset monitor to turn green, and then turn OFF the **OUTPUT key**.
- **During auto-step output**
Turn OFF the **OUTPUT key** when the value n is at the smallest value.
- **During sweep output**
Turn OFF the **OUTPUT key** when the output is at 0%.

CAUTION

To abort the pressure output, set the output pressure to zero and then turn OFF the **OUTPUT key**. If you happen to turn OFF the **OUTPUT key** in the middle of the output, the source pressure may directly be output as output pressure the next time the **OUTPUT key** is turned ON. In such case, remove the output connector temporarily, set the pressure to zero, and output the pressure.

French

ATTENTION

Pour abandonner la sortie de la pression, réglez la pression de sortie sur zéro puis mettez la **touche OUTPUT** hors tension. Si vous mettez la **touche OUTPUT** hors tension en cours de sortie, la pression source est susceptible d'être produite comme pression source la prochaine fois que la **touche OUTPUT** est mise sous tension. Dans ce cas, retirez temporairement le connecteur de sortie, réglez la pression sur zéro et produisez la pression.

2.7 Setting the Load Capacity

Explanation

Set the load capacity of the output destination.

Select the approximate load capacity from the following three types:

SmaLL (Small): 0 to 100 cc
MiddLE (Middle): 100 to 500 cc
LArGE (Large): 500 to 1000 cc

Procedure

1. Press the **MENU** key.

The display shows the following:

The display shows the text "SmaLL" on the left and "L.B" on the right, with a vertical line between them.

2. Press the lowest digit pressure setting key and set the load capacity.

The display shows the text "SmaLL" on the left and "L.B" on the right, with a vertical line between them.

or

The display shows the text "MiddLE" on the left and "L.B" on the right, with a vertical line between them.

or

The display shows the text "LArGE" on the left and "L.B" on the right, with a vertical line between them.



Press these keys to set the load capacity.

3. When you are done, press the **MENU** key three times.

Note

The response speed of the MC100 varies depending on the load capacity.

2.8 Setting the Interval

Explanation

When using the auto-step output mode or sweep output mode to output pressure, set the interval of each step or the sweep period as the interval.

Range and resolution

Mode Selectable	Range	Resolution
Auto-step output mode	10 to 600 s	5 s
Sweep output mode	15 to 600 s	5 s

Definition of the interval

- During auto-step output mode
- Sweep output mode

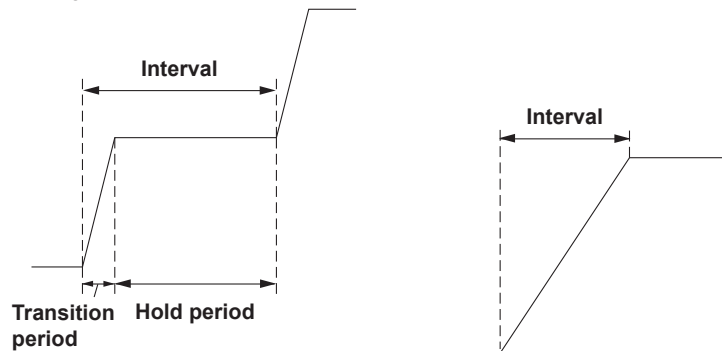

Procedure

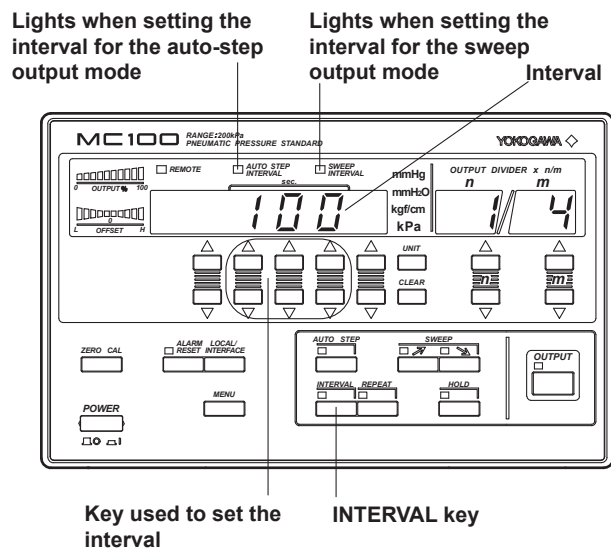

1. Confirm that the **OUTPUT** key is OFF.
2. Press the **INTERVAL** key and set the interval for the auto-step output mode or sweep output mode. To set the interval for the auto-step output mode, turn ON the AUTO STEP INTERVAL indication LED. To set the interval for the sweep output mode, turn ON the SWEEP INTERVAL indication LED.
3. The display shows the interval.
4. Set the interval using the **pressure setting keys**.
5. When you are done, press the **INTERVAL** key.

2.9 Alarm Function

Explanation

An alarm occurs in the following cases. When an alarm occurs, the ALARM indication LED located above and to the left of the **ALARM RESET** key lights, and the output turns OFF.

- When the source pressure falls below the specified pressure (when the input piping that is supplying the pressure comes off during operation, for example) or when the source pressure is too large.
- When the output piping comes off while outputting pressure.
- When the load capacity is too large.

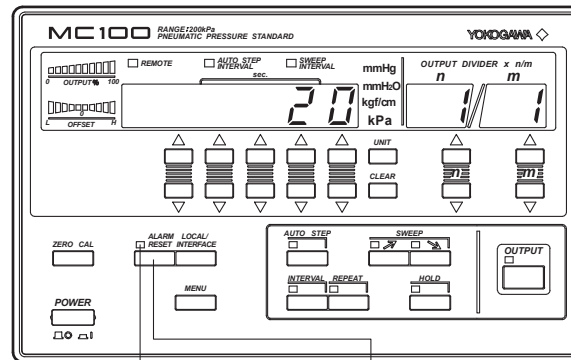

Lights when an alarm occurs. ALARM RESET key

Procedure

Make sure to follow the procedure below when releasing the alarm.

CAUTION

If you do not release the alarm according to the following procedure, a pressure nearly equal to the source pressure will be output when you release the alarm using the **ALARM RESET key**. Be careful, because excessive pressure will be applied to the connected device.

French

ATTENTION

Si vous ne déclenchez pas l'alarme selon la procédure suivante, une pression presque égale à la pression source sera produite lorsque vous déclenchez l'alarme à l'aide de la **touche ALARM RESET**. Faites attention car une pression excessive sera appliquée à l'appareil branché.

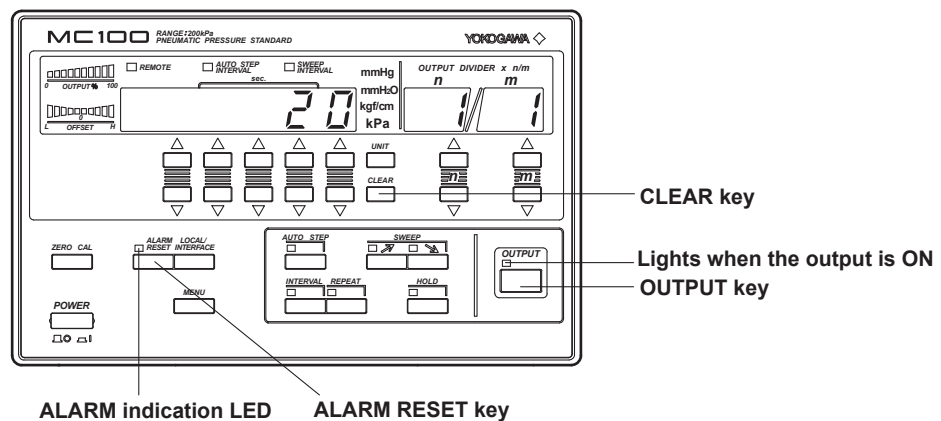

1. Disconnect the tube from the output connector on the rear panel.
2. Check the piping and setting of the source pressure and make adjustments to correct the cause of the alarm.
3. Press the **ALARM RESET key**. Confirm that the ALARM indication LED turns OFF.
4. Set the output value to zero using the **CLEAR key**.
5. Press the **OUTPUT key** and output the pressure for at least 10 s.
6. Turn OFF the **OUTPUT key**, and then turn OFF the main power switch and the power switch. Connect the tube to the output connector on the rear panel.
7. Turn ON the main power switch and power switch, and then press the **OUTPUT key**. The output resumes.

2.10 Monitor Output

Explanation

You can output voltage signals in accordance with the pressure setting condition (up to the maximum setting) from the monitor output terminal on the rear panel.

Monitor output terminal



CAUTION

Do not short the monitor output terminal or apply external voltage to it. This can damage the MC100.

French



ATTENTION

Ne mettez pas la borne de sortie du moniteur en court-circuit et n'y appliquez pas une tension externe. Ceci pourrait endommager le MC100.

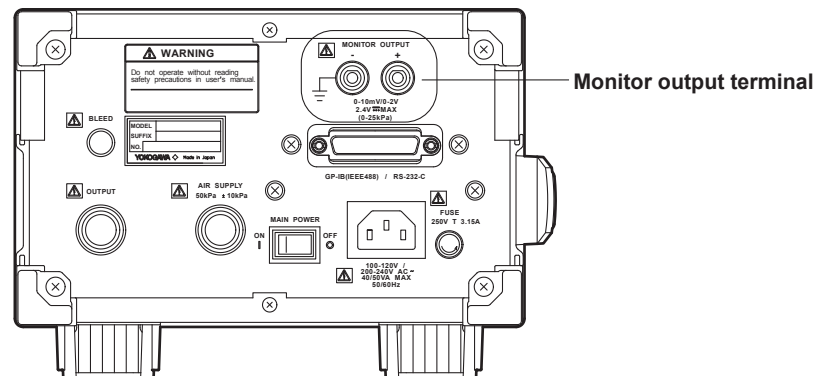

Setting the monitor output range

Set the range of voltage signals to be output to the monitor output terminal.

Select the range from the following two types:

L - L (Low): 0 to 10 mV/full scale (12 mV max)

L - H (High): 0 to 2 V/full scale (2.4 V max)

Procedure

1. Press the **MENU** key twice.

The display shows the following:



2. Press the lowest digit pressure setting key and set the range.



or



Press these keys to set the range.

3. When you are done, press the **MENU** key twice.

Note

The monitor output value is zero when the alarm is active and the **OUTPUT** key is OFF.

2.11 Turning ON/OFF the Beep Sound

Turn ON or OFF the beep sound.

When you turn ON the beep sound, beeps will sound in the following cases:

- When the output value reaches the specified value (100%) during auto-step output or sweep output.
- When zero calibration is finished.

Note

Beep will always sound when an alarm occurs regardless of the beep sound setting.

Procedure

1. Press the **MENU key** three times.

The display shows the following:



2. Press the lowest digit **pressure setting key** and set ON or OFF.



or



Press these keys to set ON or OFF.

3. When you are done, press the **MENU key**.

2.12 Output Monitor and Offset Monitor

Output Monitor

This monitor indicates the ratio (%) of the output with respect to the specified value.

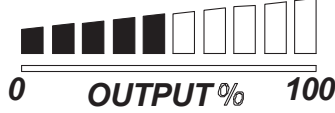
Display example	Description
	<ul style="list-style-type: none"> • When n/m is 1/2 during the manual (divider ratio) output mode. • When n/m is at 1/2 during auto-step output mode. • When the output is at 50% in the sweep output mode.

Offset Monitor

This monitor indicates the output pressure condition. If the green section is ON, the output is stable.

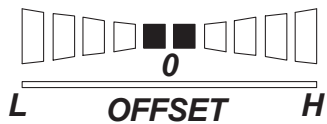
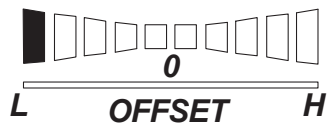
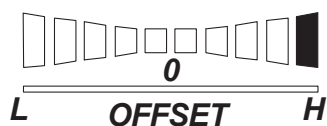
Display example	Description
	<ul style="list-style-type: none"> • The output is stable.
	<ul style="list-style-type: none"> • The final output value is lower than the specified value.
	<ul style="list-style-type: none"> • The final output value is higher than the specified value.

Note

Note that the actual pressure output may be delayed with respect to the pressure output that is indicated by the output monitor, offset monitor, or the output from the monitor output terminal (analog output) depending on the piping and load capacity on the output side.

3.1 Manual Output (Divider Output)

Example

The following settings will be used to explain the output procedure.

Condition

Pressure: 20 kPa, divider ratio: set to n=1 and m=1, and then change to n=1 and m=2.

Output condition

Output the specified value → Output 1/2 the specified value → Output OFF

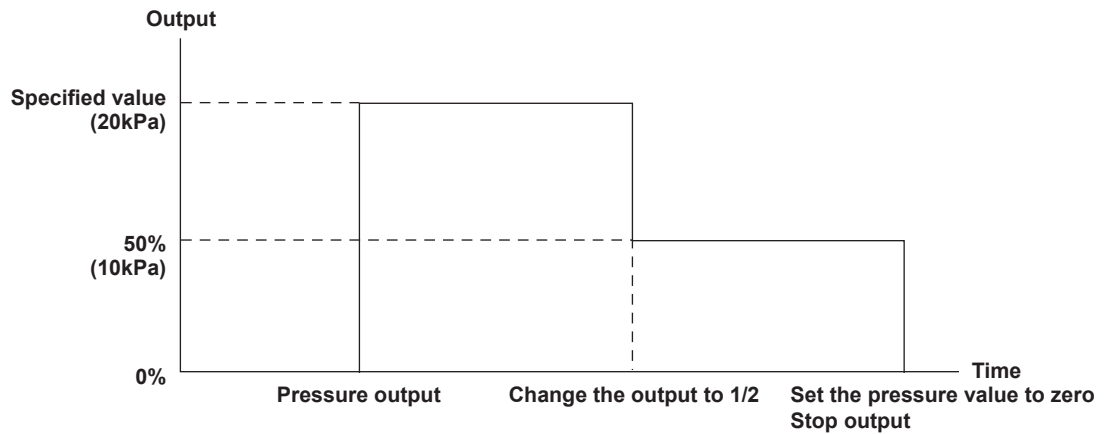

Procedure

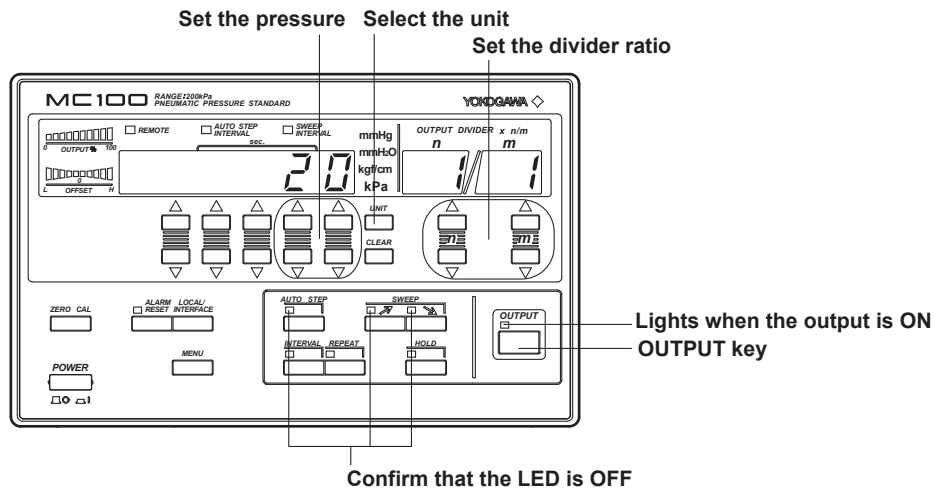

Confirm that the LED is OFF

1. Confirm that the AUTO STEP indication LED, rising SWEEP indication LED, and falling SWEEP indication LED are OFF.
If any of the LEDs are ON, press the keys to turn them OFF.
2. Using the **pressure setting keys**, set the pressure to "20."
3. Press the **UNIT key** to turn ON "kPa." If the suffix code of the MC100 that you are using is "U1," this step is not necessary.
4. Using the **divider ratio setting keys**, set n and m to "1."
5. Turn ON the **OUTPUT key** to start the output. The LED located above and to the left of the key lights when the output is turned ON.
6. Set the value m of the divider ratio to "2." The output pressure drops to 1/2.
7. Press the **pressure setting keys** or the CLEAR key to set the output pressure to "0."
8. Press the **pressure setting keys** to set the output pressure to "0." When the output turns OFF, the OUTPUT indication LED located above and to the left of the key turns OFF.

3.2 Auto-Step Output

Example

The following settings will be used to explain the output procedure.

Condition

Maximum pressure: 20 kPa, interval: 60 s, start step: 1/4 the specified value

Output condition

Output 1/4 the specified value → output 2/4 the specified value → output 3/4 the specified value → output 4/4 the specified value → output 3/4 the specified value → output 2/4 the specified value → output 1/4 the specified value → output OFF

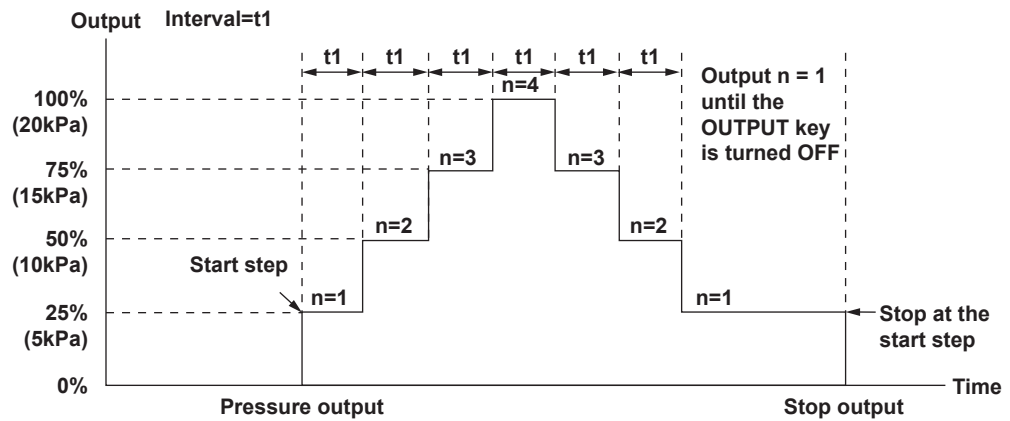

Procedure

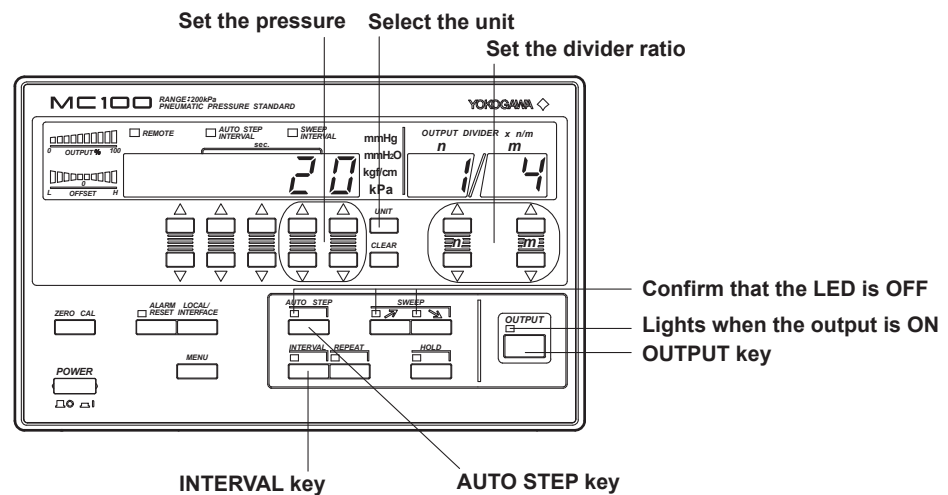

1. Confirm that the AUTO STEP indication LED, rising SWEEP indication LED, and falling SWEEP indication LED are OFF.
If any of the LEDs are ON, press the keys to turn them OFF.
 2. Using the **pressure setting keys**, set the pressure to “20.”
 3. Press the **UNIT key** to turn ON “kPa.” If the suffix code of the MC100 that you are using is “U1,” this step is not necessary.
 4. Using the **divider ratio keys**, set m (number of divisions) to “4” and n (start step) to “1.”
 5. Press the **INTERVAL key**. The display shows the auto-step output interval.
 6. Press the **pressure setting keys** to set the interval to “60” s. For the procedure on setting the interval, see section 2.8, “Setting the Interval” (page 2-14).
 7. Press the **AUTO STEP key** to select the auto-step output mode. The AUTO STEP indication LED lights.
 8. Press the **OUTPUT key** to turn ON the output. The LED located above and to the left of the key lights when the output is turned ON. The output changes according to the example in the figure on the previous page. When the value n returns to the minimum value (the start step, 1 in this case), auto-step operation stops. The MC100 continues to output the pressure at the minimum level.
 9. Check that the value n is at the minimum value (the start step, 1 in this case) and press the **OUTPUT key** to turn OFF the output. When the output turns OFF, the LED located above and to the left of the key turns OFF.
- The following figure shows the output pattern when the output is repeated using the repeat function
(See section 3.4, “Repeating the Output” (page 3-14).)

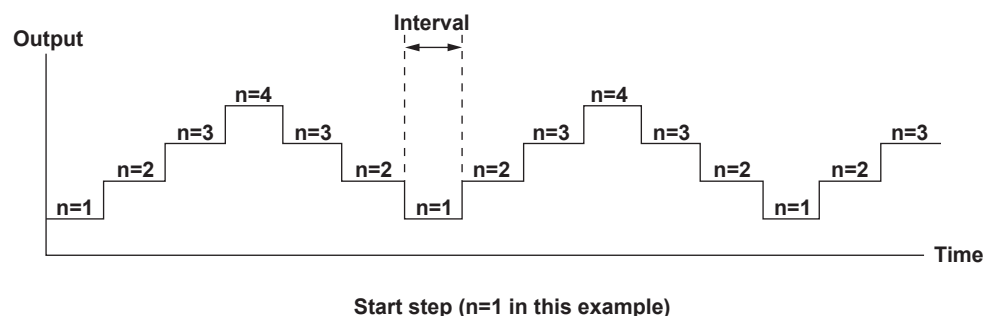

3.3 Sweep Output

Performing the Rising Sweep

Example

The following settings will be used to explain the output procedure.

Condition

Maximum pressure: 20 kPa, interval: 60 s, sweep condition: rising sweep

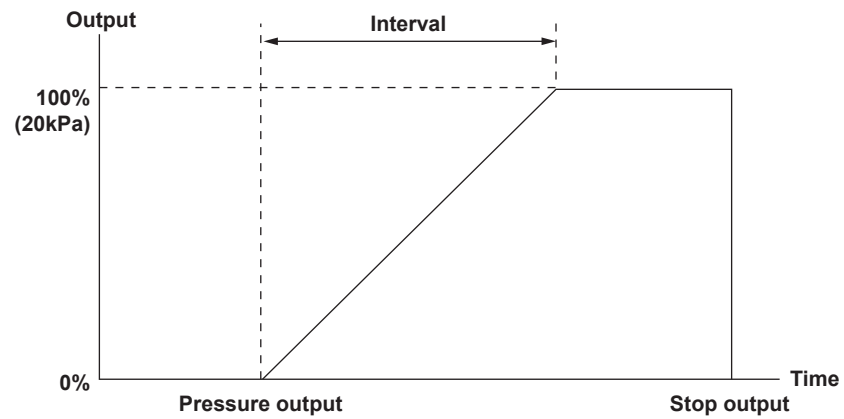

Procedure

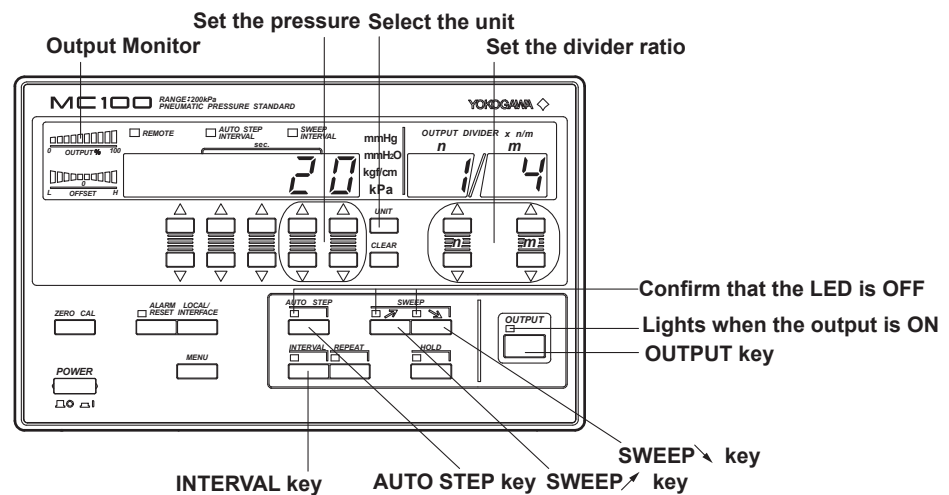

1. Confirm that the AUTO STEP indication LED, rising SWEEP indication LED, and falling SWEEP indication LED are OFF.
If any of the LEDs are ON, press the keys to turn them OFF.
2. Using the **pressure setting keys**, set the pressure to "20."
3. Press the **UNIT key** to turn ON "kPa." If the suffix code of the MC100 that you are using is "U1," this step is not necessary.
4. Press the **INTERVAL key**. The display shows the sweep interval.
5. Press the **pressure setting keys** to set the sweep interval to "60" s.
For the procedure on setting the sweep interval, see section 2.8, "Setting the Interval" (page 2-14).
6. Press the **SWEEP ↗ key** to select the rising sweep output mode. The rising sweep indication LED lights.
7. Press the **OUTPUT key** to turn ON the output. The LED located above and to the left of the key lights when the output is turned ON. When the output monitor indicates 100%, the output pressure reaches the specified value (20 kPa in this case). The MC100 continues to output the specified pressure.
8. To turn OFF the output, press the **SWEEP ↘ key** to select the falling sweep mode. The falling sweep indication LED lights.
9. Confirm that the output pressure is zero, and then press the **OUTPUT key** to turn the output OFF. When the output turns OFF, the LED located above and to the left of the key turns OFF.

Performing the Falling Sweep

Example

The following settings will be used to explain the output procedure.

Condition

Maximum pressure: 20 kPa, interval: 60 s, sweep condition: falling sweep with hold period

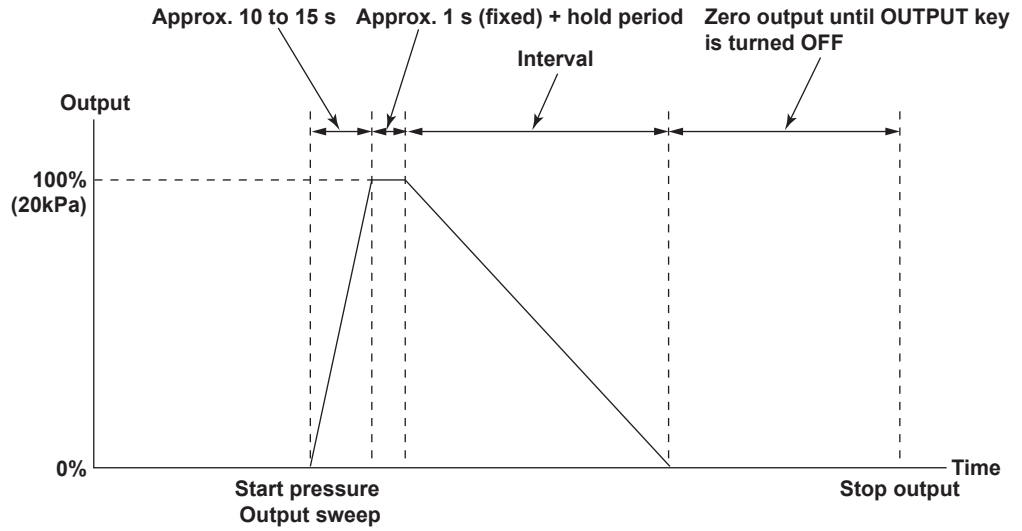

Procedure

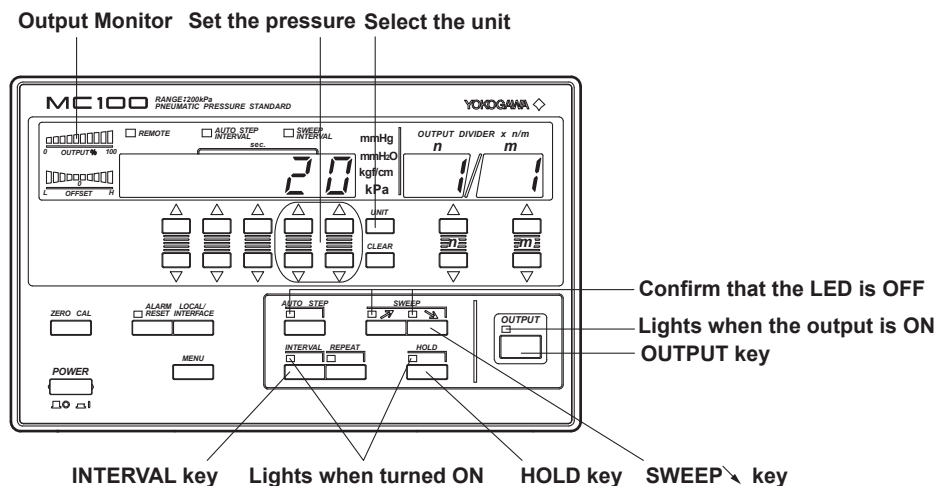

1. Confirm that the AUTO STEP indication LED, rising SWEEP indication LED, and falling SWEEP indication LED are OFF.
If any of the LEDs are ON, press the keys to turn them OFF.
2. Using the **pressure setting keys**, set the pressure to "20."
3. Press the **UNIT key** to turn ON "kPa." If the suffix code of the MC100 that you are using is "U1," this step is not necessary.
4. Press the **INTERVAL key**. The display shows the sweep interval.
5. Press the **pressure setting keys** to set the sweep interval to "60" s.
For the procedure on setting the sweep interval, see section 2.8, "Setting the Interval" (page 2-14).
6. Press the **SWEEP ↘ key** to select the falling sweep output mode. The falling sweep indication LED lights.
7. Press the **OUTPUT key** to turn ON the output. The LED located above and to the left of the key lights when the output is turned ON.
8. Press the **HOLD key** to turn ON the hold function. The LED located above and to the left of the key lights when the hold function is turned ON. For the procedure to hold the output, see section 3.5, "Holding the Output" (page 3-15).
9. Confirm that the output rises to 100% on the output monitor.
10. Press the **HOLD key** to turn OFF the hold function. When the hold function is turned OFF, the LED located above and to the left of the key turns OFF, and the sweep operation starts. When the output monitor indicates 0%, the output pressure is zero. However, the output operation continues.
11. Confirm that the output pressure is zero, and then press the **OUTPUT key** to turn the output OFF. When the output turns OFF, the LED located above and to the left of the key turns OFF.

Note

In some cases during falling sweep output, pressure output may start before reaching 100% of the specified value depending on the size of the load. Therefore, always follow the procedure above.

Performing Falling Sweep after the Completion of the Rising Sweep

Example

The following settings will be used to explain the output procedure.

Condition

Maximum pressure: 20 kPa, interval: 60 s, sweep condition: rising sweep and falling sweep

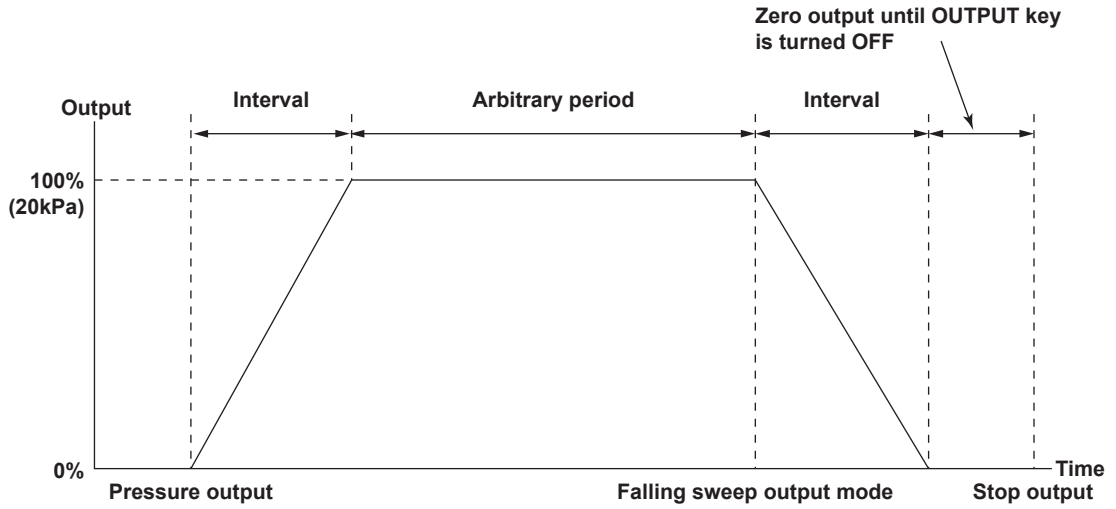

Procedure

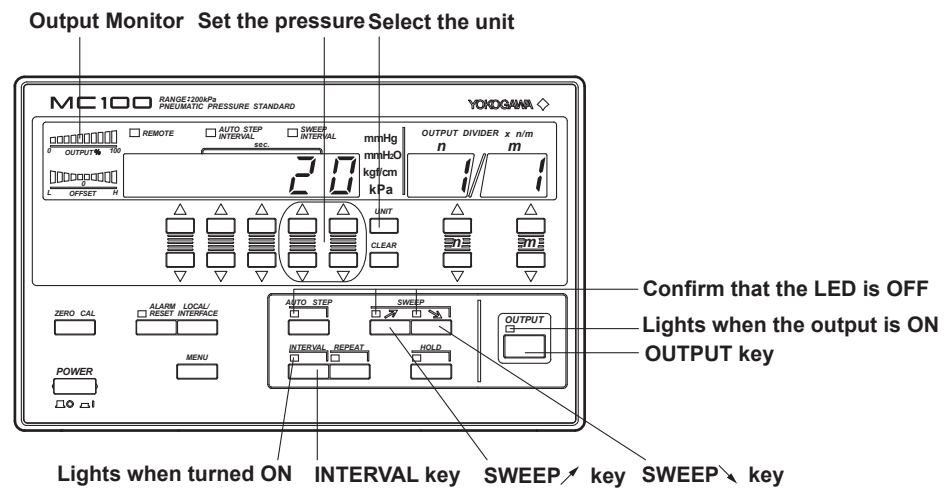

1. Confirm that the AUTO STEP indication LED, rising SWEEP indication LED, and falling SWEEP indication LED are OFF.
If any of the LEDs are ON, press the keys to turn them OFF.
2. Using the **pressure setting keys**, set the pressure to "20."
3. Press the **UNIT key** to turn ON "kPa." If the suffix code of the MC100 that you are using is "U1," this step is not necessary.
4. Press the **INTERVAL key**. The display shows the sweep interval.
5. Press the **pressure setting keys** to set the sweep interval to "60" s.
For the procedure on setting the sweep interval, see section 2.8, "Setting the Interval" (page 2-14).
6. Press the **SWEEP ↗ key** to select the rising sweep output mode. The rising sweep indication LED lights.
7. Press the **OUTPUT key** to turn ON the output. The LED located above and to the left of the key lights when the output is turned ON. When the output monitor indicates 100%, the output pressure reaches the specified value (20 kPa in this case). The MC100 continues to output the specified pressure.
8. Press the **SWEEP ↘ key** to select the falling sweep output mode. The falling sweep indication LED lights. When the output monitor indicates 0%, the output pressure is zero. However, the output operation continues.
9. Confirm that the output pressure is zero, and then press the **OUTPUT key** to turn the output OFF. When the output turns OFF, the LED located above and to the left of the key turns OFF.

Performing Rising Sweep by Pressing the SWEEP ↗ Key after or during the Falling Sweep Operation

Example

The following settings will be used to explain the output procedure.

Condition

Maximum pressure: 20 kPa, interval: 60 s, sweep condition: rising sweep and falling sweep

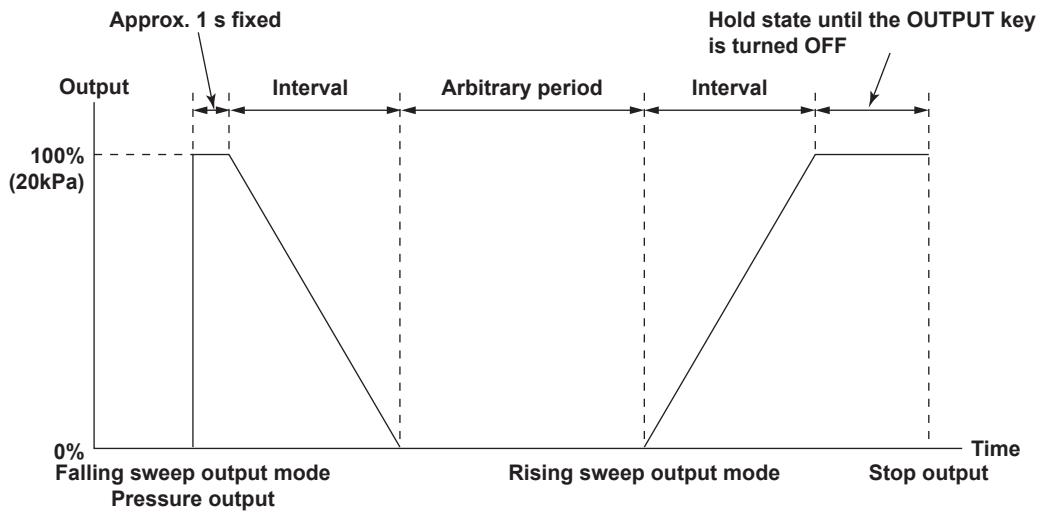

Procedure

Output Monitor Set the pressure Select the unit

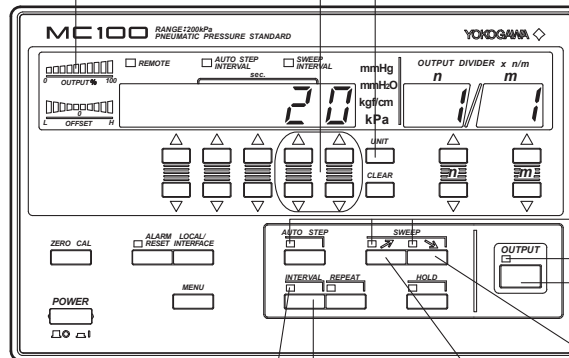

Lights when turned ON INTERVAL key SWEEP ↗ key SWEEP ↘ key

1. Confirm that the AUTO STEP indication LED, rising SWEEP indication LED, and falling SWEEP indication LED are OFF.
If any of the LEDs are ON, press the keys to turn them OFF.
2. Using the **pressure setting keys**, set the pressure to "20."
3. Press the **UNIT key** to turn ON "kPa." If the suffix code of the MC100 that you are using is "U1," this step is not necessary.
4. Press the **INTERVAL key**. The display shows the sweep interval.
5. Press the **pressure setting keys** to set the sweep interval to "60" s.
For the procedure on setting the sweep interval, see section 2.8, "Setting the Interval" (page 2-14).
6. Press the **SWEEP ↘ key** to select the falling sweep output mode. The falling sweep indication LED lights.
7. Press the **OUTPUT key** to turn ON the output. The LED located above and to the left of the key lights when the output is turned ON. When the output monitor indicates 100%, the output pressure reaches the specified value (20 kPa in this case). The MC100 outputs the specified pressure for approximately 1 s. Then, the MC100 performs falling sweep and the output pressure reaches zero. However, the output operation continues. The output monitor indicates 0% at this point.
8. Press the **SWEEP ↗ key** to select the rising sweep output mode. The rising sweep indication LED lights. When the output monitor indicates 100%, the output pressure reaches the specified value (20 kPa in this case). The MC100 continues to output the specified pressure.
9. To turn OFF the output, press the **SWEEP ↘ key** to select the falling sweep mode. The falling sweep indication LED lights. When the output monitor indicates 0%, the output pressure is zero. However, the output operation continues.
10. Confirm that the output pressure is zero, and then press the **OUTPUT key** to turn the output OFF. When the output turns OFF, the LED located above and to the left of the key turns OFF.

Performing Rising Sweep Repeatedly with the Repeat Function (see section 3.4, "Repeating the Output" (page 3-14)).

Example

The following settings will be used to explain the output procedure.

Condition

Maximum pressure: 20 kPa, interval: 60 s, sweep condition: rising sweep and falling sweep, with repeat function

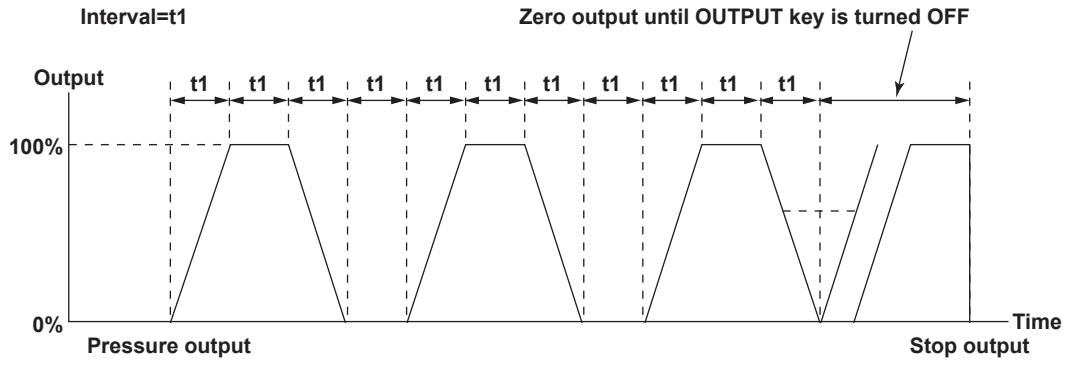

Procedure

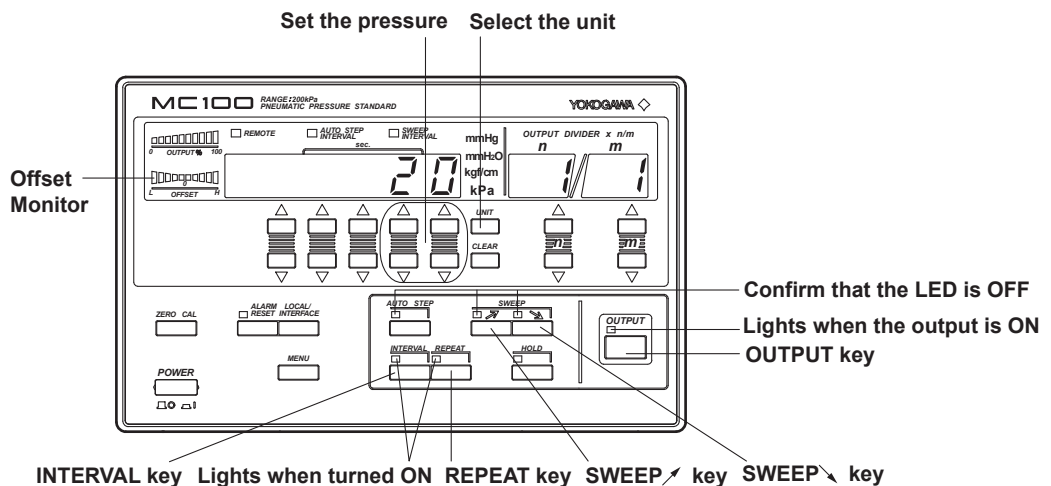

1. Confirm that the AUTO STEP indication LED, rising SWEEP indication LED, and falling SWEEP indication LED are OFF.
If any of the LEDs are ON, press the keys to turn them OFF.
2. Using the **pressure setting keys**, set the pressure to "20."
3. Press the **UNIT key** to turn ON "kPa." If the suffix code of the MC100 that you are using is "U1," this step is not necessary.
4. Press the **INTERVAL key**. The display shows the sweep interval.
5. Press the **pressure setting keys** to set the sweep interval to "60" s.
For the procedure on setting the sweep interval, see section 2.8, "Setting the Interval" (page 2-14).
6. Press the **SWEEP ↗ key** to select the rising sweep output mode. The rising sweep indication LED lights.
7. Press the **OUTPUT key** to turn ON the output. The LED located above and to the left of the key lights when the output is turned ON.
8. Press the **REPEAT key** to turn ON the repeat function. The LED located above and to the left of the key lights when the repeat function is turned ON. Repeat function continues until you turn OFF the output. For the procedure to repeat the output, see section 3.4, "Repeating the Output" (page 3-14).
9. To turn OFF the output, press the **REPEAT key** to turn OFF the repeat function.
10. Confirm that the output pressure stabilizes on the offset monitor, and then press the **SWEEP ↘ key** to select the falling sweep mode. The falling sweep indication LED lights.
11. Confirm that the output pressure is zero, and then press the **OUTPUT key** to turn the output OFF. When the output turns OFF, the LED located above and to the left of the key turns OFF.

Note

If you specify and execute the repeat function in the falling sweep mode, the output starts with the falling sweep.

3.4 Repeating the Output

If you use the repeat output function, auto-step and sweep operations can be repeated.

Setting the Repeat Function

You can specify the repeat function in the following range.

- During the auto-step output mode (with $n = 1$ and $m = 4$)

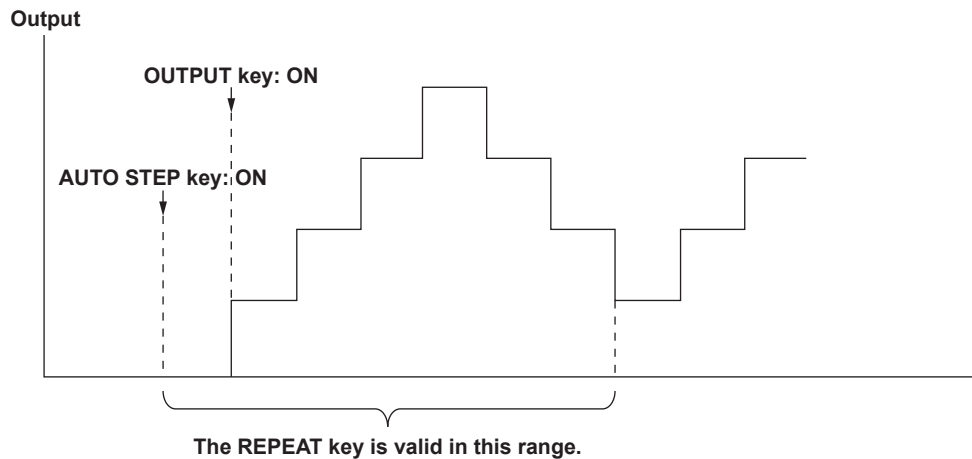

- During the sweep output mode

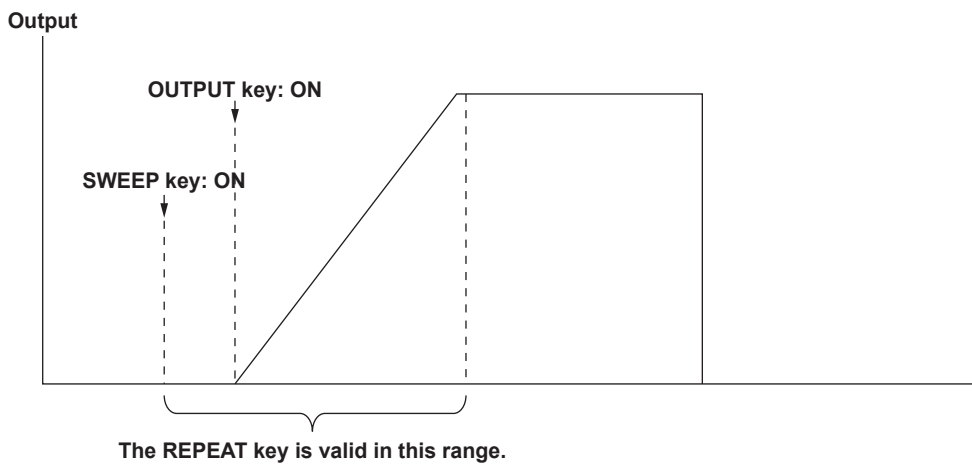

Releasing the Repeat Function during Output Operation

Press the **REPEAT** key to release the repeat function during output operation.

The output after you press the **REPEAT** key is as follows:

- Auto-step output mode: Perform the present cycle.
- Sweep output mode: Perform the sweep up to 100% during the rising sweep, down to 0% during the falling sweep.

3.5 Holding the Output

Press **HOLD** key to hold the output during auto-step or sweep operation.
When the output is held, the auto-step or sweep operation is paused and the current pressure is held.
The output period is as follows.

During the Auto-Step Output Mode

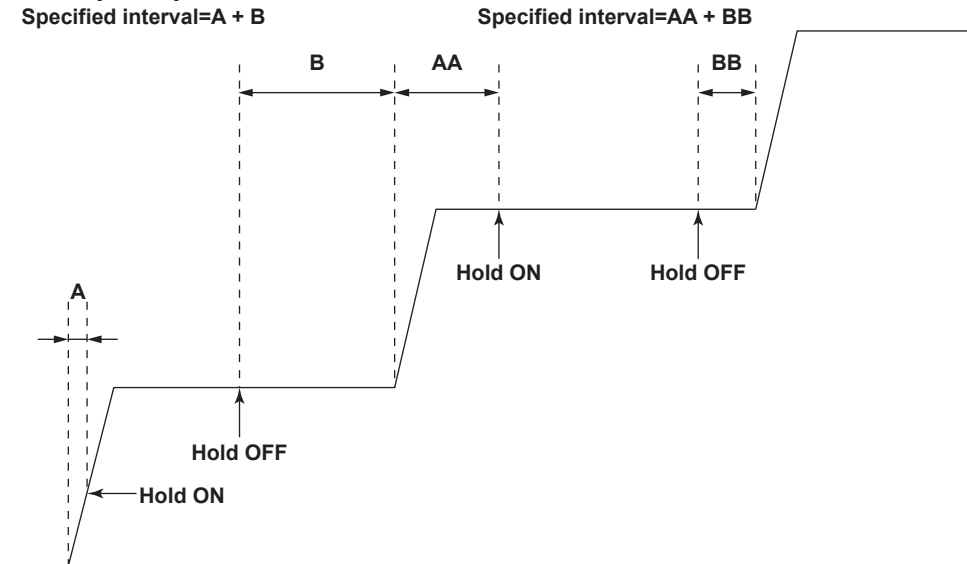

Note

If you specify the hold function in the middle of the rising or falling step, the value is held at the next step value.

During the Sweep Output Mode

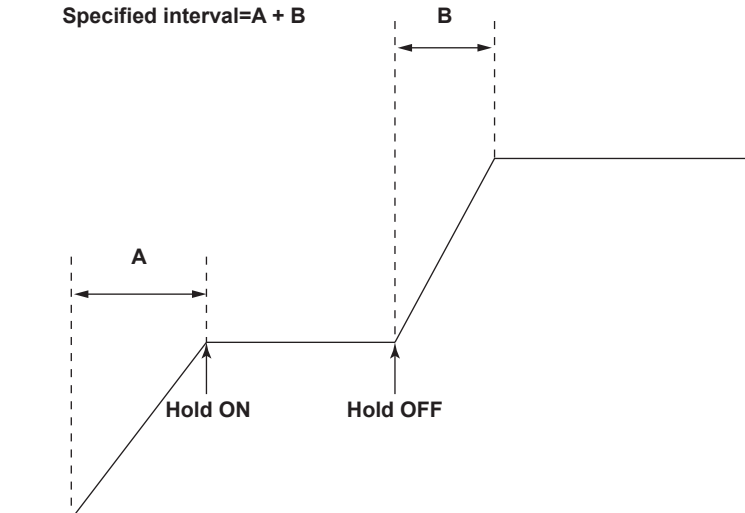

Note

It takes several seconds for the pressure to stabilize after the hold function is turned ON.

4.1 GP-IB Interface

The GP-IB interface can be used to control the MC100 remotely (using a controller) and output various types of data.

Functions Available through the GP-IB Interface

Function	Description
Listener function	<ul style="list-style-type: none"> • Functions available through panel key operation (excludes the power switch operation) • Request to receive setup data • Request to receive panel setting information • Request to receive status
Talker function	<ul style="list-style-type: none"> • Output setup data • Output panel setting information • Output status byte • Output status

Listener Function

- The listener function enables remote control of settings that can be accessed through the panel keys, except for the power switch. It also enables output of setup data in response to a command received from the controller.
- The listener function carries out operations according to the communication command received from the talker when the ATN (Attention) signal line is "False."
- The communication commands used by the MC100 consists of:
Command + Parameter + Terminator
ASCII codes are used to set these commands.
 - Command: Defined by one or two upper-case alphabet characters.
 - Parameter: Defined by numerical values (ASCII codes).
 - Terminator: CR LF
LF
EOI
; (semicolon)

Talker Function

- The talker function enables output of setup data, panel setting information, status byte, and status.

GP-IB Interface Specifications

- Electrical and mechanical specifications: Conforms to IEEE St'd 488-1978
- Functional specifications: SH1, AH1, T6, L4, SR1, RL1, PP0, DC1, DT1, and C0
- Code: ISO (ASCII) code
- Address setting: Specify the address between 0 and 30.
- Cancel remote mode: Clear remote mode by pressing the **LOCAL/INTERFACE key** (except when LOCAL LOCKOUT is enabled by the controller).

- **Functional specifications**

Function	Subset Name	Description
Source handshaking	SH1	All transmit handshaking functions available
Acceptor handshaking	AH1	All receive handshaking functions available
Talker	T6	Basic talker functions, serial polling functions, and talker cancellation function through MLA (My Listen Address) available
Listener	L4	Basic listener functions and listener cancel function through MTA (My Talk Address) available
Service request	SR1	All service request functions available
Remote local	RL1	All remote/local functions available
Parallel polling	PP0	No parallel polling functions
Device clear	DC1	All device clear functions available
Device trigger	DT1	All device trigger functions available
Controller	C0	No controller functions

Interface Messages that the MC100 Supports

- IFC (Interface Clear)
Releases talker and listener.
- REN (Remote Enable)
Transits to the remote mode.
- GTL (Go To Local)
Transits to the local mode.
- SDC (Selective Device Clear), DCL (Device Clear)
Sets the panel setting information of the MC100 to the same condition as when the MC100 is powered up.
- GET (Group Execute Trigger)
Executes the commands that change the output setting (O, S, D, UP, DW, DU, and DD). (Same as command "E")
- LLO (Local Lockout)
Disables the **LOCAL/INTERFACE key** of the front panel and prohibits transition to the local mode.

Operation to Switch Remote and Local

Remote mode is active when the REMOTE indication LED is ON. All front panel key operations except the **LOCAL/INTERFACE key** are not available.

To clear the remote mode, press the **LOCAL/INTERFACE key**. The REMOTE indication LED turns OFF and the MC100 enters the local mode. However, if Local Lockout is enabled by the controller, you cannot clear the remote mode using the **LOCAL/INTERFACE key**.

Setting the Address

Set the address of the MC100 within the following range:
0 to 30

Each device that can be connected via GP-IB has a unique address within the GP-IB system. This address is used to distinguish the device from others. Therefore, when you connect the MC100 to a PC, for example, make sure to assign a unique address to the MC100.

Note

While using the GP-IB, do not change the address of the controller or other devices that are connected to the controller.

Procedure

1. Press the **LOCAL/INTERFACE** key.

The display shows the following:



2. Press the pressure setting keys located below the address number to set the address number.
3. Press the **LOCAL/INTERFACE** key to return to the pressure display.

4.2 Serial (RS-232) Interface

The serial interface can be used to control the MC100 remotely (using a controller) and output various types of data.

Functions Available through the Serial Interface

Function	Description
Settings	<ul style="list-style-type: none">• Functions available through panel key operation (excludes the power switch operation)• Request to receive setup data• Request to receive panel setting information• Request to receive the status byte• Request to receive status
Output	<ul style="list-style-type: none">• Output setup data• Output status byte• Output status

Serial Interface Specifications

- Electrical characteristics: Conforms to EIA232 (RS-232)
- Connection: Pint-to-point
- Communication: Full-duplex
- Synchronization: Start-stop synchronization
- Baud rate: 1200, 2400, 4800, 9600
- Start bit: 1 bit
- Data length (word length): 7 or 8 bits
- Parity: Even, odd, or no parity
- Stop bit: 1 or 2 bits
- Hardware handshaking: Select whether to fix the CA and CB signals to TRUE or use the signal for flow control
- Software handshaking: Select whether to use the X-on and X-off signals to control the transmission data.
X-on (ASCII 11H)
X-off (ASCII 13H)
- Received buffer length: 256 bytes

Connection via Serial Interface

When you connect the MC100 to a PC, you must set the MC100 so that the handshaking method, data transfer rate, data format, etc. match those on the PC side.

For details on the settings, see the following pages. In addition, use an interface cable that meets the specifications of the MC100.

Connector and Signal Names

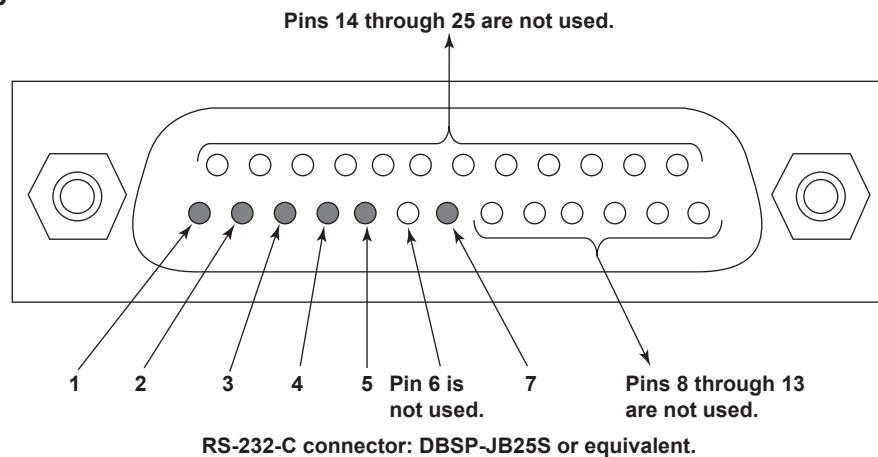

The numbers in the figure indicate pin numbers.

1 AA (GND: Protective Ground):	Grounded to the case.
2 BA (TXD: Transmitted Data):	Transmitted data to the PC. Signal direction:.....Output
3 BB (RXD: Received Data):	Received data from the PC. Signal direction:.....Input
4 CA (RTS: Request to Send):	Handshaking used to receive data from the PC. Signal direction:.....Output
5 CB (CTS: Clear to Send):	Handshaking used to send data to the PC. Signal direction:.....Input
7 AB (GND: Signal Ground):	Signal ground.

Note

Pins 6 and 8 through 25 are not used.

Signal Direction

The following figure shows the direction of the signals used by the serial interface of the MC100.

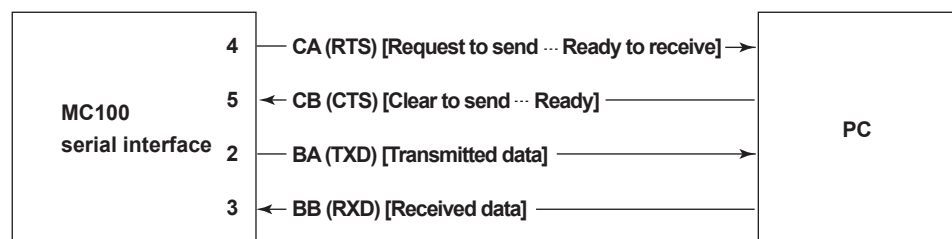

4.2 Serial (RS-232) Interface

RS-232 Standard Signals and Their JIS and CCITT Abbreviations

Signal table

Pin No. (25-pin connector)	Symbol			Name
	RS-232	CCITT	JIS	
1*	AA (GND)	101	FG	Protective ground
7*	AB (GND)	102	SG	Signal ground
2*	BA (TXD)	103	SD	Transmitted data
3*	BB (RXD)	104	RD	Received data
4*	CA (RTS)	105	RS	Request to send
5*	CB (CTS)	106	CS	Clear to send
6	CC (CSR)	107	DR	Data set ready
20	CD (DTR)	108/2	ER	Data terminal ready
22	CE (RI)	125	CI	Ring indicator
8	CF (DCD)	109	CD	Data channel received carrier detector
21	CG (-)	110	SRS	Data signal quality detector
23	CH/CI (-)	111	SRS	Data signal rate selector
24/15	DA/DB (TXC)	113/114	ST1/ST2	Transmission signal element timing
17	DD (RXC)	115	RT	Receiver signal element timing
14	SBA (-)	118	BSD	Secondary transmitted data
16	SBB (-)	119	BRD	Secondary received data
19	SCA (-)	120	BRS	Secondary request to send
13	SCB (-)	121	BCS	Secondary clear to send
12	SCF (-)	122	BCD	Secondary received line signal detector

* Serial (RS-232) interface pins that are used by the MC100.

Combination of Handshaking Methods

When using the serial interface for transferring data, it is necessary for equipment on both sides to agree on a set of rules to ensure the proper transfer of data. The set of rules is called handshaking. Because there are many handshaking methods that can be used between the MC100 and the PC, one must make sure that the same method is chosen by both the MC100 and the PC.

You can choose any of the four methods shown in the following table through key operation on the MC100.

Table of Handshaking Methods (O indicates that it is supported)

Mode selection No. (Handshaking method)	Data Transmission Control (Control used to send data to a PC)			Data Reception Control (Control used to receive data from a PC)		
	Software handshaking	Hardware handshaking	No handshaking	Software handshaking	Hardware handshaking	No handshaking
	Stops transmission when X-off is received. Resume when X-on is received.	Stops transmission when CB (CTS) is false. Resume when it is true.		Send X-off when the received data buffer is 3/4th filled. Send X-on when the received data buffer becomes 1/4th filled.	Set CA (RTS) to False when the received data buffer is 3/4th filled. Set to True when the received data buffer becomes 1/4th filled.	
0 (OFF-OFF)			○			○
1 (XON-XON)	○			○		
2 (XON-RTS)	○				○	
3 (CTS-RTS)		○			○	

Description of Each Handshaking Method

- **OFF-OFF**

Data transmission control

There is no handshaking between the MC100 and the PC. The “X-off” and “X-on” signals are treated as data, and the CB (CTS) signal is ignored.

Data reception control

There is no handshaking between the MC100 and the PC. When the received buffer becomes full, all overflow data are discarded. Therefore, the PC program must be designed so that the received buffers of both the MC100 and the PC do not become full. The CA (RTS) signal is fixed to True.

- **XON-XON**

Data transmission control

Software handshaking is performed between the MC100 and the PC. When an “X-off” code is received while sending data to the PC, the instrument stops the data transmission. When it receives the next “X-on” code, it resumes the data transmission. The CB (CTS) signal received from the PC is ignored.

Data reception control

Software handshaking is performed between the MC100 and the PC. When the free area of the receive buffer decreases to 64 bytes, the MC100 sends an “X-off” code. When the free area increases to 192 bytes, it sends an “X-on” code. The CA (RTS) signal is fixed to True.

- **XON-RTS**

Data transmission control

Software handshaking is performed between the MC100 and the PC. When an "X-off" code is received while sending data to the PC, the instrument stops the data transmission. When it receives the next "X-on" code, it resumes the data transmission. The CB (CTS) signal received from the PC is ignored.

Data reception control

Hardware handshaking is performed between the MC100 and the PC. When the free area of the receive buffer decreases to 64 bytes, the instrument sets "CA (RTS)=False." When the free area increases to 192 bytes, it sets "CA (RTS)=True."

- **CTS-RTS**

Data transmission control

Hardware handshaking is performed between the MC100 and the PC. When the CB (CTS) signal becomes False while sending data to the PC, the instrument stops the data transmission. When the CB (CTS) signal becomes True, it resumes the data transmission. The "X-off" and "X-on" signals are treated as data.

Data reception control

Hardware handshaking is performed between the MC100 and the PC. When the free area of the receive buffer decreases to 64 bytes, the instrument sets "CA (RTS)=False." When the free area increases to 192 bytes, it sets "CA (RTS)=True."

Precautions Regarding Data Receiving Control

When handshaking is used to control the reception of data, data may still be sent from the PC even if the free space in the receive buffer drops below 64 bytes. In this case, after the receive buffer becomes full, the excess data will be lost, whether or not handshaking is in effect. Data storage of data resumes when there is free space in the buffer.

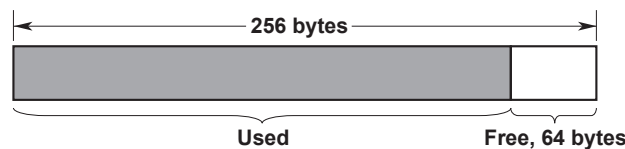

When handshaking is used, data reception will stop when the free space in the buffer drops to 64 bytes due to the inability to keep up with the data transfer.

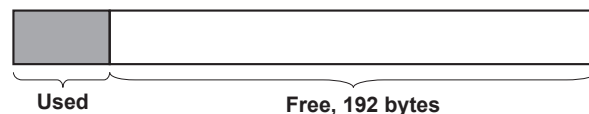

After data reception stops, data continue to be passed to the internal program. When the free space in the buffer increases to 192 bytes, data reception resumes.



If the buffer becomes full, data that overflow are discarded regardless of the handshaking.

Data Receiving Control through Handshaking

Setting the Data Format

The serial interface of the MC100 performs communications using start-stop synchronization. In start-stop synchronization, characters are transmitted one at a time. Each character consists of a start bit, data bits, a parity bit, and a stop bit (see the following figure).

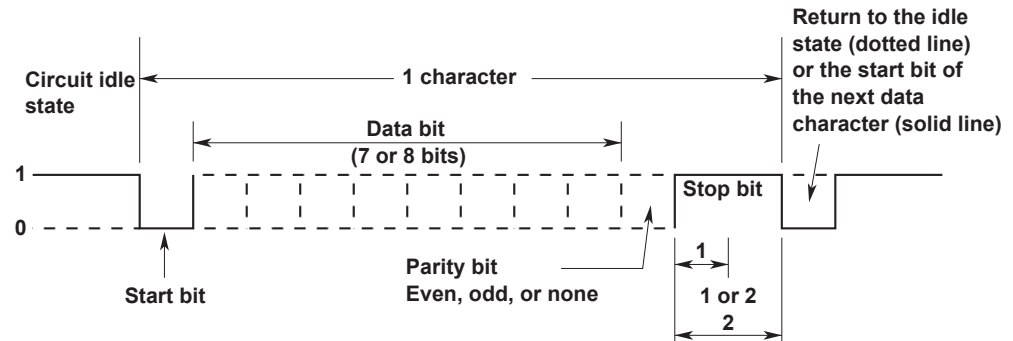

Setting the Serial Communication

Carry out the following settings when using a PC to set information that can be specified through key operation on the MC100 or when outputting setup data or output value data to the PC.

- **Selecting the handshaking method**

Select the transmit data control and receive data control from the following.

Setting	Handshaking Method
0	OFF-OFF
1	XON-XON
2	XON-RTS
3	CTS-RTS

- **Selecting the data format**

Select the combination of data length, parity, and stop bit from the following.

Setting	Data Length	Parity Bit	Stop Bit
0	8	None	1
1	7	Odd	1
2	7	Even	1
3	7	None	2

- **Selecting the baud rate**

Select the baud rate from the following.

1200
2400
4800
9600

Procedure

1. Press the **LOCAL/INTERFACE** key.

Setting the handshaking method

2. The display shows the following:



3. Press the lowest digit pressure setting keys to set the handshaking method.
4. Press the **LOCAL/INTERFACE** key.

Setting the data format

5. The display shows the following:



6. Press the lowest digit pressure setting keys to set the data format.
7. Press the **LOCAL/INTERFACE** key.

Setting the baud rate

8. The display shows the following:



9. Press the lowest digit pressure setting keys to set the baud rate.
10. Press the **LOCAL/INTERFACE** key.

4.3 Communication Commands

Commands Common to the GP-IB and Serial Interfaces

Item	Description	Program Data	Page
(1)	Set the unit	UNm	4-12
(2)	Set the output data	Sm, UPm, DWm	4-12, 4-13
(3)	Set the divider output	Dn/m, DUm, DDm	4-13, 4-14
(4)	Turn ON/OFF output	Om	4-14
(5)	Trigger	E, <GET>	4-14
(6)	Initialize settings	RC	4-14
(7)	Set auto-step and sweep	RUm	4-14
(8)	Set the interval	ASm, SWm	4-15
(9)	Set the repeat function	Mm	4-15
(10)	Set the hold function	HDm	4-15
(11)	Set the load capacity	LVm	4-15
(12)	Setting the monitor output range	DRm	4-15
(13)	Turn ON/OFF the beep sound	BPm	4-16
(14)	Output setup data	OS	4-16
(15)	Output output value data	OD	4-16
(16)	Output status	OC	4-16
(17)	Set the terminator of the output data	DLm	4-17
(18)	Set the header	Hm	4-17
(19)	Set zero calibration	ZA	4-17
(20)	Reset the source pressure alarm	AR	4-17
(21)	Mask the status byte	MSm	4-17

Command for the Serial Interface (Dedicated)

Item	Description	Program Data	Page
(22)	Set remote control	ESC R	4-18
(23)	Set local control	ESC L	4-18
(24)	Clear device	ESC C	4-18
(25)	Output status byte	ESC S	4-18

4.4 Description of Commands

The sample programs provided in this section are for explaining the usage of each command. When actually using the program, refer to section 4.5, "Sample Program," and make appropriate alterations to suit your application.

(1) Set the unit

UNm

Function Selects the desired unit of pressure to be displayed.

Syntax UNm<terminator>
m= 0: kgf/cm² (only for U2)
2: kPa
4: mmHzO (only for U2)
5: mmHg (only for U2)
6: psi (only for U3)
7: inHzO (only for U3)
8: inHg (only for U3)

Description The selectable units vary depending on the SUFFIX (suffix code) that you selected at the time of purchase.

Sample program

[GP-IB]

```
DEVICE$="DEV1" CALL IBFIND(DEVICE$,  
MC%) CALL IBSIC(MC%)  
CMD$="UN2" CALL IBWRT(MC%,CMD$)  
END
```

[Serial]

```
OPEN "COM1:" AS #1  
PRINT #1,"UN2"  
END
```

(2) Set the output data

Sm

Function Sets the pressure value.

Syntax Sm<terminator>
When the pressure display unit is kPa (UN2)
m=0.000 to 30.000 (for 767401)
m=0.00 to 240.00 (for 767402)

Description

- This command is executed by the trigger command, "E" <GET>.
- The value is expressed in floating-point representation.
- For the range of pressure values for pressure display units other than kPa, see section 2.6, "Setting the Pressure Display Unit, Output Pressure, Divider Ratio and Turning ON/OFF the Pressure Output" (page 2-11).

Sample program

[GP-IB]

```
DEVICE$="DEV1" CALL IBFIND(DEVICE$,  
MC%) CALL IBSIC(MC%)  
CMD$="S20.500" CALL IBWRT(MC%,CMD$)  
CMD$="E" CALL IBWRT(MC%,CMD$)  
END
```

[Serial]

```
OPEN "COM1:" AS #1  
PRINT #1,"S20.500"  
PRINT #1,"E"  
END
```

UPm

Function Increments the specified output data by each digit.

Syntax UPm<terminator>
 m=0: Increments the one's digit value.
 1: Increments the ten's digit value.
 2: Increments the hundred's digit value.
 3: Increments the thousand's digit value.
 4: Increments the ten thousand's digit value.

Description This command is executed by the trigger command, "E" <GET>.

Sample program

```
[GP-IB]
DEVICE$="DEV1" CALL IBFIND(DEVICE$,
MC%) CALL IBSIC(MC%)
CMD$="UP2" CALL IBWRT(MC%,CMD$)
CMD$="E" CALL IBWRT(MC%,CMD$)
END
[Serial]
OPEN "COM1:" AS #1
PRINT #1,"UP2"
PRINT #1,"E"
END
```

DWm

Function Decrements the specified output data by each digit.

Syntax DWm<terminator>
 m=0: Decrements the one's digit value.
 1: Decrements the ten's digit value.
 2: Decrements the hundred's digit value.
 3: Decrements the thousand's digit value.
 4: Decrements the ten thousand's digit value.

Description This command is executed by the trigger command, "E" <GET>.

Sample program

```
[GP-IB]
DEVICE$="DEV1" CALL IBFIND(DEVICE$,
MC%) CALL IBSIC(MC%)
CMD$="DW2" CALL IBWRT(MC%,CMD$)
CMD$="E" CALL IBWRT(MC%,CMD$)
END
[Serial]
OPEN "COM1:" AS #1
PRINT #1,"DW2"
PRINT #1,"E"
END
```

(3) Set the divider output**Dn/m**

Function Set the value n/m.

Syntax Dn/m<terminator>
 m=1 to 20 (denominator of the divider ratio).
 n=0 to m (numerator of the divider ratio)

Description This command is executed by the trigger command, "E" <GET>.

Sample program

```
[GP-IB]
DEVICE$="DEV1" CALL IBFIND(DEVICE$,
MC%) CALL IBSIC(MC%)
CMD$="D1/2" CALL IBWRT(MC%,CMD$)
CMD$="E" CALL IBWRT(MC%,CMD$)
END
[Serial]
OPEN "COM1:" AS #1
PRINT #1,"D1/2"
PRINT #1,"E"
END
```

DUm

Function Increments the value of n or m.

Syntax DUm<terminator>
 m=0: Increments the value of n.
 1: Increments the value of m.

Description This command is executed by the trigger command, "E" <GET>.

Sample program

```
[GP-IB]
DEVICE$="DEV1" CALL IBFIND(DEVICE$,
MC%) CALL IBSIC(MC%)
CMD$="DU0" CALL IBWRT(MC%,CMD$)
CMD$="E" CALL IBWRT(MC%,CMD$)
END
[Serial]
OPEN "COM1:" AS #1
PRINT #1,"DU0"
PRINT #1,"E"
END
```

4.4 Description of Commands

DDm

Function Decrements the value of n or m.

Syntax DDm<terminator>
m=0: Decrements the value of n.
1: Decrements the value of m.

Description This command is executed by the trigger command, "E" <GET>.

Sample program

```
[GP-IB]
DEVICE$="DEV1" CALL IBFIND (DEVICE$,
MC%) CALL IBSIC (MC%)
CMD$="DD0" CALL IBWRT (MC%,CMD$)
CMD$="E" CALL IBWRT (MC%,CMD$)
END

[Serial]
OPEN "COM1:" AS #1
PRINT #1,"DD0"
PRINT #1,"E"
END
```

(4) Turns ON/OFF the output

Om

Function Turns ON/OFF the output.

Syntax Om<terminator>
m=0: Output OFF
1: Output ON

Description This command is executed by the trigger command, "E" <GET>.

Sample program

```
[GP-IB]
DEVICE$="DEV1" CALL IBFIND (DEVICE$,
MC%) CALL IBSIC (MC%)
CMD$="O1" CALL IBWRT (MC%,CMD$)
CMD$="E" CALL IBWRT (MC%,CMD$)
END

[Serial]
OPEN "COM1:" AS #1
PRINT #1,"O1"
PRINT #1,"E"
END
```

(5) Trigger

E

Function Executes output of data and output ON and OFF.

Syntax E<terminator>
<GET>

Description <GET> is valid only for GP-IB.

(6) Initialize settings

RC

Function Initializes all setup data of the MC100. However, communication settings are not initialized.

Syntax RC<terminator>

Sample program

```
[GP-IB]
DEVICE$="DEV1" CALL IBFIND (DEVICE$,
MC%) CALL IBSIC (MC%)
CMD$="RC" CALL IBWRT (MC%,CMD$)
END

[Serial]
OPEN "COM1:" AS #1
PRINT #1,"RC"
END
```

(7) Set auto-step and sweep

RUm

Function Sets or stops the auto-step or sweep function.

Syntax RUm<terminator>
m= 0: Release.
1: Set auto-step.
2: Set sweep ↗.
3: Set sweep ↘.

Description RU0: Corresponds to turning OFF the AUTO STEP key and SWEEP ↗/↘ keys.
RU1: Corresponds to turning ON the AUTO STEP key.
RU2: Corresponds to pressing the SWEEP ↗ key.
RU3: Corresponds to pressing the SWEEP ↘ key.

Sample program

```
[GP-IB]
DEVICE$="DEV1" CALL IBFIND (DEVICE$,
MC%) CALL IBSIC (MC%)
CMD$="RU1" CALL IBWRT (MC%,CMD$)
END

[Serial]
OPEN "COM1:" AS #1
PRINT #1,"RU1"
END
```

(8) Set the interval**ASm****Function** Sets the interval for auto-step operation.**Syntax** ASm<terminator>
m=10 to 600 (s) Resolution of m: 5 s**Sample program**

```
[GP-IB]
DEVICE$="DEV1" CALL IBFIND(DEVICE$,
MC%) CALL IBSIC(MC%)
CMD$="AS100" CALL IBWRT(MC%,CMD$)
END
[Serial]
OPEN "COM1:" AS #1
PRINT #1,"AS100"
END
```

SWm**Function** Sets the interval for sweep operation.**Syntax** SWm<terminator>
m=15 to 600 (s) Resolution of m: 5 s**Sample program**

```
[GP-IB]
DEVICE$="DEV1" CALL IBFIND(DEVICE$,
MC%) CALL IBSIC(MC%)
CMD$="SW200" CALL IBWRT(MC%,CMD$)
END
[Serial]
OPEN "COM1:" AS #1
PRINT #1,"SW200"
END
```

(9) Set the repeat function**Mm****Function** Turns ON/OFF the repeat function.**Syntax** Mm<terminator>
m= 0: Repeat the operation.
1: Do not repeat the operation.**Sample program**

```
[GP-IB]
DEVICE$="DEV1" CALL IBFIND(DEVICE$,
MC%) CALL IBSIC(MC%)
CMD$="M0" CALL IBWRT(MC%,CMD$)
END
[Serial]
OPEN "COM1:" AS #1
PRINT #1,"M0"
END
```

(10) Set the hold function**Hm****Function** Turns ON/OFF the hold function.**Syntax** Hm<terminator>
m= 0: Hold OFF
1: Hold ON**Sample program**

```
[GP-IB]
DEVICE$="DEV1" CALL IBFIND(DEVICE$,
MC%) CALL IBSIC(MC%)
CMD$="HD1" CALL IBWRT(MC%,CMD$)
END
[Serial]
OPEN "COM1:" AS #1
PRINT #1,"HD1"
END
```

(11) Set the load capacity**Lm****Function** Sets the load capacity.**Syntax** Lm<terminator>
m= 0: Small (0 to 100 cc)
1: Middle (100 to 500 cc)
2: Large (500 to 1000 cc)**Sample program**

```
[GP-IB]
DEVICE$="DEV1" CALL IBFIND(DEVICE$,
MC%) CALL IBSIC(MC%)
CMD$="LV0" CALL IBWRT(MC%,CMD$)
END
[Serial]
OPEN "COM1:" AS #1
PRINT #1,"LV0"
END
```

(12) Set the monitor output range**DRm****Function** Sets the monitor output range.**Syntax** DRm<terminator>
m= 0: (Low) 10 mV/Full Scale
1: (High) 2 V/Full Scale**Sample program**

```
[GP-IB]
DEVICE$="DEV1" CALL IBFIND(DEVICE$,
MC%) CALL IBSIC(MC%)
CMD$="DR0" CALL IBWRT(MC%,CMD$)
END
[Serial]
OPEN "COM1:" AS #1
PRINT #1,"DR0"
END
```

(13) Turn ON/OFF the beep sound

BPm

Function Turns ON/OFF the beep sound.

Syntax Bpm<terminator>
m= 0: Beep sound OFF
1: Beep sound ON

Sample program

```
[GP-IB]
DEVICE$="DEV1" CALL IBFIND(DEVICE$,
MC%) CALL IBSIC(MC%)
CMD$="BP1" CALL IBWRT(MC%,CMD$)
END
[Serial]
OPEN "COM1:" AS #1
PRINT #1,"BP1"
END
```

(14) Output setup data

OS

Function Outputs the current panel setup data (information).

Syntax OS<terminator>

Description For details on the setup data output format, see page App-4.

Sample program

```
[GP-IB]
DEVICE$="DEV1" CALL IBFIND(DEVICE$,
MC%) CALL IBSIC(MC%)
CMD$="OS" CALL IBWRT(MC%,CMD$)
LOOP1
D$=SPACE$(20) CALL IBRD(MC%,D$)
D$=LEFT(D$,IBCNT%-2)
PRINT D$
IF D$<>"END" GOTO LOOP1
END
[Serial]
OPEN "COM1:" AS #1
PRINT #1,"OS"
LOOP1:
INPUT #1;D$
PRINT D$
IF D$<>"END" GOTO LOOP1
END
```

(15) Output output value data

OD

Function Outputs the specified output value data.

Syntax OD<terminator>

Description For details on the output format of the output value data, see page App-3.

Output example

```
NMPa100.00, 1/1 CRLF
```

Sample program

```
[GP-IB]
DEVICE$="DEV1" CALL IBFIND(DEVICE$,
MC%) CALL IBSIC(MC%)
CMD$="OD" CALL IBWRT(MC%,CMD$)
CMD$="E" CALL IBWRT(MC%,CMD$)
PRINT D$
END
[Serial]
OPEN "COM1:" AS #1
PRINT #1,"OD"
LINE INPUT #1;D$
PRINT D$
END
```

(16) Output status

OC

Function Outputs the current status.

Syntax OC<terminator>(data: 0 to 127)

Output example

```
STS1=127 CRLF
```

Description

- For details on the status output format, see page App-4.
- The 8-bit binary value is represented in decimal notation.

Sample program

```
[GP-IB]
DEVICE$="DEV1" CALL IBFIND(DEVICE$,
MC%) CALL IBSIC(MC%)
CMD$="OC" CALL IBWRT(MC%,CMD$)
D$=SPACE$(20) CALL IBRD(MC%,D$)
D$=LEFT(D$,IBCNT%-2)
PRINT D$
END
[Serial]
OPEN "COM1:" AS #1
PRINT #1,"OC"
LINE INPUT #1;D$
PRINT D$
END
```

(17) Set the terminator of the output data**DLm****Function** Sets the terminator of the output data.

Syntax DLm<terminator>(GP-IB)
 m= 0: CR/LF/EOI
 1: LF
 2: EOI
 DLm<terminator>(serial)
 m= 0: CR/LF
 1: LF
 2: CR

Sample program

[GP-IB]
 DEVICE\$="DEV1" CALL IBFIND(DEVICE\$,
 MC%) CALL IBSIC(MC%)
 CMD\$="DL0" CALL IBWRT(MC%,CMD\$)
 END
[Serial]
 OPEN "COM1:" AS #1
 PRINT #1,"DL0"
 END

(18) Set the header**Hm****Function** Sets whether or not to attach a header to the output data.

Syntax Hm<terminator>
 m= 0: No header
 1: Attach header

Sample program

[GP-IB]
 DEVICE\$="DEV1" CALL IBFIND(DEVICE\$,
 MC%) CALL IBSIC(MC%)
 CMD\$="H1" CALL IBWRT(MC%,CMD\$)
 END
[Serial]
 OPEN "COM1:" AS #1
 PRINT #1,"H1"
 END

(19) Set zero calibration**ZA****Function** Performs zero calibration.**Syntax** ZA<terminator>**Sample program**

[GP-IB]
 DEVICE\$="DEV1" CALL IBFIND(DEVICE\$,
 MC%) CALL IBSIC(MC%)
 CMD\$="ZA" CALL IBWRT(MC%,CMD\$)
 END
[Serial]
 OPEN "COM1:" AS #1
 PRINT #1,"ZA"
 END

(20) Reset the source pressure alarm**AR****Function** If the source pressure alarm is activated due to abnormal source pressure, this command resets the alarm.**Syntax** AR<terminator>**Sample program**

[GP-IB]
 DEVICE\$="DEV1" CALL IBFIND(DEVICE\$,
 MC%) CALL IBSIC(MC%)
 CMD\$="AR" CALL IBWRT(MC%,CMD\$)
 END
[Serial]
 OPEN "COM1:" AS #1
 PRINT #1,"AR"
 END

(21) Mask the status byte**MSm****Function** Sets the cause of the interrupt of the status byte. The specified cause is activated and an interrupt to be generated.**Syntax** MSm<terminator>
 m = 0 to 29**Description** For details on the status byte, see page App-3.**Sample program**

[GP-IB]
 DEVICE\$="DEV1" CALL IBFIND(DEVICE\$,
 MC%) CALL IBSIC(MC%)
 CMD\$="MS1" CALL IBWRT(MC%,CMD\$)
 CMD\$="00E" CALL IBWRT(MC%,CMD\$)
 POLL 1,B CALL IBRSP(MC%,B%)
 CMD\$="01E" CALL IBWRT(MC%,CMD\$)
 LOOP1
 POLL 1,B CALL IBRSP(MC%,B5)
 PRINT B%
 IF (B% AND &H40)=0 GOTO LOOP1
 END
[Serial]
 OPEN "COM:" AS #1
 PRINT #1,"MS1"
 PRINT #1,"00E"
 PRINT #1,CHR\$(&H1B)+"S"
 INPUT #1,D\$
 PRINT #1,"01E"
 LOOP1
 PRINT #1,CHR\$(&H1B)+"S"
 INPUT #1,D\$
 PRINT D\$
 IF (VAL(MID\$(D\$,6)) AND &H40)=0 GOTO
 LOOP1
 END

(22) Set remote control (for serial only)

ESC R

Function Enables the MC100 to be remotely controlled via serial communications. Once in the remote mode, panel key operations are not allowed.

Syntax ESC R<terminator>

Description

- ESC=1BH in the ASCII character code set.
- For details on the ASCII character codes, see page App-2.

(23) Set local control (for serial only)

ESC L

Function Sets the MC100 to the local mode from the remote mode via serial communications. Panel key operations are possible in the local mode.

Syntax ESC L<terminator>

Description

- ESC=1BH in the ASCII character code set.
- For details on the ASCII character codes, see page App-2.

(24) Clear device (for serial only)

ESC C

Function Sets the panel setting information of the MC100 to the same condition as when the MC100 is powered up.

Syntax ESC C<terminator>

Description

- ESC=1BH in the ASCII character code set.
- For details on the ASCII character codes, see page App-2.

(25) Output status byte

ESC S

Function Outputs the status byte (for serial communications).

Syntax ESC S<terminator>

Output example

```
STS0=125CRLF (for serial  
communications)
```

Description

- ESC=1BH in the ASCII character code set.
- For details on the ASCII character codes, see page App-2.
- For details on the status byte, see page App-4.

4.5 Sample Program

Environment

Model: MS-DOS computer equipped with AT-GPIB/TNT IEEE-488.2 board from National Instruments.

Language: Quick BASIC

Sample 1

• GP-IB

```
*****
\*
\* MC100 Sample Program1 for GP-IB interface
\* Microsoft QuickBASIC 4.0/4.5 Version
\*
*****
\*
\* Set the pressure to 200.00 kPa, divider ratio to 1/1, and turn ON the
\* output. Then, read and display the setup data. When a key is pressed,
\* the pressure is set to zero and the output is stopped. (Before
\* executing the following program, allow at least five minutes of warm-up
\* after turning ON the power and perform zero calibration by pressing the
\* ZERO CAL key.)
\*
\*
*****
\
\
REM $INCLUDE: 'qbdecl.bas'
\
\/* Initialize GP-IB */
\
\
BORD$ = "GPIB0": CALL IBFIND(BORD$, BD%)
CALL IBSIC(BD%)
DEVICE$ = "DEV1": CALL IBFIND(DEVICE$, MC%)
CALL IBSIC(MC%)
V% = 1: CALL IBSRE(BD%, V%)          \ Set to remote mode
\
\
\/* Set the MC100 */
\
\
CMD$ = "S200": CALL IBWRT(MC%, CMD$)          \ Pressure: 200.00 kPa
CMD$ = "D1/1": CALL IBWRT(MC%, CMD$)          \ Divider ratio: 1/1
CMD$ = "O1E" : CALL IBWRT(MC%, CMD$)          \ Output: on
\
\
\/* Read setup data */
\
\
CMD$ = "OD" : CALL IBWRT(MC%, CMD$)          \ Output setup data
D$ = SPACE$(20)
CALL IBRD(MC%, D$)
PRINT LEFT$(D$, IBCNT% - 2)
\
\
\/* Determine output stop */
\
\
PRINT "Press a key to abort."
WHILE (INKEY$="")
WEND
```

4.5 Sample Program

```
CMD$ = "S0E" : CALL IBWRT(MC%, CMD$)           ` Pressure: 0 kPa
`
FOR I = 1 TO 5000                               ` Wait period (enough time for the
output pressure to drop to 0 kPa)
  FOR J = 1 TO 1000
    NEXT J
  NEXT I
`
CMD$ = "00E" : CALL IBWRT(MC%, CMD$)           ` Output: off
`
`
`/* Terminate GP-IB */
`
V% = 0: CALL IBSRE(BD%, V%)                     ` Set to local mode
`
`
END
```

- **Serial (RS-232)**

```

\*****
\*
\* MC100 Sample Program1 for RS-232 interface
\* Microsoft QuickBASIC 4.0/4.5 Version
\*
\* Rate:9600 Parity:None CHR:8 STOPBIT:1 XON/XON Term:CR+LF
\*
\*****
\
\/* Initialize RS-232 */
\
OPEN "COM1:9600,N,8,1,ASC,CS0,DS0,LF" FOR RANDOM AS #1
\
\
\/* Set the MC100 */
\
PRINT #1, CHR$( &H1B) + "R" \ Set to remote mode
\
\
PRINT #1, "S200" \ Pressure: 200.00 kPa
PRINT #1, "D1/1" \ Divider ratio: 1/1
PRINT #1, "O1E" \ Output: on
\
\
\/* Read setup data */
\
PRINT #1, "OD" \ Output setup data
LINE INPUT #1, D$
PRINT D$
\
\
\/* Determine output stop */
\
PRINT "Press a key to abort."
WHILE (INKEY$="")
WEND
PRINT #1, "S0E" \ Pressure: 0 kPa
\
FOR I = 1 TO 5000 \ Wait period
FOR J = 1 TO 1000
NEXT J
NEXT I
\
PRINT #1, "O0E" \ Output: off
\
\
\/* Terminate RS-232 */
\
PRINT #1, CHR$( &H1B) + "L" \ Set to local mode
CLOSE #1
\
\
END

```

Sample 2

• GP-IB

```

*****
\*
\* MC100 Sample Program2 for GP-IB interface
\* Microsoft QuickBASIC 4.0/4.5 Version
\*
*****
\*
\* Using the auto-step function of the MC100, output the pressure in the
\* following fashion: 40kPa-80kPa-120kPa-160kPa-200kPa. When a key is
\* pressed, the output is stopped.
\* (Before executing the following program, allow at least five minutes of
\* warm-up after turning ON the power and perform zero calibration by
\* pressing the ZERO CAL key.)
\*
*****
\
REM $INCLUDE: 'qbdecl.bas'
\
\/* Initialize GP-IB */
\
BORD$ = "GPIB0": CALL IBFIND(BORD$, BD%)
CALL IBSIC(BD%)
DEVICE$ = "DEV1": CALL IBFIND(DEVICE$, MC%)
CALL IBSIC(MC%)
V% = 1: CALL IBSRE(BD%, V%)           \ Set to remote mode
\
\
\/* Set the MC100 */
\
CMD$ = "S200E": CALL IBWRT(MC%, CMD$)   \ Pressure: 200.00 kPa
CMD$ = "D1/5E": CALL IBWRT(MC%, CMD$)   \ Divider ratio: 1/5
CMD$ = "AS60" : CALL IBWRT(MC%, CMD$)   \ Interval: 60 s
CMD$ = "RU1"  : CALL IBWRT(MC%, CMD$)   \ Set auto-step
CMD$ = "M0"   : CALL IBWRT(MC%, CMD$)   \ Enable the repeat function
\
\
\/* Output using auto-step */
\
CMD$ = "O1E" : CALL IBWRT(MC%, CMD$)     \ Output: on
\
\
\/* Determine output stop */
\
PRINT "Press a key to abort"
WHILE (INKEY$="")
WEND
\
CMD$ = "O0E" : CALL IBWRT(MC%, CMD$)     \ Output: off
\
\
\/* Terminate GP-IB */
\
V% = 0: CALL IBSRE(BD%, V%)           \ Set to local mode
\
\
END

```

- **Serial (RS-232)**

```

\*****
\*
\* MC100 Sample Program2 for RS-232 interface
\* Microsoft QuickBASIC 4.0/4.5 Version
\*
\* Rate:9600 Parity:None CHR:8 STOPBIT:1 XON/XON Term:CR+LF
\*
\*****
\
\/* Initialize RS-232 */
\
OPEN "COM1:9600,N,8,1,ASC,CS0,DS0,LF" FOR RANDOM AS #1
\
\
\/* Set the MC100 */
\
PRINT #1, CHR$(&H1B)+"R" \ Set to remote mode
\
\
PRINT #1, "S200E" \ Pressure: 200.00 kPa
PRINT #1, "D1/5E" \ Divider ratio: 1/5
PRINT #1, "AS60" \ Interval: 60 s
PRINT #1, "RU1" \ Set auto-step
PRINT #1, "M0" \ Enable the repeat function
\
\
\/* Output using auto-step */
\
PRINT #1, "O1E" \ Output: on
\
\
\/* Determine output stop */
\
PRINT "Press a key to abort."
WHILE (INKEY$="")
WEND
\
PRINT #1, "O0E" \ Output: off
\
\
\/* Terminate RS-232 */
\
PRINT #1, CHR$(&H1B)+"L" \ Set to local mode
CLOSE #1
\
\
END

```

5.1 Troubleshooting

Items to Check when Problems Occur

If the MC100 is not operating correctly after performing the following corrective actions, the corrective action indicates “Servicing required,” or other problems are detected, contact your nearest YOKOGAWA dealer as listed on the back cover of this manual.

Symptom	Items to Check	Page
Nothing shows up on the display when the power switch is turned ON.	<ul style="list-style-type: none"> Is the main power switch turned ON? 	2-5
The output pressure value is not correct.	<ul style="list-style-type: none"> Are the ambient temperature and humidity within the allowed ranges? Are the connections correct? 	2-2, 6-2 2-8
Cannot operate the keys.	<ul style="list-style-type: none"> Is “REMOTE” showing on the upper left corner of the display? 	4-2
Cannot configure or control the MC100 via the GP-IB interface.	<ul style="list-style-type: none"> Is the GP-IB address of the MC100 written in the program match the GP-IB address specified on the MC100? Are the electrical and mechanical specifications of the IEEE Standard 488-1978 satisfied? 	4-3 4-2
Cannot configure or control the MC100 via the serial interface.	<ul style="list-style-type: none"> Are the communication specifications between the MC100 and controller matched? 	4-4

Error Code Description and Corrective Actions

Error No.	Error Description	Cause of the Error	Corrective Action
05	Output operation error	<ul style="list-style-type: none"> Pressed the ZERO CAL key while outputting pressure. Pressed the OUTPUT key during zero calibration. Executed auto-step operation with the pressure set to 0 or with the divider ratio set to $n = m$. Executed sweep operation with the pressure set to 0. 	
08	Abnormal source pressure (too small)	The source pressure is too small.	Apply a prescribed source pressure and press the ALARM RESET key.
09	Abnormal source pressure (too large)	The source pressure is too large.	Apply a prescribed source pressure and press the ALARM RESET key.
11	Communication command error	Received a command that is not used by the MC100.	Check that the command you sent is correct.
12	Parameter error	Specified a parameter outside the allowed range.	Correct the value so that the parameter is within the allowed range.
17	Zero calibration error	Pressed the ZERO CAL key when the standard pressure is off by a great amount with respect to the initial value.	Remove the residual pressure of the load and try again.
60*	Setup data backup error (other than communication settings)	The panel setting information other than communication settings is corrupt.	The panel setting information other than communication settings will be reset.
61*	Setup data backup error (communication settings)	Communication settings are corrupt.	The communication settings will be reset.
70	Motor error	The driving section of the pressure output is abnormal.	Servicing required.
71	Motor error	The driving section of the pressure output is abnormal.	Servicing required.
72	Motor error	The driving section of the pressure output is abnormal.	Servicing required.
73	Motor error	The driving section of the pressure output is abnormal.	Servicing required.
83*	EEPROM error (pressure control value)	EEPROM contents (pressure control value) are corrupt.	Servicing required.
84*	EEPROM error (monitor output calibration value)	EEPROM contents (monitor output calibration value) are corrupt.	Servicing required.
90	Output pressure detection error	The output pressure detection section is abnormal.	Servicing required.
91	Output pressure detection error	The output pressure detection section is abnormal.	Servicing required.
92	Output pressure detection error	The output pressure detection section is abnormal.	Servicing required.

5.1 Troubleshooting

Error No.	Error Description	Cause of the Error	Corrective Action
93	Output pressure detection error	The output pressure detection section is abnormal.	Servicing required.
94	Output pressure detection error	The output pressure detection section is abnormal.	Servicing required.
95	Hardware error	The hardware is abnormal.	Servicing required.
96	Hardware error	The hardware is abnormal.	Servicing required.
97	Hardware error	The hardware is abnormal.	Servicing required.
98	Hardware error	The hardware is abnormal.	Servicing required.
99	Hardware error	The hardware is abnormal.	Servicing required.

*If an error appears during power up, the error remains displayed until a key is pressed.

5.2 Storing the MC100 and Replacing the Fuse

Storage

When storing the MC100, avoid the following locations:

- Where the humidity is high.
- In direct sunlight or in a hot place.
- Near heat sources
- Where mechanical vibration is high.
- In a place filled with dirt, dust, salt, and corrosive gases.

Replacing the Fuse



WARNING

- To prevent fire, only use a fuse of the specified rating. Never use a fuse of any other rating and never short-circuit the fuse holder to bypass the fuse.
- Never operate the instrument if you have any reason to suspect any defect or problem with the fuse.
- Before replacing the fuse, be sure to turn the POWER and MAIN POWER switches OFF, remove the connections from each input and output terminal, and remove the power cord from the AC outlet.

French



AVERTISSEMENT

- Afin d'éviter tout risque d'incendie, utilisez uniquement un fusible de la cote spécifiée. N'utilisez jamais de fusible d'une autre cote et ne mettez jamais le porte-fusible en court-circuit pour contourner le fusible.
- Ne faites jamais fonctionner l'instrument si, pour quelque raison que ce soit, vous suspectez un défaut ou un problème du fusible.
- Avant de remplacer le fusible, assurez-vous de mettre hors tension les interrupteurs POWER et MAIN POWER, de retirer les branchements de chaque borne d'entrée et de sortie, et de retirer le cordon d'alimentation de la prise secteur.

5.2 Storing the MC100 and Replacing the Fuse

- **Location of the fuse**

The fuse is attached to the fuse holder located to the right of the power connector on the rear panel.

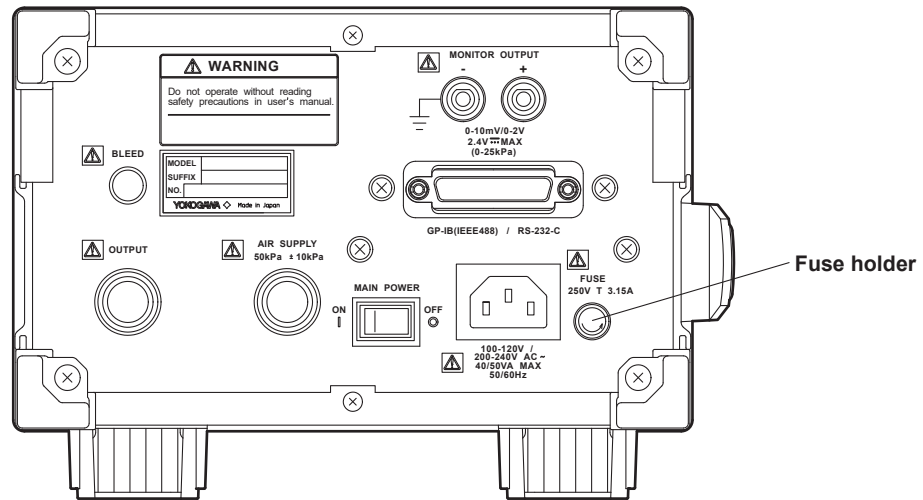

- **Fuse rating**

Rated voltage Time lag fuse rated for 250 V and 3.15 A.
(Order part number: A1113EF)

- **Procedure for replacing the fuse**

1. Turn OFF the main power switch and the power switch.
2. Remove the power cord from the outlet and inlet.
3. Remove the fuse holder cap and replace with the spare fuse provided.

5.3 Calibration

We recommend that you calibrate the MC100 once every six months to assure its measurement accuracy over a long period of time.
To have your MC100 calibrated, contact your nearest YOKOGAWA dealer.

5.4 Recommended Replacement Parts

We recommend periodic replacement so that you will be able to use the MC100 for a long period of time. Contact your nearest YOKOGAWA dealer for replacement parts.

Parts Name	Part Number	Replacement Period
Motor Assembly	B9984EP	Approx. 2000 hours at normal use

6.1 Specifications

Model	767401	767402
Source pressure ^{*1}	50±10 kPa	280±20 kPa
Maximum source pressure	100 kPa	500 kPa
Pressure output range ^{*2}	0 to 25.000 kPa	0 to 200.00 kPa
Minimum resolution	0.001 kPa	0.01 kPa
Accuracy (at reference test conditions ^{*3})	Including calibration accuracy: ±0.05% of full scale Excluding calibration accuracy: ±0.045% of full scale	
Output noise	±0.02% of full scale	
Pressure display unit	Select from the following at the time of purchase: kPa kPa, kgf/cm ² , mmHg, mmH ₂ O kPa, psi, inHg, inH ₂ O	
Output settings	4.5-digit setting	
Manual (divider ratio) output	Outputs a pressure equal to the specified value x n/m (n = 0 to m, m = 1 to 20), where n/m is less than or equal to 100%.	
Auto-step output	Outputs manual (divider ratio) output using a specified step pattern.	
Interval	10 s to 600 s (10 minutes) at 5 s increments.	
Repetition	Once or infinite number of times (can be stopped)	
Sweep output	Outputs pressure in a increasing and decreasing linear fashion between 0% and 100% of the specified pressure over the specified interval. (no load condition (10 cc or less))	
Interval	15 s to 600 s (10 minutes) at 5 s intervals.	
Repetition	Once or infinite number of times (can be stopped)	
Output monitor	Displays 0% to 100% with respect to the specified value on a 10-segment LED bar graph. Sounds the buzzer when the output value reaches the specified value (100%) during auto-step output or sweep output.	
Offset monitor	Indicates the deviation from the final value.	
Temperature coefficient		
Zero drift	±0.003% of full scale/°C ^{*4}	
Sensitivity	±0.002% of full scale/°C ^{*4}	
Tilt sensitivity	Front and back 90: ±0.1% of full scale ^{*4} Left and right 30: ±2.5% of full scale ^{*4}	Front and back 90: ±0.01% of full scale ^{*4} Left and right 30: ±0.2% of full scale ^{*4}
Communication interface	Select GP-IB or serial at the time of purchase.	

*1 Use a filtered reducing valve for the source pressure and provide stable pressure.

*2 Can output up to 120%, but the accuracy is not guaranteed.

*3 Reference test conditions: Ambient temperature: 23±3°C. Use a source pressure through a filtered reducing valve. Dry supply air at 23°C.

*4 Full scale: Indicates the pressure output range.

6.1 Specifications

- **General Specifications**

Composition:	Pressure setting section, servo valve, and pressure sensor, all in a single unit
Operating principle:	Uses a needle valve type servo valve
Pressure sensor:	Silicon resonant sensor
Source pressure:	Dry air at 5 to 40°C with minimal temperature fluctuation
Input/Output connection:	Select Rc1/4 or NPT1/4 internal thread (provided on the rear panel) at the time of purchase
Output response time:	Approx. 5 s (time it takes for the output to settle within $\pm 0.1\%$ of full scale) under no-load condition (10 cc or less) for any single 20% to 25% divider output step
Monitor output:	Allows monitoring of the output condition through voltage output (up to the maximum specified output) 0 to 10 mV/full scale or 0 to 2 V/full scale
Calibration interval:	Approx. 6 months
Air consumption:	Approx. 30 l/min (when using source pressure that meets the specifications)
Pressure value display:	7-segment LED (4.5 digits, character height: approx. 15 mm)
Error indication:	ALARM indication at low or excessive source pressure
Operating environment:	Temperature 5 to 40°C Humidity 20 to 80%RH, no condensation
Warm-up time:	Approx. 5 minutes
Rated supply voltage range:	100-120 VAC/200-240 VAC
Permitted supply voltage range:	90 to 132 VAC/180 to 264 VAC
Rated supply voltage frequency:	50/60 Hz
Permitted supply voltage frequency range:	47 to 63 Hz
Withstand voltage:	1,500 VAC at 50/60 Hz for one minute (between the AC power supply and case)
Insulation Resistance:	100 M Ω or more at 500 VDC (between the AC power supply and case)
Power consumption:	100-120 VAC 40 VA MAX/200-240 VAC 50 VA MAX
External dimensions:	Approx. 132 x 213 x 400 mm (projections excluded)
Weight:	Approx. 9.5 kg
Standard Accessories:	Power cord (1, if the suffix code is -Y, a power cord is not included.), rubber feet for the hind feet (2), power fuse (2), joint connector (2), and User's Manual (this manual, 1)

6.2 Dimensional Drawings

Unit: mm

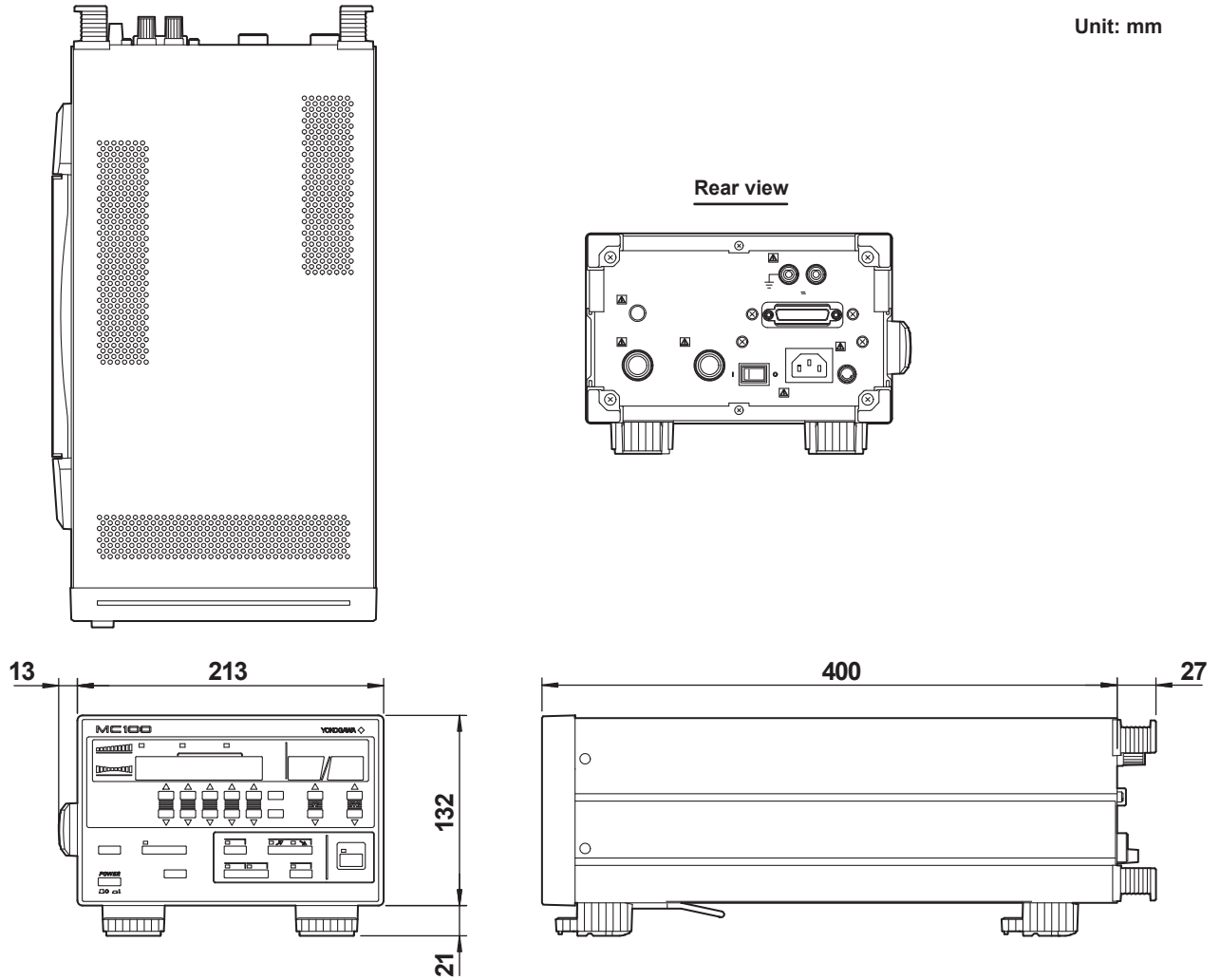

If not specified, the tolerance is 3%. However, in cases of less than 10 mm, the tolerance is 0.3%.

Appendix 1 Calibrating a Pneumatic Industrial Instrument

Calibrating a Pressure Transmitter

The model varies depending on the pressure range.

Pressure Range	Pressure standard
0 to 25 kPa	767401
25 kPa to 200 kPa	767402

The following figure shows a calibration example of a pneumatic differential transmitter.

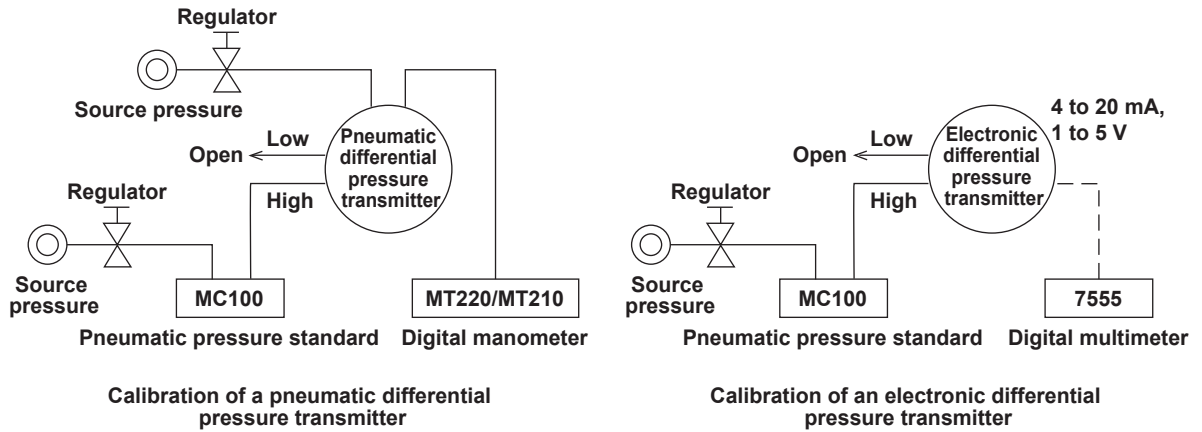

Appendix 2 ASCII Character Codes

The following table shows the ASCII character codes.

	0	1	2	3	4	5	6	7
0	0 NUL	20 DEL	40 SP	60 0	100 @	120 P	140 '	160 p
1	1 SOH	21 DC1	41 !	61 1	101 A	121 Q	141 a	161 q
2	2 STX	22 DC2	42 "	62 2	102 B	122 R	142 b	162 r
3	3 ETX	23 DC3	43 #	63 3	103 C	123 S	143 c	163 s
4	4 EOT	24 DC4	44 \$	64 4	104 D	124 T	144 d	164 t
5	5 ENQ	25 NAK	45 %	65 5	105 E	125 U	145 e	165 u
6	6 ACK	26 SYN	46 &	66 6	106 F	126 V	146 f	166 v
7	7 BEL	27 ETB	47 ,	67 7	107 G	127 W	147 g	167 w
8	10 BS	30 CAN	50 (70 8	110 H	130 X	150 h	170 x
9	11 HT	31 EM	51)	71 9	111 I	131 Y	151 i	171 y
A	12 LF	32 SUB	52 *	72 :	112 J	132 Z	152 j	172 z
B	13 VT	33 ESC	53 +	73 ;	113 K	133 [153 k	173 {
C	14 FF	34 FS	54 ,	74 <	114 L	134 \	154 l	174
D	15 CR	35 GS	55 -	75 =	115 M	135]	155 m	175 }
E	16 SO	36 RS	56 .	76 >	116 N	136 ^	156 n	176 ~
F	17 SI	37 US	57 /	77 ?	117 O	137 _	157 o	177 DEL (RUBOUT)
	Address Command	Universal Command	Listener Address	Talker Address	Secondary Command			

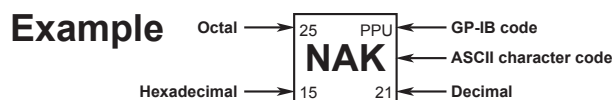

Appendix 3 Communication Format

Status Byte Format (for <ESC S> command)

bit8 DIO8 0 (fixed)	bit7 DIO7 Service request	bit6 DIO6 Error	bit5 DIO5 Completion of the AUTO STEP or SWEEP function	bit4 DIO4 Abnormal source pressure	bit3 DIO3 Syntax error	bit2 DIO2 0 (fixed)	bit1 DIO1 Output change completion
------------------------------	------------------------------------	-----------------------	---	--	---------------------------------	------------------------------	--

bit8: Fixed to 0.

bit7: Service request. Set to "1" when at least one of the bits 6, 5, 4, 3, and 1 becomes a 1.

bit6: Set to "1" when either a syntax error or an abnormal source pressure condition occurs.

bit5: Set to "1" when auto-step or sweep operation terminates.

bit4: Set to "1" when an abnormal source pressure condition occurs.

bit3: Set to "1" when a syntax error occurs.

bit2: Fixed to 0.

bit1: Set to "1" when change in the output completes.

Note

If a load capacitance is connected to the output side, the actual pressure output is delayed with respect to the output change completion signal of bit 1.

Output Format of the Output Value Data

Data block composition

Each data block consists of a header section (4 bytes), a data section (up to 13 bytes), and a terminator.

Header	Data	Terminator
--------	------	------------

Header section

The header section consists of 4 bytes (h1 to h4).

h1	h2	h3	h4
----	----	----	----

h1: Source pressure condition

N: Normal

E: Abnormal source pressure (too large)

e: Abnormal source pressure (too small)

h2: Output pressure condition

M: Output stability

H: Output is higher than the specified value

L: Output is lower than the specified value

h3-h4: Output pressure unit

Pa: kPa

kg: kgf/cm²

HO: mmH₂O

Hg: mmHg

ps: psi

iO: inH₂O

ig: inHg

Appendix 3 Communication Format

Data section

d1	d2	d3	d4	d5	d6	d7	d8	d9	d10	d11	d12	d13
----	----	----	----	----	----	----	----	----	-----	-----	-----	-----

The data section consists of a maximum of 13 bytes (d1 to d13). The numerical section is justified to the left, and unneeded digits are packed.

d1-d7: Number (up to 6 digits) + a decimal point

d8: , (comma)

d9-d10: Numerator of the divider ratio (n), a number (up to 2 digits)
0 to m (denominator of the divider ratio)

d11: / (slash)

d12-d13: Denominator of the divider ratio (m) , a number (up to 2 digits)
1 to 20

Terminator

CRLF (+EOI)

LF

EOI

Note

If a load capacitance is connected to the output side, the actual pressure output is delayed with respect to the output stable signal.

Output Format of Status Output

bit8 0 (fixed)	bit7 Calibration function operation status	bit6 Hold function operation status	bit5 Output ON/OFF status	bit4 Output change status	bit3 Previous communi- cation command error information	bit2 SWEEP function operation status	bit1 AUTO STEP function operation status
----------------------	--	---	------------------------------------	------------------------------------	---	--	--

bit8: Fixed to 0.

bit7: Set to "1" while the calibration function (zero calibration) is in progress.

bit6: Set to "1" while the hold function is in progress.

bit5: Set to "1" when the output is ON.

bit4: Set to "1" until the output stabilizes during the sweep operation when the output value is changed in the output ON state or when the output is turned ON.

bit3: Set to "1" when a communication command error other than <GET> occurs.

bit2: Set to "1" while the sweep function is in progress.

bit1: Set to "1" while the auto-step function is in progress.

Note

If a load capacitance is connected to the output side, the actual pressure output is delayed with respect to the output change signal of bit 4.

Output Format of Setup Data

Line 1: Model, software version number

Line 2: Unit, pressure value, and divider ratio value

Line 3: Auto-step interval, sweep interval, and repeat function settings

Line 4: END (end of output)

Output example MDL767401REV1.01 CRLF
UN2S20.000D1/1 CRLF
AS10SW15M1 CRLF
END CRLF

Index

Symbol Page

7-segment LED..... 1-7

A Page

Accessories iv
 Address 4-3
 Alarm Function 2-15
 ALARM RESET key..... 1-5, 2-15
 A List of Factory Default Values..... 2-7
 AUTO STEP key..... 1-4, 3-3
 Auto-Step Output..... 3-2
 Auto-step output mode 1-2

B Page

baud rate 4-9
 Beep Sound..... 2-19
 Bleed outlet..... 1-6

C Page

conversion coefficient..... 2-11
 CLEAR key 1-5, 2-12, 2-16
 Communication Commands 4-11
 Communication Format..... App-3
 Communication interface connector 1-7

D Page

data format 4-9
 Digital Numbers and Characters 1-7
 Dimensional Drawings..... 6-3
 divider output..... 1-2
 Divider Output..... 3-1
 Divider Ratio..... 2-12
 Divider ratio setting keys 1-5

E Page

Error Code 5-1

F Page

Falling Sweep..... 3-6, 3-8, 3-10
 Front Panel..... 1-4
 Fuse..... iii, 1-6, 5-3

G Page

GP-IB Interface..... 4-1

H Page

handshaking method 4-9
 High 2-17
 Holding 3-15
 HOLD key 1-5, 3-15

I Page

Initializing..... 2-7
 Installation 2-2
 Interval..... 2-14
 INTERVAL key..... 1-4, 2-14

L Page

Large 2-13
 lithium battery 2-6
 Load Capacity..... 2-13
 LOCAL/INTERFACE key..... 1-5, 4-2, 4-3, 4-10
 Low 2-17

M Page

Main power switch 1-6
 Manual Output 3-1
 Manual output mode..... 1-2
 MENU key 1-5, 2-13, 2-18, 2-19
 Middle 2-13
 MODEL..... ii
 Monitor Output..... 2-17
 Monitor output terminal..... 1-7, 2-17

N Page

Name plate 1-7
 Names and Function of Parts 1-4

O Page

Offset Monitor 1-5, 2-20
 Operating Principles 1-1
 Output Connector 1-6, 2-9
 OUTPUT key 1-4, 2-12
 Output Monitor..... 1-5, 2-20
 Output Pressure 2-11

P Page

Power Connection Procedure..... 2-4
 Power connector..... 1-6
 Power cord ii, iii
 Power switch 1-4, 2-5
 Pressure Display Unit..... 2-11
 Pressure setting keys 1-5, 3-1
 Pressure source connector..... 1-6

R Page

Rear Panel..... 1-6
 Recommended Replacement Parts..... 5-6
 Releasing the Repeat Function 3-14
 Repeat Function 3-12, 3-14
 Repeating the Output 3-14
 REPEAT key..... 1-5, 3-13
 Rising Sweep..... 3-4, 3-8, 3-10, 3-12

Index

S	Page
Sample Program.....	4-19
Serial Communication	4-9
Serial (RS-232) Interface.....	4-4
silicon resonant sensor.....	1-1
Small.....	2-13
Source Pressure.....	2-8
Specifications	6-1
Standard Accessories.....	iii
SUFFIX.....	ii
SWEEP d key	1-4, 3-7, 3-9, 3-11
Sweep Output.....	3-4
Sweep output mode.....	1-2
SWEEP u key	1-4, 3-5, 3-9, 3-11
Switch Remote and Local.....	4-2
T	Page
Troubleshooting.....	5-1
U	Page
Unit 2-11	
UNIT key.....	1-5
Z	Page
Zero Calibration.....	2-10
ZERO CAL key	1-5