**User's
Manual**

**AQ7280 OTDR
Communication Interface**

Thank you for purchasing the AQ7280 OTDR. This Communication Interface User's Manual describes the functions and commands of the following communication interfaces.

- USB Interface
- Ethernet Interface (Optional)

To ensure correct use, please read this manual thoroughly before beginning operation. After reading the manual, keep it in a convenient location for quick reference whenever a question arises during operation.

List of Manuals

The following manuals are provided for the AQ7280. Please read all of them.

Manual Title	Manual No.	Description
AQ7280 OTDR User's Manual (included in CD)	IM AQ7280-01EN	Explains all AQ7280 features, except for the communication features, and how to use them.
AQ7280 OTDR Getting Started Guide	IM AQ7280-02EN	This guide focuses on the handling precautions, basic operations, and specifications of the AQ7280.
AQ7280 OTDR Communication Interface User's Manual (included in CD)	IM AQ7280-17EN	This manual. Explains the features related to using communication commands to control the AQ7280.
Model 739883 Battery Pack Handling Precautions	IM 739883-01EN	Explains the handling precautions for the battery pack.
AQ7280 OTDR User's Manual	IM AQ7280-92Z1	Document for China

* The "EN" and "Z1" in the manual numbers are the language codes.

Contact information of Yokogawa offices worldwide is provided on the following sheet.

Document No.	Description
PIM 113-01Z2	List of worldwide contacts

Notes

- The contents of this manual are subject to change without prior notice as a result of improvements in instrument's performance and functions.
- Every effort has been made in the preparation of this manual to ensure the accuracy of its contents. However, should you have any questions or find any errors, please contact your nearest YOKOGAWA representative.
- Copying or reproduction of all or any part of the contents of this manual without YOKOGAWA's permission is strictly prohibited.
- The TCP/IP software of this product and the documents concerning it have been developed/created by YOKOGAWA based on the BSD Networking Software, Release 1 that has been licensed from the Regents of the University of California.

Trademarks

- Microsoft, Windows, Windows 7 and Windows 8 are either registered trademarks or trademarks of Microsoft Corporation in the United States and/or other countries.
- Adobe, Acrobat, and PostScript are trademarks of Adobe Systems Incorporated.
- In this manual, the ® and TM symbols do not accompany their respective registered trademark or trademark names.
- Other company and product names are registered trademarks or trademarks of their respective holders.

Revisions

October 2014:	1st Edition
July 2015:	2nd Edition
July 2016:	3rd Edition
October 2017:	4th Edition

USB Interface and Ethernet Interface

The items below are needed on the PC to use the communication functions via the USB interface.

- The communication library (TMCTL)
- USB driver

The item below is needed on the PC to use the communication functions via the Ethernet interface.

- The communication library (TMCTL)

The library and driver above can be downloaded from the following Web page.

<http://www.yokogawa.com/tm/>

How to Use this Manual

Structure of the Manual

This User's Manual consists of the following sections:

Chapter 1 USB Interface

Describes the functions and specifications of the USB interface used to control the AQ7280 OTDR from a PC.

Chapter 2 Ethernet Interface (Option)

Describes the functions and specifications of the Ethernet interface.

Chapter 3 Before Programming

Describes the syntax used to transmit commands.

Chapter 4 Commands

Describes each command that is available.

Chapter 5 Condition Register/Output Queue and Error Queue

Describes the register and queues.

Appendix

Explains the support for AQ7280 error cord.

Index

Conventions Used in This Manual

Notations Used in the Procedural Explanations

On pages that describe the operating procedures in each chapter, the following notations are used to distinguish the procedure from their explanations.

Procedure This subsection contains the operating procedure used to carry out the function described in the current section. The procedures are written with inexperienced users in mind; experienced users may not need to carry out all the steps.

Explanation This subsection describes the setup parameters and the limitations on the procedures.

Note Calls attention to information that is important for proper operation of the instrument.

Terms Used in Explanations of Procedures

Panel Keys and Soft Keys

Bold characters used in the procedural explanations indicate characters that are marked on the panel keys or the characters of the soft keys displayed on the screen menu.

Units

k: Denotes "1000." Example: 400km

K: Denotes "1024." Example: 459 KB (file data size)

Symbols Used in Syntax Descriptions

Symbols which are used in the syntax descriptions in Chapter 4 are shown below.

These symbols are referred to as BNF notation (Backus-Naur Form).

For detailed information, see section 3.4, "Data."

Symbol	Description	Example	Example of Input
<>	Defined value	SET:M<x> <x> = 1, 2, 3	-> SET:M2
{ }	One of the options in { } is selected.	LMTechnique {LSA TPA}	-> LMTechnique TPA
	Exclusive OR		

Contents

List of Manuals.....	i
How to Use this Manual.....	iv
Conventions Used in This Manual.....	v

Chapter 1 USB Interface

1.1 Names and Functions of Parts.....	1-1
1.2 USB Interface Functions and Specifications.....	1-2
1.3 Connecting via the USB Interface.....	1-3
1.4 Setting the AQ7280 (USB).....	1-4

Chapter 2 Ethernet Interface (Option)

2.1 Names and Functions of Parts.....	2-1
2.2 Ethernet Interface Functions and Specifications.....	2-2
2.3 Connecting the Ethernet Interface.....	2-3
2.4 Setting the AQ7280 (Network).....	2-4

Chapter 3 Before Programming

3.1 Messages.....	3-1
3.2 Commands.....	3-3
3.3 Response.....	3-5
3.4 Data.....	3-6

Chapter 4 Commands

4.1 List of Commands.....	4-1
4.2 ACQUIRE Group.....	4-8
4.3 ANALYSIS Group.....	4-12
4.4 COMMUNICATE Group.....	4-18
4.5 DISPLAY Group.....	4-19
4.6 FILE Group.....	4-21
4.7 FIPROBE Group.....	4-25
4.8 LABEL Group.....	4-29
4.9 LIGHTSOURCE Group.....	4-30
4.10 MENU Group.....	4-31
4.11 MISC Group.....	4-32
4.12 NETWORK Group.....	4-35
4.13 PMETER Group.....	4-37
4.14 PMONITOR Group.....	4-39
4.15 PRINT Group.....	4-40
4.16 REPORT Group.....	4-41
4.17 SETUP Group.....	4-42
4.18 STATUS Group.....	4-43
4.19 SYSTEM Group.....	4-44
4.20 VLS Group.....	4-45
4.21 WAVEDATA Group.....	4-46
4.22 Common Commands.....	4-48

Chapter 5 Condition Register, Output Queue, and Error Queue

5.1 Condition Register..... 5-1
5.2 Output and Error Queue..... 5-2

Appendix

Appendix Error Messages.....App-1

Index

1
2
3
4
5
App
Index

1.1 Names and Functions of Parts

Upper Panel

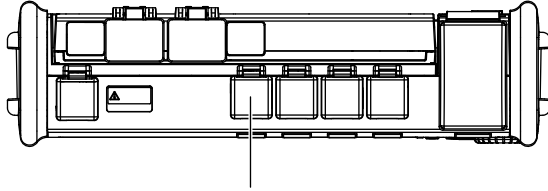

USB type B (mini B) connector
Connector used to connect the AQ7280 to the controller (such as a PC) using a USB cable.

Front Panel

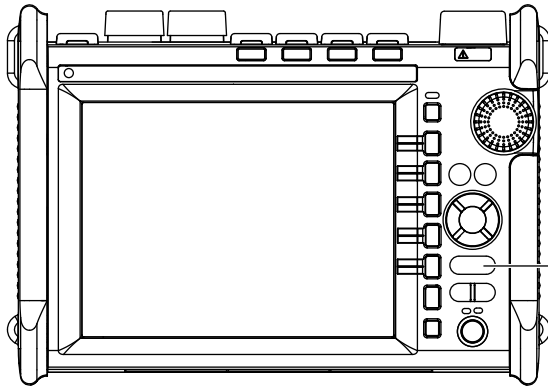

SETUP key
Press this key to select the USB interface.

1.2 USB Interface Functions and Specifications

USB Interface Functions and Specifications

Reception Function

You can specify the same settings as those specified by front panel key operations.
Receives output requests for measured data, setup data of the panel, and error codes.

Transmission Function

Outputs measured and computed data.
Outputs panel setup data and the status byte.
Outputs error codes that have occurred.

USB Interface Specifications

Electrical and mechanical specifications: Conforms to USB Rev. 2.0
Connector: Type B (mini B) connector (receptacle)
Number of ports: 1
Power supply: Self-powered
Compatible PC systems: PC running Windows 7 or Windows 8 with a standard USB port (a separate device driver is needed to connect to a PC).

Switching between Remote and Local Modes

When Switching from Local to Remote Mode

Sending a command when the instrument is in the local mode causes the instrument to switch to the remote mode.

- All keys except the **Local** soft key are disabled.
- Settings entered in local mode are retained even when the AQ7280 switches to remote mode.

When Switching from Remote to Local Mode

Pressing the **Local** soft key in remote mode puts the instrument in local mode.

- Key operations are enabled.
- Settings entered in remote mode are retained even when the AQ7280 switches to local mode.

Note

The AQ7280 cannot be remotely controlled via the USB interface while the storage function is in operation.
Remote control via the Ethernet interface is also not possible.

1.3 Connecting via the USB Interface

Connection Procedure

1. Open the cover of the upper panel.
2. Connect a USB cable to the type B (mini B) connector.

Precautions to Be Taken When Connecting the Cable

- Connect the USB cable by inserting the connector firmly into the USB connector.
- Do not connect or disconnect the USB cable after the power is turned ON until the AQ7280 series is ready for operation (approximately 20 s).

1.4 Setting the AQ7280 (USB)

Procedure

Selecting the USB Interface Function

Press **SETUP** and then the **System Setup** soft key to display the following screen.



Releasing the Remote Control

Press the **Local** soft key that appears on the screen after communication starts.

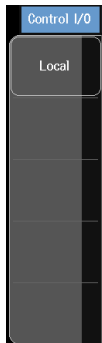

Explanation

USB Interface

To control the AQ7280 remotely using communication commands through the USB port, install YOKOGAWA's TMC (Text and Measurement Class) driver into your PC. To obtain YOKOGAWA's USB TMC driver, contact your nearest YOKOGAWA dealer or access the following USB driver page at our Web site and download it.

<http://www.yokogawa.com/tm/tm-softdownload.htm>

Note

- You cannot change the display while the AQ7280 is being remotely controlled.
- Only use the USB TMC driver (or software) provided by YOKOGAWA.

2.1 Names and Functions of Parts

Upper Panel

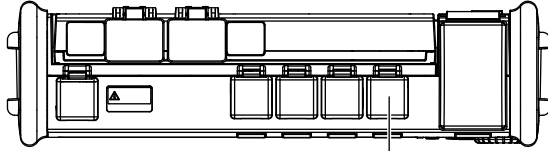

Ethernet Port

Connector used to connect the AQ7280 to the controller (such as a PC) using a ethernet cable.

Front Panel

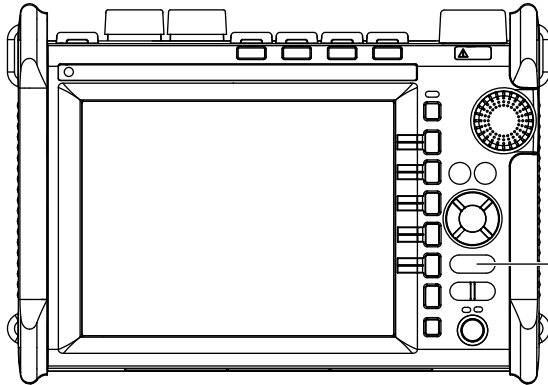

SETUP key

Press this key to select the USB interface.

2.2 Ethernet Interface Functions and Specifications

Ethernet Interface Features

Reception Feature

The AQ7280 reception feature allows you to specify the same settings through an Ethernet connection that you can specify using the front panel keys.

The AQ7280 can receive output requests for measured data, panel setting data, and error codes.

Transmission Feature

The AQ7280 can transmit measured data.

The AQ7280 can transmit panel setting data and the status byte.

The AQ7280 can transmit error codes when errors occur.

Ethernet Interface Specifications

Electrical and mechanical specifications: Conforms to IEEE802.3

Transmission system: Ethernet (10BASE-T/100BASE-TX)

Data rate: 10 Mbps/100 Mbps

Number of communication ports: 1

Port number: 10001/tcp

Communication protocol: VXI-11

Connector type: RJ45 connector

Switching between Remote and Local Modes

When Switching from Local to Remote Mode

Sending a command when the instrument is in the local mode causes the instrument to switch to the remote mode.

- All keys except the **Local** soft key are disabled.
- Settings entered in local mode are retained even when the AQ7280 switches to remote mode.

When Switching from Remote to Local Mode

Pressing the **Local** soft key in remote mode puts the instrument in local mode.

- Key operations are enabled.
- Settings entered in remote mode are retained even when the AQ7280 to local mode.

Note

The AQ7280 cannot be remotely controlled via the USB interface while the storage function is in operation.

Remote control via the Ethernet interface is also not possible.

FTP Function

The AQ7280 series has an FTP function. You can transfer the data stored in the AQ7280 internal memory to the PC using FTP commands from the PC.

2.3 Connecting the Ethernet Interface

Connection Procedure

Connect a UTP (Unshielded Twisted-Pair) cable or an STP (Shielded Twisted-Pair) cable that is connected to a hub, for example, to the 100BASE-TX port on the bottom of the AQ7280.

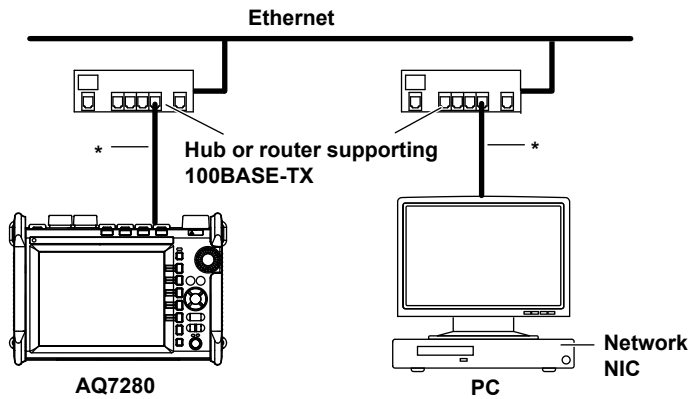

* UTP cable or STP cable (straight cable in either case)

Precautions to Be Taken When Connecting the Cable

- To connect the AQ7280 to a PC through a hub, use a straight cable. To connect the AQ7280 to a PC directly, use a crossover cable.
- Use a network cable that conforms to your network environment (such as the data rate).
- When using a UTP cable (straight cable), use a cable of category 5.

2.4 Setting the AQ7280 (Network)

The settings for remotely controlling the AQ7280 via the Ethernet interface are explained below.

Procedure

Selecting the Ethernet Interface Function

Press **SETUP** and then the **System Setup** soft key to display the following screen.

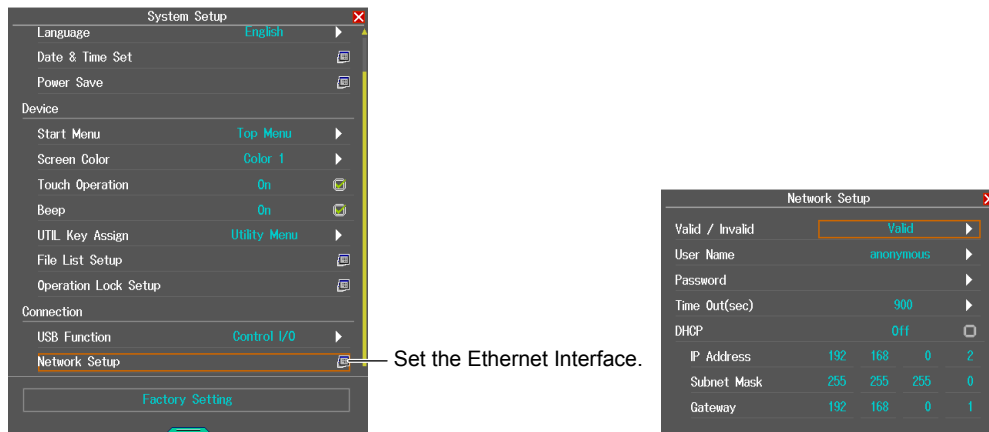

Releasing the Remote Control

Press the **Local** soft key that appears on the screen after communication starts.

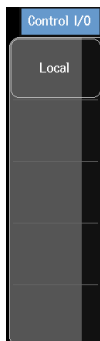

Explanation**Setting the Ethernet Interface**

You must set the following parameters to use the Ethernet interface function.

- **Enabling or Disabling the Network Setup**
After you have set the user name, password, timeout value, and TCP/IP parameters, select Valid to use the network connection.
- **User Name**
- **Password**
- **Setting the Timeout Value**
The connection to the network is automatically disconnected if there is no access to the AQ7280 for the specified time.
- **Setting the TCP/IP**
IP Address
Subnet Mask
Gateway

For details on how to configure the settings, see section 7.4, “Configuring Network Settings (/LAN option),” in the *AQ7280 OTDR User’s Manual*, IM AQ7280-01EN.

Note

- If a router or the like is between the AQ7280 and the controlling PC, set a timeout period. If a timeout period is not set and the router or the like malfunctions, the AQ7280 will no longer be able to connect to the PC.
- The AQ7280 cannot be remotely controlled via the ethernet interface while the USB storage function is in operation.

3.1 Messages

Messages

Messages are used to exchange information between the controller and the instrument. Messages that are sent from the controller to the instrument are called program messages and messages that are sent back from the instrument to the controller are called response messages.

If a program message contains a message unit that requests a response (a query), the instrument returns a response message upon receiving the program message. A single response message is always returned in response to a single program message.

Program Messages Program Message Unit

A program message consists of zero or more program message units; each unit corresponds to one command. The instrument executes the received commands in order.

Each program message unit is separated by a semicolon (;).

Example `:PMETer:MODulation MOD_CW;UNIT DB<PMT>`

<PMT>

PMT is a program message terminator. The following three types are available.

- **NL (New Line)**
Same as LF (Line Feed). ASCII code "0AH" is used.
- **^END**
END message defined in IEEE488.1. (EOI signal) (The data byte sent with an END message will be the final item of the program message unit.)
- **NL^END**
NL with an END message added (NL is not included in the program message unit.)

Program Header

A program header is used to indicate the command type. For details, see section 3.2, "Commands."

Program Data

If certain conditions are required in executing a command, program data is added. A space (ASCII code "20H") separates the program data from the header. If there are multiple sets of program data, they are separated by commas (.). For details, see section 3.4, "Data."

Example `:PMETer:MODulation MOD_CW<PMT>`

Response Messages Response Message Units

A response message consists of one or more response message units: each response message unit corresponds to one response. Response message units are delimited by a ";" (semicolon).

Example `:PMETer:MODulation MOD_CW;UNIT DB<PMT>`

<RMT>

RMT stands for "response message terminator." The response message terminator is NL^EOM.

Response Header

A response header sometimes precedes the response data. A space separates the data from the header. For details, see section 3.3, "Response."

Response Data

Response data contains the content of the response. If there are multiple sets of response data, they are separated by commas (.). For details, see section 3.4, "Data."

Example `850E-9<RMT> :PMETer:MODulation MOD_CW<PMT>`

If there are multiple queries in a program message, responses are returned in the same order that the queries were received in. The AQ7280 returns a single response message unit to most queries, but there are queries that the AQ7280 returns multiple units to. The first response message unit always corresponds to the first query, but the nth response unit may not necessarily correspond to the nth query. If you want to make sure that every response is retrieved, divide the program messages into individual messages.

3.1 Messages

Note

- It is always possible to send a program message if the previous message which was sent did not contain any queries.
 - If the previous message contained a query, it is not possible to send another program message until a response message has been received. An error will occur if a program message is sent before a response message has been received in its entirety. A response message which has not been received will be discarded.
 - If an attempt is made by the controller to receive a response message, even if there is no response message, an error will occur. An error will also occur if the controller makes an attempt to receive a response message before transmission of a program message has been completed.
 - If a program message of more than one unit is sent and some of the units are incomplete, this instrument receives program message units which the instrument thinks complete and attempts to execute them. However, these attempts may not always be successful and a response may not always be returned, even if the program message contains queries.
-

3.2 Commands

Command

There are three types of commands (program headers) that a controller may send to the AQ7280. The commands differ in their program header formats.

Common Command Header

Commands that are defined in IEEE 488.2-1987 are called common commands. Be sure to include an asterisk (*) at the beginning of a common command.

Common command example *CLS

Compound Header

Other commands that are specific to the AQ7280 are classified and arranged in a hierarchy according to their functions. Be sure to use a colon to specify a lower hierarchical level.

Compound header example :PMETer:LINK:STATe

When Concatenating Commands Command Groups

A command group is a group of commands that have common compound headers arranged in a hierarchy. A command group may contain sub-groups.

Example

Commands relating to acquisition settings

```
:PMETer:DREF
:PMETer:LINK:STATe
:PMETer:MAXMin:STATe
:PMETer:MODulation
:PMETer:OFFSet
:PMETer:REFerence
:PMETer:WAVelength:DETail
```

When Concatenating Commands of the Same Group

The AQ7280 stores the hierarchical level of the command that is currently being executed and processes the next command on the assumption that it belongs to the same level. Therefore, the common header section can be omitted for commands that belong to the same group.

Example

```
:PMETer:MODulation MOD_CW;UNIT DB<PMT>
```

When Concatenating Commands of Different Groups

If the subsequent command does not belong to the same group, place a colon in front of the header (cannot be omitted).

Example

```
:PMETer:MODulation MOD_
CW;:MENU:FUNction TOP<PMT>
```

When Concatenating Common Commands

Common commands that are defined in the IEEE 488.2-1987 are independent of hierarchy. There is no need to use a colon.

Example

```
:PMETer:MODulation MOD_CW;*CLS;UNIT
DB<PMT>
```

When Separating Commands with <PMT>

If a terminator is used to separate two commands, each command is a separate message. Therefore, the common header must be typed in for each command even when commands of the same command group are being concatenated.

Example

```
:PMETer:MODulation MOD_CW<PMT>:PMETer
UNIT DB<PMT>
```

Upper-level Query

An upper-level query is a query that is made by appending a question mark to the highest level command of a group. The controller can receive all of the settings in a group collectively by executing an upper-level query. Some upper-level queries of a group, which may be comprised of more than three hierarchical levels, can cause the AQ7280 to transmit all the lower level settings.

Example

```
:NETWork:CONTRol?<PMT> ->
:NETW:CONT:PASS "ABC";TIM 30;USER
"anonyumous"
```

Note

- The response to an upper-level query can be sent back to the AQ7280 as a program message. This enables the settings that were present when the upper-level query was made to be reproduced later on.
- Some upper-level queries do not return setup data that is not currently in use. Exercise caution because not all of a group's information is necessarily returned in a response.

3.2 Commands

Header Interpretation Rules

The AQ7280 interprets the header that it receives according to the rules below.

Example

"DRANge" can be written as "drange" or "Drange."

- The lower-case characters can be omitted.

Example

"DRANge" can be written as "DRANG" or "DRAN."

- The question mark at the end of a header indicates that it is a query. You cannot omit the question mark.

Example

The shortest abbreviation for "DRANge?" is "DRAN?."

- If the <x> (value) at the end of a mnemonic is omitted, it is interpreted as a 1.

Example

If you write "M" for "M<x>", "M1." is specified.

Note

A mnemonic is a character string made up of alphanumeric characters.)

3.3 Response

Form

When the controller sends a query with a question mark, the AQ7280 returns a response message to the query.

Response Consisting of a Header and Data

Responses that can be used as program messages without any changes are returned with command headers attached.

Example

```
:PMETer:MODulation?<PMT>  
-> :PMETer:MODulation MOD_270HZ<RMT>
```

If You Want the AQ7280 to Return Responses without Headers

You can configure the AQ7280 so that even responses that have both headers and data are returned without headers. Use the COMMunicate:HEADer command for this purpose.

Abbreviated Form

The AQ7280 normally returns response headers with the lower-case section removed. You can configure the AQ7280 so that full headers are returned. Use the COMMunicate:VERBose command for this purpose.

3.4 Data

Data contains conditions and values that are written after the header. A space separates the data from the header. Data is grouped as follows:

Data	Description
<Decimal>	A value expressed in decimal notation (Example: Western calendar year ->MISC:DATE:YEAR 2009)
<Distance><Time> <Wavelength><Loss>	A physical value (Example: Timeout value ->NETWork: CONTRol:TIMEout 30))
<Character data>	Predefined character string (mnemonic). Select from the available strings in braces. (Example: Select the function mode ->MENU:FUNCTION {TOP LSPM LOSStest PONPm MLOSStest IPTest})
<Boolean>	Indicates ON and OFF. Specify ON or OFF. (Example: Turn on the DHCP ->NETWork: DHCP ON))
<String data>	User-defined string (Example: Set the Network password ->NETWork:CONTRol:PASSword "ABC")

<Decimal>

<Decimal> indicates a value expressed as a decimal number, as shown in the table below. Decimal values are written in the NR form as specified in ANSI X3.42-1975.

Symbol	Description	Example
<NR1>	Integer	125 -1 +1000
<NR2>	Fixed point number	125.0 -.90 +001.
<NR3>	Floating point number	125.0E+0 -9E-1 +.1E4
<NRf>	Any of the forms <NR1> to <NR3> is allowed.	

- The AQ7280 can receive decimal values that are sent from the controller in any form, from <NR1> to <NR3>. This is expressed as <NRf>.
- The AQ7280 returns a response to the controller in one of the forms from <NR1> to <NR3> depending on the query. The same form is used regardless of the size of the value.
- For the <NR3> form, the plus sign after the “E” can be omitted. You cannot omit the minus sign.
- If a value outside the setting range is entered, the value is adjusted to the closest value within the range.
- If a value has more significant digits than are available, the value will be rounded.

<Distance>, <Time>, <Wavelength>, and <Loss>

<Distance>, <Time>, <Wavelength>, and <Loss> indicate decimal values that have physical significance. A <Multiplier> or <Unit> can be attached to the <NRf> form that was described earlier. The following types of expressions are possible.

Form	Example
<NRf><Multiplier><Unit>	0.85UM
<NRf><Unit>	500m
<NRf><Multiplier>	5M
<NRf>	5E -3

<Multiplier>

<Multipliers> that you can use are indicated in the following table.

Symbol	Word	Description
EX	Exa	10 ¹⁸
PE	Peta	10 ¹⁵
T	Tera	10 ¹²
G	Giga	10 ⁹
MA	Mega	10 ⁶
K	Kilo	10 ³
M	Milli	10 ⁻³
U	Micro	10 ⁻⁶
N	Nano	10 ⁻⁹
P	Pico	10 ⁻¹²
F	Femto	10 ⁻¹⁵
A	Atto	10 ⁻¹⁸

<Unit>

<Units> that you can use are indicated in the following table.

Symbol	Word	Description
M	Meter	Distance
S	Second	Time
dB	Decibel	Level
UM	Micro meter	Wavelength

- <Multiplier> and <Unit> are not case sensitive.
- “U” is used to indicate micro (“μ”).
- “MA” is used for Mega to distinguish it from Milli.
- If both <Multiplier> and <Unit> are omitted, the default unit is used.

<Character Data>

<Character data> is a predefined character string (mnemonics). It is mainly used to indicate that an option listed as a character string in braces must be selected and entered. The data interpretation rules are the same as those described in "Header Interpretation Rules" on page 3-4.

Form	Example
{SIMPLE DETAIL WIZARD MULTI}	DETAIL

- As with the header, the COMMunicate:VERBoSe command can be used to select whether to return the response in the full form or in the abbreviated form.
- The COMMunicate:HEADer setting does not affect <character data>.

<Boolean>

<Boolean> is data that indicates ON or OFF. The following types of expressions are possible.

Form	Example
{ON OFF <NRf>}	ON OFF 1 0

- When <Boolean> is expressed in the <NRf> form, "OFF" is selected if the rounded integer value is 0, and ON is selected for all other cases.
- A response message is always returned with a 1 if the value is ON and with a 0 if the value is OFF.

<String Data>

<String data> is not a predefined character string like <character data>. It can be any character string. The character string must be enclosed in single quotation marks (') or double quotation marks (").

Form	Example
<Character string data>	'ABC' "IEEE488.2-1987"

- If a character string contains a double quotation mark ("), the double quotation mark is expressed as two consecutive quotation marks (" "). This rule also applies to single quotation marks.
- A response message is always enclosed in double quotation marks (").
- <String data> is any character string. Therefore, the AQ7280 assumes that the remaining program message units are part of the character string if no single (') or double quotation mark (") is encountered. As a result, no error is detected if a quotation mark is omitted.

<Block data>

<Block data> is any 8-bit data. It is only used in response messages on the AQ7280. The syntax is as follows:

Form	Example
#N <N-digit decimal number><Data byte sequence>	#80000010ABCDEFGHIJ

- #N
Indicates that the data is <block data>. "N" indicates the number of succeeding data bytes (digits) in ASCII code.
- <N-digit decimal number>
Indicates the number of bytes of data (example: 0000010 = 10 bytes).
- <Data byte sequence>
Expresses the actual data (example: ABCDEFGHIJ).
- Data is comprised of 8-bit values (0 to 255). This means that the ASCII code "0AH" which stands for "NL" can also be included in the data. Hence, care must be taken when programming the controller.

4.1 List of Commands

Command	Function	Page
ACQUIRE Group		
:ACQUIRE:ADSave	Sets or queries whether or not a file is saved automatically after averaged measurement is executed.	4-8
:ACQUIRE:AESEARCH	Sets or queries whether or not automatic event searching takes place after averaged measurement is executed.	4-8
:ACQUIRE:ATTenuation	Sets or queries the attenuation.	4-8
:ACQUIRE:AUTO:ATTenuation?	Queries the attenuation value when the attenuation is set to auto.	4-8
:ACQUIRE:AUTO:DRANge?	Queries the distance range value when the distance range is set to auto.	4-8
:ACQUIRE:AUTO:PWIDth?	Queries the pulse width when the pulse width is set to auto.	4-8
:ACQUIRE:AVERAge:COUNT?	Queries the current average count.	4-8
:ACQUIRE:AVERAge:INDex	Sets or queries the average index.	4-8
:ACQUIRE:AVERAge:MODE	Sets or queries the averaging mode.	4-8
:ACQUIRE:AVERAge:START	Executes averaged measurement.	4-9
:ACQUIRE:AVERAge:STOP	Stops averaged measurement.	4-9
:ACQUIRE:AVERAge:TIME	Sets or queries the averaged time.	4-9
:ACQUIRE:AVERAge:TYPE	Sets or queries the average type.	4-9
:ACQUIRE:DRANge	Sets or queries the distance range.	4-9
:ACQUIRE:OFFSet	Sets or queries the horizontal axis measurement start position.	4-9
:ACQUIRE:PLUGcheck	Sets or queries the optical plug connection check feature.	4-9
:ACQUIRE:PON:STATe	Sets or queries the PON (high SNR mode).	4-10
:ACQUIRE:PWIDth	Sets or queries the pulse width.	4-10
:ACQUIRE:REALtime:START	Executes real-time measurement.	4-10
:ACQUIRE:REALtime:STOP	Stops real-time measurement.	4-10
:ACQUIRE:SELECTION:ATTenuation?	Queries the selectable attenuation values.	4-10
:ACQUIRE:SELECTION:DRANge?	Queries the selectable distance range values.	4-10
:ACQUIRE:SELECTION:PWIDth?	Queries the selectable pulse widths.	4-10
:ACQUIRE:SELECTION:SMPinterval?	Queries the selectable sampling intervals.	4-10
:ACQUIRE:SELECTION:WAVelength?	Queries the selectable measurement wavelengths.	4-10
:ACQUIRE:SETTing	Sets or queries the measurement mode.	4-10
:ACQUIRE:SMPinterval:DATA	Sets or queries the sampling interval.	4-11
:ACQUIRE:SMPinterval:VALue?	Queries the sampling interval.	4-11
:ACQUIRE:WAVelength	Sets or queries the measurement wavelength.	4-11
ANALYSIS Group		
:ANALYSIS:ASEARCH:EXECute	Executes automatic searching.	4-12
:ANALYSIS:ASEARCH:NUMber?	Queries the number of automatically detected events.	4-12
:ANALYSIS:BCOEfficient	Sets or queries the backscattering coefficient of the current wavelength.	4-12
:ANALYSIS:CURSor:DECibel?	Queries the cursor dB value.	4-12
:ANALYSIS:CURSor:DELeTe	Deletes the cursor.	4-12
:ANALYSIS:CURSor:DISTance	Sets or queries the cursor position.	4-12
:ANALYSIS:CURSor:LINK	Sets or queries the cursor link.	4-12
:ANALYSIS:DUMMy:END	Sets the end event of the dummy fiber event number.	4-12
:ANALYSIS:DUMMy:START	Sets the start event of the dummy fiber event number.	4-12
:ANALYSIS:DUNit	Sets or queries the distance unit.	4-12
:ANALYSIS:EMARKer:LMTechnique	Sets or queries the approximation method (for events).	4-12
:ANALYSIS:EMARKer:SET:M1	Sets or queries marker M1 of the current event.	4-13
:ANALYSIS:EMARKer:SET:M2	Sets or queries marker M2 of the current event.	4-13
:ANALYSIS:EMARKer:SET:M3	Sets or queries marker M3 of the current event.	4-13
:ANALYSIS:EMARKer:SET:Y2	Sets or queries marker Y2 of the current event.	4-13
:ANALYSIS:EVENT:CURRent:CUMLo ss?	Sets or queries the cumulative loss of the current event.	4-13
:ANALYSIS:EVENT:CURRent:DISTan ce?	Acquires the distance of the current event.	4-13
:ANALYSIS:EVENT:CURRent:INDex	Moves the current event.	4-13
:ANALYSIS:EVENT:CURRent:IOR?	Queries the section group index of the current event.	4-13
:ANALYSIS:EVENT:CURRent:LOSS?	Acquires the connection loss of the current event.	4-13

4.1 List of Commands

Command	Function	Page
:ANALysis:EVENT:CURRent:RETurnLoss?	Acquires the optical return loss of the current event.	4-13
:ANALysis:EVENT:CURRent:TYPE?	Acquires the event type of the current event.	4-13
:ANALysis:EVENT:CURRent:UNITLoss?	Acquires the dB/km of the current event.	4-14
:ANALysis:EVENT:DELeTe	Deletes the current event.	4-14
:ANALysis:EVENT:FIX:MODE	Sets or queries the event fix mode.	4-14
:ANALysis:EVENT:FIX:STATE	Sets or queries the event fix on/off state.	4-14
:ANALysis:EVENT:INSert	Inserts an event at the cursor position.	4-14
:ANALysis:EVENT:IOR	Sets or queries the interval index of the current event.	4-14
:ANALysis:FEDetection	Sets or queries whether or not fault events are detected.	4-14
:ANALysis:FMARKer:DELeTe	Deletes the marker.	4-14
:ANALysis:FMARKer:LEFT:DISTanCe?	Queries the distance between markers 1 and 2.	4-14
:ANALysis:FMARKer:LEFT:LOSS?	Queries the loss between markers 1 and 2.	4-14
:ANALysis:FMARKer:LEFT:UNITLoss?	Queries the slope between markers 1 and 2.	4-14
:ANALysis:FMARKer:LMTechnique	Sets or queries the approximation method (for markers).	4-14
:ANALysis:FMARKer:LOSS?	Queries the connection loss.	4-14
:ANALysis:FMARKer:REFLection:SATurated?	Queries the reflection saturation.	4-14
:ANALysis:FMARKer:REFLection:VALue?	Queries the amount of reflection.	4-15
:ANALysis:FMARKer:RETurnloss:SATurated?	Queries the optical return loss saturation.	4-15
:ANALysis:FMARKer:RETurnloss:VALue?	Queries the optical return loss.	4-15
:ANALysis:FMARKer:RIGHT:DISTanCe?	Queries the distance between markers 2 and 3.	4-15
:ANALysis:FMARKer:RIGHT:LOSS?	Queries the loss between markers 2 and 3.	4-15
:ANALysis:FMARKer:RIGHT:UNITLoss?	Queries the slope between markers 2 and 3.	4-15
:ANALysis:FMARKer:SET:M<x>	Sets or queries markers.	4-15
:ANALysis:FMARKer:SET:Y<x>	Sets or queries auxiliary markers.	4-15
:ANALysis:IOR	Sets or queries the group index of the current wavelength.	4-15
:ANALysis:MACRobending:DISPlay	Sets or queries the macrobending display on/off state.	4-15
:ANALysis:MACRobending:THReshold	Sets or queries the macrobending threshold.	4-15
:ANALysis:REFerence:DELeTe	Deletes the distance reference.	4-15
:ANALysis:REFerence:DISTanCe	Sets the distance reference or queries its current position.	4-15
:ANALysis:SECTion:BASElevel?	Queries the dB value of the interval data reference point.	4-16
:ANALysis:SECTion:DELeTe	Deletes the interval analysis data.	4-16
:ANALysis:SECTion:DISTanCe?	Queries the distance of the interval data.	4-16
:ANALysis:SECTion:END	Sets or queries the end position of the interval data.	4-16
:ANALysis:SECTion:LMTechnique	Sets or queries the interval analysis approximation method.	4-16
:ANALysis:SECTion:LOSS?	Queries the loss of the interval data.	4-16
:ANALysis:SECTion:REFerence	Sets the interval data reference point.	4-16
:ANALysis:SECTion:RETurnloss:SATurated?	Queries the optical return loss saturation of the interval data.	4-16
:ANALysis:SECTion:RETurnloss:VALue?	Queries the optical return loss of the interval data.	4-16
:ANALysis:SECTion:START	Sets or queries the start position of the interval data.	4-16
:ANALysis:SPLitter:STATE	Sets or queries whether splitter search is on or off.	4-16
:ANALysis:THReshold:EOFiber	Sets or queries the fiber end threshold.	4-16
:ANALysis:THReshold:FECLoss	Sets or queries the fault event connector loss threshold.	4-17
:ANALysis:THReshold:FERLoss	Sets or queries the fault event optical return loss threshold.	4-17
:ANALysis:THReshold:FESLoss	Sets or queries the fault event connection loss threshold.	4-17
:ANALysis:THReshold:FESPLoss	Sets or queries the fault event splitter loss threshold.	4-17
:ANALysis:THReshold:FETLoss	Sets or queries the fault event total loss threshold.	4-17
:ANALysis:THReshold:FEULoss	Sets or queries the fault event dB/km threshold.	4-17
:ANALysis:THReshold:RLOSS	Sets or queries the optical return loss threshold.	4-17
:ANALysis:THReshold:SLOSS	Sets or queries the connection loss threshold.	4-17
:ANALysis:THReshold:SPLOss	Sets or queries the splitter loss threshold.	4-17

Command	Function	Page
COMMunicate Group		
:COMMunicate?	Queries all communication settings.	4-18
:COMMunicate:HEADer	Sets or queries whether or not a header is added to the response to a query. (Example with header: PMETer:REFerence 5.00. Example without header: 5.00.)	4-18
:COMMunicate:VERBose	Sets or queries whether the response to a query is returned fully spelled out (example: PMETer:REFerence 5.00) or using abbreviation (example: PMET:REF 5.00).	4-18
DISPlay Group		
:DISPlay:ALINe	Sets or queries the display of approximated lines.	4-19
:DISPlay:COLor	Sets or queries the screen colors.	4-19
:DISPlay:CURSor:DBValue	Sets or queries the cursor dB value.	4-19
:DISPlay:CURSor:SECond	Sets or queries the second-cursor display.	4-19
:DISPlay:CURSor:TYPE	Sets or queries the cursor display format.	4-19
:DISPlay:DECibel:UPPer	Sets or queries the display start level.	4-19
:DISPlay:DIGit:DECibel	Sets or queries the number of decimal places of the dB display.	4-19
:DISPlay:DIGit:DISTance	Sets or queries the number of decimal places of the distance display.	4-19
:DISPlay:DISTance:LEFT	Sets or queries the display start distance.	4-19
:DISPlay:DIVide:DECibel	Sets or queries the vertical axis zoom.	4-20
:DISPlay:DIVide:DISTance	Sets or queries the horizontal axis zoom.	4-20
:DISPlay:EVENT:AZOom	Sets or queries the event auto zoom.	4-20
:DISPlay:INITialize:SCALE	Initializes the display scale.	4-20
:DISPlay:MARKer:INFORMATION	Sets or queries the display of marker information.	4-20
:DISPlay:SCALE	Sets or queries the scale display.	4-20
:DISPlay:WAVE:EXPAnd	Sets or queries the waveform area expansion mode.	4-20
FILE Group		
:FILE:DELeTe:EXECute	Deletes files.	4-21
:FILE:DRIVE:FREE?	Queries the amount of free space on the current drive.	4-21
:FILE:DRIVE:SET	Sets or queries the current drive setting.	4-21
:FILE:FILE:EXIST?	Checks whether or not the specified file exists.	4-21
:FILE:FILE:GET?	Acquires the specified file.	4-21
:FILE:FILE:NAME	Specifies the file name used for file acquisition, file size acquisition, and file transfer.	4-21
:FILE:FILE:SIZE?	Acquires the size of the specified file.	4-21
:FILE:FOLDer:LIST?	Acquires a list of the contents of the current folder.	4-21
:FILE:FOLDer:MAKE	Creates a folder.	4-21
:FILE:FOLDer:PATH	Sets or queries the current folder name.	4-22
:FILE:LOAD:EXECute	Loads a file.	4-22
:FILE:SAVE:COMMeNt1	Sets or queries the save comment 1.	4-22
:FILE:SAVE:COMMeNt2	Sets or queries the save comment 2.	4-22
:FILE:SAVE:COMMeNt3	Sets or queries the save comment 3.	4-22
:FILE:SAVE:COMMeNt4	Sets or queries the save comment 4.	4-22
:FILE:SAVE:COMMeNt5	Sets or queries the save comment 5.	4-22
:FILE:SAVE:COMMeNt6	Sets or queries the save comment 6.	4-22
:FILE:SAVE:COMMeNt7	Sets or queries the save comment 7.	4-22
:FILE:SAVE:COMMeNt8	Sets or queries the save comment 8.	4-22
:FILE:SAVE:COMMeNt9	Sets or queries the save comment 9.	4-22
:FILE:SAVE:COMMeNt10	Sets or queries the save comment 10.	4-22
:FILE:SAVE:EXECute	Saves the file.	4-23
:FILE:SAVE:ID	Sets or queries the save ID.	4-23
:FILE:SAVE:ITEM<x>	Sets or queries the saved items.	4-23
:FILE:SAVE:SEParator	Sets or queries the separator used when files are saved.	4-23
:FILE:SAVE:SUB	Sets or queries the sub number used when files are saved.	4-23
:FILE:SAVE:TYPE	Sets or queries the filename type used when files are saved.	4-23
:FILE:SOR:GET?	Acquires an SOR file image.	4-23
:FILE:SOR:VALId?	Queries whether the SOR file image is enabled.	4-23
:FILE:SUBFolder:LIST?	Acquires a list of the subfolders in the current folder.	4-24
:FILE:TYPE	Sets or queries the type of file that is saved.	4-24

4.1 List of Commands

Command	Function	Page
FIPRobe Group		
:FIPRobe:PASSfail:CLADding:DEF1:ENABle	Sets or queries whether defects that are 2 µm or less in length in the cladding area are judged.	4-25
:FIPRobe:PASSfail:CLADding:DEF1:THReshold	Sets or queries the threshold for judging defects that are 2 µm or less in length in the cladding area.	4-25
:FIPRobe:PASSfail:CLADding:DEF2:ENABle	Sets or queries whether defects that are 2 µm to 5 µm in length in the cladding area are judged.	4-25
:FIPRobe:PASSfail:CLADding:DEF2:THReshold	Sets or queries the threshold for judging defects that are 2 µm to 5 µm in length in the cladding area.	4-25
:FIPRobe:PASSfail:CLADding:DEF3:ENABle	Sets or queries whether defects that are longer than 5 µm in length in the cladding area are judged.	4-25
:FIPRobe:PASSfail:CLADding:DEF3:THReshold	Sets or queries the threshold for judging defects that are longer than 5 µm in length in the cladding area.	4-25
:FIPRobe:PASSfail:CLADding:SCR1:ENABle	Sets or queries whether scratches that are 3 µm or less in length in the cladding area are judged.	4-26
:FIPRobe:PASSfail:CLADding:SCR1:THReshold	Sets or queries the threshold for judging scratches that are 3 µm or less in length in the cladding area.	4-26
:FIPRobe:PASSfail:CLADding:SCR2:ENABle	Sets or queries whether scratches that are longer than 3 µm in length in the cladding area are judged.	4-26
:FIPRobe:PASSfail:CLADding:SCR2:THReshold	Sets or queries the threshold for judging scratches that are longer than 3 µm in length in the cladding area.	4-26
:FIPRobe:PASSfail:CONtact:DEF:ENABle	Sets or queries whether defects that are longer than 10 µm in length in the contact area are judged.	4-26
:FIPRobe:PASSfail:CONtact:DEF:THReshold	Sets or queries the threshold for judging defects that are longer than 10 µm in length in the contact area.	4-26
:FIPRobe:PASSfail:CONtact:SCR:ENABle	Sets or queries whether scratches in the contact area are judged.	4-26
:FIPRobe:PASSfail:CONtact:SCR:THReshold	Sets or queries the threshold for judging scratches in the contact area.	4-26
:FIPRobe:PASSfail:CORE:DEF1:ENABle	Sets or queries whether defects that are 3 µm or less in length in the core area are judged.	4-27
:FIPRobe:PASSfail:CORE:DEF1:THReshold	Sets or queries the threshold for judging defects that are 3 µm or less in length in the core area.	4-27
:FIPRobe:PASSfail:CORE:DEF2:ENABle	Sets or queries whether defects that are longer than 3 µm in length in the core area are judged.	4-27
:FIPRobe:PASSfail:CORE:DEF2:THReshold	Sets or queries the threshold for judging defects that are longer than 3 µm in length in the core area.	4-27
:FIPRobe:PASSfail:CORE:DEFAny:ENABle	Sets or queries whether defects in the core area are judged.	4-27
:FIPRobe:PASSfail:CORE:DEFAny:THReshold	Sets or queries the threshold for judging defects in the core area.	4-27
:FIPRobe:PASSfail:CORE:SCR1:ENABle	Sets or queries whether scratches that are 3 µm or less in length in the core area are judged.	4-27
:FIPRobe:PASSfail:CORE:SCR1:THReshold	Sets or queries the threshold for judging scratches that are 3 µm or less in length in the core area.	4-27
:FIPRobe:PASSfail:CORE:SCR2:ENABle	Sets or queries whether scratches that are longer than 3 µm in length in the core area are judged.	4-28
:FIPRobe:PASSfail:CORE:SCR2:THReshold	Sets or queries the threshold for judging scratches that are longer than 3 µm in length in the core area.	4-28
:FIPRobe:PASSfail:CORE:SCRAny:ENABle	Sets or queries whether scratches in the core area are judged.	4-28
:FIPRobe:PASSfail:CORE:SCRAny:THReshold	Sets or queries the threshold for judging scratches in the core area.	4-28
:FIPRobe:PASSfail:EXECute	Executes pass/fail judgment.	4-28
:FIPRobe:PASSfail:FIBertype	Sets or queries the type of optical fiber cable.	4-28
:FIPRobe:PASSfail:GET:IMAGe?	Gets the image of the pass/fail judgment results.	4-28
:FIPRobe:PASSfail:GET:SUMMery?	Gets the pass/fail judgment results.	4-28
:FIPRobe:PASSfail:STANdard	Sets or queries the standard that is used for pass/fail judgment.	4-28
:FIPRobe:STATe	Sets or queries the image state of the fiber inspection probe.	4-28

Command	Function	Page
LABel Group		
:LABel:CABLe:CODE	Sets or queries the cable code.	4-29
:LABel:CABLe:ID	Sets or queries the cable ID.	4-29
:LABel:COMPany	Sets or queries the company name.	4-29
:LABel:DFLag:CURRent	Sets or queries the current data flag.	4-29
:LABel:FIBer:ID	Sets or queries the fiber ID.	4-29
:LABel:FIBer:TYPE	Sets or queries the fiber type.	4-29
:LABel:LOCation:ORIGInating	Sets or queries the start position label.	4-29
:LABel:LOCation:TERMINating	Sets or queries the end position label.	4-29
:LABel:OPERator	Sets or queries the operator name.	4-29
LIGHtsource Group		
:LIGHtsource:ABORt	Turns the measurement light off.	4-30
:LIGHtsource:EXECute	Turns the measurement light on.	4-30
:LIGHtsource:MODulation	Sets or queries the light source modulation frequency.	4-30
:LIGHtsource:STATe	Turns the measurement light off or on.	4-30
:LIGHtsource:WAVelength	Sets or queries the light source wavelength.	4-30
MENU Group		
:MENU:ERRor:CLEar	Clears the error dialog box.	4-31
:MENU:FUNCTion	Sets or queries the function mode.	4-31
:MENU:MARKer	Sets or queries the marker mode.	4-31
MISC Group		
:MISC:ALARmsound	Sets or queries the alarm sound.	4-32
:MISC:BACKlightoff	Sets or queries the backlight off setting when the AQ7280 is running on battery power.	4-32
:MISC:BRIGHtness:AC	Sets or queries the LCD brightness when the AC adapter is connected.	4-32
:MISC:BRIGHtness:BATTery	Sets or queries the LCD brightness when the AQ7280 is running on battery power.	4-32
:MISC:BACKlightoff	Sets or queries the backlight off setting when the AQ7280 is running on battery power.	4-32
:MISC:DATE:DAY	Sets or queries the day.	4-32
:MISC:DATE:GET?	Queries the date and time.	4-32
:MISC:DATE:HOuR	Sets or queries the hour.	4-32
:MISC:DATE:MINute	Sets or queries the minute.	4-32
:MISC:DATE:MODE	Sets or queries the date display type.	4-32
:MISC:DATE:MONTH	Sets or queries the month.	4-33
:MISC:DATE:SECOnd	Sets or queries the second.	4-33
:MISC:DATE:SET	Applies the date and time change.	4-33
:MISC:DATE:YEAR	Sets or queries the year.	4-33
:MISC:LANGuage	Sets or queries the language.	4-33
:MISC:POWersave:BATTery	Sets or queries the power-save setting when the AQ7280 is running on battery power.	4-33
:MISC:RLOSmode	Sets or queries the reflection display.	4-33
:MISC:TOUChope	Sets or queries whether touch panel operations are enabled or disabled.	4-34
NETWork Group		
:NETWork:CONTRol:PASSword	Sets or queries the password.	4-35
:NETWork:CONTRol:TIMEout	Sets or queries the timeout value.	4-35
:NETWork:CONTRol:USERname	Sets or queries the user name.	4-35
:NETWork:DHCP	Sets or queries the DHCP on/off state.	4-35
:NETWork:GATeway	Sets or queries the gateway.	4-35
:NETWork:IPAdDress	Sets or queries the IP address.	4-35
:NETWork:NETMask	Sets or queries the subnet mask.	4-35
:NETWork:STATe	Sets or queries the Ethernet on/off state.	4-36
:NETWork:UPNP:ENABle	Sets or queries whether the UPnP port forwarding function is enabled.	4-36
:NETWork:UPNP:STATus?	Queries the UPnP port forwarding configuration status.	4-36
:NETWork:UPNP:URL?	Queries the URL of the UPnP compatible NAT router.	4-36

4.1 List of Commands

Command	Function	Page
PMETer Group		
:PMETer:AVERage:TIMes	Sets or queries the power meter average count.	4-37
:PMETer:DREF	Executes Dref on the power meter.	4-37
:PMETer:LINK:STATe	Sets or queries the light source power meter setting interlock.	4-37
:PMETer:MAXMin:MAX?	Sets or queries the maximum value.	4-37
:PMETer:MAXMin:MIN?	Sets or queries the minimum value.	4-37
:PMETer:MAXMin:STATe	Sets or queries the MAX and MIN display on/off state.	4-37
:PMETer:MEASurement:DATA?	Queries the power meter's measured results.	4-37
:PMETer:MODulation	Sets or queries the power meter modulation.	4-37
:PMETer:OFFSet	Sets or queries the power meter offset.	4-37
:PMETer:REFerence	Sets or queries the power meter reference value.	4-37
:PMETer:THReshold:LOWer	Sets or queries the power meter lower threshold value.	4-37
:PMETer:THReshold:UPPer	Sets or queries the power meter upper threshold value.	4-37
:PMETer:UNIT	Sets or queries the power meter display unit.	4-38
:PMETer:WAVelength:DETail	Sets or queries the wavelength when the wavelength mode is set to Detail.	4-38
:PMETer:ZERoset	Executes zero set on the power meter.	4-38
PMONitor Group		
:PMONitor:DREF	Executes Dref (display reference) on the power monitor.	4-39
:PMONitor:MAX?	Queries the maximum scale value of the power monitor.	4-39
:PMONitor:MEASurement:DATA?	Queries the measured results of the power monitor.	4-39
:PMONitor:MIN?	Queries the minimum scale value of the power monitor.	4-39
:PMONitor:OFFSet	Sets or queries the power monitor offset.	4-39
:PMONitor:REFerence	Sets or queries the power monitor reference.	4-39
:PMONitor:THReshold:LOWer	Sets or queries the power monitor lower threshold limit.	4-39
:PMONitor:THReshold:UPPer	Sets or queries the power monitor upper threshold limit.	4-39
:PMONitor:UNIT	Sets or queries the power unit display unit.	4-39
:PMONitor:WAVelength	Sets or queries the power monitor wavelength.	4-39
:PMONitor:ZERoset	Executes zero-set on the power monitor.	4-39
PRINt Group		
:PRINt:COLor	Sets or queries the print colors.	4-40
:PRINt:EXECute	Executes printing.	4-40
:PRINt:MAKer	Sets or queries the printer manufacturer.	4-40
REPOrt Group		
:REPOrt:EXECute	Creates a report.	4-41
:REPOrt:SET:EVENT:CONDition	Sets or queries the event detection conditions in report settings.	4-41
:REPOrt:SET:EVENT:LIST	Sets or queries the event list in report settings.	4-41
:REPOrt:SET:FIBer	Sets or queries the fiber end face image in report settings.	4-41
:REPOrt:SET:JUDGe	Sets or queries the pass/fail judgment conditions in report settings.	4-41
:REPOrt:SET:MEASure:CONDition	Sets or queries the measurement conditions in report settings.	4-41
:REPOrt:SET:MEASure:INFO	Sets or queries the measurement information in report settings.	4-41
:REPOrt:SET:MEASure:RESUlt	Sets or queries the measurement results in report settings.	4-41
:REPOrt:SET:OVERview	Sets or queries the overview in report settings.	4-41
:REPOrt:SET:WAVE	Sets or queries the waveform in report settings.	4-41
SETup Group		
:SETup:ALLinit	Returns all the settings to their factory default values and formats the internal memory.	4-42
:SETup:INITialize	Returns all settings to their factory defaults.	4-42

Command	Function	Page
STATus Group		
:STATus?	Queries all the settings for the communication status feature.	4-43
:STATus:CONDition?	Queries the contents of the condition register.	4-43
:STATus:ERRor?	Queries the error code and message information (top of the error queue).	4-43
:STATus:QENable	Sets or queries whether or not messages other than errors will be stored to the error queue (on/off).	4-43
:STATus:QMESsage	Sets or queries whether or not message information will be attached to the response to the STATus:ERRor? query (on/off).	4-43
SYSTem Group		
:SYSTem:MODule:OPTion:IDN?	Queries the OPM module or VLS module type.	4-44
:SYSTem:MODule:OTDR:IDN?	Queries OTDR unit type.	4-44
:SYSTem:REBoot	Restarts the AQ7280.	4-44
:SYSTem:SAVE	Executes the saving of setup parameters.	4-44
:SYSTem:SHUTdown	Shuts down the AQ7280.	4-44
VLS Group		
:VLS:ABORT	Turns the visible light source off.	4-45
:VLS:EXECute	Turns the visible light source on.	4-45
:VLS:STATe	Turns the visible light source on or off.	4-45
WAVedata Group		
:WAVedata:DISPlay:SEND:ASCIi?	Queries the data of the displayed waveform in ASCII format.	4-46
:WAVedata:DISPlay:SEND:BINary?	Queries the data of the displayed waveform in binary format.	4-46
:WAVedata:LENGth?	Queries the number of waveform data points.	4-46
:WAVedata:OLDType:DISPlay:SEND?	Queries the data of the displayed waveform in Dot4 format.	4-46
:WAVedata:OLDType:SEND?	Queries the waveform data in Dot4 format.	4-46
:WAVedata:SEND:ASCIi?	Queries the waveform data in ASCII format.	4-46
:WAVedata:SEND:BINary?	Queries the waveform data in block data (in binary format).	4-46
:WAVedata:SEND:SIZE	Sets or queries the number of acquired data points.	4-46
:WAVedata:SEND:START	Sets or queries the starting distance of the waveform data.	4-47
Common Commands		
*CLS (Clear Status)	Clears all event status registers that are displayed in the status byte register summary.	4-48
*ESE (Standard Event Status Enable)	Sets or queries the standard event enable register.	4-48
*ESR? (Standard Event Status Register)	Queries and clears the standard event status register.	4-48
*IDN? (Identification)	Queries the instrument type and firmware version.	4-48
*OPT? (Option)	Queries the option information.	4-48
*RST (Reset)	Returns all the settings except the communication settings to their factory default values.	4-48
*SRE (Service Request Enable)	Sets or queries the service request enable register.	4-49
*STB? (Read Status Byte)	Queries the current status byte register value.	4-49
*TST? (Self Test)	Executes a self-test.	4-49

4.2 ACQUIRE Group

The commands in this group deal with waveform acquisition. You can make the same settings and queries that you can by using the front panel. However, you need to stop measurement before you change measurement conditions remotely. You cannot change the measurement conditions during real-time measurement or during averaged measurement. During measurement, only the `:REALtime:STOP` or `AVERAge:STOP` command is valid.

:ACQUIRE:ADSave

Function Sets or queries whether or not a file is saved automatically after averaged measurement is executed.

Syntax `:ACQUIRE:ADSave <Boolean>`
`:ACQUIRE:ADSave?`

Example `:ACQUIRE:ADSAVE ON`
`:ACQUIRE:ADSAVE? -> :ACQUIRE:ADSAVE 1`

Description If automatic saving is set to ON, the auto save mode is set to "user defined."

:ACQUIRE:AESEARCH

Function Sets or queries whether or not automatic event searching takes place after averaged measurement is executed.

Syntax `:ACQUIRE:AESEARCH <Boolean>`
`:ACQUIRE:AESEARCH?`

Example `:ACQUIRE:AESEARCH OFF`
`:ACQUIRE:AESEARCH?`
`-> :ACQUIRE:AESEARCH 0`

:ACQUIRE:ATTenuation

Function Sets or queries the attenuation.

Syntax `:ACQUIRE:ATTenuation {<NRF>|AUTO}`
`:ACQUIRE:ATTenuation?`

Example `:ACQUIRE:ATTENUATION 2.5`
`:ACQUIRE:ATTENUATION AUTO`
`:ACQUIRE:ATTENUATION?`
`-> :ACQUIRE:ATTENUATION 25.00`

Description

- The range of values that you can set varies depending on the wavelength, distance range, and pulse width.
- You cannot use this command if the averaging mode is set to high reflection.
- You cannot use this command if the distance range is set to auto.

:ACQUIRE:AUTO:ATTenuation?

Function Queries the attenuation value when the attenuation is set to auto.

Syntax `:ACQUIRE:AUTO:ATTenuation?`

Example `:ACQUIRE:AUTO:ATTENUATION?`
`-> :ACQUIRE:AUTO:ATTENUATION 0.00`

:ACQUIRE:AUTO:DRANge?

Function Queries the distance range value when the distance range is set to auto.

Syntax `:ACQUIRE:AUTO:DRANge?`

Example `:ACQUIRE:AUTO:DRANGE?`
`-> :ACQUIRE:AUTO:DRANGE 20000`

Description The unit is meters.

:ACQUIRE:AUTO:PWIDth?

Function Queries the pulse width when the pulse width is set to auto.

Syntax `:ACQUIRE:AUTO:PWIDth?`

Example `:ACQUIRE:AUTO:PWIDTH?`
`-> :ACQUIRE:AUTO:PWIDTH 100E-09`

Description The unit is seconds.

:ACQUIRE:AVERAge:COUNT?

Function Queries the current average count.

Syntax `:ACQUIRE:AVERAge:COUNT?`

Example `:ACQUIRE:AVERAGE:COUNT?`
`-> :ACQUIRE:AVERAGE:COUNT 0`

:ACQUIRE:AVERAge:INDEX

Function Sets or queries the average index.

Syntax `:ACQUIRE:AVERAge`
`:INDEX{AUTO|E2_10|E2_11|...|E2_20}`
`:ACQUIRE:AVERAge:INDEX?`

AUTO: Automatic

E2_10: 2E+10

E2_11: 2E+11

• •

• •

E2_20: 2E+20

Example `:ACQUIRE:AVERAGE:INDEX AUTO`
`:ACQUIRE:AVERAGE:INDEX E2_12`
`:ACQUIRE:AVERAGE:INDEX?`
`-> :ACQUIRE:AVERAGE:INDEX E2_15`

:ACQUIRE:AVERAge:MODE

Function Sets or queries the averaging mode.

Syntax `:ACQUIRE:AVERAge:MODE`
`{HIREFLECTION|HISPEED}`
`:ACQUIRE:AVERAge:MODE?`

HIREFLECTION: High reflection

HISPEED: High speed

Example `:ACQUIRE:AVERAGE:MODE HIREFLECTION`
`:ACQUIRE:AVERAGE:MODE?`
`-> :ACQUIRE:AVERAGE:MODE HISPEED`

:ACQUIRE:AVERAGE:START

Function Executes averaged measurement.
 Syntax :ACQUIRE:AVERAGE:START
 Example :ACQUIRE:AVERAGE:START
 Description You can only use this command when averaged measurement is stopped.

:ACQUIRE:AVERAGE:STOP

Function Stops averaged measurement.
 Syntax :ACQUIRE:AVERAGE:STOP
 Example :ACQUIRE:AVERAGE:STOP
 Description You can only use this command when averaged measurement is taking place.

:ACQUIRE:AVERAGE:TIME

Function Sets or queries the averaged time.
 Syntax :ACQUIRE:AVERAGE:TIME {<NRf>|AUTO}
 :ACQUIRE:AVERAGE:TIME?
 <NRf> = 5, 10, 20, 30, 60, 180, 300, 600, 1200, 1800 (s)
 AUTO: Automatic
 5: 5 s
 10: 10 s
 20: 20 s
 30: 30 s
 60: 1 min
 180: 3 min
 300: 5 min
 600: 10 min
 1200: 20 min
 1800: 30 min
 Example :ACQUIRE:AVERAGE:TIME AUTO
 :ACQUIRE:AVERAGE:TIME 1200
 :ACQUIRE:AVERAGE:TIME?
 -> :ACQUIRE:AVERAGE:TIME 60

:ACQUIRE:AVERAGE:TYPE

Function Sets or queries the average type.
 Syntax :ACQUIRE:AVERAGE
 :TYPE {TIMES|DURATION}
 :ACQUIRE:AVERAGE:TYPE?
 TIMES: Times
 DURATION: Duration
 Example :ACQUIRE:AVERAGE:TYPE TIMES
 :ACQUIRE:AVERAGE:TYPE DURATION
 :ACQUIRE:AVERAGE:TYPE?
 -> :ACQ:AVER:TYPE DURATION

:ACQUIRE:DRANGE

Function Sets or queries the distance range.
 Syntax :ACQUIRE:DRANGE {<NRf>|AUTO}
 :ACQUIRE:DRANGE?
 <NRf> = 200 m to 200000 m (0.2 km to 200 km)
 AUTO: Automatic
 200: 200 m
 500: 500 m
 1000: 1 km
 2000: 2 km
 5000: 5 km
 10000: 10 km
 20000: 20 km
 30000: 30 km
 50000: 50 km
 100000: 100 km
 200000: 200km
 300000: 300 km
 400000: 400 km
 512000: 512 km

Example :ACQUIRE:DRANGE AUTO
 :ACQUIRE:DRANGE 500
 :ACQUIRE:DRANGE 500m
 :ACQUIRE:DRANGE 5000
 :ACQUIRE:DRANGE 100km
 :ACQUIRE:DRANGE?
 -> :ACQUIRE:DRANGE 1000

Description The values that you can set vary depending on the wavelength.

:ACQUIRE:OFFSET

Function Sets or queries the horizontal axis measurement start position.
 Syntax :ACQUIRE:OFFSET <NRf>
 :ACQUIRE:OFFSET?
 Example :ACQUIRE:OFFSET 1000
 :ACQUIRE:OFFSET?
 -> :ACQUIRE:OFFSET 999.99265E+00
 Description The unit is meters.

:ACQUIRE:PLUGCHECK

Function Sets or queries the optical plug connection check feature.
 Syntax :ACQUIRE:PLUGCHECK <Boolean>
 :ACQUIRE:PLUGCHECK?
 Example :ACQUIRE:PLUGCHECK ON
 :ACQUIRE:PLUGCHECK?
 -> :ACQUIRE:PLUGCHECK 0

4.2 ACQUIRE Group

:ACQUIRE:PON:STATE

Function Sets or queries the PON (high SNR mode).

Syntax :ACQUIRE:PON:STATE <Boolean>

:ACQUIRE:PON:STATE?

Example :ACQUIRE:PON:STATE ON

:ACQUIRE:PON:STATE?

-> :ACQUIRE:PON:STATE 0

:ACQUIRE:PWIDTh

Function Sets or queries the pulse width.

Syntax :ACQUIRE:PWIDTh {<NRf>|AUTO}

:ACQUIRE:PWIDTh?

<NRf> = 3 ns to 10 us (3E-9 to 10E-6)

AUTO: Automatic

3E-09: 3 ns

10E-09: 10 ns

20E-09: 20 ns

30E-09: 30 ns

50E-09: 50 ns

100E-09: 100 ns

200E-09: 200 ns

300E-09: 300 ns

500E-09: 500 ns

1E-06: 1 μ s

2E-06: 2 μ s

5E-06: 5 μ s

10E-06: 10 μ s

20E-06: 20 μ s

Example :ACQUIRE:PWIDTh AUTO

:ACQUIRE:PWIDTh 3E-9

:ACQUIRE:PWIDTh 3NS

:ACQUIRE:PWIDTh 10US

:ACQUIRE:PWIDTh 10E-6

:ACQUIRE:PWIDTh?

-> :ACQ:PWID 10.0E-06

Description • The values that you can set vary depending on the wavelength and distance range.
• You cannot use this command if the distance range is set to auto.

:ACQUIRE:REALtime:START

Function Executes real-time measurement.

Syntax :ACQUIRE:REALtime:START

Example :ACQUIRE:REALTIME:START

Description You can only use this command when measurement is stopped.

:ACQUIRE:REALtime:STOP

Function Stops real-time measurement.

Syntax :ACQUIRE:REALtime:STOP

Example :ACQUIRE:REALTIME:STOP

Description You can only use this command when real-time measurement is taking place.

:ACQUIRE:SELECTION:ATTenuation?

Function Queries the selectable attenuation values.

Syntax :ACQUIRE:SELECTION:ATTenuation?

Example :ACQUIRE:SELECTION:ATTENUATION?

-> :ACQUIRE:SELECTION:ATTENUATION AUTO,

0.00,2.50,5.00,7.50,10.00,12.50,

15.00,17.50,20.00

Description The unit is dB.

:ACQUIRE:SELECTION:DRANge?

Function Queries the selectable distance range values.

Syntax :ACQUIRE:SELECTION:DRANge?

Example :ACQUIRE:SELECTION:DRANGE?

-> :ACQUIRE:SELECTION:DRANGE AUTO,200,

500,1000,2000,5000,10000,20000,

30000,50000,100000,200000,300000

Description The unit is m (meters).

:ACQUIRE:SELECTION:PWIDTh?

Function Queries the selectable pulse widths.

Syntax :ACQUIRE:SELECTION:PWIDTh?

Example :ACQUIRE:SELECTION:PWIDTh?

-> :ACQUIRE:SELECTION:PWIDTh AUTO,

3E-09,10E-09,20E-09,30E-09,50E-09,

100E-09,200E-09,300E-09,500E-09

Description The unit is s (seconds).

:ACQUIRE:SELECTION:SMPinterval?

Function Queries the selectable sampling intervals.

Syntax :ACQUIRE:SELECTION:SMPinterval?

NORMAL: Normal

HI: High resolution

Example :ACQUIRE:SELECTION:SMPINTERVAL?

-> :ACQUIRE:SELECTION:

SMPINTERVAL NORMAL,HI

:ACQUIRE:SELECTION:WAVelength?

Function Queries the selectable measurement wavelengths.

Syntax :ACQUIRE:SELECTION:WAVelength?

Example :ACQUIRE:SELECTION:WAVELENGTH?

-> 1310E-09,1550E-09

Description The selectable wavelengths vary depending on the model.

:ACQUIRE:SETTING

Function Sets or queries the measurement mode.

Syntax :ACQUIRE:SETTING {SIMPLE|DETAIL}

:ACQUIRE:SETTING?

SIMPLE: Simple mode

DETAIL: Detailed mode

Example :ACQUIRE:SETTING DETAIL

:ACQUIRE:SETTING?

-> :ACQUIRE:SETTING SIMPLE

:ACQUIRE:SMPinterval:DATA

Function Sets or queries the sampling interval.

Syntax :ACQUIRE:SMPinterval:DATA {<NRF>|
NORMAL|HI}
:ACQUIRE:SMPinterval:DATA?
<NRF> = 0.02 m to 32 m
NORMAL: Normal
HI: High resolution
0.02: 2 cm
0.05: 5 cm
0.10: 10 cm
0.20: 20 cm
0.50: 50 cm
1.00: 1 m
2.00: 2 m
4.00: 4 m
8.00: 8 m
16.00: 16 m
32.00: 32 m

Example :ACQUIRE:SMPINTERVAL:DATA 2.0
:ACQUIRE:SMPINTERVAL:DATA NORMAL
:ACQUIRE:SMPINTERVAL:DATA?
-> :ACQUIRE:SMPINTERVAL:DATA HI

Description When the distance range is set to auto, you can only set the interval to NORMAL or HI.

:ACQUIRE:SMPinterval:VALue?

Function Queries the sampling interval.

Syntax :ACQUIRE:SMPinterval:VALue?

Example :ACQUIRE:SMPINTERVAL:VALUE?
-> :ACQUIRE:SMPINTERVAL:VALUE 8.0

:ACQUIRE:WAVelength

Function Sets or queries the measurement wavelength.

Syntax :ACQUIRE:WAVelength <NRf>
:ACQUIRE:WAVelength?
<NRf> = 0.850 μ m to 1.650 μ m
(850E-9 to 1650E-9)

1310E-09: 1310 nm
1550E-09: 1550 nm

Example :ACQUIRE:WAVELENGTH 0.85UM
:ACQUIRE:WAVELENGTH 1650E-9
:ACQUIRE:WAVELENGTH 1.650E-6
:ACQUIRE:WAVELENGTH?
-> :ACQUIRE:WAVELENGTH 1550E-09

Description The wavelengths that can be specified vary depending on the model.

4.3 ANALysis Group

The commands in this group deal with waveform analysis. You can make the same settings and queries that you can by using the front panel.

:ANALysis:ASEarch:EXECute

Function Executes automatic searching.

Syntax :ANALysis:ASEarch:EXECute

Example :ANALYSIS:ASEARCH:EXECUTE

Description After execution, wait until the AS flag in the return value of the STATus:CONDition? command becomes zero, and then query the event results.

:ANALysis:ASEarch:NUMBER?

Function Queries the number of automatically detected events.

Syntax :ANALysis:ASEarch:NUMBER?

Example :ANALYSIS:ASEARCH:NUMBER?

-> :ANALYSIS:ASEARCH:NUMBER 2

:ANALysis:BCOefficient

Function Sets or queries the backscattering coefficient of the current wavelength.

Syntax :ANALysis:BCOefficient <NRf>

:ANALysis:BCOefficient?

<NRf> = -64.99 to -10.00 (in steps of 0.01)

Example :ANALYSIS:BCOEFFICIENT -25.00

:ANALYSIS:BCOEFFICIENT?

-> :ANALYSIS:BCOEFFICIENT -50.00

:ANALysis:CURSor:DECibel?

Function Queries the cursor dB value.

Syntax :ANALysis:CURSor:DECibel?

Example :ANALYSIS:CURSOR:DECIBEL?

-> :ANALYSIS:CURSOR:DECIBEL 32.878

:ANALysis:CURSor:DELeTe

Function Deletes the cursor.

Syntax :ANALysis:CURSor:DELeTe

Example :ANALYSIS:CURSOR:DELETE

:ANALysis:CURSor:DIStance

Function Sets or queries the cursor position.

Syntax :ANALysis:CURSor:DIStance <NRf>

:ANALysis:CURSor:DIStance?

<NRf> = 0 to distance range (m)

Example :ANALYSIS:CURSOR:DISTANCE 10.00

:ANALYSIS:CURSOR:DISTANCE?

-> :ANALYSIS:CURSOR:DISTANCE

11.529900E+00

Description

- Depends on the distance range, distance reference, and group index.
- The unit is meters.

:ANALysis:CURSor:LIINK

Function Sets or queries the cursor link.

Syntax :ANALysis:CURSor:LIINK <Boolean>

:ANALysis:CURSor:LIINK?

Example :ANALYSIS:CURSOR:LINK ON

:ANALYSIS:CURSOR:LINK?

-> :ANALYSIS:CURSOR:LINK 1

:ANALysis:DUMMy:END

Function Sets the end event of the dummy fiber event number.

Syntax :ANALysis:DUMMy:END <NRf>

:ANALysis:DUMMy:END?

<NRf> = 0 to 2

Example :ANALYSIS:DUMMY:END 0

:ANALYSIS:DUMMY:END?

-> :ANALYSIS:DUMMY:END 1

:ANALysis:DUMMy:STARt

Function Sets the start event of the dummy fiber event number.

Syntax :ANALysis:DUMMy:STARt <NRf>

:ANALysis:DUMMy:STARt?

<NRf> = 0 to 2

Example :ANALYSIS:DUMMY:START 0

:ANALYSIS:DUMMY:START?

-> :ANALYSIS:DUMMY:START 1

:ANALysis:DUNit

Function Sets or queries the distance unit.

Syntax :ANALysis:DUNit{KM|MILE|KF}

:ANALysis:DUNit?

KM: km

MILE: mile

KF: kf

Example :ANALYSIS:DUNIT KM

:ANALYSIS:DUNIT?

-> :ANALYSIS:DUNIT MILE

Description The unit cannot be set to mile,kf in Japanese mode.

:ANALysis:EMARker:LMTEchnique

Function Sets or queries the approximation method (for events).

Syntax :ANALysis:EMARker:LMTEchnique {LSA|TPA}

:ANALysis:EMARker:LMTEchnique?

LSA: Least-square method

TPA: Two-point method

Example :ANALYSIS:EMARKER:LMTECHNIQUE LSA

:ANALYSIS:EMARKER:LMTECHNIQUE?

-> :ANALYSIS:EMARKER:LMTECHNIQUE TPA

:ANALysis:EMARker:SET:M1

Function Sets or queries marker M1 of the current event.

Syntax :ANALysis:EMARker:SET:M1
:ANALysis:EMARker:SET:M1?

Example :ANALYSIS:EMARKER:SET:M1
:ANALYSIS:EMARKER:SET:M1?
-> :ANALYSIS:EMARKER:SET:
M1 5.0471900E+03

Description The marker is set to the cursor position.

:ANALysis:EMARker:SET:M2

Function Sets or queries marker M2 of the current event.

Syntax :ANALysis:EMARker:SET:M2
:ANALysis:EMARker:SET:M2?

Example :ANALYSIS:EMARKER:SET:M2
:ANALYSIS:EMARKER:SET:M2?
-> :ANALYSIS:EMARKER:SET:
M2 7.2463500E+03

Description The marker is set to the cursor position.

:ANALysis:EMARker:SET:M3

Function Sets or queries marker M3 of the current event.

Syntax :ANALysis:EMARker:SET:M3
:ANALysis:EMARker:SET:M3?

Example :ANALYSIS:EMARKER:SET:M3
:ANALYSIS:EMARKER:SET:M3?
-> :ANALYSIS:EMARKER:SET:
M3 9.0471600E+03

Description The marker is set to the cursor position.

:ANALysis:EMARker:SET:Y2

Function Sets or queries marker Y2 of the current event.

Syntax :ANALysis:EMARker:SET:Y2
:ANALysis:EMARker:SET:Y2?

Example :ANALYSIS:EMARKER:SET:Y2
:ANALYSIS:EMARKER:SET:Y2?
-> :ANALYSIS:EMARKER:SET:
Y2 7.3777700E+03

Description The marker is set to the cursor position.

:ANALysis:EVENT:CURRENT:CUMLoss?

Function Sets or queries the cumulative loss of the current event.

Syntax :ANALysis:EVENT:CURRENT:CUMLoss?

Example :ANALYSIS:EVENT:CURRENT:CUMLOSS?
-> 1.810

Description Use this command after you use the :ANALysis:EVENT:CURRENT:INDEX command to set an index number.

:ANALysis:EVENT:CURRENT:DISTance?

Function Acquires the distance of the current event.

Syntax :ANALysis:EVENT:CURRENT:DISTance?

Example :ANALYSIS:EVENT:CURRENT:DISTANCE?
-> 987.000

Description Use this command after you use the :ANALysis:EVENT:CURRENT:INDEX command to set an index number.

:ANALysis:EVENT:CURRENT:INDEX

Function Moves the current event.

Syntax :ANALysis:EVENT:CURRENT:INDEX <Nrf>
<NRF> = Event number (-1 to 100)

1 to 100: Event number
-1: S point, R point
0: E point

Example :ANALYSIS:EVENT:CURRENT:INDEX 5

Description The event that corresponds to the specified number becomes the current event.

:ANALysis:EVENT:CURRENT:IOR?

Function Queries the section group index of the current event.

Syntax :ANALysis:EVENT:CURRENT:IOR?

Example :ANALYSIS:EVENT:CURRENT:IOR?
-> 1.46000

Description Use this command after you use the :ANALysis:EVENT:CURRENT:INDEX command to set an index number.

:ANALysis:EVENT:CURRENT:LOSS?

Function Acquires the connection loss of the current event.

Syntax :ANALysis:EVENT:CURRENT:LOSS?

Example :ANALYSIS:EVENT:CURRENT:LOSS?
-> 2.000

Description Use this command after you use the :ANALysis:EVENT:CURRENT:INDEX command to set an index number.

:ANALysis:EVENT:CURRENT:RETurnloss?

Function Acquires the optical return loss of the current event.

Syntax :ANALysis:EVENT:CURRENT:RETurnloss?

Example :ANALYSIS:EVENT:CURRENT:RETURNLOSS?
-> 2.000

Description Use this command after you use the :ANALysis:EVENT:CURRENT:INDEX command to set an index number.

:ANALysis:EVENT:CURRENT:TYPE?

Function Acquires the event type of the current event.

Syntax :ANALysis:EVENT:CURRENT:TYPE?

Example :ANALYSIS:EVENT:CURRENT:TYPE?
-> REFLECTANCE

REFlectance: Reflectance
SPLus: Positive loss
SMINus: Negative loss

Description Use this command after you use the :ANALysis:EVENT:CURRENT:INDEX command to set an index number.

4.3 ANALYSIS Group

:ANALYSIS:EVENT:CURRENT:UNITLOSS?

Function Acquires the dB/km of the current event.
Syntax :ANALYSIS:EVENT:CURRENT:UNITLOSS?
Example :ANALYSIS:EVENT:CURRENT:UNITLOSS?
-> 2.000

Description Use this command after you use the
:ANALYSIS:EVENT:CURRENT:INDEX command to set
an index number.

:ANALYSIS:EVENT:DELETE

Function Deletes the current event.
Syntax :ANALYSIS:EVENT:DELETE
Example :ANALYSIS:EVENT:DELETE

:ANALYSIS:EVENT:FIX:MODE

Function Sets or queries the event fix mode.
Syntax :ANALYSIS:EVENT:FIX:MODE <MODE1|MODE2>
:ANALYSIS:EVENT:FIX:MODE?
MODE1: Append mode
MODE2: Master mode
Example :ANALYSIS:EVENT:FIX:MODE MODE1
:ANALYSIS:EVENT:FIX:MODE?
-> :ANALYSIS:EVENT:FIX:MODE MODE1

:ANALYSIS:EVENT:FIX:STATE

Function Sets or queries the event fix on/off state.
Syntax :ANALYSIS:EVENT:FIX:STATE <Boolean>
:ANALYSIS:EVENT:FIX:STATE?
Example :ANALYSIS:EVENT:FIX:STATE ON
:ANALYSIS:EVENT:FIX:STATE?
-> :ANALYSIS:EVENT:FIX:STATE 1

:ANALYSIS:EVENT:INSERT

Function Inserts an event at the cursor position.
Syntax :ANALYSIS:EVENT:INSERT
Example :ANALYSIS:EVENT:INSERT

:ANALYSIS:EVENT:IOR

Function Sets or queries the interval index of the current
event.
Syntax :ANALYSIS:EVENT:IOR <NRf>
:ANALYSIS:EVENT:IOR?
<NRf> = 1.30000 to 1.79999 (in steps of 0.00001)
Example :ANALYSIS:EVENT:IOR 1.47
:ANALYSIS:EVENT:IOR?
-> :ANALYSIS:EVENT:IOR 1.46000

:ANALYSIS:FEDTECTION

Function Sets or queries whether or not fault events are
detected.
Syntax :ANALYSIS:FEDTECTION <Boolean>
:ANALYSIS:FEDTECTION?
Example :ANALYSIS:FEDTECTION ON
:ANALYSIS:FEDTECTION?
-> :ANALYSIS:FEDTECTION 0

:ANALYSIS:FMARKER:DELETE

Function Deletes the marker.
Syntax :ANALYSIS:FMARKER:DELETE
Example :ANALYSIS:FMARKER:DELETE

:ANALYSIS:FMARKER:LEFT:DISTANCE?

Function Queries the distance between markers 1 and 2.
Syntax :ANALYSIS:FMARKER:LEFT:DISTANCE?
Example :ANALYSIS:FMARKER:LEFT:DISTANCE?
-> :ANALYSIS:FMARKER:LEFT:
DISTANCE 490.20000E+00

:ANALYSIS:FMARKER:LEFT:LOSS?

Function Queries the loss between markers 1 and 2.
Syntax :ANALYSIS:FMARKER:LEFT:LOSS?
Example :ANALYSIS:FMARKER:LEFT:LOSS?
-> :ANALYSIS:FMARKER:LEFT:
LOSS 137.00000E-03

:ANALYSIS:FMARKER:LEFT:UNITLOSS?

Function Queries the slope between markers 1 and 2.
Syntax :ANALYSIS:FMARKER:LEFT:UNITLOSS?
Example :ANALYSIS:FMARKER:LEFT:UNITLOSS?
-> :ANALYSIS:FMARKER:LEFT:
UNITLOSS 279.00000E-03

:ANALYSIS:FMARKER:LMTECHNIQUE

Function Sets or queries the approximation method (for
markers).
Syntax :ANALYSIS:FMARKER:LMTECHNIQUE {LSA|TPA}
:ANALYSIS:FMARKER:LMTECHNIQUE?
LSA: Least-square method
TPA: Two-point method
Example :ANALYSIS:FMARKER:LMTECHNIQUE LSA
:ANALYSIS:FMARKER:LMTECHNIQUE?
-> :ANALYSIS:FMARKER:LMTECHNIQUE TPA

:ANALYSIS:FMARKER:LOSS?

Function Queries the connection loss.
Syntax :ANALYSIS:FMARKER:LOSS?
Example :ANALYSIS:FMARKER:LOSS?
-> :ANALYSIS:FMARKER:LOSS 162.00000E-03

:ANALYSIS:FMARKER:REFLECTION:SATURATED?

Function Queries the reflection saturation.
Syntax :ANALYSIS:FMARKER:REFLECTION:
SATURATED?
0: Not saturated
1: Saturated
Example :ANALYSIS:FMARKER:REFLECTION:
SATURATED?
-> :ANALYSIS:FMARKER:REFLECTION:
SATURATED 0

:ANALysis:FMARker:REFlection:VALue?

Function Queries the amount of reflection.
 Syntax :ANALysis:FMARker:REFlection:VALue?
 Example :ANALYSIS:FMARKER:REFLECTION:VALUE?
 -> :ANALYSIS:FMARKER:REFLECTION:
 VALUE 1.0640000E+00

**:ANALysis:FMARker:RETurnloss:SATurat
ed?**

Function Queries the optical return loss saturation.
 Syntax :ANALysis:FMARker:RETurnloss:
 SATurated?
 0: Not saturated
 1: Saturated
 Example :ANALYSIS:FMARKER:RETURNLOSS:
 SATURATED?
 -> :ANALYSIS:FMARKER:RETURNLOSS:
 SATURATED 1

:ANALysis:FMARker:RETurnloss:VALue?

Function Queries the optical return loss.
 Syntax :ANALysis:FMARker:RETurnloss:VALue?
 Example :ANALYSIS:FMARKER:RETURNLOSS:VALUE?
 -> :ANALYSIS:FMARKER:RETURNLOSS:
 VALUE 47.003000E+00

:ANALysis:FMARker:RIght:DIStance?

Function Queries the distance between markers 2 and 3.
 Syntax :ANALysis:FMARker:RIght:DIStance?
 Example :ANALYSIS:FMARKER:RIGHT:DISTANCE?
 -> :ANALYSIS:FMARKER:RIGHT:
 DISTANCE 232.95000E+00

:ANALysis:FMARker:RIght:LOSS?

Function Queries the loss between markers 2 and 3.
 Syntax :ANALysis:FMARker:RIght:LOSS?
 Example :ANALYSIS:FMARKER:RIGHT:LOSS?
 -> :ANALYSIS:FMARKER:RIGHT:
 LOSS -159.00000E-03

:ANALysis:FMARker:RIght:UNITloss?

Function Queries the slope between markers 2 and 3.
 Syntax :ANALysis:FMARker:RIght:UNITloss?
 Example :ANALYSIS:FMARKER:RIGHT:UNITLOSS?
 -> :ANALYSIS:FMARKER:RIGHT:
 UNITLOSS -683.00000E-03

:ANALysis:FMARker:SET:M<x>

Function Sets or queries markers.
 Syntax :ANALysis:FMARker:SET:M<x>
 :ANALysis:FMARker:SET:M<x>?
 <x> = 1, 2, 3
 Example :ANALYSIS:FMARKER:SET:M1
 :ANALYSIS:FMARKER:SET:M1?
 -> :ANALYSIS:FMARKER:SET:
 M1 7.2648300E+03

:ANALysis:FMARker:SET:Y<x>

Function Sets or queries auxiliary markers.
 Syntax :ANALysis:FMARker:SET:Y<x>
 :ANALysis:FMARker:SET:Y<x>?
 <x> = 1, 2, 3
 Example :ANALYSIS:FMARKER:SET:Y2
 :ANALYSIS:FMARKER:SET:Y2?
 -> :ANALYSIS:FMARKER:SET:
 Y2 6.1786000E+03

:ANALysis:IOR

Function Sets or queries the group index of the current wavelength.
 Syntax :ANALysis:IOR <Nrf>
 :ANALysis:IOR?
 <NRF> = 1.30000 to 1.79999 (in steps of 0.00001)
 Example :ANALYSIS:IOR 1.48000
 :ANALYSIS:IOR?
 -> :ANALYSIS:IOR 1.48000

:ANALysis:MACRobending:DISPlay

Function Sets or queries the macrobending display on/off state.
 Syntax :ANALysis:MACRobending:
 DISPlay <Boolean>
 Example :ANALYSIS:MACROBENDING:DISPLAY ON
 :ANALYSIS:MACROBENDING:DISPLAY?
 > :ANALYSIS:MACROBENDING:DISPLAY 1

:ANALysis:MACRobending:THReshold

Function Sets or queries the macrobending threshold.
 Syntax :ANALysis:MACRobending:
 THReshold <NRF>
 <NRF> = 0.001 to 99.999 [dB]
 Example :ANALYSIS:MACROBENDING:THRESHOLD 1.000
 :ANALYSIS:MACROBENDING:THRESHOLD?
 -> :ANALYSIS:MACROBENDING:THRESHOLD

:ANALysis:REFeRence:DELeTe

Function Deletes the distance reference.
 Syntax :ANALysis:REFeRence:DELeTe
 Example :ANALYSIS:REFERENCE:DELETE

:ANALysis:REFeRence:DIStance

Function Sets the distance reference or queries its current position.
 Syntax :ANALysis:REFeRence:DIStance
 :ANALysis:REFeRence:DIStance?
 Example :ANALYSIS:REFERENCE:DISTANCE
 :ANALYSIS:REFERENCE:DISTANCE?
 -> :ANALYSIS:REFERENCE:
 DISTANCE 39.999710E+03

Description A query returns a value in meters based on the mouth of the OTDR.

4.3 ANALysis Group

:ANALysis:SECTion:BASElevel?

Function Queries the dB value of the interval data reference point.

Syntax :ANALysis:SECTion:BASElevel?

Example :ANALYSIS:SECTION:BASELEVEL?
-> :ANALYSIS:SECTION:
BASELEVEL 34.268000E+00

:ANALysis:SECTion:DELeTe

Function Deletes the interval analysis data.

Syntax :ANALysis:SECTion:DELeTe

Example :ANALYSIS:SECTION:DELETE

:ANALysis:SECTion:DIStance?

Function Queries the distance of the interval data.

Syntax :ANALysis:SECTion:DIStance?

Example :ANALYSIS:SECTION:DISTANCE?
-> :ANALYSIS:SECTION:
DISTANCE 80.262240E+03

:ANALysis:SECTion:END

Function Sets or queries the end position of the interval data.

Syntax :ANALysis:SECTion:END <Nrf>
<Nrf>: End position

Example :ANALYSIS:SECTION:END
:ANALYSIS:SECTION:END?
-> :ANALYSIS:SECTION:END 119.99912E+03

:ANALysis:SECTion:LMTechnique

Function Sets or queries the interval analysis approximation method.

Syntax :ANALysis:SECTion:LMTechnique {LSA|TPA}
:ANALysis:SECTion:LMTechnique?

LSA: Least-square method
TPA: Two-point method

Example :ANALYSIS:SECTION:LMTECHNIQUE LSA
:ANALYSIS:SECTION:LMTECHNIQUE?
-> :ANALYSIS:SECTION:LMTECHNIQUE LSA

:ANALysis:SECTion:LOSS?

Function Queries the loss of the interval data.

Syntax :ANALysis:SECTion:LOSS?

Example :ANALYSIS:SECTION:LOSS?
-> :ANALYSIS:SECTION:LOSS 7.9300000E+00

:ANALysis:SECTion:REFeRence

Function Sets the interval data reference point.

Syntax :ANALysis:SECTion:REFeRence

Example :ANALYSIS:SECTION:REFERENCE

:ANALysis:SECTion:RETurnloss:SATurated?

Function Queries the optical return loss saturation of the interval data.

Syntax :ANALysis:SECTion:RETurnloss:
SATurated?

Example :ANALYSIS:SECTION:RETURNLOSS:
SATURATED?
-> :ANALYSIS:SECTION:RETURNLOSS:
SATURATED 1

:ANALysis:SECTion:RETurnloss:VALue?

Function Queries the optical return loss of the interval data.

Syntax :ANALysis:SECTion:RETurnloss:VALue?

Example :ANALYSIS:SECTION:RETURNLOSS:VALUE?
-> :ANALYSIS:SECTION:RETURNLOSS:
VALUE 48.250000E+00

:ANALysis:SECTion:STARt

Function Sets or queries the start position of the interval data.

Syntax :ANALysis:SECTion:STARt <Nrf>
<Nrf>: Start position

Example :ANALYSIS:SECTION:START
:ANALYSIS:SECTION:START?
-> :ANALYSIS:SECTION:
START 39.736870E+03

:ANALysis:SPLitter:STATe

Function Sets or queries whether splitter search is on or off.

Syntax :ANALysis:SPLitter:STATe <Boolean>
:ANALysis:SPLitter:STATe?

Example :ANALYSIS:SPLITTER:STATE ON
:ANALYSIS:SPLITTER:STATE?
-> :ANALYSIS:SPLITTER:STATE 1

:ANALysis:THReshold:EOFiber

Function Sets or queries the fiber end threshold.

Syntax :ANALysis:THReshold:EOFiber <Nrf>
:ANALysis:THReshold:EOFiber?
<Nrf> = 3 to 65

Example :ANALYSIS:THRESHOLD:EOFIBER 5
:ANALYSIS:THRESHOLD:EOFIBER?
-> :ANALYSIS:THRESHOLD:EOFIBER 10

Description After setting the value, wait until the AS flag in the return value of the STATus:CONDition? command becomes zero, and then query the event results.

:ANALysis:THReshold:FECLoss

Function Sets or queries the fault event connector loss threshold.

Syntax :ANALysis:THReshold:FECLoss <Nrf>
:ANALysis:THReshold:FECLoss?
<Nrf> = 0.01 to 9.99

Example :ANALYSIS:THRESHOLD:FECLOSS 0.01
:ANALYSIS:THRESHOLD:FECLOSS?
-> :ANALYSIS:THRESHOLD:FECLOSS 1.23

Description After setting the value, wait until the AS flag in the return value of the STATus:CONDition? command becomes zero, and then query the event results.

:ANALysis:THReshold:FERLoss

Function Sets or queries the fault event optical return loss threshold.

Syntax :ANALysis:THReshold:FERLoss <Nrf>
:ANALysis:THReshold:FERLoss?
<Nrf> = 20 to 70

Example :ANALYSIS:THRESHOLD:FERLOSS 50
:ANALYSIS:THRESHOLD:FERLOSS?
-> :ANALYSIS:THRESHOLD:FERLOSS 30

Description After setting the value, wait until the AS flag in the return value of the STATus:CONDition? command becomes zero, and then query the event results.

:ANALysis:THReshold:FESLoss

Function Sets or queries the fault event connection loss threshold.

Syntax :ANALysis:THReshold:FESLoss <Nrf>
:ANALysis:THReshold:FESLoss?
<Nrf> = 0.01 to 9.99

Example :ANALYSIS:THRESHOLD:FESLOSS 0.01
:ANALYSIS:THRESHOLD:FESLOSS?
-> :ANALYSIS:THRESHOLD:FESLOSS 1.23

Description After setting the value, wait until the AS flag in the return value of the STATus:CONDition? command becomes zero, and then query the event results.

:ANALysis:THReshold:FESPloss

Function Sets or queries the fault event splitter loss threshold.

Syntax :ANALysis:THReshold:FESPloss <Nrf>
:ANALysis:THReshold:FESPloss?
<Nrf> = 1 to 20

Example :ANALYSIS:THRESHOLD:FESPLOSS 1
:ANALYSIS:THRESHOLD:FESPLOSS?
-> :ANALYSIS:THRESHOLD:FESPLOSS 20

Description After setting the value, wait until the AS flag in the return value of the STATus:CONDition? command becomes zero, and then query the event results.

:ANALysis:THReshold:FETLoss

Function Sets or queries the fault event total loss threshold.

Syntax :ANALysis:THReshold:FETLoss <Nrf>
:ANALysis:THReshold:FETLoss?
<Nrf> = 1 to 65

Example :ANALYSIS:THRESHOLD:FETLOSS 1
:ANALYSIS:THRESHOLD:FETLOSS?
-> :ANALYSIS:THRESHOLD:FETLOSS 65

Description After setting the value, wait until the AS flag in the return value of the STATus:CONDition? command becomes zero, and then query the event results.

:ANALysis:THReshold:FEULoss

Function Sets or queries the fault event dB/km threshold.

Syntax :ANALysis:THReshold:FEULoss <Nrf>
:ANALysis:THReshold:FEULoss?
<Nrf> = 0.01 to 9.99

Example :ANALYSIS:THRESHOLD:FEULOSS 0.01
:ANALYSIS:THRESHOLD:FEULOSS?
-> :ANALYSIS:THRESHOLD:FEULOSS 1.23

Description After setting the value, wait until the AS flag in the return value of the STATus:CONDition? command becomes zero, and then query the event results.

:ANALysis:THReshold:RLOSS

Function Sets or queries the optical return loss threshold.

Syntax :ANALysis:THReshold:RLOSS <Nrf>
:ANALysis:THReshold:RLOSS?
<Nrf> = 20 to 70

Example :ANALYSIS:THRESHOLD:RLOSS 50
:ANALYSIS:THRESHOLD:RLOSS?
-> :ANALYSIS:THRESHOLD:RLOSS 30

Description After setting the value, wait until the AS flag in the return value of the STATus:CONDition? command becomes zero, and then query the event results.

:ANALysis:THReshold:SLOSS

Function Sets or queries the connection loss threshold.

Syntax :ANALysis:THReshold:SLOSS <Nrf>
:ANALysis:THReshold:SLOSS?
<Nrf> = 0.01 to 9.99

Example :ANALYSIS:THRESHOLD:SLOSS 0.01
:ANALYSIS:THRESHOLD:SLOSS?
-> :ANALYSIS:THRESHOLD:SLOSS 1.23

Description After setting the value, wait until the AS flag in the return value of the STATus:CONDition? command becomes zero, and then query the event results.

:ANALysis:THReshold:SPLOSS

Function Sets or queries the splitter loss threshold.

Syntax :ANALysis:THReshold:SPLOSS <Nrf>
:ANALysis:THReshold:SPLOSS?
<Nrf> = 1 to 20

Example :ANALYSIS:THRESHOLD:SPLOSS 1
:ANALYSIS:THRESHOLD:SPLOSS?
-> :ANALYSIS:THRESHOLD:SPLOSS 20

Description After setting the value, wait until the AS flag in the return value of the STATus:CONDition? command becomes zero, and then query the event results.

4.4 COMMunicate Group

The commands in this group deal with communications. There are no front panel keys that correspond to the commands in this group.

:COMMunicate?

Function Queries all communication settings.

Syntax :COMMunicate?

Example :COMMUNICATE?

-> :COMMUNICATE:HEADER 1;VERBOSE 0

:COMMunicate:HEADer

Function Sets or queries whether or not a header is added to the response to a query. (Example with header: PMETer:REFErence 5.00. Example without header: 5.00.)

Syntax :COMMunicate:HEADer <Boolean>

:COMMunicate:HEADer?

Example :COMMUNICATE:HEADER ON

:COMMUNICATE:HEADER?

->:COMMUNICATE:HEADER 1

:COMMunicate:VERBose

Function Sets or queries whether the response to a query is returned fully spelled out (example: PMETer:REFErence 5.00) or using abbreviation (example: PMET:REF 5.00).

Syntax :COMMunicate:VERBose <Boolean>

:COMMunicate:VERBose?

Example :COMMUNICATE:VERBOSE ON

:COMMUNICATE:VERBOSE?

->:COMMUNICATE:VERBOSE 0

4.5 DISPlay Group

The commands in this group deal with the screen display.

You can make the same settings and queries that you can by using the front panel.

:DISPlay:ALINe

Function Sets or queries the display of approximated lines.

Syntax :DISPlay:ALINe <Boolean>
:DISPlay:ALINe?

Example :DISPLAY:ALINE ON
:DISPLAY:ALINE? -> :DISPLAY:ALINE 0

:DISPlay:COLor

Function Sets or queries the screen colors.

Syntax :DISPlay:COLor {COLOR|BLACKWHITE}
:DISPlay:COLor?

COLOR: Color
BLACKWHITE: Black and white

Example :DISPLAY:COLOR COLOR
:DISPLAY:COLOR?
-> :DISPLAY:COLOR COLOR

:DISPlay:CURSor:DBValue

Function Sets or queries the cursor dB value.

Syntax :DISPlay:CURSor:DBValue <Boolean>
:DISPlay:CURSor:DBValue?

Example :DISPLAY:CURSOR:DBVALUE ON
:DISPLAY:CURSOR:DBVALUE?
-> :DISPLAY:CURSOR:DBVALUE 1

:DISPlay:CURSor:SECOnd

Function Sets or queries the second-cursor display.

Syntax :DISPlay:CURSor:SECOnd <Boolean>
:DISPlay:CURSor:SECOnd?

Example :DISPLAY:CURSOR:SECOND ON
:DISPLAY:CURSOR:SECOND?
-> :DISPLAY:CURSOR:SECOND 1

:DISPlay:CURSor:TYPE

Function Sets or queries the cursor display format.

Syntax :DISPlay:CURSor:TYPE {CROSS|LINE}
:DISPlay:CURSor:TYPE?

CROSS: CROSS (+)
LINE: LINE (|)

Example :DISPLAY:CURSOR:TYPE LINE
:DISPLAY:CURSOR:TYPE?
-> :DISPLAY:CURSOR:TYPE CROSS

:DISPlay:DECibel:UPPer

Function Sets or queries the display start level.

Syntax :DISPlay:DECibel:UPPer <NRf>
:DISPlay:DECibel:UPPer?
<NRf> = 1.6 to 70 (dB)

Example :DISPLAY:DECIBEL:UPPER 60
:DISPLAY:DECIBEL:UPPER?
-> :DISPLAY:DECIBEL:UPPER 50.0

Description The range that can be specified varies depending on the vertical axis zoom.

:DISPlay:DIGit:DECibel

Function Sets or queries the number of decimal places of the dB display.

Syntax :DISPlay:DIGit:DECibel {DIGIT1|DIGIT2|
DIGIT3}
:DISPlay:DIGit:DECibel?

DIGIT1: **
DIGIT2: ****
DIGIT3: *****

Example :DISPLAY:DIGIT:DECIBEL DIGIT3
:DISPLAY:DIGIT:DECIBEL?
-> :DISPLAY:DIGIT:DECIBEL DIGIT3

:DISPlay:DIGit:DISTance

Function Sets or queries the number of decimal places of the distance display.

Syntax :DISPlay:DIGit:DISTance {DIGIT3|DIGIT4|
DIGIT5}
:DISPlay:DIGit:DISTance?

DIGIT3: *****
DIGIT4: ******
DIGIT5: *******

Example :DISPLAY:DIGIT:DISTANCE DIGIT5
:DISPLAY:DIGIT:DISTANCE?
-> :DISPLAY:DIGIT:DISTANCE DIGIT5

:DISPlay:DISTance:LEFT

Function Sets or queries the display start distance.

Syntax DISPlay:DISTance:LEFT <NRf>
DISPlay:DISTance:LEFT?

Example DISPLAY:DISTANCE:LEFT 1000
DISPLAY:DISTANCE:LEFT?
-> :DISPLAY:DISTANCE:LEFT 498.97000E+00

Description The range of values that you can set varies depending on the horizontal axis zoom.

4.5 DISPlay Group

:DISPlay:DIVide:DECibel

Function Sets or queries the vertical axis zoom.
Syntax :DISPlay:DIVide:DECibel <NRf>
:DISPlay:DIVide:DECibel?
<NRf> = 0.2 to 7.5 (0.2, 0.5, 1.0, 2.0, 5.0, 7.5)
Example :DISPLAY:DIVIDE:DECIBEL 5.0
:DISPLAY:DIVIDE:DECIBEL?
-> :DISPLAY:DIVIDE:DECIBEL 1.0
Description The unit is decibels.

:DISPlay:DIVide:DISTance

Function Sets or queries the horizontal axis zoom.
Syntax :DISPlay:DIVide:DISTance <NRf>
:DISPlay:DIVide:DISTance?
<NRf> = 1m to 60km
Example :DISPLAY:DIVIDE:DISTANCE 2000
:DISPLAY:DIVIDE:DISTANCE?
-> :DISPLAY:DIVIDE:DISTANCE 10.0E+03
Description The range of values that you can set varies depending on the distance range.

512 k range:	160 m to 60 km
400 k range:	160 m to 40 km
300 k range:	160 m to 30 km
200 k range:	160 m to 20 km
100 k range:	160 m to 10 km
50 k range:	20 m to 5 km
30 k range:	10 m to 3 km
20 k range:	5 m to 2 km
10 k range:	5 m to 1 km
5 k range:	5 to 500 m
2 k range:	5 to 200 m
1 k range:	2.5 to 100 m
500 m range:	1 to 50 m
200 m range:	1 to 50 m

:DISPlay:EVENT:AZOom

Function Sets or queries the event auto zoom.
Syntax :DISPlay:EVENT:AZOom <Boolean>
:DISPlay:EVENT:AZOom?
Example :DISPLAY:EVENT:AZOOM ON
:DISPLAY:EVENT:AZOOM?
-> :DISPLAY:EVENT:AZOOM 1

:DISPlay:INITialize:SCALe

Function Initializes the display scale.
Syntax :DISPlay:INITialize:SCALe
Example :DISPLAY:INITIALIZE:SCALE

:DISPlay:MARKer:INFOrmation

Function Sets or queries the display of marker information.
Syntax :DISPlay:MARKer:INFOrmation <Boolean>
:DISPlay:MARKer:INFOrmation?
Example :DISPLAY:MARKER:INFOMATION ON
:DISPLAY:MARKER:INFOMATION?
-> :DISPLAY:MARKER:INFOMATION 1

:DISPlay:SCALe

Function Sets or queries the scale display.
Syntax :DISPlay:SCALe <Boolean>
:DISPlay:SCALe?
Example :DISPLAY:SCALE ON
:DISPLAY:SCALE?
-> :DISPLAY:SCALE 1

:DISPlay:WAVE:EXPand

Function Sets or queries the waveform area expansion mode.
Syntax :DISPlay:WAVE:EXPand <Boolean>
:DISPlay:WAVE:EXPand?
Example :DISPLAY:WAVE:EXPAND ON
:DISPLAY:WAVE:EXPAND ?
-> :DISPLAY:WAVE:EXPAND 1

4.6 FILE Group

The commands in this group deal with operations such as saving and loading data. You can perform the same operations and make the same settings and queries that you can by using the front panel.

:FILE:DELeTe:EXECute

Function Deletes files.
Syntax :FILE:DELeTe:EXECute <Character string>
 <Character string> = File or folder name
Example :FILE:DELeTe:EXECUTE "0001.SOR"
Description You can also delete folders.

:FILE:DRIVE:FREE?

Function Queries the amount of free space on the current drive.
Syntax :FILE:DRIVE:FREE?
Example :FILE:DRIVE:FREE? -> 1234567
Description The value is the number of bytes.

:FILE:DRIVE:SET

Function Sets or queries the current drive setting.
Syntax :FILE:DRIVE:SET {INTERNAL|SD|USB1|USB2}
 :FILE:DRIVE:SET?
 INTERNAL: Internal memory
 SD: SD card (external memory)
 USB1: USB memory 1
 USB2: USB memory 2
Example :FILE:DRIVE:SET USB1
 :FILE:DRIVE:SET?
 -> :FILE:DRIVE:SET INTERNAL
Description The report output destination will also be the drive specified by this command.

:FILE:FILE:EXIST?

Function Checks whether or not the specified file exists.
Syntax :FILE:FILE:EXIST?
Example :FILE:FILE:EXIST?
 -> :FILE:FILE:EXIST 1
Description Returns 1 if the file exists and 0 if the file does not exist.

:FILE:FILE:GET?

Function Acquires the specified file.
Syntax :FILE:FILE:GET?
Example :FILE:FILE:GET?
 -> #220ABCDEFGHJIJ1234567890
Description A block data header is attached to the start of the loaded data.

```
#220ABCDEFGHJIJ1234567890
  |_____|
  |_____| The data starts here
  |_____| Number of data points
  |_____| Data length
```

:FILE:FILE:NAME

Function Specifies the file name used for file acquisition, file size acquisition, and file transfer.
Syntax :FILE:FILE:NAME <Character string>
 :FILE:FILE:NAME?
Example :FILE:FILE:NAME "0.SOR"
 :FILE:FILE:NAME?
 -> :FILE:FILE:NAME "0.SOR"
Description

- The following characters cannot be used in folder names:
 ", *, /, :, <, >, ?, \, |
- The following character strings cannot be used in folder names:
 "AUX," "CON," "PRN," "NUL," "CLOCK," "LPT1," "LPT2," "LPT3," "LPT4," "LPT5," "LPT6," "LPT7," "LPT8," "LPT9," "COM1," "COM2," "COM3," "COM4," "COM5," "COM6," "COM7," "COM8," "COM9"

:FILE:FILE:SIZE?

Function Acquires the size of the specified file.
Syntax :FILE:FILE:SIZE?
Example :FILE:FILE:SIZE?
 -> :FILE:FILE:SIZE 230781

:FILE:FOLDeR:LIST?

Function Acquires a list of the contents of the current folder.
Syntax :FILE:FOLDeR:LIST?
Example :FILE:FOLDeR:LIST?
 -> :FILE:FOLDeR:
 LIST "3,ABC.SOR,DEF.SOR,MACRO/"
Description Returns the number of results followed by the file and folder names. Folder names are followed by slashes.

:FILE:FOLDeR:MAKE

Function Creates a folder.
Syntax :FILE:FOLDeR:MAKE <Character string>
 <Character string> = Folder name
Example :FILE:FOLDeR:MAKE "Data"

4.6 FILE Group

: FILE : FOLDeR : PATH

Function Sets or queries the current folder name.

Syntax : FILE:FOLDeR:PATH <Character string>
: FILE:FOLDeR:PATH?
<Character string> = Folder name

Example : FILE:FOLDER:PATH "AQ7280"
: FILE:FOLDER:PATH?
-> : FILE:FOLD:PATH "AQ7280"

Description

- Moves up or down the hierarchy from the current location one directory at a time (specify ".." to return to the parent directory).
- The following characters cannot be used in folder names:
", *, /, :, <, >, ?, \, |
- The following character strings cannot be used in folder names: "AUX," "CON," "PRN," "NUL," "CLOCK," "LPT1," "LPT2," "LPT3," "LPT4," "LPT5," "LPT6," "LPT7," "LPT8," "LPT9," "COM1," "COM2," "COM3," "COM4," "COM5," "COM6," "COM7," "COM8," "COM9"
- The report output destination will also be the drive specified by this command.

: FILE : LOAD : EXECute

Function Loads a file.

Syntax : FILE:LOAD:EXECute <Character string>
<Character string> = File name

Example : FILE:LOAD:EXECUTE "0001.SOR"

: FILE : SAVE : COMMeNt1

Function Sets or queries the save comment 1.

Syntax : FILE:SAVE:COMMeNt1 <Character string>
: FILE:SAVE:COMMeNt1?

Example : FILE:SAVE:COMMENT1 "AQ7280"
: FILE:SAVE:COMMENT1? -> "AQ7280"

Description You can enter up to 30 characters.

: FILE : SAVE : COMMeNt2

Function Sets or queries the save comment 2.

Syntax : FILE:SAVE:COMMeNt2 <Character string>
: FILE:SAVE:COMMeNt2?

Example : FILE:SAVE:COMMENT2 "AQ7280"
: FILE:SAVE:COMMENT2? -> "AQ7280"

Description You can enter up to 30 characters.

: FILE : SAVE : COMMeNt3

Function Sets or queries the save comment 3.

Syntax : FILE:SAVE:COMMeNt3 <Character string>
: FILE:SAVE:COMMeNt3?

Example : FILE:SAVE:COMMENT3 "AQ7280"
: FILE:SAVE:COMMENT3? -> "AQ7280"

Description You can enter up to 30 characters.

: FILE : SAVE : COMMeNt4

Function Sets or queries the save comment 4.

Syntax : FILE:SAVE:COMMeNt4 <Character string>
: FILE:SAVE:COMMeNt4?

Example : FILE:SAVE:COMMENT4 "AQ7280"
: FILE:SAVE:COMMENT4? -> "AQ7280"

Description You can enter up to 30 characters.

: FILE : SAVE : COMMeNt5

Function Sets or queries the save comment 5.

Syntax : FILE:SAVE:COMMeNt5 <Character string>
: FILE:SAVE:COMMeNt5?

Example : FILE:SAVE:COMMENT5 "AQ7280"
: FILE:SAVE:COMMENT5? -> "AQ7280"

Description You can enter up to 30 characters.

: FILE : SAVE : COMMeNt6

Function Sets or queries the save comment 6.

Syntax : FILE:SAVE:COMMeNt6 <Character string>
: FILE:SAVE:COMMeNt6?

Example : FILE:SAVE:COMMENT6 "AQ7280"
: FILE:SAVE:COMMENT6? -> "AQ7280"

Description You can enter up to 30 characters.

: FILE : SAVE : COMMeNt7

Function Sets or queries the save comment 7.

Syntax : FILE:SAVE:COMMeNt7 <Character string>
: FILE:SAVE:COMMeNt7?

Example : FILE:SAVE:COMMENT7 "AQ7280"
: FILE:SAVE:COMMENT7? -> "AQ7280"

Description You can enter up to 30 characters.

: FILE : SAVE : COMMeNt8

Function Sets or queries the save comment 8.

Syntax : FILE:SAVE:COMMeNt8 <Character string>
: FILE:SAVE:COMMeNt8?

Example : FILE:SAVE:COMMENT8 "AQ7280"
: FILE:SAVE:COMMENT8? -> "AQ7280"

Description You can enter up to 30 characters.

: FILE : SAVE : COMMeNt9

Function Sets or queries the save comment 9.

Syntax : FILE:SAVE:COMMeNt9 <Character string>
: FILE:SAVE:COMMeNt9?

Example : FILE:SAVE:COMMENT9 "AQ7280"
: FILE:SAVE:COMMENT9? -> "AQ7280"

Description You can enter up to 30 characters.

: FILE : SAVE : COMMeNt10

Function Sets or queries the save comment 10.

Syntax : FILE:SAVE:COMMeNt10 <Character string>
: FILE:SAVE:COMMeNt10?

Example : FILE:SAVE:COMMENT10 "AQ7280"
: FILE:SAVE:COMMENT10? -> "AQ7280"

Description You can enter up to 30 characters.

: FILE : SAVE : EXECute

Function Saves the file.
 Syntax :FILE:SAVE:EXECute
 Example :FILE:SAVE:EXECUTE
 Description To check for errors after saving, first make sure that files are not being accessed by executing the STATus:CONDition? command, and then execute the STATus:ERRor command.
 (See section 5.1, "Status Register.")

: FILE : SAVE : ID

Function Sets or queries the save ID.
 Syntax :FILE:SAVE:ID <NRf>
 :FILE:SAVE:ID?
 <NRf> = 0 to 9999
 Example :FILE:SAVE:ID 100
 :FILE:SAVE:ID? -> :FILE:SAVE:ID 100

: FILE : SAVE : ITEM<x>

Function Sets or queries the saved items.
 Syntax :FILE:SAVE:ITEM<x> {NONE|WAVELENGTH|ID|COMMENT1|COMMENT2|COMMENT3|COMMENT4|COMMENT5|COMMENT6|COMMENT7|COMMENT8|COMMENT9|COMMENT10|COMPANY|OPERATOR|CABLEID|FIBERID|FIBERTYPE|CABLECODE|ORIGINATING|TERMINATING}
 :FILE:SAVE:ITEM<x>?
 <x> = 1 to 10
 NONE: None
 WAVELENGTH: Wavelength
 ID: ID
 COMMENT1 to 10: Comment1 to 10
 COMPANY: Company name
 OPERATOR: Name
 CABLEID: Cable ID
 FIBERID: Fiber ID
 FIBERTYPE: Fiber type
 CABLECODE: Cable code
 ORIGINATING: Start position
 TERMINATING: End position

Example :FILE:SAVE:ITEM1 WAVELENGTH
 :FILE:SAVE:ITEM1?
 -> :FILE:SAVE:ITEM WAVELENGTH

Description You cannot specify NONE when <x> = 1.

: FILE : SAVE : SEParator

Function Sets or queries the separator used when files are saved.
 Syntax :FILE:SAVE:SEParator {NONE|UNDERBAR|TILDE|HAT}
 :FILE:SAVE:SEParator?
 NONE: None
 UNDERBAR: Underscore (_)
 TILDE: Tilde (~)
 HAT: Hat (^)
 Example :FILE:SAVE:SEPARATOR UNDERBAR
 :FILE:SAVE:SEPARATOR?
 -> :FILE:SAVE:SEPARATOR UNDERBAR

: FILE : SAVE : SUB

Function Sets or queries the sub number used when files are saved.

Syntax :FILE:SAVE:SUB {OFF|AB|AC|AD|AE|AF|AG|AH}
 :FILE:SAVE:SUB?
 OFF: OFF
 AB: a-b
 AC: a-c
 AD: a-d
 AE: a-e
 AF: a-f
 AG: a-g
 AH: a-h

Example :FILE:SAVE:SUB AH
 :FILE:SAVE:SUB? -> :FILE:SAVE:SUB OFF

: FILE : SAVE : TYPE

Function Sets or queries the filename type used when files are saved.

Syntax :FILE:SAVE:TYPE {NO|COMMENT|CMNO|NOCM|CMWLN|NOCMWL|WLCMNO}
 :FILE:SAVE:TYPE?
 NO: Number
 COMMENT: Comment
 CMNO: Comment + number
 NOCM: Number + comment
 CMWLN: Comment + wavelength + number
 NOCMWL: Number + comment + wavelength
 WLCMNO: Wavelength + comment + number

Example :FILE:SAVE:TYPE COMMENT
 :FILE:SAVE:TYPE?
 -> :FILE:SAVE:TYPE CMWLN

Description This is a simplified version of the :FILE:SAVE:ITEM<x> command. The AQ7280 returns "UNKNOWN" for items other than number (ID no.), comment, and wavelength.

: FILE : SOR : GET?

Function Acquires an SOR file image.

Syntax :FILE:SOR:GET?

Example :FILE:SOR:GET? -> #6123456ABCDEFGHJ

Description • You can perform acquisition when SOR measurement data is enabled. You can use :FILE:SOR:VALid? to query whether the SOR measurement data is enabled.
 • The SOR file image is acquired as block data (in binary format).

: FILE : SOR : VALid?

Function Queries whether the SOR file image is enabled.

Syntax :FILE:SOR:VALid?

Example :FILE:SOR:VALID? -> :FILE:SOR:VALID 1

Description Measured data
 0: Disabled
 1: Enabled

4.6 FILE Group

:FILE:SUBFolder:LIST?

Function Acquires a list of the subfolders in the current folder.

Syntax :FILE:SUBFolder:LIST?

Example :FILE:SUBFOLDER:LIST?

```
-> :FILE:SUBFOLDER:  
LIST "3,ABC/,DEF/,MACRO/"
```

Description Returns the number of results followed by the file and folder names. Folder names are followed by slashes.

:FILE:TYPE

Function Sets or queries the type of file that is saved.

Syntax :FILE:TYPE {SET|SOR|CSV_WAVE|CSV_EVENT|
BMP|PNG|JPG|CFG}

:FILE:TYPE?

SET: A setup file

SOR: A file that conforms to Telcordia SR-4731

CSV_WAVE: A CSV waveform file

CSV_EVENT: A CSV event file

BMP: A BMP file

PNG: A PNG file

JPG: A JPG file

CFG: System setup data file

Example :FILE:TYPE SOR

```
:FILE:TYPE? -> :FILE:TYPE CSV_WAVE
```

Description SOR, CSV_WAVE, and CSV_ENENT are only valid when the function mode is set to OTDR.

4.7 FIPRobe Group

The commands in this group deal with the pass/fail judgment of fiber end faces. You can perform the same operations and make the same settings and queries that you can from the front panel. This function is valid when the /FST option is installed.

:FIPRobe:PASSfail:CLADding:DEF1:ENABLE

Function Sets or queries whether defects that are 2 μm or less in length in the cladding area are judged.

Syntax :FIPRobe:PASSfail:CLADding:DEF1:
ENABLE {<Boolean>}

Example :FIPROBE:PASSFAIL:CLADDING:DEF1:
ENABLE ON
:FIPROBE:PASSFAIL:CLADDING:DEF1:
ENABLE?
-> :FIPROBE:PASSFAIL:CLADDING:DEF1:
ENABLE 1

:FIPRobe:PASSfail:CLADding:DEF1:THResh old

Function Sets or queries the threshold for judging defects that are 2 μm or less in length in the cladding area.

Syntax :FIPRobe:PASSfail:CLADding:DEF1:
THReshold {<Nrf>}
<Nrf> = 0 to 100

Example :FIPROBE:PASSFAIL:CLADDING:DEF1:
THRESHOLD 0
:FIPROBE:PASSFAIL:CLADDING:DEF1:
THRESHOLD?
-> :FIPROBE:PASSFAIL:CLADDING:DEF1:
THRESHOLD 0

:FIPRobe:PASSfail:CLADding:DEF2:ENABLE

Function Sets or queries whether defects that are 2 μm to 5 μm in length in the cladding area are judged.

Syntax :FIPRobe:PASSfail:CLADding:DEF2:
ENABLE {<Boolean>}

Example :FIPROBE:PASSFAIL:CLADDING:DEF2:
ENABLE ON
:FIPROBE:PASSFAIL:CLADDING:DEF2:
ENABLE?
-> :FIPROBE:PASSFAIL:CLADDING:DEF2:
ENABLE 1

:FIPRobe:PASSfail:CLADding:DEF2:THResh old

Function Sets or queries the threshold for judging defects that are 2 μm to 5 μm in length in the cladding area.

Syntax :FIPRobe:PASSfail:CLADding:DEF2:
THReshold {<Nrf>}
<Nrf> = 0 to 100

Example :FIPROBE:PASSFAIL:CLADDING:DEF2:
THRESHOLD 0
:FIPROBE:PASSFAIL:CLADDING:DEF2:
THRESHOLD?
-> :FIPROBE:PASSFAIL:CLADDING:DEF2:
THRESHOLD 0

:FIPRobe:PASSfail:CLADding:DEF3:ENABLE

Function Sets or queries whether defects that are longer than 5 μm in length in the cladding area are judged.

Syntax :FIPRobe:PASSfail:CLADding:DEF3:
ENABLE {<Boolean>}

Example :FIPROBE:PASSFAIL:CLADDING:DEF3:
ENABLE ON
:FIPROBE:PASSFAIL:CLADDING:DEF3:
ENABLE?
-> :FIPROBE:PASSFAIL:CLADDING:DEF3:
ENABLE 1

:FIPRobe:PASSfail:CLADding:DEF3:THResh old

Function Sets or queries the threshold for judging defects that are longer than 5 μm in length in the cladding area.

Syntax :FIPRobe:PASSfail:CLADding:DEF3:
THReshold {<Nrf>}
<Nrf> = 0 to 100

Example :FIPROBE:PASSFAIL:CLADDING:DEF3:
THRESHOLD 0
:FIPROBE:PASSFAIL:CLADDING:DEF3:
THRESHOLD?
-> :FIPROBE:PASSFAIL:CLADDING:DEF3:
THRESHOLD 0

4.7 FIPRobe Group

:FIPRobe:PASSfail:CLADding:SCR1:ENABle

Function Sets or queries whether scratches that are 3 µm or less in length in the cladding area are judged.

Syntax :FIPRobe:PASSfail:CLADding:SCR1:
ENABle {<Boolean>}

Example :FIPROBE:PASSFAIL:CLADDING:SCR1:
ENABLE ON
:FIPROBE:PASSFAIL:CLADDING:SCR1:
ENABLE?
-> :FIPROBE:PASSFAIL:CLADDING:SCR1:
ENABLE 1

:FIPRobe:PASSfail:CLADding:SCR1:THResh old

Function Sets or queries the threshold for judging scratches that are 3 µm or less in length in the cladding area.

Syntax :FIPRobe:PASSfail:CLADding:SCR1:
THReshold {<NRf>}
<NRf> = 0 to 100

Example :FIPROBE:PASSFAIL:CLADDING:SCR1:
THRESHOLD 0
:FIPROBE:PASSFAIL:CLADDING:SCR1:
THRESHOLD?
-> :FIPROBE:PASSFAIL:CLADDING:SCR1:
THRESHOLD 0

:FIPRobe:PASSfail:CLADding:SCR2:ENABle

Function Sets or queries whether scratches that are longer than 3 µm in length in the cladding area are judged.

Syntax :FIPRobe:PASSfail:CLADding:SCR2:
ENABle {<Boolean>}

Example :FIPROBE:PASSFAIL:CLADDING:SCR2:
ENABLE ON
:FIPROBE:PASSFAIL:CLADDING:SCR2:
ENABLE?
-> :FIPROBE:PASSFAIL:CLADDING:SCR2:
ENABLE 1

:FIPRobe:PASSfail:CLADding:SCR2:THResh old

Function Sets or queries the threshold for judging scratches that are longer than 3 µm in length in the cladding area.

Syntax :FIPRobe:PASSfail:CLADding:SCR2:
THReshold {<NRf>}
<NRf> = 0 to 100

Example :FIPROBE:PASSFAIL:CLADDING:SCR2:
THRESHOLD 0
:FIPROBE:PASSFAIL:CLADDING:SCR2:
THRESHOLD?
-> :FIPROBE:PASSFAIL:CLADDING:SCR2:
THRESHOLD 0

:FIPRobe:PASSfail:CONtact:DEF:ENABle

Function Sets or queries whether defects that are longer than 10 µm in length in the contact area are judged.

Syntax :FIPRobe:PASSfail:CONtact:DEF:
ENABle {<Boolean>}

Example :FIPROBE:PASSFAIL:CONTACT:DEF:
ENABLE ON
:FIPROBE:PASSFAIL:CONTACT:DEF:
ENABLE?
-> :FIPROBE:PASSFAIL:CONTACT:DEF:
ENABLE 1

:FIPRobe:PASSfail:CONtact:DEF:THResh old

Function Sets or queries the threshold for judging defects that are longer than 10 µm in length in the contact area.

Syntax :FIPRobe:PASSfail:CONtact:DEF:
THReshold {<NRf>}
<NRf> = 0 to 100

Example :FIPROBE:PASSFAIL:CONTACT:DEF:
THRESHOLD 0
:FIPROBE:PASSFAIL:CONTACT:DEF:
THRESHOLD?
-> :FIPROBE:PASSFAIL:CONTACT:DEF:
THRESHOLD 0

:FIPRobe:PASSfail:CONtact:SCR:ENABle

Function Sets or queries whether scratches in the contact area are judged.

Syntax :FIPRobe:PASSfail:CONtact:SCR:
ENABle {<Boolean>}

Example :FIPROBE:PASSFAIL:CONTACT:SCR:
ENABLE ON
:FIPROBE:PASSFAIL:CONTACT:SCR:
ENABLE?
-> :FIPROBE:PASSFAIL:CONTACT:SCR:
ENABLE 1

:FIPRobe:PASSfail:CONtact:SCR:THResh old

Function Sets or queries the threshold for judging scratches in the contact area.

Syntax :FIPRobe:PASSfail:CONtact:SCR:
THReshold {<NRf>}
<NRf> = 0 to 100

Example :FIPROBE:PASSFAIL:CONTACT:SCR:
THRESHOLD 0
:FIPROBE:PASSFAIL:CONTACT:SCR:
THRESHOLD?
-> :FIPROBE:PASSFAIL:CONTACT:SCR:
THRESHOLD 0

: FIPRobe: PASSfail: CORE: DEF1: ENABLE

Function Sets or queries whether defects that are 3 μm or less in length in the core area are judged.

Syntax :FIPRobe:PASSfail:CORE:DEF1:
ENABLE {<Boolean>}

Example :FIPROBE:PASSFAIL:CORE:DEF1:ENABLE ON
:FIPROBE:PASSFAIL:CORE:DEF1:ENABLE?
-> :FIPROBE:PASSFAIL:CORE:DEF1:
ENABLE 1

: FIPRobe: PASSfail: CORE: DEF1: THReshold

Function Sets or queries the threshold for judging defects that are 3 μm or less in length in the core area.

Syntax :FIPRobe:PASSfail:CORE:DEF1:
THReshold {<Nrf>}
<Nrf> = 0 to 100

Example :FIPROBE:PASSFAIL:CORE:DEF1:THRESHOLD 0
:FIPROBE:PASSFAIL:CORE:DEF1:THRESHOLD?
-> :FIPROBE:PASSFAIL:CORE:DEF1:
THRESHOLD 0

: FIPRobe: PASSfail: CORE: DEF2: ENABLE

Function Sets or queries whether defects that are longer than 3 μm in length in the core area are judged.

Syntax :FIPRobe:PASSfail:CORE:DEF2:
ENABLE {<Boolean>}

Example :FIPROBE:PASSFAIL:CORE:DEF2:ENABLE ON
:FIPROBE:PASSFAIL:CORE:DEF2:ENABLE?
-> :FIPROBE:PASSFAIL:CORE:DEF2:
ENABLE 1

: FIPRobe: PASSfail: CORE: DEF2: THReshold

Function Sets or queries the threshold for judging defects that are longer than 3 μm in length in the core area.

Syntax :FIPRobe:PASSfail:CORE:DEF2:
THReshold {<Nrf>}
<Nrf> = 0 to 100

Example :FIPROBE:PASSFAIL:CORE:DEF2:THRESHOLD 0
:FIPROBE:PASSFAIL:CORE:DEF2:THRESHOLD?
-> :FIPROBE:PASSFAIL:CORE:DEF2:
THRESHOLD 0

: FIPRobe: PASSfail: CORE: DEFAny: ENABLE

Function Sets or queries whether defects in the core area are judged.

Syntax :FIPRobe:PASSfail:CORE:DEFAny:
ENABLE {<Boolean>}

Example :FIPROBE:PASSFAIL:CORE:DEFANY:
ENABLE ON
:FIPROBE:PASSFAIL:CORE:DEFANY:ENABLE?
-> :FIPROBE:PASSFAIL:CORE:DEFANY:
ENABLE 1

: FIPRobe: PASSfail: CORE: DEFAny: THReshold

Function Sets or queries the threshold for judging defects in the core area.

Syntax :FIPRobe:PASSfail:CORE:DEFAny:
THReshold {<Nrf>}
<Nrf> = 0 to 100

Example :FIPROBE:PASSFAIL:CORE:DEFANY:
THRESHOLD 0
:FIPROBE:PASSFAIL:CORE:DEFANY:
THRESHOLD?
-> :FIPROBE:PASSFAIL:CORE:DEFANY:
THRESHOLD 0

: FIPRobe: PASSfail: CORE: SCR1: ENABLE

Function Sets or queries whether scratches that are 3 μm or less in length in the core area are judged.

Syntax :FIPRobe:PASSfail:CORE:SCR1:
ENABLE {<Boolean>}

Example :FIPROBE:PASSFAIL:CORE:SCR1:ENABLE ON
:FIPROBE:PASSFAIL:CORE:SCR1:ENABLE?
-> :FIPROBE:PASSFAIL:CORE:SCR1:
ENABLE 1

: FIPRobe: PASSfail: CORE: SCR1: THReshold

Function Sets or queries the threshold for judging scratches that are 3 μm or less in length in the core area.

Syntax :FIPRobe:PASSfail:CORE:SCR1:
THReshold {<Nrf>}
<Nrf> = 0 to 100

Example :FIPROBE:PASSFAIL:CORE:SCR1:THRESHOLD 0
:FIPROBE:PASSFAIL:CORE:SCR1:THRESHOLD?
-> :FIPROBE:PASSFAIL:CORE:SCR1:
THRESHOLD 0

4.7 FIPRobe Group

:FIPRobe:PASSfail:CORE:SCR2:ENABLE

Function Sets or queries whether scratches that are longer than 3 μm in length in the core area are judged.

Syntax :FIPRobe:PASSfail:CORE:SCR2:
ENABLE {<Boolean>}

Example :FIPROBE:PASSFAIL:CORE:SCR2:ENABLE ON
:FIPROBE:PASSFAIL:CORE:SCR2:ENABLE?
-> :FIPROBE:PASSFAIL:CORE:SCR2:
ENABLE 1

:FIPRobe:PASSfail:CORE:SCR2:THReshold

Function Sets or queries the threshold for judging scratches that are longer than 3 μm in length in the core area.

Syntax :FIPRobe:PASSfail:CORE:SCR2:
THReshold {<Nrf>}
<Nrf> = 0 to 100

Example :FIPROBE:PASSFAIL:CORE:SCR2:THRESHOLD 0
:FIPROBE:PASSFAIL:CORE:SCR2:THRESHOLD?
-> :FIPROBE:PASSFAIL:CORE:SCR2:
THRESHOLD 0

:FIPRobe:PASSfail:CORE:SCRAny:ENABLE

Function Sets or queries whether scratches in the core area are judged.

Syntax :FIPRobe:PASSfail:CORE:SCRAny:
ENABLE {<Boolean>}

Example :FIPROBE:PASSFAIL:CORE:SCRANY:ENABLE ON
:FIPROBE:PASSFAIL:CORE:SCRANY:ENABLE?
-> :FIPROBE:PASSFAIL:CORE:SCRANY:
ENABLE 1

:FIPRobe:PASSfail:CORE:SCRAny:THReshold

Function Sets or queries the threshold for judging scratches in the core area.

Syntax :FIPRobe:PASSfail:CORE:SCRAny:
THReshold {<Nrf>}
<Nrf> = 0 to 100

Example :FIPROBE:PASSFAIL:CORE:SCRANY:
THRESHOLD 0
:FIPROBE:PASSFAIL:CORE:SCRANY:
THRESHOLD?
-> :FIPROBE:PASSFAIL:CORE:SCRANY:
THRESHOLD 0

:FIPRobe:PASSfail:EXECute

Function Executes pass/fail judgment.

Syntax :FIPRobe:PASSfail:EXECute

Example :FIPROBE:PASSFAIL:EXECUTE

:FIPRobe:PASSfail:FIBertype

Function Sets or queries the type of optical fiber cable.

Syntax :FIPRobe:PASSfail:FIBertype {SM|MM}
SM: Single mode
MM: Multi mode

Example :FIPROBE:PASSFAIL:FIBERTYPE SM
:FIPROBE:PASSFAIL:FIBERTYPE?
-> :FIPROBE:PASSFAIL:FIBERTYPE SM

:FIPRobe:PASSfail:GET:IMAGe?

Function Gets the image of the pass/fail judgment results.

Syntax :FIPRobe:PASSfail:GET:IMAGe?

Example :FIPROBE:PASSFAIL:GET:IMAGe?
-> :FIPROBE:PASSFAIL:GET:IMAGe

:FIPRobe:PASSfail:GET:SUMMery?

Function Gets the pass/fail judgment results.

Syntax :FIPRobe:PASSfail:GET:SUMMery?

Example :FIPROBE:PASSFAIL:GET:SUMMARY?
-> :FIPROBE:PASSFAIL:GET:SUMMARY

:FIPRobe:PASSfail:STANDard

Function Sets or queries the standard that is used for pass/fail judgment.

Syntax :FIPRobe:PASSfail:STANDard {SPC|UPC|
APC|USER}

SPC: Spherical surface polishing

UPC: Spherical surface polishing

APC: Angled spherical surface polishing

USER: Manual execution of judgment and threshold assignment

Example :FIPROBE:PASSFAIL:STANDARD SPC
:FIPROBE:PASSFAIL:STANDARD?
-> :FIPROBE:PASSFAIL:STANDARD SPC

:FIPRobe:STATe

Function Sets or queries the image state of the fiber inspection probe.

Syntax :FIPRobe:STATe {VIDEO|STILL}

Example :FIPROBE:STATE VIDEO
:FIPROBE:STATE?
-> :FIPROBE:STATE VIDEO

4.8 LABEL Group

The commands in this group deal with the settings of the labels used in file identification. You can perform the same operations and make the same settings and queries that you can by using the front panel.

: LABEL : CABLE : CODE

Function Sets or queries the cable code.
Syntax : LABEL : CABLE : CODE <Character string>
: LABEL : CABLE : CODE?
<Character string> = Up to 36 characters
Example : LABEL : CABLE : CODE "123"
: LABEL : CABLE : CODE
-> : LABEL : CABLE : CODE "123"

: LABEL : CABLE : ID

Function Sets or queries the cable ID.
Syntax : LABEL : CABLE : ID <Character string>
: LABEL : CABLE : ID?
<Character string> = Up to 36 characters
Example : LABEL : CABLE : ID "123"
: LABEL : CABLE : ID?
-> : LABEL : CABLE : ID "123"

: LABEL : COMPANY

Function Sets or queries the company name.
Syntax : LABEL : COMPANY <Character string>
: LABEL : COMPANY?
<Character string> = Up to 36 characters
Example : LABEL : COMPANY "123"
: LABEL : COMPANY?
-> : LABEL : COMPANY "123"

: LABEL : DFLAG : CURRENT

Function Sets or queries the current data flag.
Syntax : LABEL : DFLAG : CURRENT {BC|RC|OT|CC}
: LABEL : DFLAG : CURRENT?
BC: as-Built Condition
RC: as-Repaired Condition
OT: Other
CC: Current Condition
Example : LABEL : DFLAG : CURRENT BC
: LABEL : DFLAG : CURRENT?
-> : LABEL : DFLAG : CURRENT BC

: LABEL : FIBER : ID

Function Sets or queries the fiber ID.
Syntax : LABEL : FIBER : ID <Character string>
: LABEL : FIBER : ID?
<Character string> = Up to 36 characters
Example : LABEL : FIBER : ID "123"
: LABEL : FIBER : ID?
-> : LABEL : FIBER : ID "123"

: LABEL : FIBER : TYPE

Function Sets or queries the fiber type.
Syntax : LABEL : FIBER : TYPE {SMF|DSF|NZ_DS F|MMF}
: LABEL : FIBER : TYPE?
SMF: Single-mode optical fiber
DSF: Dispersion-shifted single-mode fiber
NZ_DS F: Non-zero dispersion-shifted single-mode fiber
MMF: Multi-mode optical fiber
Example : LABEL : FIBER : TYPE SMF
: LABEL : FIBER : TYPE?
-> : LABEL : FIBER : TYPE SMF

: LABEL : LOCATION : ORIGINATING

Function Sets or queries the start position label.
Syntax : LABEL : LOCATION : ORIGINATING <Character string>
: LABEL : LOCATION : ORIGINATING?
<Character string> = Up to 36 characters
Example : LABEL : LOCATION : ORIGINATING "123"
: LABEL : LOCATION : ORIGINATING?
-> : LABEL : LOCATION : ORIGINATING "123"

: LABEL : LOCATION : TERMINATING

Function Sets or queries the end position label.
Syntax : LABEL : LOCATION : TERMINATING <Character string>
: LABEL : LOCATION : TERMINATING?
<Character string> = Up to 36 characters
Example : LABEL : LOCATION : TERMINATING "123"
: LABEL : LOCATION : TERMINATING?
-> : LABEL : LOCATION : TERMINATING "123"

: LABEL : OPERATOR

Function Sets or queries the operator name.
Syntax : LABEL : OPERATOR <Character string>
: LABEL : OPERATOR?
<Character string> = Up to 36 characters
Example : LABEL : OPERATOR "123"
: LABEL : OPERATOR?
-> : LABEL : OPERATOR "123"

4.9 LIGHTsource Group

The commands in this group deal with the light source. You can perform the same operations and make the same settings and queries that you can by using the front panel. This function is valid when the /SLS option of the OTDR unit is installed.

:LIGHTsource:ABORt

Function Turns the measurement light off.

Syntax :LIGHTsource:ABORt

Example :LIGHTSOURCE:ABORT

:LIGHTsource:EXECute

Function Turns the measurement light on.

Syntax :LIGHTsource:EXECute

Example :LIGHTSOURCE:EXECUTE

:LIGHTsource:MODulation

Function Sets or queries the light source modulation frequency.

Syntax :LIGHTsource:MODulation {MOD_CW|
MOD_270HZ|MOD_1KHZ|MODE_2KHZ}
:LIGHTsource:MODulation?

Example :LIGHTSOURCE:MODULATION MOD_CW
:LIGHTSOURCE:MODULATION?
-> :LIGHTSOURCE:MODULATION MOD_CW

Description When :LIGHTsource:WAVelength is set to 0.850 um or 1.300 um, the modulation frequency can only be set to CW or 270 Hz.

:LIGHTsource:STATe

Function Turns the measurement light off or on.

Syntax :LIGHTsource:STATe <Boolean>

Example :LIGHT:SOURCE ON
:LIGHT:SOURCE? -> LIGHT:SOURCE ON

Description OFF: The same as LIGHTsource:ABORt.
ON: The same as LIGHTsource:EXECute.

:LIGHTsource:WAVelength

Function Sets or queries the light source wavelength.

Syntax :LIGHTsource:WAVelength <NRf>
:LIGHTsource:WAVelength?
<NRf> = 0.850um to 1.650um
(850E-9 to 1650E-9)

Example :LIGHTSOURCE:WAVELENGTH 0.85UM
:LIGHTSOURCE:WAVELENGTH 1650E-9
:LIGHTSOURCE:WAVELENGTH 1.650E-6
:LIGHTSOURCE:WAVELENGTH?
-> :LIGHTSOURCE:WAVELENGTH 1550E-9

Description The wavelengths that can be specified vary depending on the model.

4.10 MENU Group

The commands in this group are used to set the function or marker mode or query the settings.

:MENU:ERRor:CLEar

Function Clears the error dialog box.

Syntax :MENU:ERRor:CLEar

Example :MENU:ERROR:CLEAR

:MENU:FUNction

Function Sets or queries the function mode.

Syntax :MENU:FUNction {TOP|OTDR|LIGHT|OPC|
PMETER|VLS|FIP}
:MENU:FUNction?

TOP: Top menu

OTDR: OTDR

LIGHT: Light source

OPC¹: Power checker

PMETER²: Power meter

VLS³: Visible light source

FIP: Fiber inspection probe

1 This is available when the power checker option (/PC option) is installed.

2 This is available when the optical power meter module (OPM module) is installed.

3 This is available when the visible light source module (VLS module) is installed.

Example :MENU:FUNCTION TOP
:MENU:FUNCTION? -> :MENU:FUNCTION TOP

:MENU:MARKer

Function Sets or queries the marker mode.

Syntax :MENU:MARKer {MARKER|LINE}
:MENU:MARKer?

MARKER: Marker

LINE: Line

Example :MENU:MARKER MARKER
:MENU:MARKER? -> :MENU:MARKER MARKER

4.11 MISC Group

The commands in this group deal with the date, language, and power management. You can make the same settings and queries that you can by using the front panel.

:MISC:ALARmsound

Function Sets or queries the alarm sound.
Syntax :MISC:ALARmsound <Boolean>
:MISC:ALARmsound?
Example :MISC:ALARMSOUND OFF
:MISC:ALARMSOUND?
-> :MISC:ALARMSOUND 1

:MISC:BACKlightoff

Function Sets or queries the backlight off setting when the AQ7280 is running on battery power.
Syntax :MISC:BACKlightoff <Boolean>
Example :MISC:BACKLIGHTOFF ON
:MISC:BACKLIGHTOFF?
-> :MISC:BACKLIGHTOFF 1
Description The screen saver feature is not enabled during OTDR measurement.

:MISC:BRIGhtness:AC

Function Sets or queries the LCD brightness when the AC adapter is connected.
Syntax :MISC:BRIGhtness:AC {BRIGHT|NORMAL|DARK}
:MISC:BRIGhtness:AC?
BRIGHT: Bright
NORMAL: Normal
DARK: Power save
Example :MISC:BRIGhtness:AC NORMAL
:MISC:BRIGhtness:AC?
-> :MISC:BRIGhtness:AC NORMAL

:MISC:BRIGhtness:BATTery

Function Sets or queries the LCD brightness when the AQ7280 is running on battery power.
Syntax :MISC:BRIGhtness:BATTery {BRIGHT|NORMAL|DARK}
:MISC:BRIGhtness:BATTery?
Example :MISC:BRIGhtness:BATTERY NORMAL
:MISC:BRIGhtness:BATTERY?
-> :MISC:BRIGhtness:BATTERY NORMAL
Description The parameters are the same as those for :MISC:BRIGhtness:AC.

:MISC:BACKlightoff

Function Sets or queries the backlight off setting when the AQ7280 is running on battery power.
Syntax :MISC:BACKlightoff <Boolean>
Example :MISC:BACKLIGHTOFF ON
:MISC:BACKLIGHTOFF?
-> :MISC:BACKLIGHTOFF 1

:MISC:DATE:DAY

Function Sets or queries the day.
Syntax :MISC:DATE:DAY <Nrf>
:MISC:DATE:DAY?
<Nrf> = 1 to 31 (in steps of 1)
Example :MISC:DATE:DAY 1
:MISC:DATE:DAY? -> :MISC:DATE:DAY 1
Description This setting takes effect when :MISC:DATE:SET is executed.

:MISC:DATE:GET?

Function Queries the date and time.
Syntax :MISC:DATE:GET?
Example :MISC:DATE:GET?
-> :MISC:DATE:GET 2009/01/31 23:59:59

:MISC:DATE:HOuR

Function Sets or queries the hour.
Syntax :MISC:DATE:HOuR <Nrf>
:MISC:DATE:HOuR?
<Nrf> = 0 to 23 (in steps of 1)
Example :MISC:DATE:HOuR 17
:MISC:DATE:HOuR?
-> :MISC:DATE:HOuR 12
Description This setting takes effect when :MISC:DATE:SET is executed.

:MISC:DATE:MINute

Function Sets or queries the minute.
Syntax :MISC:DATE:MINute <Nrf>
:MISC:DATE:MINute?
<Nrf> = 0 to 59 (in steps of 1)
Example :MISC:DATE:MINUTE 5
:MISC:DATE:MINUTE?
-> :MISC:DATE:MINUTE 59
Description This setting takes effect when :MISC:DATE:SET is executed.

:MISC:DATE:MODE

Function Sets or queries the date display type.
Syntax :MISC:DATE:MODE {TYPE1|TYPE2|TYPE3}
:MISC:DATE:MODE?
TYPE1: 2009/08/29 12:16
TYPE2: 08/29/2009 12:16
TYPE3: 2009/AUG/29 12:16
Example :MISC:DATE:MODE TYPE1
:MISC:DATE:MODE?
-> :MISC:DATE:MODE TYPE2

:MISC:DATE:MONTH

Function Sets or queries the month.
 Syntax :MISC:DATE:MONTH <NRf>
 <NRf> = 1 to 12
 :MISC:DATE:MONTH?
 Example :MISC:DATE:MONTH 8
 :MISC:DATE:MONTH? -> MISC:DATE:MONTH 8
 Description This setting takes effect when :MISC:DATE:SET is executed.

:MISC:DATE:SECOnd

Function Sets or queries the second.
 Syntax :MISC:DATE:SECOnd <NRf>
 <NRf> = 0 to 59 (in steps of 1)
 Example :MISC:DATE:SECOnd 0
 :MISC:DATE:SECOnd?
 -> :MISC:DATE:SECOnd 0
 Description This setting takes effect when :MISC:DATE:SET is executed.

:MISC:DATE:SET

Function Applies the date and time change.
 Syntax :MISC:DATE:SET
 Example :MISC:DATE:SET

:MISC:DATE:YEAR

Function Sets or queries the year.
 Syntax :MISC:DATE:YEAR <NRf>
 :MISC:DATE:YEAR?
 <NRf> = 2009 to 2035 (in steps of 1)
 Example :MISC:DATE:YEAR 2009
 :MISC:DATE:YEAR?
 -> :MISC:DATE:YEAR 2009
 Description This setting takes effect when :MISC:DATE:SET is executed.

:MISC:LANGUage

Function Sets or queries the language.
 Syntax :MISC:LANGUage {JAPANESE|ENGLISH}
 :MISC:LANGUage?
 Example :MISC:LANGUage ENGLISH
 :MISC:LANGUage?
 -> :MISC:LANGUage ENGLISH
 Description You can set the following language.
 When language code is -HE
 ENGLISH, FRENCH, GERMANY, ITALY,
 SPANISH, DUTCH, FINNISH, NORWEGIAN,
 POLISH, CZECH, SWEDISH, TURKEY,
 PORTUGUESE, TRADITIONAL CHINESE,
 BRAZILIAN (Portuguese (Brazil)), ROMANIAN
 When language code is -HJ
 JAPANESE, ENGLISH
 When language code is -HC
 CHINESE (simplified Chinese), ENGLISH
 When language code is -HM
 CHINESE (simplified Chinese)
 When language code is -HK
 KOREAN, ENGLISH
 When language code is -HR
 RUSSIAN, ENGLISH

:MISC:POWersave:BATTEry

Function Sets or queries the power-save setting when the AQ7280 is running on battery power.
 Syntax :MISC:POWersave:BATTEry {OFF|A1MIN|A5MIN|A10MIN|A30MIN}
 :MISC:POWersave:BATTEry?
 OFF: Disable
 A1MIN: Auto power off after 1 minute
 A5MIN: Auto power off after 5 minutes
 A10MIN: Auto power off after 10 minutes
 A30MIN: Auto power off after 30 minutes
 Example :MISC:POWERSAVE:BATTERY A1MIN
 :MISC:POWERSAVE:BATTERY?
 -> :MISC:POWERSAVE:BATTERY OFF
 Description Auto power off cannot be performed during OTDR measurement.

:MISC:RLOSsmode

Function Sets or queries the reflection display.
 Syntax :MISC:RLOSsmode {NORMAL|NTT}
 :MISC:MARKer?
 NORMAL: Optical return loss
 NTT: Reflection
 Example :MISC:RLOSSMODE NORMAL
 :MISC:RLOSSMODE ?
 -> :MISC:RLOSSMODE NORMAL

4.11 MISC Group

:MISC:TOUChope

Function Sets or queries whether touch panel operations are enabled or disabled.

Syntax :MISC:TOUChope <Boolean>
:MISC:TOUChope?

Example :MISC:TOUCHOPE OFF
:MISC:TOUCHOPE? -> :MISC:TOUCHOPE 1

4.12 NETWORK Group

The commands in this group can only be used on models with the /LAN option.

:NETWork:CONTRol:PASSword

Function Sets or queries the password.

Syntax :NETWork:CONTRol:PASSword <character string>

Example :NETWORK:CONTROL:PASSWORD "ABC"

:NETWORK:CONTROL:PASSWORD?

-> :NETWORK:CONTROL:PASSWORD "ABC"

- Description
- You cannot use this command if NETWORK:STATE is set to OFF.
 - The setting specified by this command takes effect when the AQ7280 is reconnected.
 - You do not have to set the password when the user name is "anonymous."

:NETWork:CONTRol:TIMEout

Function Sets or queries the timeout value.

Syntax :NETWork:CONTRol:TIMEout {<NRF>|INFinite}

:NETWork:CONTRol:TIMEout?

<NRF> = 1 to 7200

Example :NETWORK:CONTROL:TIMEOUT 30

:NETWORK:CONTROL:TIMEOUT?

-> :NETWORK:CONTROL:TIMEOUT 30

- Description
- The unit is seconds.
 - You cannot use this command if NETWORK:STATE is set to OFF.
 - The setting specified by this command takes effect when the AQ7280 is reconnected..

:NETWork:CONTRol:USERname

Function Sets or queries the user name.

Syntax :NETWork:CONTRol:USERname <character string>

Example :NETWORK:CONTROL:USERNAME "anonymous"

:NETWORK:CONTROL:USERNAME?

-> :NETWORK:CONTROL:

USERNAME "anonymus"

- Description
- You cannot use this command if NETWORK:STATE is set to OFF.
 - The setting specified by this command takes effect when the AQ7280 is reconnected.

:NETWork:DHCP

Function Sets or queries the DHCP on/off state.

Syntax :NETWork:DHCP <Boolean>

:NETWork:DHCP?

OFF or 0: Invalid

ON or 1: Valid

Example :NETWORK:DHCP ON

:NETWORK:DHCP? -> :NETWORK:DHCP 1

- Description
- You cannot use this command if NETWORK:STATE is set to OFF.
 - The setting specified by this command takes effect when the AQ7280 is reconnected.

:NETWork:GATeway

Function Sets or queries the gateway.

Syntax :NETWork:GATeway <character string>

:NETWork:GATeway?

Example :NETWORK:GATEWAY "255.255.255.0"

:NETWORK:GATEWAY?

-> :NETWORK:GATEWAY "255.255.255.0"

- Description
- You cannot use this command if NETWORK:STATE is set to OFF.
 - You cannot use this command if NETWORK:DHCP is set to OFF.
 - The setting specified by this command takes effect when the AQ7280 is reconnected.

:NETWork:IPAdDress

Function Sets or queries the IP address.

Syntax :NETWork:IPAdDress <character string>

:NETWork:IPAdDress?

Example :NETWORK:IPADDRESS "192.168.0.1"

:NETWORK:IPADDRESS?

-> :NETWORK:IPADDRESS "192.168.0.1"

- Description
- You cannot use this command if NETWORK:STATE is set to OFF.
 - You cannot use this command if NETWORK:DHCP is set to OFF.
 - The setting specified by this command takes effect when the AQ7280 is reconnected.

:NETWork:NETMask

Function Sets or queries the subnet mask.

Syntax :NETWork:NETMask <character string>

:NETWork:NETMask?

Example :NETWORK:NETMASK "255.255.255.0"

:NETWORK:NETMASK?

-> :NETWORK:NETMASK "255.255.255.0"

- Description
- You cannot use this command if NETWORK:STATE is set to OFF.
 - You cannot use this command if NETWORK:DHCP is set to OFF.
 - The setting specified by this command takes effect when the AQ7280 is reconnected.

4.12 NETWORK Group

:NETWork:STATe

Function Sets or queries the Ethernet on/off state.

Syntax :NETWork:STATe <Boolean>
:NETWork:STATe?
OFF or 0: Invalid
ON or 1: Valid

Example :NETWORK:STATE ON
:NETWORK:STATE? -> :NETWORK:STATE 1

Description The setting specified by this command takes effect when the AQ7280 is reconnected.

:NETWork:UPNP:ENABle

Function Sets or queries whether the UPnP port forwarding function is enabled.

Syntax :NETWork:UPNP:ENABle <Boolean>
:NETWork:UPNP:ENABle?
OFF or 0: Disabled
ON or 1: Enabled

Example :NETWORK:UPNP:ENABLE ON
:NETWORK:UPNP:ENABLE?
-> :NETWORK:UPNP:ENABLE 1

Description When the setting is enabled with this command, first UPnP port forwarding is configured, and then configuration is repeated every minute thereafter.

:NETWork:UPNP:STATus?

Function Queries the UPnP port forwarding configuration status.

Syntax :NETWork:UPNP:STATus?
INValid: UPnP port forwarding function is disabled.
NORMAl: Normal completion
CONFiguring: Being configured
NOTFound: UPnP compatible NAT router not found
ERRor: Configuration error

Example :NETWORK:UPNP:STATUS?
-> :NETWORK:UPNP:STATUS NORMAL

:NETWork:UPNP:URL?

Function Queries the URL of the UPnP compatible NAT router.

Syntax :NETWork:UPNP:URL?

Example :NETWORK:UPNP:URL?
-> :NETWORK:UPNP:
URL "HTTP://203.0.113.1:8080/"

Description If the UPnP port forwarding function is disabled or UPnP port forwarding cannot be configured correctly, an empty string ("") is returned.

4.13 PMETER Group

The commands in this group deal with the power meter. You can make the same settings and queries that you can by using the front panel. This function is valid when the optical power module (OPM module) is installed.

: PMETER: AVERAGE: TIMES

Function Sets or queries the power meter average count.
Syntax :PMEter:AVErAge:TIMes <T1|T10|T50|T100>
:PMEter:AVErAge:TIMes?
T1: 1
T10: 10
T50: 50
T100: 100

Example :PMEter:AVErAge:TIMes T1
:PMEter:AVErAge:TIMes?
-> :PMEter:AVErAge:TIMes T1

: PMETER: DREF

Function Executes Dref on the power meter.
Syntax :PMEter:DREF
Example :PMEter:DREF

: PMETER: LINK: STATE

Function Sets or queries the light source power meter setting interlock.
Syntax :PMEter:LINK:STATe <Boolean>
Example :PMEter:LINK:STATe ON
:PMEter:LINK:STATe?
-> :PMEter:LINK:STATe 1

: PMETER: MAXMin: MAX?

Function Sets or queries the maximum value.
Syntax :PMEter:MAXMin:MAX?
Example :PMEter:MAXMin:MAX?
-> :PMEter:MAXMin:MAX? 5.00

Description You can only make this query when :PMEter:MAXMin:STATe is set to ON.

: PMETER: MAXMin: MIN?

Function Sets or queries the minimum value.
Syntax :PMEter:MAXMin:MIN?
Example :PMEter:MAXMin:MIN?
-> :PMEter:MAXMin:MIN? -5.00

Description You can only make this query when :PMEter:MAXMin:STATe is set to ON.

: PMETER: MAXMin: STATE

Function Sets or queries the MAX and MIN display on/off state.
Syntax :PMEter:MAXMin:STATe <Boolean>
Example :PMEter:MAXMin:STATe ON
:PMEter:MAXMin:STATe?
-> :PMEter:MAXMin:STATe 1

: PMETER: MEASUREMENT: DATA?

Function Queries the power meter's measured results.
Syntax :PMEter:MEASurement:DATA?
Example :PMEter:MEASurement:DATA?
-> :PMEter:MEASurement:DATA 26.56

: PMETER: MODulation

Function Sets or queries the power meter modulation.
Syntax :PMEter:MODulation {MOD_270HZ|MOD_CW|MOD_1KHZ|MOD_2KHZ}
Example :PMEter:MODulation MOD_270HZ
:PMEter:MODulation?
-> :PMEter:MODulation MOD_270HZ

: PMETER: OFFSet

Function Sets or queries the power meter offset.
Syntax :PMEter:OFFSet <NRf>
:PMEter:OFFSet?
<NRf> = -9.900 to 9.900 (in steps of 0.001)
Example :PMEter:OFFSet -5.000
:PMEter:OFFSet?
-> :PMEter:OFFSet -3.000

: PMETER: REference

Function Sets or queries the power meter reference value.
Syntax :PMEter:REference <NRf>
:PMEter:REference?
<NRf> = -70.00 to 5.00 (in steps of 0.001) [dBm]
Example :PMEter:REFERENCE 0.00
:PMEter:REFERENCE?
-> :PMEter:REFERENCE 0.00

: PMETER: THReshold: LOWER

Function Sets or queries the power meter lower threshold value.
Syntax :PMEter:THReshold:LOWer <NRf>
<NRf> = -70.00 to 5.00 (in steps of 0.001) [dBm]
Example :PMEter:THRESHOLD:LOWER -70.00
:PMEter:THRESHOLD:LOWER?
-> :PMEter:THRESHOLD:LOWER -70.00

: PMETER: THReshold: UPPER

Function Sets or queries the power meter upper threshold value.
Syntax :PMEter:THReshold:UPPer <NRf>
<NRf> = -70.00 to 5.00 (in steps of 0.001) [dBm]
Example :PMEter:THRESHOLD:UPPER -70
:PMEter:THRESHOLD:UPPER?
-> :PMEter:THRESHOLD:UPPER -70

4.13 PMETER Group

:PMETER:UNIT

Function Sets or queries the power meter display unit.

Syntax :PMETER:UNIT {DB|DBM|W}

:PMETER:UNIT ?

Example :PMETER:UNIT DBM

:PMETER:UNIT ? -> :PMETER:UNIT DB

:PMETER:WAVELENGTH:DETAIL

Function Sets or queries the wavelength when the wavelength mode is set to Detail.

Syntax :PMETER:WAVELENGTH:DETAIL <NRf>

:PMETER:WAVELENGTH:DETAIL?

<NRf> = 0.850um to 1.650um (850E-09 to 1650E-09)

Example :PMETER:WAVELENGTH:DETAIL 0.85UM

:PMETER:WAVELENGTH:DETAIL 1650E-09

:PMETER:WAVELENGTH:DETAIL 1.650E-06

:PMETER:WAVELENGTH:DETAIL?

-> PMETER:WAVELENGTH:DETAIL 1550E-09

Description If the wavelength mode is set to Simple or CWDM, executing this command sets the mode to Detail.

:PMETER:ZEROSet

Function Executes zero set on the power meter.

Syntax :PMETER:ZEROSet

Example :PMETER:ZEROSet

4.14 PMONitor Group

The commands in this group deal with the power monitor. You can make the same settings and inquiries as when the front panel is used.

:PMONitor:DREF

Function Executes Dref (display reference) on the power monitor.

Syntax :PMONitor:DREF

Example :PMONITOR:DREF

:PMONitor:MAX?

Function Queries the maximum scale value of the power monitor.

Syntax :PMONitor:MAX?

Example :PMONITOR:MAX? -> :PMON:MAX -5.0

:PMONitor:MEASurement:DATA?

Function Queries the measured results of the power monitor.

Syntax :PMONitor:MEASurement:DATA?

Example :PMONITOR:MEASUREMENT:DATA?

-> :PMON:MEAS:DATA 26.5

:PMONitor:MIN?

Function Queries the minimum scale value of the power monitor.

Syntax :PMONitor:MIN?

Example :PMONITOR:MIN? -> :PMON:MIN -50.0

:PMONitor:OFFSet

Function Sets or queries the power monitor offset.

Syntax :PMONitor:OFFSet <NRf>

:PMONitor:OFFSet?

<NRf> = -9.9 to 9.9

Example :PMONITOR:OFFSET -5.0

:PMONITOR:OFFSET? -> :PMON:OFFS -3.0

:PMONitor:REFeRence

Function Sets or queries the power monitor reference.

Syntax :PMONitor:REFeRence <NRf>

:PMONitor:REFeRence?

<NRf> = -50 to -5

Example :PMONITOR:REFERENCE -45.00

:PMONITOR:REFERENCE? -> :PMON:REF -44.1

:PMONitor:THReshold:LOWer

Function Sets or queries the power monitor lower threshold limit.

Syntax :PMONitor:THReshold:Lower <NRf>

:PMONitor:THReshold:Lower?

<NRf> = -50.0 to -5.0

Example :PMONITOR:THRESHOLD:LOWER -10

:PMONITOR:THRESHOLD:LOER?

-> :PMET:THR:LOWER -10.0

:PMONitor:THReshold:UPper

Function Sets or queries the power monitor upper threshold limit.

Syntax :PMONitor:THReshold:Upper <NRf>

:PMONitor:THResholdUpper?

<NRf> = -50.0 to -5.0

Example :PMONITOR:THRESHOLD:UPPER -10

:PMONITOR:THRESHOLD:UPPER?

-> :PMET:THR:UPPER -10.0

:PMONitor:UNIT

Function Sets or queries the power unit display unit.

Syntax :PMONitor:UNIT {DB|DBM|W}

:PMONitor:UNIT ?

Example :PMONITOR:UNIT DBM

:PMONITOR:UNIT ? -> :PMON:UNIT DB

:PMONitor:WAVelength

Function Sets or queries the power monitor wavelength.

Syntax :PMONitor:WAVelength <NRf>

:PMONitor:WAVelength?

<NRf> = 0.850um to 1.650um

(850E-09 to 1650E-09)

Example :PMONITOR:WAVELENGTH 0.85UM

:PMONITOR:WAVELENGTH 1650E-09

:PMONITOR:WAVELENGTH 1.650E-06

:PMONITOR:WAVELENGTH?

-> PMON:WAV 1550E-09

:PMONitor:ZERoset

Function Executes zero-set on the power monitor.

Syntax :PMONitor:ZERoset

Example :PMONITOR:ZEROSSET

4.15 PRINT Group

The commands in this group deal with printing. You can make the same settings and queries that you can by using the front panel.

:PRINT:COLor

Function Sets or queries the print colors.

Syntax :PRINT:COLor {COLOR|BW}
:PRINT:COLor?

COLOR: Screen colors

BW: Black and white

Example :PRINT:COLOR COLOR
:PRINT:COLOR? -> :PRINT:COLOR BW

:PRINT:EXECute

Function Executes printing.

Syntax :PRINT:EXECute

Example :PRINT:EXECUTE

:PRINT:MAKer

Function Sets or queries the printer manufacturer.

Syntax :PRINT:MAKer {HP|EPSON|SEIKO}
:PRINT:MAKer?

HP: HP inkjet printer

EPSON: EPSON inkjet printer

SEIKO: Seiko Instruments MPU-L465

Example :PRINT:MAKER HP
:PRINT:MAKER? -> :PRINT:MAKER EPSON

4.16 REPOrt Group

The commands in this group deal with report. You can make the same settings and queries that you can by using the front panel.

:REPOrt:EXECute

Function Creates a report.
Syntax :REPOrt:EXECute
Example :REPORT:EXECUTE
Description The created reports are saved in the location specified by
:FILE:DRIVE:SE
:FILE:FOLDer:PATH

:REPOrt:SET:EVENT:CONDition

Function Sets or queries the event detection conditions in report settings.
Syntax :REPOrt:SET:EVENT:CONDition <Boolean>
Example :REPORT:SET:EVENT:CONDITION ON
:REPORT:SET:EVENT:CONDITION?
-> :REPORT:SET:EVENT:CONDITION ON

:REPOrt:SET:EVENT:LIST

Function Sets or queries the event list in report settings.
Syntax :REPOrt:SET:EVENT:LIST <Boolean>
Example :REPORT:SET:EVENT:LIST ON
:REPORT:SET:EVENT:LIST?
-> :REPORT:SET:EVENT:LIST ON

:REPOrt:SET:FIBer

Function Sets or queries the fiber end face image in report settings.
Syntax :REPOrt:SET:FIBer |OFF|MANUAL|AUTO|
Example :REPORT:SET:FIBER AUTO
:REPORT:SET:FIBER?
-> :REPORT:SET:FIBER AUTO

:REPOrt:SET:JUDGE

Function Sets or queries the pass/fail judgment conditions in report settings.
Syntax :REPOrt:SET:JUDGE <Boolean>
Example :REPORT:SET:JUDGE ON
:REPORT:SET:JUDGE?
-> :REPORT:SET:JUDGE ON

:REPOrt:SET:MEASure:CONDition

Function Sets or queries the measurement conditions in report settings.
Syntax :REPOrt:SET:MEASure:CONDition <Boolean>
Example :REPORT:SET:MESURE:CONDITION ON
:REPORT:SET:MESURE:CONDITION?
-> :REPORT:SET:MESURE:CONDITION ON

:REPOrt:SET:MEASure:INFO

Function Sets or queries the measurement information in report settings.
Syntax :REPOrt:SET:MEASure:INFO <Boolean>
Example :REPORT:SET:MESURE:INFO ON
:REPORT:SET:MESURE:INFOF?
-> :REPORT:SET:MESURE:INFO ON

:REPOrt:SET:MEASure:RESUlt

Function Sets or queries the measurement results in report settings.
Syntax :REPOrt:SET:MEASure:INFO <Boolean>
Example :REPORT:SET:MESURE:INFO ON
:REPORT:SET:MESURE:INFOF?
-> :REPORT:SET:MESURE:INFO ON

:REPOrt:SET:OVERview

Function Sets or queries the overview in report settings.
Syntax :REPOrt:SET:OVERview <Boolean>
Example :REPORT:SET:OVERview ON
:REPORT:SET:OVERview?
-> :REPORT:SET:OVERview ON

:REPOrt:SET:WAVE

Function Sets or queries the waveform in report settings.
Syntax :REPOrt:SET:WAVE <Boolean>
Example :REPORT:SET:WAVE ON
:REPORT:SET:WAVE?
-> :REPORT:SET:WAVE ON

4.17 SETup Group

The commands in this group deal with the initialization of the settings. The AQ7280 settings can be returned to their factory defaults.

:SETup:ALLinit

Function Returns all the settings to their factory default values and formats the internal memory.

Syntax :SETup:ALLinit

Example :SETUP:ALLINIT

:SETup:INITialize

Function Returns all settings to their factory defaults.

Syntax :SETup:INITialize

Example :SETUP:INITIALIZE

4.18 STATUS Group

The commands in this group are used to make settings and queries related to the communication status feature. There are no front panel keys that correspond to the commands in this group.

:STATUS?

Function Queries all the settings for the communication status feature.

Syntax :STATUS?

Example :STATUS? -> :STATUS:QENABLE1;QMESSAGE 1

:STATUS:CONDition?

Function Queries the contents of the condition register.

Syntax :STATUS:CONDition?

Example :STATUS:CONDITION? -> 16

Description For information about the condition register, see section 5.1, "Condition Register."

:STATUS:ERRor?

Function Queries the error code and message information (top of the error queue).

Syntax :STATUS:ERRor?

Example :STATUS:ERROR?
-> 113, "Undefined header"

:STATUS:QENable

Function Sets or queries whether or not messages other than errors will be stored to the error queue (on/off).

Syntax :STATUS:QENable {<Boolean>}

:STATUS:QENable?

Example :STATUS:QENABLE ON
:STATUS:QENABLE? -> :STATUS:QENABLE 1

:STATUS:QMESsage

Function Sets or queries whether or not message information will be attached to the response to the STATUS:ERRor? query (on/off).

Syntax :STATUS:QMESsage {<Boolean>}

:STATUS:QMESsage?

Example :STATUS:QMESSAGE OFF
:STATUS:QMESSAGE? -> :STATUS:QMESSAGE 1

4.19 SYSTem Group

The commands in this group deal with startup. There are no front panel keys that correspond to the commands in this group.

:SYSTem:MODUle:OPTion:IDN?

Function Queries the OPM module or VLS module type.

Syntax :SYSTem:MODUle:OPTion:IDN?

Example :SYSTEM:MODULE:OPTION:IDN?
-> AQ2781V,C3QF30034F,SCC

Description The AQ7280 outputs three fields of data separated by commas.

Field 1: Model name "AQ2781V"

Field 2: The AQ7280 serial number "C3QF30034F"

Field 3: Suffix code "SCC/FCC/LMC" (for OPM module)

SCC: Universal adapter (SC)

FCC: Universal adapter (FC)

LMC: Ferrule adapter (Ø1.25)

:SYSTem:MODUle:OTDR:IDN?

Function Queries OTDR unit type.

Syntax :SYSTem:MODUle:OTDR:IDN?

Example :SYSTEM:MODULE:OTDR:IDN?
-> AQ7284A,C3QF25018F,USC/PC/SLS

Description The AQ7280 outputs three fields of data separated by commas.

Field 1: Model name "AQ7284A"

Field 2: The AQ7280 serial number "C3QF25018F"

Field 3: Suffix code "USC/PC/SLS"

USC: Universal adapter (SC)

UFC: Universal adapter (FC)

ULC: Universal adapter (LC)

ASC: Universal connector (Angled-PC SC)

PC: Power checker

SLS: Stabilized light source function

:SYSTem:REBoot

Function Restarts the AQ7280.

Syntax :SYSTem:REBoot

Example :SYSTEM:REBOOT

:SYSTem:SAVE

Function Executes the saving of setup parameters.

Syntax :SYSTem:SAVE

Example :SYSTEM:SAVE

:SYSTem:SHUTdown

Function Shuts down the AQ7280.

Syntax :SYSTem:SHUTdown

Example :SYSTEM:SHUTDOWN

4.20 VLS Group

The commands in this group deal with the visible light source. This function is valid when the visible light source module (VLS module) is installed. You can perform the same operations and make the same settings and queries that you can by using the front panel.

:VLS:ABORt

Function Turns the visible light source off.

Syntax :VLS:ABORt

Example :VLS:ABORt

:VLS:EXECute

Function Turns the visible light source on.

Syntax :VLS:EXECute

Example :VLS:EXECUTE

:VLS:STATe

Function Turns the visible light source on or off.

Syntax :VLS:STATe <Boolean>

:VLS:STATe?

Example :VLS:STATE ON

:VLS:STATE? -> :VLS:STATE 1

Description :VLS:STATE ON is the same as VLS:EXECUTE.

:VLS:STATE OFF is the same as VLS:ABORT.

You can use :VLS:STATe? to check whether the visible light source is on or off.

4.21 WAVedata Group

The commands in this group deal with waveform data. There are no front panel keys that correspond to the commands in this group.

:WAVedata:DISPlay:SEND:ASCii?

Function Queries the data of the displayed waveform in ASCII format.

Syntax :WAVedata:DISPlay:SEND:ASCii?

Example :WAVEDATA:DISPLAY:SEND:ASCII?
-> 0.000,1.234,...

Description Queries the waveform data that is displayed on the screen in ASCII format.
Return value format: XXXXX, XXXXX, etc.
Return value example: 45000 is returned for a value of 45.000 dB.

:WAVedata:DISPlay:SEND:BINary?

Function Queries the data of the displayed waveform in binary format.

Syntax :WAVedata:DISPlay:SEND:BINary?

Example :WAVEDATA:DISPLAY:SEND:BINARY?
-> #6123456ABCDEFGHJ1234567890...

Description Queries the waveform data that is displayed on the screen in block data (in binary format).
A returned value is the product of multiplying 1000 by a decibel value that is specified to the thousandths place. One value consists of 4 bytes and starts with the most-significant byte (to the thousandths place). For example, a returned value of 1000 indicates a value of 1.000 dB.

:WAVedata:LENGth?

Function Queries the number of waveform data points.

Syntax :WAVedata:LENGth?

Example :WAVEDATA:LENGTH?
-> :WAVEDATA:LENGTH 25000

:WAVedata:OLDType:DISPlay:SEND?

Function Queries the data of the displayed waveform in Dot4 format.

Syntax :WAVedata:OLDType:DISPlay:SEND?

Example :WAVEDATA:OLDTYPE:DISPLAY:SEND?
-> #42000...

Description Queries the waveform data that is displayed on the screen in block data (in binary format).
The returned value is an integer value that is the product of multiplying 250 by the data value. The most-significant byte and least-significant byte are produced in alternation, starting with the most-significant byte (to the thousandths place).

:WAVedata:OLDType:SEND?

Function Queries the waveform data in Dot4 format.

Syntax :WAVedata:OLDType:SEND?

Example :WAVEDATA:OLDTYPE:SEND?
-> #6123456ABCDEFGHJ1234567890...

Description Queries all the waveform data in block data (in binary format).
The returned value is an integer value that is the product of multiplying 250 by the data value. The most-significant byte and least-significant byte are produced in alternation, starting with the most-significant byte (to the thousandths place).

:WAVedata:SEND:ASCii?

Function Queries the waveform data in ASCII format.

Syntax :WAVedata:SEND:ASCii?

Example :WAVEDATA:SEND:ASCII?
-> 0.000,1.234,...

Description Queries all the waveform data in ASCII format.
Return value format: XX.XXX, XX.XXX, etc.

:WAVedata:SEND:BINary?

Function Queries the waveform data in block data (in binary format).

Syntax :WAVedata:SEND:BINary?

Example :WAVEDATA:SEND:BINARY?
-> #6123456ABCDEFGHJ1234567890...

Description Queries all the waveform data in binary format.
A returned value is the product of multiplying 1000 by a decibel value that is specified to the thousandths place. One value consists of 4 bytes and starts with the most-significant byte (to the thousandths place). For example, a returned value of 1000 indicates a value of 1.000 dB.

:WAVedata:SEND:SIZE

Function Sets or queries the number of acquired data points.

Syntax :WAVedata:SEND:SIZE <NRf>

:WAVedata:SEND:SIZE?
<NRf> = 1 to the number of measured points

Example :WAVEDATA:SEND:SIZE <NRf>
:WAVEDATA:SEND:SIZE?
-> :WAVEDATA:SEND:SIZE 20000

Description Values that exceed the range are rounded.

:WAVedata:SEND:START

Function Sets or queries the starting distance of the waveform data.

Syntax :WAVedata:SEND:START <NRf>
:WAVedata:SEND:START?

<NRf> = 0 to measured distance (m)

Example :WAVEDATA:SEND:START 20000
:WAVEDATA:SEND:START?
-> :WAVEDATA:SEND:START 20000

Description Values that exceed the range are rounded.

4.22 Common Commands

***CLS (Clear Status)**

Function Clears all event status registers that are displayed in the status byte register summary.

Syntax *CLS

Example *CLS

Description

- Clears all queues except the output queue and all event registers except the MAV summary message.
- After this command is executed, the AQ7280 is set to OCIS (Operation Complete Command Idle State) and OQIS (Operation Complete Query Idle State).

***ESE (Standard Event Status Enable)**

Function Sets or queries the standard event enable register.

Syntax *ESE<wsp><integer>

*ESE?
<integer> = 0 to 255

Example *ESE 251

*ESE? -> 251

Description

- Each item whose bit is set is enabled.
- The ESE is set to its default value when:
 - The power is turned on.
 - Zero is set.
- The ESE does not change its value when the following commands are executed:
 - *RST
 - *CLS
 - Device clear (DCL, SDC)
- The default value is zero.

***ESR? (Standard Event Status Register)**

Function Queries and clears the standard event status register.

Syntax *ESR?

Example *ESR? -> 251

Description The returned value of this query is not affected by the ESE (Event Status Enable Register).

***IDN? (Identification)**

Function Queries the instrument type and firmware version.

Syntax *IDN?

Example *IDN?

-> YOKOGAWA,AQ7280,SN123456789,F1.01

Description Four data fields delimited by commas are returned.

Field 1: Manufacturer "YOKOGAWA"

Field 2: Model "AQ7280A"

Field 3: Instrument serial number
"SN123456789"

Field 4: Firmware version "F1.01"

***OPT? (Option)**

Function Queries the option information.

Syntax *OPT?

Example *OPT? -> SMP,LAN

MNT: Monitoring function

SMP: Smart mapper function

FST: Fiber surface test function

LAN: Ethernet

SB: Shoulder strap

Description The installed options are returned delimited by commas.

***RST (Reset)**

Function Returns all the settings except the communication settings to their factory default values.

Syntax *RST

Example *RST

Description

- This command stops the operation in progress and resets the AQ7280 to its factory defaults.
- The following items do not change:
 - Output queue
 - SRE
 - ESE
 - Calibration data that affects the AQ7280 specifications

***SRE (Service Request Enable)**

Function Sets or queries the service request enable register.

Syntax *SRE <wsp><integer>

*SRE?

<integer> = 0 to 255

Example *SRE 250

*SRE? -> 250

Description

- Each item whose bit is set is enabled.
- The SRE is set to its default value when:
 - The power is turned on.
 - Zero is set.
- The SRE does not change its value when the following commands are executed:
 - *RST
 - *CLS
 - Device clear (DCL, SDC)
- The default value is zero.

***STB? (Read Status Byte)**

Function Queries the current status byte register value.

Syntax *STB?

Example *STB? -> 251

Description The STB is not cleared even if it is read.

***TST? (Self Test)**

Function Executes a self-test.

Syntax *TST?

Example *TST? -> 0

Description The AQ7280 returns 0 if the self-test is successful and 1 if it is not.

5.1 Condition Register

The condition register indicates the internal condition of the AQ7280.

Condition register	15	14	13	12	11	10	9	8	7	6	5	4	3	2	1	0
:STATus:CONDition?	0	0	0	PRT	LS	PME	PMZ	PMM	0	AR	PC	FIA	AS	FILE	AVE	REAL

The meanings of each bit of the condition register are as follows:

Bit 0	REAL	Set to 1 during real-time measurement.
Bit 1	AVE	Set to 1 during averaged measurement.
Bit 2	FILE	Set to 1 while a file is being accessed.
Bit 3	AS	Set to 1 during auto searching.
Bit 4	FIA	Set to 1 while the AQ7280 checks whether the fiber is in use.
Bit 5	PC	Set to 1 during plug checking.
Bit 6	AR	Set to 1 during auto range measurement.
Bit 8	PMM	Set to 1 during power meter measurement.
Bit 9	PMZ	Set to 1 while the power meter is being reset to 0.
Bit 10	PME	Set to 1 while a measurement error is occurring in the power meter.
Bit 11	LS	Set to 1 while the light source is ON.
Bit 12	PRT	Set to 1 during printing.

5.2 Output and Error Queue

Output Queue

The output queue stores query response messages. As shown below, data is stored in order and read from the oldest message first. The output queue is cleared when the AQ7280 is turned off and then back on.

The output queue cannot be emptied using the *CLS command. To see whether the output queue is empty or not, check bit 4 (MAV) of the status byte.

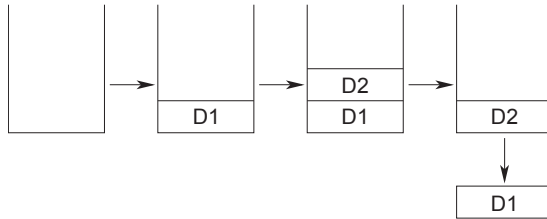

Error Queue

When an error occurs, the error queue stores the error number and message. For example, if the AQ7280 receives an incorrect program message from the controller, the error number (113) and the error message ("Undefined header") are stored in the error queue when the AQ7280 displays the error message.

You can use the :STATUS:ERROR? query to read the contents of the error queue. Like the output queue, the messages in the error queue are read from the oldest one first.

If the error queue overflows, the last message is replaced with the following message: 350, "Queue overflow"

The error queue is cleared when:

- A *CLS command is received.
- The AQ7280 is turned off and then back on.

You can determine whether or not the error queue is empty by checking bit 2 in the status byte (EAV).

Appendix Error Messages

This section explains communication error messages.

- Messages can be displayed in English or in another language on the AQ7280. However, when they are read from a PC or other similar device, messages are displayed in English.
- If servicing is necessary to solve the problem indicated by a message, contact your nearest YOKOGAWA dealer.
- Only communication error messages are listed here. For other error messages, see the *User's Manual IM AQ7280-01EN*.

Error in Execution

Code	Message
50	*OPC/? exists in message.
102	Syntax error.
103	Invalid separator.
104	Data type error.
108	Parameter not allowed.
109	Missing parameter.
111	Header separator error.
112	Program mnemonic too long.
113	Undefined header.
114	Header suffix out of range.
120	Numeric data error.
123	Exponent too large.
124	Too many digits.
128	Numeric data not allowed.
131	Invalid suffix.
134	Suffix too long.
138	Suffix not allowed.
141	Invalid character data.
144	Character data too long.
148	Character data not allowed.
150	String data error.
151	Invalid string data.
158	String data not allowed.
161	Invalid block data.
168	Block data not allowed.
171	Invalid expression.
178	Expression data not allowed.
181	Invalid outside macro definition.
221	Setting conflict.
222	Data out of range.
223	Data invalid
224	Illegal parameter value.
241	Hardware missing.
260	Expression error.
270	Macro error.
272	Macro execution error.
273	Improper macro label.
275	Macro definition too long.
276	Macro recursion error.
277	Macro redefinition not allowed
278	Macro header not found.
350	Queue overflow.
410	Query INTERRUPTED.
420	Query UNTERMINATED.
430	Query DEADLOCKED.
440	Query UNTERMINATED after indefinite response.

Index

Symbols

	Page
<Boolean>	3-7
<Character Data>	3-7
<Decimal>	3-6
<Distance>	3-6
<Loss>	3-6
<Multiplier>	3-6
<PMT>	3-1
<Program Message Unit>	3-1
<RMT>	3-1
<String Data>	3-7
<Time>	3-6
<Unit>	3-6
<Wavelength>	3-6

A

	Page
Abbreviated Form	3-5
ACQUIRE Group	4-8
approximated lines	4-19
approximation method, events	4-12
approximation method, interval analysis	4-16
approximation method, markers	4-14
attenuation	4-8
automatically detected events	4-12
automatic event searching	4-8
automatic saving	4-8
automatic searching	4-12
auto zoom	4-20
auxiliary markers	4-15
average count	4-8
averaged measurement	4-9
averaged time	4-9
average index	4-8
average type	4-9
averaging mode	4-8

B

	Page
backlight off	4-32
backscattering coefficient	4-12

C

	Page
cable code	4-29
cable ID	4-29
Command	3-3
Command Groups	3-3
Common Command	3-3, 4-48
COMMunicate Group	4-18
communication status feature	4-43
company name	4-29
Compound Header	3-3
condition register	5-1
Condition Register	4-43
connection loss	4-13, 4-14
connection loss threshold	4-17
connection loss threshold, fault event	4-17
cumulative loss	4-13
current data flag	4-29
cursor dB value	4-12
cursor, deletion	4-12
cursor display format	4-19
cursor link	4-12
cursor position	4-12

D

	Page
Data	3-1, 3-6
dB decimal	4-19
DHCP	4-35
DISPlay Group	4-19
display scale	4-20
display start distance	4-19
display start level	4-19
display unit (power meter's)	4-38
distance	4-13
distance decimal	4-19
distance, interval data	4-16
distance range	4-8, 4-9
distance reference	4-15
distance unit	4-12
Dref	4-37

E

	Page
end position, interval data	4-16
end position label	4-29
error code and message information	4-43
error dialog box	4-31
Error Messages	App-1
Error Queue	4-43, 5-2
Ethernet Interface	2-2
Ethernet on/off state	4-36
event, deletion	4-14
event, insertion	4-14
event type	4-13
Executes printing	4-40

F

	Page
factory default	4-42, 4-48
fault events	4-14
fiber end	4-16
fiber ID	4-29
fiber type	4-29
file, acquisition	4-21
file, deletion	4-21
FILE Group	4-21
file name, specification	4-21
file, saving	4-23
FIPProbe Group	4-25
firmware version	4-48
folder, creation	4-21
formatting, internal memory	4-42
free space	4-21
function mode	4-31

G

	Page
gateway	4-35
group index	4-15

H

	Page
Header	3-1, 4-18

I

	Page
interval analysis data	4-16
interval data reference point	4-16
interval index	4-14
IP address	4-35

Index

L	Page	R	Page
LABel Group	4-29	real-time measurement.....	4-10
light off	4-30	reference data, interval data.....	4-16
light off (visible light source)	4-45	reference value.....	4-37
light on	4-30	reflection, amount.....	4-15
light on (visible light source)	4-45	reflection display.....	4-33
LIGHtsource Group	4-30	reflection saturation	4-14
light source power meter setting interlock	4-37	Releasing the Remote Control (Ethernet)	2-4
loss, interval data.....	4-16	Releasing the Remote Control (USB).....	1-4
lower threshold value (power meter's)	4-37	REPOrt Group	4-41
		Response Data.....	3-1
		Restart	4-44
		RMT	3-1
M	Page	S	Page
marker, deletion	4-14	sampling interval.....	4-11
marker information, displaying.....	4-20	screen colors	4-19
marker mode	4-31	second cursor	4-19
markers.....	4-13, 4-15	self-test	4-49
MAX.....	4-37	service request enable register	4-49
measured results (power meter's).....	4-37	SETup Group.....	4-42
measurement light	4-30	shortest abbreviation	3-4
measurement mode.....	4-10	Shuts down.....	4-44
measurement start position	4-9	standard event enable register	4-48
measurement wavelength	4-11	standard event status register	4-48
MENU Group.....	4-31	start position, interval data.....	4-16
Messages	3-1	start position label.....	4-29
Message Unit.....	3-1	status byte register	4-48, 4-49
MIN	4-37	STATus Group	4-43
mini B.....	1-3	STP cable	2-3
MISC Group.....	4-32	subnet mask	4-35
modulation	4-37	Switching from Local to Remote Mode (Ethernet).....	2-2
modulation frequency	4-30	Switching from Local to Remote Mode (USB).....	1-2
moving (cursors and markers).....	4-13	Switching from Remote to Local Mode (Ethernet).....	2-2
		Switching from Remote to Local Mode (USB).....	1-2
		SYSTem Group.....	4-44
N	Page	T	Page
NETWork Group.....	4-35	TCP/IP	2-5
		Timeout Value.....	2-5, 4-35
		type B	1-3
O	Page	U	Page
offset (power meter's).....	4-37	Upper-level Query	3-3
operator name	4-29	upper threshold value (power meter's).....	4-37
optical plug	4-9	USB connector type B (mini B).....	1-3
optical return loss	4-13, 4-15	USB Interface	1-2
optical return loss, interval data.....	4-16	user name.....	4-35
optical return loss saturation.....	4-15	UTP cable.....	2-3
optical return loss saturation, interval data	4-16		
optical return loss threshold.....	4-17		
optical return loss threshold, fault event.....	4-17		
option information	4-48		
Output Queue.....	5-2		
P	Page	V	Page
pass/fail judgment (optical fiber end face).....	4-25	VLS Group.....	4-45
password	4-35		
PMEter Group.....	4-37		
PMONitor Group.....	4-39		
PMT	3-1		
Port number	2-2		
print colors	4-40		
printer manufacturer setting.....	4-40		
PRINt Group	4-40		
Program Messages	3-1		
pulse width.....	4-8, 4-10		
Q	Page	W	Page
query.....	3-1	WAVedata Group	4-46
		waveform data	4-46
		wavelength mode (power meter's)	4-38
		wavelength (power meter's)	4-30
		Z	Page
		zero set (power meter's).....	4-38
		zoom	4-20