



## Features



- Limit switch design (EN 50047)
- For use on doors or flaps
-  Positive opening safety contacts (IEC 60947-5-1) (not dependent upon springs)
- Glass-reinforced thermoplastic switch housing with plated steel actuator
-  Insulated device (IEC 60947-5-1) on all models with plastic housings
- Actuator head rotatable in 90 degree increments

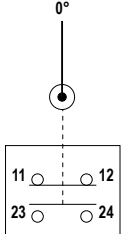
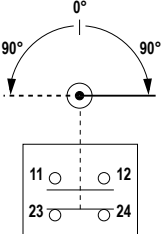
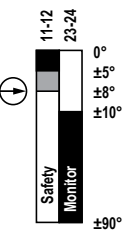
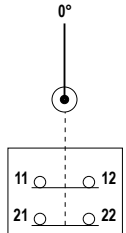
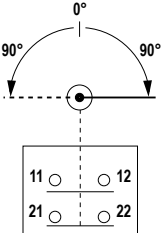
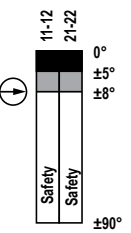

## Models

Model	Actuator	Contact Configuration (Lever in Normal Position)	Contact Configuration (Lever Rotated)	Switching Diagram
SI-LS31HGD	Vertical Hinged Lever $\pm 90^\circ$			
SI-LS31HGE				

NOTE:  This symbol for a positive opening safety contact (IEC 60947-5-1) is used in the switching diagrams to identify the point in actuator travel where the normally closed safety contact is fully open.

Contacts:  Open  Closed  Transition



# Machine Safety Switches – SI-LS31H Series



## Important Information Regarding the Use of Safety Switches

In the United States, the functions that Banner safety switches are intended to perform are regulated by the Occupational Safety and Health Administration (OSHA). Whether or not any particular safety switch installation meets all applicable OSHA requirements depends upon factors that are beyond the control of Banner Engineering Corp. These factors include the details of how the safety switches are applied, installed, wired, operated, and maintained.

Banner Engineering Corp. has attempted to provide complete application, installation, operation, and maintenance instructions. This information is found in the instruction manual packaged with each safety switch. In addition, we suggest that any questions regarding the use or installation of safety switches be directed to the factory applications department at the telephone numbers or address shown below.

Banner Engineering Corp. recommends that safety switches be applied according to the guidelines set forth in international (ISO/IEC) standards listed below. Specifically, Banner Engineering Corp. recommends application of these safety switches in a configuration which meets safety category 4, per ISO 13849 (EN954-1).

In addition, the user of Banner safety switches has the responsibility to ensure that all local, state, and national laws, rules, codes, and regulations relating to the use of Banner safety switches in any particular application are satisfied. Extreme care is urged that all legal requirements have been met and that all installations and maintenance instructions are followed.

### Application Assistance

**Toll Free:** 1-888-3-SENSOR (1-888-373-6767)  
**Email:** sensors@bannerengineering.com  
**Address:** 9714 Tenth Avenue North  
Minneapolis, MN 55441

### U.S. Regulations Applicable to Use of Banner Safety Switches

OSHA Code of Federal Regulations: Title 29, Parts 1900 to 1910

Available from: Superintendent of Documents  
Government Printing Office  
P.O. Box 371954  
Pittsburgh, PA 15250-7954  
Tel: 202-512-1800

### U.S. Standards Applicable to Use of Banner Safety Switches

ANSI B11 "Standards for Construction, Care, and Use of Machine Tools"  
Available from: Safety Director  
AMT—The Association for Manufacturing Technology  
7901 Westpark Drive  
McLean, VA 22102  
Tel: 703-893-2900

### Applicable European and International Standards

ISO/TR 12100-1 "Safety of Machinery—Basic Concepts, General Principles for Design"  
(EN292-18-2)  
ISO 13852 (EN 294) "Safety of Machinery—Safety Distances to Prevent Danger Zones Being Reached by the Upper Limbs"  
ISO 13853 (EN 811) "Safety of Machinery—Safety Distances to Prevent Danger Zones Being Reached by the Lower Limbs"  
ISO 13849 (EN 954-1) "Safety of Machinery—Safety Related Parts of Control Systems"  
ISO 13855 (EN 999) "Safety of Machinery—The Positioning of Protective Equipment in Respect to Approach Speeds of Parts of the Human Body"  
ISO 14119 (EN 1088) "Safety of Machinery—Interlocking Devices Associated with Guards—Principles for Design and Selection"  
IEC/EN 60204-1 "Safety of Machinery—Electrical Equipment of Machines"  
IEC/EN 60947-5-1 "Low Voltage Switchgear—Electromechanical Control Circuit Devices"

Available from: Global Engineering Documents  
15 Inverness Way East  
Englewood, CO 80112-5704  
Phone: 1-800-854-7179  
Fax: 303-397-2740

# Machine Safety Switches – SI-LS31H Series

## Models

Model	Actuator	Contact Configuration (Lever in Normal Position)	Contact Configuration (Lever Rotated)	Switching Diagram
SI-LS31HGRD	Right-hand Hinged Lever 180°			
SI-LS31HGRE				
SI-LS31HGLD	Left-hand Hinged Lever 180°			
SI-LS31HGLE				

NOTE: This symbol for a positive opening safety contact (IEC 60947-5-1) is used in the switching diagrams to identify the point in actuator travel where the normally closed safety contact is fully open.

Contacts: □ Open ■ Closed ◐ Transition

# Machine Safety Switches – SI-LS31H Series

## Overview

Series SI-LS31H safety interlock switches have a built-in hinged lever actuator that mounts to a hinged door or flap to detect its being opened. The actuator head may be rotated on the interlock body in any of four positions (see Figure 1).

## Mechanical Installation

1. With actuator in the normal position, loosen the four screws holding the actuator head to the switch body and carefully rotate the actuator head to the desired position (see Figure 1). Re-tighten the four screws.
2. User tamper-resistant hardware, such as one-way screws, to attach lever actuator and to mount the switch body.
3. If possible, align lever pivot point with the axis of the door or flap.

**IMPORTANT: A safety switch must be installed in a manner which discourages tampering or defeat. Mount each switch to prevent bypassing of the switching function at the terminal chamber. Overtravel may cause damage to switch.**

Model **SI-LS31HGD** is used on doors or flaps which open a maximum of 90° in either direction, beginning with the lever in a vertical position (see Figure 2, top).

Models **SI-LS31HGRD** and **SI-LS31HGLD** are used on doors and flaps which open in one direction, beginning with the lever in a horizontal position (see Figure 2, bottom).

## Electrical Installation

### Access to the Wiring Chamber

The wiring chamber is accessed via a hinged cover door which may be pried open using a flat-blade screwdriver (see the dimension drawings on page 7). A conduit adapter is supplied to convert the German M20 x 1.5 thread to ½" x 14 NPT. An accessory cable gland which fits the M20 x 1.5 thread is available (see page 7).

### Connection to a Machine

Two types of contacts are offered. The contacts between terminals 11–12 and 21–22 are the safety contacts, which are closed (i.e., they conduct) when the actuator is in the home (0°) position. The contacts located between terminals 23–24 are considered monitoring contacts, which should not be used for safety switching.

As illustrated in Figure 3, a normally-closed safety contact (i.e., a safety contact that is closed when the actuator is in the home [0°] position) from **each of two safety switches per interlock guard** must connect to a 2-channel safety module or safety interface in order to achieve a control reliable interface to the master stop control elements of a machine. Examples of appropriate safety modules include 2-channel emergency stop (E-stop) safety modules and gate monitor safety modules.

Two functions of the safety module or safety interface are:

1. to provide a means of monitoring the contacts of both safety switches for contact failure, and to prevent the machine from restarting if either switch fails; and
2. to provide a reset routine after closing the guard and returning the safety switch contacts to their closed position. This prevents the controlled machinery from restarting by simply moving the safety switch actuators. This necessary reset function is required by ANSI B11 and NFPA 79 machine safety standards.

Actuator head may be rotated in 90° increments.

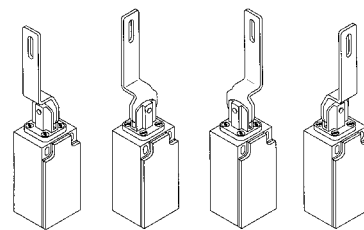
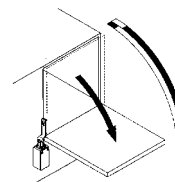

Figure 1. Features

Model  
**SI-LS31HGD**



Models  
**SI-LS31HGRD**  
**SI-LS31HGLD**

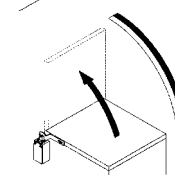
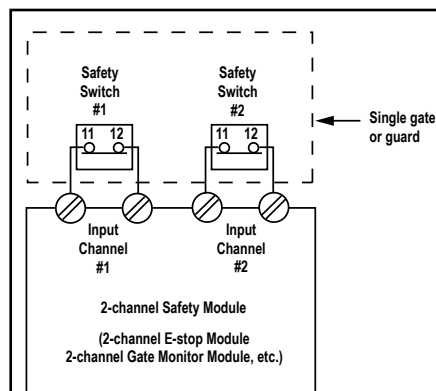

Figure 2. Door opens in one direction



**NOTE: Refer to the installation instructions provided with the safety module for information regarding the interface of the safety module to the machine stop control elements.**

Figure 3. Connect two redundant safety switches per interlock guard to an appropriate 2-channel input safety module.



## CAUTION . . . Electrical Installation

Two safety switches must be used for each interlock guard to achieve control reliability or Safety Category 4 (per ISO 13849-1, EN 954-1) of a machine stop circuit. Use of only one safety switch per interlock guard is not recommended.

In addition, normally-closed safety contacts from each of the two safety switches should be connected to the two separate inputs of a 2-channel safety module or safety interface, as illustrated in Figure 6. This is required to provide monitoring for safety switch contact failure, and to provide the necessary reset routine, as required by IEC 60204-1 and NFPA 79 machine safety standards.



## WARNING . . . Series Connection of Safety Interlock Switches

Monitoring multiple guards with a series connection of multiple safety interlock switches is not a Safety Category 4 Application (per ISO 13849-1, EN 954-1). A single failure may be masked or not detected at all. When such a configuration is used, procedures must be performed regularly to verify proper operation of each switch.



## WARNING . . .

It must not be possible for personnel to reach any hazard point through an opened guard (or any opening) before hazardous machine motion has completely stopped. Please reference OSHA CFR 1910.217 and ANSI B11 standards (see page 2) for information on determining safety distances and safe opening sizes for your guarding devices.

Use only a positively driven, normally closed safety contact from each switch for connection to the safety module. *The normally open contact may be used for control functions that are **not safety-related**.* A typical use is to communicate with a process controller. Refer to the installation instructions provided with the safety modules for more information regarding the interface of the safety module to the machine stop control elements.

## Periodic Checks

Safety switches should be checked at each shift change or machine setup by a *designated person* (see below) for:

1. Breakage of the switch body or actuator,
2. Good alignment and full engagement of the actuator with the receptor,
3. Confirmation that the safety switch is not being used as an end stop,
4. Loosening of the switch or actuator mounting hardware, and
5. Verification that it is not possible to reach any hazard point through an opened guard (or any opening) before hazardous machine motion has completely stopped.

In addition, a *qualified person* should check for the following on a periodic schedule determined by the user based upon the severity of the operating environment and the frequency of switch actuations:

1. Check the wiring chamber for signs of contamination.
2. Check the contacts for signs of deterioration or damage.
3. Inspect the electrical wiring for continuity and damage.
4. Verify that wiring conforms to the instructions on pages 4 and 5 of this data sheet.

A *designated person* is identified in writing by the employer as being appropriately trained to perform a specified checkout procedure. A *qualified person* possesses a recognized degree or certificate or has extensive knowledge, training, and experience to be able to solve problems relating to the safety switch installation (ANSI B30.2).

## Repairs



**Do not attempt any repairs to the switch. It contains no field-replaceable components. Return the switch to the factory for warranty repair or replacement.**

If it ever becomes necessary to return a switch to the factory, please do the following:

1. Contact the Banner applications engineering department at the number or address listed on the front cover. They will attempt to troubleshoot the system from your description of the problem. If they conclude that a component is defective, they will issue an RMA (Return Merchandise Authorization) number for your paperwork, and give you the proper shipping address.
2. Pack the switch carefully. Damage which occurs in shipping is not covered by warranty.

# Machine Safety Switches – SI-LS31H Series

## Specifications

<b>Contact Rating</b>	10A @ 24V ac, 10A @ 110V ac, 6A @ 230V ac 6A @ 24V dc 2.5 kV max. transient tolerance NEMA A300 P300																	
<b>European Rating</b>	<b>Utilization categories:</b> AC15 and DC13  $U_i = 500V$ ac $I_{th} = 10A$	<table border="1"> <thead> <tr> <th colspan="3">40-60 Hz</th> </tr> <tr> <th><math>U_e</math> V</th> <th><math>I_e/AC-15</math> A</th> <th><math>I_e/AC-13</math> A</th> </tr> </thead> <tbody> <tr> <td>24</td> <td>10</td> <td>6</td> </tr> <tr> <td>110</td> <td>10</td> <td>1</td> </tr> <tr> <td>230</td> <td>6</td> <td>0.4</td> </tr> </tbody> </table>		40-60 Hz			$U_e$ V	$I_e/AC-15$ A	$I_e/AC-13$ A	24	10	6	110	10	1	230	6	0.4
40-60 Hz																		
$U_e$ V	$I_e/AC-15$ A	$I_e/AC-13$ A																
24	10	6																
110	10	1																
230	6	0.4																
<b>Contact Material</b>	Silver-nickel alloy																	
<b>Maximum Switching Speed</b>	50 operations per minute																	
<b>Required Actuation Force</b>	15 N cm (1.3 lbf in)																	
<b>Short Circuit Protection</b>	6 amp Slow Blow, 10 amp Fast Blow. Recommended external fusing or overload protection.																	
<b>Mechanical Life</b>	1 million operations																	
<b>Wire Connections</b>	Screw terminals with pressure plates accept the following wire sizes – <b>Stranded and solid:</b> 20 AWG (0.5 mm <sup>2</sup> ) to 16 AWG (1.5 mm <sup>2</sup> ) for one wire <b>Stranded:</b> 20 AWG (0.5 mm <sup>2</sup> ) to 18 AWG (1.0 mm <sup>2</sup> ) for two wires																	
<b>Cable Entry</b>	M20 x 1.5 threaded entrance. Adapter supplied to convert M20 x 1.5 to ½"-14 NPT threaded entrance (See dimension drawings on page 7.)																	
<b>Construction</b>	Glass fiber-reinforced thermoplastic UL94-VO rating; plated steel actuator																	
<b>Environmental Rating</b>	IEC IP65																	
<b>Operating Conditions</b>	<b>Temperature:</b> -30° to +80° C (-22° to +176° F)																	
<b>Weight</b>	0.09 Kg (0.20 lbs)																	
<b>Certifications</b>	  																	

# Machine Safety Switches – SI-LS31H Series

## Dimensions

Models SI-LS31HGRD/HGRE and HGLD/HGLE

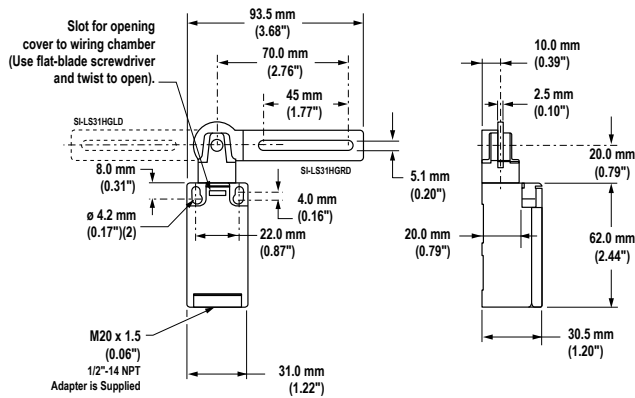

Model SI-LS31HGD/HGE

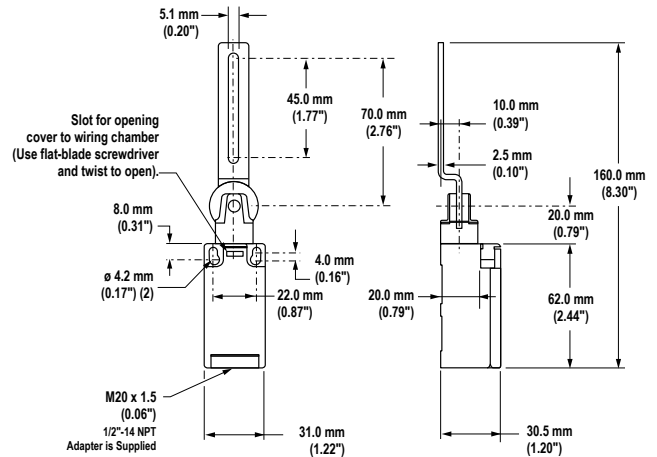

## Accessories

### Cable Glands

Size	Model	Used with Switch Models	For Cable Diameters	Dimensions
M20 x 1.5 Plastic	SI-QS-CGM20	All	5.0 to 12.0 mm (0.20" to 0.47")	

### Replacement Parts

Size	Model*	Used with Switch Models	Thread Conversion	Dimensions
1/2"-14 NPT Plastic Conduit Adapter	SI-QS-M20	All	M20 x 1.5 to 1/2"-14 NPT	

\*NOTE: One conduit adapter is supplied with each switch.

# Machine Safety Switches – SI-LS31H Series

---



**the machine safety specialist**

**WARRANTY:** Banner Engineering Corp. warrants its products to be free from defects for one year. Banner Engineering Corp. will repair or replace, free of charge, any product of its manufacture found to be defective at the time it is returned to the factory during the warranty period. This warranty does not cover damage or liability for the improper application of Banner products. This warranty is in lieu of any other warranty either expressed or implied.