

# EZ-LIGHT® Touch Gen 2 K50 Series Illuminated Multipurpose Buttons

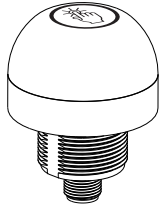

## Datasheet

General Purpose Multicolor Indicator with Independent Momentary Touch Button Output



Standard Model



Compact Model

- Excellent immunity to false triggering by water spray, detergents, oils, and other foreign materials
- Rugged, cost-effective, and easy-to-install multicolor indicator with touch button
- Waterproof IEC IP69K construction for washdown environments
- Three independent colors in one unit—Color 3 overrides Colors 1 and 2, Color 2 overrides Color 1
- Available with PNP and NPN inputs/outputs, depending on model
- Ergonomically designed to eliminate hand, wrist, and arm stresses associated with repeated switch operation; require no physical force to operate
- Can be actuated with bare hands or gloves
- 12 V dc to 30 V dc operation
- Compact models available for lower profile applications



### WARNING: Not To Be Used for Personnel Protection

Never use this device as a sensing device for personnel **protection**. Doing so could lead to serious injury or death. This device does not include the self-checking redundant circuitry necessary to allow its use in personnel safety applications. A sensor failure or malfunction can cause either an energized or de-energized sensor output condition.

## Models

Model <sup>1</sup>	I/O Type	Output State	Color 1	Color 2	Color 3	Connection
K50APT2GRYF2Q	PNP	N.O.	Green	Red	Yellow	Integral 8-pin M12/Euro-style male quick disconnect (QD)
K50RPT2GRYF2Q		N.C.				
K50ANT2GRYF2Q	NPN	N.O.				
K50RNT2GRYF2Q		N.C.				

## Wiring Diagram

NPN (Sinking) Output Models

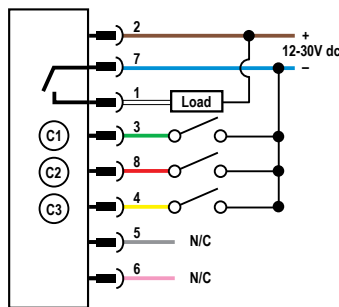

PNP (Sourcing) Output Models

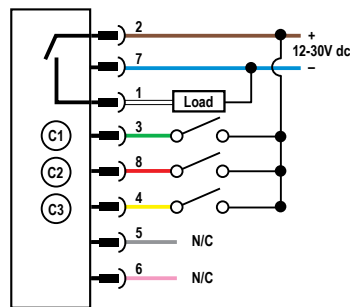

Wiring Key

- 1 = White
- 2 = Brown
- 3 = Green
- 4 = Yellow
- 5 = Gray
- 6 = Pink
- 7 = Blue
- 8 = Red

Pinout

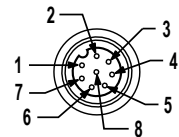

<sup>1</sup>

- To order the 2 m (6.5 ft) PVC cable model, omit the suffix "Q" in the model number. For example, K50APT2GRYF2.
- To order the 150 mm (6 in) PVC cable model with an 8-pin M12/Euro-style quick disconnect, replace the suffix "Q" with "QP" in the model number. For example, K50APT2GRYF2QP.
- To order a compact model, add the suffix "C" after K50 in the model number. For example, K50CAPT2GXQD.
- Models with a quick disconnect require a mating cordset.



## Indicator and Output Behavior

Table 1: PNP Models

Input Actions				Touch Button Actions		
Input #1: Pin 3 Green Wire	Input #2: Pin 8 Red Wire	Input #3: Pin 4 Yellow Wire	LED Color	Output Type	Touch	Output: Pin 1 White Wire
Open or -Vdc	Open or -Vdc	Open or -Vdc	Light Off	N.O.	Not touched	PNP Output Off
+V dc	Open or -Vdc	Open or -Vdc	Color #1 On		Touched	PNP Output On
+V dc	+V dc	Open or -Vdc	Color #2 On	N.C.	Not touched	PNP Output On
+V dc	+V dc	+V dc	Color #3 On		Touched	PNP Output Off
Open or -Vdc	+V dc	Open or -Vdc	Color #2 On			
Open or -Vdc	+V dc	+V dc	Color #3 On			
Open or -Vdc	Open or -Vdc	+V dc	Color #3 On			
+V dc	Open or -Vdc	+V dc	Color #3 On			

Table 2: NPN Models

Input Actions				Touch Button Actions		
Input #1: Pin 3 Green Wire	Input #2: Pin 8 Red Wire	Input #3: Pin 4 Yellow Wire	LED Color	Output Type	Touch	Output: Pin 1 White Wire
Open or +V dc	Open or +V dc	Open or +V dc	Light Off	N.O.	Not touched	NPN Output Off
-Vdc	Open or +V dc	Open or +V dc	Color #1 On		Touched	NPN Output On
-Vdc	-Vdc	Open or +V dc	Color #2 On	N.C.	Not touched	NPN Output On
-Vdc	-Vdc	-Vdc	Color #3 On		Touched	NPN Output Off
Open or +V dc	-Vdc	Open or +V dc	Color #2 On			
Open or +V dc	-Vdc	-Vdc	Color #3 On			
Open or +V dc	Open or +V dc	-Vdc	Color #3 On			
-Vdc	Open or +V dc	-Vdc	Color #3 On			

## Specifications

### Supply Voltage

12 V dc to 30 V dc

### Supply Current

< 75 mA max current at 12 V dc (exclusive of load)  
< 50 mA max current at 30 V dc (exclusive of load)

### Supply Protection Circuitry

Protected against reverse polarity and transient voltages

### Output Rating

Maximum load: 150 mA  
ON-state saturation voltage: < 2 V dc at 10 mA; < 2.5 V dc at 150 mA  
OFF-state leakage current: < 10 µA at 30 V dc

### Environmental Rating

IEC IP67, IP69K per DIN 40050-9.  
Cabled models also meet IP69K if the cable and cable entrance are protected from high-pressure spray.

### Output Response Time

50 milliseconds On and Off

### Connections

8-pin integral M12/Euro-style QD, 2 m (6.5 ft) PVC integral cable, or 8-pin 150 mm (6 in) M12/Euro-style PVC cable QD

### Mounting

M30 × 1.5 threaded base max. torque 4.5 N-m (40 in-lbf)

### Power-Up Delay

300 milliseconds

### Indicator Lumens

Color	Typical Wavelength	Typical Intensity (lm)
Green	525 nm	29
Red	625 nm	13
Yellow	591 nm	24

**Operating Conditions**

-40 °C to +50 °C (-40 °F to +122 °F)  
 90% at 50 °C maximum relative humidity (non-condensing)

**Storage**

-40 °C to +70 °C (-40 °F to +158 °F)

**Construction**

Housing: polycarbonate  
 Translucent dome: polycarbonate  
 Mounting nut: PBT

**Vibration and Mechanical Shock**

Vibration 10 Hz to 55 Hz 1.0 mm p-p amplitude per IEC 60068-2-6  
 Shock 30G 11 ms duration, half sine wave per IEC 60068-2-27

**Certifications**



**Required Overcurrent Protection**



**WARNING:** Electrical connections must be made by qualified personnel in accordance with local and national electrical codes and regulations.

Overcurrent protection is required to be provided by end product application per the supplied table.  
 Overcurrent protection may be provided with external fusing or via Current Limiting, Class 2 Power Supply.  
 Supply wiring leads < 24 AWG shall not be spliced.  
 For additional product support, go to [www.bannerengineering.com](http://www.bannerengineering.com).

Supply Wiring (AWG)	Required Overcurrent Protection (Amps)
20	5.0
22	3.0
24	2.0
26	1.0
28	0.8
30	0.5

**Dimensions**

Standard Models

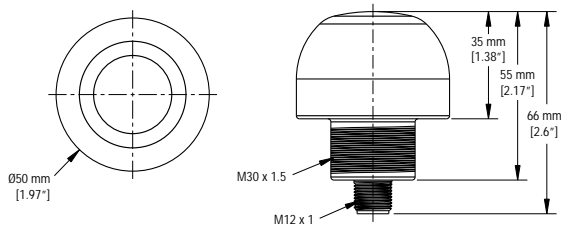

Compact Models

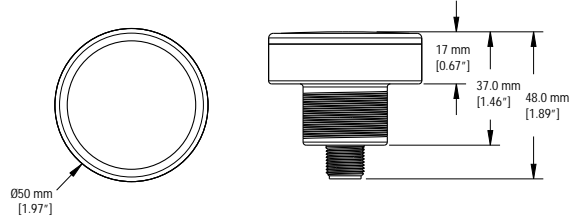

All measurements are listed in millimeters [inches], unless noted otherwise.

**Accessories**

**Cordsets**

8-Pin Threaded M12/Euro-Style Cordsets with Open-Shield				
Model	Length	Style	Dimensions	Pinout (Female)
MOQC2S-806	1.83 m (6 ft)	Straight		
MOQC2S-815	4.57 m (15 ft)			
MOQC2S-830	9.14 m (30 ft)			
MOQC2S-850	15.2 m (50 ft)			
MOQC2S-806RA	1.83 m (6 ft)	Right-Angle		
MOQC2S-815RA	4.57 m (15 ft)			
MOQC2S-830RA	9.14 m (30 ft)			
MOQC2S-850RA	15.2 m (50 ft)			

- 1 = White
- 2 = Brown
- 3 = Green
- 4 = Yellow
- 5 = Gray
- 6 = Pink
- 7 = Blue
- 8 = Red

## Brackets

## SMB30A

- Right-angle bracket with curved slot for versatile orientation
- Clearance for M6 (¼ in) hardware
- Mounting hole for 30 mm sensor
- 12-ga. stainless steel

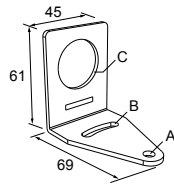

Hole center spacing: A to B=40  
Hole size: A=ø 6.3, B= 27.1 x 6.3, C=ø 30.5

## SMB30FA

- Swivel bracket with tilt and pan movement for precise adjustment
- Mounting hole for 30 mm sensor
- 12-ga. 304 stainless steel
- Easy sensor mounting to extrude rail T-slot
- Metric and inch size bolt available

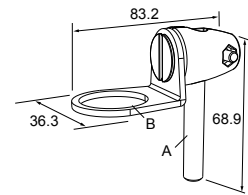

Bolt thread: SMB30FA, A= 3/8 - 16 x 2 in; SMB30FAM10, A= M10 - 1.5 x 50  
Hole size: B= ø 30.1

## SMB30FVK

- V-clamp, flat bracket and fasteners for mounting to pipe or extensions
- Clamp accommodates 28 mm dia. tubing or 1 in. square extrusions
- 30 mm hole for mounting sensors

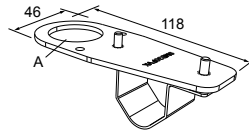

Hole size: A= ø 31

## SMB30MM

- 12-ga. stainless steel bracket with curved mounting slots for versatile orientation
- Clearance for M6 (¼ in) hardware
- Mounting hole for 30 mm sensor

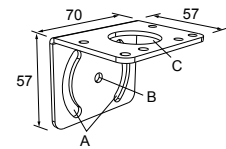

Hole center spacing: A = 51, A to B = 25.4  
Hole size: A = 42.6 x 7, B = ø 6.4, C = ø 30.1

## SMB30RAVK

- V-clamp, right-angle bracket and fasteners for mounting sensors to pipe or extrusion
- Clamp accommodates 28 mm dia. tubing or 1 in. square extrusions
- 30 mm hole for mounting sensors

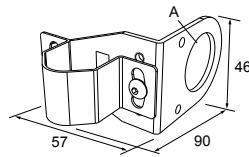

Hole size: A = ø 30.5

## SMB30SC

- Swivel bracket with 30 mm mounting hole for sensor
- Black reinforced thermoplastic polyester
- Stainless steel mounting and swivel locking hardware included

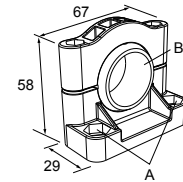

Hole center spacing: A=ø 50.8  
Hole size: A=ø 7.0, B=ø 30.0

## SMBAMS30P

- Flat SMBAMS series bracket
- 30 mm hole for mounting sensors
- Articulation slots for 90°+ rotation
- 12-ga. 300 series stainless steel

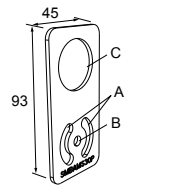

Hole center spacing: A=26.0, A to B=13.0  
Hole size: A=26.8 x 7.0, B=ø 6.5, C=ø 31.0

## SMBAMS30RA

- Right-angle SMBAMS series bracket
- 30 mm hole for mounting sensors
- Articulation slots for 90°+ rotation
- 12-ga. (2.6 mm) cold-rolled steel

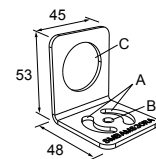

Hole center spacing: A=26.0, A to B=13.0  
Hole size: A=26.8 x 7.0, B=ø 6.5, C=ø 31.0

## TC-K50-CL

- Touch cover

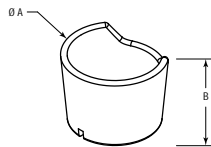

Diameter: A = 67 mm  
Height: B = 42.5 mm

## Banner Engineering Corp. Limited Warranty

---

Banner Engineering Corp. warrants its products to be free from defects in material and workmanship for one year following the date of shipment. Banner Engineering Corp. will repair or replace, free of charge, any product of its manufacture which, at the time it is returned to the factory, is found to have been defective during the warranty period. This warranty does not cover damage or liability for misuse, abuse, or the improper application or installation of the Banner product.

THIS LIMITED WARRANTY IS EXCLUSIVE AND IN LIEU OF ALL OTHER WARRANTIES WHETHER EXPRESS OR IMPLIED (INCLUDING, WITHOUT LIMITATION, ANY WARRANTY OF MERCHANTABILITY OR FITNESS FOR A PARTICULAR PURPOSE), AND WHETHER ARISING UNDER COURSE OF PERFORMANCE, COURSE OF DEALING OR TRADE USAGE.

This Warranty is exclusive and limited to repair or, at the discretion of Banner Engineering Corp., replacement. IN NO EVENT SHALL BANNER ENGINEERING CORP. BE LIABLE TO BUYER OR ANY OTHER PERSON OR ENTITY FOR ANY EXTRA COSTS, EXPENSES, LOSSES, LOSS OF PROFITS, OR ANY INCIDENTAL, CONSEQUENTIAL OR SPECIAL DAMAGES RESULTING FROM ANY PRODUCT DEFECT OR FROM THE USE OR INABILITY TO USE THE PRODUCT, WHETHER ARISING IN CONTRACT OR WARRANTY, STATUTE, TORT, STRICT LIABILITY, NEGLIGENCE, OR OTHERWISE.

Banner Engineering Corp. reserves the right to change, modify or improve the design of the product without assuming any obligations or liabilities relating to any product previously manufactured by Banner Engineering Corp. Any misuse, abuse, or improper application or installation of this product or use of the product for personal protection applications when the product is identified as not intended for such purposes will void the product warranty. Any modifications to this product without prior express approval by Banner Engineering Corp will void the product warranties. All specifications published in this document are subject to change; Banner reserves the right to modify product specifications or update documentation at any time. Specifications and product information in English supersede that which is provided in any other language. For the most recent version of any documentation, refer to: [www.bannerengineering.com](http://www.bannerengineering.com).

## FCC Part 15 and CAN ICES-3 (B)/NMB-3(B)

This device complies with part 15 of the FCC Rules and CAN ICES-3 (B)/NMB-3(B). Operation is subject to the following two conditions:

1. This device may not cause harmful interference, and
2. This device must accept any interference received, including interference that may cause undesired operation.

This equipment has been tested and found to comply with the limits for a Class B digital device, pursuant to part 15 of the FCC Rules and CAN ICES-3 (B)/NMB-3(B). These limits are designed to provide reasonable protection against harmful interference in a residential installation. This equipment generates, uses and can radiate radio frequency energy and, if not installed and used in accordance with the instructions, may cause harmful interference to radio communications. However, there is no guarantee that interference will not occur in a particular installation. If this equipment does cause harmful interference to radio or television reception, which can be determined by turning the equipment off and on, the user is encouraged to try to correct the interference by one or more of the following measures:

- Reorient or relocate the receiving antenna.
- Increase the separation between the equipment and receiver.
- Connect the equipment into an outlet on a circuit different from that to which the receiver is connected.
- Consult the manufacturer.