

## 1. PRECAUTION

Please read through this Manual before use the instrument for correct handling. Please keep this Manual carefully after use. This instrument has been thoroughly tested at the factory before shipment. When you receive it, visually inspect it for damage and check the accessories.

① Model number and specification check  
Check to see model number and specifications on the nameplate attached to the front face of the instrument are as ordered.

② Contents of instruction manual  
This instruction manual provides instructions on handling, external wiring and safety use of transmitter.

## 2. GENERAL

This instrument receives contact pulse, voltage pulse or current pulse signals from the field and converts it into isolated current or voltage signal.

Accessories: Mounting block	2
Tag number label	1
Mounting screw M4	4

## 3. MOUNTING METHOD

JUXTA signal conditioners can be mounted on rack, wall or DIN rail.

### 3.1 Rack mounting

Use panel (FRK-16) and install it on an angle as shown in Fig.1. This is a convenient method for high density mounting on 19-inch rack panel.

### 3.2 Wall mounting

Use panel (FRK-16) to mount the transmitter as shown in Fig.2 or directly mount the single unit on the wall. (See Figs.6 and 8 for mounting dimensions.)

### 3.3 DIN rail mounting

Insert DIN rail into the upper section of the DIN rail groove on the rear of transmitter and fix the rail with the slidlock at the base of transmitter as shown in Figs.3 and 4.

### 3.4 Angle mounting

If single unit is mounted without using the panel (FRK-16), refer Fig.5 for its mounting.

### 3.5 Installation and removal of mounting block

Insert mounting block into transmitter groove as shown in Fig.6 and slide it until it is fixed with the stopper. To remove it, lift up the mounting block stopper with (-) screwdriver and slide it along the groove.

## 4. EXTERNAL WIRING

**CAUTION** Wiring should be done after ensuring power break of each cable.

Wires should be connected to M4 screw terminals after opening transmitter terminal cover as shown in Figs.10~12. For wiring, flexible twisted wires and good contact of durable round crimp-on terminals are recommended to be used.

● Signal wiring cable should has more than  $0.5\text{mm}^2$  and power cable should has more than  $1.25\text{mm}^2$  of nominal cross-sectional area of conductor.

### 4.1 Wiring

- ① See Fig.9 for terminal arrangement.
- ② To receive transistor voltage pulse signal from generator, connect input signal cable to transmitter terminals 7(+), 8(-). (See Fig.10)

Fig.1 Rack Mounting

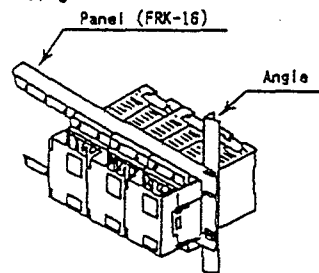

Fig.2 Wall Mounting

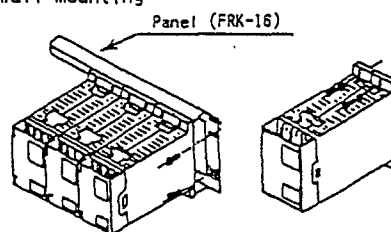

Fig.3 DIN Rail Mounting

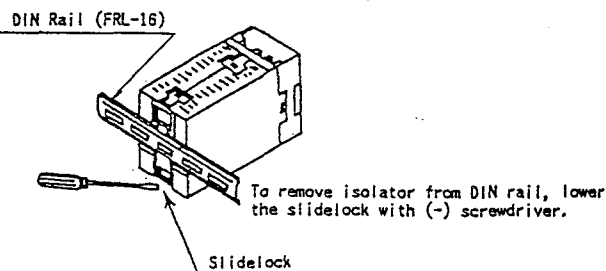

Fig.4 DIN Rail Mounting

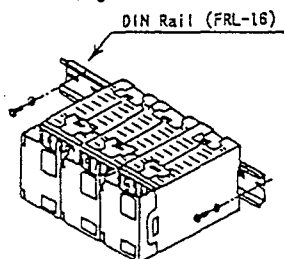
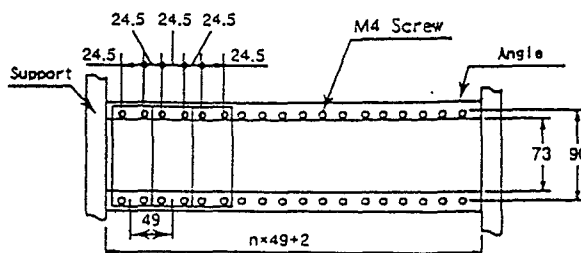

Fig.5 Angle Mounting Dimension

Unit : mm



- ③ To receive dry voltage contact pulse, connect input signal cable to transmitter terminals 7(+), 8(-). (See Fig.11)
  - ④ To receive current pulse, connect input signal cable to transmitter terminals 4(+), 7(-). (See Fig.12)
  - ⑤ Connect transmitter output signal cable to its terminals 11(+) and 12(-).
  - ⑥ When dual outputs, connect Output-2 signal cable to 9(+) and 10(-).
  - ⑦ Connect 85~265V AC or 24V DC power cable to transmitter terminals 14(L+), 15(N-) and 16(G).
- NOTE : Apart wiring of power and input/output cables from noise source. Otherwise, accuracy may not be warranted.

#### 5. INSTALLATION AND HANDLING

- ① Avoid installation in such environments as shock, vibration, corrosive gas, dust, water, oil, solvent, direct sunlight, radiation, powerful electric and magnetic fields.
- ② In order to protect isolator from inducement of thunder surges in power and signal cables, use arrester between transmitter and equipment installed in the field.

#### 6. SAFETY USE

Following caution for safety should be taken for handling of instrument. We are not responsible for damage incurred by use contrary to caution.

##### CAUTION

- Following items should be checked when turning power on. Use of instrument by ignoring the specifications may cause overheat or burning.
  - (a) Voltage of power supply and input value be applied to the instrument should meet with required specifications.
  - (b) External wiring to terminals should be connected correctly. (See preceding Article 4)
- Do not use the instrument in such dangerous places where exist inflammable and explosive gas or steam.
- In case of AC power supply, high voltage of 85~264V AC would be applied to 14 and 15 terminals during power on as shown in Fig.9. Do not touch terminals when zero and span adjustment.

Fig.6 Mounting Block installation and removal

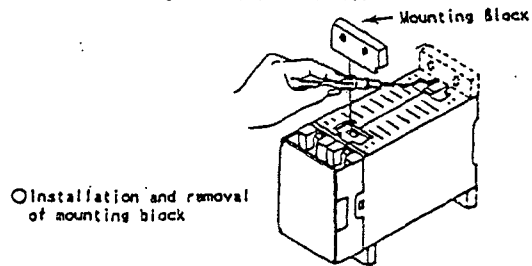

Fig.7 Rack Mounting Dimension

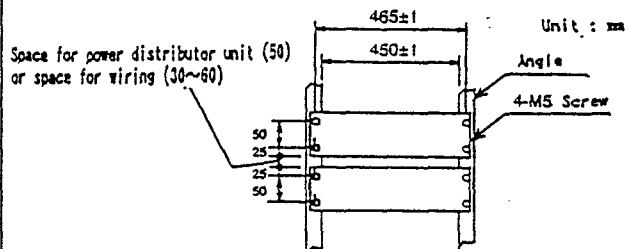

Fig.8 Panel (Wall) Mounting Dimension

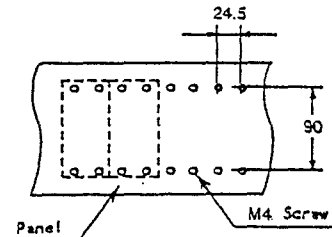
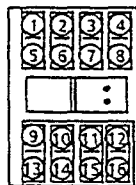

Fig.9 Terminal Arrangement



4	INPUT	(PS+)
7	INPUT	(+)
8	INPUT	(-)
9	OUTPUT-2	(+)
10	OUTPUT-2	(-)
11	OUTPUT-1	(+)
12	OUTPUT-1	(-)
13		
14	SUPPLY	(L+)
15	SUPPLY	(N-)
16	GND	(G)

## 7. CALIBRATION

Carry out the following calibration after warming up the instruments for more than 10~15 minutes.

### 7.1 Calibration equipment

- Pulse Generator 1  
(Hewlett-Packard Model 3314A or equivalent)
- Counter 1  
(Hewlett-Packard Model 5334B or equivalent)
- Voltmeter 1  
(Yokogawa Model 7552B or equivalent)
- Precision Resistor  $250\Omega \pm 0.01\%$  1W 1  
(Use for current output)

### 7.2 Calibration

- ① Connect each equipment as shown in Fig.13.
- ② Input/output characteristics check  
Apply input pulse equivalent 0, 25, 50, 75, 100% of span to transmitter through Pulse Generator.  
Check the corresponding transmitter outputs are 0, 25, 50, 75 and 100% respectively and are within accuracy rating range.
- If output signal is out of tolerance, adjust it through span and zero adjustment trimmer on front face of transmitter.

Fig.10 Wiring Diagram 1

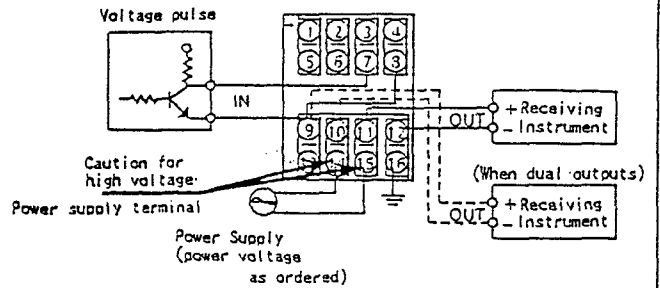

Fig.11 Wiring Diagram 2

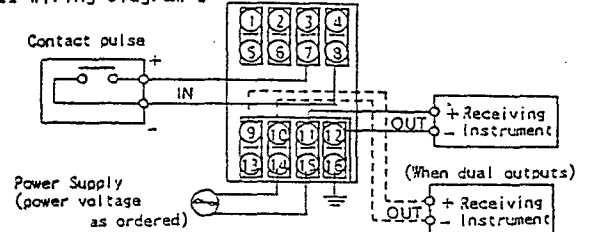

Fig.12 Wiring Diagram 3

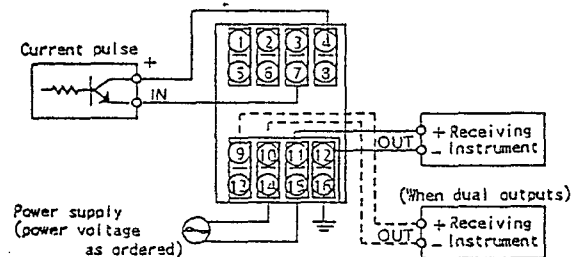
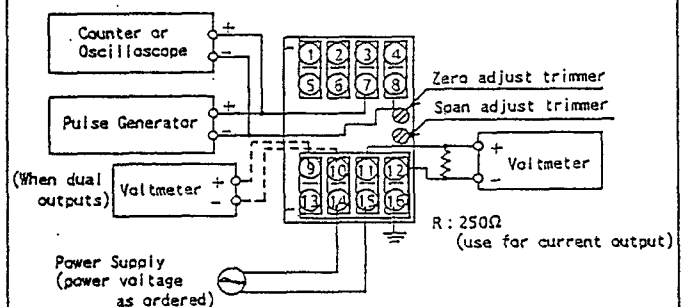

Fig.13 Wiring of Calibration Equipment



Subject to change without notice for grade up quality and performance.

---

**YOKOGAWA**   
Yokogawa Electric Corporation

Network Solutions Business Division  
2-9-32, Nakacho Musashino-shi, Tokyo, 180-8750 Japan  
Phone: (81)-422-52-7179 Fax: (81)-422-52-6793