

# Drawings

# 30031A Leakage Clamp-on Tester

## <Dimensions>

Unit: mm  
(approx. inch)

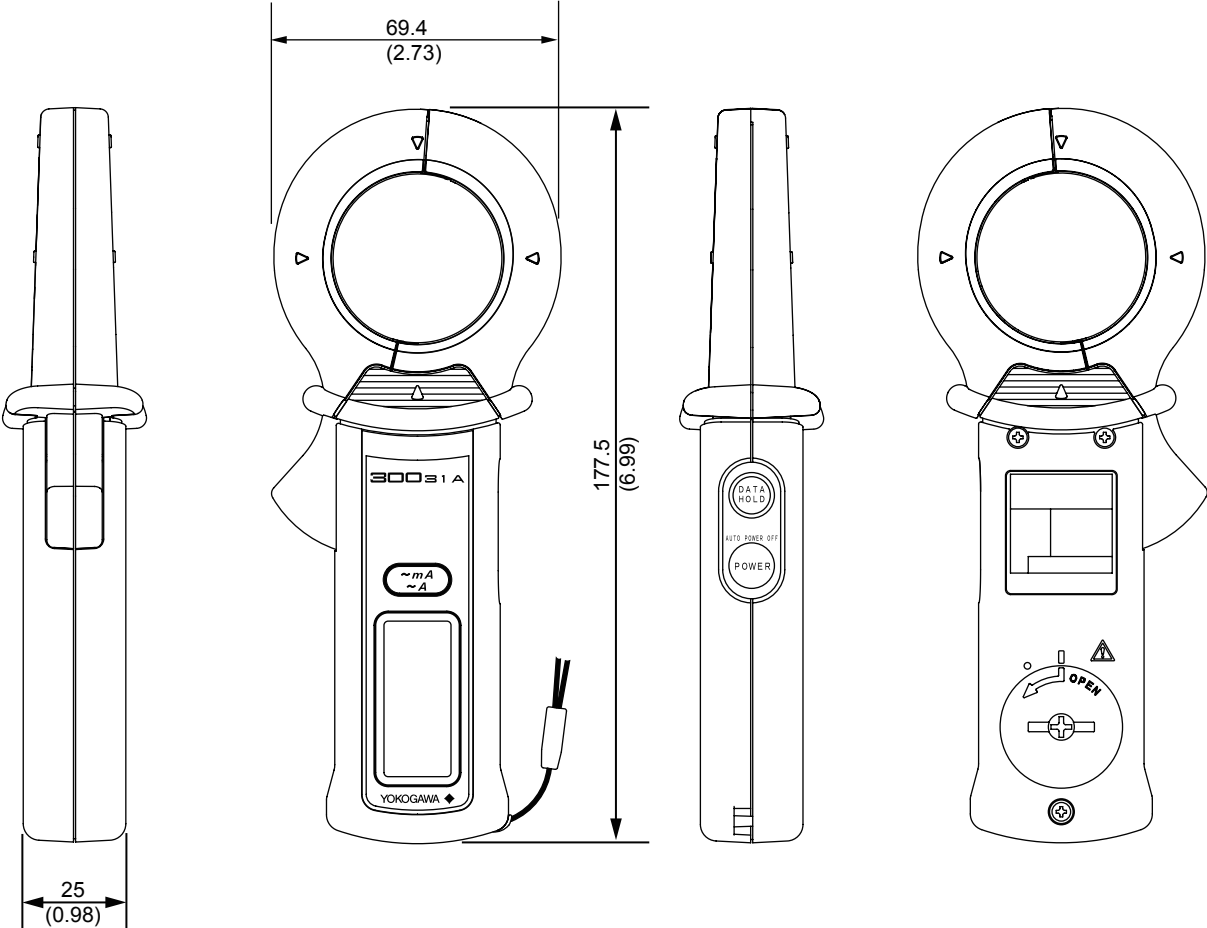

Weight: approx. 200g  
(including a battery)

General Tolerance = ± (ISO 286-1, IT18) /2