

GS 77J01E11-02E

■ General

The VJET is a compact, plug-in type communication converter. It connects with host device having an Ethernet communication function by Modbus/TCP protocol, and connects with instrument having an RS-485 communication function by Modbus/RTU protocol.



■ Model and Suffix Codes

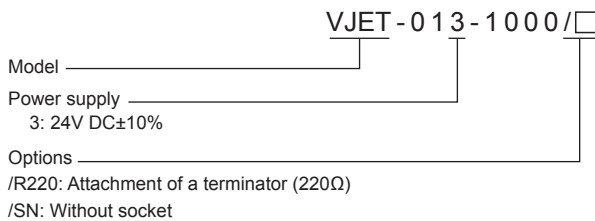

■ Items to be Specified when Ordering

- Model and Suffix Codes: e.g. VJET-013-1000
- Factory Setting:
 - High-speed response mode: 0 (OFF)
 - Parity: Even
 - IP address: 192.168.1.1
 - Subnet mask: 255.255.255.0
 - Default gateway: 0.0.0.0
 - Port number: 502

■ Communication Specifications

● Ethernet Specifications

Interface: Conforms to IEEE802.3 (10BASE-T/100BASE-TX)
Port number for Modbus/TCP protocol: 502 (default)

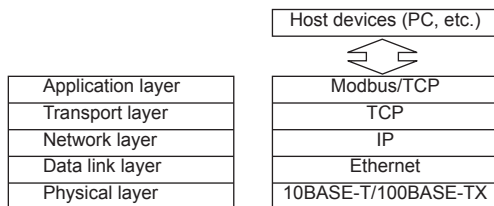

Access control: CSMA/CD
Transfer rate: 10 Mbps or 100 Mbps
Maximum segment length: 100 m (the length between Hub and converter)
Maximum connecting configuration: Up to 4 cascade connections per hub (10BASE-T), up to 2 cascade connections per hub (100BASE-TX)

Communication parameter settings:

Set the high-speed response mode, parity, IP address, subnet mask, default gateway and port number via Ethernet using the dedicated tool.

Modbus/TCP Functions:

Code Number	Function
03	Reads data from multiple registers
06	Writes data to registers
08	Loop back test
16	Writes data to multiple registers

For details, refer to the Communication Functions user's manual of each connection device.

High-speed response mode: This mode improves the response performance of the RS-485 connection devices, and can be set to a maximum of eight devices using the dedicated tool.

● RS-485 Specifications

Interface: Conforms to EIA RS-485
Protocol: Modbus/RTU
Transfer system: Half-duplex communication
Synchronous system: Start-stop synchronization
Transfer rate: 9600 bps
Parity: Even, odd or none
Stop bit: 1 bit
Data length: 8 bit

■ Power Supply and Isolation

Power Supply Rated Voltage: 24 V DC ∴
Power Supply Input Voltage: 24 V DC ∴ (±10%)
Power consumption:
1.8 W at 24 V DC
Insulation resistance: 100 MΩ minimum at 500 V DC between Ethernet, RS-485, power supply and grounding terminals mutually
Withstanding voltage: 1000 V AC for one minute between Ethernet and RS-485 terminals mutually
2000 V AC for one minute between (Ethernet, RS-485), power supply, and grounding terminals mutually

■ Safety and EMC Standards

- Safety: Approved by CAN/CSA C22.2 No.61010-1(CSA), approved by UL61010-1.
Installation category: CAT. II
Pollution degree: 2
Device is to be connected to a class 2 circuit only.

Category	Description	Remarks
CAT.I	For measurements performed on circuits not directly connected to MAINS.	
CAT.II	For measurements performed on circuits directly connected to the low voltage installation.	Appliances, portable equipments, etc.
CAT.III	For measurements performed in the building installation.	Distribution board, circuit breaker, etc.
CAT.IV	For measurements performed at the source of the low-voltage installation.	Overhead wire, cable systems, etc.

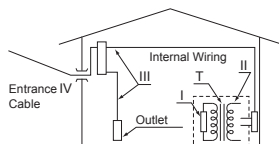

- EMC Standards:
Compliant with CE marking EN 61326-1.
KC marking: Electromagnetic wave interference prevention standard, electromagnetic wave protection standard compliance.

■ Environmental Conditions

- Operating temperature range: 0 to 50°C (Note)
- Operating humidity range: 5 to 90% RH (no condensation)
- Ambient Condition: Avoid installation in such environments as corrosive gas like sulfide hydrogen, dust, sea breeze and direct sunlight. Installation altitude 2000m or less above sea level.
- (Note) When using the VJET for side-by-side multiple mounting, mount the VJET in either the left or right end of the mounted instruments.

■ Mounting and Appearance

- Material: Modified Polyphenylene Oxide (Case body)
- Mounting Method: Wall, DIN rail, or dedicated VJ mounting base mountings (VJCE-01A)
- Connection Method: M3 screw terminal
- External Dimension: 76 (H)x29.5 (W)x124.5 (D) mm (including a socket)
- Weight: Approx. 120 g (main unit), approx. 51 g (socket)

■ System Configuration

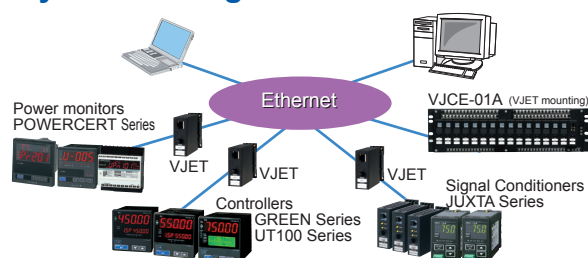

■ Accessories

- Tag number label: One
- Terminator (220 Ω): One (When option code "/R220" is specified)

■ Terminal Assignments

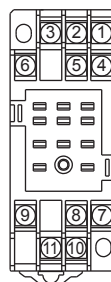

1	N.C.
2	RS-485 (B1)
3	N.C.
4	N.C.
5	RS-485 (A2)
6	RS-485 (COM)
7	N.C.
8	GND
9	N.C.
10	Supply (L1)
11	Supply (N2)

■ Block Diagrams

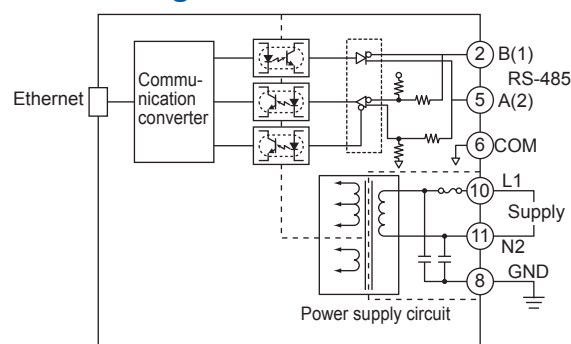

■ Link LED and Activity LED

The VJET has Link LED (lower side) and Activity LED (upper side) on the connector part of the front. These LEDs turn on in green or amber. (See the External Dimensions.)

Link LED (Lower side)		Activity LED (Upper side)	
Color	Meaning	Color	Meaning
Off	No Link	Off	No Activity
Amber	10 Mbps	Amber	Half-Duplex
Green	100 Mbps	Green	Full-Duplex

External Dimensions

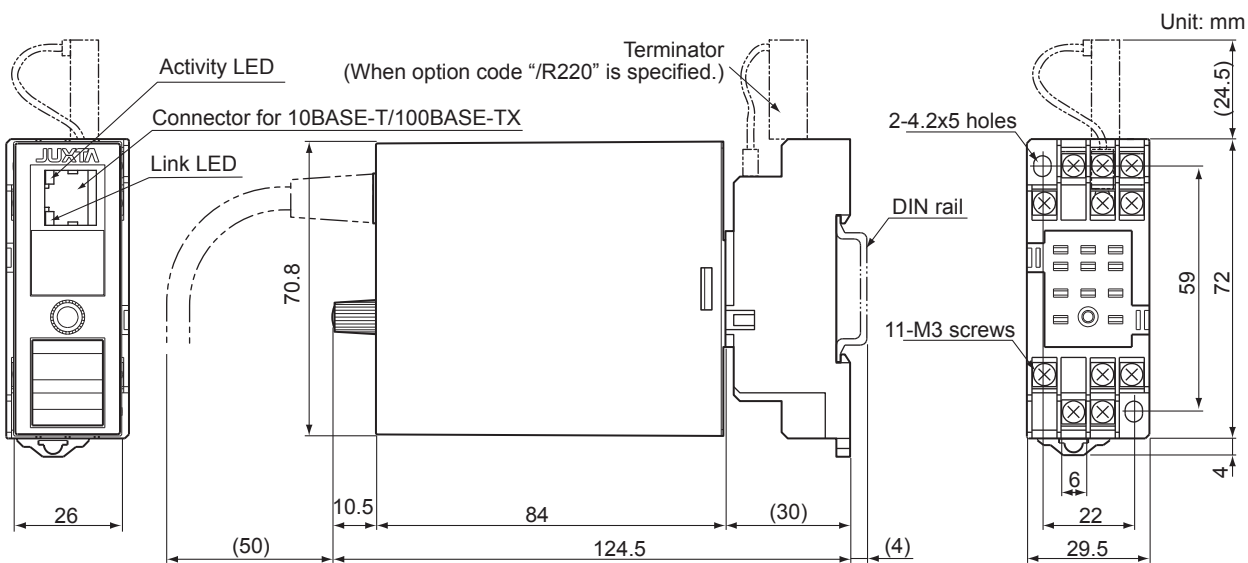

• The information covered in this document is subject to change without notice for reasons of improvements in quality and/or performance.