

XS/SC26-2 Safety Controller

Quick Start Guide



About this Guide

This guide is designed to help you create a sample configuration for the XS/SC26-2 Safety Controller using the **XS26-2 Expandable Safety Controller** PC Interface. For complete information on mounting, device installation and operation, commissioning checkout procedures, product specifications, troubleshooting, and glossary, please refer to the Safety Controller Instruction Manual (p/n 174868) and support documentation for individual safety input and output devices. Use of this document assumes familiarity with pertinent safety standards and practices as outlined in the Instruction Manual.

Product Overview

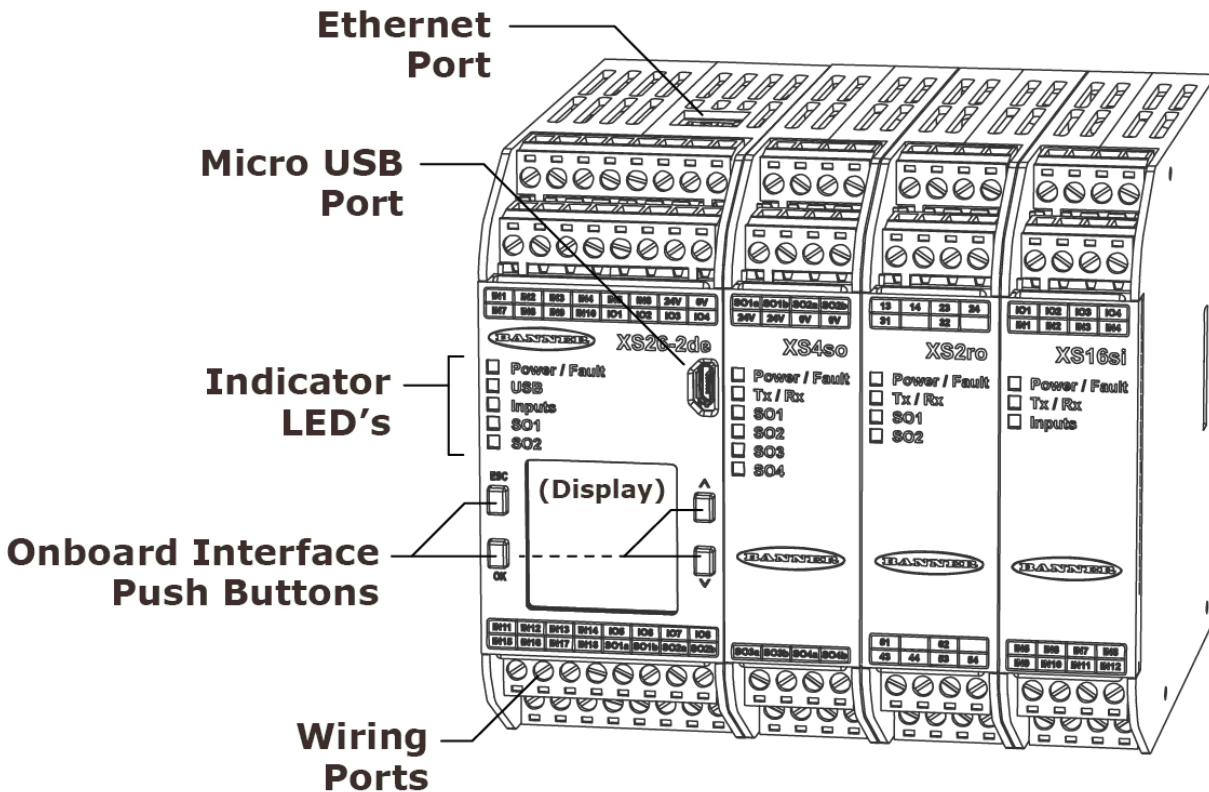

Designing a Sample Configuration

The configuration process used in this guide provides basic understanding of the software features that are necessary to create a configuration for any application. The example configuration is based on a sample application which makes use of the following devices: an XS/SC26-2 Safety Controller, an E-stop button, a Safety Light Curtain, an Interlocked Gate Switch, and a Manual Reset. The illustration below depicts these devices and additional safety equipment for a sample Robotic Cell application.

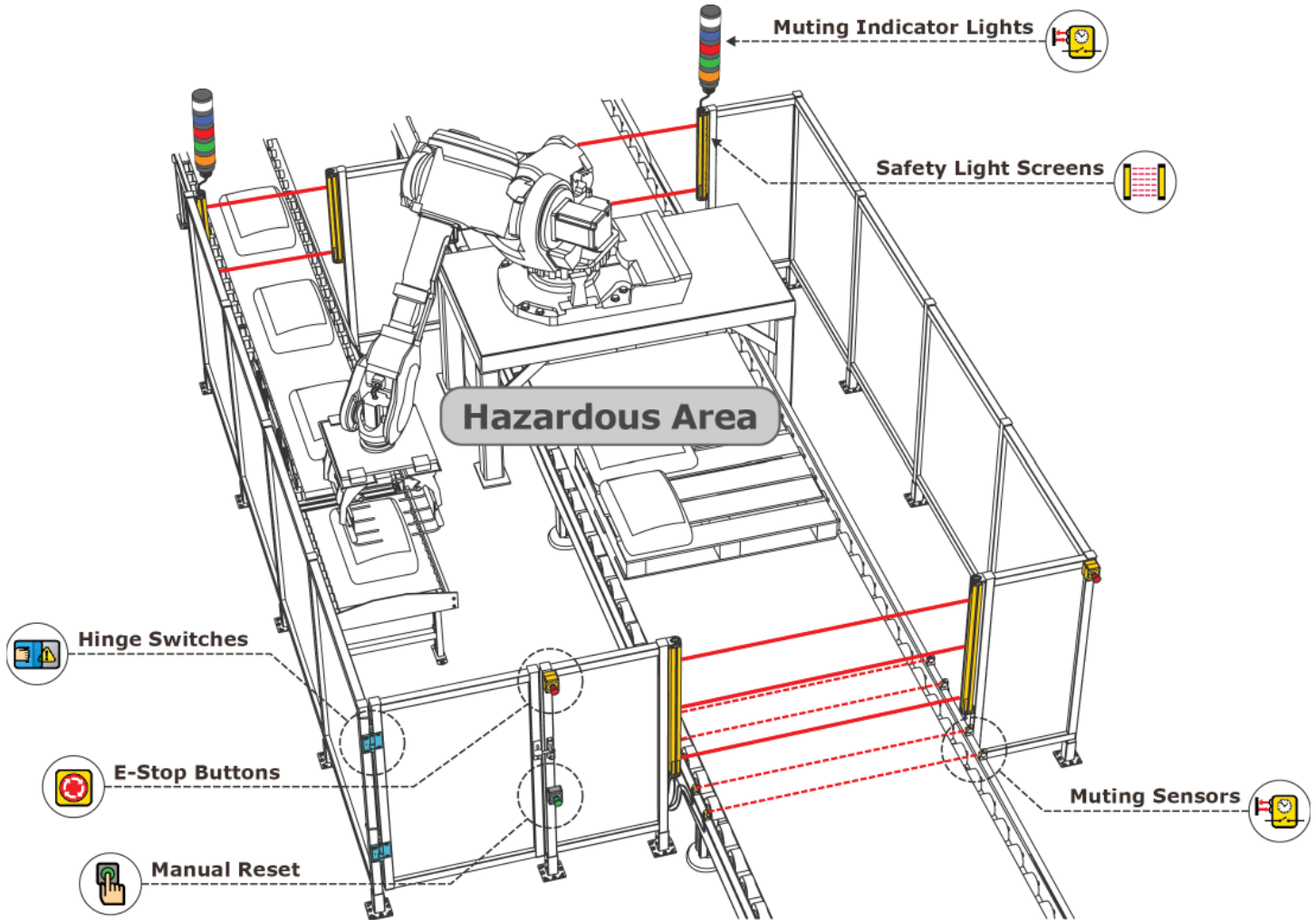

Software Installation

System Requirements	
Operating system:	Microsoft Windows XP Service Pack 3, Windows Vista, Windows 7, Windows 8 (except Windows RT), or Windows 10 ¹
System Type:	32-bit, 64-bit
Hard drive space:	80 MB (plus up to 280 MB for Microsoft .NET 4.0, if not already installed)
Memory (RAM):	512 MB minimum, 1 GB+ recommended
Processor:	1 GHz minimum, 2 GHz+ recommended
Screen Resolution:	1024x768 full color minimum, 1650x1050 full color recommended
Third-party software:	Microsoft .NET 4.0 (included with installer), PDF Viewer (such as Adobe Acrobat)
USB port:	USB 2.0

The XS26-2 Expandable Safety Controller PC Interface can be downloaded from www.bannerengineering.com/xs26.

Important: Administrative rights are required to install the Safety Controller drivers (needed for communication with the controller).

To install the software from the Banner Engineering website:

1. Download the latest version of the software from www.bannerengineering.com/xs26.
2. Navigate to and open the downloaded file.
3. Click **Next** to begin the installation process.
4. Confirm the software destination and availability for users and click **Next**.
5. Click **Next** to install the software.
6. Depending on your system settings, a popup window may appear prompting to allow XS26-2 Expandable Safety Controller to make changes to your computer. Click **Yes**.
7. Click **Close** to exit the installer.

Open **XS26-2 Expandable Safety Controller** from the **Desktop** or the **Start Menu**.

¹ Windows is a registered trademark of Microsoft Corporation in the United States and/or other countries.

Designing a Configuration

Open XS26-2 Expandable Safety Controller from the Desktop or the Start Menu.

PC Interface Features

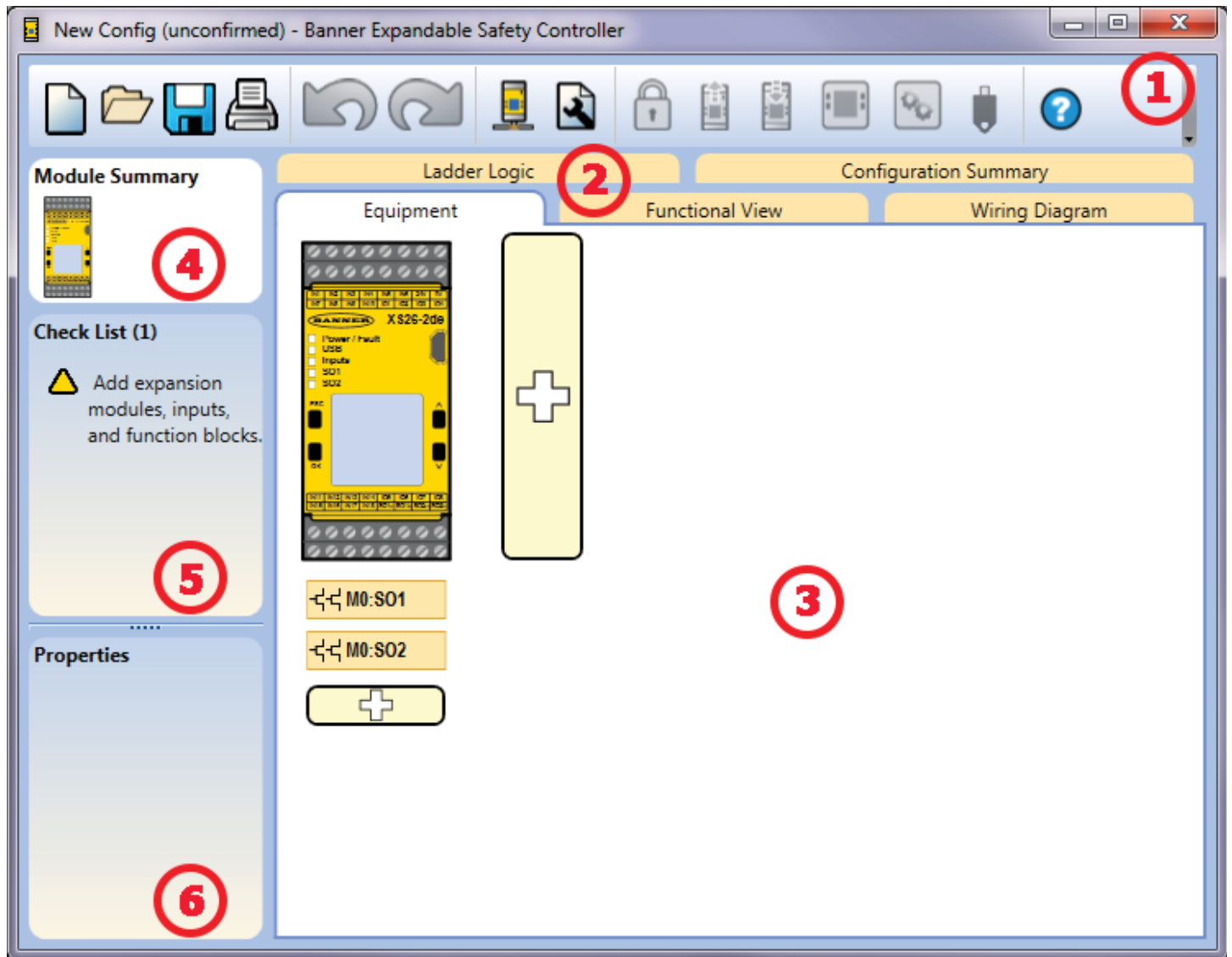



1 Navigation Toolbar

 Starts a New Project or opens a Recent project and Sample Configurations

 Opens an existing project

 Saves (or Saves As) the project to the user-defined location

 Prints a customizable Configuration Summary

 Reverts up to ten previous actions

 Re-applies up to ten previously reverted actions

 Displays Network Settings

 Displays Project Settings

 Displays Password Manager

 Reads data, such as Fault Log, Configuration, Network Settings, and Device Information, from the Safety Controller

 Writes the data, such as Configuration and/or Network Settings, to the Safety Controller

 Makes the Live Mode view available

 Makes the Simulation Mode View available

 Indicates SC-XM2 drive connection

 Opens the Help options

2 Tabs

- **Equipment**—displays an editable view of all connected equipment.
- **Functional View**—provides an editable iconic representation of the control logic.
- **Wiring Diagram**—displays the I/O device wiring detail for use by the installer.
- **Ladder Logic**—displays a symbolic representation of the Controller's safeguarding logic for the use by the machine designer or controls engineer.
- **Industrial Ethernet (when enabled)**—displays editable network configuration options.
- **Configuration Summary**—displays a detailed configuration summary.
- **Live Mode (when enabled)**—displays the live mode data, including current faults.
- **Simulation Mode (when enabled)**—displays the simulation mode data

3 Selected view

Displays the view corresponding to the selected tab (**Equipment** view shown).

4 Module Summary

Displays the Base Controller and any connected modules.

5 Checklist

Provides action items to configure the system and correct any errors to successfully complete the configuration.

6 Properties

Displays the properties of the selected device, function block, or connection (properties cannot be edited in this view, click Edit to make changes).

Define the Project Settings

Click **Project Settings**.



Enter the information about the project:

Configuration Name

Name of the configuration; displayed on the controller (models with display); different from file name.

Project

Project name is useful for distinguishing between various application areas.

Author

Person designing the configuration.

Notes

Supplemental information for this configuration or project.

Project Date

Date pertaining to the project.

Project Settings

Configuration Name: New Config

Project: New Project

Author:

Notes:

Project Date: 6/2/2014

OK Cancel

Add Equipment

1. On the **Equipment** view select your Base Module properties (Display, Industrial Ethernet, Expandability) by either double-clicking the module or clicking the **Edit** under the properties table when the module is selected.

Module Properties

Has Display

Has Industrial Ethernet

Is Expandable

OK Cancel

2. Add **Safety Input** devices by clicking  under the Base Module:
 - **Emergency Stop**
 - **Gate Switch**
 - **Optical Sensor**

Note: For the purpose of this configuration default device properties are used.

Add Equipment

Safety Input

Emergency Stop

Gate Switch

Optical Sensor

Two-Hand Control

Safety Mat

Protective Stop

External Device Monitoring

Rope Pull

Enabling Device

Muting Sensor Pair

Bypass Switch

Adjustable Valve Monitor

OK Cancel

3. Add **Non-Safety Inputs** by clicking  under the Base Module:
 - Manual Reset



Create Connections

4. Go to **Functional View**.

Note: The **Check List** on the left lists any missing connections that need to be added before the configuration is valid.

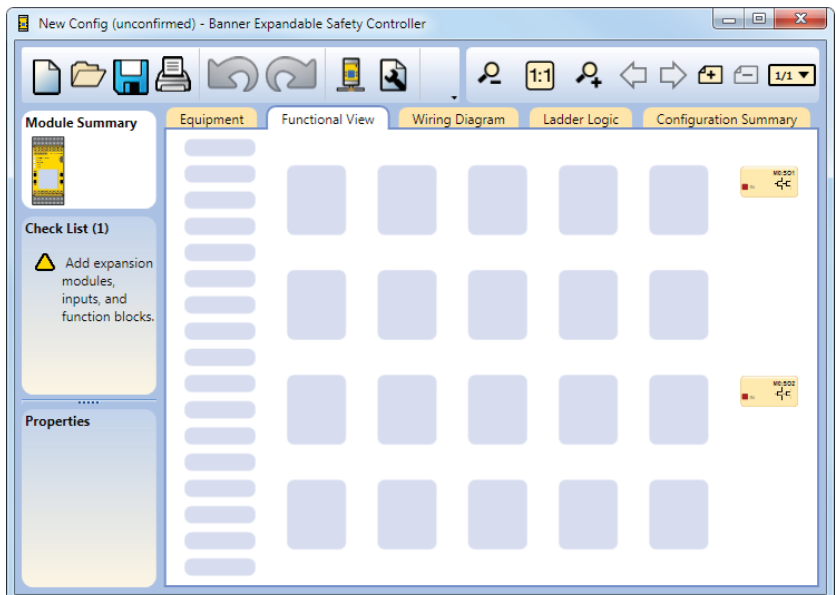
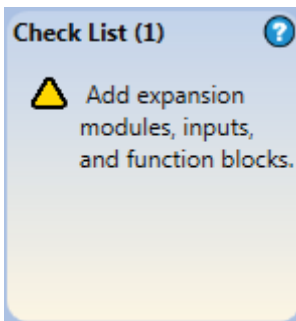

5. Add the **Function Blocks** by clicking on one of the empty placeholders in the middle area:
 - Latch Reset Block

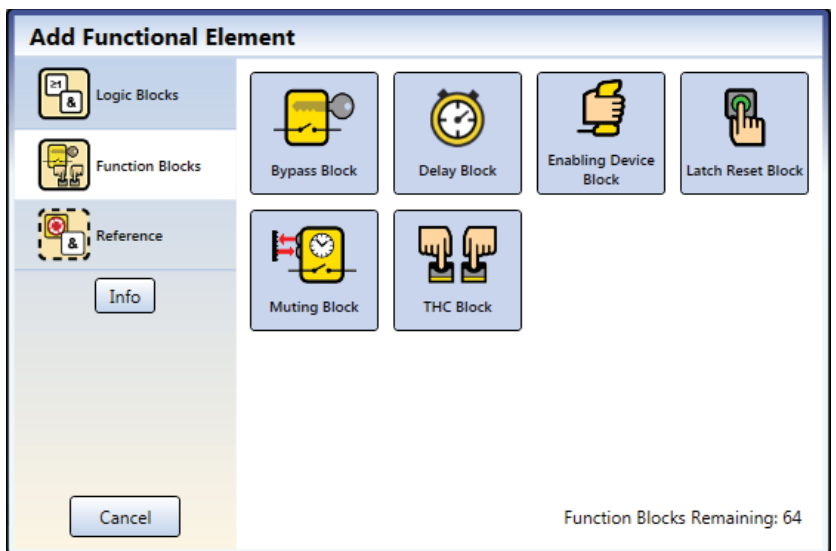

6. Add **Logic Blocks** by clicking on one of the empty placeholders in the middle area:
 - **And**

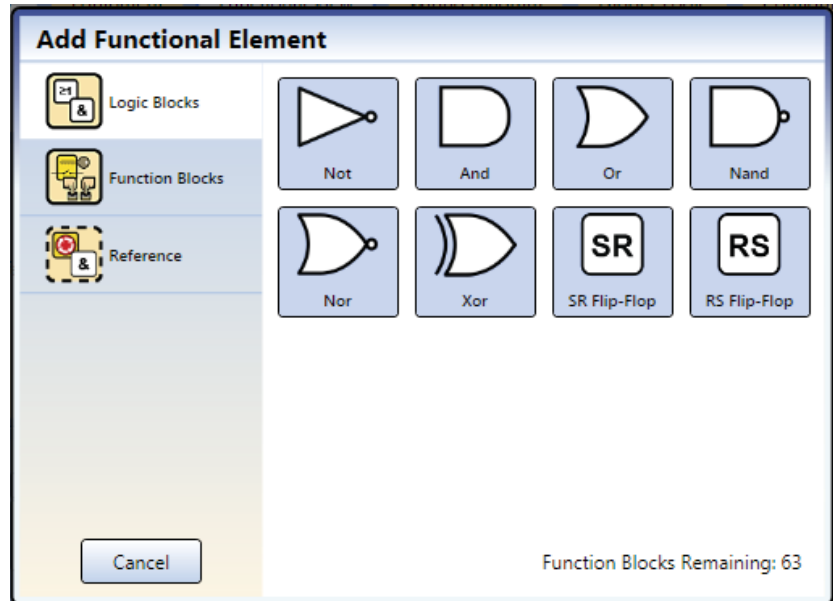

7. For this configuration, increase the number of **Input Nodes** to "3".

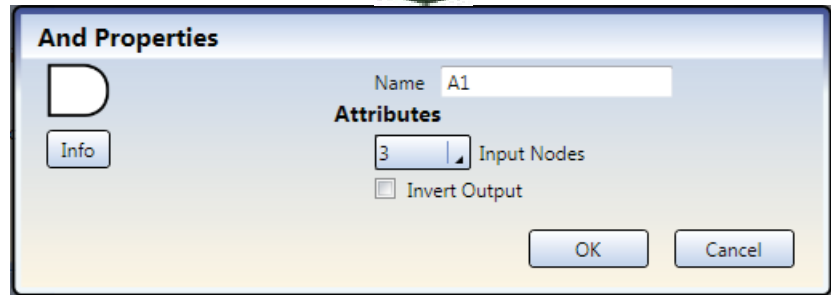

8. Connect **Optical Sensor, Gate Switch, and Latch Reset Block** to one of the input nodes on the **AND** block.
9. Connect **Emergency Stop and Manual Reset** to the **Latch Reset Block**.
10. Connect the **AND** block to the **Solid State Output (SO1)**.

Note: You may re-arrange any of the Equipment blocks or Functional Elements blocks for a better visual representation of the connections. Solid State Output blocks cannot be moved.

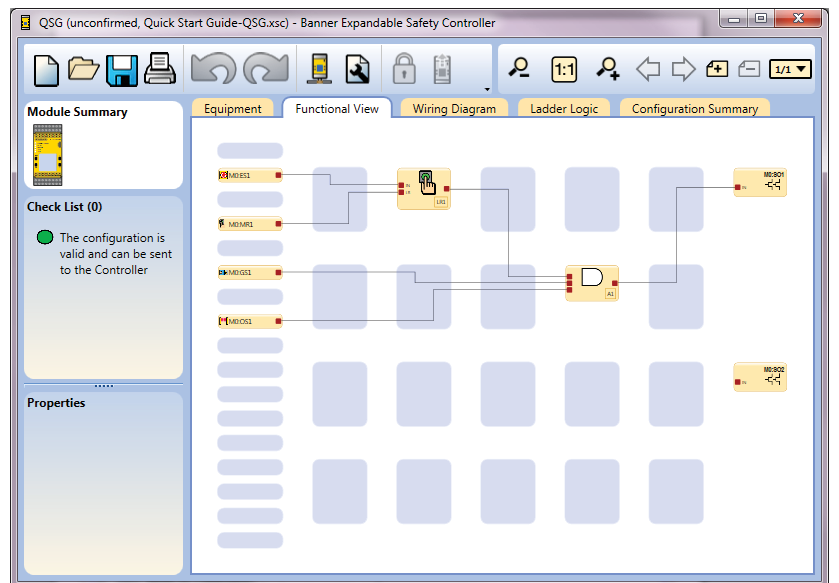

Save the Configuration

1. Click **Save**.
2. Select **Save As**.
3. Navigate to the folder where you wish to save your configuration.
4. Name the file (may be the same or different from the Configuration name).
5. Click **Save**.



Confirm the Configuration

1. Power the Safety Controller and connect it to the PC using the appropriate USB cable.
2. Click **Send to Controller**.
3. Enter the password (the default password is 1901).
4. Click **Continue** to enter the config-mode.
5. After the **Reading Configuration from the Controller** process is completed, the **Confirm Configuration** screen opens. Verify that the configuration is correct.
6. Scroll to the end of the configuration and click **Confirm**.
7. After the **Send Configuration To Controller** process has completed, click **Close**.
8. Reset the Safety Controller for the changes to take effect.



You have completed the sample configuration.



It is the responsibility of the Qualified Person who configures, installs, or maintains the XS26-2 Safety Controller to:

- Carefully read, understand, and follow the information in the XS26-2 manual (which can be accessed via the drop-down Help menu of the PC Interface)
- Perform a risk assessment of the specific machine guarding application
- Determine what safeguarding devices and methods are appropriate per the requirements defined in ISO 13849-1 and those referenced in the XS26-2 manual
- Create and confirm each XS26-2 configuration and then verify that the entire safeguarding system (including input devices and output devices) is operational and working as intended
- Periodically re-verify, as needed, that the entire safeguarding system is working as intended

Failure to follow any of these recommendations may potentially create a dangerous condition that may lead to serious injury or death.

Banner Engineering Corp Limited Warranty

Banner Engineering Corp. warrants its products to be free from defects in material and workmanship for one year following the date of shipment. Banner Engineering Corp. will repair or replace, free of charge, any product of its manufacture which, at the time it is returned to the factory, is found to have been defective during the warranty period. This warranty does not cover damage or liability for misuse, abuse, or the improper application or installation of the Banner product.

THIS LIMITED WARRANTY IS EXCLUSIVE AND IN LIEU OF ALL OTHER WARRANTIES WHETHER EXPRESS OR IMPLIED (INCLUDING, WITHOUT LIMITATION, ANY WARRANTY OF MERCHANTABILITY OR FITNESS FOR A PARTICULAR PURPOSE), AND WHETHER ARISING UNDER COURSE OF PERFORMANCE, COURSE OF DEALING OR TRADE USAGE.

This Warranty is exclusive and limited to repair or, at the discretion of Banner Engineering Corp., replacement. **IN NO EVENT SHALL BANNER ENGINEERING CORP. BE LIABLE TO BUYER OR ANY OTHER PERSON OR ENTITY FOR ANY EXTRA COSTS, EXPENSES, LOSSES, LOSS OF PROFITS, OR ANY INCIDENTAL, CONSEQUENTIAL OR SPECIAL DAMAGES RESULTING FROM ANY PRODUCT DEFECT OR FROM THE USE OR INABILITY TO USE THE PRODUCT, WHETHER ARISING IN CONTRACT OR WARRANTY, STATUTE, TORT, STRICT LIABILITY, NEGLIGENCE, OR OTHERWISE.**

Banner Engineering Corp. reserves the right to change, modify or improve the design of the product without assuming any obligations or liabilities relating to any product previously manufactured by Banner Engineering Corp. Any misuse, abuse, or improper application or installation of this product or use of the product for personal protection applications when the product is identified as not intended for such purposes will void the product warranty. Any modifications to this product without prior express approval by Banner Engineering Corp will void the product warranties. All specifications published in this document are subject to change; Banner reserves the right to modify product specifications or update documentation at any time. Specifications and product information in English supersedes that which is provided in any other language. For the most recent version of any documentation, refer to: www.bannerengineering.com.

