

# Instruction Manual

WX1□-PH (Voltage Input·Soft Variable Type)  
 WX2□-PH (V/Contact Input·Soft Variable Type)  
 WX3□-PH (mV Input·Soft Variable Type)  
 WX4□-PH (mV/Contact Input·Soft Fixed Type)  
**Peak Holder**

JUXTA

## 1. INSPECTION

This instrument has been thoroughly tested at the factory before shipment. When you receive it, visually inspect it for damage and check the accessories.

1.1 Model number and specification check  
 Check to see the model number and specifications on the nameplate attached to the front cover of the unit are as ordered.

1.2 Contents of the instruction manual  
 This instruction manual provides instructions on mounting, external wiring and maintenance.

## 2. GENERAL

2.1 Soft variable type (WX1□, WX3□)  
 This unit receives voltage or mV signal from transmitter and outputs isolated current or voltage signal holding its peak value. Holding operates when hold instruction input (INPUT 2) is more than 75%.

2.2 Soft variable type (WX2)  
 Soft fixed type (WX4□)  
 This unit receives voltage or mV signal from transmitter and outputs isolated current or voltage signal holding its peak value. Holding operates when hold instruction input (INPUT 2) is OFF (Open).

Accessories:

Mounting block	2
Tag number and range label	1 each
Mounting screw M4	4

## 3. MOUNTING METHOD

JUXTA signal conditioners can be mounted on rack, wall or DIN rail.

3.1 Rack mounting  
 Use panel (FRK-16) and install it on an angle as shown in Fig.1. This is a convenient method for high density mounting of the unit on 19-inch rack panel. (See Fig. 6)

3.2 Wall mounting  
 Use panel (FRK-16) to mount the unit as shown in Fig. 2 or directly mount it on the wall (See Figs. 6 and 7 for mounting dimensions)

3.3 DIN rail mounting  
 Insert DIN rail into the upper of DIN rail groove on the rear of the unit and fix the rail with the slidelock at the lower of the unit as shown in Fig. 3.

3.4 Angle mounting  
 In case of single unit mounting, refer to Fig. 5 for its mounting.

3.5 Mounting block installation and removal  
 Insert mounting block into the groove of the unit as shown in Fig. 4 and slide it until it is locked with the stopper. To remove it, lift up the mounting block stopper with screwdriver (-) and slide it along the groove.

## 4. EXTERNAL WIRING

Open the terminal cover of the unit. Wire should connect to M4 screw terminal. Flexible twisted wires and durable round crimp-on terminals (JIS C2805) are recommended to be used.

● Signal cable having more than 0.5mm<sup>2</sup> and power cable having more than 1.25mm<sup>2</sup> of nominal cross-sectional area of conductor are recommended.

Fig.1 Rack Mounting

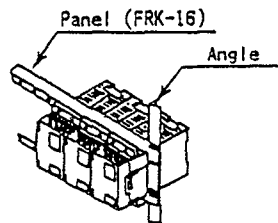

Fig.2 Wall Mounting

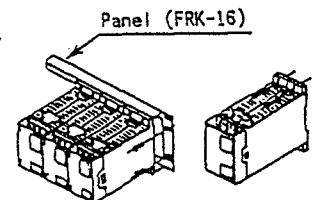

Fig.3 DIN Rail Mounting

Use (-) screwdriver and lower the slidelock to remove the unit from DIN rail

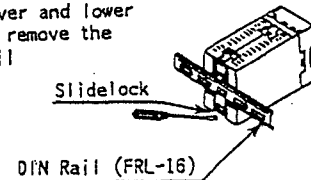

Fig.4 Mounting Block installation and removal

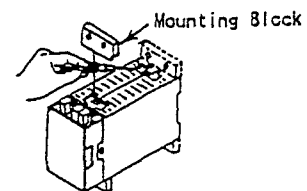

Fig.5 Angle Mounting Dimension

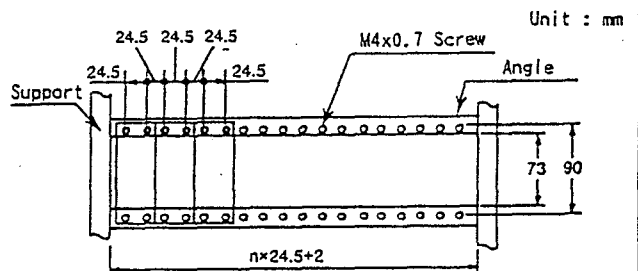

Fig.6 Rack Mounting Dimension

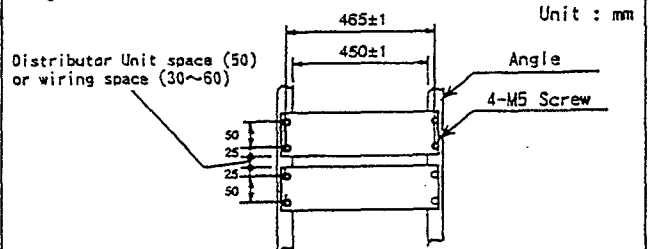
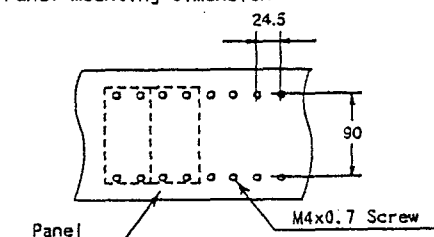

Fig.7 Panel Mounting Dimension



#### 4.1 Wiring

- ① See Fig. 8 for terminal arrangement.
- ② As for soft variable type, connect input voltage signal cable to terminals 3(+), 4(-), 7(+), 8(-) of the unit. As for soft fixed type, connect input voltage signal cable to 7(+), 8(-) and input contact cable to 3(+) and 4(-). (Figs. 9 & 10)
- ③ Connect output signal cable of the unit to its terminals 11(+) and 12(-).
- ④ In case of use AC power, connect AC power cable to terminals 14(L), 15(N), 16(G). In case of use DC power, connect DC power cable to terminals 14(+), 15(-). (See Figs. 9 & 10)

#### 5. ITEMS TO BE CHECKED BEFORE TURNING THE POWER SWITCH ON

- ① Make sure that 24V DC power cable of the unit is connected to the correct polarities (+), (-).
  - ② Confirm that the external wiring to the terminal board is correct.
  - ③ Check that the mounting, ambient temperature, humidity, dust and vibration are normal.
- Confirm the above items before turning the power on. The unit needs 5 minutes warmup to meet its specified accuracy level.

#### 6. OPERATION CHECK

(Caution)

Carry out the following calibration after warming up the instruments for more than 5 minutes.

##### 6.1 Calibration equipment

- Voltage/Current Generator (Yokogawa Model 7651 or equivalent) 1
- Voltmeter (Yokogawa Model 7551 or equivalent) 1

##### 6.2 Check method

- ① Connect each equipment as shown in Figs. 11 and 12.
  - ② Input/output characteristic check  
Make hold instruction input less than 25% (Fig. 11) or ON (Close) (Fig. 12). Use Voltage/Current Generator and apply signal equivalent 0, 25, 50, 75 and 100% of input span to Ch1. Check that corresponding outputs are within specified accuracy rating range of respective output reference values.
  - ③ Peak hold function check  
Make hold instruction input more than 75% (Fig. 11) or OFF (Open) (Fig. 12). Check to see the output corresponds to peak value of input thereafter.
- If output signal is out of tolerance in case of ②, adjust it with Handy Terminal (JHT-100 or JHT200). For adjustment, refer Instruction Manuals of Handy Terminal. (JHT200 : IM JF81-02E, JHT-100 : IM JF81-01E)

#### 7. SET VALUE INPUT THROUGH HANDY TERMINAL

As for soft variable type, input range can be changed through Handy Terminal. Make Handy Terminal to SET mode, and set voltage corresponding 0% input on ZERO (B10) and span voltage on SPAN (B11).

Fig.8 Terminal Arrangement

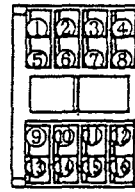

TML	
3	INPUT (ch2) +
4	INPUT (ch2) -
5	
6	
7	INPUT (ch1) +
8	INPUT (ch1) -
9	
10	
11	OUTPUT +
12	OUTPUT -
13	
14	SUPPLY L+
15	SUPPLY N-
16	GND

Fig.9 Wiring Diagram (Soft Variable Type)

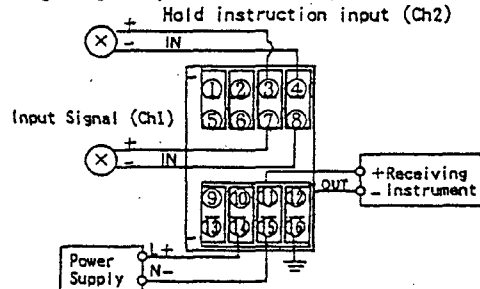

Fig.10 Wiring Diagram (Soft Fixed Type)

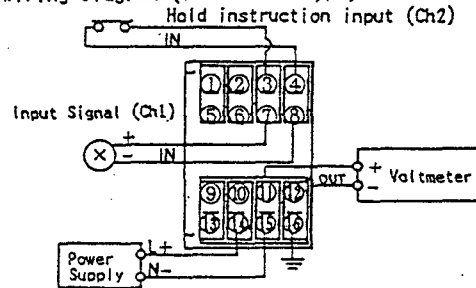

Fig.11 :Wiring of Calibration Equipment (Soft Variable Type)

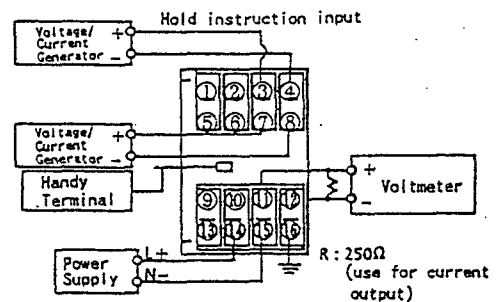

Fig.12 Wiring of Calibration Equipment (Soft Fixed Type)

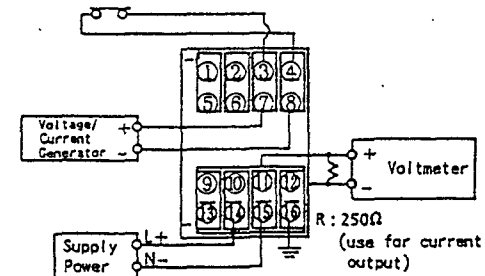
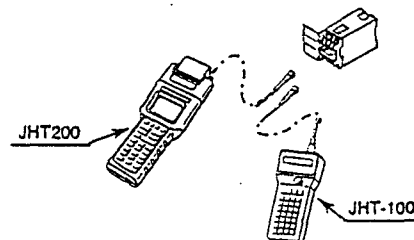

Fig.13 Connection to Handy Terminal



PARAMETER LIST

NO.	ITEM	TITLE DISPLAY	DATA DISPLAY
01	Model	MODEL	□□□□*□
02	Tag No.	TAG NO	16 Alphanumerics
03	Self Check	SELF CHK	Good or Error
A00	Display Item	DISPLAY	
A01	Input 1	INPUT 1	□□□□.□V/mV
A02	Output	OUTPUT	□□□.□%
A03	Status	STATUS	FF (Hexagonal 2 digits)
A04	Rev No.	REV NO	n.nnn (n : Rev No.)
A05	Load	LOAD	□□□.□%
A06	Input 2	INPUT 2	□□□□.□V/mV
A07	Buffer 1	BUFFER 1	□□□.□%
A08	Buffer 2	BUFFER 2	□□□.□%
A09	Buffer 3	BUFFER 3	□□□.□%
800	Set Item	SET	
801	Tag No.1	TAG NO.1	8 Alphanumerics (1st half 8 characters of Tag No.)
802	Tag No.2	TAG NO.2	8 Alphanumerics (2nd half 8 characters of Tag No.)
803	Comment 1	COMMENT 1	8 Alphanumerics
804	Comment 2	COMMENT 2	8 Alphanumerics
807	Input Type *1	INP TYPE	Select from LL/L/H/HH
810	Zero Point	ZERO	Numeric Data
811	Span	SPAN	Numeric Data
812	Burnout *1	BURN	Select from OFF/ON
813	Setup Error	SET ERR	GOOD/ERROR
820	Program *2	PROGRAM	Inter-company Setup Item
821	Program *2	PROGRAM	Inter-company Setup Item
≡	≡	≡	≡
848	Program *2	PROGRAM	Inter-company Setup Item
849	Program *2	PROGRAM	Inter-company Setup Item
C00	Adjust Item	ADJUST	
C01	0% Output Adjust	OUT 0%	Numeric Data (±10.00)
C02	100% Output Adjust	OUT 100%	Numeric Data (±10.00)
C03	Wiring Resistance Adjust *1	WIRING R	RESET/EXECUTE
C04	0% input Adjust *2	IN 0%	
C05	100% input Adjust *2	IN 100%	
C11	Fixed Constant *2	CONST	Numeric Data
C12	Fixed Constant *2	CONST	Numeric Data
≡	≡	≡	≡
C40	Fixed Constant	CONST	Numeric Data
C41	Fixed Constant	CONST	Numeric Data

\*1 Display only WX3□-PH  
 \*2 Display only. Don't use

Subject to change without notice for grade up quality and performance.

---

**YOKOGAWA**   
Yokogawa Electric Corporation

Network Solutions Business Division  
2-9-32, Nakacho Musashino-shi, Tokyo, 180-8750 Japan  
Phone: (81)-422-52-7179 Fax: (81)-422-52-6793