

# EZ-LIGHT® Touch Gen 2 K50 FDA-Grade Specialty Pick-to-Light

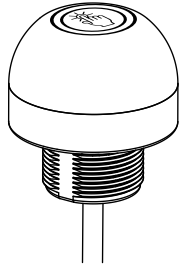

## Datasheet

Compact, Single-Point Devices for Error-Proofing of Bin-Picking Operations



- FDA-grade materials; rated to IEC IP67, IP68, and IP69K
- Laser marked information withstands aggressive cleaning procedures
- Excellent immunity to false triggering by water spray, detergents, oils, and other foreign materials
- Rugged, cost-effective and easy-to-install solutions for error-proofing and parts-verification applications
- Compact devices are completely self contained—No controller needed
- Easy actuation—no force required
- 12 V to 30 V dc operation
- Can be actuated with bare hands or in gloves



**WARNING:** Not To Be Used for Personnel Protection

Never use this device as a sensing device for personnel protection. Doing so could lead to serious injury or death. This device does not include the self-checking redundant circuitry necessary to allow its use in personnel safety applications. A sensor failure or malfunction can cause either an energized or de-energized sensor output condition.

## Models

Model <sup>1</sup>	Function	Output <sup>2</sup>	Connection	Indicators		
				Job	Mis-Pick	Sense
K50APT2FGRYC3QP	<ul style="list-style-type: none"> <li>• Job light always On with job input until touched</li> <li>• Touch activates output and overrides job light with sense light</li> <li>• Touch with inactive job input activates mis-pick light and activates output</li> </ul>	PNP, N.O.	150 mm (6 in) PVC cable with a 5-pin M12/ Euro-style male, stainless steel, quick disconnect (QD)	Green	Red	Yellow
K50RPT2FGRYC3QP		PNP, N.C.				
K50APT2FGRYC4QP	<ul style="list-style-type: none"> <li>• Job light always On with job input until touched</li> <li>• Touch activates output and overrides job light with sense light until job input is removed</li> <li>• Touch with inactive job input activates mis-pick light for 5 seconds after touched and activates output</li> </ul>	PNP, N.O.		Green	Red	Yellow
K50RPT2FGRYC4QP		PNP, N.C.				

## Indicator and Output Behavior



NOTE: "C3" and "C4" models as referenced in the table pertain to a part of the product model number, immediately preceding the designation.

Sensor Conditions		C3 Models	C4 Models	Output Signal Status
		Job input active	Hand/pick absent	
	Hand/pick present	On Yellow	On Yellow until job input is removed	On
No job input	Hand/pick absent	Off	Off	Off

- <sup>1</sup>
- To order the 2 m (6.5 ft) PVC cable model, omit the suffix "QP" in the model number. For example, K50APT2FGRYC3.
  - To order the 150 mm (6 in) PUR cable model with a 5-Pin M12/Euro-style quick disconnect, replace the suffix "QP" with "QPMA" in the model number. For example, K50APT2FGRYC3QPMA.
  - Models with a quick disconnect require a mating cordset.
- <sup>2</sup> PNP models only are listed. For other output types, contact Banner Engineering.



Sensor Conditions		C3 Models	C4 Models	Output Signal Status
		Hand/pick present	On Red	

## Specifications

### Supply Voltage

12 V to 30 V dc

### Supply Current

< 75 mA max current at 12 V dc (exclusive of load)  
< 50 mA max current at 30 V dc (exclusive of load)

### Supply Protection Circuitry

Protected against reverse polarity and transient voltages

### Output Rating

Maximum Load: 150 mA  
ON-state saturation voltage: < 2 V at 10 mA dc; < 2.5 V at 150 mA dc  
OFF-state leakage current: < 10 µA at 30 V dc

### Output Response Time

50 milliseconds On  
500 milliseconds leading edge Off

### Construction

Base, dome, and nut: FDA-grade polycarbonate

### Environmental Rating

IEC IP67, IP69K per DIN 40050-9.

### Operating Conditions

-40 °C to +50 °C (-40 °F to +122 °F)  
90% at 50 °C maximum relative humidity (non-condensing)

### Storage Conditions

-40 °C to +70 °C (-40 °F to +158 °F)

### Vibration and Mechanical Shock

Vibration 10 Hz to 55 Hz 1.0 mm p-p amplitude per IEC 60068-2-6  
Shock 30G 11 ms duration, half sine wave per IEC 60068-2-27

### Mounting

M30 × 1.5 Threaded base Max torque 4.5 N·m (40 in·lbf)

### Connections

150 mm (6 in) PVC cable with a 5-pin M12/Euro-style male, stainless steel, quick disconnect (QD), 2 m (6.5 ft) PVC integral cable, or 150 mm (6 in) PUR cable with a 5-pin M12/Euro-style male quick disconnect (QD)

### Certifications



### Power-Up Delay

300 milliseconds

### Indicators

Job ("pick") indicator: Green  
Mis-pick indicator: Red  
Sense indicator: Yellow

### Indicator Lumens

Color	Typical Wavelength	Typical Intensity (lm)
Green	525 nm	29
Red	625 nm	13
Yellow	591 nm	24

### Required Overcurrent Protection



**WARNING:** Electrical connections must be made by qualified personnel in accordance with local and national electrical codes and regulations.

Overcurrent protection is required to be provided by end product application per the supplied table.  
Overcurrent protection may be provided with external fusing or via Current Limiting, Class 2 Power Supply.  
Supply wiring leads < 24 AWG shall not be spliced.  
For additional product support, go to <http://www.bannerengineering.com>.

Supply Wiring (AWG)	Required Overcurrent Protection (Amps)
20	5.0
22	3.0
24	2.0
26	1.0
28	0.8
30	0.5

## Dimensions

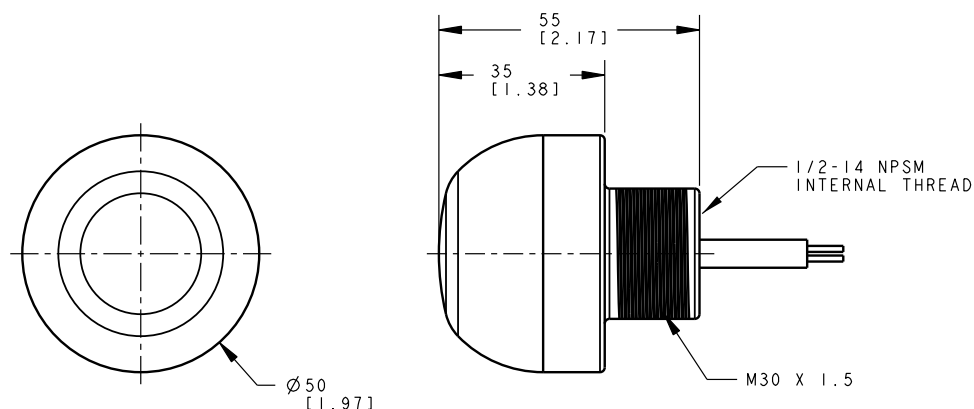

All measurements are listed in millimeters [inches], unless noted otherwise.

## Wiring Diagram

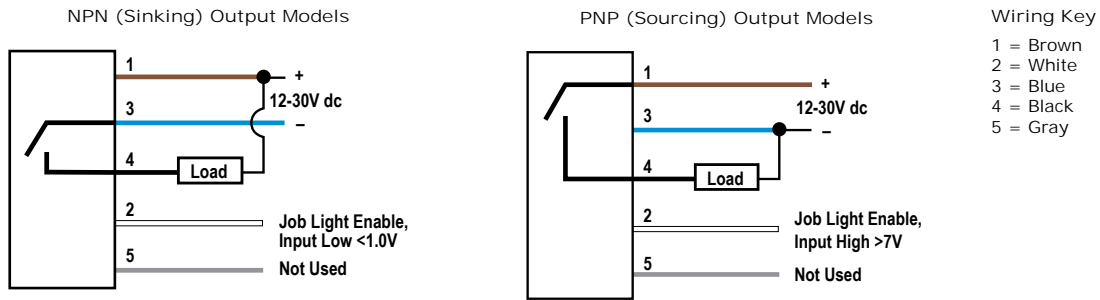

NOTE: Cabled wiring diagrams are shown. Quick disconnect (QD) wiring diagrams are functionally identical.

## Accessories

### Cordsets

5-Pin Threaded M12/Euro-Style Cordsets—Single Ended				
Model	Length	Style	Dimensions	Pinout (Female)
MQDC1-501.5	0.50 m (1.5 ft)	Straight		<p>1 = Brown 2 = White 3 = Blue 4 = Black 5 = Gray</p>
MQDC1-506	1.83 m (6 ft)			
MQDC1-515	4.57 m (15 ft)			
MQDC1-530	9.14 m (30 ft)			
MQDC1-506RA	1.83 m (6 ft)	Right-Angle		
MQDC1-515RA	4.57 m (15 ft)			
MQDC1-530RA	9.14 m (30 ft)			

5-Pin Threaded M12/Euro-Style Cordsets—Washdown Stainless Steel				
Model	Length	Style	Dimensions	Pinout (Female)
MQDC-WDSS-0506	1.83 m (6 ft)	Straight		<p>1 = Brown 2 = White 3 = Blue 4 = Black 5 = Gray</p>
MQDC-WDSS-0515	4.57 m (15 ft)			
MQDC-WDSS-0530	9.14 m (30 ft)			

5-Pin Threaded M12/Euro-Style Cordsets—Washdown, with Shield				
Model	Length	Style	Dimensions	Pinout (Female)
MQDCWD-506	1.83 m (6 ft)	Straight		
MQDCWD-530	9.14 m (30 ft)			

## Brackets

### SMB30A

- Right-angle bracket with curved slot for versatile orientation
- Clearance for M6 (1/4 in) hardware
- Mounting hole for 30 mm sensor
- 12-ga. stainless steel

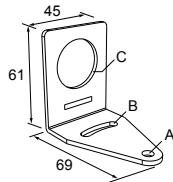

Hole center spacing: A to B=40  
 Hole size: A=ø 6.3, B= 27.1 x 6.3, C=ø 30.5

### SMB30FA

- Swivel bracket with tilt and pan movement for precise adjustment
- Mounting hole for 30 mm sensor
- 12-ga. 304 stainless steel
- Easy sensor mounting to extrude rail T-slot
- Metric and inch size bolt available

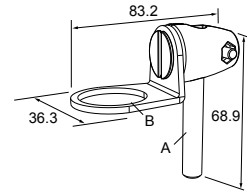

Bolt thread: SMB30FA, A= 3/8 - 16 x 2 in; SMB30FAM10, A= M10 - 1.5 x 50  
 Hole size: B= ø 30.1

### SMB30FVK

- V-clamp, flat bracket and fasteners for mounting to pipe or extrusions
- Clamp accommodates 28 mm dia. tubing or 1 in. square extrusions
- 30 mm hole for mounting sensors

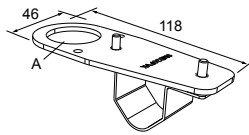

Hole size: A= ø 31

### SMB30MM

- 12-ga. stainless steel bracket with curved mounting slots for versatile orientation
- Clearance for M6 (1/4 in) hardware
- Mounting hole for 30 mm sensor

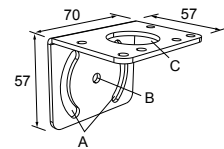

Hole center spacing: A = 51, A to B = 25.4  
 Hole size: A = 42.6 x 7, B = ø 6.4, C = ø 30.1

### SMB30RAVK

- V-clamp, right-angle bracket and fasteners for mounting sensors to pipe or extrusion
- Clamp accommodates 28 mm dia. tubing or 1 in. square extrusions
- 30 mm hole for mounting sensors

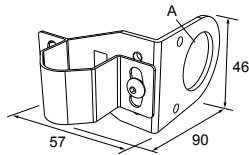

Hole size: A = ø 30.5

### SMB30SC

- Swivel bracket with 30 mm mounting hole for sensor
- Black reinforced thermoplastic polyester
- Stainless steel mounting and swivel locking hardware included

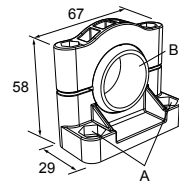

Hole center spacing: A=ø 50.8  
 Hole size: A=ø 7.0, B=ø 30.0

### SMBAMS30P

- Flat SMBAMS series bracket
- 30 mm hole for mounting sensors
- Articulation slots for 90° + rotation
- 12-ga. 300 series stainless steel

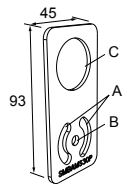

Hole center spacing: A=26.0, A to B=13.0  
 Hole size: A=26.8 x 7.0, B=ø 6.5, C=ø 31.0

### SMBAMS30RA

- Right-angle SMBAMS series bracket
- 30 mm hole for mounting sensors
- Articulation slots for 90° + rotation
- 12-ga. (2.6 mm) cold-rolled steel

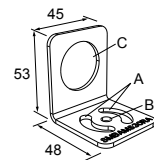

Hole center spacing: A=26.0, A to B=13.0  
 Hole size: A=26.8 x 7.0, B=ø 6.5, C=ø 31.0

TC-K50-CL

- Touch cover

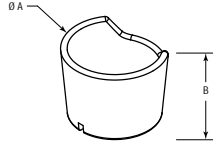

Diameter: A = 67 mm

Height: B = 42.5 mm

## Banner Engineering Corp. Limited Warranty

---

Banner Engineering Corp. warrants its products to be free from defects in material and workmanship for one year following the date of shipment. Banner Engineering Corp. will repair or replace, free of charge, any product of its manufacture which, at the time it is returned to the factory, is found to have been defective during the warranty period. This warranty does not cover damage or liability for misuse, abuse, or the improper application or installation of the Banner product.

THIS LIMITED WARRANTY IS EXCLUSIVE AND IN LIEU OF ALL OTHER WARRANTIES WHETHER EXPRESS OR IMPLIED (INCLUDING, WITHOUT LIMITATION, ANY WARRANTY OF MERCHANTABILITY OR FITNESS FOR A PARTICULAR PURPOSE), AND WHETHER ARISING UNDER COURSE OF PERFORMANCE, COURSE OF DEALING OR TRADE USAGE.

This Warranty is exclusive and limited to repair or, at the discretion of Banner Engineering Corp., replacement. IN NO EVENT SHALL BANNER ENGINEERING CORP. BE LIABLE TO BUYER OR ANY OTHER PERSON OR ENTITY FOR ANY EXTRA COSTS, EXPENSES, LOSSES, LOSS OF PROFITS, OR ANY INCIDENTAL, CONSEQUENTIAL OR SPECIAL DAMAGES RESULTING FROM ANY PRODUCT DEFECT OR FROM THE USE OR INABILITY TO USE THE PRODUCT, WHETHER ARISING IN CONTRACT OR WARRANTY, STATUTE, TORT, STRICT LIABILITY, NEGLIGENCE, OR OTHERWISE.

Banner Engineering Corp. reserves the right to change, modify or improve the design of the product without assuming any obligations or liabilities relating to any product previously manufactured by Banner Engineering Corp.

## Copyright Notice

---

Any misuse, abuse, or improper application or installation of this product or use of the product for personal protection applications when the product is identified as not intended for such purposes will void the product warranty. Any modifications to this product without prior express approval by Banner Engineering Corp will void the product warranties. All specifications published in this document are subject to change; Banner reserves the right to modify product specifications or update documentation at any time. For the most recent version of any documentation, refer to: [www.bannerengineering.com](http://www.bannerengineering.com). © Banner Engineering Corp. All rights reserved.