

General Specifications

GS 77J01P08-01E

Model VJP8 Pulse Rate Converter (Multi-function) (Isolated Single-output and Isolated Dual-output Types)

JUXTA

■ General

The VJP8 is a plug-in pulse rate converter that receives contact, voltage or current pulse from a field, and converts it into isolated transistor-contact pulse or contactless AC switch pulse at a preset pulse rate. The VJP8 can also be used as a pulse signal repeater by setting the pulse rate and pulse width type.

- Either pulse output or communication function (RS-485) is selectable as Output-2.
- Various parameters such as pulse rate can be set and modified through a PC (VJ77) or Handy Terminal (JHT200 and the like).

■ Model and Suffix Codes

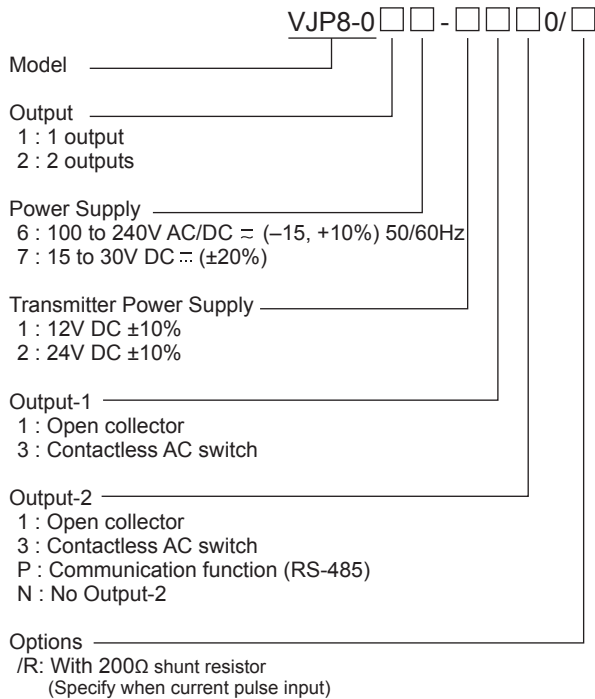

■ Input

- Input signal:
- 2-wire type; ON/OFF contact, voltage pulse, or current pulse (transmitter power supply available)
 - 3-wire type: Voltage pulse (transmitter power supply available)
- Input frequency range: 0 to 100kHz
When input filter is ON, input frequency; 100Hz or less, minimum pulse width; 3ms

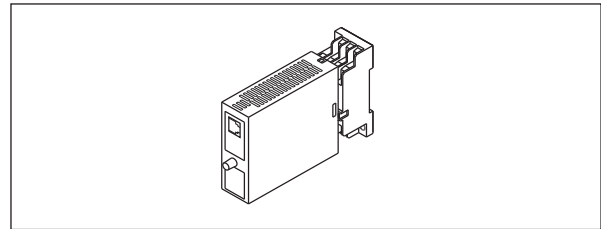

Minimum input pulse width:

- When input frequency is below 10kHz: 30 μs
- When input frequency is 10kHz or more: 30% of pulse interval

Input display unit: Either Hz or kHz is selectable.
Input Signal Type:

	Non-Voltage Contact	
	Voltage Pulse	Current Pulse (Note 1)
ON input	Contact resistance of 200Ω or less	
OFF input	Contact resistance of 100kΩ or more	
High level (OFF input)	2 to 50V DC	10 to 50mA DC
Low level (ON input)	-1 to +8V DC	-5 to +40mA DC
Pulse width	2 to 50V DC	10 to 50mA DC

(Note1) Maximum permissible current is 50mA for 200V shunt resistor

Maximum permissible input voltage: 58V DC or less
Input resistance:

- Contact pulse or voltage pulse: 15kΩ or more
- Current pulse: 200Ω (with external shunt resistor: option)

Power supply for contact input signal: At least 15V DC/15mA

Input filter: Has an approx. 10ms time constant

Transmitter power supply: 12V DC ± 10% (for 4 to 30mA output), or 24V DC ± 10% (for 4 to 30mA output)

(With current limit circuit: limited at 50mA)

■ Output

1. Output-1

Operation of Output-1 is same as that of Output-2.

Output pulse: Number of input pulse 3 pulse rate

Pulse rate = output frequency / input frequency

Output signal: Open collector or contactless AC switch

Output frequency:

Open collector: 0 to 100kHz

Contactless AC switch: 0 to 1kHz

Maximum permissible load:

Open collector: 30V DC/200mA

Contactless AC switch: 100V AC/200mA

Pulse rate setting range: 0.0001 to 2.0000 (settable to four decimal places)

When pulse width type is "through", effective range is 0.0001 to 1.0000.

Pulse width type: Either through (no change) or fixed on-state pulse width is selectable.

Pulse width time: Either 12.5, 50, 100 μ s, 12.5, 30, 50, or 100 ms is selectable.

Input frequency limitation for fixed pulse width: When the following conditions are not satisfied, number of output pulse is not guaranteed.

$$\text{Input frequency (Hz)} \leq \frac{1}{\text{Pulse width(s)} \times 2} \times n$$

"n" varies with the pulse rate applied.

When pulse rate is 0.0000 to 1.0000,

$$n = \frac{1}{\text{pulse rate}}$$

(integer after omitting the figures below the decimal place)

When pulse rate is 1.0001 to 2.0000, n=0.5.

(Note2) When pulse rate except for "1" is set, the scaler does not always deliver the same speed of output pulses as the number of input pulses multiplied by the given pulse rate. Be fully aware of this fact when using the scaler.

2. Output-2

● Pulse Output

Same as Output-1 specifications

● Communication Function

This converter can be connected to a PC, graphic panel, YOKOGAWA programmable controller FA-M3, or programmable controllers of other manufacturers.

Standards: EIA RS-485

Maximum number of connectable controllers:
31 controllers

Maximum communication distance: 1200 m

Communication method: 2-wire half duplex, start-stop synchronization, non-procedural

Baud rate: 1200, 2400, 4800, 9600 bps

Data length: 8, 7 bit

Stop bit: 1, 2 bit

Parity: Even parity, odd parity, or none

Communication protocol: PC-link, PC-link with SUM, MODBUS ASCII, MODBUS RTU, or LADDER

PC-link communication: Communication protocol with a PC, graphic panel, UT link module of FA-M3

MODBUS communication: Communication protocol with a PC (SCADA).

Ladder communication: Communication protocol with ladder communication module of FA-M3 and programmable controller of other manufacturers

■ Items Available to Be Set

The following items can be set through a PC (VJ77 PC-based parameters setting tool) or Handy Terminal:

Input filter, pulse rate, pulse width type, pulse width time, address number, baud rate, parity, data length, stop bit, protocol

■ Standard Performance

Accuracy rating: $\pm 0.1\%$ of span (however, an indicated value when monitoring input frequency through communication)

Pulse width time accuracy: $\pm 10\%$

However, 25 to 30ms for 30ms (Electromagnetic counter SICD operation is available.)

Effect of power supply voltage fluctuation: 85 to 264V AC (47 to 63Hz) / DC, no wrong operation for each power supply voltage of 12 to 36V DC

(However, when monitoring input frequency through communication, the indicated value is $\pm 0.1\%$ or less.)

Effect of ambient temperature change: No wrong operation for change of 10°C

(However, when monitoring input frequency through communication, the indicated value is $\pm 0.2\%$ or less.)

■ Safety and EMC Standards

The followings will be acquired.

Safety: Approved by CAN/CSA C22.2 No.61010-1(CSA), approved by UL61010-1.

Installation category: CAT. II

Pollution degree: 2

As for the apparatus authorized, power supply voltage is limited to 15 V to 30 V DC, and the circuit to connect is limited to a class 2.

Models that have contactless AC switch output are not certified.

Category	Description	Remarks
CAT.I	For measurements performed on circuits not directly connected to MAINS.	
CAT.II	For measurements performed on circuits directly connected to the low voltage installation.	Appliances, portable equipments, etc.
CAT.III	For measurements performed in the building installation.	Distribution board, circuit breaker, etc.
CAT.IV	For measurements performed at the source of the low-voltage installation.	Overhead wire, cable systems, etc.

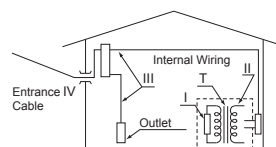

EMC Standards:

Compliant with CE marking EN 61326-1.

KC marking: Electromagnetic wave interference prevention standard, electromagnetic wave protection standard compliance.

The instrument continues to operate at a measurement accuracy of within $\pm 20\%$ of the range during testing.

The above conformed instrument is only for voltage of 15 to 30 V DC \pm (±20%); models that have contactless AC switch output are not CE certified.

■ Power Supply and Isolation

Power Supply Rated Voltage:
100 to 240 V AC/DC \approx 50/60 Hz
15 to 30 V DC \pm

Power Supply Input Voltage: 100 to 240 V AC/DC \approx
(-15, +10%) 50/60 Hz
15 to 30 V DC \pm (±20%)

Power Dissipation: 24 V DC 3.7 W, 110 V DC 3.7 W
100 V AC 6.5 VA, 200 V AC 8.6 VA

Insulation Resistance: 100 M Ω /500 V DC between
input, output-1, output-2, power supply
and ground mutually

Withstand Voltage: 2000 V AC / minute between
input, (output-1, output-2), power supply,
and ground mutually
1000 V AC / minute between output-1 and
output-2

■ Environmental Conditions

Temperature: 0 to 50 °C
Humidity: 5 to 90% RH (no condensation)
Ambient Condition: Avoid installation in such
environments as corrosive gas like sulfide
hydrogen, dust, sea breeze and direct
sunlight.
Installation altitude 2000m or less above
sea level.

■ Mounting and Appearance

Construction: Compact plug-in type
Material: Modified Polyphenylene Oxide (Case
body)

■ Terminal Arrangement

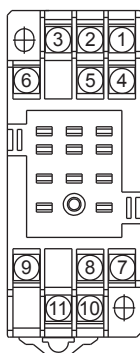

Terminal No.	Signal	Output-2 Pulse output	Output-2 Communication output
1	Input	(PS+)	
2	Output-2	(+)	B(+)
3	Input	(+) (A(+))	
4	Input	(-) (A(-))	
5	Output-2	(-)	A(-)
6	Output-2	N.C.	COM
7	Output-1	(+) (B(+))	
8	GND	GND	
9	Output-1	(-) (B(-))	
10	Supply	(L+)	
11	Supply	(N-)	

(Note3) With one-output type, terminals for Output-2 are not connected.

Note: This instrument may output a pulse when the power is turned on/off.
Depending on the connected devices, this pulse output is counted as "one pulse."

Mounting Method: Wall, DIN rail, or dedicated VJ
mounting base (only when Output-2 is
analog output) mountings

Connection Method: M3 screw terminal
External Dimension: 29.5x76x124.5mm (WxHxD)
Weight: Approx. 170 g

■ Accessories

Tag Number Label: 1 sheet
Shunt Resistor: 1 (when optional code/R is specified)

■ Items to Specify When Ordering

- Model and Suffix Code

Shipped after setting the input filter ON/OFF, input display unit, pulse rate, pulse width type, pulse width time as specified.

■ Factory Setting

Factory settings are as follows:

- Input display unit: kHz
- Input frequency: 0 to 100kHz
- Input filter: OFF
- Output frequency: 0 to 100kHz
- Pulse rate: 1.0000
- Pulse width type: Through
- Pulse width time: 30ms
- **When output-2 is specified as communication output**
 - Address No.: 01
 - Baud rate: 9600 bps
 - Parity: Even
 - Data length: 8 bit
 - Stop bit: 1 bit
 - Protocol: PCLINK

■ Block Diagram

- When Receiving Current Pulse by Running a Transmitter on an Internal Power Supply
- When Receiving Non-Voltage Contact Signal or Voltage Pulses (where, terminal 3 is the positive input (+) and terminal 4 is the negative input (-) for voltage pulse)

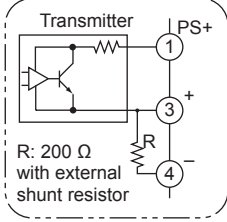

- When Receiving Voltage Pulse by Running a Transmitter on an Internal Power Supply

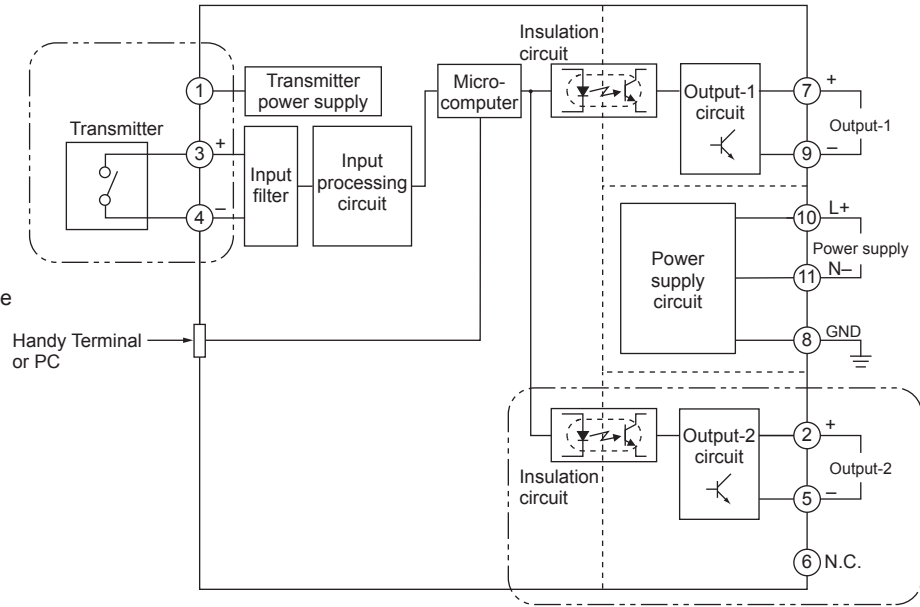
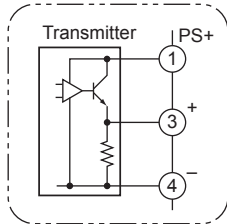

- When output-2 is communication function

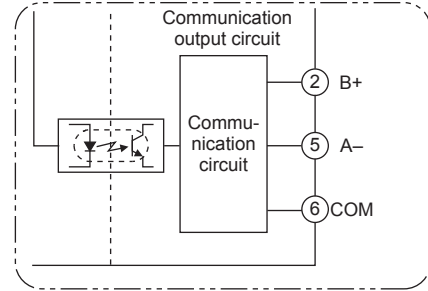

■ External Dimension

