

# L-GAGE® LE250/550 IO-Link Laser Gauging Sensors

## Instruction Manual

Original Instructions  
194205 Rev. A  
2 December 2016  
© Banner Engineering Corp. All rights reserved



194205

# Contents

1	Product Description	3
1.1	Models	3
1.2	Overview	3
1.2.1	Features and Indicators	4
1.2.2	Display	4
1.2.3	Buttons	4
1.3	Laser Description and Safety Information	5
2	Sensor Installation	7
2.1	Sensor Orientation	7
2.2	Mount the Sensor	7
2.3	Wiring Diagrams	8
3	Sensor Programming	9
3.1	Quick Menu	9
3.2	Sensor Menu (MENU)	10
3.3	Remote Input	10
3.4	Locking and Unlocking the Sensor	12
3.5	Discrete Output Menu (Dx_OUT)	13
3.5.1	Two-Point TEACH	13
3.5.2	Midpoint TEACH	15
3.5.3	Adjust Switch Point One	17
3.5.4	Adjust Switch Point Two	17
3.5.5	TEACH Switch Point	17
3.5.6	Adjust Switch Point	18
3.5.7	Mode	18
3.5.8	Switch Point Reference (SPtRef)	20
3.5.9	Switch Point TEACH Offset	20
3.5.10	Timer	21
3.6	Input Menu (INPUT)	21
3.6.1	Input Type	21
3.7	Measure Menu (MEASURE)	22
3.7.1	Speed	22
3.8	Display Menu (DISPLAY)	23
3.8.1	Units	23
3.8.2	Zero	23
3.8.3	Shift	23
3.8.4	View	23
3.8.5	Sleep	24
3.9	Information Menu (INFO)	24
3.10	Reset Menu (RESET)	25
3.10.1	Factory Default Settings	25
4	Sync Master/Slave	26
5	Additional Remote TEACH Procedures	27
5.1	TEACH Both Discrete Output Switch Points Together	27
5.2	TEACH Both Discrete Output Midpoints Together	27
6	Specifications	29
6.1	Performance Curves	30
6.2	Dimensions	31
7	Troubleshooting	32
8	Sensor Menu Full Map	33
9	Accessories	34
9.1	Cordsets	34
9.2	Brackets	34
10	Banner Engineering Corp. Limited Warranty	35

# 1 Product Description

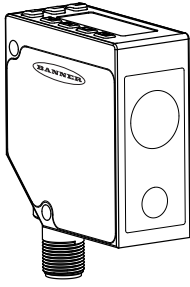

- Easy to set up and use with a 2-line, 8-character display
- Various sizes of visible red laser, depending on target size, distance, and color characteristics
- Sensing range options up to 1 meter
- IO-Link v1.1



**WARNING: Not To Be Used for Personnel Protection**

Never use this device as a sensing device for personnel protection. Doing so could lead to serious injury or death. This device does not include the self-checking redundant circuitry necessary to allow its use in personnel safety applications. A sensor failure or malfunction can cause either an energized or de-energized sensor output condition.

## 1.1 Models

Family	Range	Output	Laser Class	Connector
<b>LE</b>	<b>550</b>	<b>I</b>	<b></b>	<b>Q</b>
	550 = 100-1000 mm 250 = 100-400 mm	I = 4 to 20 mA analog and (1) NPN/PNP discrete U= 0 to 10 V analog and (1) NPN/PNP discrete D= (2) NPN/PNP discrete K= IO-Link and PNP discrete	Blank = Class 2 laser C1 = Class 1 Laser	Q = Rotatable M12/Euro-style QD QP = PVC M12/Euro-style Pigtail QD  QD models require mating cordset
		<i>NOTE: Discrete NPN/PNP is user configurable</i>		

Information about additional L-GAGE LE models, such as analog output models, is available at [www.bannerengineering.com](http://www.bannerengineering.com).

## 1.2 Overview

The L-GAGE LE250/550 IO-LINK Laser Gauging Sensor is a visible, bore-sighted laser displacement sensor designed for precise, color-insensitive measurements. The LE series of sensors includes models covering various ranges, spot sizes, and measurement performance.

A 2-line LCD shows the real-time distance measurement, in either millimeters or inches, and provides an intuitive interface for easy sensor setup.

See [Factory Default Settings](#) on page 25 for a list of sensor default settings.

Models with current or voltage analog outputs are available.

## 1.2.1 Features and Indicators

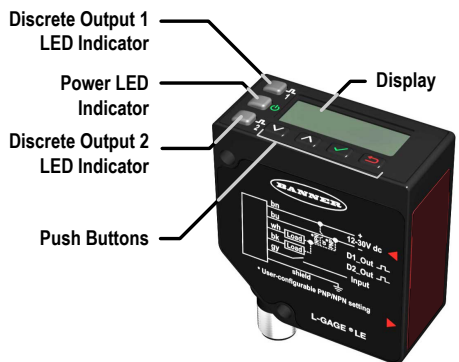

Figure 1. LE IO-Link Sensor Features

Three LED indicators provide ongoing indication of the sensing status.

### Power LED Indicator

Solid Green = Normal operation, power On and laser On  
Flashing Green (1 Hz) = Power On and laser Off (laser enable mode)

### Discrete Output LED Indicators

Solid Amber = Discrete Output is On  
Off = Discrete Output is Off

## 1.2.2 Display



Figure 2. LE550 Display in Run Mode

The display is a 2-line, 8-character LCD. The main screen is the Run mode screen, which shows the real-time distance measurement.

## 1.2.3 Buttons

Use the sensor buttons Down, Up, Enter, and Escape to program the sensor and to access sensor information.



### Down and Up Buttons

Press Down and Up to:

- Access the Quick Menu from Run mode
- Navigate the menu systems
- Change programming settings

When navigating the menu systems, the menu items loop.

Press Down and Up to change setting values. Press and hold the buttons to cycle through numeric values. After changing a setting value, it slowly flashes until the change is saved using the Enter button.



### Enter Button

Press Enter to:

- Access the Sensor Menu from Run mode
- Access the submenus
- Save changes

In the Sensor Menu, a check mark  in the lower right corner of the display indicates that pressing Enter accesses a submenu.

Press Enter to save changes. New values flash rapidly and the sensor returns to the parent menu.



### Escape Button

Press Escape to:

- Leave the current menu and return to the parent menu
- Return to Run mode from the Quick Menu



Important: Pressing Escape discards any unsaved programming changes.

In the Sensor Menu, a return arrow  in the upper left corner of the display indicates that pressing Escape returns to the parent menu.

Press and hold Escape for 2 seconds to return to Run mode from any menu or remote teach.

## 1.3 Laser Description and Safety Information



CAUTION: Use of controls or adjustments or performance of procedures other than those specified herein may result in hazardous radiation exposure. Do not attempt to disassemble this sensor for repair. A defective unit must be returned to the manufacturer.

### 1.3 Class 2 Laser Models



CAUTION: Never stare directly into the sensor lens. Laser light can damage your eyes. Avoid placing any mirror-like object in the beam. Never use a mirror as a retroreflective target.



For Safe Laser Use - Class 2 Lasers

- Do not stare at the laser.
- Do not point the laser at a person's eye.
- Mount open laser beam paths either above or below eye level, where practical.
- Terminate the beam emitted by the laser product at the end of its useful path.

Reference IEC 60825-1:2007, Section 8.2.

#### Class 2 Lasers

Class 2 lasers are lasers that emit visible radiation in the wavelength range from 400 nm to 700 nm, where eye protection is normally afforded by aversion responses, including the blink reflex. This reaction may be expected to provide adequate protection under reasonably foreseeable conditions of operation, including the use of optical instruments for intrabeam viewing.

#### Class 2 Laser Safety Notes

Low-power lasers are, by definition, incapable of causing eye injury within the duration of a blink (aversion response) of 0.25 seconds. They also must emit only visible wavelengths (400 to 700 nm). Therefore, an ocular hazard may exist only if individuals overcome their natural aversion to bright light and stare directly into the laser beam.



Figure 3. FDA (CDRH) warning label (Class 2)

### 1.3 Class 1 Laser Models

Class 1 lasers are lasers that are safe under reasonably foreseeable conditions of operation, including the use of optical instruments for intrabeam viewing.

Laser wavelength: 650  
nm

Output: < 0.22  
mW

Pulse Duration: 150  $\mu$ s to  
900  $\mu$ s



Figure 4. FDA (CDRH) warning label (Class 1)

## 2 Sensor Installation



NOTE: Handle the sensor with care during installation and operation. Sensor windows soiled by fingerprints, dust, water, oil, etc. may create stray light that may degrade the peak performance of the sensor. Blow the window clear using filtered, compressed air, then clean as necessary using 70% isopropyl alcohol and cotton swabs or water and a soft cloth.

### 2.1 Sensor Orientation

Correct sensor-to-object orientation is important to ensure proper sensing. See the following figures for examples of correct and incorrect sensor-to-object orientation as certain placements may pose problems for sensing distances.

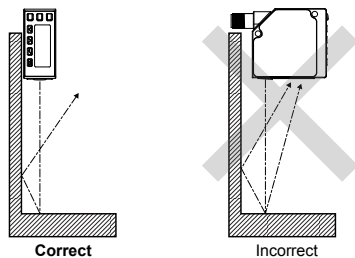

Figure 5. Orientation by a wall

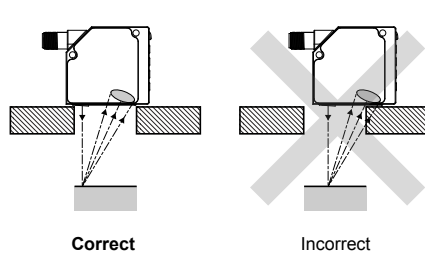

Figure 6. Orientation in an opening

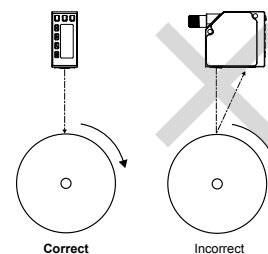

Figure 7. Orientation for a turning object

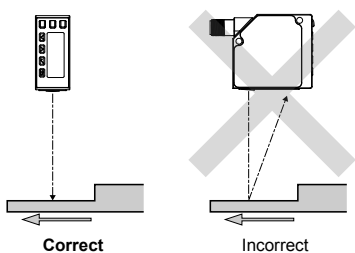

Figure 8. Orientation for a height difference

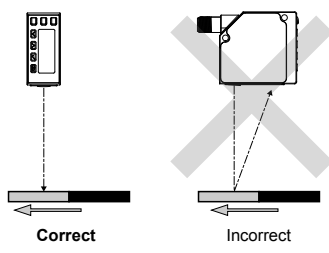

Figure 9. Orientation for a color or luster difference

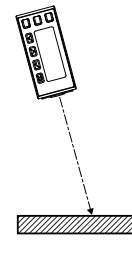

Figure 10. Orientation for a highly reflective target

Applying tilt to sensor may improve performance on reflective targets. The direction and magnitude of the tilt depends on the application, but a 15° tilt is often sufficient.

### 2.2 Mount the Sensor

1. If a bracket is needed, mount the sensor onto the bracket.
2. Mount the sensor (or the sensor and the bracket) to the machine or equipment at the desired location. Do not tighten the mounting screws at this time.
3. Check the sensor alignment.
4. Tighten the mounting screws to secure the sensor (or the sensor and the bracket) in the aligned position.

## 2.3 Wiring Diagrams

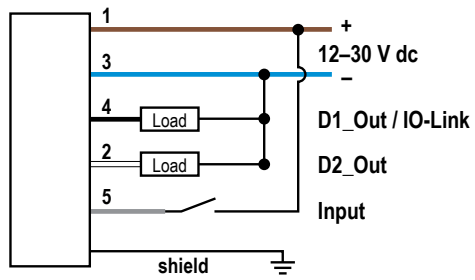

Key

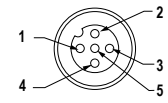

- 1 = Brown
- 2 = White
- 3 = Blue
- 4 = Black
- 5 = Gray

Figure 11. IO-Link Models



### 3 Sensor Programming

Program the sensor using the buttons on the sensor or the remote input (limited programming options).

From Run mode, use the buttons to access the Quick Menu and the Sensor Menu. See [Quick Menu](#) on page 9 and [Sensor Menu \(MENU\)](#) on page 10 for more information on the options available from each menu. For TEACH options, follow the TEACH instructions.

In addition to programming the sensor, use the remote input to disable the buttons for security, preventing unauthorized or accidental programming changes. See [Remote Input](#) on page 10 for more information.

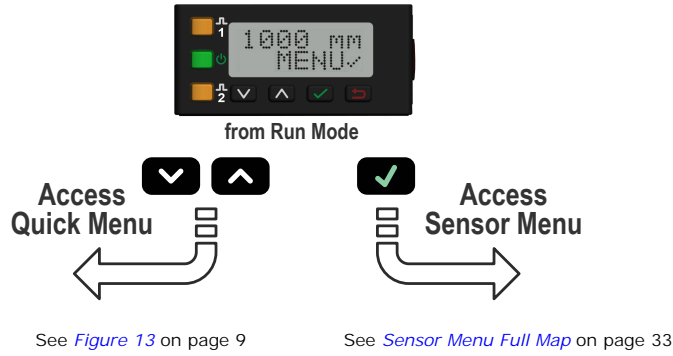

Figure 12. Accessing the Menus

#### 3.1 Quick Menu

The sensor includes a Quick Menu with easy access to view and change the discrete output switch points. Access the Quick Menu by pressing Down or Up from Run mode. When in the Quick Menu, the current distance measurement displays on the first line and the menu name and the discrete output switch points alternate on the second line of the display. Press Enter to access the switch points. Press Down or Up to change the switch point to the desired value. Press Enter to save the new value and return to the Quick Menu.

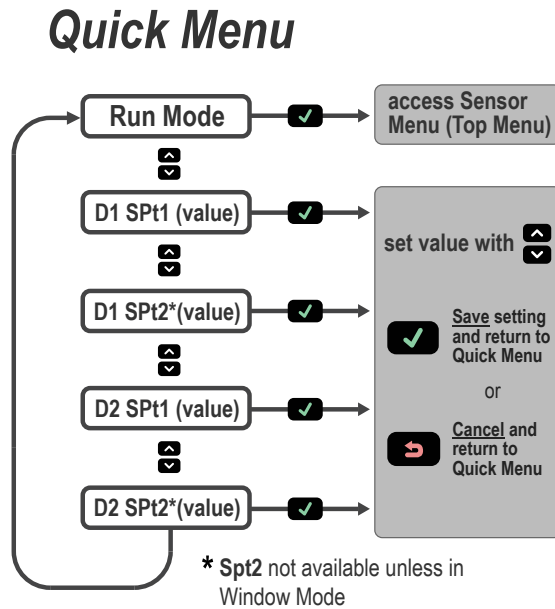



Figure 13. Quick Menu Map (Window Mode)

## 3.2 Sensor Menu (MENU)

Access the Sensor Menu by pressing Enter  from Run mode, when MENU is displayed. The Sensor Menu includes several submenus that provide access to view and change sensor settings and to view sensor information.

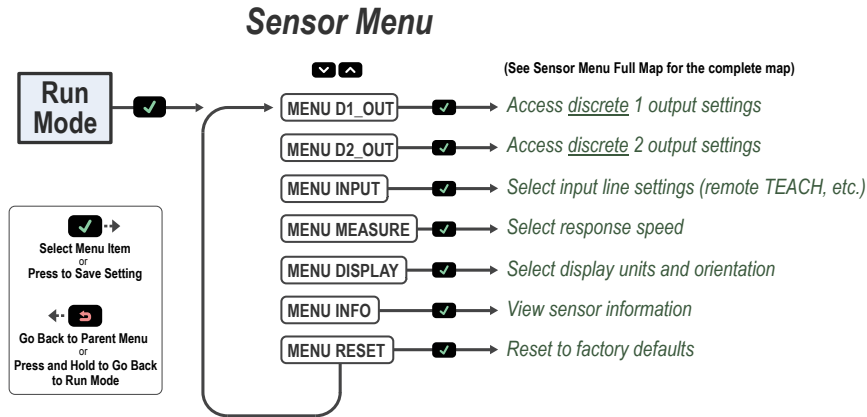

Figure 14. Sensor Menu Basic Map

See *Sensor Menu Full Map* and the Menu sections of this manual for more information.

## 3.3 Remote Input

Use the remote input to program the sensor remotely. The remote input provides limited programming options.

To use the Active High function, connect the gray input wire to V+ (12 to 30 V dc). Pulse the remote input according to the diagram and the instructions provided in this manual.

The length of the individual programming pulses is equal to the value T: 0.04 seconds  $\leq$  T  $\leq$  0.8 seconds.

Exit remote programming modes by holding the remote input low for > 2 seconds, or waiting for the automatic 60-second timeout, or by pressing and holding Escape  for 2 seconds. The sensor returns to Run mode without saving any new settings.

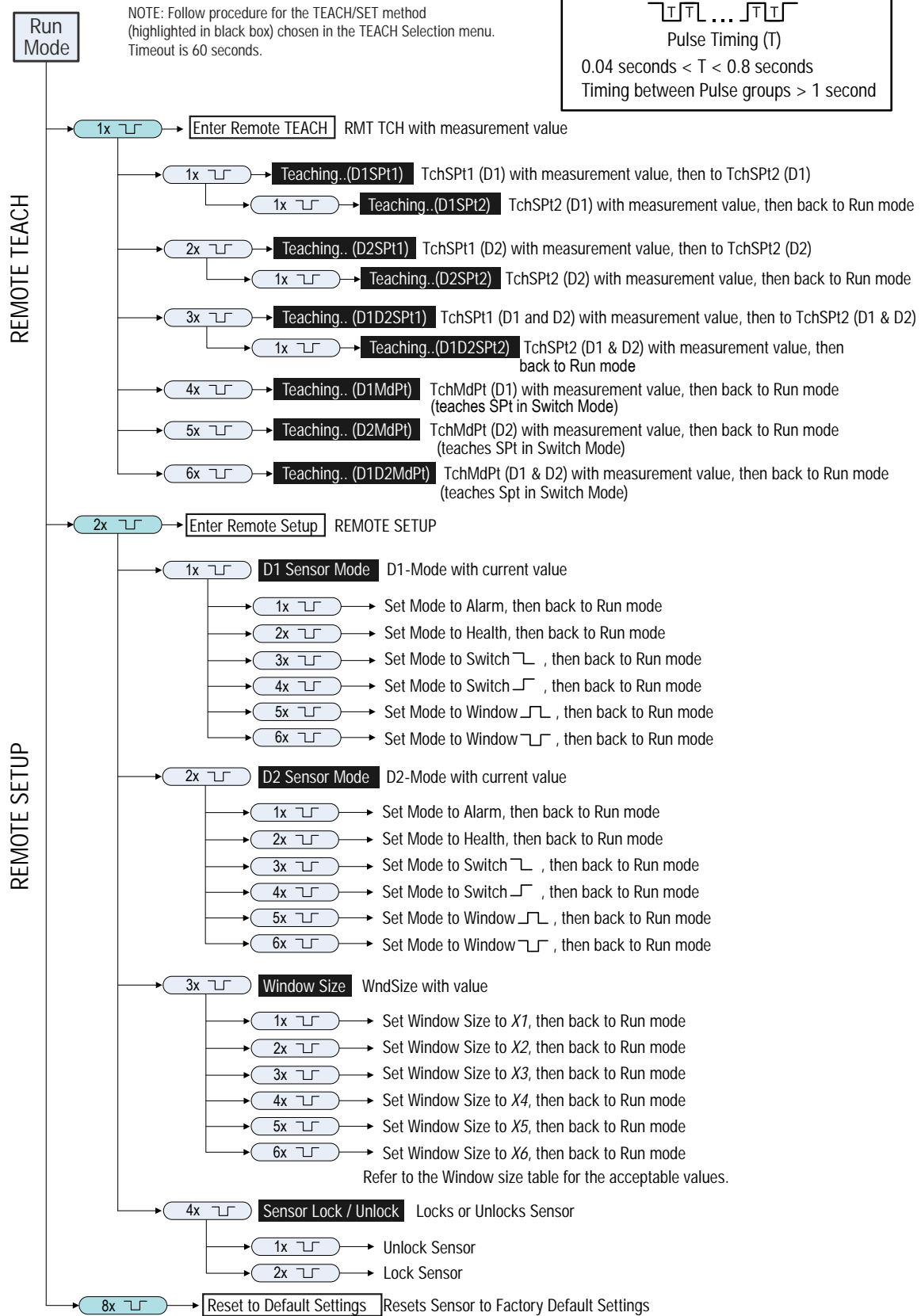



Figure 15. Remote Input Map



Table 1: Window Size (WndSize)

Variable	LE250 Models	LE550 Models	Variable	LE250 Models	LE550 Models
X1	1 mm	10 mm	X4	100 mm	300 mm
X2	10 mm	50 mm	X5	150 mm	500 mm
X3	50 mm	100 mm	X6	250 mm	800 mm

### 3.4 Locking and Unlocking the Sensor

Use the lock and unlock feature to prevent unauthorized or accidental programming changes. A lock symbol  displays in the upper left corner of the display to indicate when the sensor is locked. When locked, the menus are available to view settings, but the values cannot be changed. The remote input is also disabled, except for the unlock function.

#### Button Instructions

To lock or unlock the sensor using the buttons, press and hold Down  and Escape  simultaneously for 3 seconds.

#### Remote Input Instructions

1. Access the setup mode.

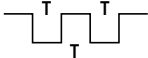
Action		Result
Double-pulse the remote input.		"REMOTE SETUP" displays.

2. Access the lock/unlock function.

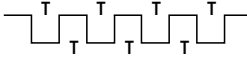
Action		Result
Four-pulse the remote input.		"LOCK" and the current status (unlocked or locked) display.

3. Lock or unlock the sensor.

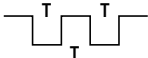
Action		Result
Unlock : Single-pulse the remote line.		"Unlocked" flashes and the sensor returns to Run mode. The sensor is unlocked.
Lock: Double-pulse the remote input.		"Locked" flashes and the sensor returns to Run mode. The sensor is locked and the lock symbol displays in the upper left corner.

### 3.5 Discrete Output Menu (Dx\_OUT)

Use this menu to view or change

- Setpoints
- Midpoint
- Mode
- Timers
- Polarity

The menu options are identical for D1\_OUT and D2\_OUT.

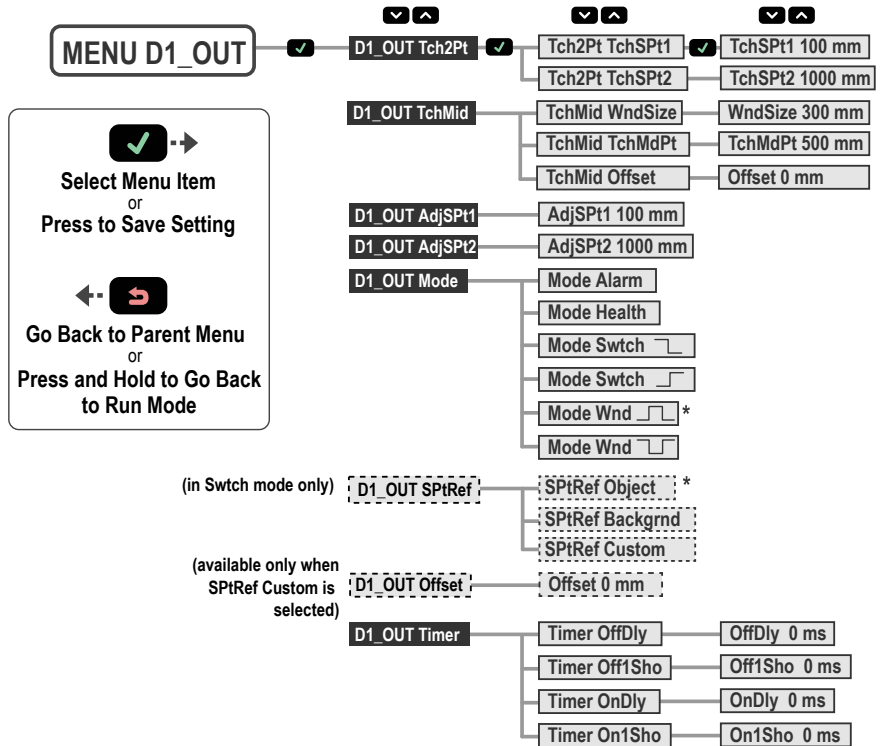

Figure 16. Discrete 1 Output Menu Map (Discrete 2 is identical)

#### 3.5.1 Two-Point TEACH

The TchSpt1 and TchSpt2 options teach the desired switch points. When using the buttons, the switch points can be taught independently. Both values must be taught when using the remote input. The same TEACH menus exist for both the D1\_OUT and D2\_OUT, but the switch points are set independently.



NOTE: When in Switch mode, use [TEACH Switch Point](#) on page 17.

Navigate: MENU > Dx\_OUT > Tch2Pt > TchSpt1 and navigate: MENU > Dx\_OUT > Tch2Pt > TchSpt2

Remote Input: Available

Button Instructions

1. Present the target.

Action	Result
Present the target. The target must be within the sensor's range..	The target's distance measurement value displays.

2. Access the TEACH mode and TEACH the sensor.

Action	Result
Navigate: MENU > Dx_OUT > Tch2Pt > TchSPt1 OR Navigate: MENU > Dx_OUT > Tch2Pt > TchSPt2	The selected TEACH mode and "Teaching" display while the sensor is being taught. <u>TEACH Accepted</u> The new value is shown on the second line of the display and flashes before it is saved and the sensor returns to the parent menu. <u>TEACH Not Accepted</u> "FAIL" and a warning message display, and the sensor returns to the parent menu.

- Repeat steps 1 to 2 for the other switch point, if desired.

Remote Input Instructions

- Access the TEACH mode.

Action	Result
Single-pulse the remote input. 	"RMT TCH" and the current switch point value displays.

- Present the target.

Action	Result
Present the switch point one target.	"RMT TCH" and the target's measurement value display.

- TEACH the sensor.

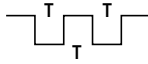
Action	Result
Double-pulse the remote input. 	"TchSPt1 Teaching" displays while the sensor is being taught. <u>TEACH Accepted</u> The new value displays on the second line of the display, flashes, and the sensor goes to "TchSPt2" and the current measurement value. <u>TEACH Not Accepted</u> "FAIL" flashes, the sensor returns to step 2, and "RMT TCH" displays.

- Present the target.

Action	Result
Present the switch point two target.	"TchSPt2" and the target's measurement value display.

- TEACH the sensor.

Action	Result
Single-pulse the remote input. 	"TchSPt2 Teaching" displays while the sensor is being taught. <u>TEACH Accepted</u> The new value displays on the second line of the display, flashes, and the sensor returns to Run mode. <u>TEACH Not Accepted</u> "FAIL" flashes, the sensor returns to step 2, and "RMT TCH" displays.

### 3.5.2 Midpoint TEACH

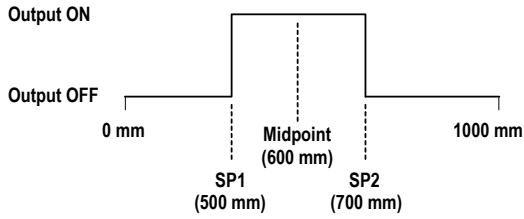

Figure 17. Window and Midpoint Example

The Midpoint TEACH uses both the window size and the TEACH midpoint to determine the actual measurement window. For example, a window of 200 mm with a midpoint of 600 mm places the measurement window from 500 mm to 700 mm.

To use Midpoint TEACH:

1. Set the window size.
2. Set the measurement window using [TEACH Midpoint](#) on page 16.

#### Window Size

The WndSize option sets the window size that the Midpoint TEACH uses to set the setpoint one and setpoint two thresholds.

The Midpoint TEACH fails if the window is not taught within the valid measurement range.

	LE250 Laser Sensor	LE550 Laser Sensor
Window Size Minimum	1 mm	10 mm
Window Size Maximum	250 mm	800 mm
Range	100 mm to 400 mm	100 mm to 1000 mm
Default Window Size	50 mm	300 mm



Navigate: MENU > Dx\_OUT > TchMid > WndSize

Remote Input: Available

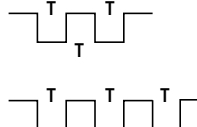
1. Access the setup mode.

Method	Action	Result
Push Button	Navigate: MENU > Dx_OUT > TchMid > WndSize .	"WndSize" and the current window size value display.
Remote Input	a. Double-pulse the remote input to enter setup mode. b. Three-pulse the remote input to enter window size mode.	 a. "REMOTE SETUP" displays. b. "WndSize" and the current value display.

2. Set the window size.

Method	Action	Result
Push Button	a. Use Down  and Up  to set the desired window size—the value changes in increments of 2. b. Press Enter  to save the new value.	a. "WndSize" and the new value display. b. The new value flashes and returns to "TchMid WndSize".

Method	Action	Result		
Remote Input (Sets A_OUT and D_OUT window Size)	Pulse the remote input 1 to 6 times to select the desired window size.	The new value flashes and the sensor returns to Run mode.		
	Window Size			
	Pulses		LE250	LE550
	1		1 mm	10 mm
	2		10 mm	50 mm
	3		50 mm	100 mm
	4		100 mm	300 mm
	5		150 mm	500 mm
6	250 mm	800 mm		

### TEACH Midpoint

The TchMdPt option sets the midpoint that determines the actual measurement window.

Navigate: MENU > Dx\_OUT > TchMid > TchMdPt

Remote Input: Available

Button Instructions

1. Present the target.

Action	Result
Present the target.	The target's distance measurement value displays.

2. Access the TEACH midpoint mode and TEACH the sensor.

Action	Result
Navigate: MENU > Dx_OUT > TchMid > TchMdPt	<p>"TchMdPt Teaching" displays while the sensor is being taught.</p> <p><u>TEACH Accepted</u></p> <p>The new value is shown on the second line of the display and flashes before it is saved and the sensor returns to "TchMid TchMdPt".</p> <p><u>TEACH Not Accepted</u></p> <p>"FAIL" and a warning message display, and the sensor returns to "TchMid TchMdPt".</p>

Remote Input Instructions

1. Access the TEACH mode.

Action	Result
Single-pulse the remote input. 	"RMT TCH" and the current measurement value display.

2. Present the target.

Action	Result
Present the target.	"RMT TCH" and the target's measurement value display.



3. TEACH the sensor.

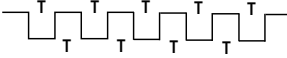

Action	Result
Five-pulse the remote input. 	"TchMdpt Teaching" displays while the sensor is being taught. <u>TEACH Accepted</u> The new value displays on the second line of the display, flashes, and the sensor returns to Run mode. <u>TEACH Not Accepted</u> "FAIL" and a warning message display, the sensor returns to step 2, and "RMT TCH" displays.

### Offset

Use the TEACH MidPoint Offset menu to set an offset from the taught surface. This menu is available only for a midpoint

TEACH (TchMid). The default is 0 mm because the window is centered around the taught target. Use  and  to select a value. Values increase or decrease by 0.1 mm (LE250) or 1.0 mm (LE550). A positive offset value always shifts the window towards the sensor.

The taught surface must be inside of the defined sensing range. After the offset is applied, some portion of the window must be located within the sensing range. If the entire window is offset out of range, the TEACH fails and the "Fail / OfSt" error message displays.

### 3.5.3 Adjust Switch Point One

The AdjSPT1 option manually adjusts the value of the switch point one threshold for the Discrete Output when the sensor is in Window mode. The value is adjustable within the sensor's range. It is required to be maintain the minimum window size between switch points. This menu is not available when the sensor is in Switch, Alarm, or Health mode.

Navigate: MENU > Dx\_OUT > AdjSPT1

Remote Input: Not available

Default: 100 mm for both the LE250 and LE550 models.

### 3.5.4 Adjust Switch Point Two

The AdjSPT2 option manually adjusts the value of the switch point two threshold for the Discrete Output when the sensor is in Window mode. The value is adjustable with the sensor's range. It is required to be maintain the minimum window size between switch points. This menu is not available when the sensor is in Switch, Alarm, or Health mode.

Navigate: MENU > Dx\_OUT > AdjSPT2

Remote Input: Not available

Default: 400 mm for LE250 models and 1000 mm for LE550 models.

### 3.5.5 TEACH Switch Point

The TchSPt option teaches the distance at which the switch point threshold is placed when the Discrete Output is in Switch mode. This menu is not available when the sensor is in Window, Alarm, or Health mode.

Navigate: MENU > Dx\_OUT > TchSPt

Remote Input: Available

Button Instructions

1. Present the target.

Action	Result
Present the target. The target must be within the sensor's range.	The target's distance measurement value displays.

2. Access the switch point TEACH mode and TEACH the sensor.

Action	Result
Navigate: MENU > Dx_OUT > TchSPt	<p>"TchSPt Teaching" displays while the sensor is being taught.</p> <p><u>TEACH Accepted</u></p> <p>The new value is shown on the second line of the display and flashes before it is saved and the sensor returns to "Dx_OUT TchSPt".</p> <p><u>TEACH Not Accepted</u></p> <p>"FAIL" and a warning message display, and the sensor returns to "Dx_OUT TchSPt".</p>

### Remote Input Instructions

1. Verify the sensor is in Switch mode.
2. Access the TEACH mode.

Action	Result
Single-pulse the remote input. 	"RMT TCH" and the current measurement value display.

3. Present the target.

Action	Result
Present the target.	"RMT TCH" and the target's measurement value display.

4. TEACH the sensor.

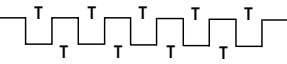
Action	Result
Five-pulse the remote input. 	<p>"TchSPt Teaching" displays while the sensor is being taught.</p> <p><u>TEACH Accepted</u></p> <p>The new value displays on the second line of the display, flashes, and the sensor returns to Run mode.</p> <p><u>TEACH Not Accepted</u></p> <p>"FAIL" flashes, the sensor returns to step 3, and "RMT TCH" displays.</p>

### 3.5.6 Adjust Switch Point

The AdjSPt option manually adjusts the value of the switch point threshold for the discrete output when the sensor is in Switch mode. The value is adjustable within the sensor's range. This menu is not available when the sensor is in Window, Alarm, or Health mode.

Navigate: MENU > Dx\_OUT > AdjSPt

Remote Input: Not available

Default: 100 mm for the LE250 and LE550 models

### 3.5.7 Mode





The Mode option sets the output to the desired mode.

Navigate: MENU > Dx\_OUT > Mode

Remote Input: Available

Default: Wnd  mode

The following table describes the sensor modes.

Mode	Description
Alarm	Alarm Mode: The Discrete Output is Off while a target is detected by the sensor at any distance. When a loss of signal occurs, the Discrete Output is On. This mode has no associated thresholds.
Health	Health Mode: The Discrete Output is On while a target is detected by the sensor at any distance. When a loss of signal occurs, the Discrete Output is Off. This mode has no associated thresholds.
Switch 	Switch Mode: The Discrete Output is On while a target is detected nearer than the switch point threshold. When a target is detected farther than the switch point threshold or the signal is lost, the Discrete Output is Off.
Switch 	Switch Mode: The Discrete Output is Off while a target is detected nearer than the switch point threshold. When a target is detected farther than the switch point threshold or the signal is lost, the Discrete Output is On.
Wnd 	Window Mode: The Discrete Output is On while a target is detected between the SPt1 and SPt2 thresholds. (Default) When a target is detected outside the SPt1 and SPt2 thresholds or the signal is lost, the Discrete Output is Off.
Wnd 	Window Mode: The Discrete Output is Off while a target is detected between the SPt1 and SPt2 thresholds. When a target is detected outside the SPt1 and SPt2 thresholds or the signal is lost, the Discrete Output is On.

### Remote Input Instructions



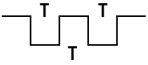



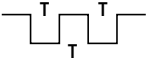



1. Access the setup mode.

Action		Result
Double-pulse the remote input.		"REMOTE SETUP" displays.

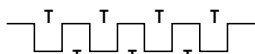
2. View the current mode.

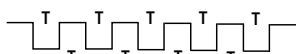
Action		Result
Double-pulse the remote input.		The current mode displays.

3. Program the sensor.

Action		Result
Pulse the remote input 1 to 6 times to select the desired mode.		The selected mode flashes and the sensor returns to Run mode.
Pulses	Mode	
1 	Alarm	
2 	Health	
3 	Swtch 	
4 	Swtch 	
5 	Wnd 	
6 	Wnd 	

### 3.5.8 Switch Point Reference (SPtRef)

The SPtRef menu only displays for a discrete output when it is set to switch mode. The SPtRef settings, object or background, for the two discrete outputs are set independently. This setting cannot be changed with remote teach.

- Object (default). Object mode sets the switching threshold just past the location of the taught object, farther away from the sensor's face.
- Background. Background mode sets the switching threshold in front of the taught object, closer to the sensor's face.
- Custom. Custom mode allows the user to define the location of the switching threshold relative to a taught distance using the Offset menu that appears only after selecting Custom Switch Point Reference.

The distance between the surface of the taught object and the switching threshold varies depending on measurement strength and can be affected by target distance, color, reflectivity, etc. Use object mode when teaching an object if a change in state is required when the object is no longer present. Use background mode when teaching background so that the output state changes when a new object is in front of the background.

Navigate: MENU > Dx\_OUT > SPtRef

Remote Input: Not available

Default: Object

### 3.5.9 Switch Point TEACH Offset

Use this menu to set an offset from the taught distance after a switch point TEACH, if SPtRef is set to Custom.

By default, the value is 0 mm. A positive offset value always shifts the threshold towards the sensor.

Navigate: MENU > Dx\_OUT > TchMd > Offset

Remote Input: Not available

Default: 0 mm

### 3.5.10 Timer

The Timer option sets the delays and timers. On/Off Delays and On/Off One-Shot timers can be programmed between 1 to 9999 ms (a value of 0 disables the delay/timer). *Figure 18* on page 21 defines how the delays/timers affect the output behavior.

Navigate: MENU > Dx\_OUT > Timer

Remote Input: not available

Default: 0 ms for all timers

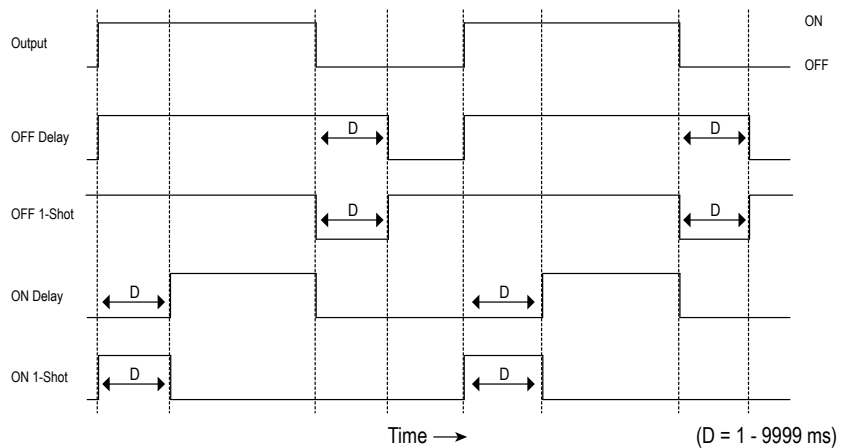

Figure 18. Delays/Timers

Some combinations of delays/timers are not allowed. The programming menu automatically disables invalid combinations of delays/timers. The following table shows the allowable combinations of delays/timers.

	Off Delay	Off One-Shot Timer	On Delay	On One-Shot Timer
Off Delay (OffDly)	OK	OK	OK	N/A
Off One-Shot Timer (Off1Sho)	OK	OK	N/A	N/A
On Delay (OnDly)	OK	N/A	OK	OK
On One-Shot Timer (On1Sho)	N/A	N/A	OK	OK

### 3.6 Input Menu (INPUT)

Use this menu to view or change the:

- Multi-function input type

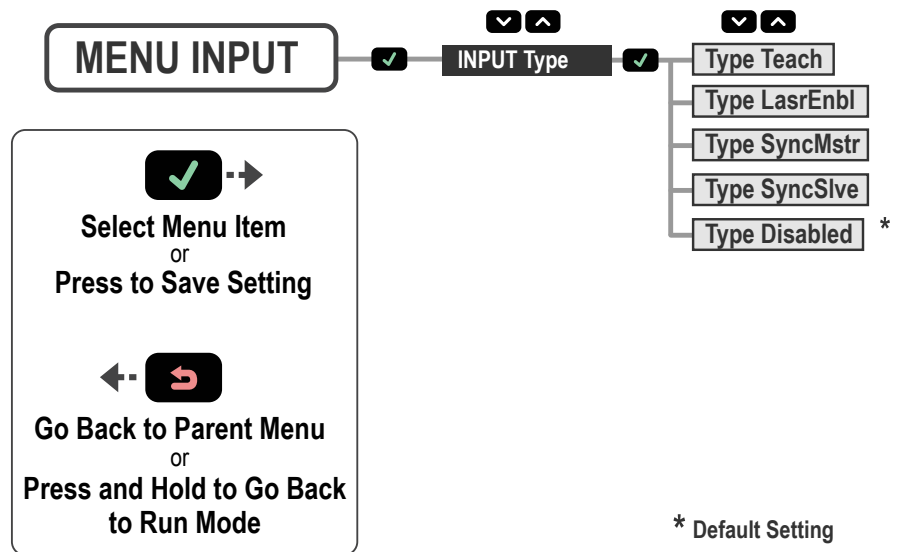

Figure 19. Input Menu Map

#### 3.6.1 Input Type

The Type option sets the input type.

Navigate: MENU > INPUT > Type

Remote Input: Not available

Default: Disabled

Input Type	Description
Teach	The remote input is used to TEACH and program the sensor. (Default)
LasrEnbl	The remote input is used to control when the laser emitter is On/Off.
SyncMstr	The remote input is used as the Master Sync output to an attached Slave sensor (see <a href="#">Sync Master/Slave</a> on page 26).
SyncSlve	The remote input is used as the Slave Sync input from an attached Master sensor (see <a href="#">Sync Master/Slave</a> on page 26).
Disabled	The remote input is disabled.

### 3.7 Measure Menu (MEASURE)

Use this menu to view or change the:

- Speed

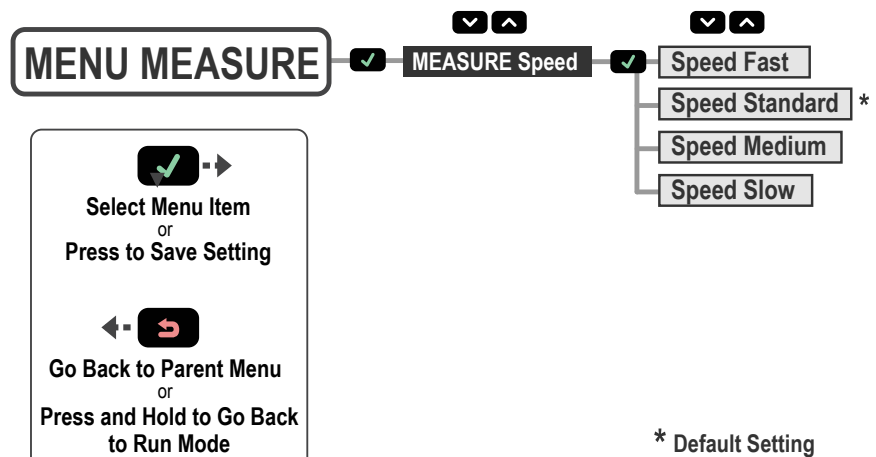

Figure 20. Measure Menu Map

#### 3.7.1 Speed

The Speed option sets the speed at which the measurement is calculated. This process uses averaging in the digital processing of the signal to calculate the measurement. A slower speed increases the response time of the sensor but improves the repeatability. See [Figure 27](#) on page 30 for repeatability specifications for each speed.

Navigate: MENU > MEASURE > Speed

Remote Input: Not available

Default: Standard

Speed	Class 1 Laser Models		Class 2 Laser Models	
	Response Time	Response Time in Sync Mode	Response Time	Response Time in Sync Mode
Fast	2 ms	4 ms	2 ms	4 ms
Standard	10 ms (default)	20 ms	5 ms (default)	10 ms
Medium	30 ms	60 ms	15 ms	30 ms
Slow	100 ms	200 ms	50 ms	100 ms

## 3.8 Display Menu (DISPLAY)

Use this menu to view or change the:

- Display units
- Display orientation
- Sleep mode settings

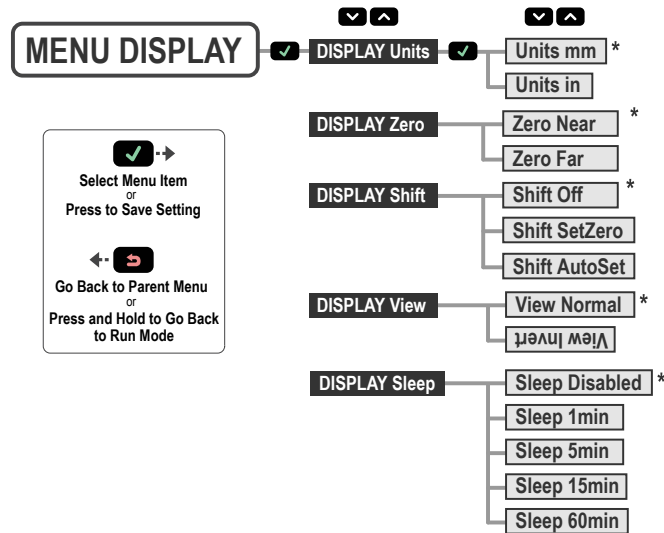

Figure 21. Display Menu Map

### 3.8.1 Units

The Units option sets the displayed units to millimeters (mm) or inches (").

Navigate: MENU > DISPLAY > Units

Remote Input: Not available

Default: mm

### 3.8.2 Zero

Use this menu to select the zero reference location. The default is Near, where 0 = the front of the sensor.

- Near—0 = the front of the sensor; the measurement increases further from the sensor
- Far—0 = maximum range; the measurement increases closer to the sensor

Navigate: MENU > DISPLAY > Zero

Remote Input: Not available

Default: Near

### 3.8.3 Shift

Use this menu to select whether the sensor shifts the zero reference location based on the last TEACH process. The default is off, where 0 = the front of the sensor or the maximum range.

- Off—0 = the front of the sensor or the maximum range, depending on the Zero setting.
- AutoSet—Shift the zero reference location to one of the taught positions with each TEACH. The zero reference location is reset when teaching either output.
- SetZero—Teaches the current target as its new zero reference location.

### 3.8.4 View

The View option sets the display orientation of the sensor. For applications where the sensor must be mounted so that the display is not right-reading, invert the display for readability. The Down and Up buttons do not change when the display is inverted.

Navigate: MENU > DISPLAY > View

Remote Input: Not available

Default: Normal



Figure 22. LE550 Normal Display Orientation



Figure 23. LE550 Inverted Display Orientation

### 3.8.5 Sleep

The Sleep option sets when the display is put to sleep. Four timing options are available: 1, 5, 15, or 60 minutes. Sleep mode is disabled by default. Sleep occurs in Run mode and any menu. To wake the sensor and return to the last viewed mode or menu, press any button.

Navigate: MENU > DISPLAY > Sleep

Remote Input: Not available

Default: Disabled

## 3.9 Information Menu (INFO)

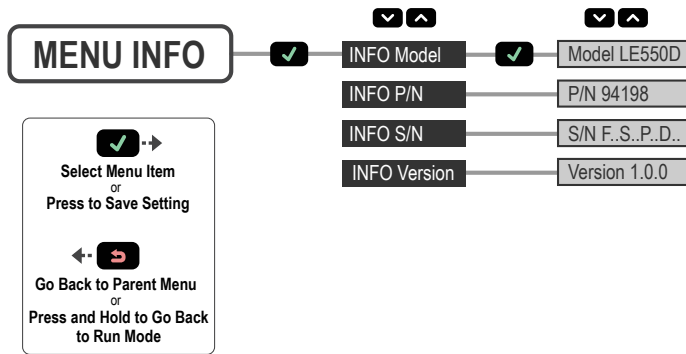

Figure 24. LE550 Information Menu Map

Use this menu to view model, part number (P/N), serial number (S/N), and firmware version (Version) information. Select one of these options to view specific information for your sensor. This information is read-only.

Navigate: MENU > INFO

Remote Input: Not available



### 3.10 Reset Menu (RESET)

Use this menu to restore the sensor to the factory default settings.

Navigate: MENU > RESET. Select Yes to apply the factory defaults; select No to return to the Reset option without changing any sensor settings.

Remote Input: Eight-pulse the remote input

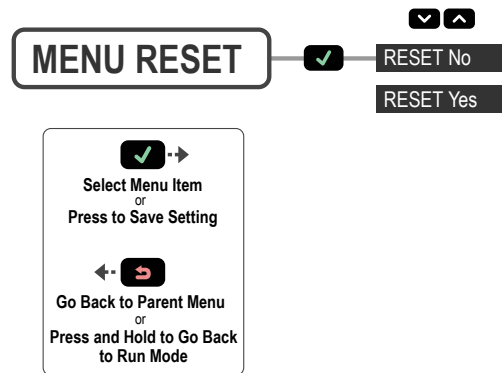
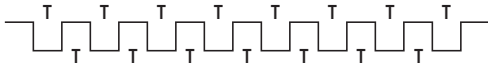

Figure 25. Reset Menu Map

#### 3.10.1 Factory Default Settings

Discrete Output Settings	LE250	LE550
Adjust Switch Point One	100 mm	100 mm
Adjust Switch Point Two	400 mm	1000 mm
Mode	Wnd	
Timer	0 ms for all timers	
Window Size	50 mm	300 mm

Input Settings	LE250 and LE550
Input Type	Disabled

Measure Settings	LE250 and LE550
Speed	Standard

Display Settings	LE250 and LE550
Sleep	Disabled
Units	mm
View	Normal

## 4 Sync Master/Slave

Two LE250/550 Laser sensors may be used together in a single sensing application. To eliminate crosstalk between the two sensors, configure one sensor to be the master and one to be the slave. In this mode, the sensors alternate taking measurements and the response speed doubles.

1. Configure the first sensor as the master; navigate: MENU > INPUT > Type > SyncMstr.
2. Configure the second sensor as the slave; navigate: MENU > INPUT > Type > SyncSlve.
3. Connect the gray (input) wires of the two sensors together.

If using a combination of Class 1 and Class 2 laser models, the Class 1 laser model must be used as the master.

## 5 Additional Remote TEACH Procedures

### 5.1 TEACH Both Discrete Output Switch Points Together

Use the following procedure to teach both Discrete Output switch points at the same time using the remote input. This feature is not available using the buttons.

1. Access the TEACH mode.

Action		Result
Single-pulse the remote input.		"RMT TCH" and the current measurement value display.

2. Present the target.

Action		Result
Present the switch point one target.		"RMT TCH" and the target's measurement value display.

3. TEACH the sensor.

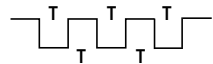
Action		Result
Three-pulse the remote input.		<p>"D1D2Spt1 Teaching" displays while the sensor is being taught.</p> <p><u>TEACH Accepted</u></p> <p>The new value displays on the second line of the display, flashes, and then "D1D2Spt2" and the current measurement value display.</p> <p><u>TEACH Not Accepted</u></p> <p>"FAIL" flashes, the sensor returns to step 2, and "RMT TCH" displays.</p>

4. Present the target.

Action		Result
Present the switch point two target.		"D1D2Spt2" and the target's measurement value display.

5. TEACH the sensor.

Action		Result
Single-pulse the remote input.		<p>"D1D2Spt2 Teaching" displays while the sensor is being taught.</p> <p><u>TEACH Accepted</u></p> <p>The new value displays on the second line of the display, flashes, and the sensor returns to Run mode.</p> <p><u>TEACH Not Accepted</u></p> <p>"FAIL" flashes, the sensor returns to step 2, and "RMT TCH" displays.</p>

### 5.2 TEACH Both Discrete Output Midpoints Together

Use the following procedure to teach an identical discrete output midpoint (switch point) for both D1\_OUT and D2\_OUT at the same time using the remote input. This feature is not available using the buttons. Note that if the window sizes were set independently (using the buttons), the windows taught using the following procedure could be different.

1. Access the TEACH mode.

Action	Result
Single-pulse the remote input. 	"RMT TCH" and the current measurement value display.

2. Present the target.

Action	Result
Present the midpoint (switch point) target.	"RMT TCH" and the target's measurement value display.

3. TEACH the sensor.

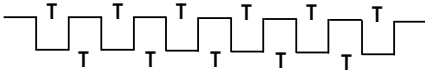
Action	Result
Six-pulse the remote input. 	<p>"D1D2MdPt Teaching" displays while the sensor is being taught.</p> <p><u>TEACH Accepted</u></p> <p>The new value displays on the second line of the display, flashes, and the sensor returns to Run mode.</p> <p><u>TEACH Not Accepted</u></p> <p>"FAIL" flashes, the sensor returns to step 2, and "RMT TCH" displays.</p>

## 6 Specifications

### Supply Voltage (Vcc)

12 to 30 V dc

### Power and Current Consumption, exclusive of load

Normal Run Mode: 1.7 W, Current consumption < 70 mA at 24 V dc

### Supply/Output Protection Circuitry

Protected against reverse polarity and transient overvoltages

### Output Configuration

D1\_Out: IO-Link, Push/pull

D2\_Out: PNP

### Output Ratings

100 mA maximum capability each output

Saturation: Less than 2 V

Off-State Leakage Current: Less than 50 µA PNP at 30 V (N.A. push/pull)

### Remote I Input

Allowable Input Voltage Range: 0 to Vcc

Active High (internal weak pulldown—sourcing current):

High State > Vcc – 1.5 V dc

Low State < Vcc – 5 V dc

Input Impedance > 10 kOhm

### Measurement/Output Rate

Class 2 Laser Models: < 1 ms

Class 1 Laser Models (Fast): < 1 ms

Class 1 Laser Models (Std/Medium/Slow): < 2 ms

### Typical Beam Spot Size<sup>1</sup>

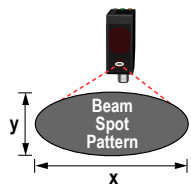

	Distance (mm)					
	LE250 Models			LE550 Models		
	100	250	400	100	550	1000
x	3.2	2.1	1.2	8.4	10.5	12.1
y	2.2	1.5	0.9	3.5	4.2	4.9

### IO-Link Interface

Supports Smart Sensor Profile: Yes

Baud Rate: 38400 bps

Process Data Widths: 32 bits

IODD files: Provides all programming options of the display, plus additional functionality

### Sensing Beam

Class 2 laser models: visible red, 650 nm

Class 1 laser models: visible red, 650 nm

### Sensing Range

LE250: 100 mm to 400 mm (3.94 to 15.75 inches)

LE550: 100 mm to 1000 mm (3.94 to 39.37 inches)

### Minimum Window Size

LE250: 1 mm (0.039 inches)

LE550: 10 mm (0.39 inches)

### Boresighting

LE250: 4 mm radius at 400 mm

LE550: 1 cm radius at 1 m

### Maximum Torque

2 N·m (17.7 in-lbs)

### Indicators

Power LED Indicator

Solid Green = Normal operation, power On and laser On

Flashing Green (1 Hz) = Power On and laser Off (laser enable mode)

Discrete Output LED Indicator

Solid Amber = Discrete Output is On

Off = Discrete Output is Off

### Construction

Housing: die-cast zinc

Window: acrylic

### Ambient Light Immunity

Class 2 laser models: > 10,000 lux

Class 1 laser models: > 5,000 lux

### Response Time

	Class 1 Laser Models	Class 2 Laser Models
Fast <sup>2</sup>	2 ms	2 ms
Standard	10 ms	5 ms
Medium	30 ms	15 ms
Slow	100 ms	50 ms

### Delay at Power Up

3 s

### Repeatability

See *Performance Curves*

### Temperature Effect

See *Performance Curves*

<sup>1</sup> Beam spot size is calculated as 1.6 times the D4σ measured value

<sup>2</sup> Response time for lateral entry of object into measurement range < 5 ms

Environmental Rating  
IEC IP67, NEMA 6

Operating Conditions  
-20 °C to +55 °C (-4 °F to +131°F)  
90% at +55 °C maximum relative humidity (non-condensing)

Storage Temperature  
-30 °C to +65 °C (-22 °F to +149 °F)

Vibration/Mechanical Shock  
All models meet Mil. Std. 202 G requirements method 201A. Also meets IEC 60947-5-2.

Application Note  
For optimum performance, allow 10 minutes for the sensor to warm up

Certifications



UL Environmental Rating: Type 1



Required Overcurrent Protection



**WARNING:** Electrical connections must be made by qualified personnel in accordance with local and national electrical codes and regulations.

Overcurrent protection is required to be provided by end product application per the supplied table. Overcurrent protection may be provided with external fusing or via Current Limiting, Class 2 Power Supply. Supply wiring leads < 24 AWG shall not be spliced. For additional product support, go to [www.bannerengineering.com](http://www.bannerengineering.com).

Supply Wiring (AWG)	Required Overcurrent Protection (Amps)
20	5.0
22	3.0
24	2.0
26	1.0
28	0.8
30	0.5

## 6.1 Performance Curves

LE250 Dual Discrete Models

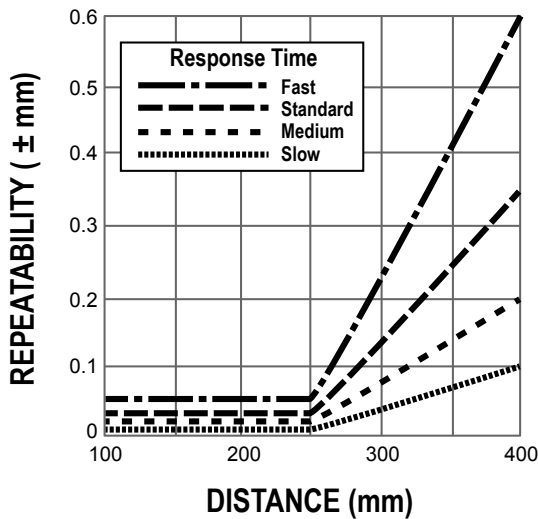

Figure 26. Repeatability (90% to 6% reflectance)

LE550 Dual Discrete Models

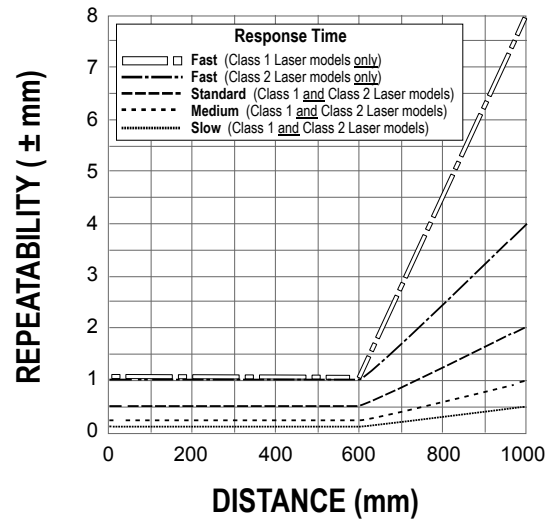

Figure 27. Repeatability (90% to 6% reflectance)

LE250 Dual Discrete Models

LE550 Dual Discrete Models

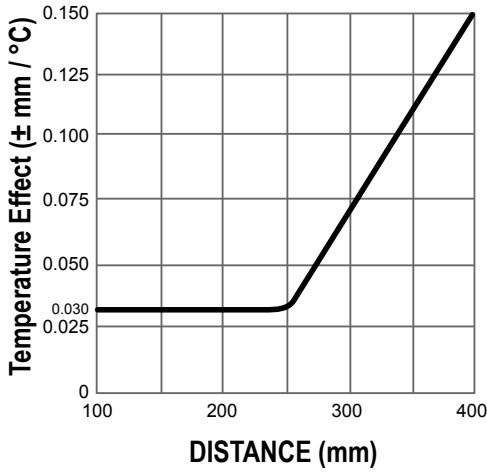

Figure 28. Temperature Effect

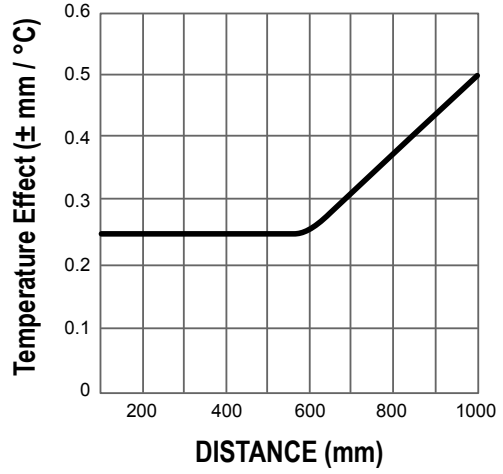
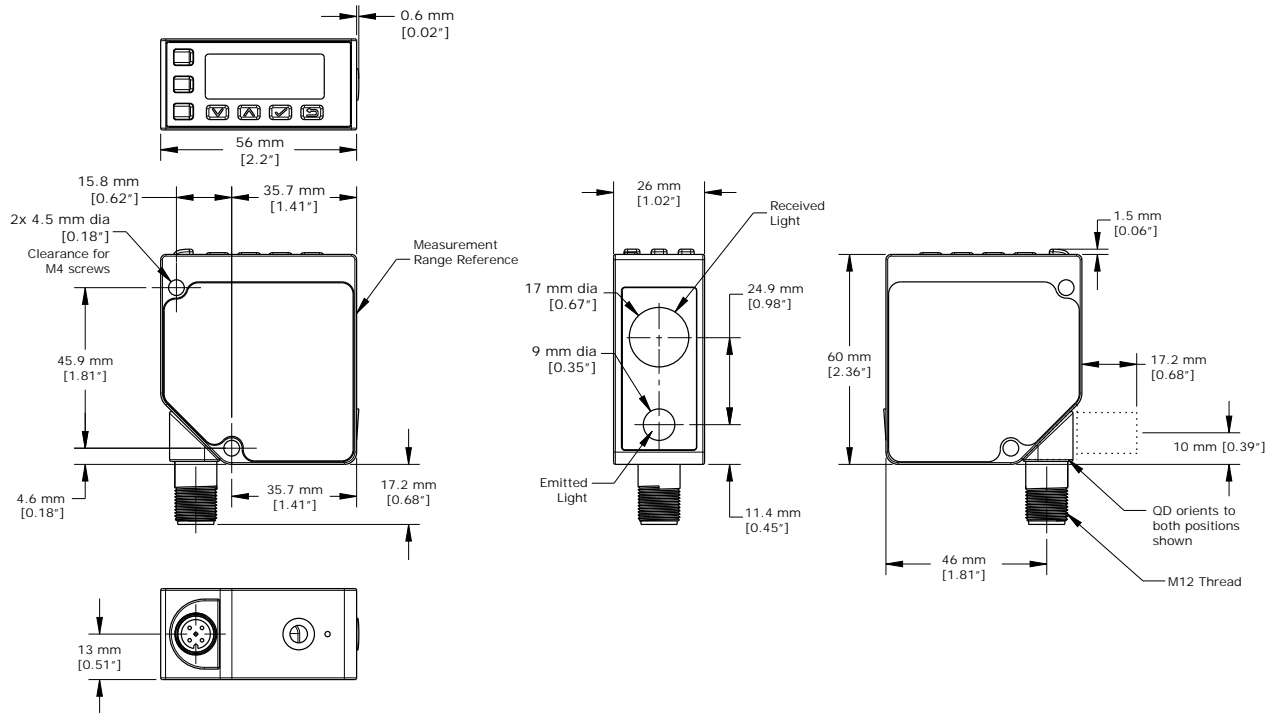

Figure 29. Temperature Effect

## 6.2 Dimensions

All measurements are listed in millimeters [inches], unless noted otherwise.



## 7 Troubleshooting

Message/Indicator	Description	Resolution
Fail/ Min Wnd OutRnge	The minimum window size is 1 mm for the LE250 models and 10 mm for the LE550 models. One point of the adjusted or taught window is out of range.	The sensor automatically returns to the previous setting.
Fail/ Out of Range	The TEACH failed, the target is out of range. The target might have moved out of range after the TEACH process began.	TEACH the switch point within the measurement range.
Fail/ OfSt Out of Range	The TEACH failed. The target is in range but the offset value caused the setpoint(s) to be out of range.	Adjust the offset value or target distance to keep the setpoint(s) within the measurement range.
MIN Wnd xx mm (xx in)	The adjusted or taught window size is too small; the minimum window size is displayed.	The sensor automatically adjusts the window size to maintain the minimum window size and completes the adjust or TEACH operation.
OutRnge	The target is out of range, too dark, or the sensor is not measuring.	Move the target within the measurement range.
Power LED is flashing green	The sensor input is set to laser enable and the input is not active.	See <a href="#">Input Type</a> on page 21.
Power LED is flashing red	The laser shut off, the Power LED flashes red and Output LEDs flash amber at 1Hz, and the display is blank.  The laser has experienced a fault.	Contact Banner Engineering to resolve.
SPTx < Near or SPTx > Far	One of the switch points is located outside the sensor's range, either too close to the sensor or too far away.	The desired window size is maintained, but the usable portion of the window is restricted to be within the sensor's range.
Type Sync Slave	The slave mode sensor does not see the master's pulse.	Verify the master mode sensor is configured and functioning properly. Check the input wire connection between the master and slave.



# 8 Sensor Menu Full Map

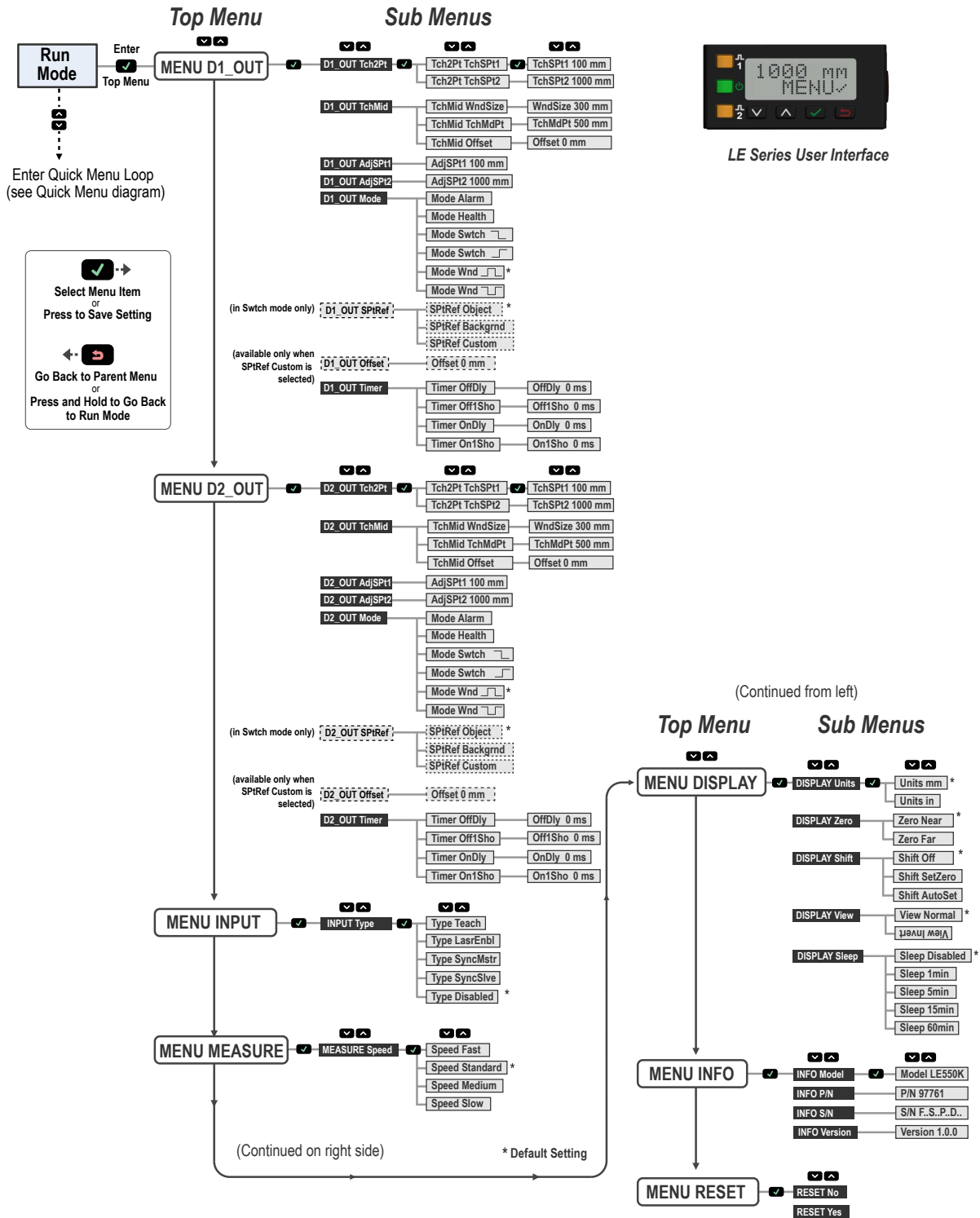

## 9 Accessories

### 9.1 Cordsets

All measurements are listed in millimeters, unless noted otherwise.

5-Pin Threaded M12/Euro-Style Cordsets—with Shield				
Model	Length	Style	Dimensions	Pinout (Female)
MQDEC2-506	1.83 m (6 ft)	Straight		
MQDEC2-515	4.57 m (15 ft)			
MQDEC2-530	9.14 m (30 ft)			
MQDEC2-550	15.2 m (50 ft)			
MQDEC2-506RA	1.83 m (6 ft)	Right-Angle		
MQDEC2-515RA	4.57 m (15 ft)			
MQDEC2-530RA	9.14 m (30 ft)			
MQDEC2-550RA	15.2 m (50 ft)			

### 9.2 Brackets

All measurements are listed in millimeters, unless noted otherwise.

#### SMBLEU

- Enclosed bracket
- 12 gauge stainless steel

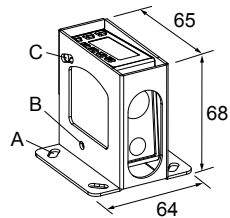

Hole size: A =  $\varnothing$  5 with 20° adjustability, B =  $\varnothing$  4.5, C =  $\varnothing$  4.5 with 10° adjustability

#### SMBLEL

- Right-angle bracket
- 12 gauge stainless steel

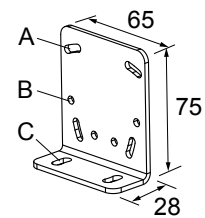

Hole size: A =  $\varnothing$  4.5 with 20° adjustability, B =  $\varnothing$  4.5, C =  $\varnothing$  5.7 with 20° adjustability

#### SMBLEFA

- Swivel plate bracket
- 12 gauge stainless steel

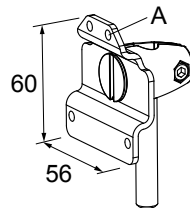

Hole size: A = 4x  $\varnothing$  4.5

#### SMBAMSLTFP

- AMS mounting pattern
- 12 gauge stainless steel

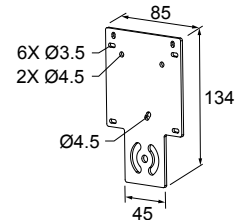

## 10 Banner Engineering Corp. Limited Warranty

Banner Engineering Corp. warrants its products to be free from defects in material and workmanship for one year following the date of shipment. Banner Engineering Corp. will repair or replace, free of charge, any product of its manufacture which, at the time it is returned to the factory, is found to have been defective during the warranty period. This warranty does not cover damage or liability for misuse, abuse, or the improper application or installation of the Banner product.

THIS LIMITED WARRANTY IS EXCLUSIVE AND IN LIEU OF ALL OTHER WARRANTIES WHETHER EXPRESS OR IMPLIED (INCLUDING, WITHOUT LIMITATION, ANY WARRANTY OF MERCHANTABILITY OR FITNESS FOR A PARTICULAR PURPOSE), AND WHETHER ARISING UNDER COURSE OF PERFORMANCE, COURSE OF DEALING OR TRADE USAGE.

This Warranty is exclusive and limited to repair or, at the discretion of Banner Engineering Corp., replacement. IN NO EVENT SHALL BANNER ENGINEERING CORP. BE LIABLE TO BUYER OR ANY OTHER PERSON OR ENTITY FOR ANY EXTRA COSTS, EXPENSES, LOSSES, LOSS OF PROFITS, OR ANY INCIDENTAL, CONSEQUENTIAL OR SPECIAL DAMAGES RESULTING FROM ANY PRODUCT DEFECT OR FROM THE USE OR INABILITY TO USE THE PRODUCT, WHETHER ARISING IN CONTRACT OR WARRANTY, STATUTE, TORT, STRICT LIABILITY, NEGLIGENCE, OR OTHERWISE.

Banner Engineering Corp. reserves the right to change, modify or improve the design of the product without assuming any obligations or liabilities relating to any product previously manufactured by Banner Engineering Corp. Any misuse, abuse, or improper application or installation of this product or use of the product for personal protection applications when the product is identified as not intended for such purposes will void the product warranty. Any modifications to this product without prior express approval by Banner Engineering Corp will void the product warranties. All specifications published in this document are subject to change; Banner reserves the right to modify product specifications or update documentation at any time. Specifications and product information in English supersede that which is provided in any other language. For the most recent version of any documentation, refer to: [www.bannerengineering.com](http://www.bannerengineering.com).