

DXM100-Sx Wireless Modbus Slave

Instruction Manual

Original Instructions
188231 Rev. B
21 October 2016
© Banner Engineering Corp. All rights reserved



188231

Contents

1 DXM100-Sx Overview	3
1.1 DXM100-Sx Modbus Slave System Overview	3
1.2 DXM Configuration Tool Overview	3
1.3 Overview of the DXM1xx-SxR2P Model	4
1.3.1 Basic Setup Requirements	4
2 DXM Hardware Configuration Overview	5
3 ISM Radio	6
3.1 ISM Radio Board (Modbus Slave ID 1)	6
3.1.1 DIP Switch Settings for the MultiHop HE5 Board Module	6
3.2 Binding the ISM Radio of a DXM100-Sx Modbus Slave	7
4 I/O Base Board for the DXM100-S1 Model	9
4.1 DXM100-S1 I/O Base Board Connections	9
4.1.1 DIP Switches for the I/O Board	9
4.1.2 I/O Board Jumpers	10
4.1.3 Setting the Modbus Slave ID on the I/O Base Board	10
4.2 Applying Power to the DXM100-Sx Modbus Slave	11
4.2.1 Using Courtesy Power or Switch Power	11
4.2.2 Associating a Switched Power Output to an Input	11
4.2.3 Connecting a Battery to the DXM Slave	13
4.2.4 Supplying Power from a Solar Panel	14
4.3 Working with Solar Power	14
4.3.1 Setting the DXM Slave for Solar Power	14
4.3.2 Solar Components	15
4.3.3 Recommended Solar Configurations	16
4.3.4 Monitoring Solar Operation	16
4.4 Connecting the Communication Pins	16
4.5 Inputs and Outputs	17
4.5.1 Universal Inputs	17
4.5.2 NMOS Outputs	18
4.5.3 Analog (DAC) Outputs	18
4.5.4 Modbus I/O Registers for the DXM100-S1x I/O Base Board	19
5 I/O Base Board for the DXM100-S2 Model	23
5.1 DXM100-B2 and S2 I/O Base Board Connections	23
5.1.1 DIP Switches for the I/O Board	23
5.1.2 Setting the Modbus Slave ID on the I/O Base Board	24
5.2 Applying Power to the DXM100-Sx Modbus Slave	24
5.2.1 Using Courtesy Power or Switch Power	25
5.2.2 Associating a Switched Power Output to an Input	25
5.2.3 Connecting a Battery to the DXM Slave	27
5.2.4 Supplying Power from a Solar Panel	27
5.3 Working with Solar Power	28
5.3.1 Setting the DXM Slave for Solar Power	28
5.3.2 Solar Components	28
5.3.3 Recommended Solar Configurations	29
5.3.4 Monitoring Solar Operation	30
5.4 Connecting the Communication Pins	30
5.5 Inputs and Outputs	31
5.5.1 Universal Inputs	31
5.5.2 NMOS Outputs	32
5.5.3 Analog (DAC) Outputs	32
5.5.4 DC Latching Outputs	33
5.5.5 SDI-12 Interface	33
5.5.6 Modbus I/O Registers for the DXM100-S2x I/O Base Board	33
6 DXM Modbus Registers	39
7 Restoring Factory Default Settings	40
8 DXM100 Dimensions	41
9 Contact Us	42
10 Warnings	43
10.1 Banner Engineering Corp. Limited Warranty	43

1 DXM100-Sx Overview

1.1 DXM100-Sx Modbus Slave System Overview

Banner's DXM Logic Controller integrates Banner's wireless radio and local I/O for a remote I/O device.

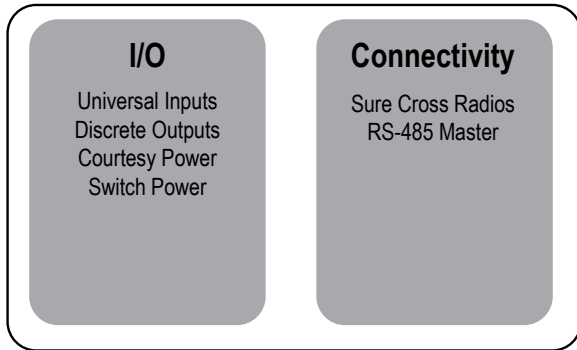

Inputs/Outputs—On-board universal and programmable I/O ports connect to local sensors, indicators, and control equipment.

- Universal Inputs
- Discrete outputs
- Courtesy power
- Switch power
- Battery backup
- Solar controller

Connectivity—The integrated Sure Cross[®] wireless radio enables Modbus connectivity to remote sensors, indicators, and control equipment.

Wired Connectivity

Field Bus: Modbus RS-485 Master

Wireless Connectivity

Sure Cross Wireless Radio: DX80 900 MHz, DX80 2.4 GHz, MultiHop 900 MHz, or MultiHop 2.4 GHz

1.2 DXM Configuration Tool Overview

The DXM Configuration Tool configures the DXM Slave by creating an XML file that is transferred to the DXM Slave using a USB or Ethernet connection. The DXM Slave can also receive the XML configuration file from a Web server using a cellular or Ethernet connection.

This configuration file governs all aspects of the DXM Slave operation. The wireless network devices are a separate configurable system. Use the DX80 User Configuration Tool (UCT) to configure the internal DX80 wireless Gateway and the attached wireless Nodes. Use the MultiHop Configuration Tool (MCT) if the internal radio is a MultiHop device.

All tools can be connected to the DXM Slave using a USB cable or an Ethernet connection.

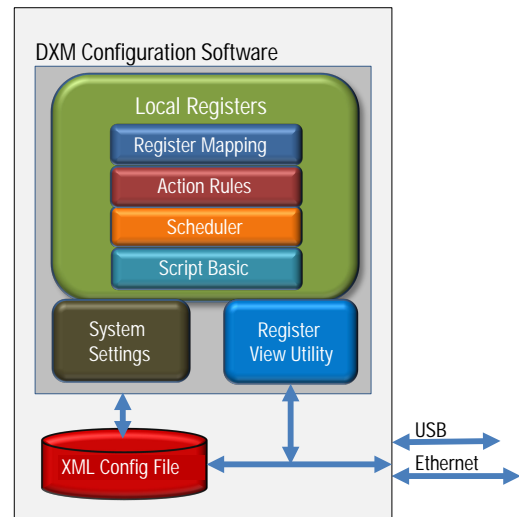

1.3 Overview of the DXM1xx-SxR2P Model

The DXM1xx-SxR2P model is a smart slave device that uses a MultiHop ISM radio plugged into the processor board instead of a cellular modem. This allows the DXM Slave to be connected to a MultiHop ISM network as a Modbus slave device and also be a Modbus master device to the other internal ISM radio on the base board.

The MultiHop radio on the processor board is defined in the radio network as Modbus ID 1 and is a pass-through only device. No messages are destined for the radio itself.

The DXM Slave must be assigned a Modbus ID, to allow the host to communicate directly with the Local Registers of the DXM Slave. Assign the Modbus ID to the DXM Slave using the LCD menu.

In the example below, the host can send a message to Modbus device 20 and it passes through the radios to the DXM Slave. The host can only interact with the Local Registers. This creates a wall of separation between the two networks, with the bridge being the Local Registers. The DXM Slave must be configured to pass data between the separate networks using the Local Registers.

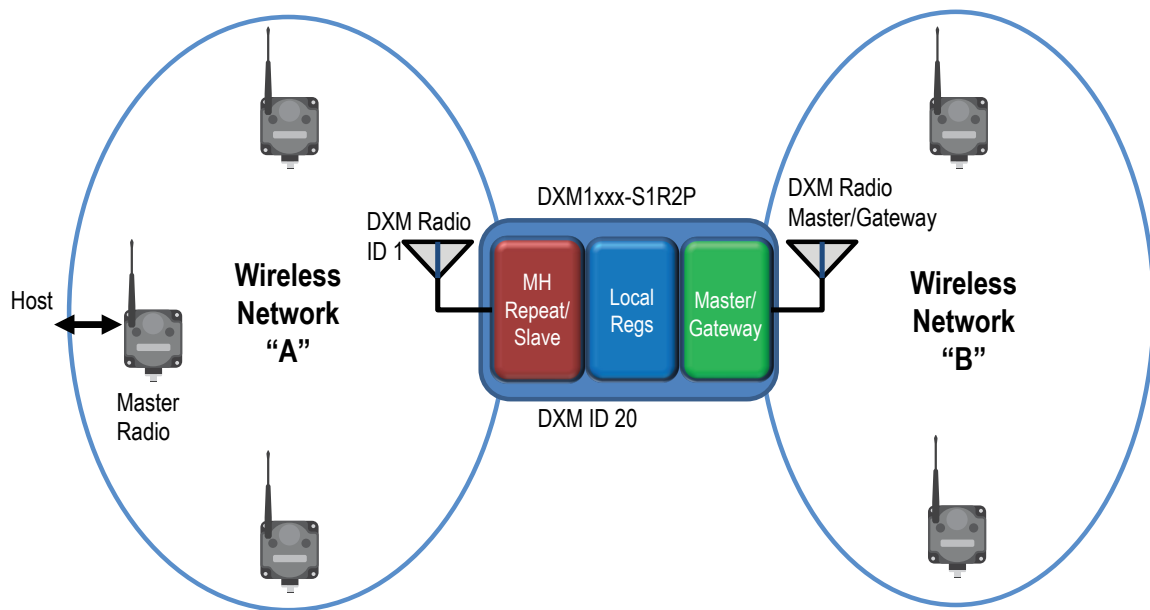

DXM1xx-SxR2P Configuration—The DXM1xx-SxR2P model requires a special configuration setting in the XML configuration. In the Settings > General screen of the DXM Configuration Tool, select Wireless Modbus Backbone to set the DXM Slave slave connection to the MultiHop ISM radio on the processor board. The RS-485 slave connection on the terminals (S+/S-) is disabled.

Since there are potentially two separate radios within the DXM Slave housing, they must be put into the binding process individually. Bind the ISM radio on the processor board to the master device by triple-clicking the button on the ISM radio. Bind the ISM radio on the I/O base board to its master using the LCD menu system of the DXM Slave.

1.3.1 Basic Setup Requirements

There are three basic setup steps required to install/deploy the DXM1xx-SxR2P slave controller:

1. Assign the DXM Slave a Modbus ID using the LCD menu System > DXM Modbus ID. Each DXM Slave should have a unique Modbus ID. The internal radio does not need to have a unique Modbus ID, it is only a pass-through device for the DXM Slave. The I/O base board radio, if installed, is the master or gateway for another network and is Modbus ID 1.
2. Bind the ISM radio in the processor board to the wireless MultiHop network master by triple-clicking the button on the ISM radio. When binding the ISM radio, the Modbus ID comes from the master radio, either the rotary dials or the LCD settings, when you use a DXM Wireless Controller as a master radio. The Modbus ID comes from the master radio's rotary dials when you use a MultiHop radio as the master radio.
3. Any XML configuration file used on the DXM1xx-SxR2P model must have Wireless Modbus Backbone selected (on the Settings > General screen). This identifies the MultiHop ISM radio on the processor board as the connection to the DXM Modbus Slave port.

2 DXM Hardware Configuration Overview

The DXM Slave can have multiple configurations. The DXM Slave will have a model number label on the housing. Use the model number and model table above to identify which boards are included in the controller.

When opening the DXM Slave, follow proper ESD grounding procedures. Refer to the ESD warning in the appendix.

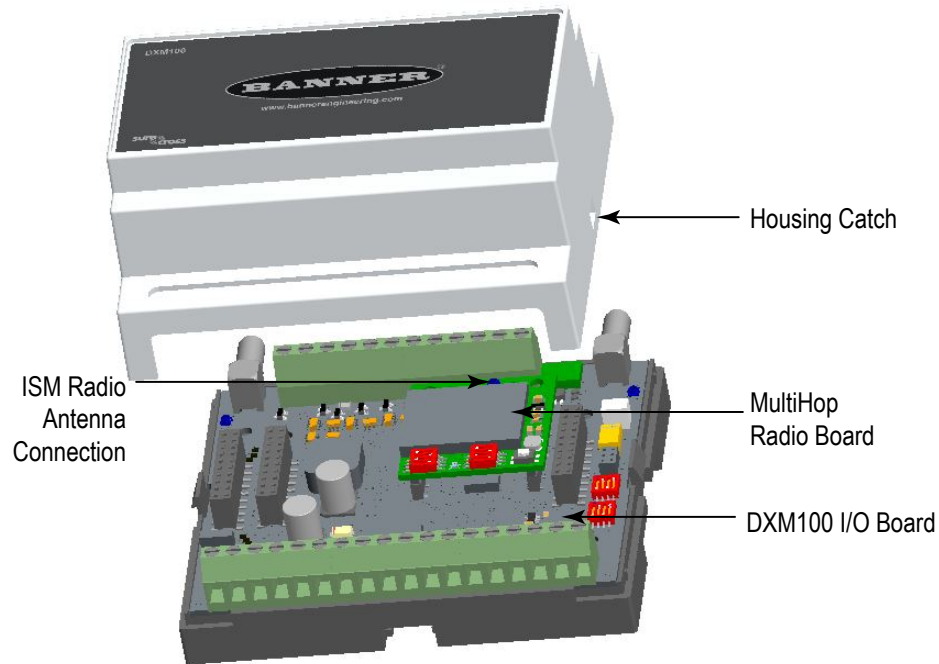

The DXM Slave I/O base board provides connections for all inputs, outputs and power. The base board also contains a 12 V solar controller that accepts connections to a solar panel and SLA battery. The battery connection can also be used with line power to provide a battery backup in case of line power outages.

The ISM radio fits on the base board in the parallel sockets. Install the ISM radio so the U.FL antenna connection is to the side with the SMA antenna connectors. Connect the U.FL cable from the ISM radio U.FL to the right side U.FL connector. The ISM radio boards are available with either a 900 MHz radio or a 2.4 GHz radio.

3 ISM Radio

3.1 ISM Radio Board (Modbus Slave ID 1)

For the DXM100-S1R2x models, the ISM radio board installed in the I/O board is a MultiHop radio (DX80DR*M-HE5).

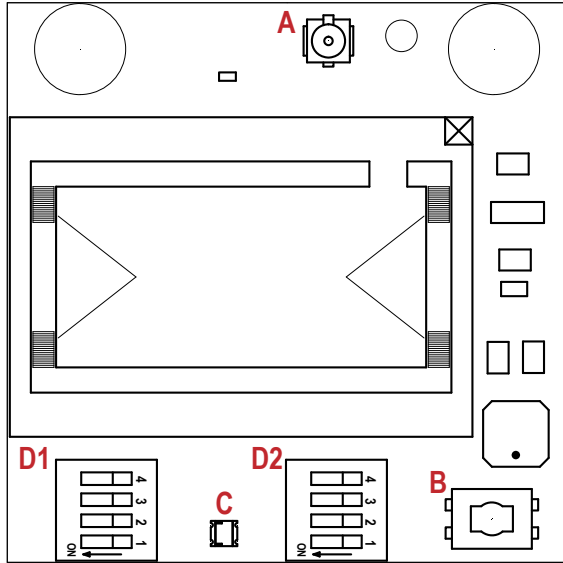

Plug the ISM radio into the I/O base board with the U.FL antenna connector closest to the SMA connectors.

- A - Antenna connector
- B - Button
- C - LED
- D1 - DIP switches
- D2 - DIP Switches

Button Operation—For DXM models without a LCD display, use the button (B) to bind the ISM radio. For models with a LCD display, use the ISM menu to bind the radio.

LED Operation—The LED located on the ISM radio module indicates power and communications traffic.

- Solid green DX80 ISM radio LED: Indicates power.
- Flashing green MultiHop ISM radio LED indicates operation.
- Red and green combined: Communications traffic and binding.

3.1.1 DIP Switch Settings for the MultiHop HE5 Board Module

Device Settings	D1 Switches				D2 Switches			
	1	2	3	4	1	2	3	4
Serial line baud rate 19200 OR User defined receiver slots	OFF*	OFF*						
Serial line baud rate 38400 OR 32 receiver slots	OFF	ON						
Serial line baud rate 9600 OR 128 receiver slots	ON	OFF						
Serial line baud rate Custom OR 4 receiver slots	ON	ON						
Parity: None			OFF*	OFF*				
Parity: Even			OFF	ON				
Parity: Odd			ON	OFF				
Disable serial (low power mode) and enable the receiver slots select for switches 1-2			ON	ON				
Transmit power 900 MHz radios: 1.00 Watt (30 dBm) 2.4 GHz radios: 0.065 Watts (18 dBm) and 60 ms frame					OFF*			
Transmit power 900 MHz radios: 0.25 Watts (24 dBm) 2.4 GHz radios: 0.065 Watts (18 dBm) and 40 ms frame					ON			

Device Settings	D1 Switches				D2 Switches			
	1	2	3	4	1	2	3	4
Application mode: Modbus						OFF*		
Application mode: Transparent						ON		
MultiHop radio setting: Repeater							OFF*	OFF*
MultiHop radio setting: Master							OFF	ON
MultiHop radio setting: Slave							ON	OFF
MultiHop radio setting: Reserved							ON	ON

* Default configuration

Application Mode

The MultiHop radio operates in either Modbus mode or transparent mode. Use the internal DIP switches to select the mode of operation. All MultiHop radios within a wireless network must be in the same mode.

Modbus mode uses the Modbus protocol for routing packets. In Modbus mode, a routing table is stored in each parent device to optimize the radio traffic. This allows for point to point communication in a multiple data radio network and acknowledgement/retry of radio packets. To access a radio's I/O, the radios must be running in Modbus mode.

In transparent application mode, all incoming packets are stored, then broadcast to all connected data radios. The data communication is packet based and not specific to any protocol. The application layer is responsible for data integrity. For one to one data radios it is possible to enable broadcast acknowledgement of the data packets to provide better throughput. In transparent mode, there is no access to the radio's I/O.

Baud Rate and Parity

The baud rate (bits per second) is the data transmission rate between the device and whatever it is physically wired to. Set the parity to match the parity of the device you are wired to.

Disable Serial

If the local serial connection is not needed, disable it to reduce the power consumption of a data radio powered from the solar assembly or from batteries. All radio communications remain operational.

Transmit Power Levels/Frame Size

The 900 MHz data radios can be operated at 1 watt (30 dBm) or 0.250 watt (24 dBm). For most models, the default transmit power is 1 watt.

For 2.4 GHz radios, the transmit power is fixed at 0.065 watt (18 dBm) and DIP switch 5 is used to set the frame timing. The default position (OFF) sets the frame timing to 60 milliseconds. To increase throughput, set the frame timing to 40 milliseconds. Note that increasing the throughput decreases the battery life.

Prior to date code 15341 and radio firmware version 3.6, the frame timing was 40 ms (OFF) or 20 ms (ON).

3.2 Binding the ISM Radio of a DXM100-Sx Modbus Slave

A DXM100-Sx Modbus Slave (model DXM1x0-S*R2) contains two boards: a MultiHop ISM radio and an I/O base board. Each board is a separate Modbus device.

- The ISM radio is not required to have a Modbus ID because there are no registers to manage.
- The I/O board must have a Modbus ID to access the I/O register data and configuration data.

To bind the DXM100-Sx Modbus Slave (as either a repeater or slave radio) to its master radio, follow the binding instructions. If the binding instructions are not included in the master radio datasheet, refer to the MultiHop Quick Start Guide (p/n [152653](#)) or Instruction Manual (p/n [151317](#)).

The ISM radio board's Modbus ID is assigned from the master radio during binding using the master radio's rotary dials or the DXM Controller's LCD Binding menu. For example, if the master's binding number is 25, the DXM Slave ISM radio's Modbus ID is set to 25. To reduce the number of Modbus IDs used, set the ISM radio Modbus ID to 01.

By default, the I/O board's Modbus ID is set to 11. To change the Modbus ID, use the I/O board DIP switches. For applications requiring Modbus IDs outside the range of the DIP switches, write a Modbus ID to a Modbus register on the I/O board.

DXM100-Sx Wireless Modbus Slave

Use the MultiHop Configuration Tool to display and configure a MultiHop radio network. With the DXM100-Sx Modbus Slave, only the ISM radio displays on the Network View screen. The Modbus ID of the I/O board is a separate device that is not a part of the radio network. Although the I/O board does not show up in the Network View, it is accessible when using the Register View functions.

4 I/O Base Board for the DXM100-S1 Model

4.1 DXM100-S1 I/O Base Board Connections

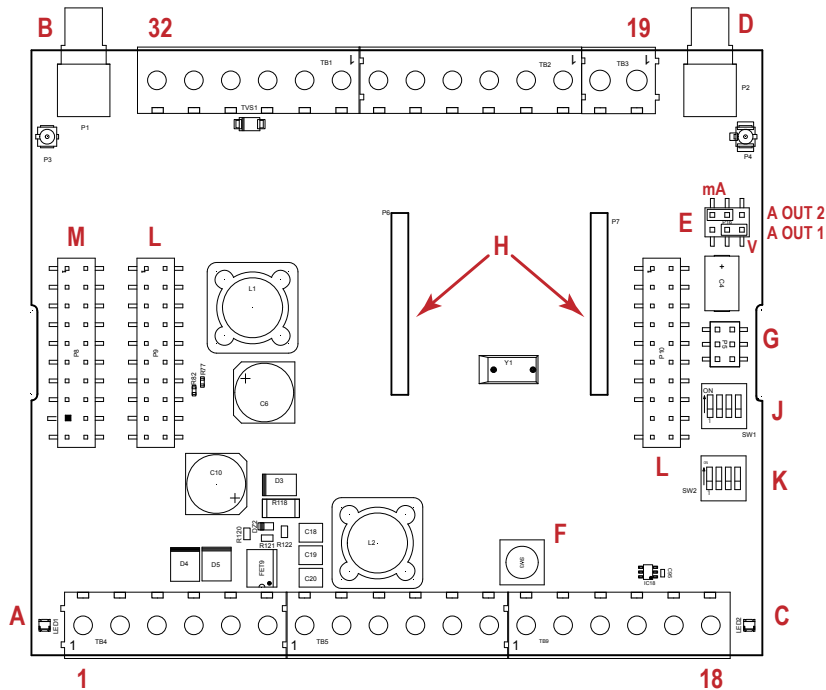

1	No connection	12	Not used	23	N3. NMOS OUT 3
2	PW. 12 to 30 V dc or solar power in (+)	13	S-. Secondary RS-485 -	24	N2. NMOS OUT 2
3	GD. Ground	14	S+. Secondary RS-485 +	25	N1. NMOS OUT 1
4	B+. Battery in (< 15 V dc)	15	CL. CANL	26	GD. Ground
5	GD. Ground	16	CH. CANH	27	U4. Universal Input 4
6	M-. Primary RS-485 -	17	GD. GND	28	U3. Universal Input 3
7	M+. Primary RS-485 +	18	P3. Courtesy Power 5 V	29	GD. Ground
8	GD. Ground	19	A2. Analog OUT 2	30	P1. Switch Power (5 V or 16 V)
9	Not used	20	A1. Analog OUT 1	31	U2. Universal Input 2
10	Not used	21	P2. Switch Power 2 (5 V or 16 V)	32	U1. Universal Input 1
11	Not used	22	N4. NMOS OUT 4		

A	Base board LED	E	Jumpers - Configures Analog Out 1 and 2 for mA or V	J	Modbus Slave ID DIP Switches
B	A1. Cellular antenna	F	Radio Binding Button	K	Modbus Slave ID DIP Switches
C	Radio LED	G	Programming header	L	SAM4 Processor Board Connection
D	A2. ISM Antenna	H	ISM Radio Board Connection	M	Display Connection

4.1.1 DIP Switches for the I/O Board

The DXM100-Sx Modbus Slave I/O board DIP switches are set from the factory to Modbus Slave ID 11. For more information, refer to *Setting the Modbus Slave ID on the I/O Base Board*.

4.1.2 I/O Board Jumpers

Hardware jumpers on the DXM I/O board allow the user to select alternative pin operations. Turn the power off to the device before changing jumper positions.

Jumper	Function	Positions
E	Analog output characteristics for AO2 (pin 19) and AO1 (pin 20)	<p>Defines current (0–20 mA) or voltage (0–10 V) for analog output 1 and 2.</p> <p>By default, current (0–20 mA) is selected using jumpers 1 and 2 and registers 4008 and 4028 contain a value of 2.</p> <p>To select voltage (0–10 V) for output Aout1, set jumper 1 in the voltage position (V) and set Modbus register 4008 on the I/O board (SID 200) to 3.</p> <p>To select voltage (0–10 V) for output Aout2, set jumper 2 in the voltage position (V) and set Modbus register 4028 on the I/O board (SID 200) to 3.</p>

4.1.3 Setting the Modbus Slave ID on the I/O Base Board

Only DXM100-S1 and -S1R2 Slave models require that the Modbus Slave ID to be adjusted on the I/O base board. The DXM100-Sx Modbus Slave models use DIP switches J and K to set the Modbus Slave ID. This device can use a Modbus register 6804 in the I/O board to access the full range of Modbus Slave IDs.

On the DXM100-Sx Modbus Slave models, use the DIP switches at location K to define the lower digit of the Modbus Slave ID.

DIP Switch location J defines the course group of Modbus Slave IDs. DIP Switch 4 must be set to ON for DXM100-S1, DXM100-S2, DXM100-S1R2, and DXM100-S2R2 models.

Settings	Location J DIP Switches			
	1	2	3	4
Modbus Slave ID set to 11 through 19	OFF	OFF		
Modbus Slave ID set to 20 through 29	ON	OFF		
Modbus Slave ID set to 30 through 39	OFF	ON		
Modbus Slave ID set to 40 through 49	ON	ON		
Not Used			-	
Modbus Slave Configuration (DX100-S1 and -S1R2 models only) ¹				ON
Standard Communication Mode				OFF

DIP Switches J		DIP Switch K, Switches 1, 2, 3, 4 (0 is OFF, 1 is ON)									
1	2	0,0,0,0	1,0,0,0	0,1,0,0	1,1,0,0	0,0,1,0	1,0,1,0	0,1,1,0	1,1,1,0	0,0,0,1	1,0,0,1
OFF	OFF	x ²	11	12	13	14	15	16	17	18	19
ON	OFF	20	21	22	23	24	25	26	27	28	29
OFF	ON	30	31	32	33	34	35	36	37	38	39
ON	ON	40	41	42	43	44	45	46	47	48	49

DXM100-Sx Modbus Slave Example—To set the DXM100-Sx Modbus Slave to a Modbus Slave ID of 34, set the following:

- Location J DIP switches set to 1=OFF, 2=ON
- Location K DIP switches set to 1=OFF, 2=OFF, 3=ON, 4=OFF

The location J DIP switches set the upper Modbus Slave ID digit to 3 while the location K DIP switches set the lower digit to 4.

Setting the DXM I/O Board Modbus Slave ID using Modbus Registers—Write to the I/O board's Modbus register 6804 to set the Modbus Slave ID to any valid Modbus Slave ID (1 through 245).

- For the DXM100-Sx Modbus Slave model, all switches on DIP switch K should be in the OFF position to use the Modbus register slave ID.

¹ Must be in the ON position for the -S1 and -S1R2 model)
² Uses value in Modbus register 6804.

4.2 Applying Power to the DXM100-Sx Modbus Slave

Apply power to the DXM100-Sx Modbus Slave using either 12 to 30 V dc or a 12 V dc solar panel and 12 V sealed lead acid battery.

Pin	Description
Pin 1	No connection
Pin 2	12 to 30 V dc input (+) or solar panel connection (+)
Pins 3, 5, 8, 17, 26, 29	Main logic ground for the DXM100-Sx Modbus Slave
Pin 4	Solar or backup battery positive input. Battery voltage must be less than 15 V dc. Use only a sealed lead acid (SLA) battery.

4.2.1 Using Courtesy Power or Switch Power

Pin 18 of the DXM100-Sx Modbus Slave is a constant power source that supplies 5 volts up to 500 mA.

Pins 21 (switch power 2) and 30 (switch power 1) are switched power outputs. Configure the switched power outputs using Modbus registers. The output voltage can be selected and is controlled using a Modbus register on the I/O board (Modbus slave ID 200). The voltage options are:

- 5 volts or 16 volts for DXM100-B1 models; or
- 5 to 24 V dc for DXM100-B2 models.

Turn the switched power on or off using the output register 505 for switch power 1 or 506 for switch power 2. For continuous power, set the Default Output register to 1, then cycle the power.

Switch Power	Enable Register	Voltage Register	Default Output Register	Output Register
1 (pin 30)	2201 Write a 0 to turn OFF Write a 1 to turn ON (default)	3601 Write a 0 to select 5 V (default) Write a 1 to select 16 V	3602	505
2 (pin 21)	2251 Write a 0 to turn OFF Write a 1 to turn ON (default)	3621 Write a 0 to select 5 V (default) Write a 1 to select 16 V	3622	506

Enable Register

Configuration registers that turn on the ability to use the switched power output.

Default setting = ON

Voltage Register

Configuration registers that define the output voltage to the switched power output.

Default setting = 5 V

Default Output Register

Configuration registers that turn on the switched power outputs for continuous power out.

Set register to 1 for continuous power. Cycle power if this register is changed.

Default setting = 0

Modbus Output Register

Turn on or turn off the voltage output. If both outputs 505 and 506 are turned on at the same time but are set to different voltages, the output voltage is 5 V for DXM100-B1 models and set to the lower voltage setting for DXM100-B2 models.

4.2.2 Associating a Switched Power Output to an Input

Switched power 1 and 2 (pins 30 and 21) can be associated to any Universal input to apply power a sensor, take a reading, and then remove power from the sensor. This conserves power in battery-operated systems.

The switched power supply can be used in one of two different ways: supplying courtesy power to an output pin or associated to an input. (Only one method can be active at a time.)

Use the following configuration parameters to define the courtesy power supplied to a switched power output pin.

Courtesy Power Output Configuration Parameters ³	Modbus Registers	
	Switched Power 1	Switched Power 2
Switched Power Enable	2201	2251
Voltage	3601	3621
Default Output	3602	3622
Output Register	505	506

Default Output

Set the register value to 1 for continuous power. The default setting is 0.

Cycle power if this register value is changed.

Switched Power Enable

Enables the switched power supply. Set to 1 to enable; set to 0 to disable.

This does not enable the supply output to the actual output pin. To enable the supply output to the output pin, set Modbus register 505 or 506 to 1. Set to 0 when associating the switched power supply to an input.

Output Register

Write to the Output register to turn on or turn off the voltage output.

If both Output Registers 505 and 506 are turned on at the same time, but are set to different voltages, the output voltage is 5 V for DXM100-B1 models and set to the lower voltage setting for DXM100-B2 models.

Voltage

For the B1 and S1 models, set the Modbus register value to 0 for a switched power supply at 5 volts. Set the Modbus register value to 1 for a switched power supply at 16 volts.

For the B2 and S2 models, set one of the following register values to select your switched power output voltage.

For 5 V, set the Modbus register to 204.

For 7 V, set the Modbus register to 125.

For 10 V, set the Modbus register to 69.

For 15 V, set the Modbus register to 32.

For 20 V, set the Modbus register to 12.

For 24 V, set the Modbus register to 3.

When associating a switched power supply to an input, set the Switch Power Output Enable register to off (0). Set Modbus register 2201 for switched power 1 and Modbus register 2251 for switched power 2. This allows the input sampling mechanism to control the output.

Use the following configuration parameters to define the switch power associated with an input.

Input Parameter	Universal Input Configuration Parameter Modbus Registers			
	Universal Input 1	Universal Input 2	Universal Input 3	Universal Input 4
Input Enable	1001	1051	1101	1151
Sample Interval (high)	1002	1052	1102	1152
Sample Interval (low)	1003	1053	1103	1153
Switched Power Enable Mask	1004	1054	1104	1154
Switched Power Warmup	1005	1055	1105	1155
Switched Power Voltage	1006	1056	1106	1156
Extended Input Read	1007	1057	1107	1157
Input Out-of-Sync Enable	1008	1058	1108	1158

Extended Input Read

The Extended Input Read is a bit field parameter that allows multiple inputs to be sampled with the same switch power parameters.

If the bit field is set to 0x000F, the first four inputs are sampled after the switch power parameters are satisfied.

If the Extended Input Read parameter is set in the Universal input 1 configuration registers, set Universal inputs 2 through 4 Extended Input Read and Sample Interval parameters to zero.

³ Only used when supply courtesy power to the output pin, not when associating switched power to an input.

Input Enable

Set to 1 to enable the input. Set to 0 to disable the input.

Out-of-Sync Enable

To enable the input to continue operating when the device is out of sync with the master radio, set to 1.

To disable the input when the device is not synchronized to the master radio, set to 0.

Sample Interval (high), Sample Interval (low)

The sample interval (rate) is a 32-bit value (requires two Modbus registers) that represents how often the I/O board samples the input.

The register value is the number of time units. One time unit is equal to 0.01 seconds.

For example, a Modbus register value of 1000 represents a sample interval of 10 seconds (1000×0.010 seconds = 10 seconds).

Switch Power Enable Mask

The Switch Power Enable Mask works with the warm-up and voltage parameters to define the switch power output. The bit mask can select any number of switch powers.

0x0 - No switch power enabled

0x1 - Enable Switch Power 1

0x2 - Enable Switch Power 2

0x3 - Enable Switch Power 1 and Switch Power 2

Switch Power Voltage

The Switch Power Voltage parameter defines the output voltage of the switch power output.

This parameter applies only to inputs using switched power. If switch power is not used with an input, use the Courtesy Power Voltage parameter to control the voltage.

See *Voltage* entry for Modbus register values used to select the output voltage.

Switch Power Warm-up

When an input controls power to external sensors, the Switch Power Warm-up parameter defines how long power is applied to the external sensor before the input point is examined for changes.

The register value is the number of time units, and a time unit is 0.01 seconds. For a warm-up time of 1 second, this parameter value is 100 (0.01 seconds \times 100 = 1 second).

Associate Universal Input 1 with Switch Power 1

To associate universal input 1 with switched power 1, follow these instructions. Set Input 1 to sample every 60 seconds, with a warmup time of 10 seconds.

1. Verify Switched Power 1 Output Enable is off (0). Set Modbus Register 2201 = 0
2. Set the Sample Interval to 1 minute. Modbus Registers 1002 = 0, 1003 = 6000 (0.01 seconds \times 6000 = 60 seconds).
3. Set the Switched Power Enable Mask to use Switch Power 1. Modbus Register 1004 = 1
4. Set the Switched Power Warm-up time to 10 seconds. Modbus Register 1005 = 1000 (0.01 seconds \times 1000 = 10 seconds).
5. Set the Switched Power Voltage to 16 volts. Modbus Register 1006 = 1.

4.2.3 Connecting a Battery to the DXM Slave

When attaching a battery to the DXM Slave as a backup battery or as a solar battery, verify the charging algorithm is set properly. The factory default setting for the battery charging algorithm assumes you are using 12 to 30 V dc to recharge the battery.

The charging algorithm is designed to work with a sealed lead acid (SLA) battery only.

- When using 12 to 30 V dc, connect the 12 to 30 V dc + to pin 2 and connect the ground to pin 3.
- When using main dc power with a back up battery (default configuration), connect the incoming main power pin 2 (+) and to pin 3 (-). Connect the 12 V sealed lead acid battery to pin 4 (+) and pin 5 (-). The incoming main power must be 15 to 30 V dc to charge the battery.
- When using a solar panel, connect the solar panel output to pin 2 and connect the ground to pin 3. Connect the 12 V dc SLA battery to pin 4 (+) and pin 5 (-). To change the charging algorithm, refer to [Supplying Power from a Solar Panel](#) on page 14.

Modbus Slave ID	Modbus Register	Description
11 *	6071	Battery backup charging algorithm. 0 = Battery is recharged from a solar panel 1 = Battery is recharged from 12 to 30 V dc (default)

* The Modbus Slave ID for the base board is set at the factory and may be changed using the base board DIP switch settings.

4.2.4 Supplying Power from a Solar Panel

To power the DXM100-Sx Modbus Slave from a 12 V dc solar panel, connect the solar panel to power pins 2(+) and 3(-). Connect a 12 V dc sealed lead acid (SLA) rechargeable battery to pins 4(+) and 5(-).

The factory default setting for the battery charging algorithm assumes you are using 12 to 30 V dc power to recharge the battery. If the incoming power is from a solar panel, you must change the charging algorithm.

To change the charging algorithm from the menu system:

1. From the LCD menu, select Update > Power.
2. Use the up/down arrows to select "SOLAR" power.

To change the charging algorithm by writing to Modbus register 6071 on the I/O base board (Slave ID 11):

1. Write a 0 to select the solar power charging algorithm.

Modbus Slave ID	Modbus Register	Description
11 *	6071	Battery backup charging algorithm. 0 = Battery is recharged from a solar panel 1 = Battery is recharged from 12 to 30 V dc (default)

The following power operating characteristics are stored in Modbus registers.

Battery voltage

If no battery is present, the value in this register is less than 5 V. If the value in this register is greater than the incoming voltage register, the battery is powering the system.

Battery charging current

The charging algorithm charges the battery when the incoming voltage register value is greater than the battery voltage register value. This registers shows the charging current in milliamps.

Incoming supply voltage

The incoming power can be from a solar panel or from a power supply. The battery is charging when the incoming voltage register value is greater than the battery voltage register value. The battery is powering the system when the incoming voltage register value is less than the battery voltage register value.

On-board thermistor temperature

This register stores the on-board thermistor reading in tenths of degrees C, this is not a calibrated input: divide by 10 to calculate the temperature in degrees C. For calibrated temperature inputs, define one of the universal inputs as a temperature input.

Modbus Slave ID	Modbus Register	Description
11 *	6081	Battery voltage (mV)
	6082	Battery charging current (mA)
	6083	Incoming supply voltage (mV) (solar or power supply)
	6084	On-board thermistor temperature (°C)

* The Slave ID for the base board is set at the factory. This may be changed using the base board DIP switch settings.

4.3 Working with Solar Power

A reliable solar system requires careful planning and monitoring to size the components correctly. The recommendations provided are for the DXM Slave system as an autonomous system.

Adding extra components increases the power requirements and likely requires increasing the solar system components. Depending upon the geographical location, the size of the solar panel and battery may vary.

4.3.1 Setting the DXM Slave for Solar Power

By default, the DXM Slave is set from the factory to charge a backup battery from a line power source.

4.3.2 Solar Components

The components of a solar system include the battery and the solar panel.

Battery

The DXM solar controller is designed to use a 12 V lead acid battery. The characteristics of a solar system require the battery to be of a certain type. There are basically two types of lead acid batteries:

- SLI batteries (Starting Lights Ignition) designed for quick bursts of energy, like starting engines
- Deep Cycle batteries - greater long-term energy delivery. This is the best choice for a solar battery.

Since a solar system charges and discharges daily, a deep cycle battery is the best choice. There are different versions of a lead acid battery: wet cell (flooded), gel cell, and an AGM (absorbed glass mat).

Wet cell batteries are the original type of rechargeable battery and come in two styles, serviceable and maintenance free. Wet cell batteries typically require special attention to ventilation as well as periodic maintenance but are the lowest cost. The gel cell and AGM battery are sealed batteries that cost more but store very well and do not tend to sulfate or degrade as easily as a wet cell. Gel or AGM batteries are the safest lead acid batteries you can use.

Battery Capacity

Battery capacity is a function of the ambient temperature and the rate of discharge. Depending upon the specific battery, a battery operating at -30 °C can have as much as 40 percent less capacity than a battery operating at 20 °C. Choose enough battery capacity based on your geographical location.

A larger capacity battery typically lasts longer for a given solar application because lead-acid batteries do not like deep cycling (discharging a large percentage of its capacity). Depending upon the battery, a battery discharging only 30 percent of its capacity before recharging will have approximately 1100 charge/discharge cycles. The same battery discharging 50 percent of its capacity will have approximately 500 charge/discharge cycles. Discharging 100 percent leaves the battery with only 200 charge/discharge cycles.

Batteries degrade over time based on discharge/charge cycles and environmental conditions. Always monitor the battery system to obtain the best performance of the solar powered system.

Use this as a guide to the approximate state of charge and in determining when to apply conservation measures.

Average Voltage Readings Relative to Battery Change	
State of Charge (%)	Open Circuit Voltage
100	13.0 or higher
75	12.6
50	12.1
25	11.66
0	11.4 or less

Solar Panel

Banner solar panels come in two common sizes for the DXM Slave: 5 Watt and 20 Watt. Both panels are designed to work with the DXM Slave but provide different charging characteristics. Use the 5 watt panel for light duty operation and use the 20 watt panel when you require greater charging capabilities.

Solar Panel	Voltage	Current	Typical DXM Configurations
5 Watt	17 V	0.29 A	DXM slave controller, ISM radio, I/O base board
20 Watt	21 V	1 A	DXM Controller with ISM radio and Cellular modem

Photovoltaic panels are very sensitive to shading. Unlike solar thermal panels, PV solar panels cannot tolerate shading from a branch of a leafless tree or small amounts of snow in the corners of the panel. Because all cells are connected in a series string, the weakest cell will bring down the other cells' power level.

Good quality solar panels will not degrade much from year to year, typically less than 1 percent .

Solar Panel Mounting

To capture the maximum amount of solar radiation throughout the year, mount a fixed solar panel to optimize the sun's energy throughout the year. For the northern hemisphere, face the panel true south. For the southern hemisphere, face the panel true north. If you are using a compass to orientate the panels, compensate for the difference between true north and magnetic north. Magnetic declination varies across the globe.

A solar panel's average tilt from horizontal is at an angle equal to the latitude of the site location. For optimum performance, adjust the tilt by plus 15 degrees in the winter or minus 15 degrees in the summer. For a fixed panel with a consistent power requirement throughout the year, adjust the tilt angle to optimize for the winter months: latitude plus 15 degrees. Although in the summer months the angle may not be the most efficient, there are more hours of solar energy available.

For sites with snow in the winter months, the increased angle helps to shed snow. A solar panel covered in snow produces little or no power.

4.3.3 Recommended Solar Configurations

These solar panel and battery combinations assume direct sunlight for two to three hours a day. Solar insolation maps provide approximate sun energy for various locations. The depth of battery discharge is assumed to be 50 percent.

Solar panel and battery combinations for a DXM Slave system				
Solar Panel	Battery Capacity ⁴	Days of Autonomy	DXM mA	DXM Controller
5 watt	10 Ahr	10 days	25 mA	DXM Slave Controller - ISM radio and I/O base board
20 watt	14 Ahr	10 days	30 mA	DXM Controller with ISM radio
20 watt	20 Ahr	10 days	35 mA	DXM Controller with ISM radio and Cellular Modem

4.3.4 Monitoring Solar Operation

The DXM solar controller provides Modbus registers that allow the user to monitor the state of the solar panel input voltage, the battery voltage, the charging current, and the temperature in °C. The DXM Slave can be configured to monitor the health of the charging system as well as send an alert message when the battery is too low.

The charts show a typical charging cycle, with each vertical grid representing about eight hours. The chart shows three days of charging.

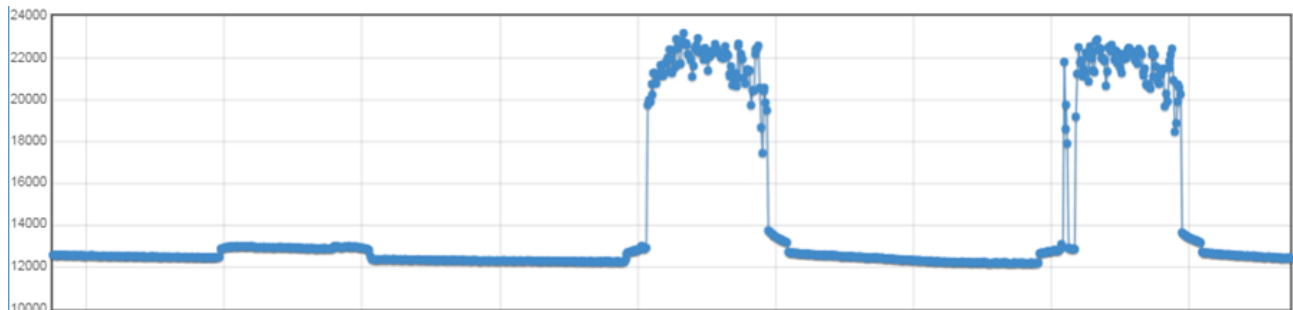

Figure 1. Solar Panel Voltage (mV) -- Cloudy First Day

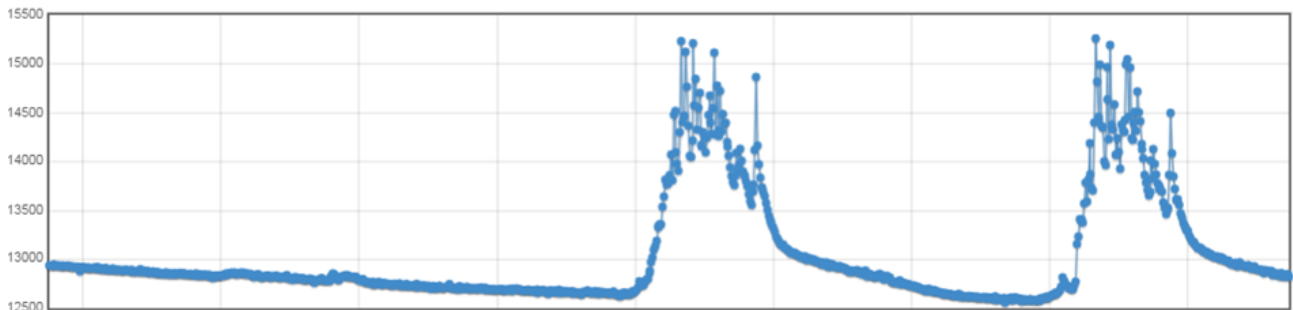

Figure 2. Battery Voltage (mV) - Cloudy First Day

4.4 Connecting the Communication Pins

The base board communications connection for external Modbus device uses the primary RS-485.

RS-485. The primary RS-485 bus is a common bus shared with the ISM radio board (Modbus Slave ID 1).

RS-232. The RS-232 bus is not currently defined.

⁴ Battery capacity (amp hour) is standard amp rating taken for 20 hours. Battery capacity should be monitored for reliable system power and may need to be increased for cold weather locations.

Pin	Parameter	Description
Pin 6	Primary RS-485 –	Running Modbus protocol at 19.2k baud, use this bus to connect to other Modbus Slave devices. The DXM100-Sx Modbus Slave is a Modbus Master device on this RS-485 port. Modbus Register 6101 = Baud Rate 0 = 19.2k 1 = 9600 2 = 38400 Modbus Register 6103 = Parity 0 = no parity 1 = odd? 2 = even?
Pin 7	Primary RS-485 +	
Pin 9	RS-232 Tx	Serial RS-232 connection. This bus must use a ground connection between devices to operate correctly.
Pin 10	RS-232 Rx	
Pin 13	Secondary RS-485 –	Not used
Pin 14	Secondary RS-485 +	
Pin 15	CANL –	
Pin 16	CANH +	

4.5 Inputs and Outputs

The I/O base board is a Modbus slave device that communicates using Modbus commands. Refer to the Modbus Registers section for more descriptions of each Modbus register on the DXM100-Sx Modbus Slave.

4.5.1 Universal Inputs

The universal inputs on the DXM100-Sx Modbus Slave can be programmed to accept several different types of inputs:

- Discrete NPN/PNP
- 0 to 20 mA analog
- 0 to 10 V analog
- 10k temperature thermistor
- Potentiometer sense
- Bridge
- NPN raw fast

Any input can be used as a synchronous counter by configuring the input as a discrete NPN/PNP input.

Use the DXM Configuration Tool tool to write to the appropriate Modbus registers in the I/O board to configure the input type. The universal inputs are treated as analog inputs. When the universal inputs are defined as mA, V, or temperature, use Modbus registers to configure the operational characteristics of the inputs. These parameters are temperature conversion type, enable full scale, threshold and hysteresis. Refer to the DXM100 Controller Instruction Manual (p/n [190037](#)) for the parameter definitions.

When a universal input is configured as an NPN or PNP input type, it can be enabled to be a synchronous counter. Enable the counter function by setting Modbus register 'Enable Rising' or 'Enable Falling' to 1. See [Modbus I/O Registers for the DXM100-S1x I/O Base Board](#) on page 19 for universal input register definitions.

Pin	Universal Input	Modbus Register	Description
27	4	4	Program the universal inputs to accept input types NPN, PNP, 10k thermistor, 0 to 10 V, 0 to 20 mA, or potentiometer. The default setting is 8: NPN raw fast. To set the input type, write the following values to the Input Type Modbus registers defined in Modbus I/O Registers for the DXM100-S1x I/O Base Board on page 19. 0 = NPN 1 = PNP 2 = 0 to 20 mA 3 = 0 to 10 V dc 4 = 10k Thermistor 5 = Not used 6 = Not used 7 = Bridge 8 = NPN Raw Fast (default)
28	3	3	
31	2	2	
32	1	1	

Thermistor Input

A thermistor input must use a 10k temperature thermistor between ground and the universal input. The thermistor must be a 10k NTC (Banner model number BWA-THERMISTOR-002) or equivalent. Select the temperature conversion of degrees C (default) or degrees F by writing Modbus registers defined in [Modbus I/O Registers for the DXM100-S1x I/O Base Board](#) on page 19.

Potentiometer Input

A potentiometer input is created from three inputs: a voltage source (pin 30) that supplies 5 V to the potentiometer and two inputs set to voltage inputs to read the voltage across the potentiometer. See the DXM tech note for setting up a potentiometer.

Bridge Input

The bridge input is not implemented yet.

NPN vs NPN Raw Fast

The difference between NPN and NPN Raw Fast is the amount of settling time given to the input. Switch the input type to NPN if the input is not detecting a transition.

Synchronous Counters

When an input is configured as a counter (inputs set to NPN/PNP), the input counts the input signal transitions. The count value is stored into two 16-bit Modbus registers for a total count of 32-bits (unsigned). To program an input to capture the edge transition counts, follow [Example: Configure Input 1 as a Synchronous Counter](#) on page 18.

Synchronous counter sample the inputs every 10 ms. The input logic does not detect rising or falling edges, but instead samples the input every 10 ms to find level changes. The input signals must be high or low for more than 10 ms or the input will not detect transitions. Because most signals are not perfect, a realistic limit for the synchronous counter would be 30 to 40 Hz.

Example: Configure Input 1 as a Synchronous Counter

1. Change the Source Register selection to I/O Board Registers.
2. In the Write Registers area, write Modbus register 4908 to 1 to enable counting on the rising edge of the input signal.
3. Read Modbus registers 4910 and 4911 to get the 32-bit value of the count.

Example: Change Universal Input 2 to a 0 to 10 V dc Input

1. Write a 3 to Modbus register 3326 on Modbus Slave ID 11 (I/O board).
2. Cycle power to the device.
3. Using the Register View tab, read register 3326 to verify it is set to 3.

Example: Change Analog Output 1 to a 0 to 10 V dc Output

1. Change the Source Register selection to I/O Board Registers.
2. Set jumper 1 on the I/O base board to the 0 to 10 V position. Refer to the base board image for the analog output jumper position.
3. Write a 3 to Modbus register 4008 on Modbus Slave ID 11 (I/O board).
4. Cycle power to the device.
5. Using the Register View tab, read register 4008 to verify it is set to 3.

4.5.2 NMOS Outputs

Pin	NMOS Discrete Outputs	Modbus Register	Description	Wiring
22	4	504	Less than 1 A maximum current at 30 V dc ON-State Saturation: Less than 0.7 V at 20 mA ON Condition: Less than 0.7 V OFF Condition: Open	
23	3	503		
24	2	502		
35	1	501		

4.5.3 Analog (DAC) Outputs

The DXM100-B1 and S1 analog outputs may be configured as either 0 to 20 mA outputs (default) or 0 to 10 V outputs.

To change the analog (DAC) output type:

1. Remove power to the device.
2. Remove the DXM cover.
3. Change the hardware jumper position (see the table for the pin number and [DXM100-B1 I/O Base Board Connections](#) for the pin locations).
4. Replace the DXM cover.

5. Restore power to the DXM.
6. Set the Output Type Select Modbus register (on the I/O board, Slave ID 200) to a value of 2 (default) to select 0 to 20 mA or a value of 3 to select 0 to 10 V. For analog output 1 write to Modbus register 4008, for analog output 2 write to Modbus register 4028 (see the table for the values).

DXM100-B1 and S1 Models			
Pin	Analog Output	Modbus Register	Description
20	1	507	0 to 20 mA or 0 to 10 V dc output (I/O board jumper selectable) Accuracy: 0.1% of full scale +0.01% per °C Resolution: 12-bit
19	2	508	

Parameters for Analog Output 1 start at 4001 through 4008. Parameters for Analog Output 2 start at 4021 through 4028.

Parameter Registers for Analog Outputs (4xxxx)		
OUT 1	OUT 2	Parameters
4001	4021	Maximum Analog Value
4002	4022	Minimum Analog Value
4003	4023	Enable Register Full Scale
4004	4024	Hold Last State Enable
4005	4025	Default Output State
4008	4028	Analog Output Type

Analog Output Type. The analog outputs may be configured as either 0 to 20 mA outputs (default) or 0 to 10 V outputs. To change the analog output type change the hardware jumper position and write to the Modbus register that defines the analog output type. For analog output 1, write to Modbus register 4008, for analog output 2 write to Modbus register 4028. Write a value of 2 (default) to select 0 to 20 mA; write a value of 3 to select 0 to 10 V.

Default Output Conditions. Default output conditions/triggers are the conditions that drive outputs to defined states. Example default output conditions include when radios are out of sync, when a device cycles power, or during a host communication timeout.

- 2952 Enable Default Communication Timeout. A "communication timeout" refers to the communication between any Modbus master host and the DXM baseboard. Set this register to 1 to enable the default condition when the host has not communicated with the DXM baseboard for the period of time defined by the Communication Default IO Timeout.
- 2953 Communication Default I/O Timeout (100 ms/Count). This parameter defines the host timeout period in 100 millisecond increments. If a host does not communicate within this timeout period, the device outputs are set to the default values.
- 2954 Enable Default on Power Up. Setting this parameter to 1 sends the device outputs to their default condition when the DXM baseboard is powered up. Set to 0 to disable this feature.

Default Output State. The Default Output State parameter represents the default condition of the analog output. When an error condition exists, the outputs are set to this 16-bit user-defined output state. To define the error conditions for device outputs, refer to the MultiHop default output parameters 2950-2954.

Enable Register Full Scale. Set to 1 to enable a linear range from 0 to 65535 for specified input range. For a 4 to 20 mA output, a value of 0 represents 4 mA and 65535 represents 20 mA. Set this parameter to 0 to store readings in unit-specific data. For example, the register data representing a 15.53 mA reading is 15530. For units of current (0 to 20 mA outputs), values are stored as μ A (micro Amps) and voltage values are stored as mV (millivolts).

Hold Last State Enable. Set the Hold Last State to 1 to set the output to its last known value before the error occurred. Set this parameter to 0 to disable the Hold Last State and use the Default Output State setting during an error condition.

Maximum Analog Value. The Maximum Analog Value register stores the maximum allowed analog value. The specific units of measure apply to the register value. For example, the register may contain 20000, for 20 mA, or for a voltage output the register may contain 8000, for 8 volts.

Minimum Analog Value. The Minimum Analog Value register stores the minimum allowed analog value. The specific units of measure apply to register value. For example, the register may contain 4000, for 4 mA, or for a voltage output the register may contain 2000, for 2 volts.

4.5.4 Modbus I/O Registers for the DXM100-S1x I/O Base Board

The I/O base board stores the input and output values in Modbus holding registers. Since the I/O base board is defined as a separate device, configure the DXM Slave to read or write the values on the I/O base board.

Base Board Input Connection		
Modbus Register	Range	Description
1	0-65535	Universal input 1
2	0-65535	Universal input 2
3	0-65535	Universal input 3
4	0-65535	Universal input 4

Universal Input Register Ranges			
Register Types	Unit	Minimum Value	Maximum Value
Discrete input/output		0	1
Universal input 0 to 10 V	mV	0	10000 *
Universal input 0 to 20 mA	μA	0	20000 *
Universal input temperature (-40 °C to +85 °C)	C or F, signed, in tenths of a degree	-400	850
Universal potentiometer	unsigned	0	65535

* Setting Enable Full Scale to 1 sets the ranges to a linear scale of 0 to 65535.

Base Board Output Connection		
Modbus Register	Range	Description
501	0-1	NMOS Output 1
502	0-1	NMOS Output 2
503	0-1	NMOS Output 3
504	0-1	NMOS Output 4
505	0-1	Switched Power 1 (5 V or 16 V)
506	0-1	Switched Power 2 (5 V or 16 V)
507	0-20000	Analog Output 1 default (0-20.000 mA)
	0-10000	Analog Output 1 (0-10.000 V)
508	0-20000	Analog Output 2 default (0-20.000 mA)
	0-10000	Analog Output 2 (0-10.000 V)

Modbus Configuration Registers for the I/O

Each input or output on the I/O base board has associated Modbus registers that configure its operation.

Universal Input Parameters Registers				
Universal Inputs	1	2	3	4
Enable Full Scale Registers	3303	3323	3343	3363
Temperature °C/°F Registers	3304	3324	3344	3364
Input Type Registers	3306	3326	3346	3366
Threshold Registers	3308	3328	3348	3368
Hysteresis Registers	3309	3329	3349	3369
Enable Rising Registers	4908	4928	4948	4968
Enable Falling Registers	4909	4929	4949	4969
High Register for Counter Registers	4910	4930	4950	4970
Low Register for Counter Registers	4911	4931	4951	4971

Enable Full Scale

Set to 1 to enable a linear range from 0 to 65535 for specified input range. For a 4 to 20 mA input, a value of 0 represents 4 mA and 65535 represents 20 mA. Set this parameter to 0 to store input readings in unit-specific data. For example, the register data representing a 15.53 mA reading is 15530. For units of current (0 to 20 mA inputs), values are stored as μA (micro Amps) and voltage values are stored as mV (millivolts).

Enable Rising/Falling

Use these registers to enable the universal input logic to count on a rising transition or a falling transition. Write a one (1) to enable; write a zero (0) to disable.

High/Low Register for Counter

The low and high registers for the counter hold the 32-bit counter value. To erase the counter, write zeroes to both registers. To preset a counter value, write that value to the appropriate register.

Hysteresis and Threshold

Threshold and hysteresis work together to establish the ON and OFF points of an analog input. The threshold defines a trigger point or reporting threshold (ON point) for a sensor input. Setting a threshold establishes an ON point. Hysteresis defines how far below the threshold the analog input is required to be before the input is considered OFF. A typical hysteresis value is 10% to 20% of the unit's range.

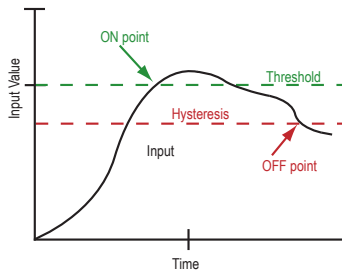

In the example shown graphically, the input is considered on at 15 mA. To consider the input off at 13 mA, set the hysteresis to 2 mA. The input will be considered off when the value is 2 mA less than the threshold.

Input Type

Program the universal inputs to accept input types NPN, PNP, 10k thermistor, 0 to 10 V, 0 to 20 mA, or potentiometer. The default setting is 8: NPN raw fast. To set the input type, write the following values to the Input Type Modbus registers.

- 0 = NPN
- 1 = PNP
- 2 = 0 to 20 mA
- 3 = 0 to 10 V dc
- 4 = 10k Thermistor
- 5 = Potentiometer Sense (DXM150 only)
- 6 = Not used
- 7 = Bridge
- 8 = NPN Raw Fast (default)

Temperature °C/°F

Set to 1 to represent temperature units in degrees Fahrenheit, and set to 0 (default) to represent temperature units in degrees Celsius.

Modbus Configuration Registers for the Analog Output

The DXM100-B1 I/O base board has two analog outputs that are selectable as 0 to 20 mA (factory default) or 0 to 10 V. To change the analog output characteristic, physical jumpers must be change on the I/O board and a parameter Modbus register must be changed. For step by step instructions on changing the output characteristics see [Analog \(DAC\) Outputs](#) on page 18.

Modbus Register	Analog Output	Description
4008	Analog Output 1	0 to 20 mA or 0 to 10 V dc output (I/O board jumper selectable)
4028	Analog Output 2	Accuracy: 0.1% of full scale +0.01% per °C Resolution: 12-bit After changing the jumper position, write the appropriate value to the Modbus registers to define your analog output to match the setting selected by the jumper. 2 = 0 to 20 mA output (default) 3 = 0 to 10 V output

Modbus Configuration Registers for Power

To monitor the input power characteristics of the DXM Slave, read the following power Modbus registers. The on-board thermistor is not calibrated, but can be used as a non-precision temperature input.

Modbus Register	Description
6071	Battery backup charging algorithm. 0 = Battery is recharged from a solar panel 1 = Battery is recharged from 12 to 30 V dc . (default)
6081	Battery voltage (mV)
6082	Battery charging current (mA)
6083	Incoming supply voltage (mV) (solar or power supply)
6084	On-board thermistor temperature (°C)

5 I/O Base Board for the DXM100-S2 Model

5.1 DXM100-B2 and S2 I/O Base Board Connections

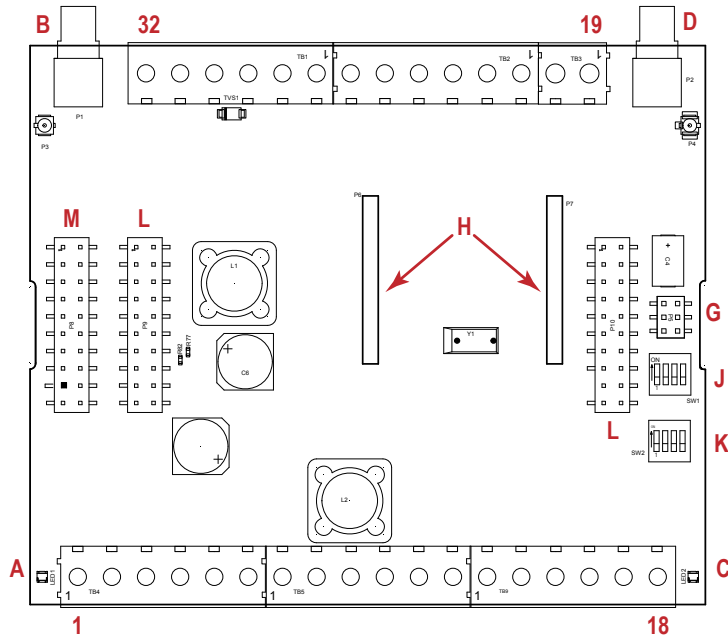

1	No connection	12	D2B. DLatch 2B	23	N3. NMOS OUT 3
2	PW. 12–30 V dc or solar power in (+)	13	S-. Secondary RS-485 –	24	N2. NMOS OUT 2
3	GD. Ground	14	S+. Secondary RS-485 +	25	N1. NMOS OUT 1
4	B+. Battery in (< 15 V dc)	15	P12. SDI-12 Courtesy Power	26	GD. Ground
5	GD. Ground	16	D12. SDI-12 Data	27	U4. Universal Input 4
6	M-. Primary RS-485 –	17	GD. GND	28	U3. Universal Input 3
7	M+. Primary RS-485 +	18	P3. Courtesy Power 5 V	29	GD. Ground
8	GD. Ground	19	A2. Analog OUT 2 (0–10 V)	30	P1. Adjustable Courtesy Power (5–24 V)
9	D1A. DLatch 1A	20	A1. Analog OUT 1 (0–10 V)	31	U2. Universal Input 2
10	D1B. DLatch 1B	21	P2. Adjustable Courtesy Power (5–24 V)	32	U1. Universal Input 1
11	D2A. DLatch 2A	22	N4. NMOS OUT 4		

A	Base board LED			J	Modbus Slave ID DIP Switches
B	A1. Cellular antenna			K	Modbus Slave ID DIP Switches
C	Radio LED	G	Programming header	L	SAM4 Processor Board Connection
D	A2. ISM Antenna	H	ISM Radio Board Connection	M	Display Connection

5.1.1 DIP Switches for the I/O Board

The DXM100-Sx Modbus Slave I/O board DIP switches are set from the factory to Modbus Slave ID 11. For more information, refer to *Setting the Modbus Slave ID on the I/O Base Board*.

5.1.2 Setting the Modbus Slave ID on the I/O Base Board

Only DXM100-S1 and -S1R2 Slave models require that the Modbus Slave ID to be adjusted on the I/O base board. The DXM100-Sx Modbus Slave models use DIP switches J and K to set the Modbus Slave ID. This device can use a Modbus register 6804 in the I/O board to access the full range of Modbus Slave IDs.

On the DXM100-Sx Modbus Slave models, use the DIP switches at location K to define the lower digit of the Modbus Slave ID.

DIP Switch location J defines the course group of Modbus Slave IDs. DIP Switch 4 must be set to ON for DXM100-S1, DXM100-S2, DXM100-S1R2, and DXM100-S2R2 models.

Settings	Location J DIP Switches			
	1	2	3	4
Modbus Slave ID set to 11 through 19	OFF	OFF		
Modbus Slave ID set to 20 through 29	ON	OFF		
Modbus Slave ID set to 30 through 39	OFF	ON		
Modbus Slave ID set to 40 through 49	ON	ON		
Not Used			-	
Modbus Slave Configuration (DX100-S1 and -S1R2 models only) ⁵				ON
Standard Communication Mode				OFF

DIP Switches J		DIP Switch K, Switches 1, 2, 3, 4 (0 is OFF, 1 is ON)									
1	2	0,0,0,0	1,0,0,0	0,1,0,0	1,1,0,0	0,0,1,0	1,0,1,0	0,1,1,0	1,1,1,0	0,0,0,1	1,0,0,1
OFF	OFF	x ⁶	11	12	13	14	15	16	17	18	19
ON	OFF	20	21	22	23	24	25	26	27	28	29
OFF	ON	30	31	32	33	34	35	36	37	38	39
ON	ON	40	41	42	43	44	45	46	47	48	49

DXM100-Sx Modbus Slave Example—To set the DXM100-Sx Modbus Slave to a Modbus Slave ID of 34, set the following:

- Location J DIP switches set to 1=OFF, 2=ON
- Location K DIP switches set to 1=OFF, 2=OFF, 3=ON, 4=OFF

The location J DIP switches set the upper Modbus Slave ID digit to 3 while the location K DIP switches set the lower digit to 4.

Setting the DXM I/O Board Modbus Slave ID using Modbus Registers—Write to the I/O board's Modbus register 6804 to set the Modbus Slave ID to any valid Modbus Slave ID (1 through 245).

- For the DXM100-Sx Modbus Slave model, all switches on DIP switch K should be in the OFF position to use the Modbus register slave ID.

5.2 Applying Power to the DXM100-Sx Modbus Slave

Apply power to the DXM100-Sx Modbus Slave using either 12 to 30 V dc or a 12 V dc solar panel and 12 V sealed lead acid battery.

Pin	Description
Pin 1	No connection
Pin 2	12 to 30 V dc input (+) or solar panel connection (+)
Pins 3, 5, 8, 17, 26, 29	Main logic ground for the DXM100-Sx Modbus Slave
Pin 4	Solar or backup battery positive input. Battery voltage must be less than 15 V dc. Use only a sealed lead acid (SLA) battery.

⁵ Must be in the ON position for the -S1 and -S1R2 model)
⁶ Uses value in Modbus register 6804.

5.2.1 Using Courtesy Power or Switch Power

Pin 18 of the DXM100-Sx Modbus Slave is a constant power source that supplies 5 volts up to 500 mA.

Pins 21 (switch power 2) and 30 (switch power 1) are switched power outputs. Configure the switched power outputs using Modbus registers. The output voltage can be selected and is controlled using a Modbus register on the I/O board (Modbus slave ID 200). The voltage options are:

- 5 volts or 16 volts for DXM100-B1 models; or
- 5 to 24 V dc for DXM100-B2 models.

Turn the switched power on or off using the output register 505 for switch power 1 or 506 for switch power 2. For continuous power, set the Default Output register to 1, then cycle the power.

Switch Power	Enable Register	Voltage Register	Default Output Register	Output Register
1 (pin 30)	2201 Write a 0 to turn OFF Write a 1 to turn ON (default)	3601 Write a 0 to select 5 V (default) Write a 1 to select 16 V	3602	505
2 (pin 21)	2251 Write a 0 to turn OFF Write a 1 to turn ON (default)	3621 Write a 0 to select 5 V (default) Write a 1 to select 16 V	3622	506

Enable Register

Configuration registers that turn on the ability to use the switched power output.

Default setting = ON

Voltage Register

Configuration registers that define the output voltage to the switched power output.

Default setting = 5 V

Default Output Register

Configuration registers that turn on the switched power outputs for continuous power out.

Set register to 1 for continuous power. Cycle power if this register is changed.

Default setting = 0

Modbus Output Register

Turn on or turn off the voltage output. If both outputs 505 and 506 are turned on at the same time but are set to different voltages, the output voltage is 5 V for DXM100-B1 models and set to the lower voltage setting for DXM100-B2 models.

5.2.2 Associating a Switched Power Output to an Input

Switched power 1 and 2 (pins 30 and 21) can be associated to any Universal input to apply power a sensor, take a reading, and then remove power from the sensor. This conserves power in battery-operated systems.

The switched power supply can be used in one of two different ways: supplying courtesy power to an output pin or associated to an input. (Only one method can be active at a time.)

Use the following configuration parameters to define the courtesy power supplied to a switched power output pin.

Courtesy Power Output Configuration Parameters ⁷	Modbus Registers	
	Switched Power 1	Switched Power 2
Switched Power Enable	2201	2251
Voltage	3601	3621
Default Output	3602	3622
Output Register	505	506

Default Output

Set the register value to 1 for continuous power. The default setting is 0.

Cycle power if this register value is changed.

⁷ Only used when supply courtesy power to the output pin, not when associating switched power to an input.

Switched Power Enable

Enables the switched power supply. Set to 1 to enable; set to 0 to disable.

This does not enable the supply output to the actual output pin. To enable the supply output to the output pin, set Modbus register 505 or 506 to 1. Set to 0 when associating the switched power supply to an input.

Output Register

Write to the Output register to turn on or turn off the voltage output.

If both Output Registers 505 and 506 are turned on at the same time, but are set to different voltages, the output voltage is 5 V for DXM100-B1 models and set to the lower voltage setting for DXM100-B2 models.

Voltage

For the B1 and S1 models, set the Modbus register value to 0 for a switched power supply at 5 volts. Set the Modbus register value to 1 for a switched power supply at 16 volts.

For the B2 and S2 models, set one of the following register values to select your switched power output voltage.

- For 5 V, set the Modbus register to 204.
- For 7 V, set the Modbus register to 125.
- For 10 V, set the Modbus register to 69.
- For 15 V, set the Modbus register to 32.
- For 20 V, set the Modbus register to 12.
- For 24 V, set the Modbus register to 3.

When associating a switched power supply to an input, set the Switch Power Output Enable register to off (0). Set Modbus register 2201 for switched power 1 and Modbus register 2251 for switched power 2. This allows the input sampling mechanism to control the output.

Use the following configuration parameters to define the switch power associated with an input.

Input Parameter	Universal Input Configuration Parameter Modbus Registers			
	Universal Input 1	Universal Input 2	Universal Input 3	Universal Input 4
Input Enable	1001	1051	1101	1151
Sample Interval (high)	1002	1052	1102	1152
Sample Interval (low)	1003	1053	1103	1153
Switched Power Enable Mask	1004	1054	1104	1154
Switched Power Warmup	1005	1055	1105	1155
Switched Power Voltage	1006	1056	1106	1156
Extended Input Read	1007	1057	1107	1157
Input Out-of-Sync Enable	1008	1058	1108	1158

Extended Input Read

The Extended Input Read is a bit field parameter that allows multiple inputs to be sampled with the same switch power parameters.

If the bit field is set to 0x000F, the first four inputs are sampled after the switch power parameters are satisfied.

If the Extended Input Read parameter is set in the Universal input 1 configuration registers, set Universal inputs 2 through 4 Extended Input Read and Sample Interval parameters to zero.

Input Enable

Set to 1 to enable the input. Set to 0 to disable the input.

Out-of-Sync Enable

To enable the input to continue operating when the device is out of sync with the master radio, set to 1.

To disable the input when the device is not synchronized to the master radio, set to 0.

Sample Interval (high), Sample Interval (low)

The sample interval (rate) is a 32-bit value (requires two Modbus registers) that represents how often the I/O board samples the input.

The register value is the number of time units. One time unit is equal to 0.01 seconds.

For example, a Modbus register value of 1000 represents a sample interval of 10 seconds (1000 × 0.010 seconds = 10 seconds).

Switch Power Enable Mask

The Switch Power Enable Mask works with the warm-up and voltage parameters to define the switch power output. The bit mask can select any number of switch powers.

- 0x0 - No switch power enabled
- 0x1 - Enable Switch Power 1
- 0x2 - Enable Switch Power 2
- 0x3 - Enable Switch Power 1 and Switch Power 2

Switch Power Voltage

The Switch Power Voltage parameter defines the output voltage of the switch power output.

This parameter applies only to inputs using switched power. If switch power is not used with an input, use the Courtesy Power Voltage parameter to control the voltage.

See *Voltage* entry for Modbus register values used to select the output voltage.

Switch Power Warm-up

When an input controls power to external sensors, the Switch Power Warm-up parameter defines how long power is applied to the external sensor before the input point is examined for changes.

The register value is the number of time units, and a time unit is 0.01 seconds. For a warm-up time of 1 second, this parameter value is 100 (0.01 seconds \times 100 = 1 second).

Associate Universal Input 1 with Switch Power 1

To associate universal input 1 with switched power 1, follow these instructions. Set Input 1 to sample every 60 seconds, with a warmup time of 10 seconds.

1. Verify Switched Power 1 Output Enable is off (0). Set Modbus Register 2201 = 0
2. Set the Sample Interval to 1 minute. Modbus Registers 1002 = 0, 1003= 6000 (0.01 seconds \times 6000 = 60 seconds).
3. Set the Switched Power Enable Mask to use Switch Power 1. Modbus Register 1004 = 1
4. Set the Switched Power Warm-up time to 10 seconds. Modbus Register 1005 = 1000 (0.01 seconds \times 1000 = 10 seconds).
5. Set the Switched Power Voltage to 16 volts. Modbus Register 1006 = 1.

5.2.3 Connecting a Battery to the DXM Slave

When attaching a battery to the DXM Slave as a backup battery or as a solar battery, verify the charging algorithm is set properly. The factory default setting for the battery charging algorithm assumes you are using 12 to 30 V dc to recharge the battery.

The charging algorithm is designed to work with a sealed lead acid (SLA) battery only.

- When using 12 to 30 V dc, connect the 12 to 30 V dc + to pin 2 and connect the ground to pin 3.
- When using main dc power with a back up battery (default configuration), connect the incoming main power pin 2 (+) and to pin 3 (-). Connect the 12 V sealed lead acid battery to pin 4 (+) and pin 5 (-). The incoming main power must be 15 to 30 V dc to charge the battery.
- When using a solar panel, connect the solar panel output to pin 2 and connect the ground to pin 3. Connect the 12 V dc SLA battery to pin 4 (+) and pin 5 (-). To change the charging algorithm, refer to [Supplying Power from a Solar Panel](#) on page 14.

Modbus Slave ID	Modbus Register	Description
11 *	6071	Battery backup charging algorithm. 0 = Battery is recharged from a solar panel 1 = Battery is recharged from 12 to 30 V dc (default)

* The Modbus Slave ID for the base board is set at the factory and may be changed using the base board DIP switch settings.

5.2.4 Supplying Power from a Solar Panel

To power the DXM100-Sx Modbus Slave from a 12 V dc solar panel, connect the solar panel to power pins 2(+) and 3(-). Connect a 12 V dc sealed lead acid (SLA) rechargeable battery to pins 4(+) and 5(-).

The factory default setting for the battery charging algorithm assumes you are using 12 to 30 V dc power to recharge the battery. If the incoming power is from a solar panel, you must change the charging algorithm.

To change the charging algorithm from the menu system:

1. From the LCD menu, select Update > Power.

- Use the up/down arrows to select "SOLAR" power.

To change the charging algorithm by writing to Modbus register 6071 on the I/O base board (Slave ID 11):

- Write a 0 to select the solar power charging algorithm.

Modbus Slave ID	Modbus Register	Description
11 *	6071	Battery backup charging algorithm. 0 = Battery is recharged from a solar panel 1 = Battery is recharged from 12 to 30 V dc (default)

The following power operating characteristics are stored in Modbus registers.

Battery voltage

If no battery is present, the value in this register is less than 5 V. If the value in this register is greater than the incoming voltage register, the battery is powering the system.

Battery charging current

The charging algorithm charges the battery when the incoming voltage register value is greater than the battery voltage register value. This registers shows the charging current in milliamps.

Incoming supply voltage

The incoming power can be from a solar panel or from a power supply. The battery is charging when the incoming voltage register value is greater than the battery voltage register value. The battery is powering the system when the incoming voltage register value is less than the battery voltage register value.

On-board thermistor temperature

This register stores the on-board thermistor reading in tenths of degrees C, this is not a calibrated input: divide by 10 to calculate the temperature in degrees C. For calibrated temperature inputs, define one of the universal inputs as a temperature input.

Modbus Slave ID	Modbus Register	Description
11 *	6081	Battery voltage (mV)
	6082	Battery charging current (mA)
	6083	Incoming supply voltage (mV) (solar or power supply)
	6084	On-board thermistor temperature (°C)

* The Slave ID for the base board is set at the factory. This may be changed using the base board DIP switch settings.

5.3 Working with Solar Power

A reliable solar system requires careful planning and monitoring to size the components correctly. The recommendations provided are for the DXM Slave system as an autonomous system.

Adding extra components increases the power requirements and likely requires increasing the solar system components. Depending upon the geographical location, the size of the solar panel and battery may vary.

5.3.1 Setting the DXM Slave for Solar Power

By default, the DXM Slave is set from the factory to charge a backup battery from a line power source.

5.3.2 Solar Components

The components of a solar system include the battery and the solar panel.

Battery

The DXM solar controller is designed to use a 12 V lead acid battery. The characteristics of a solar system require the battery to be of a certain type. There are basically two types of lead acid batteries:

- SLI batteries (Starting Lights Ignition) designed for quick bursts of energy, like starting engines
- Deep Cycle batteries - greater long-term energy delivery. This is the best choice for a solar battery.

Since a solar system charges and discharges daily, a deep cycle battery is the best choice. There are different versions of a lead acid battery: wet cell (flooded), gel cell, and an AGM (absorbed glass mat).

Wet cell batteries are the original type of rechargeable battery and come in two styles, serviceable and maintenance free. Wet cell batteries typically require special attention to ventilation as well as periodic maintenance but are the lowest cost. The gel cell and AGM battery are sealed batteries that cost more but store very well and do not tend to sulfate or degrade as easily as a wet cell. Gel or AGM batteries are the safest lead acid batteries you can use.

Battery Capacity

Battery capacity is a function of the ambient temperature and the rate of discharge. Depending upon the specific battery, a battery operating at $-30\text{ }^{\circ}\text{C}$ can have as much as 40 percent less capacity than a battery operating at $20\text{ }^{\circ}\text{C}$. Choose enough battery capacity based on your geographical location.

A larger capacity battery typically lasts longer for a given solar application because lead-acid batteries do not like deep cycling (discharging a large percentage of its capacity). Depending upon the battery, a battery discharging only 30 percent of its capacity before recharging will have approximately 1100 charge/discharge cycles. The same battery discharging 50 percent of its capacity will have approximately 500 charge/discharge cycles. Discharging 100 percent leaves the battery with only 200 charge/discharge cycles.

Batteries degrade over time based on discharge/charge cycles and environmental conditions. Always monitor the battery system to obtain the best performance of the solar powered system.

Use this as a guide to the approximate state of charge and in determining when to apply conservation measures.

Average Voltage Readings Relative to Battery Change	
State of Charge (%)	Open Circuit Voltage
100	13.0 or higher
75	12.6
50	12.1
25	11.66
0	11.4 or less

Solar Panel

Banner solar panels come in two common sizes for the DXM Slave: 5 Watt and 20 Watt. Both panels are designed to work with the DXM Slave but provide different charging characteristics. Use the 5 watt panel for light duty operation and use the 20 watt panel when you require greater charging capabilities.

Solar Panel	Voltage	Current	Typical DXM Configurations
5 Watt	17 V	0.29 A	DXM slave controller, ISM radio, I/O base board
20 Watt	21 V	1 A	DXM Controller with ISM radio and Cellular modem

Photovoltaic panels are very sensitive to shading. Unlike solar thermal panels, PV solar panels cannot tolerate shading from a branch of a leafless tree or small amounts of snow in the corners of the panel. Because all cells are connected in a series string, the weakest cell will bring down the other cells' power level.

Good quality solar panels will not degrade much from year to year, typically less than 1 percent .

Solar Panel Mounting

To capture the maximum amount of solar radiation throughout the year, mount a fixed solar panel to optimize the sun's energy throughout the year. For the northern hemisphere, face the panel true south. For the southern hemisphere, face the panel true north. If you are using a compass to orientate the panels, compensate for the difference between true north and magnetic north. Magnetic declination varies across the globe.

A solar panel's average tilt from horizontal is at an angle equal to the latitude of the site location. For optimum performance, adjust the tilt by plus 15 degrees in the winter or minus 15 degrees in the summer. For a fixed panel with a consistent power requirement throughout the year, adjust the tilt angle to optimize for the winter months: latitude plus 15 degrees. Although in the summer months the angle may not be the most efficient, there are more hours of solar energy available.

For sites with snow in the winter months, the increased angle helps to shed snow. A solar panel covered in snow produces little or no power.

5.3.3 Recommended Solar Configurations

These solar panel and battery combinations assume direct sunlight for two to three hours a day. Solar insolation maps provide approximate sun energy for various locations. The depth of battery discharge is assumed to be 50 percent.

Solar panel and battery combinations for a DXM Slave system				
Solar Panel	Battery Capacity ⁸	Days of Autonomy	DXM mA	DXM Controller
5 watt	10 Ahr	10 days	25 mA	DXM Slave Controller - ISM radio and I/O base board
20 watt	14 Ahr	10 days	30 mA	DXM Controller with ISM radio
20 watt	20 Ahr	10 days	35 mA	DXM Controller with ISM radio and Cellular Modem

5.3.4 Monitoring Solar Operation

The DXM solar controller provides Modbus registers that allow the user to monitor the state of the solar panel input voltage, the battery voltage, the charging current, and the temperature in °C. The DXM Slave can be configured to monitor the health of the charging system as well as send an alert message when the battery is too low.

The charts show a typical charging cycle, with each vertical grid representing about eight hours. The chart shows three days of charging.

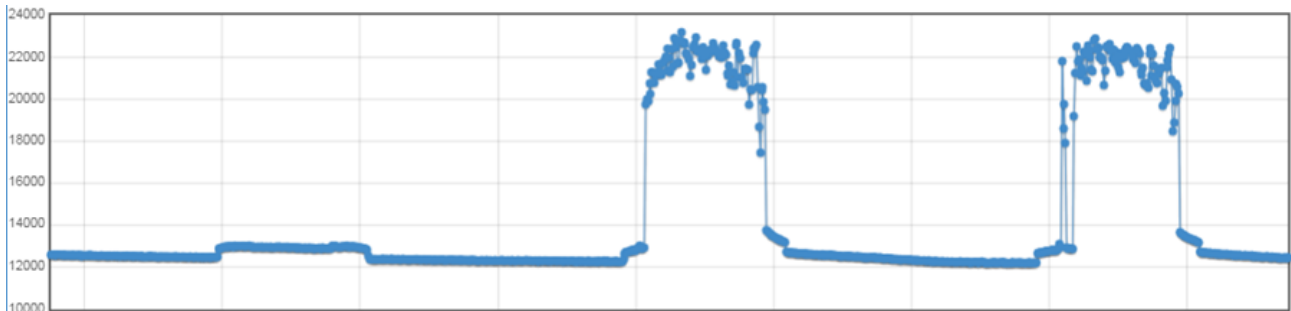

Figure 3. Solar Panel Voltage (mV) -- Cloudy First Day

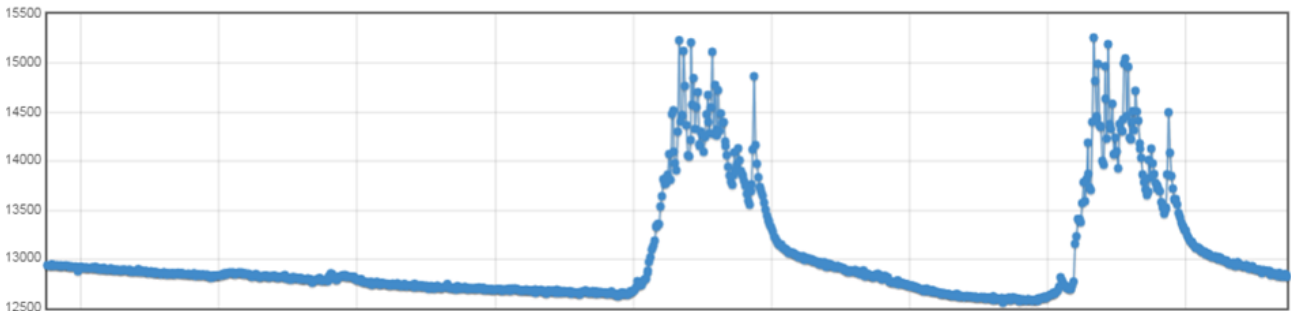

Figure 4. Battery Voltage (mV) - Cloudy First Day

5.4 Connecting the Communication Pins

The base board communications connection for external Modbus device uses the primary RS-485.

RS-485. The primary RS-485 bus is a common bus shared with the ISM radio board (Modbus Slave ID 1).

RS-232. The RS-232 bus is not currently defined.

Pin	Parameter	Description
Pin 6	Primary RS-485 -	Running Modbus protocol at 19.2k baud, use this bus to connect to other Modbus Slave devices. The DXM100-Sx Modbus Slave is a Modbus Master device on this RS-485 port. Modbus Register 6101 = Baud Rate 0 = 19.2k 1 = 9600 2 = 38400 Modbus Register 6103 = Parity 0 = no parity 1 = odd? 2 = even?
Pin 7	Primary RS-485 +	

⁸ Battery capacity (amp hour) is standard amp rating taken for 20 hours. Battery capacity should be monitored for reliable system power and may need to be increased for cold weather locations.

Pin	Parameter	Description
Pin 9	RS-232 Tx	Serial RS-232 connection. This bus must use a ground connection between devices to operate correctly.
Pin 10	RS-232 Rx	
Pin 13	Secondary RS-485 -	Not used
Pin 14	Secondary RS-485 +	
Pin 15	CANL -	
Pin 16	CANH +	

5.5 Inputs and Outputs

The I/O base board is a Modbus slave device that communicates using Modbus commands. Refer to the Modbus Registers section for more descriptions of each Modbus register on the DXM100-Sx Modbus Slave.

5.5.1 Universal Inputs

The universal inputs on the DXM100-Sx Modbus Slave can be programmed to accept several different types of inputs:

- Discrete NPN/PNP
- 0 to 20 mA analog
- 0 to 10 V analog
- 10k temperature thermistor
- Potentiometer sense
- Bridge
- NPN raw fast

Any input can be used as a synchronous counter by configuring the input as a discrete NPN/PNP input.

Use the DXM Configuration Tool tool to write to the appropriate Modbus registers in the I/O board to configure the input type. The universal inputs are treated as analog inputs. When the universal inputs are defined as mA, V, or temperature, use Modbus registers to configure the operational characteristics of the inputs. These parameters are temperature conversion type, enable full scale, threshold and hysteresis. Refer to the DXM100 Controller Instruction Manual (p/n [190037](#)) for the parameter definitions.

When a universal input is configured as an NPN or PNP input type, it can be enabled to be a synchronous counter. Enable the counter function by setting Modbus register 'Enable Rising' or 'Enable Falling' to 1. See [Modbus I/O Registers for the DXM100-S1x I/O Base Board](#) on page 19 for universal input register definitions.

Pin	Universal Input	Modbus Register	Description
27	4	4	Program the universal inputs to accept input types NPN, PNP, 10k thermistor, 0 to 10 V, 0 to 20 mA, or potentiometer. The default setting is 8: NPN raw fast. To set the input type, write the following values to the Input Type Modbus registers defined in Modbus I/O Registers for the DXM100-S1x I/O Base Board on page 19. 0 = NPN 1 = PNP 2 = 0 to 20 mA 3 = 0 to 10 V dc 4 = 10k Thermistor 5 = Not used 6 = Not used 7 = Bridge 8 = NPN Raw Fast (default)
28	3	3	
31	2	2	
32	1	1	

Thermistor Input

A thermistor input must use a 10k temperature thermistor between ground and the universal input. The thermistor must be a 10k NTC (Banner model number BWA-THERMISTOR-002) or equivalent. Select the temperature conversion of degrees C (default) or degrees F by writing Modbus registers defined in [Modbus I/O Registers for the DXM100-S1x I/O Base Board](#) on page 19.

Potentiometer Input

A potentiometer input is created from three inputs: a voltage source (pin 30) that supplies 5 V to the potentiometer and two inputs set to voltage inputs to read the voltage across the potentiometer. See the DXM tech note for setting up a potentiometer.

Bridge Input

The bridge input is not implemented yet.

NPN vs NPN Raw Fast

The difference between NPN and NPN Raw Fast is the amount of settling time given to the input. Switch the input type to NPN if the input is not detecting a transition.

Synchronous Counters

When an input is configured as a counter (inputs set to NPN/PNP), the input counts the input signal transitions. The count value is stored into two 16-bit Modbus registers for a total count of 32-bits (unsigned). To program an input to capture the edge transition counts, follow [Example: Configure Input 1 as a Synchronous Counter](#) on page 18.

Synchronous counter sample the inputs every 10 ms. The input logic does not detect rising or falling edges, but instead samples the input every 10 ms to find level changes. The input signals must be high or low for more than 10 ms or the input will not detect transitions. Because most signals are not perfect, a realistic limit for the synchronous counter would be 30 to 40 Hz.

Example: Configure Input 1 as a Synchronous Counter

1. Change the Source Register selection to I/O Board Registers.
2. In the Write Registers area, write Modbus register 4908 to 1 to enable counting on the rising edge of the input signal.
3. Read Modbus registers 4910 and 4911 to get the 32-bit value of the count.

Example: Change Universal Input 2 to a 0 to 10 V dc Input

1. Write a 3 to Modbus register 3326 on Modbus Slave ID 11 (I/O board).
2. Cycle power to the device.
3. Using the Register View tab, read register 3326 to verify it is set to 3.

Example: Change Analog Output 1 to a 0 to 10 V dc Output

1. Change the Source Register selection to I/O Board Registers.
2. Set jumper 1 on the I/O base board to the 0 to 10 V position. Refer to the base board image for the analog output jumper position.
3. Write a 3 to Modbus register 4008 on Modbus Slave ID 11 (I/O board).
4. Cycle power to the device.
5. Using the Register View tab, read register 4008 to verify it is set to 3.

5.5.2 NMOS Outputs

Pin	NMOS Discrete Outputs	Modbus Register	Description	Wiring
22	4	504	Less than 1 A maximum current at 30 V dc ON-State Saturation: Less than 0.7 V at 20 mA ON Condition: Less than 0.7 V OFF Condition: Open	
23	3	503		
24	2	502		
35	1	501		

5.5.3 Analog (DAC) Outputs

The DXM100-B2 and S2 analog outputs are 0 to 10 V dc outputs and cannot be changed.

DXM100-B2 and S2 Models				
Pin	Analog Output	Modbus Register	Description	
20	1	509	0 to 10 V dc output	
19	2	510	Accuracy: 0.1% of full scale +0.01% per °C Resolution: 12-bit	

Parameters for Analog Output 1 start at 4001 through 4008. Parameters for Analog Output 2 start at 4021 through 4028.

Parameter Registers for Analog Outputs (4xxxx)		
OUT 1	OUT 2	Parameters
4001	4021	Maximum Analog Value
4002	4022	Minimum Analog Value
4003	4023	Enable Register Full Scale
4004	4024	Hold Last State Enable
4005	4025	Default Output State

Default Output Conditions. Default output conditions/triggers are the conditions that drive outputs to defined states. Example default output conditions include when radios are out of sync, when a device cycles power, or during a host communication timeout.

- 2952 Enable Default Communication Timeout. A "communication timeout" refers to the communication between any Modbus master host and the DXM baseboard. Set this register to 1 to enable the default condition when the host has not communicated with the DXM baseboard for the period of time defined by the Communication Default IO Timeout.
- 2953 Communication Default I/O Timeout (100 ms/Count). This parameter defines the host timeout period in 100 millisecond increments. If a host does not communicate within this timeout period, the device outputs are set to the default values.
- 2954 Enable Default on Power Up. Setting this parameter to 1 sends the device outputs to their default condition when the DXM baseboard is powered up. Set to 0 to disable this feature.

Default Output State. The Default Output State parameter represents the default condition of the analog output. When an error condition exists, the outputs are set to this 16-bit user-defined output state. To define the error conditions for device outputs, refer to the MultiHop default output parameters 2950-2954.

Enable Register Full Scale. Set to 1 to enable a linear range from 0 to 65535 for specified input range. For a 4 to 20 mA output, a value of 0 represents 4 mA and 65535 represents 20 mA. Set this parameter to 0 to store readings in unit-specific data. For example, the register data representing a 15.53 mA reading is 15530. For units of current (0 to 20 mA outputs), values are stored as μA (micro Amps) and voltage values are stored as mV (millivolts).

Hold Last State Enable. Set the Hold Last State to 1 to set the output to its last known value before the error occurred. Set this parameter to 0 to disable the Hold Last State and use the Default Output State setting during an error condition.

Maximum Analog Value. The Maximum Analog Value register stores the maximum allowed analog value. The specific units of measure apply to the register value. For example, the register may contain 20000, for 20 mA, or for a voltage output the register may contain 8000, for 8 volts.

Minimum Analog Value. The Minimum Analog Value register stores the minimum allowed analog value. The specific units of measure apply to register value. For example, the register may contain 4000, for 4 mA, or for a voltage output the register may contain 2000, for 2 volts.

5.5.4 DC Latching Outputs

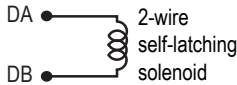
Pin	DC Latching Outputs	Modbus Register	Description	Wiring
9	D1A	507	Write a 1 to the output register to activate the DC Latching output from A to B.	 <p>2-wire self-latching solenoid</p>
10	D1B			
11	D2A	508	Write a 0 to the output register to deactivate the DC Latching output form B to A.	
12	D2B			

5.5.5 SDI-12 Interface

The SDI-12 interface on the DXM100-B2 Wireless Controllers can support up to five devices with twelve 32-bit register values each. The DXM100-B2 SDI-12 interface can be configured to increase the number of registers per device address for devices with large register sets. The factory default enables one SDI-12 device using device address 1 with up to nine registers with a SDI-12 command of "M!".

The DXM100-B2 controller is configured by writing non-volatile Modbus registers with configuration parameters. Read or write the device configuration parameters using standard Modbus commands.

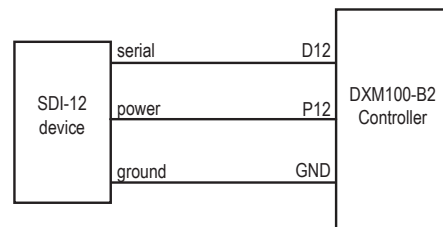

Basic SDI-12 Interface Parameters

Up to five devices/commands can be accessed using the SDI-12 interface. There are three parameters for each device/command: Enable, Device Address, Device Command. For more information, refer to the SDI-12 Technical Notes.

Enable. Instructs the DXM Slave device to activate or deactivate the SDI-12 device. Write a 1 to enable, and write a 0 to disable. The factory default for device 1 is enabled; devices 2 through 5 are disabled.

Device Address. Each SDI-12 device must have a unique device address. This parameter is the ASCII code for the device address. Valid device addresses are 0–9 and a–z that map to ASCII codes 48–57 and 97–122, respectively. The factory default addresses are:

- SDI-12 Device 0 uses ASCII code 48
- SDI-12 Device 1 uses ASCII code 49
- SDI-12 Device 2 uses ASCII code 50
- SDI-12 Device 3 uses ASCII code 51
- SDI-12 Device 4 uses ASCII code 52

Device Command The SDI-12 interface supports "M!" or "C!" commands. Use the Device Command parameter to define which command to use for this device. The factory default is "M!" commands for all devices (value of 10 in the Modbus register).

Supported M! Commands		Supported C! Commands	
SDI-12 Command	Register Value	SDI-12 Command	Register Value
xM!	0 or 10	xC!	1 or 20
xM1!	11	xC1!	21
xM2!	12	xC2!	22
xM3!	13	xC3!	23
xM4!	14	xC4!	24
xM5!	15	xC5!	25
xM6!	16	xC6!	26
xM7!	17	xC7!	27
xM8!	18	xC8!	28
xM9!	19	xC9!	29

The Modbus configuration registers are listed. All registers are defined as Modbus holding registers. The factory default values are shown in parentheses. All values are in decimal, unless noted otherwise.

Device/CMD Configuration	Registers (Default Value)		
	Enable	Device Address	Device Command
SDI-12 Device/CMD 1	1751 (1)	11001 (48) ⁹	11002 (10)
SDI-12 Device/CMD 2	1701 (0)	11201 (49)	11202 (10)
SDI-12 Device/CMD 3	1651 (0)	11401 (50)	11402 (10)
SDI-12 Device/CMD 4	1601 (0)	11601 (51)	11602 (10)
SDI-12 Device/CMD 5	1551 (0)	11801 (52)	11802 (10)

SDI-12 Device Result Registers

The result registers store all information received from the SDI-12 devices.

The registers are 16-bit registers and require two registers to store a 32-bit value. The factory default configuration defines the result registers as 32-bit registers, floating point format, and the first nine result registers are enabled for use. A host system reads the SDI-12 device data from these registers.

Result Registers	Register 1	Register 2	Register 3	Register 4	Register 5	Register 6
SDI-12 Device/CMD 1 Result Upper	11101	11103	11105	11107	11109	11111

⁹ The default device addresses 48 through 52 are in ASCII.

Result Registers	Register 1	Register 2	Register 3	Register 4	Register 5	Register 6
SDI-12 Device/CMD 1 Result Lower	11102	11104	11106	11108	11110	11112
SDI-12 Device/CMD 2 Result Upper	11301	11303	11305	11307	11309	11311
SDI-12 Device/CMD 2 Result Lower	11302	11304	11306	11308	11310	11312
SDI-12 Device/CMD 3 Result Upper	11501	11503	11505	11507	11509	11511
SDI-12 Device/CMD 3 Result Lower	11502	11504	11506	11508	11510	11512
SDI-12 Device/CMD 4 Result Upper	11701	11703	11705	11707	11709	11711
SDI-12 Device/CMD 4 Result Lower	11702	11704	11706	11708	11710	11712
SDI-12 Device/CMD 5 Result Upper	11901	11903	11905	11907	11909	11911
SDI-12 Device/CMD 5 Result Lower	11902	11904	11906	11908	11910	11912

Result Registers	Register 7	Register 8	Register 9	Register 10	Register 11	Register 12
SDI-12 Device/CMD 1 Result Upper	11113	11115	11117	11119	11121	11123
SDI-12 Device/CMD 1 Result Lower	11114	11116	11118	11120	11122	11124
SDI-12 Device/CMD 2 Result Upper	11313	11315	11317	11319	11321	11323
SDI-12 Device/CMD 2 Result Lower	11314	11316	11318	11320	11322	11324
SDI-12 Device/CMD 3 Result Upper	11513	11515	11517	11519	11521	11523
SDI-12 Device/CMD 3 Result Lower	11514	11516	11518	11520	11522	11524
SDI-12 Device/CMD 4 Result Upper	11713	11715	11717	11719	11721	11723
SDI-12 Device/CMD 4 Result Lower	11714	11716	11718	11720	11722	11724
SDI-12 Device/CMD 5 Result Upper	11913	11915	11917	11919	11921	11923
SDI-12 Device/CMD 5 Result Lower	11914	11916	11918	11920	11922	11924

SDI-12 Device Settings

The following are generic sampling, power and warmup parameters that should work for all SDI-12 devices. See the tested device table below. In most cases, parameters will not need to be adjusted but if needed there are three common SDI-12 device parameters that control the communications and power of the SDI-12 device. Contact Banner Engineering Corp support for more guidance.

- **Sample Rate.** Formed using two 16-bit parameters, a HI word and a LOW word. The sample rate is how often the SDI-12 device is powered up, then interrogated for data. The value in the registers is the number of 0.010 second counts. For example, the default value is 22,500, which calculates to a sample rate of 22500×0.010 seconds. Adjusting this value affects the battery life.
- **Warmup time.** Amount of time to wait, in 0.010 second increments, from powering on the device to the time to send communications to the device. The default value is 50, or 50×0.010 seconds. Adjusting this value affects the battery life.
- **Voltage.** The default voltage setting is 6 volts or a register value of 168. Adjusting this value affects the battery life.

Device / Cmd Configuration	Registers (Default Value)							
	Enable	Device Address	Switch Power Enable	Device Command	Sample Hi	Sample Low	Warmup Time	Voltage
SDI-12 Device/CMD 1	1751 (1)	11001 (48) ¹⁰	1754 (1)	11002 (10)	1752 (0)	1753 (22500)	1755 (50)	1756 (148)
SDI-12 Device/CMD 2	1701 (0)	11201 (49)	1704 (0)	11202 (10)	1702 (0)	1703 (22500)	1705 (50)	1706 (148)
SDI-12 Device/CMD 3	1651 (0)	11401 (50)	1654 (0)	11402 (10)	1652 (0)	1653 (22500)	1655 (50)	1656 (148)
SDI-12 Device/CMD 4	1601 (0)	11601 (51)	1604 (0)	11602 (10)	1602 (0)	1603 (22500)	1605 (50)	1606 (148)
SDI-12 Device/CMD 5	1551 (0)	11801 (52)	1554 (0)	11802 (10)	1552 (0)	1553 (22500)	1555 (50)	1556 (148)

¹⁰ The default device addresses 48 through 52 are in ASCII.

These SDI-12 probes have been tested and are functional with the factory default settings.

MFG	Models	Technical Note
Acclima	SEN-SDI (TDT SDI-12 Soil Moisture Sensor)	SDI-12 and the Acclima TDT SDI-12 Soil Moisture Probe
Adcon Telemetry	HydraProbeII	
AquaCheck	Sub-surface Probe	SDI-12 and the AquaCheck Sub-Surface Soil Moisture Probe
Decagon	MPS-2, MPS-6, 5TE, TS1, T8	SDI-12 and the Decagon 5TE Soil Moisture Probe SDI-12 and the Decagon GS3 Soil Moisture Probe SDI-12 and the Decagon MPS-2 Soil Moisture Probe
HSTI	HydraScout	SDI-12 and the HydraScout HSTI Probe
Sentek	EnviroSCAN	SDI-12 and the Sentek EnviroScan Soil Moisture Probe

5.5.6 Modbus I/O Registers for the DXM100-S2x I/O Base Board

The I/O base board stores the input and output values in Modbus holding registers. Since the I/O base board is defined as a separate device, configure the DXM Slave to read or write the values on the I/O base board.

Base Board Input Connection		
Modbus Register	Range	Description
1	0–65535	Universal input 1
2	0–65535	Universal input 2
3	0–65535	Universal input 3
4	0–65535	Universal input 4

Universal Input Register Ranges			
Register Types	Unit	Minimum Value	Maximum Value
Discrete input/output		0	1
Universal input 0 to 10 V	mV	0	10000 *
Universal input 0 to 20 mA	µA	0	20000 *
Universal input temperature (–40 °C to +85 °C)	C or F, signed, in tenths of a degree	–400	850
Universal potentiometer	unsigned	0	65535

* Setting Enable Full Scale to 1 sets the ranges to a linear scale of 0 to 65535.

Base Board Output Connection		
Modbus Register	Range	Description
501	0–1	NMOS Output 1
502	0–1	NMOS Output 2
503	0–1	NMOS Output 3
504	0–1	NMOS Output 4
505	0–1	Switched Power 1 (5 V or 16 V)
506	0–1	Switched Power 2 (5 V or 16 V)
507	0–20000	Analog Output 1 default (0-20.000 mA)
	0–10000	Analog Output 1 (0-10.000 V)
508	0–20000	Analog Output 2 default (0-20.000 mA)
	0–10000	Analog Output 2 (0-10.000 V)

Modbus Configuration Registers for the I/O

Each input or output on the I/O base board has associated Modbus registers that configure its operation.

Universal Input Parameters Registers				
Universal Inputs	1	2	3	4
Enable Full Scale Registers	3303	3323	3343	3363
Temperature °C/°F Registers	3304	3324	3344	3364
Input Type Registers	3306	3326	3346	3366
Threshold Registers	3308	3328	3348	3368
Hysteresis Registers	3309	3329	3349	3369
Enable Rising Registers	4908	4928	4948	4968
Enable Falling Registers	4909	4929	4949	4969
High Register for Counter Registers	4910	4930	4950	4970
Low Register for Counter Registers	4911	4931	4951	4971

Enable Full Scale

Set to 1 to enable a linear range from 0 to 65535 for specified input range. For a 4 to 20 mA input, a value of 0 represents 4 mA and 65535 represents 20 mA. Set this parameter to 0 to store input readings in unit-specific data. For example, the register data representing a 15.53 mA reading is 15530. For units of current (0 to 20 mA inputs), values are stored as μA (micro Amps) and voltage values are stored as mV (millivolts).

Enable Rising/Falling

Use these registers to enable the universal input logic to count on a rising transition or a falling transition. Write a one (1) to enable; write a zero (0) to disable.

High/Low Register for Counter

The low and high registers for the counter hold the 32-bit counter value. To erase the counter, write zeroes to both registers. To preset a counter value, write that value to the appropriate register.

Hysteresis and Threshold

Threshold and hysteresis work together to establish the ON and OFF points of an analog input. The threshold defines a trigger point or reporting threshold (ON point) for a sensor input. Setting a threshold establishes an ON point. Hysteresis defines how far below the threshold the analog input is required to be before the input is considered OFF. A typical hysteresis value is 10% to 20% of the unit's range.

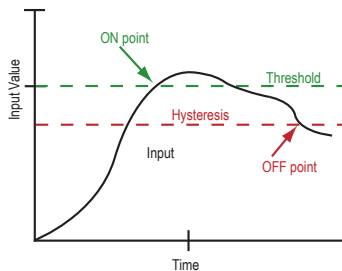

In the example shown graphically, the input is considered on at 15 mA. To consider the input off at 13 mA, set the hysteresis to 2 mA. The input will be considered off when the value is 2 mA less than the threshold.

Input Type

Program the universal inputs to accept input types NPN, PNP, 10k thermistor, 0 to 10 V, 0 to 20 mA, or potentiometer. The default setting is 8: NPN raw fast. To set the input type, write the following values to the Input Type Modbus registers.

- 0 = NPN
- 1 = PNP
- 2 = 0 to 20 mA
- 3 = 0 to 10 V dc
- 4 = 10k Thermistor
- 5 = Potentiometer Sense (DXM150 only)
- 6 = Not used
- 7 = Bridge
- 8 = NPN Raw Fast (default)

Temperature °C/°F

Set to 1 to represent temperature units in degrees Fahrenheit, and set to 0 (default) to represent temperature units in degrees Celsius.

Modbus Configuration Registers for the Analog Output

The DXM100-B1 I/O base board has two analog outputs that are selectable as 0 to 20 mA (factory default) or 0 to 10 V. To change the analog output characteristic, physical jumpers must be change on the I/O board and a parameter Modbus register must be changed. For step by step instructions on changing the output characteristics see [Analog \(DAC\) Outputs](#) on page 18.

Modbus Register	Analog Output	Description
4008	Analog Output 1	0 to 20 mA or 0 to 10 V dc output (I/O board jumper selectable) Accuracy: 0.1% of full scale +0.01% per °C Resolution: 12-bit After changing the jumper position, write the appropriate value to the Modbus registers to define your analog output to match the setting selected by the jumper. 2 = 0 to 20 mA output (default) 3 = 0 to 10 V output
4028	Analog Output 2	

Modbus Configuration Registers for Power

To monitor the input power characteristics of the DXM Slave, read the following power Modbus registers. The on-board thermistor is not calibrated, but can be used as a non-precision temperature input.

Modbus Register	Description
6071	Battery backup charging algorithm. 0 = Battery is recharged from a solar panel 1 = Battery is recharged from 12 to 30 V dc . (default)
6081	Battery voltage (mV)
6082	Battery charging current (mA)
6083	Incoming supply voltage (mV) (solar or power supply)
6084	On-board thermistor temperature (°C)

6 DXM Modbus Registers

All Modbus registers are defined as 16-bit Modbus Holding Registers. When connecting external Modbus slave devices, only use Modbus slave IDs 2 through 198.

DXM Internal Modbus Slave IDs (factory default)	
Modbus Slave ID	Device
1	ISM Radio—MultiHop wireless devices connected to the internal MultiHop radio should be assigned Modbus Slave addresses starting at 11.
11	I/O Base Board—All data and parameters for each input or output of the DXM Slave.

7 Restoring Factory Default Settings

To reset to factory defaults, write to two Modbus registers in the I/O board. The default slave ID for the I/O board is 11.

To reset the DXM I/O board parameters:

1. Write a 1 to Modbus register 4152
2. Write a 10 to Modbus register 4151

To reset only the I/O board:

1. Write a 0 to Modbus register 4152
2. Write a 10 to Modbus register 4151

Modbus Register	Values	Description
4151	0–255	Reset/restore trigger. This timer is based in 100 millisecond units. Once written, the timer starts to count down to zero. After the timer expires, the restore factory defaults are applied if register 4152 = 1. If register 4152 is zero, the I/O board is reset. Default value: 0 1 = 100 milliseconds, 10 = 1 second.
4152	0–1	1 = Restores factory defaults for I/O parameters. Default value: 0

8 DXM100 Dimensions

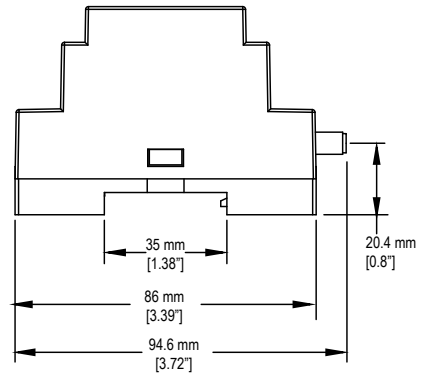
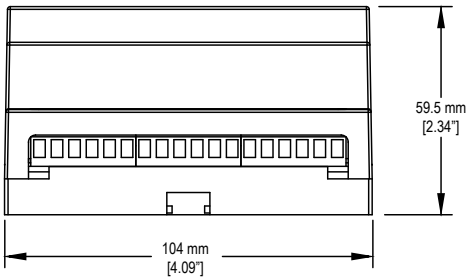
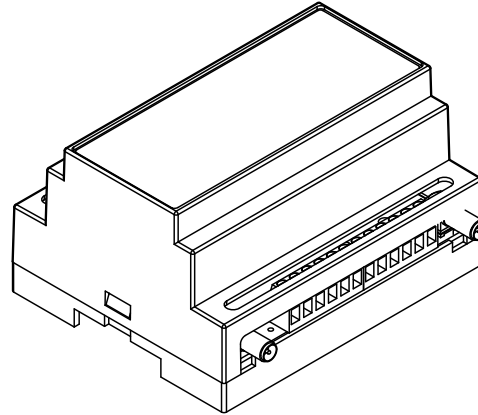
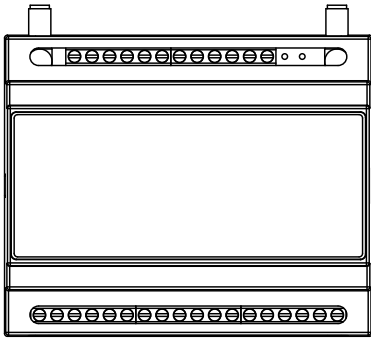

All measurements are listed in millimeters, unless noted otherwise.

9 Contact Us

Corporate Headquarters

Address:
Banner Engineering Corporate
9714 Tenth Avenue North
Minneapolis, Minnesota 55441, USA

Phone: +1 763 544 3164
Website: www.bannerengineering.com

Europe

Address:
Banner Engineering EMEA
Park Lane Culliganlaan 2F
Diegem B-1831, Belgium

Phone: +32 (0)2 456 0780
Website: www.bannerengineering.com/eu
Email: mail@bannerengineering.com

Turkey

Address:
Banner Engineering Turkey
Barbaros Mah. Uphill Court Towers A Blok D: 49
34746 Batı Ataşehir İstanbul Türkiye

Phone: +90 216 688 8282
Website: www.bannerengineering.com.tr
Email: turkey@bannerengineering.com.tr

India

Address:
Banner Engineering India Pune Head Quarters
Office No. 1001, 10th Floor Sai Capital, Opp. ICC Senapati Bapat Road
Pune 411016, India

Phone: +91 (0) 206 640 5624
Website: www.bannerengineering.co.in
Email: salesindia@bannerengineering.com

Mexico

Address:
Banner Engineering de Mexico Monterrey Head Office
Edificio VAO Av. David Alfaro Siqueiros No.103 Col. Valle Oriente C.P.66269
San Pedro Garza Garcia, Nuevo Leon, Mexico

Phone: +52 81 8363 2714 or 01 800 BANNERE (toll free)
Website: www.bannerengineering.com.mx
Email: mexico@bannerengineering.com

Brazil

Address:
Banner do Brasil
Rua Barão de Teffé nº 1000, sala 54
Campos Eliseos, Jundiaí - SP, CEP.: 13208-761, Brasil

Phone: +1 763 544 3164
Website: www.bannerengineering.com.br
Email: brasil@bannerengineering.com

China

Address:
Banner Engineering Shanghai Rep Office
Xinlian Scientific Research Building Level 12, Building 2
1535 Hongmei Road, Shanghai 200233, China

Phone: +86 212 422 6888
Website: www.bannerengineering.com.cn
Email: sensors@bannerengineering.com.cn

Japan

Address:
Banner Engineering Japan
Cent-Urban Building 305 3-23-15 Nishi-Nakajima Yodogawa-Ku
Osaka 532-0011, Japan

Phone: +81 (0)6 6309 0411
Website: www.bannerengineering.co.jp
Email: mail@bannerengineering.co.jp

Taiwan

Address:
Banner Engineering Taiwan
8F-2, No. 308 Section 1, Neihu Road
Taipei 114, Taiwan

Phone: +886 (0)2 8751 9966
Website: www.bannerengineering.com.tw
Email: info@bannerengineering.com.tw

10 Warnings

Install and properly ground a qualified surge suppressor when installing a remote antenna system. Remote antenna configurations installed without surge suppressors invalidate the manufacturer's warranty. Keep the ground wire as short as possible and make all ground connections to a single-point ground system to ensure no ground loops are created. No surge suppressor can absorb all lightning strikes; do not touch the Sure Cross® device or any equipment connected to the Sure Cross device during a thunderstorm.

Exporting Sure Cross® Radios. It is our intent to fully comply with all national and regional regulations regarding radio frequency emissions. Customers who want to re-export this product to a country other than that to which it was sold must ensure the device is approved in the destination country. A list of approved countries appears in the *Radio Certifications* section of the product manual. The Sure Cross wireless products were certified for use in these countries using the antenna that ships with the product. When using other antennas, verify you are not exceeding the transmit power levels allowed by local governing agencies. Consult with Banner Engineering Corp. if the destination country is not on this list.

10.1 Banner Engineering Corp. Limited Warranty

Banner Engineering Corp. warrants its products to be free from defects in material and workmanship for one year following the date of shipment. Banner Engineering Corp. will repair or replace, free of charge, any product of its manufacture which, at the time it is returned to the factory, is found to have been defective during the warranty period. This warranty does not cover damage or liability for misuse, abuse, or the improper application or installation of the Banner product.

THIS LIMITED WARRANTY IS EXCLUSIVE AND IN LIEU OF ALL OTHER WARRANTIES WHETHER EXPRESS OR IMPLIED (INCLUDING, WITHOUT LIMITATION, ANY WARRANTY OF MERCHANTABILITY OR FITNESS FOR A PARTICULAR PURPOSE), AND WHETHER ARISING UNDER COURSE OF PERFORMANCE, COURSE OF DEALING OR TRADE USAGE.

This Warranty is exclusive and limited to repair or, at the discretion of Banner Engineering Corp., replacement. IN NO EVENT SHALL BANNER ENGINEERING CORP. BE LIABLE TO BUYER OR ANY OTHER PERSON OR ENTITY FOR ANY EXTRA COSTS, EXPENSES, LOSSES, LOSS OF PROFITS, OR ANY INCIDENTAL, CONSEQUENTIAL OR SPECIAL DAMAGES RESULTING FROM ANY PRODUCT DEFECT OR FROM THE USE OR INABILITY TO USE THE PRODUCT, WHETHER ARISING IN CONTRACT OR WARRANTY, STATUTE, TORT, STRICT LIABILITY, NEGLIGENCE, OR OTHERWISE.

Banner Engineering Corp. reserves the right to change, modify or improve the design of the product without assuming any obligations or liabilities relating to any product previously manufactured by Banner Engineering Corp. Any misuse, abuse, or improper application or installation of this product or use of the product for personal protection applications when the product is identified as not intended for such purposes will void the product warranty. Any modifications to this product without prior express approval by Banner Engineering Corp will void the product warranties. All specifications published in this document are subject to change; Banner reserves the right to modify product specifications or update documentation at any time. Specifications and product information in English supersede that which is provided in any other language. For the most recent version of any documentation, refer to: www.bannerengineering.com.