

DPharp
HART 5/HART 7 Communication Type
(EJX□□□A, EJA□□□E)

IM 01C25T01-06EN













DPharp HART 5/HART 7 Communication Type (EJX□□□A, EJA□□□E)

IM 01C25T01-06EN 8th Edition

Contents

1.	Introduction.....	1-1
■	Regarding This Manual	1-1
1.1	Safe Use of This Product	1-2
1.2	Warranty.....	1-2
1.3	Abbreviation and Marking.....	1-3
1.4	Applicable Configuration Files.....	1-4
2.	Connection.....	2-1
2.1	Integral Indicator Display When Powering On	2-1
2.2	HART Protocol Revision	2-2
2.3	Device Description (DD) on a Configuration Tool and Transmitter Device Revision.....	2-3
2.4	Set the parameters using DTM.....	2-4
2.5	Interconnection Between DPharp and the HART Configuration Tool	2-5
2.6	Power Supply Voltage and Load Resistance 	2-5
3.	Parameter Setting.....	3-1
3.1	Menu Tree	3-1
3.2	Basic Setup.....	3-11
3.2.1	Tag and Device Information	3-11
3.2.2	Unit.....	3-11
3.2.3	Range Change.....	3-12
3.2.4	Output Mode	3-12
3.2.5	Damping Time Constant Setup.....	3-13
3.2.6	Output Signal Low Cut Mode Setup	3-13
3.2.7	Impulse Line Connection Orientation Setup.....	3-14
3.2.8	Static Pressure Setup	3-14
3.3	Detailed Setup	3-15
3.3.1	Static Pressure sensor.....	3-15
3.3.2	Bi-directional Flow Measurement	3-15
3.3.3	Analog Output Signal Adjustable Range	3-16
3.3.4	Integral Indicator Display Mode	3-16
3.3.5	Integral Indicator Scale Setup.....	3-16

3.3.6	Unit for Displayed Temperature	3-18
3.3.7	Sensor Trim.....	3-18
3.3.8	Trim Analog Output	3-20
3.3.9	External Switch Mode	3-20
3.3.10	CPU Failure Burnout Direction and Hardware Write Protect	3-21
3.3.11	Software Write Protection	3-21
3.3.12	Signal Characterizer	3-22
3.3.13	Alarm.....	3-23
3.3.14	Status Output (only for EJX series: option code AL) 	3-24
3.3.15	Capillary Fill Fluid Density Compensation	3-25
3.3.16	Test Output, Simulation, and Squawk.....	3-26
3.3.17	Burst Mode.....	3-28
3.3.17.1	In the case of using HART 5 	3-28
3.3.17.2	In the case of using HART 7  	3-28
3.3.18	Multidrop Mode	3-34
3.3.18.1	Setting on HART 5 	3-34
3.3.18.2	Setting on HART 7  	3-34
3.3.19	Switching HART Protocol Revision	3-35
4.	Diagnostics	4-1
4.1	Self-Diagnostics.....	4-1
4.1.1	Identify Problems by Using HART Configuration Tool.....	4-1
4.1.2	Checking with Integral Indicator.....	4-2
4.1.3	Status information available for HART 7 	4-2
4.1.4	NE107 Status Information.....	4-3
4.2	Advanced Diagnostics (Only for EJX series) 	4-4
4.2.1	Multi-sensing Process Monitoring.....	4-4
4.2.2	Impulse Line Blockage Detection (ILBD).....	4-4
4.2.2.1	Blockage Detection.....	4-6
4.2.2.2	Combination of Reference Result and Blockage Detection.....	4-8
4.2.2.3	Operation Parameters	4-9
4.2.2.4	Operating Procedure	4-11
4.2.2.5	Alarm and Alert Setting	4-12
4.2.2.6	Condition Check	4-14
4.2.2.7	Obtain Reference Values.....	4-15
4.2.2.8	Capability Test of Blockage Detection Operation	4-16
4.2.2.9	Start ILBD Operation	4-16
4.2.2.10	Tuning	4-17
4.2.2.11	Reset of Reference Value.....	4-18
4.2.2.12	ILBD Parameter List	4-19

4.2.3	Heat Trace Monitoring.....	4-21
4.2.3.1	Flg Temp Coef Setting	4-21
4.2.3.2	Out of Temperature Measurement Range.....	4-22
4.2.3.3	Parameter Lists for Heat Trace Monitoring.....	4-23
4.3	Alarms and Countermeasures	4-24
5.	Parameter Summary	5-1
Appendix 1.	Safety Instrumented Systems Installation 	A1-1
Appendix 2.	ILBD Check List.....	A2-1
Appendix 3.	Parameter Setting for Previous Version.....	A3-1
A3.1	Group I: DD and DTM (excluding EJX HART 5 DTM based on FDT1.2) ...	A3-1
A3.2	Group II: EJX HART 5 DTM based on FDT1.2	A3-9

Revision Information

1. Introduction

Thank you for purchasing the DPharp EJX series pressure transmitter/EJA series pressure transmitter(“transmitter”).

The transmitters are precisely calibrated at the factory before shipment.

To ensure both safety and efficiency, please read this manual carefully before operating the instrument.

This manual describes the HART protocol communication functions of the transmitter and explains how to set the parameters for the transmitters using the HART configuration tool. For information on the installation, wiring, and maintenance of the transmitters, please refer to the user’s manual of each model.



WARNING

When using the transmitters in a Safety Instrumented System application, refer to the Functional Safety Data Sheet (Document No.: TI 01C25A05-01EN or TI 01C25A05-21EN for option code SLT) and follow the instructions and procedures described there. The document can be downloaded from the website of Yokogawa. (Website address:

<https://www.yokogawa.com/solutions/products-platforms/field-instruments/>)

In order to satisfy the requirement of Safety Instrumented System, executing parameters setting is required. Please refer to chapter 3. “Parameter Setting” for setting range.

Please also refer to the status output setting in the same clause. After installing the transmitter, confirm that the range and unit is set correctly. Calibration of the transmitters shall be done after completing the range setting.

■ Regarding This Manual

- This manual should be provided to the end user.
- The contents of this manual are subject to change without prior notice.
- All rights reserved. No part of this manual may be reproduced in any form without Yokogawa’s written permission.

- Yokogawa makes no warranty of any kind with regard to this manual, including, but not limited to, implied warranty of merchantability and fitness for a particular purpose.
- If any question arises or errors are found, or if any information is missing from this manual, please inform the nearest Yokogawa sales office.
- The specifications covered by this manual are limited to those for the standard type under the specified model number break-down and do not cover custom-made instruments.
- Please note that changes in the specifications, construction, or component parts of the instrument may not immediately be reflected in this manual at the time of change, provided that postponement of revisions will not cause difficulty to the user from a functional or performance standpoint.
- The following safety symbols are used in this manual:



WARNING

Indicates a potentially hazardous situation which, if not avoided, could result in death or serious injury.



CAUTION

Indicates a potentially hazardous situation which, if not avoided, may result in minor or moderate injury. It may also be used to alert against unsafe practices.



IMPORTANT

Indicates that operating the hardware or software in this manner may damage it or lead to system failure.



NOTE

Draws attention to information essential for understanding the operation and features.

1.1 Safe Use of This Product

For the safety of the operator and to protect the instrument and the system, please be sure to follow this manual's safety instructions when handling this instrument. If these instructions are not heeded, the protection provided by this instrument may be impaired. In this case, Yokogawa cannot guarantee that the instrument can be safely operated. Please pay special attention to the following points:

(a) Installation

- This instrument may only be installed by an engineer or technician who has an expert knowledge of this device. Operators are not allowed to carry out installation unless they meet this condition.
- With high process temperatures, care must be taken not to burn yourself by touching the instrument or its casing.
- Never loosen the process connector nuts when the instrument is installed in a process. This can lead to a sudden, explosive release of process fluids.
- When draining condensate from the pressure detector section, take appropriate precautions to prevent the inhalation of harmful vapors and the contact of toxic process fluids with the skin or eyes.
- When removing the instrument from a hazardous process, avoid contact with the process fluid and the interior of the meter.
- All installation shall comply with local installation requirements and the local electrical code.

(b) Wiring

- The instrument must be installed by an engineer or technician who has an expert knowledge of this instrument. Operators are not permitted to carry out wiring unless they meet this condition.
- Before connecting the power cables, please confirm that there is no current flowing through the cables and that the power supply to the instrument is switched off.

(c) Operation

- Wait 10 min. after the power is turned off before opening the covers.

(d) Maintenance

- Please carry out only the maintenance procedures described in this manual. If you require further assistance, please contact the nearest Yokogawa office.
- Care should be taken to prevent the build up of dust or other materials on the display glass and the name plate. To clean these surfaces, use a soft, dry cloth.

(e) Modification

- Yokogawa will not be liable for malfunctions or damage resulting from any modification made to this instrument by the customer.

1.2 Warranty

- The warranty shall cover the period noted on the quotation presented to the purchaser at the time of purchase. Problems occurring during the warranty period shall basically be repaired free of charge.
- If any problems are experienced with this instrument, the customer should contact the Yokogawa representative from which this instrument was purchased or the nearest Yokogawa office.
- If a problem arises with this instrument, please inform us of the nature of the problem and the circumstances under which it developed, including the model specification and serial number. Any diagrams, data and other information you can include in your communication will also be helpful.
- The party responsible for the cost of fixing the problem shall be determined by Yokogawa following an investigation conducted by Yokogawa.
- The purchaser shall bear the responsibility for repair costs, even during the warranty period, if the malfunction is due to:
 - Improper and/or inadequate maintenance by the purchaser.
 - Malfunction or damage due to a failure to handle, use, or store the instrument in accordance with the design specifications.
 - Use of the product in question in a location not conforming to the standards specified by Yokogawa, or due to improper maintenance of the installation location.
 - Failure or damage due to modification or repair by any party except Yokogawa or an approved representative of Yokogawa.
 - Malfunction or damage from improper relocation of the product in question after delivery.
 - Reason of force majeure such as fires, earthquakes, storms/floods, thunder/lightening, or other natural disasters, or disturbances, riots, warfare, or radioactive contamination.

1.3 Abbreviation and Marking

The following models, HART protocol revisions and configuration files are applied in this manual.

Model	HART Protocol Revision	Configuration file
EJA□□□E	5	• DD (Device Description) • DTM (FDT1.2) • DTM (FDT2.0)
	7	
EJX□□□A*	5	
	7	

*: Not applicable for EJX9□□A

In order to classify multiple models, HART protocol revisions, or configuration files, abbreviated words or marks are used as below in this manual.

■ Applied models

- The following expression is used instead of model name.

[Model: EJA□□□E]
EJA series or EJA

[Model: EJX□□□A (excluding EJX9□□A)]
EJX series or EJX

- EJX** mark indicates specification or function applied for EJX series only.

■ HART protocol revision

- Two HART protocol revisions are expressed for short as below.

HART protocol revision 5: HART 5
HART protocol revision 7: HART 7

- HART 7** mark indicates specification or function applied for HART 7 only.
Refer to section 2.2 for typical functions for HART 7.
- HART 5** mark indicates specification or function applied for HART 5 only.

■ Output signal

This instruction manual covers both 4 to 20 mA DC output (Output signal code J) and 1 to 5 V DC output (Output signal code Q) with HART 7.

- Two analog output signal type may be expressed for short as below.
4 to 20 mA DC output: 4-20mA
1 to 5 V DC output: 1-5V
- 4-20mA** mark indicates the specification or function applied for 4 to 20mA only.

- Unless otherwise stated or shown by a mark, the functions described in the chapter 3 are applicable for both 4 to 20 mA and 1 to 5 V output types. Even though, the description may only show the values for 4 to 20 mA output. For 1 to 5 V output, replace the current mA value with corresponding voltage V value, with using the following table.

Reference table

% range (%)	-5	-2.5	-1.2	0	50	100	103.1	110
Current (mA)	3.2	3.6	3.8	4	12	20	20.5	21.6
Voltage (V)	0.8	0.9	0.95	1	3	5	5.12	5.4

■ Configuration file

Three configuration files are applied in this manual.

- DD stands for Device Description (file).
- This manual covers two revision DTM (Device Type Manager) files based on FDT (Field Device Tool) standard. The difference of revisions is indicated as follows.

[DTM for FDT 1.2]
DTM (FDT1.2) or [1.2]
[DTM for FDT2.0]
DTM (FDT2.0) or [2.0]

The root referring to a parameter is classified to Group I or II according to applied configuration file.

Configuration file	EJA		EJX	
	HART 5	HART 7	HART 5	HART 7
DD			I	
DTM (FDT1.2)		I	II	I
DTM (FDT2.0)			I	

Note: Only DTM (FDT1.2) for EJX with HART 5 is classified to Group II.

As the above, two roots referring to a parameter is shown in this manual.

Procedure to call up xxx parameter

DD and DTM (excluding EJX_HART 5[1.2])	[Root Menu] →...
EJX_HART 5[1.2] DTM	...→...

For parameter menu tree, refer to section 3.1.

1.4 Applicable Configuration Files

● DD

File		Applied device			
File name	DD revision (■)	Model	HART protocol revision	Device type	Device revision
010■	■=2 or later	EJA series	5	EJA-NEXT (0x5C)	1
0a0■	■=1 or later		7	EJA-NEXT(0x375C)	10
0C0■	■=1 or later		7	EJA-NEXT(0x375C)	12
010■	■=1 or later		7	EJA-NEXT-LP(0x375D)	1
030■	■=3 or later	EJX series	5	EJX (0x51)	3
0a0■	■=2 or later		7	EJX (0x3751)	10
0C0■	■=1 or later		7	EJX (0x3751)	12

● DTM

File			Applied device			
File name	DTM revision	FDT revision	Model	HART protocol revision	Device type	Device revision
EJA-NEXT HART DTM	3.3.0.140 or later *2	FDT1.2	EJA series	5	EJA-NEXT (0x5C)	1
EJA-NEXT FDT2.0 HART DTM	5.0.0.0 or later *3	FDT2.0				
EJA-NEXT HART 7 DTM	3.3.0.140 or later *2	FDT1.2		7	EJA-NEXT (0x375C)	10
EJA-NEXT FDT2.0 HART 7 DTM	5.0.0.0 or later *3	FDT2.0				
EJA-NEXT FDT2.0 HART 7 DTM	5.8.2.0 or later *5	FDT2.0				
EJA-NEXT-LP HART 7 DTM	3.5.0.40 or later *4	FDT1.2		7	EJA-NEXT-LP (0x375D)	1
EJA-NEXT-LP FDT2.0 HART 7 DTM	5.0.1.12 or later *4	FDT2.0				
EJXV3.1	1.4.160.8 or later *1	FDT1.2	EJX series	5	EJX (0x51)	3
EJX FDT2.0 HART DTM	5.0.0.0 or later *3	FDT2.0				
EJX HART 7 DTM	3.3.0.140 or later *2	FDT1.2		7	EJX (0x3751)	10
EJX FDT2.0 HART 7 DTM	5.0.0.0 or later *3	FDT2.0				
EJX FDT2.0 HART 7 DTM	5.8.2.0 or later *5	FDT2.0				

*1: The DTM is included in Yokogawa DTM Library HART 2012-2/Device Files R3.03.03 or later.

*2: The DTM is included in Yokogawa Device DTM Library 2.3/Device Files R3.03.03 or later.

*3: The DTM is included in Device DTM Library 4.0 or later.

*4: The DTM is included in Device DTM Library 5.0 or later.

*5: The DTM is included in Device DTM Library 7.9/Device Files R3.09.04 or later.

Refer to section 2.2 to 2.4 for confirmation of each revision number.

2. Connection

2.1 Integral Indicator Display When Powering On

For models with the integral indicator code “D” and “E”, the display shows all segments in the LCD and then changes to the displays shown below sequentially.

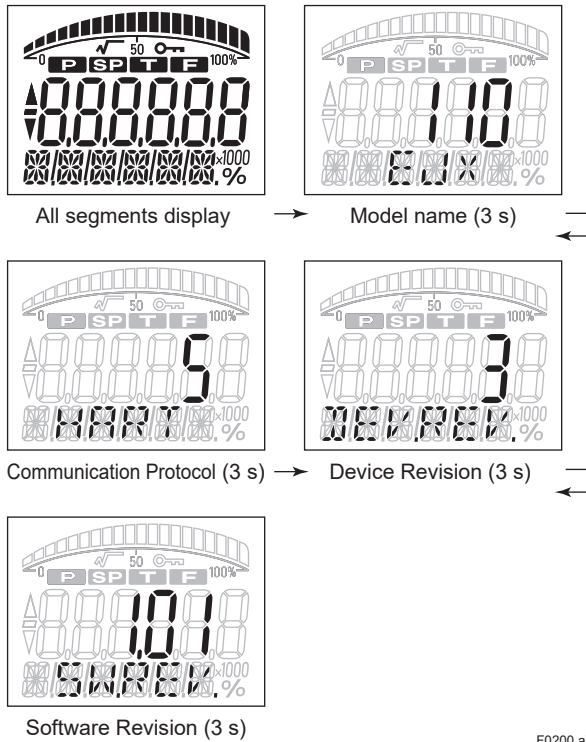

F0200.ai

Either “5” or “7” is displayed on the “Communication Protocol” display as HART protocol revision followed by device revision number on the “Device Revision” display. Software Revision may be displayed after the Device Revision, depending on the product.

NOTE

This function is available for software revision 2.02 or later. Software revision can be checked by the following procedure.

DD and DTM (excluding EJX_HART 5[1.2])	[Root Menu] (Refer to section 3.1) → Review → Software rev
EJX_HART 5[1.2] DTM	Configuration → Device information1 → Software rev

NOTE

In this User’s Manual, HART protocol revision 5 and 7 are described as HART 5 and HART 7 respectively.

NOTE

LCD display can be set to “All segments display” only.

- Procedure to call up the display

DD (HART 5/7) DTM (HART 7 /EJA:HART 5)	[Root Menu] (Refer to section 3.1) → Detailed setup → Display condition → Disp condition → Chg power on info
DTM (EJX:HART 5)	Configuration → Local Display → Chg power on info
ON	Show all segments display, Model name, Communication Protocol, and Device Revision when powering on.
OFF	Show all segments display when powering on.

2.2 HART Protocol Revision

For the models with the output signal code “-J”, HART protocol revision 5 or 7 is selectable. The protocol revision is set as specified in the order.

The typical function which is available by HART protocol revision 7 is listed as follows. Refer to HART 7 description in this document or **HART 7** mark for detail.

- Long Tag Supporting Up to 32 Characters
Long tag secures a better asset management with abundant digits in its software.
- Enhanced Burst Mode and Event Notification **4-20mA**
Advanced burst mode includes the variety of transmission setting by specifying burst variables, update period, and message trigger mode, and event notification function gives you alert signal based on the status change in preset values and self-diagnosis.
- Squawk
Identifying the transmitter by displaying the particular pattern on LCD
- Multidrop Communication **4-20mA**
Up to 63 transmitters can be connected. An analog signal output available for one device in a loop.

How to confirm protocol revision is shown below.

There are three ways to confirm the protocol revision set to the transmitter.

- (a) Confirmation on the name plate
The last numerical number engraved after Serial number and year of production shows HART protocol revision number at the shipment which is shown in Figure 2.1.

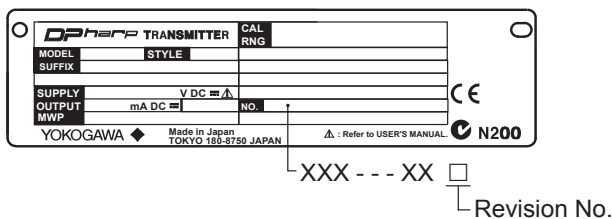

F0201.ai

Output Signal Code	Revision No.	HART Protocol Revision
J	5	HART 5
	7	HART 7
	-	HART 7
E	-	HART 5
Q	-	HART 7

Figure 2.1 Hart Protocol Revision Number on Name Plate

- (b) Confirmation on integral indicator
(A case of integral indicator code D or E is specified)
Refer to section 2.1.
- (c) Confirmation by using HART configuration tool
 - 1) Connect the configuration tool to the transmitter.
 - 2) Confirm numerical number displayed on “Universal rev” column.
 - Procedure to call up the display

DD and DTM (excluding EJX_ HART 5[1.2])	[Root Menu (refer to 3.1)] → Review → Universal rev
EJX_ HART 5[1.2] DTM	Configuration → HART → Universal rev



IMPORTANT

Protocol revision supported by HART configuration tool must be the same or higher than that of the transmitter.

		Protocol revision supported by HART configuration tool	
		5	7
Protocol revision of the transmitter	5	○	○
	7	×	○

- : Communication OK
- × : Communication NG



NOTE

HART 7 communication is supported by FieldMate R2.02 or later.



NOTE

When the output signal code of the transmitter is “-J”, HART protocol revision can be changed. Refer to subsection 3.3.19 about the procedure of the revision change of HART 5 and HART 7.

2.3 Device Description (DD) on a Configuration Tool and Transmitter Device Revision

Before using a HART configuration tool, confirm that the DD for the transmitter is installed in the configuration tool.

About the DD, use the device type, device revision and DD Revision shown in the Table 2.1.

Table 2.1 HART Protocol Revision, Device Revision and DD Revision

HART Protocol Revision (*1)	DPharp Pressure Transmitter			
	Model	Device Type	Device Revision	DD Revision
5	EJX series	EJX (0x51)	3	3 or later
	EJA series	EJA-NEXT (0x5C)	1	2 or later
7	EJX series	EJX (0x3751)	10	2 or later
	EJA series	EJA-NEXT (0x375C)	10	1 or later
	EJX series	EJX (0x3751)	12	1 or later
	EJA series	EJA-NEXT (0x375C)	12	1 or later

*1: When the output signal code is “-E”, only “5” is available.

The device revision of the transmitter and DD can be confirmed as shown below.

If the correct DD is not installed in the configuration tool, download it from the official web site of HART Communication Foundation.

- (1) Confirmation of device revision for the transmitter
 - Confirmation on integral indicator (A case of integral indicator code D or E is specified)
Refer to the section 2.1
 - Confirmation by using HART configuration tool
 - a) Connect the configuration tool to the transmitter.
 - b) Confirm numerical number displayed on “FId dev rev” column.

DD and DTM (excluding EJX_HART 5[1.2])	[Root Menu (refer to 3.1)] → Review → FId dev rev
EJX_HART 5[1.2] DTM	Configuration → HART → FId dev rev

- (2) Confirmation of device revision for the configuration tool
Confirm the device revision from the installed DD file name according to the procedure provided for the configuration tool.
The first two digits indicate the device revision and the next two digits indicate the DD revision.

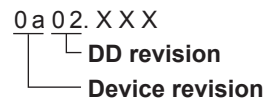

NOTE

Device revision of DD file is given in hexadecimal

2.4 Set the parameters using DTM

When configure the parameters using FieldMate, use the DTM (Device Type Manager) shown in the Table 2.2.



NOTE

The DTM revision can be confirmed by “DTM setup.”

Device Files is a Media included in FieldMate. The user registration site provides Device Files with the latest update programs.

(URL: <https://partner.yokogawa.com/global/fieldmate/>)

In case update, following operation by “DTM setup” is required.

- Update DTM catalog
- Assign corresponding DTM to the device (refer to Table 2.2)

Refer to FieldMate Instruction Manual for detail.

Table 2.2 Applicable DTM

File			Applied device			
File name	DTM revision	FDT revision	Model	HART protocol revision	Device type	Device revision
EJA-NEXT HART DTM	3.3.0.140 or later *2	FDT1.2	EJA series	5	EJA-NEXT (0x5C)	1
EJA-NEXT FDT2.0 HART DTM	5.0.0.0 or later *3	FDT2.0				
EJA-NEXT HART 7 DTM	3.3.0.140 or later *2	FDT1.2		7	EJA-NEXT (0x375C)	10
EJA-NEXT FDT2.0 HART 7 DTM	5.0.0.0 or later *3	FDT2.0				
EJA-NEXT FDT2.0 HART 7 DTM	5.8.2.0 or later *5	FDT2.0				
EJA-NEXT-LP HART 7 DTM	3.5.0.40 or later *4	FDT1.2		7	EJA-NEXT-LP (0x375D)	1
EJA-NEXT-LP FDT2.0 HART 7 DTM	5.0.1.12 or later *4	FDT2.0				
EJXV3.1	1.4.160.8 or later *1	FDT1.2	EJX series	5	EJX (0x51)	3
EJX FDT2.0 HART DTM	5.0.0.0 or later *3	FDT2.0				
EJX HART 7 DTM	3.3.0.140 or later *2	FDT1.2		7	EJX (0x3751)	10
EJX FDT2.0 HART 7 DTM	5.0.0.0 or later *3	FDT2.0				
EJX FDT2.0 HART 7 DTM	5.8.2.0 or later *5	FDT2.0				

*1: The DTM is included in Yokogawa DTM Library HART 2012-2/Device Files R3.03.03 or later.

*2: The DTM is included in Yokogawa Device DTM Library 2.3/Device Files R3.03.03 or later.

*3: The DTM is included in Device DTM Library 4.0 or later.

*4: The DTM is included in Device DTM Library 5.0 or later.

*5: The DTM is included in Device DTM Library 7.9/Device Files R3.09.04 or later.

2.5 Interconnection Between DPharp and the HART Configuration Tool

The HART configuration tool can interface with the transmitter from the control room, the transmitter site, or any other wiring termination point in the loop. To communicate, the tool must be connected to the signal line in parallel with the transmitter; the connections are non-polarized. The HART digital signal is superimposed on the analog signal. Figure 2.2 illustrates the wiring connections for direct interface at the transmitter site for the DPharp. The HART configuration tool can be used for remote access from any terminal strip as well.

■ 4 to 20 mA output

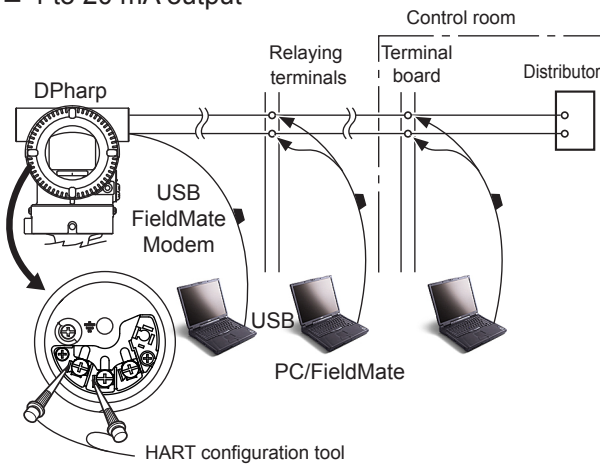

■ 1 to 5 V output (3-wire)

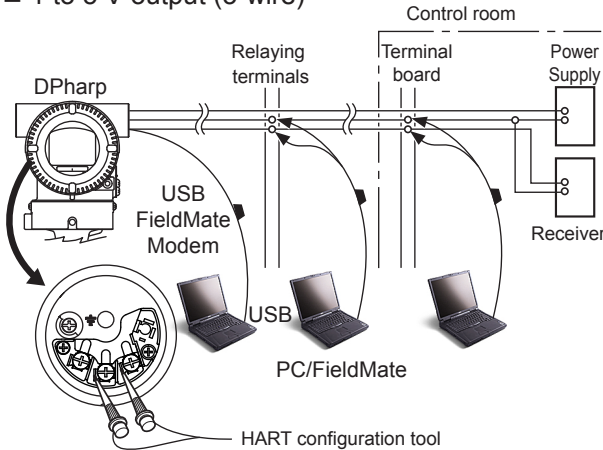

Figure 2.2 Connecting the HART Configuration Tool

2.6 Power Supply Voltage and Load Resistance 4-20mA

When configuring the loop, make sure that the external load resistance is within the range in the figure below.

(Note) With an intrinsically safe transmitter, external load resistance includes safety barrier resistance.

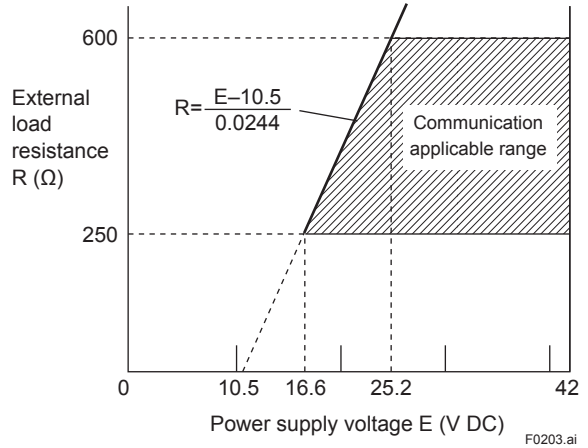

Figure 2.3 Relationship between Power Supply Voltage and External Load Resistance

3. Parameter Setting

3.1 Menu Tree

The menu tree is different in DD and DTM, and device revision respectively. See the menu tree corresponding to the configuration tool. Also, if you are using a device of the previous version or DTM Refer to Appendix 3

Applied model	[HART]	[Dev.Rev.]	DD	DTM	Remarks
EJA series	HART 7	12	I-1	I-2	Default related DTM
				I-3	For 3rd vender DTM Frame
	HART 5	1	A3.1.1	A3.1.1	Refer to previous revision in Appendix 3
EJX series	HART 7	12	I-1	I-2	Default related DTM
				I-3	For 3rd vender DTM Frame
	HART 5	3	A3.1.1	A3.1.2	Refer to previous revision in Appendix 3

I-1 DD

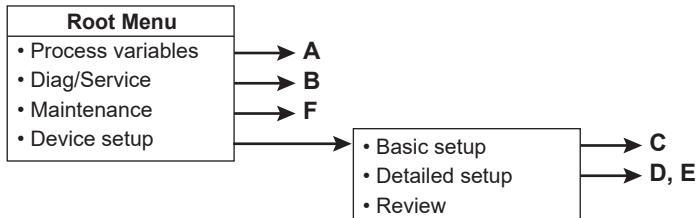

I-2 EJA-NEXT FDT2.0 HART 7 DTM / EJX FDT2.0 HART 7 DTM

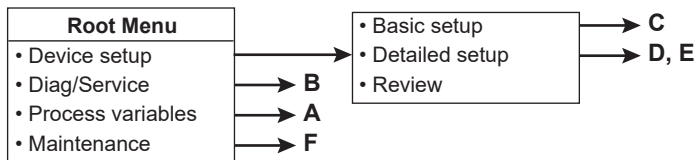

I-3 HART Built-in DTM

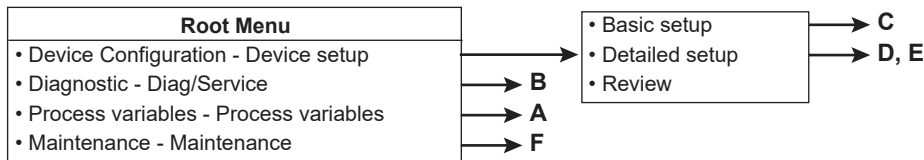

F0301-01.ai

A

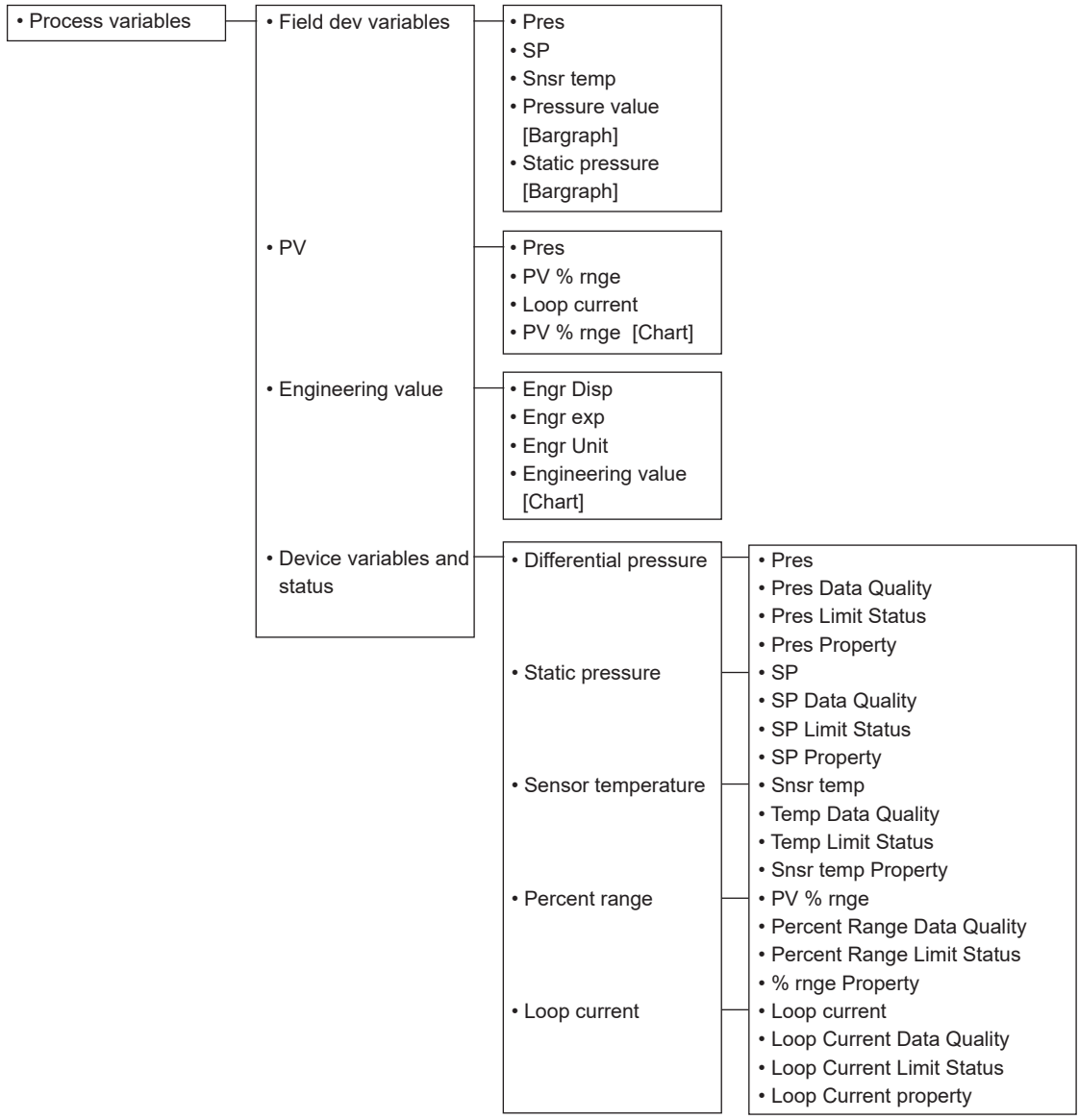

F0301-02.ai

B

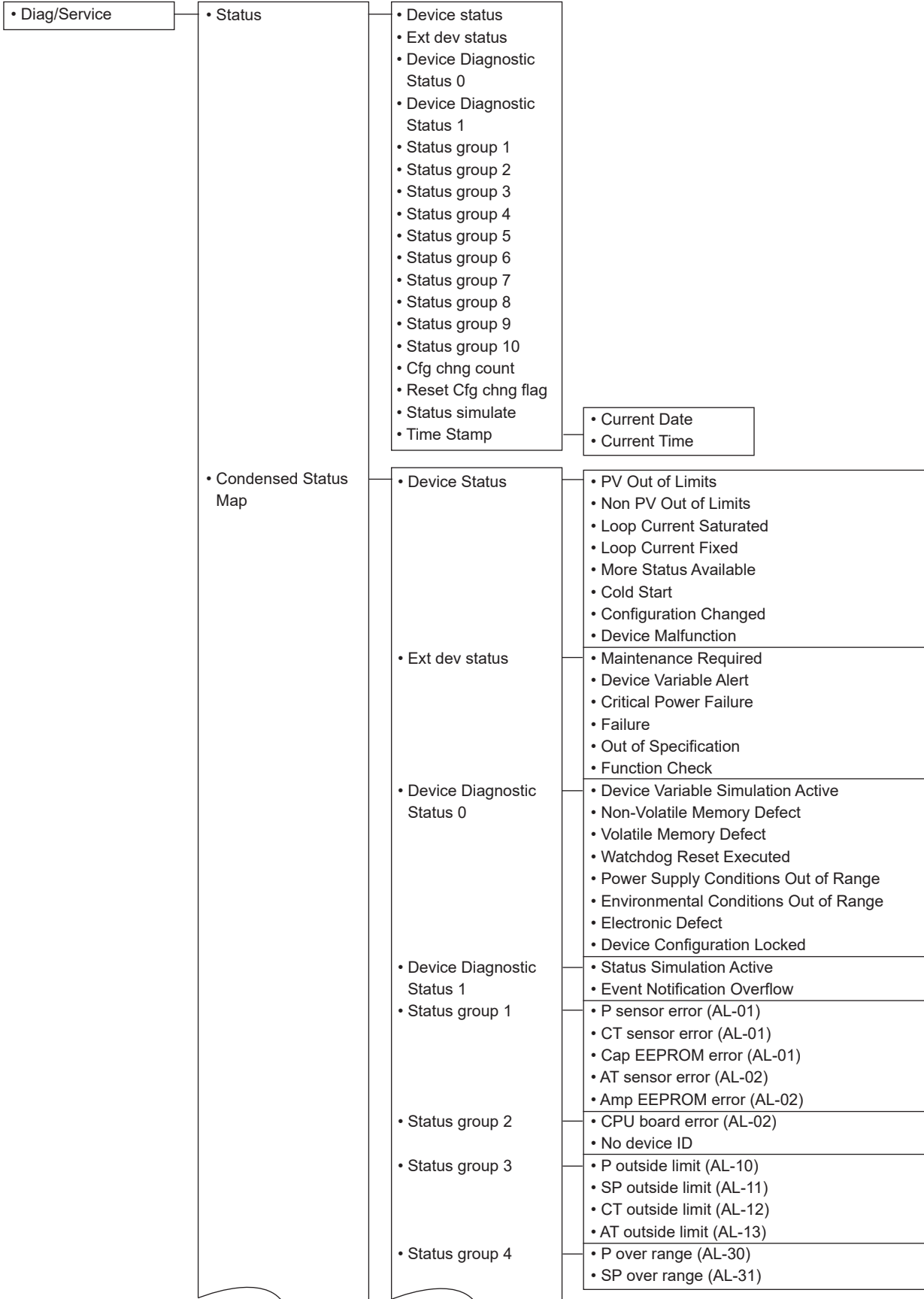

See B1 (next page)

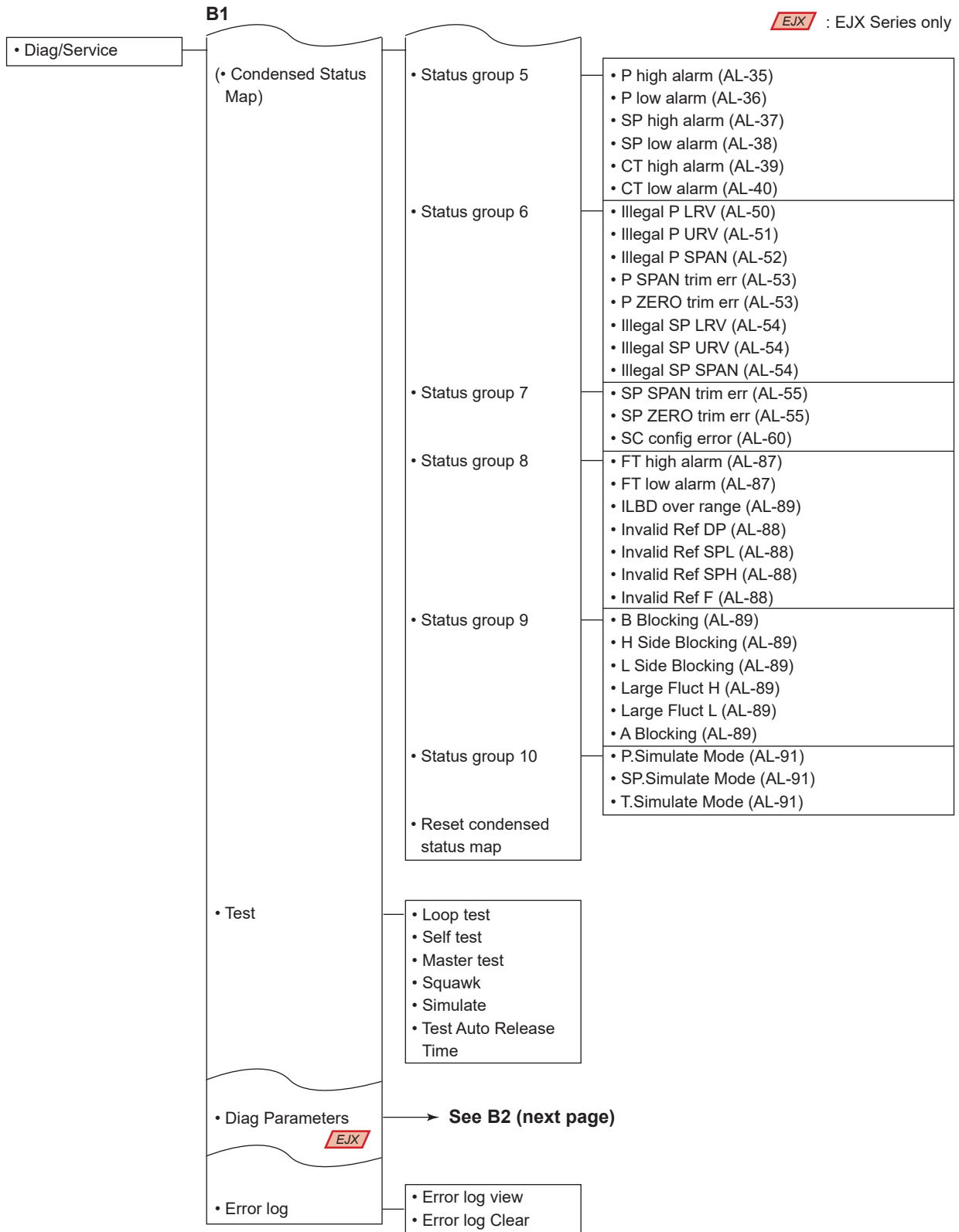

F0301-04.ai

EJX : EJX Series only

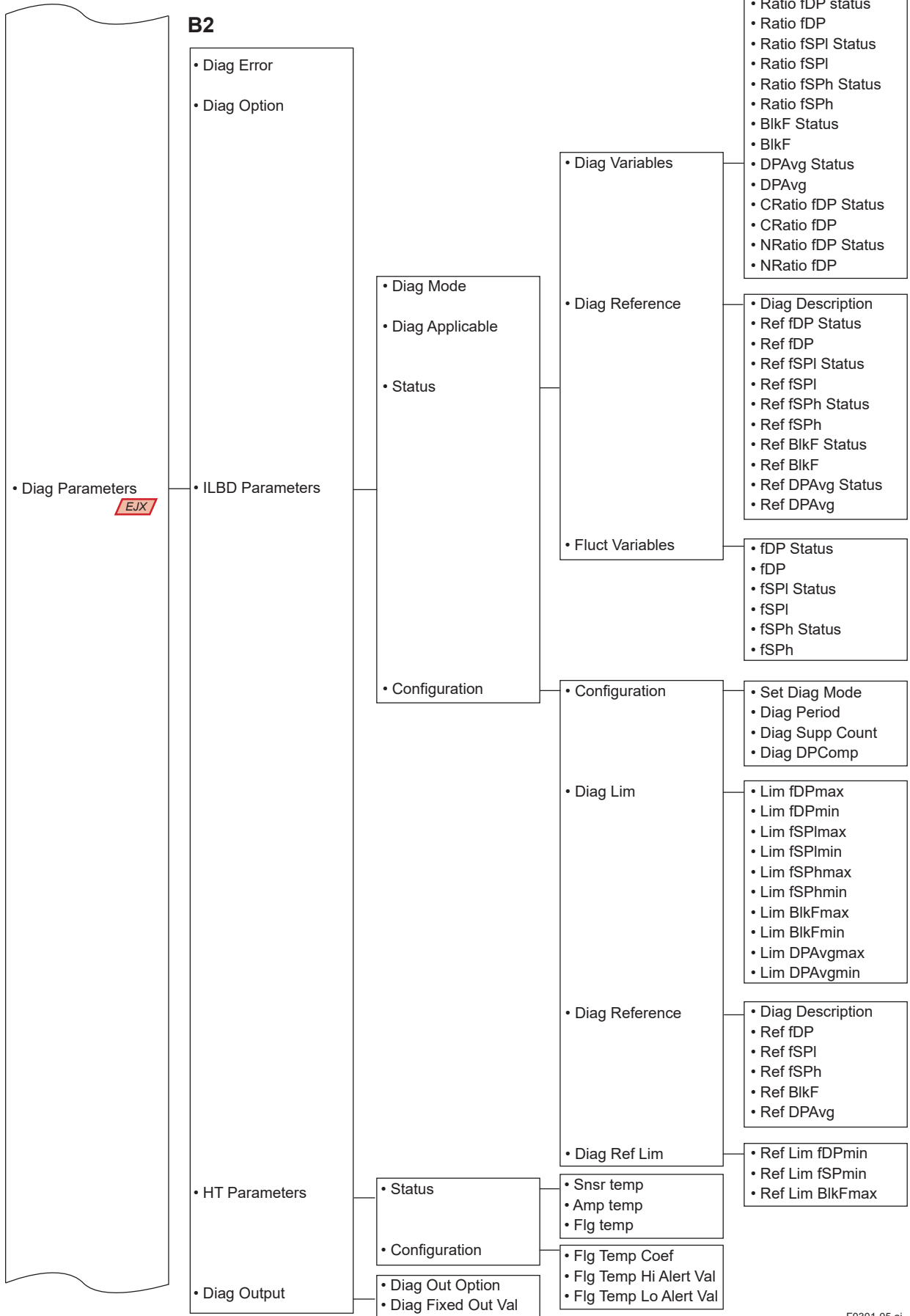

F0301-05.ai

C

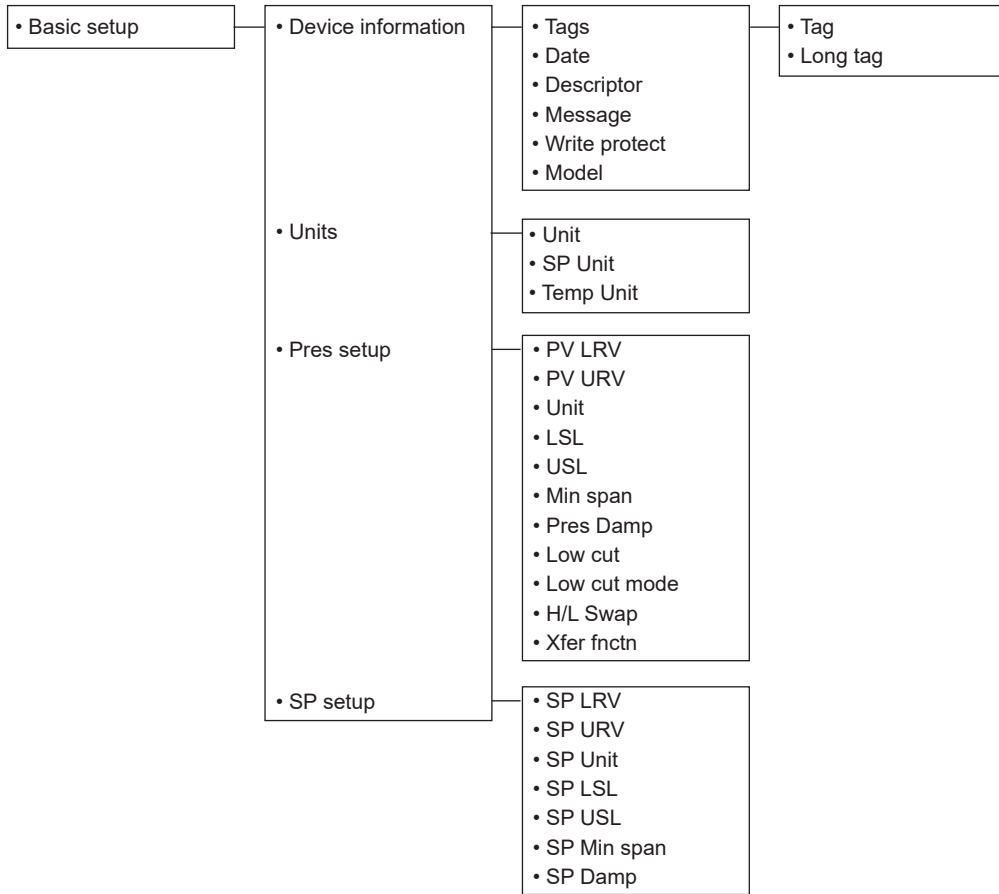

F0301-06.ai

D

EJX : EJX Series only

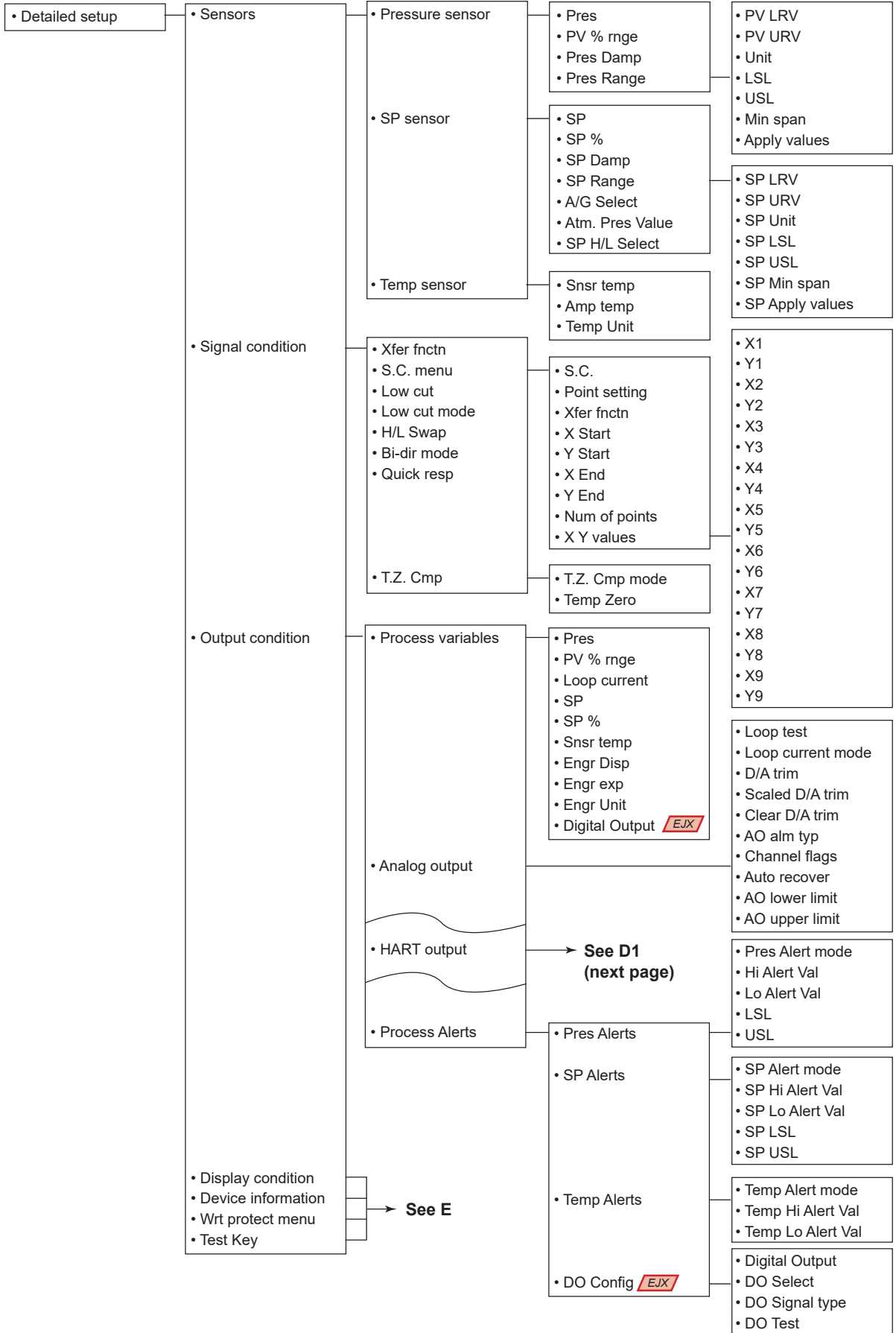

F0301-07.ai

D1

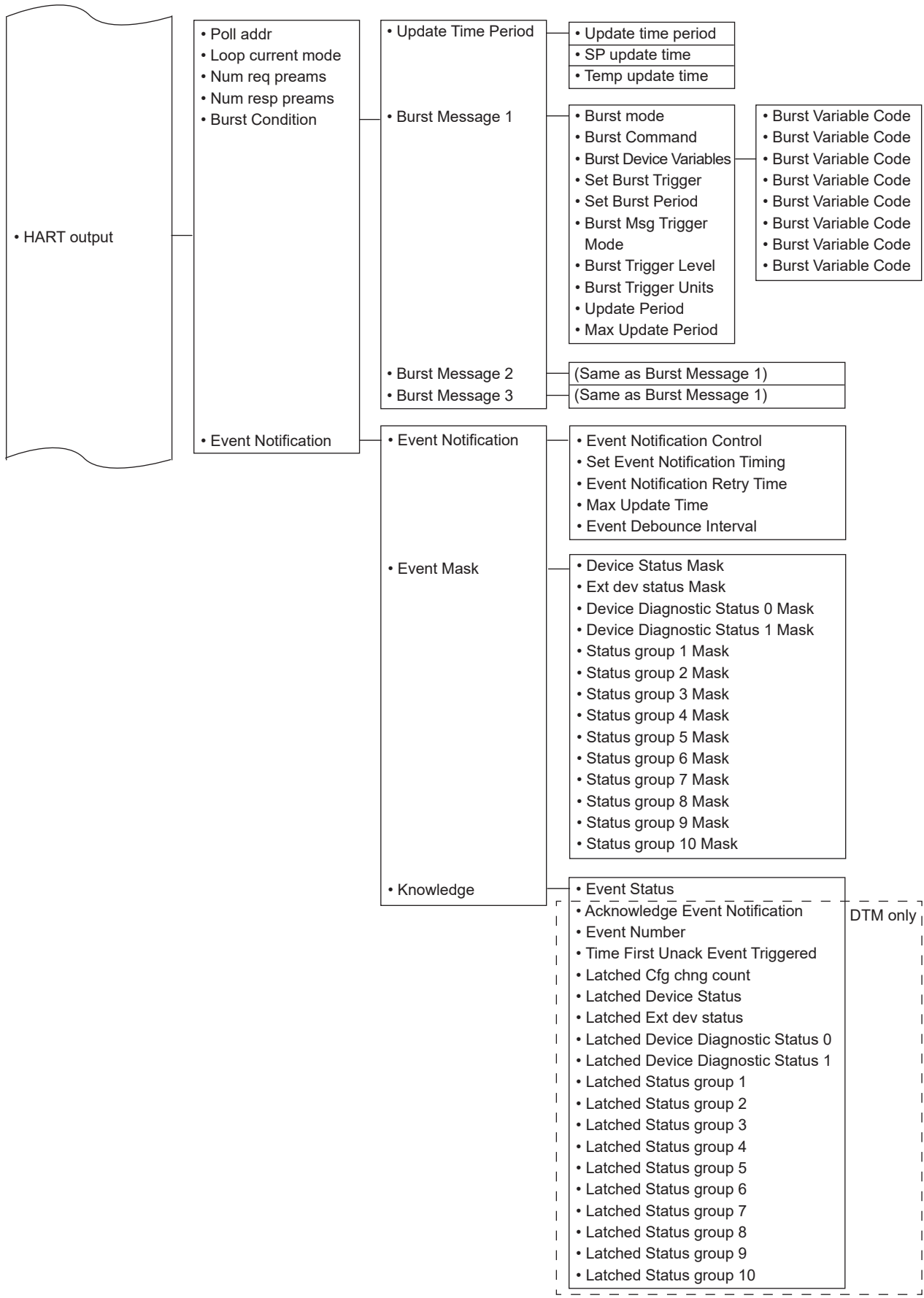

F0301-08.ai

E

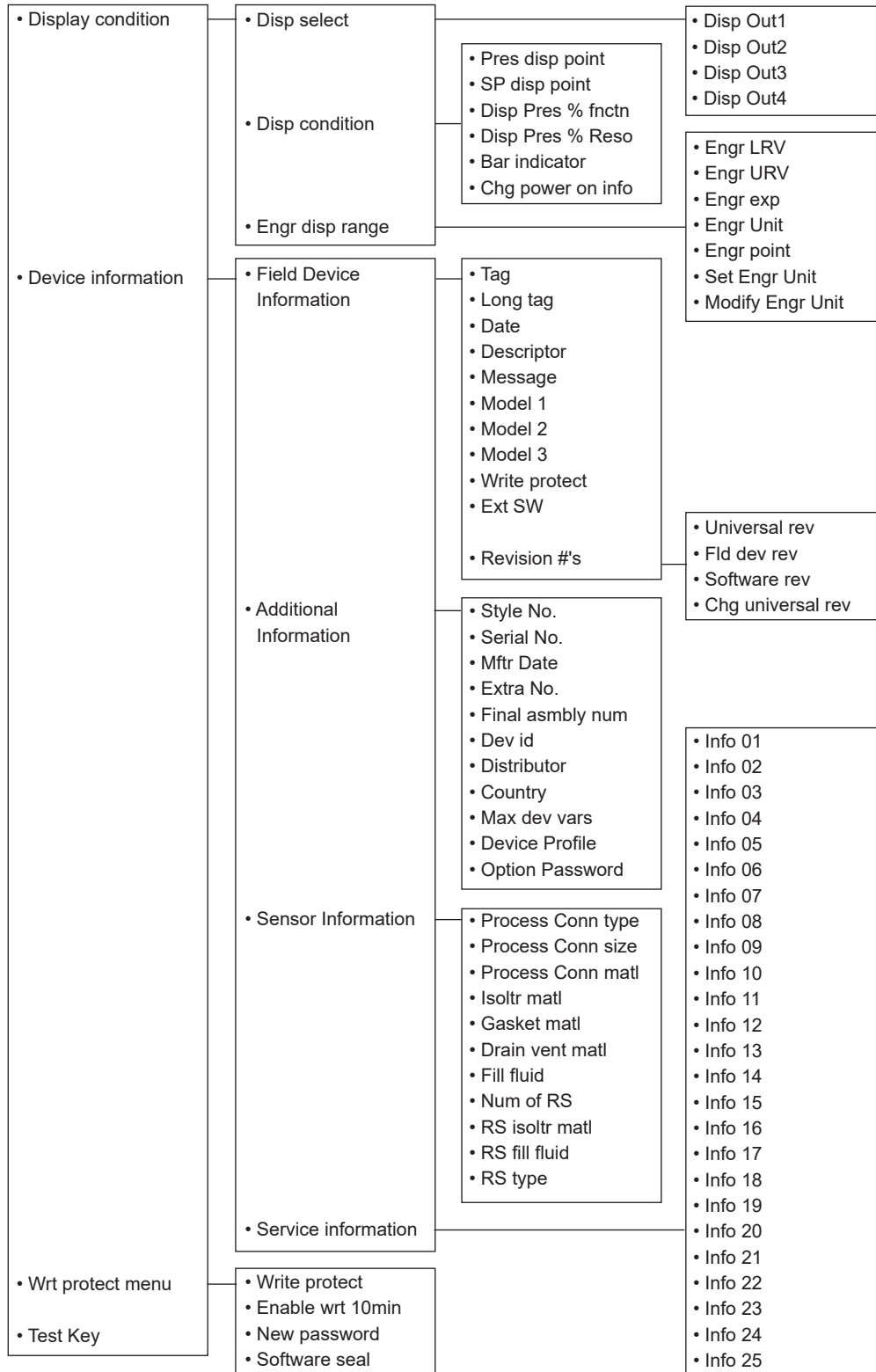

F0301-09.ai

F

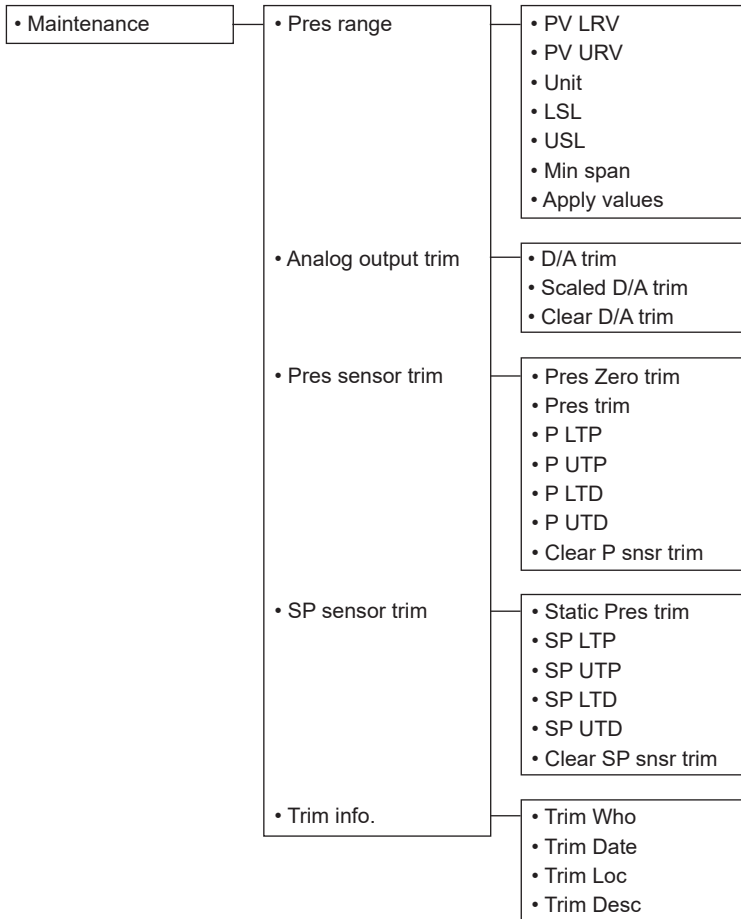

F0301-10.ai

3.2 Basic Setup



IMPORTANT

After setting and sending data with the HART configuration tool, wait 30 seconds before turning off the transmitter. If it is turned off too soon, the settings will not be stored in the transmitter.

3.2.1 Tag and Device Information

If there are specified when ordering, the desired Tag No. and device information are set and shipped. Tag No. and device information can be checked as follows.

- Procedure to call up the display using by DD and DTM (excluding EJX HART 5 DTM based on FDT1.2)

Item	Procedure
Tag	[Root Menu] → Device setup → Basic setup → Device information → Tag → Tag
Long tag (HART 7 only)	[Root Menu] → Device setup → Basic setup → Device information → Tag → Long Tag
Descriptor	[Root Menu] → Device setup → Basic setup → Device information → Descriptor
Message	[Root Menu] → Device setup → Basic setup → Device information → Message
Date	[Root Menu] → Device setup → Basic setup → Device information → Date

- Procedure to call up the display by EJX HART 5 DTM based on FDT1.2

Item	Procedure
Tag	Easy Setup → Tag or Configuration → HART → Tag
Descriptor	Configuration → Device information 1 → Descriptor
Message	Configuration → Device information 1 → Message
Date	Configuration → Device information 1 → Date

When the Tag No. and device information are changed, input them based on the following limitations.

Item	Limitations
Tag	Up to 8 characters or numbers*1
Long tag (HART 7 only)	Up to 32 characters or numbers*2
Descriptor	Up to 16 characters or numbers*1
Message	Up to 32 characters or numbers*1
Date	mm/dd/yyyy - mm: month (2 digits) - dd: days (2 digits) - yyyy: years (4 digits)

*1: The characters bounded by the thick line in the following table can be used.

*2: All characters in the following table can be used.

SP	!	"	#	\$	%	&	'	()	*	+	,	-	.	/
0	1	2	3	4	5	6	7	8	9	:	;	<	=	>	?
@	A	B	C	D	E	F	G	H	I	J	K	L	M	N	O
P	Q	R	S	T	U	V	W	X	Y	Z	[\]	^	_
`	a	b	c	d	e	f	g	h	i	j	k	l	m	n	o
p	q	r	s	t	u	v	w	x	y	z	{		}	~	

*: SP shows one-byte space

3.2.2 Unit

The unit parameter is set at the factory before shipment if specified at the time of order. Follow the procedure below to change the unit parameter.

- Procedure to call up the display

DD and DTM (excluding EJX_HART 5[1.2])	[Root Menu] → Device setup → Basic setup → Units → Unit
EJX_HART 5[1.2] DTM	Easy Setup → Unit or Configuration → Analog Output → Unit

Note that the Yokogawa default setting for the standard temperature is 4°C (39.2°F). For the units of mmH₂O, inH₂O, and ftH₂O, the pressure varies according to the standard temperature definition. Select the appropriate unit with @68degF when a standard temperature of 20°C (68°F) is required. Available pressure units are shown below.

inH ₂ O@68degF	mbar	MPa
inHg	g/cm ²	inH ₂ O
ftH ₂ O@68degF	kg/cm ²	mmH ₂ O
mmH ₂ O@68degF	Pa	ftH ₂ O
mmHg	kPa	hPa
psi	torr	
bar	atm	

3.2.3 Range Change

The range values are factory-set as specified by the customer. To change the range, follow the steps below.

(1) Keypad input — LRV and URV

The measurement span is determined by the upper and lower range values. In this method, the upper and lower range values can be set independently, and the span changes according to the range limit values sent to the transmitter.

- Procedure to call up the display

DD and DTM (excluding EJJ_HART 5[1.2])	[Root Menu] → Device setup → Basic setup → Pres Setup →
EJJ_HART 5[1.2] DTM	Easy Setup → or Configuration → Analog Output →
→ PV LRV	Lower range value
→ PV URV	Upper range value

The measurement range setting is used for correlating the 4-20 mA signal with the pressure value, therefore setting the measurement range in the safety instrumentation system is the setting of safety related parameters, and entering incorrect values may lead to dangerous events. When the pressure is over the range, output signal is saturated only within the normal operation range between the upper range value(URV) and the lower range value(LRV), and the 4 to 20 mA output does not enter the burnout state. Behaviors under “pressure over range” are not intended for behavior in safety instrumented systems. “Pressure over range” of EJJ/EJA is available as an alarm, not related to safety, via communication function or LCD display.



NOTE

The calibration range can be set as LRV > URV under the following conditions, reversing the 4 to 20 mA or 1 to 5 V output signal. When using the integral indicator, change the user set scale values accordingly.

Conditions:

$$LSL \leq LRV \leq USL$$

$$LSL \leq URV \leq USL$$

$$|URV - LRV| \geq \text{Min Span}$$

LSL: Lower sensor limit of range setting

USL: Upper sensor limit of range setting

(2) Apply values — changing the ranges while applying an actual Input

This feature allows the lower and upper range values to be setup automatically with the actual input applied. If the upper and lower range values are set, URV and LRV are changed at the same time.

- Procedure to call up the display

DD and DTM (excluding EJJ_HART 5[1.2])	[Root Menu] → Detailed setup → Sensors → Pressure sensor → Pres range → Apply values
EJJ_HART 5[1.2] DTM	Configuration → Analog Output → Apply values

The measurement span is determined by the upper and lower range values. Changing the lower range value causes the upper range value to change automatically, keeping the span constant. If a change in the lower range value causes the upper range value to exceed the measuring limit of the transmitter, an error message appears and the transmitter holds the output signal right before the error occurred. Enter the correct values within the range of the sensor limits.

Note that changing the upper range value does not cause the lower range value to change. Thus, changing the upper range value also changes the span.

3.2.4 Output Mode

The mode setting for the output signal and the integral indicator can be performed independently.

The output mode for the output signal is set as specified in the order when the instrument is shipped. Follow the procedure below to change the mode.

- Procedure to call up the display

DD and DTM (excluding EJJ_HART 5[1.2])	[Root Menu] → Device setup → Basic setup → Pres Setup →
EJJ_HART 5[1.2] DTM	Easy Setup → or Configuration → Analog Output →
Xfer fnctn	Select “Linear” or “Sq root”

3.2.5 Damping Time Constant Setup

The damping time constant is set as specified in the order when the instrument is shipped. Follow the procedure below to change the damping time constant. The damping time constant for the amplifier assembly can be set here. The damping time constant for the entire transmitter is the sum of the values for the amplifier assembly and the capsule assembly.

Any number from 0.00 to 100.00 can be set for the damping time constant. Note that setting the quick response parameter ON enables you to set the time constant between 0.00 and 0.49 seconds.



NOTE

When using the HART communication in such application that the output varies very quickly, set the damping time constant as 0.5 sec or greater.

- Procedure to call up the **Pres Damp** display

DD and DTM (excluding EJX_HART 5[1.2])	[Root Menu] → Device setup → Basic setup → Pres Setup → Pres Damp
EJX_HART 5[1.2] DTM	Easy Setup → Pres Damp or Configuration → Analog Output → Pres Damp

- Procedure to call up the **Quick resp** display

DD and DTM (excluding EJX_HART 5[1.2])	[Root Menu] → Device setup → Detailed setup → Signal condition → Quick resp
EJX_HART 5[1.2] DTM	Configuration → Analog Output → Quick resp
Off	Set from 0.50 to 100.00
On	Set from 0.00 to 100.00

3.2.6 Output Signal Low Cut Mode Setup

Low cut mode can be used to stabilize the output signal near the zero point.

The low cut point can be set in a range from 0 to 20%, the direct ratio corresponding to the output signal of 4 to 20 mA or 1 to 5 V. (Hysteresis for the cut point: ±10% of the cut point)

Either “Linear” or “Zero” can be selected as the low cut mode. Unless otherwise specified, the cut mode is set to “Linear” at the factory.

The default value of Low cut is set according to the combination of the Output mode (Xfer frctn) and Integral indicator display mode (Disp Pres % frctn). See below table.

Relationship of default value of Low cut and Low cut point

#	Combination of output mode and display mode		Default value of Low cut	Low cut point for the output signal/display
	Output mode	Display mode		
1)	Linear	Linear	10%	10% / 10%
2)	Sq Root	Sq Root	10%	10% / 10%
3)	Linear	Sq Root	1%*	1% / 10%
4)	Sq Root	Linear	10%	10% / NA

*: It is applied for software revision 2.02 or later. For previous software version, it is set in 10%. In the case 3) above, Low cut point for the display is square root of Low cut value. (Example: Low cut value; 2%, Low cut point; 14%)

Note that when the output modes of the output signal and the display are selected as “Sq root” and “Linear” accordingly, the low cut function is not available for the display value.

Example: Low cut at 20%

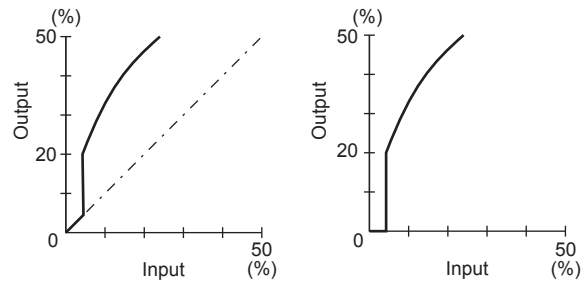

For low cut in linear mode

For low cut in zero mode

F0302.ai

Figure 3.1 Low Cut Mode

- Procedure to call up the display

DD and DTM (excluding EJX_HART 5[1.2])	[Root Menu] → Device setup → Basic setup → Pres Setup →
EJX_HART 5[1.2] DTM	Easy Setup → or Configuration → Analog Output →
Low cut	Set from 0 to 20% of output
Low cut mode	Select "Linear" or "Zero"

The low cut point has hysteresis so that the output around the point is behaved as below figure.

<Example>

Output mode: Linear

Low cut mode: Zero

Low cut: 20.00%

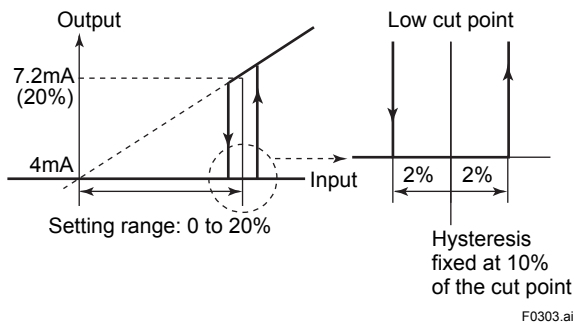

3.2.7 Impulse Line Connection Orientation Setup

This function reverses the impulse line orientation.

Follow the procedure below to assign the high pressure impulse line connection to the L side of the transmitter.

- Procedure to call up the display

DD and DTM (excluding EJX_HART 5[1.2])	[Root Menu] → Device setup → Basic setup → Pres Setup →
EJX_HART 5[1.2] DTM	Configuration → Pressure Sensor →
H/L Swap	Select "Normal" or "Reverse"

3.2.8 Static Pressure Setup

The differential pressure transmitter can display the static pressure also.

(1) Setting of the unit for static pressure

Follow the procedure below to change the static pressure unit.

- Procedure to call up the display

DD and DTM (excluding EJX_HART 5[1.2])	[Root Menu] → Device setup → Basic setup → Units →
EJX_HART 5[1.2] DTM	Configuration → Process Input (or Static Pressure Sensor) →
SP Unit	Select the unit for static pressure (Refer to subsection 3.2.2 Unit)

(2) Setting of the measuring range for static pressure

Follow the procedure below to change the lower range value (LRV) and upper range value (URV).

- Procedure to call up the display

DD and DTM (excluding EJX_HART 5[1.2])	[Root Menu] → Device setup → Basic setup → SP setup
EJX_HART 5[1.2] DTM	Configuration → Static Pressure Sensor →
SP LRV	Set the lower range value (0 %) of static pressure
SP URV	Set the upper range value (100 %) of static pressure

- SP Apply values

This feature allows the lower and upper SP range values to be setup automatically with the actual input applied. If the upper and lower range values are set, URV and LRV are changed at the same time.

[Root Menu] → Device setup → Detailed setup → Sensors → SP sensor → SP Range →	
EJX V3.1 (HART 5 DTM) Configuration → Static Pressure Sensor →	
SP Apply values	Automatically set up lower and upper SP range with the actual input applied.

3.3 Detailed Setup

3.3.1 Static Pressure sensor

(1) Selection of Gauge pressure and Absolute pressure

Either the gauge pressure or absolute pressure can be selected to display on the LCD display. Absolute pressure is selected when the transmitter is shipped.

- Procedure to call up the display

DD and DTM	[Root Menu] → Device setup → Detailed setup → Sensors → SP sensor → SP Range
A/G Select	Select "Gauge" or "Absolute"
Atm. Pres Value	0.1013 MPa when the transmitter is shipped

(2) Selection of pressure side

Either the high or low pressure side of capsule can be selected to monitor the static pressure. High pressure side is selected when the transmitter is shipped.

- Procedure to call up the display

DD and DTM	[Root Menu] → Device setup → Detailed setup → Sensors → SP sensor → SP Range
SP H/L Select	Select "High" or "Low"

3.3.2 Bi-directional Flow Measurement

(a) **Bi-dir mode** enables selection of 50% output at an input of 0 mmH₂O.

- Procedure to call up the display

DD and DTM (excluding EJJ_HART 5[1.2])	[Root Menu] → Device setup → Detailed setup → Signal condition →
EJJ_HART 5[1.2] DTM	Configuration → Analog output → DTM
Bi-dir mode	Select "On" or "Off"

(b) Combining **Bi-dir mode** with **Xfer fnctn** provides a square root output computed independently for 0% to 50% output and for 50% to 100% output.

- Output mode "LINEAR"

20 mA (100% display)

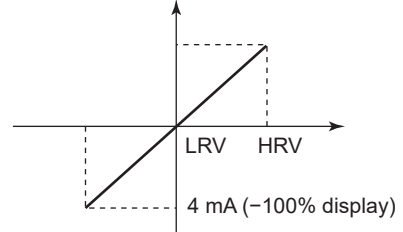

- Output mode "SQUARE ROOT"

20 mA (100% display)

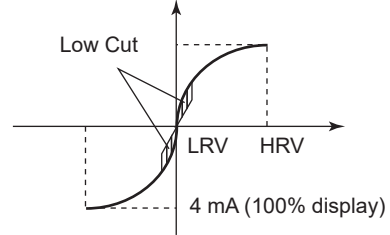

F0304.ai

3.3.3 Analog Output Signal Adjustable Range

Output signal adjustable range at normal operating condition are set as shown below at the factory when the instrument is shipped, and output signal are limited by these value.

	Lower limit	Upper limit
Standard Option code /C1	3.6 mA (0.9 V)	21.6 mA (5.4 V)
Option code /C2 and /C3	3.8 mA (0.95 V)	20.5 mA (5.12 V)

() shows the value for 1 to 5 V output.

Output signal range can be changed between 3.6 mA and 21.6 mA (0.9 V and 5.4 V for 1 to 5 V output) to match it to the equipment on the receiving side.

Lower value is set at **AO lower limit** and upper value is set at **AO upper limit** respectively. Follow the procedure below to change the upper and lower values.

- Procedure to call up the display

DD and DTM (excluding EJJ_ HART 5[1.2])	[Root Menu] → Device setup → Detailed setup → Output condition → Analog output →
EJJ_HART 5[1.2] DTM	Configuration → Analog output →
AO lower limit	Set the lower value (mA)
AO upper limit	Set the upper value (mA)

Set the values as below.

Lower value < Upper value

3.3.4 Integral Indicator Display Mode

The mode setting for the output signal and the integral indicator can be performed independently.

The output mode for the integral indicator is set as specified in the order when the instrument is shipped. Follow the procedure below to change the mode.



- Procedure to call up the display

DD and DTM (excluding EJJ_ HART 5[1.2])	[Root Menu] → Device setup → Detailed setup → Display condition → Disp condition →
EJJ_HART 5[1.2] DTM	Configuration → Local Display →
Disp Pres % fnctn	Select "Linear" or "Sq root"

If the instrument is equipped with an integral indicator and the transfer function is sq root, "√" is displayed on the integral indicator.

3.3.5 Integral Indicator Scale Setup

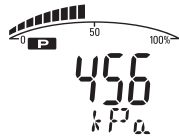
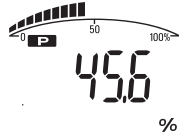
The following five displays are available for integral indicators: input pressure, % of range, user set scale, input static pressure*1, and % of static pressure range*1. A cycle of up to four displays can be shown by assigning variables to the parameters at **Disp select**.

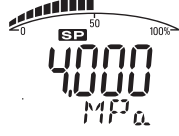
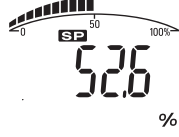
Available displays	Description and related parameters
Input pressure (PRES) 	Indicates values of input pressure with the indication limits -99999 to 99999. PRES 45.6 kPa
% of range (PRES %) 	Indicates input pressure in -2.5 to 110% range depending on the set range (LRV and URV). PRES % 45.6 %
User set scale (ENGR. PRES) 	Indicates values depending on the engineering range (Engr LRV and Engr URV) with the unit (Engr Unit). Engr LRV 0.0 Engr URV 45.0 Engr exp ×100 Engr Unit m3/min Engr point 1
Input static pressure (SP)*1 	Indicates input static pressure with the indication limits -99999 to 99999. Reference pressure is factory-set in absolute. SP 4.000 MPa
% of static pressure range (SP %)*1 	Indicates input static pressure in -10 to 110% range depending on the set range (SP LRV and SP URV). SP % 52.6 %

F0305.ai

*1: Available for differential pressure transmitter.

See (a.) through (d.) shown below for the setting procedures.

a. Display Selection

At **Disp select**, select the variable that the parameter Disp Out 1 will display on the integral indicator.

- Procedure to call up the display

DD and DTM (excluding EJJ_HART 5[1.2])	[Root Menu] → Device setup → Detailed setup → Display condition → Disp select →
EJJ_HART 5[1.2] DTM	Configuration → Local Display →
Disp Out 1 to 4	Select desired display from five kinds of display shown above.

Set Disp Out 2, Disp Out 3 and Disp Out 4 in the same way if necessary.

In addition to the above item, “Not used” is also displayed as a selection item.

b. Cyclic Display

Up to four displays can be displayed cyclically in the order of the parameter number.

c. Display Resolution

User can change the position of decimal point which is shown on the integral indicator.

- Procedure to call up the display for PV %

DD and DTM (excluding EJJ_HART 5[1.2])	[Root Menu] → Device setup → Detailed setup → Display condition → P disp condition →
EJJ_HART 5[1.2] DTM	Configuration → Local Display →
Disp Pres % Reso	Select the decimal point position of pressure Normal: Display one digit below the decimal point High Resolution: Display two digits below the decimal point

- Procedure to call up the display for Pres and SP

DD and DTM (excluding EJJ_HART 5[1.2])	[Root Menu] → Device setup → Detailed setup → Display condition →
EJJ_HART 5[1.2] DTM	Configuration → Local Display →
(→ P disp condition) → Disp condition → Pres disp point	Select the decimal point position of differential pressure (0, 1, 2, 3 or 4)
(→ SP disp condition) → Disp condition → SP disp point	Select the decimal point position of static pressure (0, 1, 2, 3 or 4)

d. User Setting of Engineering Unit and Scale

• **Setting by DD and DTM**

Engr disp range parameters allow the engineering unit and scale to be displayed. At **Set Engr Unit**, the following engineering units can be selected from a list.

- Procedure to call up the display

DD and DTM (excluding EJJ_HART 5[1.2])	[Root Menu] → Device setup → Detailed setup → Display condition → Engr disp range
→ Set Engr Unit	Select the engineering unit
→ Engr LRV	Lower range value
→ Engr URV	Upper range value
→ Engr exp	Exponents for user scale display
→ Engr point	Decimal point position for user scale display (0, 1, 2, 3 or 4)

Select the engineering unit from the list. Available units are shown below

kPa	ftH ₂ O	NI/min
MPa	gf/cm ²	Nm ³ /h
mbar	kgf/cm ²	Nm ³ /min
bar	kg/cm ² G	ACFH
psi	kg/cm ² A	ACFM
psia	atm	SCFH
mmH ₂ O	kg/h	SCFM
mmHg	t/h	GPH
mmHgA	m ³ /h	GPM
mmAq	m ³ /min	m
mmWG	l/h	mm
Torr	l/min	in
inH ₂ O	kl/h	ft
inHg	kl/min	kg/m ³
inHgA	NI/h	g/cm ³

At **Modify Engr Unit** parameter, user can set your own unit also.

Up to eight alphanumeric characters, spaces or one slash (/) can be input at **Modify Engr Unit**; only the first six are displayed on the integral indicator.

- Procedure to call up the display

DD and DTM (excluding EJJ_HART 5[1.2])	[Root Menu] → Device setup → Detailed setup → Display condition → Engr disp range →
→ Modify Engr Unit	Set your own unit

Note that following symbols are not available:

% & < > . * : + - , ' ()

The integral indicator shows “-----” when these symbols or more than two slashes are entered.

● **Setting by EJX HART 5 DTM based on FDT1.2**

User can input the desired unit at **Engr Unit**.

- Procedure to call up the display

EJX HART 5 DTM based on FDT1.2	Configuration → Local Display →
→ Engr Unit	Set the engineering unit
→ Engr LRV	Lower range value
→ Engr URV	Upper range value
→ Engr exp	Exponents for user scale display
→ Engr point	Decimal point position for user scale display

Available characters and symbols for **Engr Unit** are the same as for **Modify Engr Unit** shown above.

3.3.6 Unit for Displayed Temperature

When the instrument is shipped, the temperature units are set to “deg C” (Centigrade). Follow the procedure below to change this setting.

When this parameter is set, it also changes the temperature unit for **Snsr temp at Process variables** and **Amp temp at Temp sensor**.

- Procedure to call up the display

DD and DTM (excluding EJX_HART 5[1.2])	[Root Menu] → Device setup → Detailed setup → Sensors → Temp sensor →
EJX_HART 5[1.2] DTM	Configuration → Process Input →
Temp Unit	Select the temperature unit (deg C, deg F, Kelvin(K))

3.3.7 Sensor Trim

The transmitter is factory characterized. Factory characterization is the process of comparing a known pressure input with the output of each transmitter sensor module over the entire pressure and temperature operating range. During the characterization process, this comparison information is stored in the transmitter EEPROM. In operation, the transmitter uses this factory-stored curve to produce a process variable output (PV), in engineering units, dependent on the pressure input.

The sensor trim procedure allows you to adjust for local conditions, changing how the transmitter calculates process variables. There are two ways to trim the sensor: a zero trim and a full sensor trim. A zero trim is a one-point adjustment typically used to compensate for mounting position effects or zero shifts caused by static pressure. A full sensor trim is a two-point process, in which two accurate end-point pressures are applied (equal to or greater than the range values), and all output is linearized between them.

(1) **Zero Trim**

a. **Zeroing—Pres Zero trim**

Pres Zero trim carries out the zero adjustment and automatically sets the applied “0” input values to the output value of “0”, keeping the span constant. Use this setting when the LRV is known to be 0 mmH₂O.

- Procedure to call up the display

DD and DTM (excluding EJX_HART 5[1.2])	[Root Menu] → Maintenance Diag/Service → Calibration → Pres Sensor trim →
EJX_HART 5[1.2] DTM	Calibration →
Pres Zero trim	Adjust the lower point

b. **Level Adjustment—Auto, lower Pt**

This zero adjustment calibrates the transmitter output corresponding to the actual tank level. To perform this adjustment, first use a glass gauge or the like to determine the actual tank level, then enter the correct data as shown below.

- Procedure to call up the display

DD and DTM (excluding EJX_HART 5[1.2])	[Root Menu] → Maintenance → Pres Sensor trim → Pres trim →
EJX_HART 5[1.2] DTM	Calibration → Pres trim →
Auto, Lower Pt	Auto trim for 0% point

DPharp span: 0 to 25.00 kPa
 Actual level: 13.50 kPa
 Transmitter output: 13.83 kPa

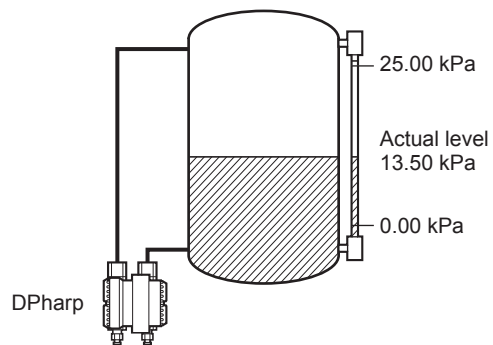

c. **Using External Zero-adjustment Screw**

This method permits zero adjustment without the HART configuration tool. Use a slotted screwdriver to turn the zero-adjustment screw. See the hardware manual for details.

Note that the parameter of **Ext SW** must be “Enabled” to perform this adjustment. See subsection 3.3.9 for the setting procedure.

(2) Full Sensor Trim—Auto Trim and Manual Trim

Full sensor trim is carried out by performing **Auto, Lower Pt** followed by **Auto, Upper Pt**.

Also, you can manually perform the trimming procedure with **Manual, Lower Pt** and **Manual, Upper Pt**.

The full sensor trim is a two-point adjustment, and the lower point adjustment should always be performed before the upper point adjustment in order to maintain the pitch between the zero and 100% points within the calibration range.

In the manual method, the reference pressure should also be applied to the transmitter at both the lower and upper points. Without the reference pressure, **Manual, Lower Pt** and **Manual, Upper Pt** may not represent the correct value for each adjustment point.

a. Auto Sensor Trim

Applying reference pressure of 0% and 100% of the measurement range to the transmitter, adjust the lower and upper points automatically.

- Procedure to call up the display

DD and DTM (excluding EJJ_HART 5[1.2])	[Root Menu] → Maintenance → Pres sensor trim → Pres trim →
EJJ_HART 5[1.2] DTM	Calibration → Pres trim →
Auto, Lower Pt	Auto trim for 0% point
Auto, Upper Pt	Auto trim for 100% point

b. Manual Sensor Trim

Using the example below, follow the steps to perform the full sensor trim by manually. The Pres LTD (Manual, Lower Pt) and Pres UTD (Manual, Upper Pt) represent the previously adjusted values.

Example: For the range of 1000 to 3000 mmH₂O
Pres LTD (Manual, Lower Pt) = -4.0 mmH₂O
Pres UTD (Manual, Upper Pt) = -3.0 mmH₂O

<1> Call up the **Manual, Lower Pt**.

- Procedure to call up the display

DD and DTM (excluding EJJ_HART 5[1.2])	[Root Menu] → Maintenance → Pres sensor trim → Pres trim →
EJJ_HART 5[1.2] DTM	Calibration → Pres trim →
→ Manual, Lower Pt	Manual trim for 0% point
→ Manual, Upper Pt	Manual trim for 100% point

<2> Suppose that a standard pressure of 1000 mmH₂O is applied and the value of the “Pres for trim” is 994.0. Correct for this output error of 6 mmH₂O by adding 6 mmH₂O to **Pres LTD (Manual, Lower Pt)**.

$$-4.0+6.0=+2.0$$

<3> Enter the correction value of “2” to the **Pres LTD (Manual, Lower Pt)**.

<4> Call up the **Pres UTD (Manual, Upper Pt)**.

<5> Suppose that a standard pressure of 3000 mmH₂O is applied and the value of the Pres for trim is 3015.0. Firstly, obtain the slope error for the span as follows;

$$\begin{aligned} \text{Slope Error} &= \frac{\text{Applied Pressure Value}-\text{Value of Pres for Trim}}{\text{Applied Pressure Value}} \times (\text{URV}-\text{LRV}) \\ &= \frac{3000-3015}{3000} \times (3000-1000) = -10 \end{aligned}$$

Then correct for this slope error of -10 by adding -10 to **Pres UTD (Manual, Upper Pt)**.

$$-3.0+(-10.0)=-13.0$$

<6> Enter the correction value of “-13” to the **Pres UTD (Manual, Upper Pt)**.

(3) Sensor Trim for Static Pressure

For the transmitter, full sensor trim of the static pressure is performed in the same way as with the differential pressure.

- Procedure to call up the display

DD and DTM (excluding EJJ_HART 5[1.2])	[Root Menu] → Maintenance → SP sensor trim → Static Pres trim →
EJJ_HART 5[1.2] DTM	Calibration → Static Pres trim →
Auto, Lower Pt	Auto trim for 0% point
Auto, Upper Pt	Auto trim for 100% point
Manual, Lower Pt	Manual trim for 0% point
Manual, Upper Pt	Manual trim for 100% point

(4) Reset Trim Adjustment to Factory Setting

The **Clear P snsr trim** and **Clear SP snsr trim** commands can reset the trim adjustment to the initial calibrated values that were set. The amount of the adjustment performed with the external zero-adjustment screw is returned to the initial setting as well.

- Procedure to call up the display for pressure

DD and DTM (excluding EJJ_ HART 5[1.2])	[Root Menu] → Maintenance → Pres sensor trim → Pres trim info. → Clear P snsr trim → Execute
EJJ_HART 5[1.2] DTM	Calibration → Clear P snsr trim → Execute

- Procedure to call up the display for static pressure

DD and DTM (excluding EJJ_ HART 5[1.2])	[Root Menu] → Maintenance → SP sensor trim → SP trim info. → Clear SP snsr trim → Execute
EJJ_HART 5[1.2] DTM	Calibration → Clear SP snsr trim → Execute

3.3.8 Trim Analog Output

Fine current output adjustment is carried out with **D/A trim** or **Scaled D/A trim**.

(1) D/A Trim

D/A trim is to be carried out if the calibration digital ammeter does not exactly read 4.000 mA and 20.000 mA with an output signal of 0% and 100%.

- Procedure to call up the **D/A trim** display

DD and DTM (excluding EJJ_ HART 5[1.2])	[Root Menu] → Maintenance → Analog output trim → D/A trim
EJJ_HART 5[1.2] DTM	Calibration → D/A trim

(2) Scaled D/A Trim

Scaled D/A trim is to be carried out if the output is adjusted using a voltmeter or a meter whose scale is 0 to 100%.

- Procedure to call up the **Scaled D/A trim** display

DD and DTM (excluding EJJ_ HART 5[1.2])	[Root Menu] → Maintenance → Analog output trim → Scaled D/A trim
EJJ_HART 5[1.2] DTM	Calibration → Scaled D/A trim

<Example>

Adjustment 4 to 20 mA output using a volt meter.
(4mA → 1V, 20mA → 5V)

- 1) Select "Change".
- 2) Enter the value read on the voltmeter when the output signal is 4mA.

In this case, enter the value of the voltage across a 250Ω resistor (1V).
- 3) Enter the value read on the meter when the output signal is 20mA (5V).
- 4) Select "Proceed".
- 5) Connect the voltmeter.
- 6) Output the 0% output signal and read the output value.
- 7) Enter the reading of the voltmeter to the configuration tool. (The output of the transmitter changes).
- 8) Confirm the voltmeter reading is 1.000.
- 9) If the reading on the voltmeter is 1.000, select "Yes".

If the reading is not 1.000, select "No" and repeat steps 6 and 7 until the voltmeter reads 1.000V.
- 10) Output the 100% output signal and read the output value.
- 11) Enter the reading of the voltmeter.
- 12) Confirm the voltmeter reading is 5.000.
- 13) If the reading of the voltmeter is 5.000, select "Yes".

If the reading on the voltmeter is not 5.000, select "No" and repeat steps 10 and 11 until the voltmeter reads 5.000V.

3.3.9 External Switch Mode

Follow the procedure below to enable or inhibit zero point adjustment by means of the zero-adjustment screw on the transmitter.

This is set to "Enabled" when the instrument is shipped.

To change the mode, follow the procedure below.

- Procedure to call up the display

DD and DTM (excluding EJJ_ HART 5[1.2])	[Root Menu] → Device setup → Detailed setup → Device information → Field device info → Ext SW
EJJ_HART 5[1.2] DTM	Configuration → Device information1 → Ext SW
Enabled	Enable the external zero point adjustment
Disabled	Disable the external zero point adjustment

3.3.10 CPU Failure Burnout Direction and Hardware Write Protect

There are two slide switches on the CPU assembly board. One sets the burnout direction at CPU failure, and the other sets a write protection function which disables parameter changes through the use of a handheld terminal or some other communication method.

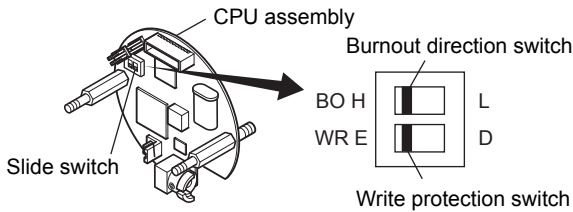

Burnout direction switch (BO)		
Burnout Direction Switch Position	H L E D	H L E D
Burnout Direction	HIGH	LOW

Hardware write protection switch (WR)		
Write Protection Switch Position	H L E D	H L E D
Write Protection	NO (Write enabled)	YES (Write disabled)

F0307.ai

The parameter of **AO alm typ** parameter displays the status of analog output if a CPU failure occurs. In case of a failure, communication is disabled.

Standard specifications or with option code /C3

The burnout direction switch is set to "HIGH". If a failure occurs, the transmitter outputs a 110% or higher signal.

With option code /C1 or /C2

The burnout direction switch is set to "LOW". If a failure occurs, a -5% or lower output is generated.

To confirm the burnout direction at the CPU failure, follow the procedure below.

- Procedure to call up the display

DD and DTM (excluding EJX_HART 5[1.2])	[Root Menu] → Device setup → Detailed setup → Output condition → Analog output → AO alm typ
EJX_HART 5[1.2] DTM	Configuration → Analog output → AO alm typ
High	Burnout direction is set to High
Low	Burnout direction is set to Low

3.3.11 Software Write Protection

The transmitter configured data is saved by using a write protection function. The write protection status is set to "Yes" when 8 alphanumeric characters are entered in the **New password** field and transferred to the transmitter.

When write protection is set to "Yes," the transmitter does not accept parameter changes. When the same eight alphanumeric string entered in the **New password** field is also entered in the **Enable wrt 10min** field and transferred to the transmitter, it will be possible to change transmitter parameters during a 10 minute period.

To change the transmitter from the write protection "Yes" status back to write protection "No" status, use **Enable wrt 10min** to first release the write protection function and then enter eight spaces in the **New password** field.

- Procedure to call up the display using by DD and DTM (excluding EJX HART 5 DTM based on FDT1.2)

DD and DTM (excluding EJX_HART 5[1.2])	[Root Menu] → Device setup → Detailed setup → Wrt protect menu →
Write protect	Display current protect mode (Yes: protected, No: not protected)
Enable wrt 10 min	Release the protect function for 10 min.
New password	Set: Put a new password with 8-digit Release: Put 8 spaces

- Procedure to call up the display by EJX HART 5 DTM based on FDT1.2

EJX HART 5 DTM based on FDT1.2	Write Protect →
Write Protect	Display current protect mode (Yes: protected, No: not protected)
Enter new password	Enter the password here to enable the protect function. Enter eight spaces to disable the protect function.
Enable write	Enter the password here to release the protect function for 10 min.

3.3.12 Signal Characterizer

This function is used to compensate the output for non-linear applications. The characterized values are applied to the analog output. For the measured pressure, a maximum of nine coordinates can be specified between 0-100%. Perform the coordinate settings while the **S.C.** at **S.C. menu** parameter is "Disabled".

To apply the settings to the output, set the **S.C.** parameter to "Enabled".

Note that the transmitter rejects the activation of the function by AL. 60 with the following transmitter's status:

- When the specified coordinates of x and y are not incremental as the input increases.
- When the output mode of the output signal is set as "Sq root"; at the same time, the low cut mode is set to "Linear".

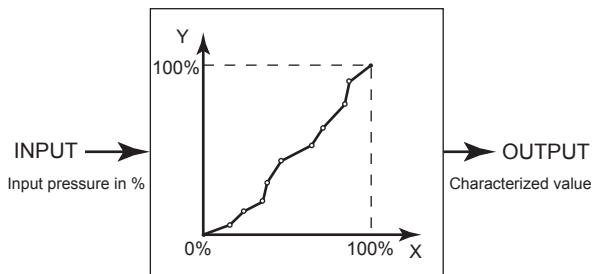

F0308.ai

Follow the steps below to perform the signal characterizer.

<1> Set the desired number of coordinates on the line graph

- Procedure to call up the display

DD and DTM (excluding EJJ_HART 5[1.2])	[Root Menu] → Device setup → Detailed setup → Signal condition → S.C. menu →
EJJ_HART 5[1.2] DTM	Configuration → Signal Characterizer Menu →
→ Num of points	Set the number between 0 and 9

<2> Set the coordinates

- Procedure to call up the display

DD and DTM (excluding EJJ_HART 5[1.2])	[Root Menu] → Device setup → Detailed setup → Signal condition → S.C. menu →
EJJ_HART 5[1.2] DTM	Configuration → Signal Characterizer Menu →
→ Point setting	Set the coordinates (X-axis, Y-axis)

<3> Apply the settings

- Procedure to call up the display

DD and DTM (excluding EJJ_HART 5[1.2])	[Root Menu] → Detailed setup → Signal condition → S.C. menu →
EJJ_HART 5[1.2] DTM	Configuration → Signal Characterizer Menu →
→ S.C.	Select "Enabled" or "Disabled"

3.3.13 Alarm

The function is used to display the alarm codes when the input pressure exceeds the specified value within the calibration range. The same is available for the input static pressure and the capsule temperature on the pressure sensor. Refer to table 4.5 Alarm Message Summary for the specific alarm code to be generated.

(1) Alarm Setting

Select the process variable at **Process Alert** which the alarm is set, then set the alert mode for that value.

- Procedure to call up the display

DD and DTM (excluding EJJ_HART 5[1.2])	[Root Menu] → Detailed setup → Output condition → Process Alerts →
EJJ_HART 5[1.2] DTM	Configuration → Process Alerts →
Selection of the process variable for alarm	→ Pres Alert (DTM only) → Pres Alert mode: Pressure
	→ SP Alert (DTM only) → SP Alert mode: Static pressure
	→ Temp Alert (DTM only) → Temp Alert mode: Capsule temperature
Selection of alert mode	Off: Disable the alert function
	Hi. AI Detect: High side alert detection
	Lo. AI Detect: Low side alert detection
	Hi/Lo. AI Detect: High and Low side alert detection

(2) Threshold Level Setting

Set the threshold of high and low alert value for alarm generation.

- Procedure to call up the display by DD and DTM (EJJ HART 5 DTM based on FDT1.2)

DD and DTM (excluding EJJ_HART 5[1.2])	[Root Menu] → Device setup → Detailed setup → Output condition → Process Alerts → Pres Alerts →
→ Hi Alert Val	Set the threshold value of upper side for pressure
→ Lo Alert Val	Set the threshold value of lower side for pressure

DD and DTM (excluding EJJ_HART 5[1.2])	[Root Menu] → Device setup → Detailed setup → Output condition → Process Alerts → SP Alerts →
→ SP Hi Alert Val	Set the threshold value of upper side for static pressure
→ SP Lo Alert Val	Set the threshold value of lower side for static pressure

DD and DTM (excluding EJJ_HART 5[1.2])	[Root Menu] → Device setup → Detailed setup → Output condition → Process Alerts → Temp Alerts →
→ Temp Hi Alert Val	Set the threshold value of upper side for capsule temperature
→ Temp Lo Alert Val	Set the threshold value of lower side for capsule temperature

- Procedure to call up the display by EJJ HART 5 DTM based on FDT1.2

EJJ HART 5 DTM based on FDT1.2	Configuration → Process Alerts →
→ Hi Alert Val	Set the threshold value of upper side for pressure
→ Lo Alert Val	Set the threshold value of lower side for pressure
→ SP Hi Alert Val	Set the threshold value of upper side for static pressure
→ SP Lo Alert Val	Set the threshold value of lower side for static pressure
→ Temp Hi Alert Val	Set the threshold value of upper side for capsule temperature
→ Temp Lo Alert Val	Set the threshold value of lower side for capsule temperature



NOTE

When option code /DG6 is specified, **Diag** can be also assigned to Status. The Hi Alert Val or Lo Alert Val for **Diag** is defined by the following parameters.

[Impulse Line Blockage Detection]
Limit meters to detect the blockage and Condition error for ILBD operation is defined. Refer to 4.2.2.1.

[Heat Trace Monitoring]
Fig temp Hi Alert Val and **Fig temp Lo Alert Val** parameters are used as the upper and lower threshold for Status output. Refer to 4.2.3.2.

3.3.14 Status Output (only for EJX series: option code AL) EJX

The transmitter has a contact output. Select the type of output, status output, and set the unit, value etc.

Please note that the status output function is not a safety related function and it can not be used for safety instrumented system applications.

(1) Setting of status output

This feature is used for a transistor output (open collector) of an on/off signal according to the status of high and low alarm limits, which are user-configurable values as shown in subsection 3.3.13 Alarm. The status output can be assigned as any combination of the high or low limits of the input pressure, input static pressure, or capsule temperature.

- Procedure to call up the display

DD and DTM (excluding EJX_HART 5[1.2])	[Root Menu] → Device setup → Detailed setup → Output condition → Process Alerts → DO config → DO Select
EJX_HART 5 [1.2] DTM	Configuration → Process Alerts → DO Select
Display Item	Contents (Select a output variable from the list below)
Off	–
Pres	Differential pressure
SP	Static pressure
Temp	Temperature
Pres/SP	Pressure and static pressure
Pres/Temp	Pressure and temperature
SP/Temp	Static pressure and temperature
Pres/SP/Temp	Pressure, static pressure and temperature
Diag Alarm	Alarm for advanced diagnostics (Refer to subsection 4.2.2.5)
All	Alarm for pressure, static pressure, temperature, and advanced diagnostics



NOTE

No status output signal has been defined for a CPU failure or hardware error. Use a 4-20 mA signal to indicate a transmitter's failure.

Example: Status output operation of ON WHEN AL. DETECT

- Status output for higher alert value

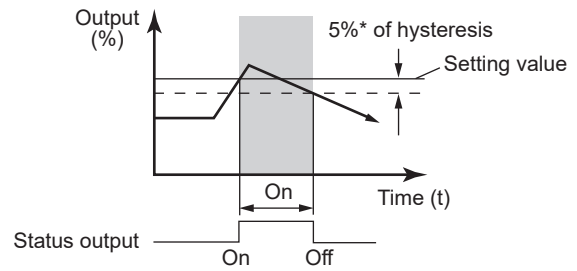

- Status output for lower alert value

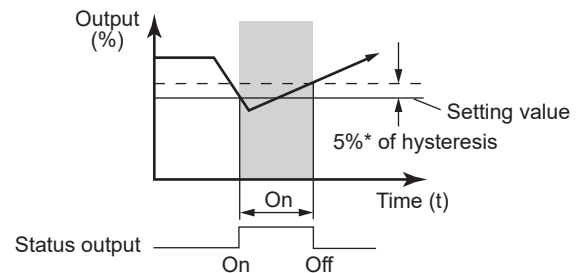

*: 5% of setting span for differential pressure / pressure

F0309.ai

Figure 3.2 Status Output

(2) Selecting of output signal

Status output can be selected for the contact output.

- Procedure to call up the display

DD and DTM (excluding EJX_HART 5[1.2])	[Root Menu] → Device setup → Detailed setup → Output condition → Process Alerts → DO config → DO Signal type
EJX_HART 5 [1.2] DTM	Configuration → Process Alerts → DO Signal type
ON WHEN AL. DETECT	Output is "ON" when alert is detected
OFF WHEN AL. DETECT	Output is "OFF" when alert is detected



CAUTION

Whenever turning on the transmitter or detecting the short interruption, check if contact output correctly reflects the alarm status and test the ON/OFF action of contact output by the parameter **DO test** to confirm that the contact output operates correctly.

3.3.15 Capillary Fill Fluid Density Compensation

For transmitters with diaphragm seals, this function is used to compensate the zero shift caused by the ambient temperature effect on the capillary tubes.

The following equation indicates the relationship between the calculated output value and the compensating constant K (%/°C) with the measured ambient temperature at the capsule module.

$$\text{Compensated output} = \text{output} + K \times \text{Temp}$$

(1) Temperature Compensation Mode Setup

When using this function, set **T.Z. Cmp mode** to “On” to enable or “Off” to disable. To set to “On”, follow the procedure below.

- Procedure to call up the display

DD and DTM (excluding EJX_HART 5[1.2])	[Root Menu] → Device setup → Detailed setup → Signal condition → T.Z. Comp menu →
EJX_HART 5[1.2] DTM	Configuration → Pressure Sensor →
→ T.Z. Comp mode	Select “On” or “Off”

Select “On” at the **T.Z. Cmp mode** display

(2) Zero Shift Compensation Setup

Obtain the K compensating value from the equation (a) below, and enter the value to **Temp Zero**.

$$K = \frac{-h \times B}{\text{Span}} \times 100 \dots\dots\dots (a)$$

where,

B: Constant value of fill fluid (See Table A.)

Span: |URV – LRV|

h: Distance from high pressure side to low pressure side (m)

EJX118A/EJA118E: Distance from high side of diaphragm seal to low side of diaphragm seal.

EJX438A/EJA438E: Distance from diaphragm seal (high side) to position of transmitter (low side).

- EJX118A/EJA118E

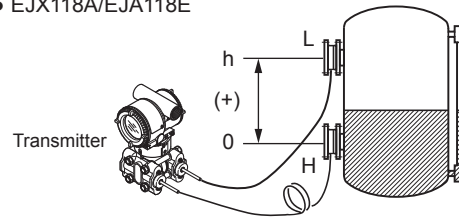

- EJX438A/EJA438E

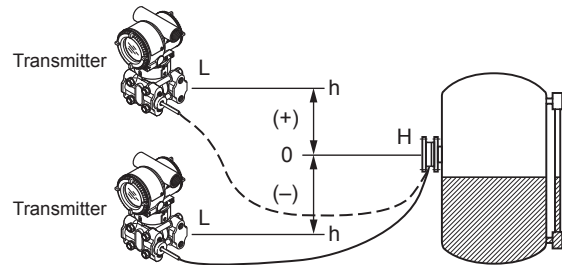

Note: When the transmitter is positioned lower than the diaphragm seal part, the value of “h” must have a negative sign (-).

F0310.ai

Example: Enter K value obtained from the equation (a). A value having up to 3 decimal places may be specified.

When h=+3 m, Fill fluid code A, span=15 kPa,
 $K = -(+3) \times 0.00745 \div 15 \times 100 = -0.149$

- Procedure to call up the display

DD and DTM (excluding EJX_HART 5[1.2])	[Root Menu] → Device setup → Detailed setup → Signal condition → T.Z. Comp →
EJX_HART 5[1.2] DTM	Configuration → Pressure Sensor →
→ Temp Zero	Set the compensation value

Input “-0.149” to **Temp Zero** parameter.

Note 1: The function is performed using a built-in temperature sensor in the transmitter body. The temperature deviation between the transmitter body and capillaries should be minimized to achieve optimal performance of the function.

Note 2: When the span changes, reenter the newly obtained value of K to **Temp Zero**.

Table A. Constant value [B] of fill fluid

	Fill fluid code	A, C, 1, 2, 4	B	D	E
Constant value [B]	mmH ₂ O	0.76	0.87	1.45	0.75
	kgf/cm ²	0.000076	0.000087	0.000145	0.000075
	kPa	0.00745	0.00853	0.01422	0.00736
	mBar	0.07453	0.08532	0.14220	0.07355
	atm	0.000074	0.000084	0.000140	0.000073
	inH ₂ O	0.02992	0.03425	0.05709	0.02953
	psi	0.00108	0.00124	0.00206	0.00167
	mmHg	0.05592	0.06401	0.10669	0.05518

Note 3: Select the unit of constant value of [B] from the actual unit used for the transmitter in operation.

3.3.16 Test Output, Simulation, and Squawk



NOTE

Fixed current output, DO Test, and Device Variable Simulation Function continue for a given holding time, then is released automatically. Even if the HART configuration tool power supply is turned off or the communication cable is disconnected, the test output will continue for that time.

The holding time can be selected from 10 min*, 30 min, 60 min, 3 hour, 6 hour or 12 hour.

*: Default value.

- Procedure to call up the display

DD and DTM	[Root Menu] → Diag/Service → Test → Test Auto Release Time
DTM (excluding EJJ_HART 5 [1.2])	[Root Menu] → Diag/Service → Test → Test Auto Release Time
EJJ_HART 5[1.2] DTM	Diag and Service → Service → Test Auto Release Time

(1) Fixed current output

This feature can be used to output a fixed current (or voltage) for loop checks. The available range for test output depend on the settings for the **AO lower limit** and **AO upper limit** parameters, whose limit is from 3.6 mA or 0.9 V (-2.5%) to 21.6 mA or 5.4 V (110%).

Refer to the subsection 3.3.3 about the setting of **AO lower limit** and **AO upper limit**.

While this function works, "TEST" is displayed on the integral indicator.

● **Setting by DD and DTM (EJJ HART 5 DTM based on FDT1.2)**

Call up the test output parameter (Loop test) and select the output signal.

- Procedure to call up the display

DD and DTM (excluding EJJ_HART 5[1.2])	[Root Menu] → Diag/Service → Test → Loop test
Display Item	Contents
4mA (1V*)	Output a 4mA (1V*) DC signal
20mA (5V*)	Output a 20mA (5V*) DC signal
Other	Set a desired output signal value
End	Exit

*: For 1 to 5 V output.

● **Setting by EJJ HART 5 DTM based on FDT1.2**

Call up the test output parameter (Loop test) and select either manual test or auto test, and set the current value.

- Procedure to call up the display

EJJ HART 5 DTM based on FDT1.2	Diag and Service → Service → Loop test
Display Item	Contents
Manual Test	Set the current value or % value at Test output value , then click the Start button.
Auto Test	Set the interval and rate of change of current output at Auto Test Setting , then click the Start button.

(2) DO Test (only for EJJ series) EJJ

This function performs the contact output test. (option code: /AL)

- Procedure to call up the display

DD and DTM (excluding EJJ_HART 5[1.2])	[Root Menu] → Device setup → Detailed setup → Output condition → Process Alerts → DO config → DO Test
EJJ_HART 5[1.2] DTM	Diag and Service → Service → DO test →
Display Item	Contents
Off	Contact output: OFF
On	Contact output: ON
Exit	Output test is canceled

(3) Device Variable Simulation Function (Effective only when setting to HART 7)

HART 7

Using the simulation function, the output signal can be confirmed by setting any value and status to the selected device variable.

Call up the parameter and follow the message shown.

After completing the step 5, the simulation starts. Integral indicator shows output value and alarm (AL.91) alternately.

- Procedure of device variable simulation

Step 1	Call up the parameter	[Root Menu] → Diag/Service → Test (DTM)/Test device (DD) → Simulate
2	Selection of Device Variable	Select one parameter from the list below Off PV SV TV Percent Range Loop Current
3	Setting of Value	Input the simulate value
4	Setting of Data quality	Select one parameter from the list below Bad Poor accuracy Manual / Fixed Good
5	Setting of Limit status	Select one parameter from the list below Not limited Low limited High limited Constant



NOTE

- All the simulations for pressure, static pressure, and capsule temperature are reflected to the output. Accordingly, the loop current, LCD display, and communication output are directly corresponded to the simulate value.
The alarm output is also available according to the simulate value.
- Damping is applicable for pressure, static pressure, and capsule temperature simulation.

(4) Squawk (Effective only when setting to HART 7)

HART 7

This feature can be used to identify the communicating transmitter by remotely causing LCD to display the particular pattern as shown in the Figure 3.3.

- In case of Device Revision 12
“SQUAWK” continues depending on the setting of ‘Change Number of squawks to make’. In case of default setting ‘5’, “SQUAWK” continues for approximately 10 seconds, then is released automatically.

- Procedure to call up the **Squawk** display

[Root Menu] → Diag/Service → Test → Squawk	
Change Number of squawks	Setting the squawks duration period
Squawk	Execute squawk (Squawk display on LCD)
Exit	End of squawk

- In case of Device Revision 10
“SQUAWK” continues for approximately 15 seconds, then is released automatically. Enter the larger number to “Change number of squawks to make” in order to prolong the duration of squawk indication.

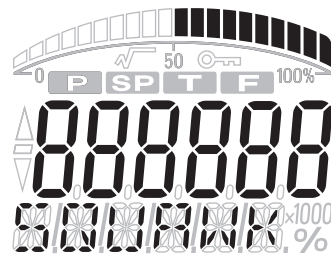

F0311.ai

Figure 3.3 LCD display for Squawk

3.3.17 Burst Mode

3.3.17.1 In the case of using HART 5

HART 5

When the **Burst mode** is enabled, the transmitter continuously sends the stored data. The data is sent approximately three times per second as a digital signal when the transmitter is set in burst mode. When data is being sent in burst mode, other operations can be performed with the HART configuration tool.

(1) Selection of the transmission data.

Call up the **Burst option** parameter and select the data which is transferred.

- Procedure to call up the display

DD and DTM (excluding EJX_HART 5[1.2])	[Root Menu] → Device setup → Detailed setup → Output condition → HART output → Burst option
EJX_HART 5[1.2] DTM	Configuration → HART → Burst option
Display Item	Contents
PV	Process variable assigned to PV (Either of pressure, static pressure)
%range/current	Output in % and mA
Process vars/crnt	Output in mA and process variables assigned to PV, SV and TV. (Output in mA, pressure, static pressure and capsule temperature)

(2) Shift to the Burst mode.

To enable the Burst mode, select “On” at the **Burst mode** parameter.

To release the **Burst mode**, call up the **Burst mode** display and set it to “Off”.

This parameter is set to “Off” when the instrument is shipped.

- Procedure to call up the display

DD and DTM (excluding EJX_HART 5[1.2])	[Root Menu] → Device setup → Detailed setup → Output condition → HART output → Burst mode
EJX_HART 5[1.2] DTM	Configuration → HART → Burst mode
Display Item	Contents
Off	Stop the burst mode
On	Start the burst mode

3.3.17.2 In the case of using HART 7

HART 7

4-20mA

When the **Burst mode** is enabled, the transmitter continuously sends up to three data listed in Table 3.1.

Refer to the subsection 3.3.17.2.1 Burst Message for details.

When the **Burst mode** is set to “Wired HART Enabled”, transmitter continuously sends alarm signal also.

Refer to subsection 3.3.17.2.2 Event Notification for detail.

When changing the setting of **Burst mode**, set “Off” to the **Burst mode**.

Default setting is “Off”.

3.3.17.2.1 Burst Message and Burst Mode

(1) Burst message

The transmitter can transmit three burst messages at the maximum.

The parameters for **Burst Message** are as follows.

- Burst Command
- Update Period and Max Update Period
- Burst Msg Trigger Mode

Table 3.1 Burst parameters

Command parameter	Burst Command	Burst Msg Trigger Mode	Burst Trigger Source	Burst Trigger Units
PV (Pressure • Differential Pressure)	Cmd1:PV	Continuous	---	---
		Window	PV	Depend on the assigned variable to PV
		Rising		
		Falling		
		On-change		
% range/current (Percent of range, Loop current)	Cmd2:% range/current	Continuous	---	---
		Window	% range	%
		Rising		
		Falling		
		On-change		
Process vars/current (Loop current, Pressure • Differential Pressure • Static Pressure • Temperature)	Cmd3:Dyn vars/current	Continuous	---	---
		Window	PV	Depend on the assigned variable to PV
		Rising		
		Falling		
		On-change		
Process vars/% range/ current Mapping by user	Cmd9:Device vars w/status	Continuous	---	---
		Window	Top of Burst Device Variables	Depends on mapping
		Rising		
		Falling		
		On-change		
Self diagnosis information	Cmd48:Read Additional Device Status	Continuous	---	---
		On-change	All status	---

*1: Output the data with time and status.

(2) Burst mode setting procedure

- Procedure to call up the display

DD and DTM	[Root Menu] → Detailed setup → Output condition → HART output → Burst Condition → Burst Message 1,2 or 3 → Burst Command
------------	--

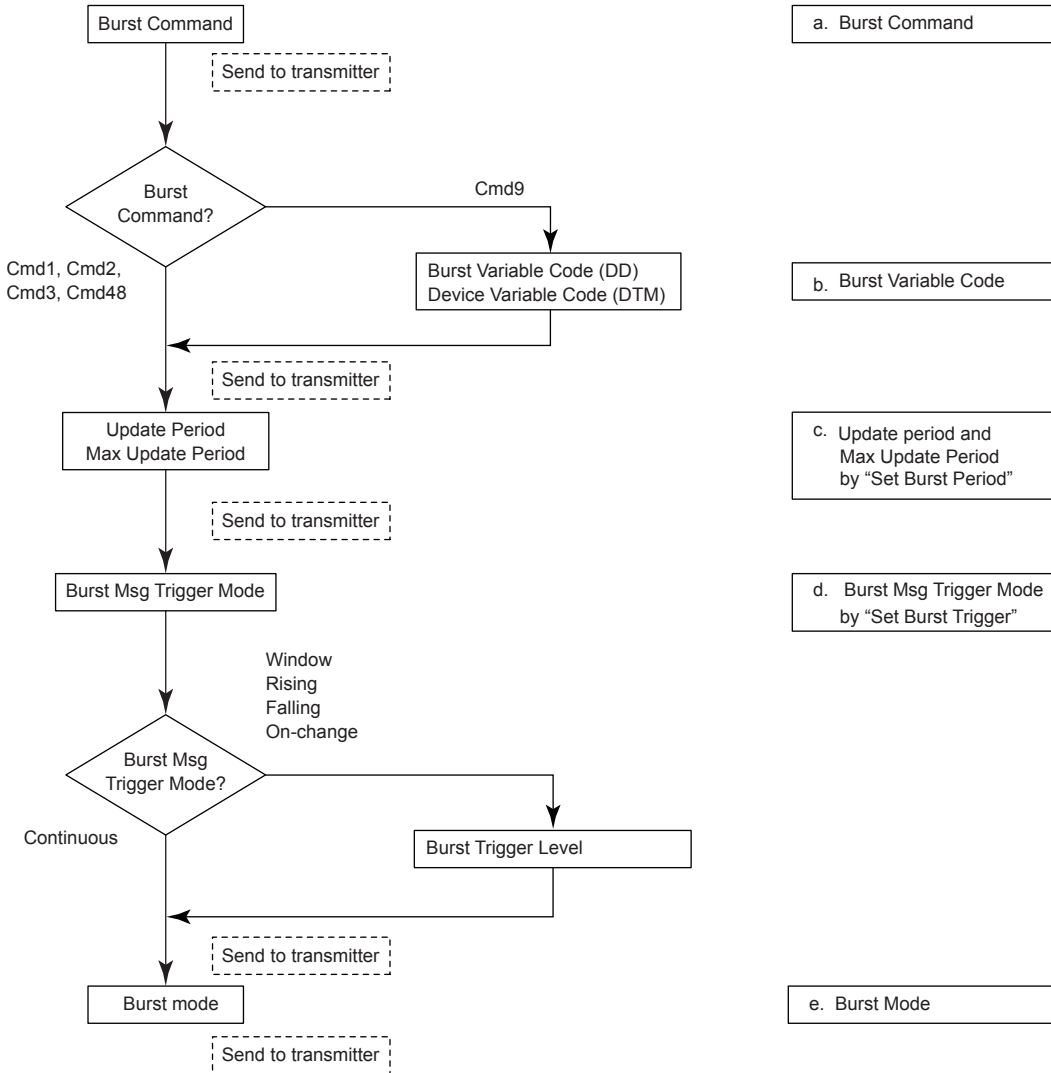

F0312.ai

a. Burst Command

Select the transmission data at **Burst Command** parameter.

Burst Command	Command parameter
Cmd1: PV	PV (Pressure • Differential Pressure)
Cmd2: % range/current	% range/current (Percent of range, Loop current)
Cmd3: Dyn vars/current	Process vars/current (Loop current, Pressure • Differential Pressure • Static Pressure • Temperature)
Cmd9: Device vars w/ status	Process vars/% range/current Mapping by user
Cmd48: Read Additional Device Status	Self diagnosis information

b. Burst Variable Code/Device Variable Code

This parameter need to be set when **Burst Command** is Cmd9:Device vars w/status (up to eight items).

- Procedure to call up the display

DD and DTM	[Root Menu] → Device setup → Detailed setup → Output Condition → HART Output → Burst Condition → Burst Message 1,2 or 3 → Burst Device Variables → Burst Variable Code →
Display Item	Contents
PV	Select the pressure
SV	Select the static pressure
TV	Select the capsule temperature
% rnge	Select the % output
Loop current	Select the output current
Not Used	—

c. Update period and Max Update Period

Set to **Update Period** and **Max Update Period**. The Burst Trigger Source is checked with a period of Update Period, and if it fulfills the condition of Burst Message Trigger Mode, the data is updated. When it does not fulfill the condition of the Trigger Mode with a period of Update Period, the data is updated forcibly with Max Update Period. When the period that is earlier than the operation period of each process value was set, it is set automatically to become bigger than an operation period of the transmitter. For **Update Period**, set the value that is smaller than **Max Update Period**.

- Procedure to call up the display

DD and DTM	[Root Menu] → Device setup → Detailed setup → Output condition → HART output → Burst condition → Burst Message 1,2 or 3 → Set Burst Period
Update Period / Max Update Period	0.5 s
	1 s
	2 s
	4 s
	8 s
	16 s
	32 s
	1 min
	5 min
	10 min
	15 min
	30 min
45 min	
60 min	

d. Burst Msg Trigger Mode

Set the **Burst Msg Trigger Mode** from the parameters shown below.

When **Burst Msg Trigger Mode** is Window, Rising or Falling, set the **Burst Trigger Level**.

- Procedure to call up the display

DD and DTM	[Root Menu] → Device setup → Detailed setup → Output Condition → HART Output → Burst Condition → Burst Message 1,2 or 3 → Set Burst Trigger
Display Item	Contents
Continuous	Burst Message is transmitted continuously.
Window	In “Window” mode, the Trigger Value must be a positive number and is the symmetric window around the last communicated value.
Rising	In “Rising” mode, the Burst Message must be published when the source value exceeds the threshold established by the trigger value.
Falling	In “Falling” mode, the Burst Message must be published when the source value fall below the threshold established by the trigger value.
On-change	In “On-change” mode, the Burst Message must be published when the source value on change established by the trigger value.

e. Burst Mode

When the **Burst mode** is set to “Wired HART Enabled”, the transmitter starts to send the data.

- Procedure to call up the display

DD and DTM	[Root Menu] → Device setup → Detailed setup → Output condition → HART output → Burst condition → Burst Message 1,2 or 3 → Burst mode → Wired HART Enabled
------------	--

3.3.17.2.2 Event Notification

When a setting change and a change of the Self-diagnostics occur, device detect it as an event and can transmit an alarm signal continuously.

Up to four events that occurred can be stored. When using this function, set to **Burst mode** as “Wired HART Enabled”.

(1) Set Event Notification

- Procedure to call up the display

DD and DTM	[Root Menu] → Device setup → Detailed setup → Output condition → HART output → Event Notification →
→ Event Mask	Set the status to detect
→ Event Notification	→ Set Event Notification Timing
→ Event Notification Retry Time	Set the retry time when the event occur.
→ Max Update Time	Set the retry time when the event does not occur.
→ Event Debounce Interval	The setting of the minimum event duration
→ Event Notification → Event Notification Control	Stop the event monitor: Off Shift to the monitor state: Enable event notification on token-passing data link layer

a) Event Mask

Set the status to detect in the **Event Mask** parameter.

Device Status Mask
Status group 1 Mask to 10 Mask
Ext dev status Mask
Device Diagnostic Status 0 Mask
Device Diagnostic Status 1 Mask
AO saturated Mask
AO fixed Mask

When changing the configuration of the device, Configuration Changed (0x40) Flag (refer to Table 4.7) of Device Status is set, and Cfg chng count (refer to subsection 4.1.3 (5)) is also incremented. Configuration changed flag detection can be masked by the Device Status Mask, but it is impossible to mask the Cfg chng count. Therefore, the configuration changes to the device are always detected as an event regardless of the setting of the Device Status.

b) Event Notification Retry Time/ Max Update Time/ Event Debounce Interval

Set to Event Notification Retry Time, Max Update Time and Event Debounce Interval.

For **Event Notification Retry Time**, set the value that is smaller than **Max Update Time**.

Event Notification Retry Time /Max Update Time	Event Debounce Interval
---	Off
0.5 s	0.5 s
1 s	1 s
2 s	2 s
4 s	4 s
8 s	8 s
16 s	16 s
32 s	32 s
1 min	1 min
5 min	5 min
10 min	10 min
15 min	15 min
30 min	30 min
45 min	45 min
60 min	60 min

c) Event Notification Control

Select “Enable event notification on token-passing data link layer” in the **Event Notification Control** parameter to shift to the monitor state:

(2) Acknowledge Event Notification

The transmission of the event message stops when event is approved.

- Procedure to call up the display

DD and DTM	[Root Menu] → Device setup → Detailed setup → Output condition → HART output → Event Notification → Knowledge →
→ Acknowledge Event Notification	Acquisition of the event number and approval.

a) Get Event Number

Confirm the latest event number.

Execute **Acknowledge Event Notification** method.

- 1) Enter Event Number is set to "0".
- 2) OK.
- 3) Set "Trans 0: Read Event Notificaiton" to Select Transaction.
- 4) OK.
- 5) Confirm Event Number.

b) Acknowledge Event Notification

Execute **Acknowledge Event Notification** method.

- 1) Set to Enter Event Number is in confirmed Event Number a)5.
- 2) OK.
- 3) Set "Trans 1: Send Acknowledge" to Select Transaction.
- 4) OK.
- 5) Confirm Event Status is cleard (0x00).

(3) Event Notification Record

- Procedure to call up the display

DD and DTM	[Root Menu] → Device setup → Detailed setup → Output condition → HART output → Event Notification → Knowledge →
→ Acknowledge Event Notification	Acquisition of the event number and approval.

a) Get Event Number

Confirm the latest event number.

Execute **Acknowledge Event Notification** method.

- 1) Enter Event Number is set to "0".
- 2) OK.
- 3) Set "Trans 0: Read Event Notificaiton" to Select Transaction.
- 4) OK.
- 5) Confirm Event Number.

b) Confirmation record of Event Notification

Confirm four events checked in a).

Execute **Acknowledge Event Notification** method.

- 1) Enter the event number to Enter Event Number which is confirmed in a)5.
- 2) OK.
- 3) Set "Trans 0: Read Event Notificaiton" to Select Transaction.
- 4) OK.
- 5) Knowledge menu displays events record.

Ex.) When the confirmed event number is 123.

Event Number	Explanation
123	The latest event
122	An event before the once.
121	An event before the twice.
120	An event before three times.

3.3.18 Multidrop Mode

3.3.18.1 Setting on HART 5 HART 5

“Multidropping” transmitters refer to the connection of several transmitters to a single communication transmission line. Up to 15 transmitters can be connected when set in the multidrop mode. To activate multidrop communication, the transmitter address must be changed to a number from 1 to 15. This change deactivates the 4 to 20 mA analog output, sending it to 4 mA. The alarm current is also disabled.

Setting of Multidrop Mode

(1) Polling address

- Procedure to call up the display

DD and DTM (excluding EJJ_ HART 5[1.2])	[Root Menu] → Detailed setup → Output condition → HART output →
EJJ_HART 5[1.2] DTM	Configuration → HART →
→ Poll addr	Enter the number from 1 to 15

(2) Enabling the Multidrop Mode of Configuration Tool

About the procedure to call up the **Polling** display, please refer to the User’s Manual of each configuration tool.



When the same polling address is set for two or more transmitters in multidrop mode, communication with these transmitters is disabled.

(3) Communication when set in multidrop mode.

- The HART configuration tool searches for a transmitter that is set in multidrop mode when it is turned on. When the HART configuration tool is connected to the transmitter, the polling address and the tag will be displayed.
- Select the desired transmitter. After that, normal communication to the selected transmitter is possible. However, the communication speed will be slow.

To release multidrop mode, call up the **Poll addr** display and set the address to “0”.

3.3.18.2 Setting on HART 7 HART 7 4-20mA

“Multidropping” transmitters refer to the connection of several transmitters to a single communication transmission line. Up to 63 transmitters can be connected when set in the multidrop mode. To activate multidrop communication, the transmitter address must be changed to a number from 1 to 63. If it sets to multidrop mode, in order to transmit all the data in digital one, it is necessary to change a setup of the analog output signal of 4 to 20 mA.

Setting of Multidrop Mode

(1) Polling address

- Procedure to call up the display

DD and DTM	[Root Menu] → Device setup → Detailed setup → Output condition → HART output →
→ Poll addr	Enter the number from 1 to 63



When the same polling address is set for two or more transmitters in multidrop mode, communication with these transmitters is disabled.

(2) Analog Output Signal Setting

Set Disabled to **Loop current mode** and fix an analog output signal to 4mADC. It becomes impossible in this case, to also use a burnout output.

However, in the case of the application which receives and operates an analog output signal, an analog output signal can be used for one loop. In this case, set Enabled to **Loop current mode**.

- Procedure to call up the display

DD and DTM	[Root Menu] → Device setup → Detailed setup → Output condition → Analog output → Loop current mode
Enabled	Loop current mode is enabled.
Disabled	Loop current mode is disabled.

(3) Enabling the Multidrop Mode of Configuration Tool

About the procedure to call up the **Polling** display, please refer to the User’s Manual of each configuration tool.

(4) **Communication when set in multidrop mode.**

- The HART configuration tool searches for a transmitter that is set in multidrop mode when it is turned on. When the HART configuration tool is connected to the transmitter, the polling address and the tag will be displayed.
- Select the desired transmitter. After that, normal communication to the selected transmitter is possible. However, the communication speed will be slow.

To release multidrop mode, call up the **Poll addr** display and set the address to "0".

Return **Loop current mode** to Enabled.

3.3.19 Switching HART Protocol Revision

When the output signal code is "-J", HART protocol revision of the transmitter can be selectable from 5 or 7.

The HART protocol revision is set and shipped as specified in the order.

To change the HART protocol revision after shipment, follow the procedure shown below.



IMPORTANT

When changing the protocol revision, confirm the items below.

- Protocol revision supported by HART configuration tool must be the same or higher than new protocol revision of the transmitter. (Refer to Table 2.1)
- Confirm that the DD or DTM which is suitable to new protocol revision of transmitter is installed in the configuration tool. (Refer to Section 2.3 or 2.4)

- 1) Call up the parameter for protocol revision change
 - Procedure to call up the **Chg universal rev** display.

DD and DTM (excluding EJX_HART 5[1.2])	[Root Menu] → Device setup → Detailed setup → Device information → Field device info → Revision #'s → Chg universal rev
EJX_HART 5[1.2] DTM	Configuration → HART → Chg universal rev

- 2) Activate the "Chg universal rev" method



IMPORTANT

The message is displayed to separate the transmitter from the automatic control loop. Confirm that the transmitter is separated.

- 3) Input the new revision number
An input column for new protocol revision number is displayed. Input the new HART protocol revision number of "5" for HART 5 or "7" for HART 7.
- 4) Applying the new protocol revision
 - a. Close the configuration tool
After completion of Chg universal rev method, close the HART configuration tool.



NOTE

When using a FieldMate, close the main display of FieldMate.

- b. Restart the transmitter
Turn off the power to the transmitter, and turn it on.



IMPORTANT

New protocol revision is applied only after having performed restart of the transmitter.



NOTE

A new HART revision number is displayed on the integral indicator for three (3) seconds after restart the transmitter. (Refer to section 2.1)

- 5) Confirming the new protocol revision
 - a. Restart the HART configuration tool



NOTE

When execute the other parameter confirmation or setting change, execute after restart the configuration tool.

- b. Confirm the new HART protocol revision number

Call up the **Universal rev** parameter, and confirm that the new HART revision number is displayed.

- Procedure to call up the **Universal rev.** parameter.

DD and DTM (excluding EJX_HART 5[1.2])	[Root Menu] → Device setup → Detailed setup → Device information → Field device information → Revision #'s → Universal rev
EJX_HART 5[1.2] DTM	Configuration → HART → Universal rev.
5	HART protocol revision: 5
7	HART protocol revision: 7

4. Diagnostics

4.1 Self-Diagnostics

4.1.1 Identify Problems by Using HART Configuration Tool

The HART configuration tool can be used to run self-diagnostics on a transmitter and check for incorrect data settings.

(1) DD and DTM (excluding EJX HART 5 DTM based on FDT1.2)

The **Self test** and **Status** commands are available for self-diagnostics. When **Self test** is run, the integral indicator shows an error code and alarm message if the transmitter detects any illegal parameter settings or functional faults. See Table 4.5 Alarm Message Summary for probable cause and countermeasures.

- Procedure to call up the **Self test** display

[Root Menu] → Diag/Service → Test → Self test

If no error is detected, "Self test OK" is displayed on the configuration tool.

If the specific diagnostic item is known for the check, you can directly call up the item by using the **Status** command.

The status is categorized from 1 to 9 for HART 5, and from 1 to 10 for HART 7.

See Table 4.5 to determine the status group.

Show an example below to confirm the status of Status group 1.

- Procedure to call up the **Status** display

[Root Menu] → Diag/Service → Status → Status group 1

If there is an error, check is displayed in the check box of the error and a countermeasure for that error is necessary.

Example of display:

- P sensor error (AL-01)
- CT sensor error (AL-01)
- Cap EEPROM error (AL-01)
- AT sensor error (AL-02)
- Amp EEPROM error (AL-02)

The HART configuration tool diagnoses at each communication.

When an improper operation is performed, the error message is displayed.

See Table 4.6 HART Configuration Tool Error Message.

(2) EJX HART 5 DTM based on FDT1.2

The **Device Status** commands are used for self-diagnostics. When **Device Status** is run, the integral indicator shows an error code and alarm message if the transmitter detects any illegal parameter settings or functional faults. See Table 4.5 Alarm Message Summary for probable cause and countermeasures.

- Procedure to call up the **Device Status** display

Device Status

If no error is detected, "Status: Normal" is displayed on the configuration tool.

If the specific diagnostic item is known for the check, you can directly call up the item by using the Diagnostic List in the Device Status display.

The Diagnostic List is categorized to Device Status, Hardware Failure, Transducer Status, Diag Status, and Configuration.

See Table 4.5 Alarm Message Summary.

If no error is detected, color symbol which shows Normal State is displayed on top of the error message.

If color symbol which shows Error State is displayed, there is an error and a countermeasure for that error is necessary.

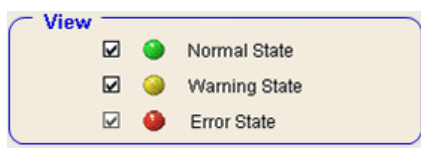
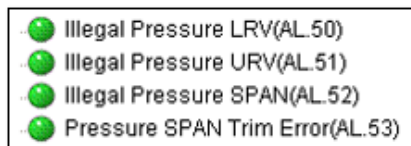

The HART configuration tool diagnoses at each communication.

When an improper operation is performed, the error message is displayed.

See Table 4.6 HART Configuration Tool Error Message.

4.1.2 Checking with Integral Indicator



NOTE

If an error is detected by running self-diagnostics, an error number is displayed on the integral indicator. If there is more than one error, the error number changes at three-second intervals. See table 4.3.1 regarding the alarm codes.



F0401.ai

Figure 4.1 Integral Indicator

4.1.3 Status information available for HART 7 HART 7

Status added to HART 7 is explained below.

(1) Device Status

Device Status indicates the current operating status of the device. (Refer to Table 4.7)
Table 4.10 indicates the relationship between alarm and Device Status.

- Procedure to call up the display

DD and DTM	[Root Menu] → Diag/Service → Status → Device status
------------	--

(2) Extended Device Status

Ext dev status contains commonly used device information. (Refer to Table 4.8)
Table 4.10 indicates the relationship between alarm and Extended Device Status.

- Procedure to call up the display

DD and DTM	[Root Menu] → Diag/Service → Status → Ext dev status
------------	---

(3) Data quality and Limit status

The transmitter can handle Pres, SP, Snsr temp, Percent Range and Loop current. Each variable contains data quality and limit status for providing useful status about the data value. The data quality is normally “Good”. However, in the case of a sensor failure or out of measurement range, it turns to “Bad” or “Poor Accuracy”. The limit status indicates whether the data value is limited (i.e., not responding to the process). When the limit status is “Constant”, the value will not be changed. For detail, refer to Table 4.9 and 4.10.

- Procedure to call up the display

[Dynamic Variables]

DD and DTM	[Root Menu] → Process variables → Device variables and Status →
→ Pres Data Quality	Good, Poor Accuracy, Manual/Fixed, or Bad is displayed.
→ Pres Limit Status	Constant, Low Limit, High Limit, or Not Limited is displayed.
It is the same about the SP and Temp, Percent range, and Loop current	

(4) Time Stamp

Time Stamp displays the date and the time information which the transmitter maintains from the time of the power on. It is used as the additional information of the process value and the event.

- Procedure to call up the display

DD and DTM	[Root Menu] → Diag/Service → Status → Time Stamp
→ Current Date	It shows the number of operating days.
→ Current Time	It shows the running time.



NOTE

Time Stamp is reset when powering on.

(5) Configuration Change Counter
 The Configuration Change Counter is incremented once for every user action that changes the device's configuration or calibration. This value is never reset or written and maintained even if power is removed from the device.

- Procedure to call up the display

DD and DTM	[Root Menu] → Diag/Service → Status →
→ Cfg chng count	The configuration change times are counted. The counted value cannot be reset.

(6) Reset Configuration Changed Flag
 Configuration Changed Flag can be reset by this method.



Refer to Configuration Changed (0x40) in the Table 4.7.

- Procedure to call up the display

DD and DTM	[Root Menu] → Diag/Service → Status → Reset Cfg Chng flag
------------	--

4.1.4 NE107 Status Information

Alarm information is divided into four groups on the basis of NE107. The status is displayed on the alarm screen of the HART configuration tool.

NE107 Status Group	Device Status
F Failure	Part failure, device failure, total failure
C Function Check	Output signal temporarily invalid due to local operation, manual value input, etc.
S Out of specification	The device is operating outside the specifications. The measured value is undefined due to improper process or environment.
M Maintenance required	Maintenance is required in the near future or in a certain amount of time.

The following symbols are displayed on the configuration tool.



- F(Failure)
- C(Function Check)
- S(Out of Specification)
- M(Maintenance Required)
- N(No Effect)

F0414.ai

Table 4.4 shows the factory default settings. The four groups can be edited using the HART configuration tool

Recall parameters	[Root Menu] → Diag/Service → Condensed status map →
Device Status	Table 4.7
Ext dev status	Table 4.8
Diagnositic Status 0, 1	
Status group 0 to 5, 14 to 23	Table 4.5

4.2 Advanced Diagnostics (Only for EJX series)

4.2.1 Multi-sensing Process Monitoring

Multi-sensing process monitoring function (option code: /DG6) provides the advanced diagnostics to detect the abnormal conditions in process environment such as an impulse line etc. by using the EJX multisensing technology and its unique algorithm. There are following two functions.

■ Impulse Line Blockage Detection (ILBD)

The fluctuation change of differential pressure and static pressure is monitored by a silicone resonant sensor and detects a potential blockage condition. The differential pressure transmitter gives also a result of which pressure-side was plugged.

■ Heat Trace Monitoring

The two temperature sensors built in the transmitter calculate the flange temperature, the change of which enables to detect the heat trace breakage or the abnormal temperature due to the failure.

4.2.2 Impulse Line Blockage Detection (ILBD)

ILBD is carried out by using statistical analysis based on the measured values of process fluctuations that exist in a fluid. An alarm on the transmitter LCD display or an analog alert is generated if blockage reaches a certain level. The transmitter provides the following results as blockage detection.

(1) A Blocking and B Blocking

These are blockage detections based on the fluctuation value change of differential pressure/pressure. With a differential pressure transmitter, each result indicates that both or single side is plugged.

(2) L Side Blocking

It is a low-pressure side blockage detection based on the change of **BIkF** or low-pressure-side fluctuation value.

(3) H Side Blocking

It is a high-pressure side blockage detection based on the change of **BIkF** or high-pressure-side fluctuation value.

*: **BIkF** indicates blockage degree characterized by a comparison of the high- and low-pressure-side fluctuation values. For the details, refer to Figure 4.2.2.



IMPORTANT

- The pressure fluctuation amplitude in fluids must be sufficiently large for blockages to be detected.
- If the pressure fluctuation amplitude is too low for a reference value to be obtained, blockages detection operation cannot be performed with an alarm that the reference value is invalid.
- The pressure fluctuation amplitude may decrease due to other causes unrelated with a blockage according to process condition. In above case, a false alarm of an impulse line blockage may be generated. Before taking action in response to a blockage alarm, consider the plant operating conditions.

■ Notes for Pressure or Level Measurement

With pressure or level measurement, the pressure fluctuation amplitude may reduce especially for the following cases.

● Pressure Measurement

- Operational pressure is near outside of diagnostic range.
- Even though pressure is constant, the flow decreases than that under normal condition.
- A source of pressure fluctuation (pump, compressor, blower, etc.) is shut down. As a result, the pressure fluctuation amplitude decreases.

● Level Measurement

- A transmitter is used to measure tank level and the flow of fluid into or out of the tank comes to a stop.
- The agitator in the tank is shut down.
- A source of pressure variation (a compressor, etc.) that controls the internal pressure of a sealed (closed) tank is shut down.

Before taking action in response to a blockage alarm, consider the plant operating conditions.

■ Functional block diagram

The figure below shows the functional block diagram of ILBD.

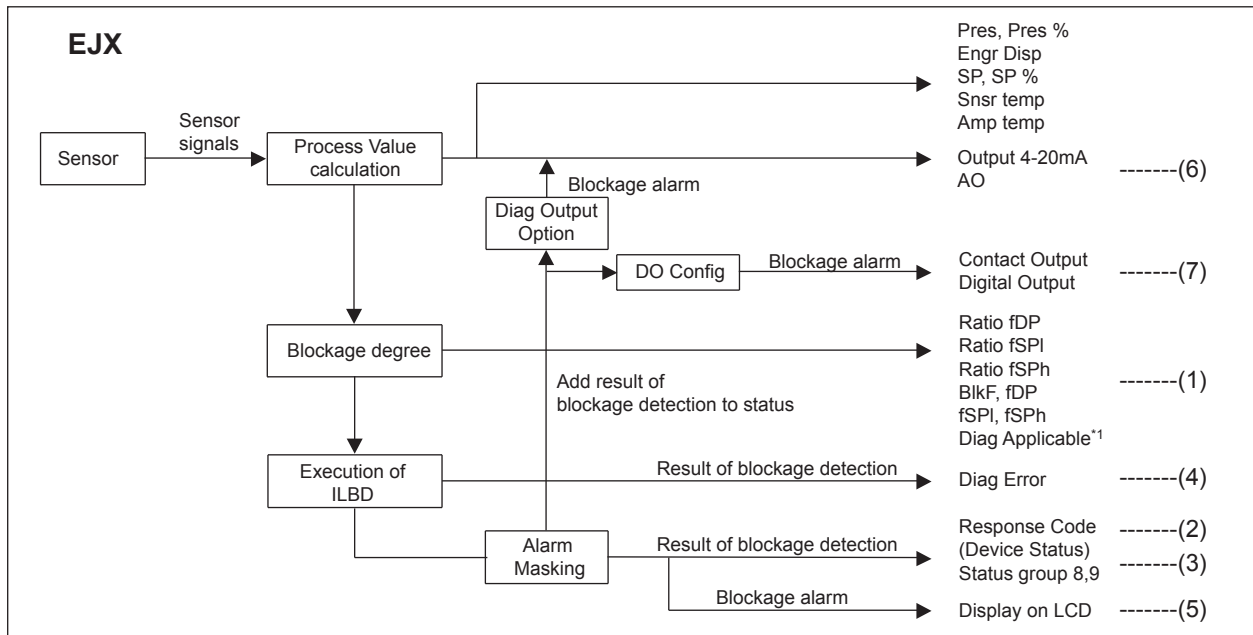

F0402.ai

Figure 4.2 Functional Block Diagram of ILBD

The following outputs are given for the ILBD results.

Table 4.1 List of Outputs for ILBD

#	OUTPUT Parameter name	Remarks
(1)	Ratio fDP	Parameters based on the fluctuation value and blockage degree. [Diag DPComp: Non-Compensation] $\text{Ratio fDP} = \sqrt{\frac{\text{fDP}}{\text{Ref fDP}}}$ [Diag DPComp: Compensation] $\text{Ratio fDP} = \sqrt{\frac{\text{fDP}}{\text{Ref fDP}}} \times \left \frac{\text{Ref DPavg}}{\text{DPAvg}} \right $
	Ratio fSPI	$\text{Ratio fSPI} = \sqrt{\frac{\text{fSPI}}{\text{Ref fSPI}}}$
	Ratio fSPH	$\text{Ratio fSPH} = \sqrt{\frac{\text{fSPH}}{\text{Ref fSPH}}}$
	BlkF	Blockage degree characterized in comparison of high-pressure side and low-pressure side pressure fluctuation value.
	fDP	Average value of the sum of squares of differential pressure fluctuations.
	fSPI	Average value of the sum of squares of low-pressure side static pressure fluctuation.
	fSPH	Average value of the sum of squares of high-pressure side static pressure fluctuation.
	Diag Applicable*1	After the reference value is obtained, the applicable blockage deflection and the status of abnormal fluctuation are displayed on this parameter.
(2)	Response Code Device Status	When an impulse line blockage is detected, "More Status Available" is generated in Response Code Device Status.
(3)	Status group 8, 9	When an impulse line blockage is detected, the result of the blockage detection (alarm status) is indicated.
(4)	Diag Error	When an impulse line blockage is detected, the results of the blockage detection (alarm status) is indicated.
(5)	Display on LCD	When impulse line blockage is detected, an alarm status is displayed on LCD.
(6)	Analog Output	When impulse line blockage is detected, an alarm status is output on 4 to 20mA.
(7)	Digital Output	When impulse line blockage is detected, an alarm status is output on Status output.

F0403.ai

*1: Available only for DD and DTM (excluding EJX HART 5 DTM based on FDT1.2).
 For EJX HART 5 DTM based on FDT1.2, the color of icon on the Diag Error display changes with the status.

4.2.2.1 Blockage Detection

■ Limit parameter

When the parameter based on pressure fluctuation exceeds the preset value, EJX diagnoses an impulse line as blockage and gives an alarm. The threshold values are set to Limit parameter shown in below table.

- Procedure to call up the display

DD and DTM (excluding EJX_ HART 5[1.2])	[Root Menu] → Diag/Service → Diag Parameters → ILBD Parameters → Configuration → Diag Lim →
EJX_ HART 5[1.2] DTM	Diag and Service → Advanced Diag Configurations → Impulse Line Blockage Detection → Threshold → Sensitivity →

Table 4.2 Limit Parameter

#	Parameter	Threshold value
[1]	Lim fDPmax	Threshold to detect "A Blocking" by using Ratio fDP
[2]	Lim fDPmin	Threshold to detect "B Blocking" by using Ratio fDP
[3]	Lim fSPImax	Threshold to detect "Large Fluct L" by using Ratio fSPI
[4]	Lim fSPImin	Threshold to detect "L Side Blocking" by using Ratio fSPI
[5]	Lim fSPHmax	Threshold to detect "Large Fluct H" by using Ratio fSPH
[6]	Lim fSPHmin	Threshold to detect "H Side Blocking" by using Ratio fSPH
[7]	Lim BlkFmax	Threshold to detect "H Side Blocking" by using BlkF
[8]	Lim BlkFmin	Threshold to detect "L Side Blocking" by using BlkF
[9]	Lim DPavgmax	Threshold to detect "ILDB over range" by using DPavg and to detect "Invalid Ref xx" by using Ref DPavg
[10]	Lim DPavgmin	Threshold to detect "ILDB over range" by using DPavg and to detect "Invalid Ref xx" by using Ref DPavg

Table 4.3 shows the default values at the factory setting.



NOTE

- When ILBD is performed for the first time, use the default value. If the pressure fluctuation amplitude is low or a false alarm is often generated after ILBD is performed, change the values of Limit parameters according to the procedure described in subsection 4.2.2.10. Tuning

Table 4.3 Default Values of Limit Parameter

#	Parameter	Differential pressure transmitter		Flange mounted differential pressure transmitter	Diaphragm sealed differential pressure/pressure transmitter	Absolute pressure transmitter	Gauge pressure transmitter	Gauge/ Absolute pressure transmitter
		EJX110A EJX115A EJX130A	EJX120A	EJX210A	EJX118A Note 1 EJX438A	EJX310A	EJX430A EJX440A	EJX510A EJX530A EJX610A EJX630A
[1]	Lim fDPmax	3	3	10000	10000	10000	10000	10000
[2]	Lim fDPmin	0.3	0.3	0.3	0.3	0.3	0.3	0.3
[3]	Lim fSPImax	5	10000	10000	10000	10000	10000	10000
[4]	Lim fSPImin	0.5	0	0	0	0	0	0
[5]	Lim fSPHmax	5	10000	10000	10000	10000	10000	10000
[6]	Lim fSPHmin	0.5	0	0	0	0	0	0
[7]	Lim BlkFmax	0.6	10	10	10	10	10	10
[8]	Lim BlkFmin	-0.6	-10	-10	-10	-10	-10	-10
[9]	Lim DPavgmax Note 2	1	1	1	1	1	1	1
[10]	Lim DPavgmin Note 2	0.05	0.2	-1	-1	0.05	0.05	0.05

Note 1: The default values are set for level measurement. If EJX118A is applied to flow measurement, enter the same value to Limit parameter [1] to [10] as those of EJX110A.

Note 2: It indicates the threshold value for "ILBD over range" (refer to 4.2.2.5).

■ A/B Blocking Detection

"A Blocking" and "B Blocking" indicates the result estimated from blockage degree based on the difference of the high- and low-pressure-side fluctuation values. **Ratio fDP**, **SQRT (fDP / Ref fDP)** is used to detect A/B blocking. **Ref fDP** is the average value of the sum of squares of differential pressure fluctuations under normal condition.

As the value of **Ratio fDP** exceeds the value of **Lim fDPmax**, EJX gives basically an alarm of "A Blocking". On the other hand, if this value is below the value of **Lim fDPmin**, EJX gives an alarm of "B Blocking".

As a high- or low-pressure-side blockage progresses, **fDP** increases. Therefore, "A Blocking" with a differential pressure transmitter indicates that a single-side impulse line is plugged for a differential pressure transmitter. As the both-side blockages progress simultaneously, **fDP** decreases. Therefore, "B Blocking" with a differential pressure transmitter indicates that both-side impulse lines are plugged.



NOTE

A single-side impulse line blockage may generate "B blocking" under the condition where the fluctuation amplitude is much different between high- and low-pressure sides.

■ H/L Blocking Detection

EJX differential pressure transmitter enables to detect both-, a high-, or low-pressure-side blockage. The blockage degree characterized by a comparison of high-pressure side and low-pressure-side fluctuation values, **BlkF**, is used to detect it. The value changes within a range of -1 to +1. As **BlkF** approaches +1, the high-pressure-side blockage progresses. On the other hand, if it approaches -1, the low-pressure-side blockage progresses.

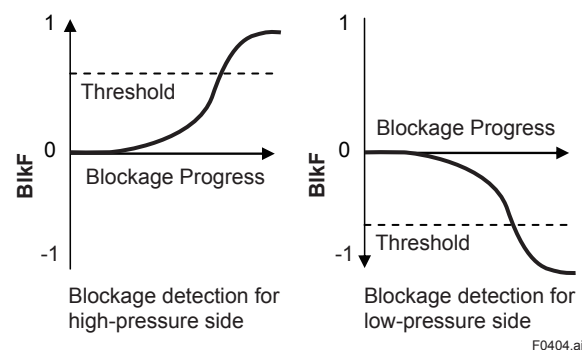

Figure 4.3 Relation between Blockage Progress and BlkF

The each threshold value to detect the high- or low-pressure-side blockage is set to **Lim BlkFmax** or **Lim BlkFmin**.

■ **L Side Blocking Detection**

BlkF is preferentially used to "L Side Blocking" detection. If **BlkF** cannot be used, **Ratio fSPI**, $\text{SQRT}(\text{fSPI} / \text{Ref fSPI})$ is used to "L Side Blocking" detection. **Ref fSPI** is the average value of the sum of squares of low-pressure-side static pressure fluctuations under normal condition.

As the value of **Ratio fSPI** is below the value of **Lim fSPImin**, EJX gives an alarm of "L Side Blocking".

On the other hand, if this value exceeds the value of **Lim fSPImax**, EJX gives an alarm of "Large Fluct L".

■ **H Side Blocking Detection**

BlkF is preferentially used to "H Side Blocking" detection. If **BlkF** cannot be used, **Ratio fSPH**, $\text{SQRT}(\text{fSPH} / \text{Ref fSPH})$ is used to "H Side Blocking" detection. **Ref fSPH** is the average value of the sum of squares of high-pressure-side static pressure fluctuations under normal condition.

As the value of **Ratio fSPH** is below the value of **Lim fSPHmin**, EJX gives an alarm of "H Side Blocking".

On the other hand, if this value exceeds the value of **Lim fSPHmax**, EJX gives an alarm of "Large Fluct H".

■ **Large Fluctuation Detection**

When a pump or compressor starts, the large fluctuation is generated as process condition changes rapidly. This phenomenon affects process fluctuation measurement; so correct blockage detection is not performed.

If "Large Fluct L" or "Large Fluct H" is detected, consider whether a blockage result is correct.

The threshold values to detect large fluctuation are set to **Lim fSPImax** and **Lim fSPHmax**.

Since these values are enough to detect large fluctuation, it is not almost necessary to change them.

4.2.2.2 **Combination of Reference Result and Blockage Detection**

■ **Diag Applicable**

The transmitter can detect four modes of impulse line blockage: both-sides, high-pressure side, low-pressure side, and/or single-side and abnormal fluctuation when all the reference values are properly measured. However, the detectable alarm mode combination is limited when some of the reference values are invalid. Available Blockage Detection are shown in the below figure.



NOTE

- **Ref fDP** must be larger than the specified level shown in Table 4.4 (refer to subsection 4.2.2.6). No blockage can be detected when **Ref fDP** is not large enough.
- The plausibility of blockage detection needs to be confirmed by blockage simulation test. The simulation test can be performed by the appropriate manifold operation (refer to subsection 4.2.2.8).

[Differential pressure measurement]

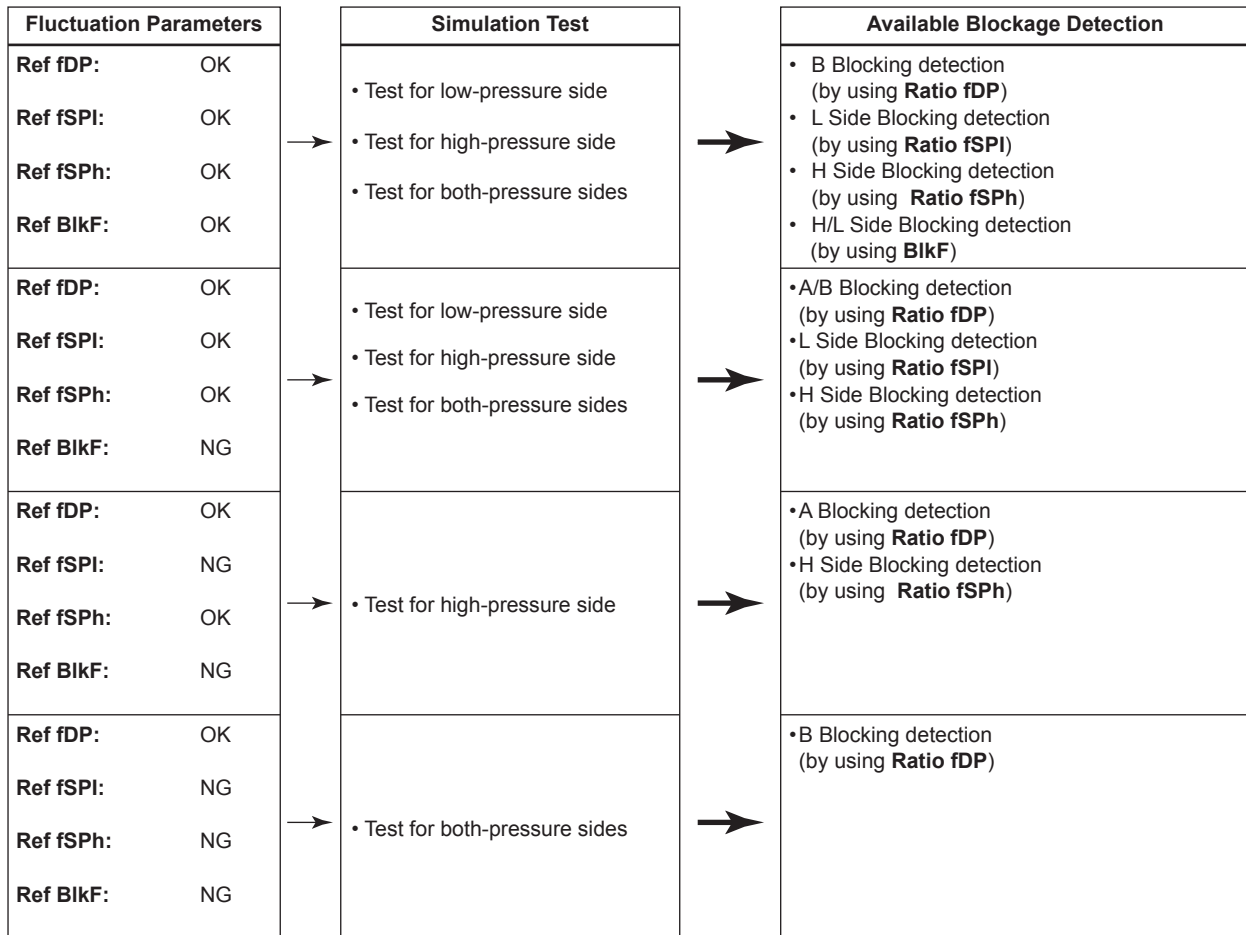

[Gauge/absolute pressure and level measurement]

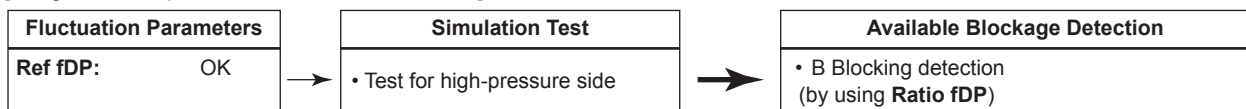

F0405.ai

4.2.2.3 Operation Parameters

■ Diag Mode

Diag Mode gives the directive for the ILBD operation. There are following three modes.

- Procedure to call up the display

DD and DTM (excluding EJJ_HART 5[1.2])	[Root Menu] → Diag/Service → Diag Parameters → ILBD Parameters → Configuration → Set Diag Mode →
EJJ_HART 5[1.2] DTM	Diag and Service → Advanced Diag Configurations → Impulse Line Blockage Detection → Diag Mode →

Diag Mode

Mode	Function
Stop	The blockage detection operation is stopped.
Calculation	The blockage detection operation is performed. Alarms are generated along with the result.
Reference	Reference values for the blockage detection are obtained and updated to the latest. After sampling reference values, this mode changes to "Calculation".

When the blockage detection operation is performed, set "Calculation" to **Diag Mode**. "Stop" must be set when you change a threshold value or set an alarm. "Reference" is set in order to obtain the reference fluctuation values under the normal configuration.



NOTE

When setting ILBD parameters in the transmitter via “Online Parameter” of the EJX HART 5 DTM based on FDT1.2 menu, Diag Mode automatically changes to 0 (Stop). After the setting, Diag Mode automatically returns to the original value.



NOTE

When setting ILBD parameters in the transmitter via “Download to device” of the EJX HART 5 DTM based on FDT1.2 menu, Diag Mode automatically changes to 0 (Stop).

Diag Period

The values such as **Ratio fDP** and **BlkF** are averaged based on several hundreds of pressure fluctuation values in constant time. **Diag Period** defines the sampling time is. The default value at the shipment is set to 180 seconds.

- Procedure to call up the display

DD and DTM (excluding EJX_HART 5[1.2])	[Root Menu] → Diag/Service → Diag Parameters → ILBD Parameters → Configuration → Diag Period →
EJX_HART 5[1.2] DTM	Diag and Service → Advanced Diag Configurations → Impulse Line Blockage Detection → Diag Period →

For the information on how to change the sampling period, refer to subsection 4.2.2.10.

Diag Supp Count

When the value as **Ratio fDP** or **BlkF** exceeds the threshold value for several times in a row, it is estimated that the impulse line is plugged.

Diag Supp Count defines the number of times to estimate blockage detection.

- Procedure to call up the display

DD and DTM (excluding EJX_HART 5[1.2])	[Root Menu] → Diag/Service → Diag Parameters → ILBD Parameters → Configuration → Diag Supp Count →
EJX_HART 5[1.2] DTM	Diag and Service → Advanced Diag Configurations → Impulse Line Blockage Detection → Threshold → Diag Suppress Count →

If **Diag Supp Count** is set to three times, an alarm is not generated at part 'A' in Figure 4.4. Because the first and second values only exceeded consecutively the threshold.

When the value exceeds consecutively the threshold value three times, an alarm is generated (see part 'B' in Figure 4.4).

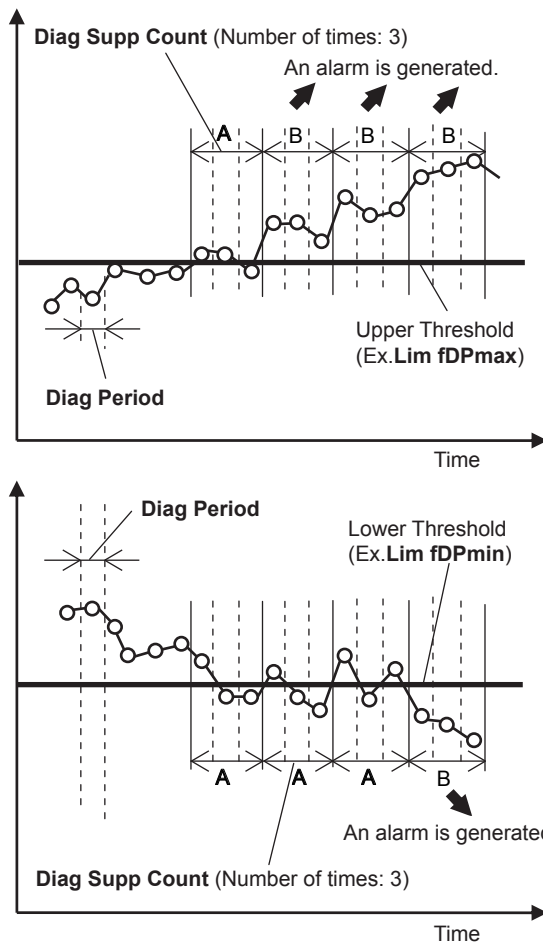

Figure 4.4 Relationship of Diag Supp Count and Alarm

The number of detection to give an alarm is set for each blockage detection function. The default value at the shipment is set to three times.

If fluctuating around the threshold value, an alarm may be often generated. In this case, change the threshold value (Limit parameter) or the sampling time (**Diag Period**) to enhance the accuracy of the blockage detection. Refer to subsection 4.2.2.10.

4.2.2.4 Operating Procedure

The basic flow of the ILBD operation is as follows.

- 1) Initial setting
- 2) Condition check
- 3) Start up
- 4) Perform the ILBD algorithm.

If an alarm is often generated or the process condition changed in the ILBD operation, do tuning to change the alarm setting, or to reset the reference values.

Fill out the information to the checklist, at the process shown in below figure.
(Refer to the Appendix 1. ILBD Check List)

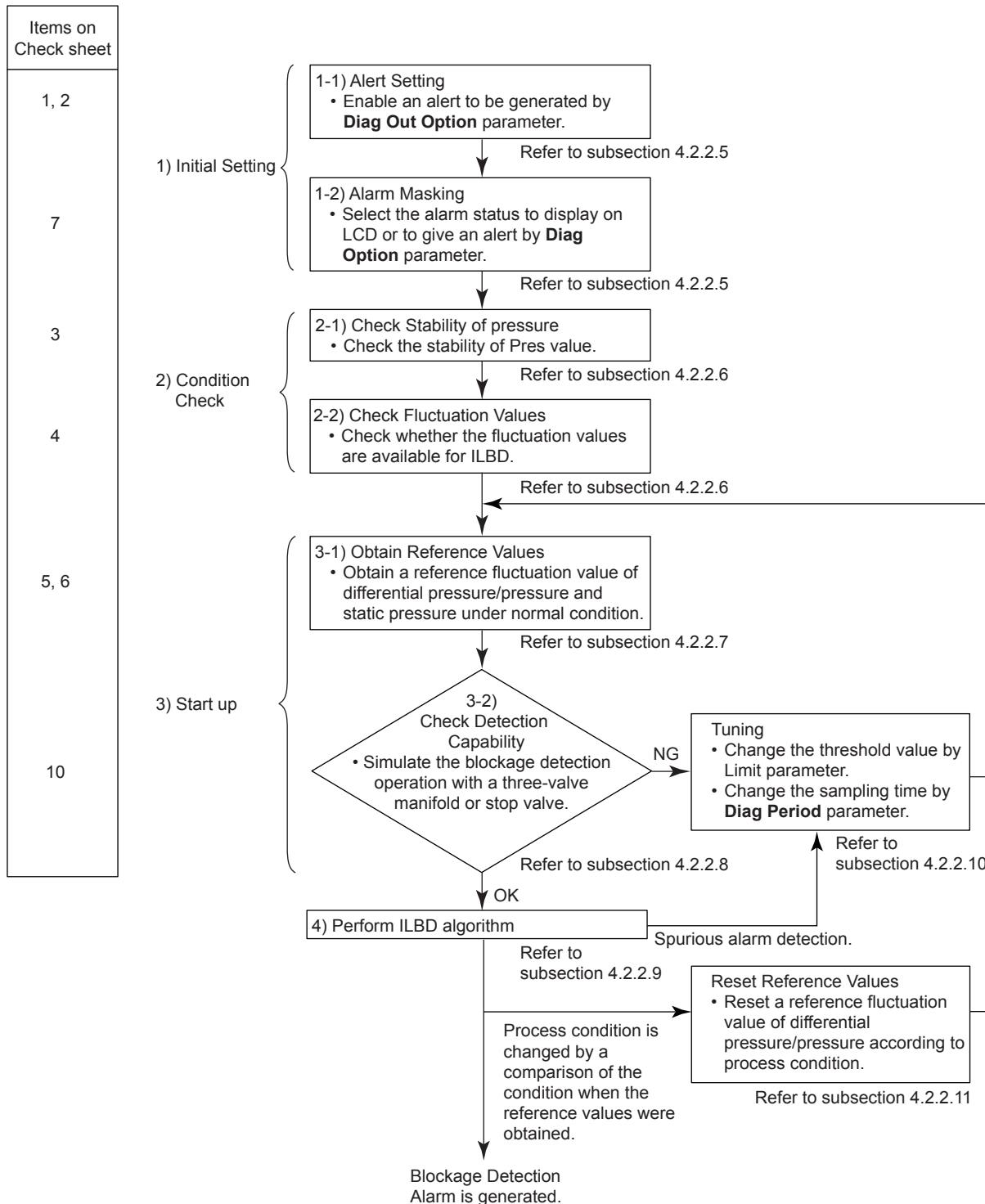

Figure 4.5 Flow Chart of ILBD Operation

F0407.ai

4.2.2.5 Alarm and Alert Setting

The abnormal results as the blockage detection and high/low flange temperature (heat trace monitoring) are given through an analog alert or the LCD display of alarm status. Before performing the ILBD operation, it is necessary to set the alarm and alert according to the following procedure.

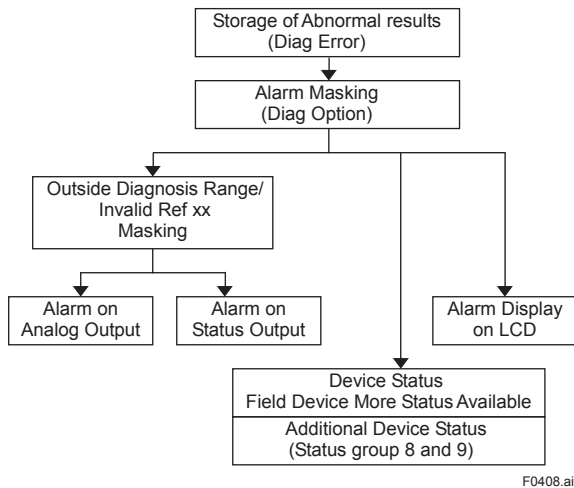

Figure 4.6 Alarm and Alert Setting

■ Alarm Status

When the algorithm of ILBD and Heat trace monitoring detect the abnormality, the result is stored in **Diag Error**. The alarm status based on the detected abnormality is displayed to **Diag Error**.

(Displayed to **Impulse Line Blockage Detection** and **Heat Trace** for DTM(HART 5))

- Procedure to call up the display

DD and DTM (excluding EJX_HART 5[1.2])	[Root Menu] → Diag/Service → Diag Parameters → Diag Error →
EJX_HART 5[1.2] DTM	Diag and Service → Advanced Diag Alerts → Diag Error

Bit	DD (HART 5/HART 7) DTM (HART 7)	DTM (HART 5)	Category
0	Not used	Not used	
1	Not used	Not used	
2	A Blocking	A Blocking	ILBD
3	Large Fluct L	Large Fluctuation of Low Side	
4	Large Fluct H	Large Fluctuation of High Side	
5	L Side Blocking	Low Side Blocking	
6	H Side Blocking	High Side Blocking	
7	B Blocking	B Blocking	
8	Invalid Ref F	Invalid Ref BIKF	
9	Invalid Ref SPH	Invalid Ref fSPH	
10	Invalid Ref SPL	Invalid Ref fSPI	
11	Invalid Ref DP	Invalid Ref fDP	
12	ILBD over range	Outside Diagnosis Range	
13	FT low alarm	Flg Temp Low Alarm	Heat trace monitoring
14	FT high alarm	Flg Temp High Alarm	
15	Not used	Not used	

Note: FT indicates the flange temperature.

● ILBD over range (Outside Diagnosis Range)

- Procedure to call up the display

DD and DTM (excluding EJX_HART 5[1.2])	[Root Menu] → Diag/Service → Diag Parameters → ILBD Parameters → Configuration → Diag Lim →
EJX_HART 5[1.2] DTM	Diag and Service → Advanced Diag Configurations → Impulse Line Blockage Detection → Threshold →

1) Lim DPavgmax

Lim DPavgmax is the upper limit of the diagnostic capability range. The limit value can be changed when **Diag Mode** is "Stop".

DPavg indicates the ratio of the average of differential pressure to the EJX maximum span regarded as 1. When **DPavg** exceeds this limit, "ILBD over range" is generated so that the blockage detection becomes impossible.

2) Lim DPavgmin

Lim DPavgmin is the lower limit of the diagnostic capability range. The limit value can be changed when **Diag Mode** is "Stop".

When **DPavg** is below this limit, "ILBD over range" is generated so that the blockage detection becomes impossible.

<Example>

When the level range that can be measured by the transmitter with 100 kPa span is -80 to 80 kPa, the limits are set as follows.

- **Lim DPAvgmax**: 0.80
- **Lim DPAvgmin**: -0.80

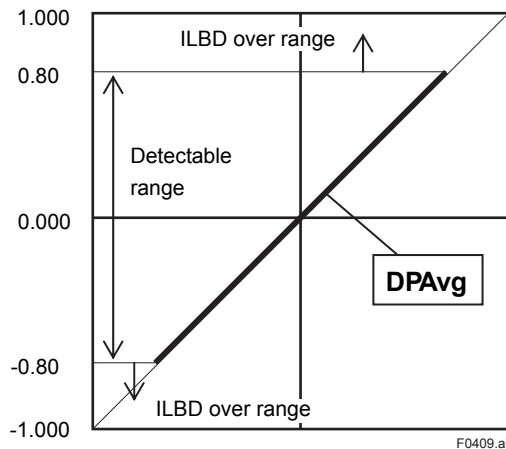

● **Invalid Ref F, SPH, SPL, or DP**

This alarm indicates that the reference value under normal condition is invalid. If **Ref F** is invalid, the blockage detection excluding **BikF** is carried out. If blockage detection function based on **BikF** is required, obtain the reference value again.

Also when **Ref DPAvg** is below **Lim DPAvgmin** or exceeds **Lim DPAvgmax**, all reference value becomes invalid so that “Invalid Ref DP”, “Invalid Ref SPL”, “Invalid Ref SPH”, and “Invalid Ref F” are generated.

■ **Alarm Masking**

● **Diag Option**

The alarms linked to an analog alert and LCD display are selected by **Diag Option**.

- Procedure to call up the display

DD and DTM (excluding EJJ_HART 5[1.2])	[Root Menu] → Diag/Service → Diag Parameters → Diag Option →
EJJ_HART 5 [1.2] DTM	Diag and Service → Advanced Diag Configurations → Impulse Line Blockage Detection → Diag Option →

The bit of **Diag Option** is corresponding to that of **Diag Error**. The following alarms are set at the factory setting, which is corresponding to hexadecimal 0x08FC.

DD (HART 5/HART 7) DTM (HART 7)	DTM (HART 5)
A Blocking	A Blocking
Large Fluct L	Large Fluctuation of Low Side
Large Fluct H	Large Fluctuation of High Side
L Side Blocking	Low Side Blocking
H Side Blocking	High Side Blocking
B Blocking	B Blocking
Invalid Ref DP	Invalid Ref fDP

To Link the alarm to an analog alert and LCD display, follow the procedure below.

- 1) Set “Stop” to **Diag Mode**.
- 2) Check each checkbox of the alarm, which is selectable from bit 2 to 14.

Note: Set to “Calculation” after setting the parameter.

■ **Alert Setting**

● **Diag Out Option**

When an alert regarding the impulse line blockage or high/low flange temperature is generated, the output value of 4-20 mA analog signal can be changed.

Mode	Function
Off	Keeping PV measurement. The alert is not reflected to 4-20 mA analog signal.
Burnout	The analog signal is shifted to the value of AO upper limit or AO lower limit when an alert is generated. The shifted direction follows Burnout switch setting.
Fall back	The analog signal is hold to the specific value, Diag Fixed Out Val , when an alert is generated.

- Procedure to call up the display

DD and DTM (excluding EJJ_HART 5[1.2])	[Root Menu] → Diag/Service → Diag Parameters → Diag Output → Diag Out Option →
EJJ_HART 5 [1.2] DTM	Diag and Service → Advanced Diag Configurations → Diag Out Option →

■ **Diag Fixed Out Val**

This parameter is used when “Fall back” is selected to **Diag Output Option**.

When an alert is generated, the 4-20 mA analog signal is held on the value specified by this parameter.

The value can be entered within 3.6 to 21.6 mA.

- Procedure to call up the display

DD and DTM (excluding EJJ_HART 5[1.2])	[Root Menu] → Diag/Service → Diag Parameters → Diag Output → Diag Fixed Out Val →
EJJ_HART 5[1.2] DTM	Diag and Service → Advanced Diag Configurations → Diag Fixed Out Val →

● **Status Output for Advanced diagnostic**

The output of the abnormal results are applicable for a transistor output (open collector) of an on/off signal according to the status of high and low alarm limits, which are values set to Limit parameters as shown in subsection 4.2.2.1. About the **Flg Temp Hi Alert Val**, or **Flg Temp Lo Alert Val** for Heat trace monitoring, refer to subsection 4.2.3.2.

■ **DO Select**

If the advanced diagnostic function is installed, the following modes can be also assigned to the status output in addition to Pres, SP and Temp.

Mode	Function
Diag Alarm	The status regarding advanced diagnostic masked by Diag Option is output.
All	All status of Press, SP, Temp and advanced diagnostic are output.

■ **Alarm Display on LCD**

If the ILBD algorithm detects the abnormality, the content of the detected result is displayed with “AL.88” or “AL.89” on the LCD. “AL.88” indicates that condition is not applicable for the abnormality detection and “AL.89” indicates the abnormality is detected.

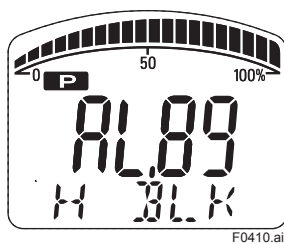

Figure 4.7 Display Example of H Side Blocking

The alarm display on LCD regarding the advanced diagnostic is described in Table 4.5.



NOTE

The alarms of “Invalid Ref xx” and “ILBD over range” do not link to the 4-20 mA analog signal and Status output.

4.2.2.6 Condition Check

After the transmitter was installed, it is necessary to confirm if **Pres** is stable under the normal operating condition or if fluctuation amplitude under the normal operating condition is large enough to detect the blockage.

■ **Stability of Pressure Value**

- 1) Observe the value change of **Pres** under the normal operating condition for 10 minutes.
- 2) Confirm the value change is less than 10%.

- Procedure to call up the display

DD and DTM (excluding EJJ_HART 5[1.2])	[Root Menu] → Detailed setup → Sensors → Pressure Sensor → Pres
EJJ_HART 5[1.2] DTM	Configuration → Process Input → Pres

If the value change is more than 10%, the error influences pressure fluctuation value so that the blockage detection becomes impossible. Consider the plant operating conditions.

■ **Fluctuation Value**



NOTE

The blockage detection may not be carried out correctly when pressure fluctuation amplitude especially with the pressure and level measurement, is small.

Confirm that each value of **fDP**, **fSPI**, **fSPH**, and **BlkF** is more than the value specified in the below table.

- Procedure to call up the **fDP**, **fSPI**, **fSPH** display

DD and DTM (excluding EJJ_HART 5[1.2])	[Root Menu] → Diag/Service → Diag Parameters → ILBD parameters → Status → Fluct Variables → fDP/fSPI/fSPH
EJJ_HART 5[1.2] DTM	Diag and Service → Advanced Diag Variables → fDP/fSPI/fSPH

- Procedure to call up the **BlkF** display

DD and DTM (excluding EJJ_HART 5[1.2])	[Root Menu] → Diag/Service → Diag Parameters → ILBD parameters → Status → Diag Variables → BlkF
EJJ_HART 5[1.2] DTM	Diag and Service → Advanced Diag Variables → BlkF

Table 4.4 Requirements to apply ILBD

	Condition
fDP	7×10^{-10} or more
fSPI	1×10^{-10} or more
fSPh	1×10^{-10} or more
BlkF	-0.5 to 0.5

● **fDP is not enough.**

No blockage can be detected if **fDP** is not larger than the specified value.

● **Only fDP is enough.**

“A Blocking” or “B Blocking” can be detected if **fSPI** and **fSPh** are not larger than specified values.

● **fDP and fSPI are enough.**

“H Side Blocking” and “Large Fluct H” can not be detected if **fSPh** is not larger than specified value.

● **fDP and fSPh are enough.**

“L Side Blocking” and “Large Fluct L” can not be detected if **fSPI** is not larger than specified value.

● **fDP, fSPI and fSPh are enough.**

All alarm modes can be detected even if **BlkF** is not within the specified values.

4.2.2.7 Obtain Reference Values

The pressure fluctuation values are reduced when the impulse line is plugged. Therefore, the reference value is required to determine the degree of reduction.



IMPORTANT

- If the impulse line is about to be plugged at the time when a reference value is obtained, blockages cannot be detected accurately. The impulse lines on both the high-pressure and low-pressure sides need to be cleaned before a reference value is obtained.
- All air bubbles need to be adequately purged before a reference value is obtained.
- Reference values must be obtained under operating condition.

■ **Start of Sampling**

The sampling of reference value is carried out for 180 seconds, which is the default value set to **Diag Period**.

- 1) Confirm that the sampling period (**Diag Period**) is set to 180 seconds.
- 2) Set “Reference” to **Diag Mode**.
The sampling starts soon after the setting.



IMPORTANT

- For the each parameter, the one value is given. If Reference is set to **Diag Mode** again, the value is updated and overwritten.
- If the power supply is shut down during the sampling, **Diag Mode** becomes “Stop”. Set “Reference” to **Diag Mode** in order to carry out the sampling again.

■ **End of Sampling**

After about 180 seconds, the sampling automatically finishes. The “Reference” setting of **Diag Mode** moves automatically to “Calculation”.

Confirm that the setting of **Diag Mode** moves to “Calculation”.

■ **Reference Values**

Confirm the latest values are obtained into the following parameters.

- Ref fDP
- Ref fSPI
- Ref fSPh
- Ref BlkF
- Ref DPavg

- Procedure to call up the display

DD and DTM (excluding EJJ_HART 5[1.2])	[Root Menu] → Diag/Service → Diag Parameters → ILBD parameters → Status → Diag Reference → Ref fDP/Ref fSPI/Ref fSPh/Ref BlkF/Ref DPavg
EJJ_HART 5[1.2] DTM	Diag and Service → Advanced Diag Configuration → Impulse Line Blockage Detection → Ref fDP/Ref fSPI/Ref fSPh/Ref BlkF/Ref DPavg

■ Invalid Ref F, SPH, SPL, or DP

When the enough reference fluctuation value is not obtained, an alarm of invalid reference value for each parameter is generated and also the ILBD operation is not carried out.

Confirm the alarm of **Invalid Ref F, SPH, SPL, or DP** is not displayed in **Diag Error**.

If an alarm of **Invalid Ref F, SPH, SPL, or DP** is generated, consider the process condition or obtain the reference fluctuation values again.



NOTE

Even if an alarm of **Invalid Ref F, SPH, SPL, or DP** is generated, "Calculation" in **Diag Mode** is kept.

4.2.2.8 Capability Test of Blockage Detection Operation

Before performing the ILBD operation, check the capability of the blockage detection operation. The simulation test is performed by closing motion of a three-valve manifold or stop valve. When simulated blockage occurs, confirm that an alarm is generated.



NOTE

The fluctuation amplitude of atmospheric pressure is nearly zero with pressure or level measurement. In such case, simulate the blockage detection by closing the valve where the fluctuation existed.

■ Simulation of High-pressure Side Blockage

- 1) Close the high-pressure-side valve.
- 2) Confirm the value of **Pres** is stable. If not, open the valve a little.
- 3) Set "Calculation" to **Diag Mode** so as to start blockage detection operation.
- 4) Check that an alarm of "H Side Blocking" is generated after the time that consists of **Diag Period** and **Diag Supp Count** passed.
- 5) Check also the operation of the analog alert if an analog alert is set.
- 6) Open the valve completely and check that there are no alarms.

■ Simulation of Low-pressure Side Blockage

- 1) Close the low-pressure-side valve.
- 2) Confirm the value of **Pres** is stable. If not, open the valve a little.
- 3) Set "Calculation" to **Diag Mode** so as to start blockage detection operation.
- 4) Check that an alarm of "L Side Blocking" is generated after the time that consists of **Diag Period** and **Diag Supp Count** passed.
- 5) Check also the operation of the analog alert if an analog alert is set.
- 6) Open the valve completely and check that there are no alarms.

■ Simulation of Both-pressure Side Blockage

- 1) Close the both-pressure-side valves.
- 2) Confirm the value of **Pres** is stable. If not, open the valve a little.
- 3) Set "Calculation" to **Diag Mode** so as to start blockage detection operation.
- 4) Check that an alarm of "B Blocking" is generated in the **Diag Error** after the time that consists of **Diag Period** and **Diag Supp Count** passed.
- 5) Check also the operation of the analog alert if an analog alert is set.
- 6) Open the valve completely and check that there are no alarms.

4.2.2.9 Start ILBD Operation

If process condition and capability to detect a blockage are confirmed, you can start the ILBD operation according to the following procedure.

- 1) Check the value of sampling period (**Diag Period**).
- 2) Check the number of times that detect the blockage consecutively in order to give an alarm (**Diag Supp Count**). The default value at the shipment is set to 3 times.
- 3) Set "Calculation" to **Diag Mode**.
If the reference value has not yet been obtained, set "Reference" to **Diag Mode**. After obtained the reference values, the ILBD starts automatically. At the same time, **Diag Mode** changes automatically from "Reference" to "Calculation".

4.2.2.10 Tuning

When the pressure fluctuation amplitude in fluids is not sufficiently large or an alarm is often generated according to the process condition, tune up by changing the threshold for the blockage detection (Limit parameters) or the sampling period (**Diag Period**) to enhance the accuracy of the blockage detection. The ILBD operation must be stopped to tune up. Set "Stop" to **Diag Mode**.

■ Threshold Value

The figure below shows the image of tuning effect with a monochrome bar.

- (a) The tuning image of the threshold values for
 - (1) **Ratio fDP**: $\text{Sqrt}(\text{fDP}/\text{Ref fDP})$,
 - (2) **Ratio fSPI**: $\text{Sqrt}(\text{fSPI}/\text{Ref fSPI})$,
 - (3) **Ratio fSPH**: $\text{Sqrt}(\text{fSPH}/\text{Ref fSPH})$

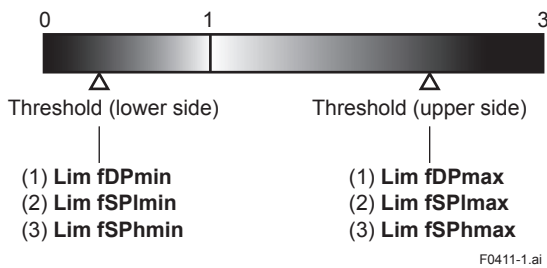

- (b) The tuning image of the threshold values for
 - (4) $\text{Sqrt}(\text{BlkF}/\text{Ref BlkF})$

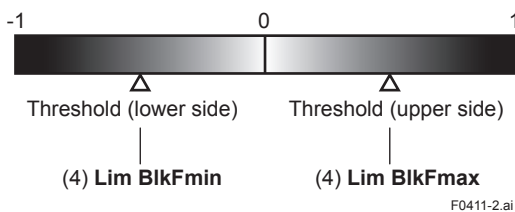

Figure 4.8 Tuning Image of Threshold Value

● Move the threshold toward the white.

- It becomes increasingly likely to give a false alarm due to the disturbance from environment change.
- If flow/differential pressure is below **Lim DPAvgmin** or exceeds **Lim DPAvgmax**, pressure fluctuation is likely too small or too large to detect the blockage.

● Move the threshold toward the black.

- It enables to be insusceptible to disturbance such as environment change and to detect the blockage easier.
- It becomes giving an alarm of the blockage after the blockage has been progressed.

(1) Setting by DD and DTM (excluding EJX HART 5 DTM based on FDT1.2)

- Procedure to call up the **threshold** related display

DD and DTM (excluding EJX_HART 5[1.2])	[Root Menu] → Diag/Service → Diag Parameters → ILBD parameters → Configuration → Diag Lim →
--	---

The default values at the factory setting are the values of **Lim fDPmax** to **Lim BlkFmin** shown in Table 4.3.

Change the threshold value to solve your problem according to the above image.

- 1) Set "Stop" to **Set Diag Mode**.
- 2) Change the unsuitable value of **Diag Lim** parameters corresponding to the each blockage detection.

Note: Set to "Calculation" after setting the parameter.

Limit parameter

#	Parameter	Threshold value
[1]	Lim fDPmax	Threshold to detect "A Blocking" by using Ratio fDP
[2]	Lim fDPmin	Threshold to detect "B Blocking" by using Ratio fDP
[3]	Lim fSPImax	Threshold to detect "Large Fluct L" by using Ratio fSPI
[4]	Lim fSPmin	Threshold to detect "L Side Blocking" by using Ratio fSPI
[5]	Lim fSPHmax	Threshold to detect "Large Fluct H" by using Ratio fSPH
[6]	Lim fSPHmin	Threshold to detect "H Side Blocking" by using Ratio fSPH
[7]	Lim BlkFmax	Threshold to detect "H Side Blocking" by using BlkF
[8]	Lim BlkFmin	Threshold to detect "L Side Blocking" by using BlkF

(2) Setting by EJX HART 5 DTM based on FDT1.2

Combination of threshold depend on the sensitivity of blockage detection can be selected from High, Medium, or Low in the **Sensitivity** parameter.

- Procedure to call up the display

EJX HART 5 DTM based on FDT1.2	Diag and Service → Advanced Diag Configuration → Impulse Line Blockage Detection → Threshold → sensitivity
--------------------------------	--

When select "Custom" in the Sensitivity parameter, you can set each threshold individually.

Set the **Diag Mode** to "Stop" before changing the threshold.

Combination of threshold for sensitivity parameter

	High	Medium	Low
Lim fDPmax	1.50	3.00	3.00
Lim fDPmin	0.40	0.30	0.20
Lim fSPImax	5.00	5.00	5.00
Lim fSPImin	0.50	0.50	0.30
Lim fSPPhmax	5.00	5.00	5.00
Lim fSPPhmin	0.50	0.50	0.30
Lim BlkFmax	0.60	0.60	0.80
Lim BlkFmin	-0.60	-0.60	-0.80

■ **Sampling Period**

If fluctuating around the threshold value, an alarm maybe often generated. When the above phenomenon happens, the sampling time (**Diag Period**) can be changed so as to enhance the accuracy of the blockage detection.

The longer the sampling time, better the expected accuracy.

- (1) Set "Stop" to **Diag Mode**.
- (2) Enter the value to **Diag Period** within the range of 20 to 65535 (seconds).

Note: Set to "Calculation" after setting the parameter.

Also, the accuracy can be improved by increasing the number of **Diag Supp Count**.

■ **ILBD Range Setting**

If flow/differential pressure is less than the default threshold value of **Lim DPavgmin**, pressure fluctuation is not large enough to detect the blockage. To prevent the fault blockage detection, the threshold should be changed to larger value.

- (1) Set "Stop" to **Diag Mode**.
- (2) Enter the value to **Lim DPavgmin** or **Lim DPavgmax**.

Note Set to "Calculation" after setting the parameter.

- Procedure to call up the **threshold** display

DD and DTM (excluding EJJ_HART 5[1.2])	[Root Menu] → Diag/Service → Diag Parameters → ILBD parameters → Configuration → Diag Lim →
EJJ_HART 5[1.2] DTM	Diag and Service → Advanced Diag Configuration → Impulse Line Blockage Detection → Threshold →

■ **Ratio fDP Compensation**

When the flow change is too large or small, an alarm maybe often generated. When the above case happens, the Ratio fDP can be compensated so as to enhance the accuracy of the blockage detection.

● **Diag DPComp**

When "Compensation" is selected in **Diag DPComp**, **Ratio fDP** is compensated by following formula and used as treatable monitoring value, **CRatio fDP**.

$$CRatio\ fDP = \sqrt{\frac{fDP}{Ref\ fDP}} \times \left| \frac{Ref\ DPavg}{DPavg} \right|$$

On the other hand, if the compensation is not necessary, "Non-compensation" is selected in **Diag DPComp** and **Ratio fDP** is used as **NRatio fDP**.

$$NRatio\ fDP = \sqrt{\frac{fDP}{Ref\ fDP}}$$

- Procedure to call up the display

DD and DTM (excluding EJJ_HART 5[1.2])	[Root Menu] → Diag/Service → Diag Parameters → ILBD parameters → Status → Diag Variables → CRatio fDP/NRatio fDP
EJJ_HART 5[1.2] DTM	Diag and Service → Advanced Diag Variables → CRatio fDP/NRatio fDP

4.2.2.11 **Reset of Reference Value**

When there are large flow change or the change of fluid conditions, obtain the reference value again. If flow change by a comparison of the reference value is ±25% or more, obtain the reference value again.

4.2.2.12 ILBD Parameter List

#	Parameter name	Default value	Explanation
1	Diag Error	0x0000	The results detected by ILBD or Heat trace monitoring are stored into this parameter. Also the condition abnormality in the diagnostic process is stored as an error.
2	Diag Option	0x08FC	The masking in this parameter enable to display each error message and the status to the output signal or LCD. The error assigned to each bit is corresponding to that of Diag Error . Writable only when Diag Mode is "Stop".
3	Diag Out Option	Off	Output mode of 4-20mA when an advanced diagnostic alarm is generated. There are following three output modes; Off, Burnout, or Fall back.
4	Diag Fixed Out Val	21.6 mA	Parameter for "Fall back" function in the Diag Out option. The output value of 4-20 mA analog signal is specified when an alarm is generated. The value can be entered within 3.6 to 21.6 mA.
5	DO Select	Off	The variables for status output are specified to this parameter. When the advanced diagnostic function (option code /DG6) is installed, the parameters monitoring in diagnostic process can be also assigned to the status output.
6	Diag Mode	Stop	The operation mode of ILBD is set. Stop: The blockage detection is stopped. Calculate: The blockage detection is carried out. The alarms are generated along with the detected result. Reference: The reference values are obtained and the update values are overwritten. After setting, this mode moves automatically to "Calculation".
7	Diag Period	180 (s)	The data acquisition period for ILBD is set within 20 to 65535 (s). If the process fluctuation values are unsteady, this value is changed to the longer to enhance the accuracy of the blockage detection. Writable only when Diag Mode is "Stop".
8	Diag Supp Count	3	Detection count to generate an alarm. When the statistical value as Ratio fDP and BlkF exceeds consecutively the threshold by number of times preset to this parameter, it is estimated that the impulse line is plugged.
9	Diag Description		Memo field. 32 alphanumeric
10	fDP		Average value of the sum of squares of differential pressure fluctuation.
11	fDP Status		Status of fDP
12	fSPI		Average value of the sum of squares of low-pressure-side static pressure fluctuation. For gauge/absolute pressure transmitter, 0 is set.
13	fSPI Status		Status of fSPI
14	fSPh		Average value of the sum of squares of high-pressure-side static pressure fluctuation. For gauge/absolute pressure transmitter, 0 is set.
15	fSPh Status		Status of fSPh
16	BlkF		Blockage degree characterized in comparison of high- and low-pressure side pressure fluctuation value.
17	BlkF Status		Status of BlkF
18	DPAvg		Ratio of the average of differential pressure/pressure to the maximum span of an EJX transmitter.
19	DPAvg Status		Status of DPAvg
20	Ratio fDP		CRatio fDP or NRatio fDP is used by Diag Comp setting. fDP decreases and this parameter is used to determine whether one or both sides are plugged.
21	Ratio fDP Status		Status of Ratio fDP
22	Ratio fSPI		SQRT (fSPI/Ref fSPI). fSPI decreases and this parameter is used to determine whether low-pressure-side is plugged.
23	Ratio fSPI Status		Status of Ratio fSPI
24	Ratio fSPh		SQRT (fSPh/Ref fSPh). fSPh decreases and this parameter is used to determine whether high-pressure-side is plugged.
25	Ratio fSPh Status		Status of Ratio fSPh
26	Ref fDP		Value of fDP obtained under normal condition.
27	Ref fDP Status		Status of fDP obtained under normal condition.

#	Parameter name	Default value	Explanation
28	Ref fSPI		Value of fSPI obtained under normal condition.
29	Ref fSPI Status		Status of fSPI obtained under normal condition.
30	Ref fSPh		Value of fSPh obtained under normal condition.
31	Ref fSPh Status		Status of fSPh obtained under normal condition.
32	Ref BlkF		Value of BlkF obtained under normal condition.
33	Ref BlkF Status		Status of BlkF obtained under normal condition.
34	Ref DPAvg		Value of DPAvg obtained under normal condition.
35	Ref DPAvg Status		Status of DPAvg obtained under normal condition.
36	Lim fDPmax	Refer to Table 4.3	Upper limit for Ratio fDP to detect the blockage. Writable only when Diag Mode is "Stop".
37	Lim fDPmin		Lower limit for Ratio fDP to detect the blockage. Writable only when Diag Mode is "Stop".
38	Lim fSPImax		Upper limit for Ratio fSPI to detect the blockage. Writable only when Diag Mode is "Stop".
39	Lim fSPImin		Lower limit for Ratio fSPI to detect the blockage. Writable only when Diag Mode is "Stop".
40	Lim fSPhmax		Upper limit for Ratio fSPh to detect the blockage. Writable only when Diag Mode is "Stop".
41	Lim fSPhmin		Lower limit for Ratio fSPh to detect the blockage. Writable only when Diag Mode is "Stop".
42	Lim BlkFmax		Upper limit for BlkF to detect the blockage. Writable only when Diag Mode is "Stop".
43	Lim BlkFmin		Lower limit for BlkF to detect the blockage. Writable only when Diag Mode is "Stop".
44	Lim DPAvgmax		Upper limit for DPAvg . Writable only when Diag Mode is "Stop".
45	Lim DPAvgmin		Lower limit for DPAvg . Writable only when Diag Mode is "Stop".
46	Ref Lim fDPmin	7.0E-10	Lower limit to judge whether Ref fDP is available for ILBD operation. Writable only when Diag Mode is "Stop".
47	Ref Lim fSPmin	1.0E-10	Lower limit to judge whether Ref fSPI and Ref fSPh are available for ILBD operation. Writable only when Diag Mode is "Stop".
48	Ref Lim BlkFmax	0.5	Upper limit to judge whether Ref BlkF is available for ILBD operation. Writable only when Diag Mode is "Stop".
49	Status group 8		Refer to Table 4.5.
50	Status group 9		Refer to Table 4.5.
51	CRatio fDP		Ratio fDP is compensated by following formula and used as treatable monitoring value when the flow change is too large or small. $\text{Sqrt}(\text{fDP} / \text{Ref fDP}) \times \text{Ref DPAvg} / \text{DPAvg} $ When compensation is selected in Diag DP Comp , CRatio fDP is used as monitoring value.
52	CRatio fDP Status		Status of CRatio fDP
53	NRatio fDP		When Non-compensation is selected in Diag DP Comp , NRatio fDP is used as monitoring value. $\text{NRatio fDP} = \text{Sqrt}(\text{fDP} / \text{Ref fDP})$
54	NRatio fDP Status		Status of NRatio fDP
55	Diag DPComp	0: Compensation	Whether fDP is referred by CRatio fDP or NRatio fDP is selected.
56	Diag Applicable		After the reference value is obtained, the applicable blockage detection is displayed on this parameter.

4.2.3 Heat Trace Monitoring

The transmitter with Heat trace monitoring function calculates the flange temperature by using the two temperature sensors built in the transmitter.

An analog alert is generated if the temperature reached to the preset level.

The flange temperature is based on the following parameters and calculation formula.

[Parameters]

Parameter name	Explanation
Snsr temp (CT)	Measured capsule temperature value
Amp temp (AT)	Measured amplifier temperature value
Flg temp (FT)	Flange temperature value (Calculated value)
Flg Temp Coef (Cf)	Coefficient to calculate flange temperature
Flg Temp Hi Alert Val	Threshold to generate FT high alarm
Flg Temp Lo Alert Val	Threshold to generate FT low alarm

[Calculation formula]

Flg temp (FT) = CT + Cf X (CT-AT)

If the flange temperature exceeds the value preset to **Flg Temp Hi Alert Val** or **Flg Temp Lo Alert Val**, an alert is generated.



The flange temperature is calculated by the calculation formula assumed that the capsule part of the transmitter is heated up or kept warm by an electrical heater or steam. In the case of an atmosphere temperature or less, the difference of temperature of approximately 3 to 4 °C, may occur because the amplifier temperature becomes higher than the capsule temperature.

4.2.3.1 Flg Temp Coef Setting

The value calculated according to the following procedure is set to **Flg Temp Coef**.

- To enhance the calculation accuracy of the flange temperature, measure the actual flange temperature by using the temperature sensor etc.
- Calculate the ratio of the capsule temperature to the capsule temperature minus the amplifier temperature from the two temperature values measured by the transmitter.
- Derive the **Flg Temp Coef** from the measured flange temperature and the ratio of the capsule temperature to the amplifier temperature in accordance with the following calculation formula.

Flg Temp Coef (Cf) =

$$\frac{(\text{Actual measured value of Flange temperature}) - CT}{CT - AT}$$

For DTM (HART 5), Flg Temp Coef parameter can be set by using Tuning function.

By setting the measured value of flange temperature, Flg Temp Coef is calculated by using capsule temperature and amplifier temperature.

- Procedure to call up the **Tuning** display.

Diag and Service → Advanced Diag Configuration → Heat Trace → Tuning

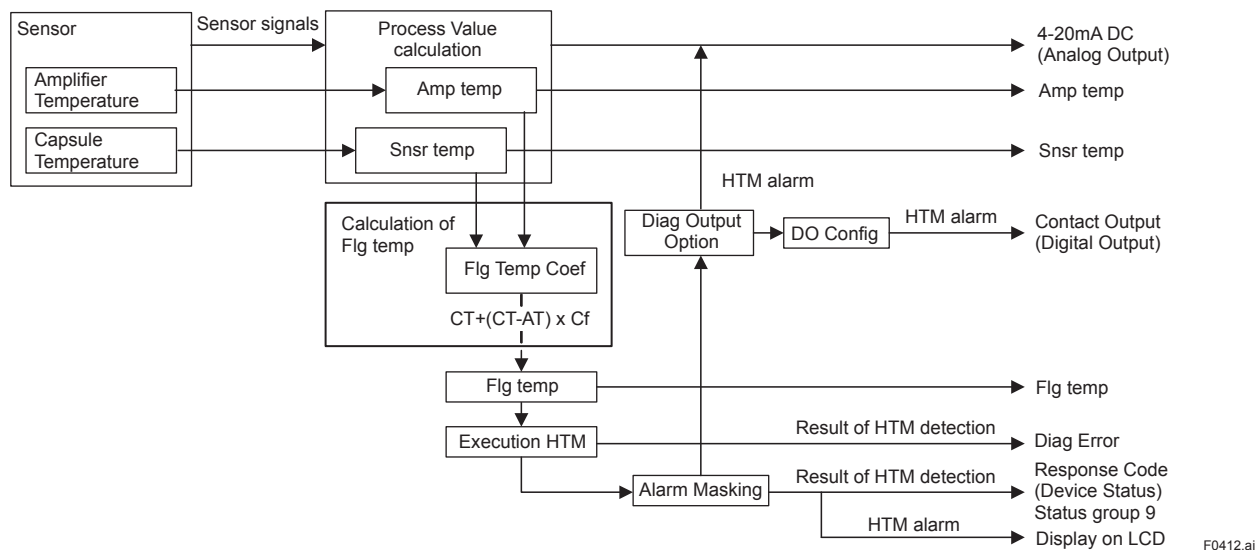
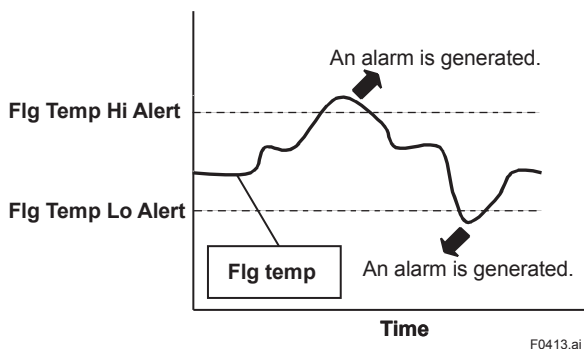

Figure 4.9 Functional Block Diagram of Heat Trace Monitoring (HTM)

4.2.3.2 Out of Temperature Measurement Range

When the flange temperature is out of measurement range, the alarm or alert is generated. For the detail of alarm and alert setting, refer to subsection 4.2.2.5.

The measurement range is set to **Flg Temp Hi Alert Val** and **Flg Temp Lo Alert Val**, which values can be specified within -50 to 130 deg C.



4.2.3.3 Parameter Lists for Heat Trace Monitoring

#	Parameter name	Default value	Explanation
1	Diag Error	0x0000	The results detected by ILBD or Heat trace monitoring are stored into this parameter. Also the condition abnormality in the diagnostic process is stored as an error.
2	Diag Option	0x08FC	The masking in this parameter enable to display each error message and the status to the output signal or LCD. The error assigned to each bit is corresponding to that of Diag Error. Writable only when Diag Mode is "Stop".
3	Diag Out Option	Off	The error status can be output by 4-20 mA analog signal. There are following three output modes; Off, Burnout, or Fall back.
4	Diag Fixed Out Val	21.6mA	Parameter for "Fall back" function in the Diag Out option. The output value in 4-20 mA analog signal is specified when an alarm is generated. The value must be entered within 3.6 to 21.6 mA.
5	Snsr temp (Cap temp ^{*2})		Measured capsule temperature value
6	Amp temp		Measured Amplifier temperature value
7	Flg temp	(^{*1})	Calculated flange temperature value
8	Flg Temp Coef	0	Coefficient to calculate flange temperature (Cf: Rt_1/Rt_2) Rt_1 : Thermal resistance between the flange and capsule. Rt_2 : Thermal resistance between the capsule and amplifier.
9	Flg Temp Hi Alart Val (Flg Temp High Limit ^{*2})	120 deg C	Upper limit of Flg temp
10	Flg Temp Lo Alart Val (Flg Temp Low Limit ^{*2})	-40 deg C	Lower limit of Flg temp
11	DO Select	Off	See subsection 3.3.14 Status Output
12	DO Signal type	ON WHEN AL DETECT	See subsection 3.3.14 Status Output
13	Digital Output	Off	See subsection 3.3.14 Status Output

*1: The **Flg Temp Coef** is 0 at the shipment so that the **Flg temp** outputs the same value as that of **Snsr temp**.

*2: EJX HART 5 DTM based on FDT1.2.

4.3 Alarms and Countermeasures



Table 4.5 Alarm Message Summary

Integral indicator	NE107 (Default Value)	HART configuration tool display	Cause	4-20mA Output operation during error	Countermeasure	Status group *1	Diagnostic List group *2
AL. 01 CAP.ERR	F	P sensor error *1 Pressure Sensor Error *2	Sensor problem.	Outputs the signal (High or Low) set with burnout direction switch. [status output: undefined] (About the output signal, refer to subsection 3.3.10)	Replace capsule if the error recurs after the transmitter is restarted.	1	Hardware Failure
		CT sensor error *1 Capsule Temperature Sensor Error *2	Capsule temperature sensor problem.		Replace capsule.		
		Cap EEPROM error *1 Capsule EEPROM Error *2	Capsule EEPROM problem.				
AL. 02 AMP.ERR	F	AT sensor error *1 Amp Temp Sensor Error *2	Amplifier temperature sensor problem.		Replace amplifier.		
		Amp EEPROM error *1 Amp EEPROM Error *2	Amplifier EEPROM problem.				
		CPU board error *1 CPU Board Error *2	Amplifier problem.			2	
—	F	No device ID *1 No Device ID *2	No device ID is found.	Continues to operate and output.	Replace amplifier.	2	
AL. 10 PRESS	S	P outside limit *1 Pressure Outside Limit *2	Differential pressure is outside measurement range limit of capsule.	When PV is Pres Output AO upper limit or AO Lower limit. (Refer to subsection 3.3.2)	Check input or replace capsule when necessary.		3
AL. 11 ST. PRSS	S	SP outside limit *1 Static Pressure Outside Limit *2	Static pressure exceeds limit.	When PV is SP Output AO upper limit or AO Lower limit. (Refer to subsection 3.3.2)			
AL. 12 CAP.TMP	S	CT outside limit *1 Cap Temp Outside Limit *2	Capsule temperature is outside range (–50 to 130°C).	Continues to operate and output.	Use heat insulation or make lagging to keep temperature within range.		
AL. 13 AMP.TMP	S	AT outside limit *1 Amp Temp Outside Limit *2	Amplifier temperature is outside range (–50 to 95°C).				
AL. 30 PRS.RNG	S	P over range *1 Pressure Over Range *2	Differential pressure exceeds specified range.	When PV is Pres. Output AO upper limit or lower limit. (Refer to subsection 3.3.2)	Check input and range setting, and change them as needed.	4	Transducer Status
AL. 31 SP. RNG	S	SP over range *1 Static Pressure Over Range *2	Static pressure exceeds specified range.	When PV is SP Output AO upper limit or lower limit. (Refer to subsection 3.3.2)			
AL. 35 P.HI	N	P high alarm *1 Pressure High Alarm *2	Input pressure exceeds specified threshold.	Continues to operate and output.	Check input.	5	
AL. 36 P.LO	N	P low alarm *1 Pressure Low Alarm *2					
AL. 37 SP.HI	N	SP high alarm *1 Static Pressure High Alarm *2	Input static pressure exceeds specified threshold.				
AL. 38 SP.LO	N	SP low alarm *1 Static Pressure Low Alarm *2					

*1: DD and DTM (excluding EJV HART 5 DTM based on FDT1.2)

*2: EJV HART 5 DTM based on FDT1.2

*3: Available only for HART 7

Integral indicator	NE107 (Default Value)	HART configuration tool display	Cause	4-20mA Output operation during error	Countermeasure	Status group *1	Diagnostic List group *2
AL. 50 P. LRV	C	Illegal P LRV *1 Illegal Pressure LRV *2	Specified value is outside of setting range.	Holds at the output value that existed immediately before the error occurred.	Check settings and change them as needed.	6	Configuration
AL. 51 P. URV	C	Illegal P URV *1 Illegal Pressure URV *2					
AL. 52 P. SPN	C	Illegal P SPAN *1 Illegal Pressure SPAN *2					
AL. 53 P. ADJ	C	P SPAN trim err *1 Pressure SPAN Trim Error *2 P ZERO trim err *1 Pressure ZERO Trim Error *2		Continues to operate and output.	Adjust settings and change them as needed.		
AL. 54 SP. RNG	C	Illegal SP LRV *1 Illegal Static Pressure LRV *2 Illegal SP URV *1 Illegal Static Pressure URV *2 Illegal SP SPAN *1 Illegal Static Pressure SPAN *2	Holds at the output value that existed immediately before the error occurred.	Check settings and change them as needed.			
AL. 55 SP. ADJ	C	SP SPAN trim err *1 Static Pressure SPAN Trim Error *2 SP ZERO trim err *1 Static Pressure ZERO Trim Error *2			Continues to operate and output.		
AL.60 SC.CFG	C	SC config error	Specified values or settings to define signal characterizer function do not satisfy the condition.	Continue to operate and output.	Check setting and change them as needed.	7	
AL. 79 OV. DISP	—	—	Displayed value exceeds limit.	Continues to operate and output.	Check settings and change them as needed.	—	
AL.87 FLG. HI 	M	FT high alarm *1 Fig Temp High Alarm *2	Flange temperature exceeds a preset upper limit.	It depends on the Diag Out Option setting.	Check the heater failure.	8	Diag Status
AL.87 FLG. LO 	M	FT low alarm *1 Fig Temp Low Alarm *2	Flange temperature is below a preset lower limit.	Off: Continue to operate and output. Burnout: Outputs AO upper limit or AO lower limit. Fall back: Outputs Diag Out Fixed Val.	Check the capsule temp. and Amplifier temp. Adjust Flg Temp Coef.		

*1: DD and DTM (excluding EJX HART 5 DTM based on FDT1.2)

*2: EJX HART 5 DTM based on FDT1.2

*3: Available only for HART 7

Integral indicator	NE107 (Default Value)	HART configuration tool display	Cause	4-20mA Output operation during error	Countermeasure	Status group *1	Diagnostic List group *2
AL.88 INVR.DP <i>EJX</i>	C	Invalid Ref DP *1 Invalid Ref fDP *2	Differential pressure/pressure fluctuation does not reach the reference level required to blockage detection so that no blockage detection is carried out.	Continue to operate and output.	Check process condition.	8	Diag Status
AL.88 INVR.SL <i>EJX</i>	C	Invalid Ref SPL *1 Invalid Ref fSPI *2	Low-pressure-side fluctuation does not reach the reference fluctuation level required to blockage detection.				
AL.88 INVR.SH <i>EJX</i>	C	Invalid Ref SPH *1 Invalid Ref fSPH *2	High-pressure-side fluctuation fluctuation does not reach the reference fluctuation level required to blockage detection.				
AL.88 INVR.F <i>EJX</i>	C	Invalid Ref F *1 Invalid Ref BlkF *2	BlkF can not be used for blockage detection for some reasons.				
AL.89 ILBD.OV <i>EJX</i>	N	ILBD over range *1 Outside Diagnosis Range *2	Appointed the diagnosis range outside.	It depends on the Diag Out Option setting. Off: Continue to operate and output. Burnout: Outputs AO upper limit or AO lower limit. Fall back: Outputs Diag Out Fixed Val.	Check process condition.	9	
AL.89 B BLK <i>EJX</i>	M	B Blocking *1, *2	B Blocking (both-side blockage) is detected.				
AL.89 H BLK <i>EJX</i>	M	H Side Blocking *1 High Side Blocking *2	High-pressure-side blockage is detected.				
AL.89 L BLK <i>EJX</i>	M	L Side Blocking *1 Low Side Blocking *2	Low-pressure-side blockage is detected.				
AL.89 H LRG <i>EJX</i>	M	Large Fluct H *1 Large Fluctuation of High Side *2	Pressure fluctuation amplitude of high-pressure side is large.				
AL.89 L LRG <i>EJX</i>	M	Large Fluct L *1 Large Fluctuation of Low Side *2	Pressure fluctuation amplitude of low-pressure side is large.				
AL.89 A BLK <i>EJX</i>	M	A Blocking *1, *2	A Blocking (single-side blockage) is detected.				
AL.91 *3 P. SIM	C	P Simulate Mode	Under Simulation Mode for device variables.	Output the setting value of Simulate-Value	Check Simulation Mode	10	
AL.91 *3 SP. SIM	C	SP Simulate Mode					
AL.91 *3 T. SIM	C	T Simulate Mode					
AL.92 *3 STS.SIM	N	Status Simulate Mode	Under Simulation Mode for status	Continue to operate and output		—	

*1: DD and DTM (excluding EJX HART 5 DTM based on FDT1.2)

*2: EJX HART 5 DTM based on FDT1.2

*3: Available only for HART 7

Table 4.6 HART Configuration Tool Error Messages

Error message	Probable cause	Countermeasure
Invalid selection	—	Change the setting.
Value was too high	Set value is too high.	
Value was too low	Set value is too low.	
Too few data bytes received	—	—
In write protect mode	Operation is set in the Write Protect mode.	—
Lower range value too high	LRV set point is too high.	Change the range.
Lower range value too low	LRV set point is too low.	
Upper range value too high	URV set point is too high.	
Upper range value too low	URV set point is too low.	
Span too small	Set span is too small.	
Applied process too high	Applied pressure is too high.	Adjust the applied pressure.
Applied process too low	Applied pressure is too low.	
New lower range value pushed upper range value over upper sensor limit	The shift of URV according to the new LRV setting exceeds USL.	Change the URV setting within the range of USL.
Excess correction attempted	Amount of correction is too much.	Adjust the amount.
Lower conversion not succeeded	Characters are not convertible. e.g. %	Correct the setting.
Not in fixed current mode	The fixed current mode is desired but not set in that mode.	Set in the fixed current mode.
In multidrop mode	Operation is set in the multi-drop mode.	—
Not write protect mode	Operation is set without a password.	—
Lower range value and upper range value out of limits	URV and LRV are out of range limits.	Change the setting.

Table 4.7 Device Status

Item	NE107 (Default Value)	Description
Field Device Malfunction (0x80)	N	Field device has malfunctioned due to a hardware error or failure.
Configuration Changed (0x40)*	N	A modification has been made to the configuration of the field device.
Cold Start (0x20)	N	A reset of the field device has occurred, or power has been removed and reapplied.
More Status Available (0x10)	N	Field device has more status available.
Loop Current Fixed (0x08)	N	Analog output and its digital representation are in fixed mode, and not responsive to input changes.
Loop Current Saturated (0x04)	S	Analog output and its digital representation are outside the operating range limits, and not responding to input.
Non-Primary Variable Out of Limits (0x02)	S	Process applied to the non-primary variable is outside the operating limits of the field device.
Primary Variable Out of Limits (0x01)	S	Process applied to the primary variable is outside the operating limits of the field device.

*: This flag can be reset. Refer to subsection 4.1.3 (6) Reset Configuration Changed Flag

Table 4.8 Extended Device Status and Diagnostic Status 0, 1

Extended Device Status (Ext dev Status)	NE107 (Default Value)	Description
Maintenance Required (M) (0x01)	N	Field device requires maintenance
Device Variable Alert (0x02)	S	Any device variable is in an alarm or warning state.
Critical Power Failure (0x04)	F	Not Used
Failure (F) (0x08)	N	One or more device variables are invalid due to a malfunction in the field device.
Out of Specification (S) (0x10)	N	Deviations from the permissible ambient or process conditions have been detected that may compromise measurement or control accuracy.
Function Check (C) (0x20)	N	One or more device variables are temporarily invalid due to ongoing work on the device.

Diagnostic Status 0	NE107 (Default Value)	Description
Device Variable Simulation Active (0x01)	C	The device is in simulation mode and one or more of its device variables are not representative of the process.
Non-Volatile Memory Defect (0x02)	F	The Non-Volatile memory check is invalid or maybe corrupt.
Volatile Memory Defect (0x04)	F	Not used
Watchdog Reset Executed (0x08)	F	Not used
Power Supply Conditions Out of Range (0x10)	S	Not used
Environmental Conditions Out of Range (0x20)	S	An internal or environmental condition is beyond acceptable limits.
Electronic Defect (0x40)	F	A hardware problem not related to the sensor has been detected.
Device Configuration Locked (0x80)	N	Device is in write-protect or is locked.

Diagnostic Status 1	NE107 (Default Value)	Description
Status Simulation Active (0x01)	N	Status simulation mode has been enabled and the device status and status bits are fixed and may not represent the current state of the device.
Discrete Variable Simulation Active (0x02)	C	Not used
Event Notification Overflow (0x04)	N	Not used

Table 4.9 Data Quality and Limit Status

Data Quality	Description
Good	The value may be used in control.
Poor Accuracy	The quality of the value is less than normal, but the value may still be useful.
Manual / Fixed	The value is manually fixed.
Bad	The value is not useful.

Limit Status	Description
Constant	The value cannot be changed, no matter what the process does.
Low Limited	The value is out of the high or low limit.
High Limited	
Not Limited	The value is free to change.

Table 4.10 Relationship between Alarm and Status available for HART 7

Integral Indicator	HART configuration tool display	Device Status	Extended Device Status	NE107 (Default Value)	Value and Status (Data Quality and Limit Status)				
					Differential Pressure (DP)	Static Pressure (SP)	Temperature (T)	% range	Loop current
AL.01 CAP.ERR	P sensor error *1 Pressure Sensor Error *2	Device Malfunction (0x80)	Maintenance Required (0x01)*5	F	Value: Hold value Status: Bad and Constant			Value: Hold value Status: Bad and Low Limited/High Limited*3	
	CT sensor error *1 Capsule Temperature Sensor Error *2			F	Value: Hold value Status: Bad and Constant				
	Cap EEPROM error *1 Capsule EEPROM Error *2			F	Value: Hold value Status: Bad and Constant				
AL.02 AMP.ERR	AT sensor error *1 Amp Temp Sensor Error *2	---	---	F	Value: Hold value Status: Bad and Constant			Value: Hold value Status: Bad and Low Limited/High Limited*3	
	Amp EEPROM error *1 Amp EEPROM Error *2			F	Value: Hold value Status: Bad and Constant				
	CPU board error *1 CPU Board Error *2			F	Value: Hold value Status: Bad and Constant				
---	No device ID *1 No Device ID *2	---	---	F	Value: Measured value Status: Good and Not Limited				

*1: DD and DTM (excluding EJX HART 5 DTM based on FDT1.2)

*2: EJX HART 5 DTM based on FDT1.2

*3: Depend on the setting of hardware switch

*4: Depend on the direction of range over (high or low)







*5: Only for the device revision 10

Integral Indicator	HART configuration tool display	Device Status	Extended Device Status	NE107 (Default Value)	Value and Status (Data Quality and Limit Status)				
					Differential Pressure (DP)	Static Pressure (SP)	Temperature (T)	% range	Loop current
AL.10 PRESS	P outside limit *1 Pressure Outside Limit *2	Primary Variable Out of Limits (0x01)	Device Variable Alert (0x02)	S	Value: Measured value Status: Poor Accuracy and Not Limited	Value: Measured value Status: Good and Not Limited	Same as Value and Status of PV		
AL.11 ST.PRSS	SP outside limit *1 Static Pressure Outside Limit *2	Non-Primary Variable Out of Limits (0x02)		S					
AL.12 CAP.TMP	CT outside limit *1 Cap Temp Outside Limit *2	Non-Primary Variable Out of Limits (0x02)		S					
AL.13 AMP.TMP	AT outside limit *1 Amp Temp Outside Limit *2	Loop Current Saturated (0x04)		S	Value: Measured value Status: Good and Not Limited				
AL.30 PRS.RNG	P over range *1 Pressure Over Range *2			S	Value: Measured value Status: Good and Not Limited		Value: Hold value Status: Bad and Low Limited/High Limited*4		
AL.31 SP. RNG	SP over range *1 Static Pressure Over Range *2	---	S	Value: Measured value Status: Good and Not Limited					
AL.35 P. HI	P high alarm *1 Pressure High Alarm *2	---	Device Variable Alert (0x02)*5	N	Value: Measured value Status: Good and Not Limited				
AL.36 P. LO	P low alarm *1 Pressure Low Alarm *2			N					
AL.37 SP. HI	SP high alarm *1 Static Pressure High Alarm *2			N					
AL.38 SP. LO	SP low alarm *1 Static Pressure Low Alarm *2			N					
AL.50 P. LRV	Illegal P LRV *1 Illegal Pressure LRV *2			C	Value: Measured value Status: Good and Not Limited		Value: Hold value Status: Bad and Constant		
AL.51 P. URV	Illegal P URV *1 Illegal Pressure URV *2	C							
AL.52 P. SPN	Illegal P SPAN *1 Illegal Pressure SPAN *2	C							
AL.53 P. ADJ	P SPAN trim err *1 Pressure SPAN Trim Error *2	---	---	C	Value: Measured value Status: Poor Accuracy and Not Limited	Value: Measured value Status: Good and Not Limited	Value: Measured value Status: Poor Accuracy and Not Limited		
	P ZERO trim err *1 Pressure ZERO Trim Error *2			C					

*1: DD and DTM (excluding EJX HART 5 DTM based on FDT1.2)
 *2: EJX HART 5 DTM based on FDT1.2
 *3: Depend on the setting of hardware switch
 *4: Depend on the direction of range over (high or low)
 *5: Only for the device revision 10

Integral Indicator	HART configuration tool display	Device Status	Extended Device Status	NE107 (Default Value)	Value and Status (Data Quality and Limit Status)				
					Differential Pressure (DP)	Static Pressure (SP)	Temperature (T)	% range	Loop current
AL.54 SP. RNG	Illegal SP LRV *1 Illegal Static Pressure LRV *2	---	Device Variable Alert (0x02)*5	C	Value: Measured value Status: Good and Not Limited			Value: Measured value Status: Good and Not Limited	
	Illegal SP URV *1 Illegal Static Pressure URV *2			C					
	Illegal SP SPAN *1 Illegal Static Pressure SPAN *2			C					
AL.55 SP. ADJ	SP SPAN trim err *1 Static Pressure SPAN Trim Error *2			C	Value: Measured value Status: Good and Not Limited	Value: Measured value Status: Poor Accuracy and Not Limited	Value: Measured value Status: Good and Not Limited	Value: Measured value Status: Good and Not Limited	
	SP ZERO trim err *1 Static Pressure ZERO Trim Error *2			C					
AL.60 SC.CFG	SC config error			C	Value: Measured value Status: Good and Not Limited				
AL.79 OV.DISP	---	---	---	---	Value: Measured value Status: Good and Not Limited				
AL.87 FLG. HI <i>EJX</i>	FT high alarm *1 Flg Temp High Alarm *2	---	Maintenance Required (0x01)	M	Value: Measured value Status: Good and Not Limited		In the case "Off" is set to Diag Out Option Value: Measured value Status: Good and Not Limited In the case "Burnout" is set to Diag Out Option Value: Low Limited/High Limited Status: Bad and Low Limited/High Limited*3 In the case "Fall back" is set to Diag Out Option Value: Fixed value Status: Bad and Constant		
AL.87 FLG. LO <i>EJX</i>	FT low alarm *1 Flg Temp Low Alarm *2			M					
AL.88 INVR.DP <i>EJX</i>	Invalid Ref DP *1 Invalid Ref fDP *2			C	Value: Measured value Status: Good and Not Limited				
AL.88 INVR.SL <i>EJX</i>	Invalid Ref SPL *1 Invalid Ref fSPI *2			C					
AL.88 INVR.SH <i>EJX</i>	Invalid Ref SPH *1 Invalid Ref fSPH *2			C					
AL.88 INVR.F <i>EJX</i>	Invalid Ref F *1 Invalid Ref BlkF *2			C					

- *1: DD and DTM (excluding EJX HART 5 DTM based on FDT1.2)
- *2: EJX HART 5 DTM based on FDT1.2
- *3: Depend on the setting of hardware switch
- *4: Depend on the direction of range over (high or low)
- *5: Only for the device revision 10

Integral Indicator	HART configuration tool display	Device Status	Extended Device Status	NE107 (Default Value)	Value and Status (Data Quality and Limit Status)				
					Differential Pressure (DP)	Static Pressure (SP)	Temperature (T)	% range	Loop current
AL.89 ILBD.OV 	ILBD over range *1 Outside Diagnosis Range *2	---	Maintenance Required (0x01)	N	Value: Measured value Status: Good and Not Limited				
AL.89 B BLK 	B Blocking *1, *2	---	Maintenance Required (0x01)	M	Value: Measured value Status: Good and Not Limited			In the case "Off" is set to Diag Out Option Value: Measured value Status: Good and Not Limited In the case "Burnout" is set to Diag Out Option Value: Low Limited/High Limited Status: Bad and Low Limited/High Limited*3 In the case "Fall back" is set to Diag Out Option Value: Fixed value Status: Bad and Constant	
AL.89 H BLK 	H Side Blocking *1 High Side Blocking *2			M					
AL.89 L BLK 	L Side Blocking *1 Low Side Blocking *2			M					
AL.89 H LRG 	Large Fluct H *1 Large Fluctuation of High Side *2			M					
AL.89 L LRG 	Large Fluct L *1 Large Fluctuation of Low Side *2			M					
AL.89 A BLK 	A Blocking *1, *2			M					
AL.91 P.SIM	P Simulate Mode	---	Device Variable Alert (0x02)*5	C	Value and Status: Pressure simulation value	Value: Measured value Status: Good and Not Limited		According to the setting of simulation	
AL.91 SP.SIM	SP Simulate Mode			C	Value and Status: Static Pressure simulation value			Value: Measured value Status: Good and Not Limited	
AL.91 T.SIM	T Simulate Mode			C	Value: Measured value Status: Good and Not Limited	Value and Status: Temperature simulation value			
AL.92 STS.SIM	Status Sim Mode	---	---	N	Value: Status: Good, Not Limited				

- *1: DD and DTM (excluding EJX HART 5 DTM based on FDT1.2)
- *2: EJX HART 5 DTM based on FDT1.2
- *3: Depend on the setting of hardware switch
- *4: Depend on the direction of range over (high or low)
- *5: Only for the device revision 10

5. Parameter Summary

Contents and Default values in the table are for 4 to 20 mA output type. For 1 to 5 V output, replace the current mA value with corresponding voltage V value. Refer to '1.3 Abbreviation and Marking.'

Function	Label	Item	Contents	Default value	Handling *1
Analog output	AO alm typ	Analog output alarm type	High or Low		R
	AO lower limit	Lower limit of analog output	3.6000 to 21.6000 mA	3.6000 mA	W
	AO upper limit	Upper limit of analog output	3.6000 to 21.6000 mA	21.6000 mA	W
	Auto recover	Auto-recover from hardware error	Off or On	On	W
Analog output trim	Clear D/A trim	Reset analog output trim			M
	D/A trim	Analog output trim with ammeter			M
	Scaled D/A trim	Analog output trim with voltmeter			M
	Channel flags	Analog channel flags		0x00	R
Bi-directional mode	Bi-dir mode	Bi-directional mode	Off or On	Off	W
Burst mode 4-20mA	Burst mode	Burst mode *2	Off or On HART 5 Off or Wired HART Enabled HART 7	Off	W
	Burst option HART 5	Burst option	Xmtr Variables, PV, % range/ current, Process vars/cmnt		W
	Burst Command HART 7	Burst Command *2	Cmd 1: PV Cmd 2: % range/current Cmd 3: Dyn vars/current Cmd 9: Device vars w/status Cmd 48: Read Additional Device Status.	Cmd 1: PV	W
	Burst Variable Code (DD) Device Variable Code (DTM) HART 7	Device Variable for the Burst Message *2	Max 8 slots.		W
	Burst Msg Trigger Mode HART 7	Burst Trigger Mode Selection Code *2	(Continuous, Window, Rising, Falling, On-change)	Continuous	R
	Set Burst Trigger HART 7	Configure burst trigger	Configure Burst Msg Trigger Mode and Burst Trigger Level		M
	Set Burst Period HART 7	Configure burst period	Configure Update Period and Max Update Period		M
	Burst Trigger Level HART 7	Burst Trigger Level *2		0.0	R
	Update Period HART 7	Update Period for Burst mode *2	Update period for burst message	Burst Message 1: 0.5s 2: 60s 3: 60s	R
	Max Update Period HART 7	Max Update Period for Burst mode *2	Maximum update period for burst message	60 min	R
Damping	Pres Damp	Damping time constant for DP	0.00 to 100.00 s		W
	Quick resp	Quick response	On or Off	Off	W
Date	Date	Date	**/**/**		W
Descriptor	Descriptor	Descriptor	16 alphanumerics		W

*1: Handling: **R**=Read only, **W**=Read & Write, **M**=Method, **A**=Applicable for option code AL, **G**=Applicable for option code DG6, **D**=Applicable for differential pressure transmitters. Do not change these parameters for pressure transmitters.

*2: Max three Burst Messages (Burst Message 1, Burst Message 2, Burst Message 3)

*3: The default value shows MWP (Maximum working pressure) of the capsule.

Since the working pressure limit varies according to the Model, refer to the General Specifications section in each user's manual.

*4: For output signal code J, refer to the subsection 3.3.19.

*5: These parameters may contain adjustment values based on the customer range calibration at the factory upon shipment.

When executing "Clear P sensor trim", P LTD and P UTD will become "0", and P LTP and P UTP will become the value of LRV and URV respectively.

Function	Label	Item	Contents	Default value	Handling*1
Device information	Chg universal rev *4	Change the HART universal revision	HART 5 or HART 7		M
	Country HART 7	Country code	US, JP, DE, FR, ES, RU, CN	JP	W
	Dev id	Device ID			R
	Distributor	Yokogawa			R
	Drain vent matl	Drain and vent plug material			W
	Extra No.	Customizaion number			R
	Ext SW	External zeroing permission	Disabled or Enabled	Enabled	W
	Fill fluid	Fill fluid			W
	Final asmbly num	Final assembly number			W
	Fld dev rev	Field device revision			R
	Gasket matl	Gasket material			W
	Isoltr matl	Capsule material			W
	Mftr Date	Manufactured date			R
	Model 1	Memo field for MS code 1	32 alphanumerics		W
	Model 2	Memo field for MS code 2	32 alphanumerics		W
	Model 3	Memo field for MS code 3	32 alphanumerics		W
	Num of RS	Number of remote seal			W
	Process Conn matl	Process connection material			W
	Process Conn size	Process connection size			W
	Process Conn type	Process connection type			W
	RS fill fluid	Fill fluid of remote seal			W
	RS Isoltr matl	Remote seal material			W
	RS type	Remote seal type			W
	Serial No.	Serial number			R
	Software rev	Software revision			R
	Style No.	Style number	Style number of product		R
	Universal rev	Universal revision	16 alphanumerics		R
	Cfg chng count HART 7	Configuration change counter		0	R
	Reset Cfg chng flag HART 7	Reset Configuration change flag			M
	Device Profile HART 7	Device Profile		Process automation device	R
Max dev vars HART 7	Max device variables		3	R	
Model	Model	Model name + Measurement span in the Suffix Codes Ex) "EJX110 M"		R	
Device Variable Simulation	Simulate HART 7	Execution of device variable simulation	Execute the simulation		M
Diag Applicable EJX	Diag Applicable	Applicable blockage detection	Disabled or Enabled		RG
Diag DPComp EJX	Diag DPComp	fDP compensation selection	Compensation or Non-compensation	Compensation	WG
Diag Error EJX	Diag Error	Results detected by ILBD or Heat trace monitoring			RG

- *1: Handling: **R**=Read only, **W**=Read & Write, **M**=Method, **A**=Applicable for option code AL, **G**=Applicable for option code DG6, **D**=Applicable for differential pressure transmitters. Do not change these parameters for pressure transmitters.
- *2: Max three Burst Messages (Burst Message 1, Burst Message 2, Burst Message 3)
- *3: The default value shows MWP (Maximum working pressure) of the capsule.
Since the working pressure limit varies according to the Model, refer to the General Specifications section in each user's manual.
- *4: For output signal code J, refer to the subsection 3.3.19.
- *5: These parameters may contain adjustment values based on the customer range calibration at the factory upon shipment.
When executing "Clear P sensor trim", P LTD and P UTD will become "0", and P LTP and P UTP will become the value of LRV and URV respectively.

Function	Label	Item	Contents	Default value	Handling*1
Diag Lim <i>EJX</i>	Lim fDPmax	Upper limit for Ratio fDP		Refer to Table 4.2.3	WG
	Lim fDPmin	Lower limit for Ratio fDP		Refer to Table 4.2.3	WG
	Lim fSPImax	Upper limit for Ratio fSPI		Refer to Table 4.2.3	WG
	Lim fSPImin	Lower limit for Ratio fSPI		Refer to Table 4.2.3	WG
	Lim fSPHmax	Upper limit for Ratio fSPH		Refer to Table 4.2.3	WG
	Lim fSPHmin	Lower limit for Ratio fSPH		Refer to Table 4.2.3	WG
	Lim BlkFmax	Upper limit for BlkF		Refer to Table 4.2.3	WG
	Lim BlkFmin	Lower limit for BlkF		Refer to Table 4.2.3	WG
	Lim DPAvgmax	Upper limit for DPAvg		Refer to Table 4.2.3	WG
	Lim DPAvgmin	Lower limit for DPAvg		Refer to Table 4.2.3	WG
Diag Mode <i>EJX</i>	Diag Mode	ILBD operation mode	Stop, Calculation, or Reference		WG
Diag Option <i>EJX</i>	Diag Option	Alarm masking			WG
Diag Output <i>EJX</i>	Diag Out Option	Output mode of 4-20mA when an advanced diagnostic alarm is generated	Off, Burnout, or Fall back	Off	WG
	Diag Fixed Out Val	4-20 mA output when an advanced diagnostic alarm is generated	3.6000 to 21.6000 mA	21.6 mA	WG
Diag Period <i>EJX</i>	Diag Period	Sampling period per one Diag count		180 s	WG
Diag Reference <i>EJX</i>	Diag Description	Memo field	32 alphanumerics		WG
	Ref fDP	Reference value of fDP			WG
	Ref fDP Status	Status of Reference fDP			RG
	Ref fSPI	Reference value of fSPI			WG
	Ref fSPI Status	Status of Reference fSPI			RG
	Ref fSPH	Reference value of fSPH			WG
	Ref fSPH Status	Status of Reference fSPH			RG
	Ref BlkF	Reference value of BlkF			WG
	Ref BlkF Status	Status of Reference BlkF			RG
	Ref DPAvg	Reference value of DPAvg			WG
Ref DPAvg Status	Status of Reference DPAvg			RG	
Diag Ref Lim <i>EJX</i>	Ref Lim fDPmin	Lower limit of fDP		7.0E-10	WG
	Ref Lim fSPmin	Lower limit of fSPI and fSPH		1.0E-10	WG
	Ref Lim BlkFmax	Upper limit of BlkF		0.5	WG
Diag Supp Count <i>EJX</i>	Diag Supp Count	Detection count to generate an alarm			WG

*1: Handling: **R**=Read only, **W**=Read & Write, **M**=Method, **A**=Applicable for option code AL, **G**=Applicable for option code DG6, **D**=Applicable for differential pressure transmitters. Do not change these parameters for pressure transmitters.

*2: Max three Burst Messages (Burst Message 1, Burst Message 2, Burst Message 3)

*3: The default value shows MWP (Maximum working pressure) of the capsule.

Since the working pressure limit varies according to the Model, refer to the General Specifications section in each user's manual.

*4: For output signal code J, refer to the subsection 3.3.19.

*5: These parameters may contain adjustment values based on the customer range calibration at the factory upon shipment.

When executing "Clear P sensor trim", P LTD and P UTD will become "0", and P LTP and P UTP will become the value of LRV and URV respectively.

Function	Label	Item	Contents	Default value	Handling *1
Diag Variables EJX	Ratio fDP	SQRT (fDP/Ref fDP).			RG
	Ratio fDP Status	Status of Ratio fDP			RG
	Ratio fSPI	SQRT (fSPI/Ref fSPI).			RG
	Ratio fSPI Status	Status of Ratio fSPI			RG
	Ratio fSPH	SQRT (fSPH/Ref fSPH).			RG
	Ratio fSPH Status	Status of Ratio fSPH			RG
	BikF	Blockage degree characterized in comparison of high-pressure side and low-pressure side pressure fluctuation values			RG
	BikF Status	Status of BikF			RG
	DPAvg	Ratio of the average of differential pressure/pressure to the maximum span of an EJX transmitter.			RG
	DPAvg Status	Status of DPAvg			RG
	CRatio fDP	Compensated fDP			RG
	CRatio fDP Status	Status of CRatio fDP			RG
	NRatio fDP	Non-compensated fDP			RG
	NRatio fDP Status	Status of NRatio fDP			RG
Display setup	Bar Indicator	Bar indicator	Off or On	On	W
	Chg power on info	Change the LCD display when powering on	On or Off		M
	Disp Out 1	LCD output 1	PRES, PRES %, ENGR.PRES, SP, SP %	PRES %	W
	Disp Out 2	LCD output 2	PRES, PRES %, ENGR.PRES, SP, SP % or Not used	Not used	W
	Disp Out 3	LCD output 3	(Ditto)	Not used	W
	Disp Out 4	LCD output 4	(Ditto)	Not used	W
	Disp Pres % fnctn	% display mode	Linear or Sq root	As specified or Linear	W
	Disp Pres % Reso	% display resolution	Normal or High resolution	Normal	W
	Engr exp	User set exponent	---, x10, x100, x1000	--- or as specified	W
	Engr LRV	User set lower range value	Unit specified in Set Engr Unit	As specified	W
	Engr point	Decimal place for user set	0 to 4	2	W
	Engr URV	User set upper range value	Unit specified in Set Engr Unit	As specified	W
	Modify Engr Unit	User set engineering unit			M
	Pres disp point	Decimal place for differential pressure	0 to 4	2	W
	Set Engr Unit	Engineering unit select			M
	SP disp point	Decimal place for static pressure	0 to 4	2	WD
	Squawk HART 7	Squawk	Specify the device under the communication (turn the LCD on).		M
	Error log	Error log Clear	Clear error records		
Error log view		Error records	Log1 (latest) to log4		M

- *1: Handling: **R**=Read only, **W**=Read & Write, **M**=Method, **A**=Applicable for option code AL, **G**=Applicable for option code DG6, **D**=Applicable for differential pressure transmitters. Do not change these parameters for pressure transmitters.
- *2: Max three Burst Messages (Burst Message 1, Burst Message 2, Burst Message 3)
- *3: The default value shows MWP (Maximum working pressure) of the capsule.
Since the working pressure limit varies according to the Model, refer to the General Specifications section in each user's manual.
- *4: For output signal code J, refer to the subsection 3.3.19.
- *5: These parameters may contain adjustment values based on the customer range calibration at the factory upon shipment.
When executing "Clear P sensor trim", P LTD and P UTD will become "0", and P LTP and P UTP will become the value of LRV and URV respectively.

Function	Label	Item	Contents	Default value	Handling *1
Event Notification 4-20mA	Event Notification Control HART 7	Event Notification	(Enable event notification on token-passing data link layer, Off)	Off	W
	Device Status Mask HART 7	Event Masking			W
	Status group 1 to 10 Mask HART 7				
	Ext dev status Mask HART 7				
	Device Diagnostic Status 0 Mask HART 7				
	Device Diagnostic Status 1 Mask HART 7				
	AO saturated Mask HART 7				
	AO fixed Mask HART 7				
	Set Event Notification Timing HART 7				

- *1: Handling: **R**=Read only, **W**=Read & Write, **M**=Method, **A**=Applicable for option code AL, **G**=Applicable for option code DG6, **D**=Applicable for differential pressure transmitters. Do not change these parameters for pressure transmitters.
- *2: Max three Burst Messages (Burst Message 1, Burst Message 2, Burst Message 3)
- *3: The default value shows MWP (Maximum working pressure) of the capsule.
Since the working pressure limit varies according to the Model, refer to the General Specifications section in each user's manual.
- *4: For output signal code J, refer to the subsection 3.3.19.
- *5: These parameters may contain adjustment values based on the customer range calibration at the factory upon shipment.
When executing "Clear P sensor trim", P LTD and P UTD will become "0", and P LTP and P UTP will become the value of LRV and URV respectively.

Function	Label	Item	Contents	Default value	Handling *1
Event Notification 4-20mA	Event Notification Retry Time HART 7	Event Notification Retry Time			R
	Max Update Time HART 7	Max Update Time for Event Notification			R
	Event Debounce Interval HART 7	Event Debounce Interval	Debounce Interval to detect an event.		R
	Acknowledge Event Notification HART 7	Acknowledge Event Notification			W
	Event Status HART 7	Event Status	0x00 Approved event or no event 0x10 Configuration changed event pending 0x20 Device status event pending 0x40 More status available event pending		R
	Event Number HART 7	Event Number			W
	Time First Unack Event Triggered HART 7	Time First Unack Event Triggered			W
	Latched Cfg chng count HART 7	Latched Cfg chng count			W
	Latched Device Status HART 7	Device status when event occurred			W
	Latched Status group 1 to 10 HART 7	Field device status when event occurred			W
	Latched Ext dev status HART 7				
	Latched Device Diagnostic Status 0 HART 7				
	Latched Device Diagnostic Status 1 HART 7				
	Latched AO saturated HART 7				
Latched AO fixed HART 7					

- *1: Handling: **R**=Read only, **W**=Read & Write, **M**=Method, **A**=Applicable for option code AL, **G**=Applicable for option code DG6, **D**=Applicable for differential pressure transmitters. Do not change these parameters for pressure transmitters.
- *2: Max three Burst Messages (Burst Message 1, Burst Message 2, Burst Message 3)
- *3: The default value shows MWP (Maximum working pressure) of the capsule.
Since the working pressure limit varies according to the Model, refer to the General Specifications section in each user's manual.
- *4: For output signal code J, refer to the subsection 3.3.19.
- *5: These parameters may contain adjustment values based on the customer range calibration at the factory upon shipment.
When executing "Clear P sensor trim", P LTD and P UTD will become "0", and P LTP and P UTP will become the value of LRV and URV respectively.

Function	Label	Item	Contents	Default value	Handling*1
Flg temp EJX	Flg temp	Calculated flange temperature value			RG
Flg Temp Coef EJX	Flg Temp Coef			0	WG
Flg Temp Lim EJX	Flg Temp Hi Alart Val	Upper limit of Flange temperature		120 °C (deg C)	WG
	Flg Temp Lo Alart Val	Lower limit of Flange temperature		-40 °C (deg C)	WG
Fluct Variables EJX	fDP	Average value of the sum of squares of differential pressure/ pressure fluctuations			RG
	fDP Status	Status of fDP			RG
	fSPI	Average value of the sum of squares of low-pressure-side static pressure fluctuations			RG
	fSPI Status	Status of fSPI			RG
	fSPH	Average value of the sum of squares of high-pressure-side static pressure fluctuations			RG
	fSPH Status	Status of fSPH			RG
Loop test	Loop test	Test output setting	Within AO lower and upper limits		M
	Test Auto Release Time	Auto release time for the test function. Coverage is Loop test, DO test and Device Variable Simulation.	10min, 30min, 60min, 3h, 6h, 12h	10 min	W
Low cut	Low cut	Low cut	0.00 to 20.00%	Refer to subsection 3.2.6	W
	Low cut mode	Low cut mode	Linear or Zero	Linear	W
Master test	Master test	Software reset and self test			M
Message	Message	Message	32 alphanumeric	As specified	W
Number of requested preambles	Num req preams	Number of requested preambles			R
	Num resp preams HART 7	Number of response preambles		5	W
Optional function	Option Password HART 7	Optional function activation password			W
Piping orientation	H/L Swap	Impulse piping accessing direction	Normal or Reverse	Normal	WD
Poll address	Poll addr	Poll address for multidrop use	0 to 15(HART 5), 0 to 63(HART 7)	0	W
	Loop current mode HART 7	Loop current mode in Multi Drop mode	(Disabled, Enabled)	Disabled	W

*1: Handling: **R**=Read only, **W**=Read & Write, **M**=Method, **A**=Applicable for option code AL, **G**=Applicable for option code DG6, **D**=Applicable for differential pressure transmitters. Do not change these parameters for pressure transmitters.

*2: Max three Burst Messages (Burst Message 1, Burst Message 2, Burst Message 3)

*3: The default value shows MWP (Maximum working pressure) of the capsule.

Since the working pressure limit varies according to the Model, refer to the General Specifications section in each user's manual.

*4: For output signal code J, refer to the subsection 3.3.19.

*5: These parameters may contain adjustment values based on the customer range calibration at the factory upon shipment.

When executing "Clear P sensor trim", P LTD and P UTD will become "0", and P LTP and P UTP will become the value of LRV and URV respectively.

Function	Label	Item	Contents	Default value	Handling *1
Process Alerts	Digital Output <i>EJX</i>	Display of contact output	Off or On	Off	RA
	DO Select <i>EJX</i>	Contact output select	Off, Combination of Pres, SP and Temp	Off	WA
	DO Signal type <i>EJX</i>	Signal type select	ON WHEN AL. DETECT, OFF WHEN AL. DETECT	ON WHEN AL. DETECT	WA
	DO Test <i>EJX</i>	Test output contact	Status High, Status Low, Exit		MA
	Pres Alert Mode	Alert Mode for differential pressure	Off, Hi AI Detect, Lo AI Detect, Hi/Lo AI Detect	Off	W
	Hi Alert Val	High alert value for differential pressure	Set the threshold value for high side alarm		W
	Lo Alert Val	Low alert value for differential pressure	Set the threshold value for low side alarm		W
	SP Alert Mode	Alert Mode for static pressure	Off, Hi AI Detect, Lo AI Detect, Hi/Lo AI Detect	Off	WD
	SP Hi Alert Val	High alert value for static pressure	Set the threshold value for high side alarm		WD
	SP Lo Alert Val	Low alert value for static pressure	Set the threshold value for low side alarm		WD
	Temp Alert Mode	Alert Mode for temperature	Off, Hi AI Detect, Lo AI Detect, Hi/Lo AI Detect	Off	W
Process Alerts	Temp Hi Alert Val	High alert value for temperature	Set the threshold value for high side alarm	120°C (deg C)	W
	Temp Lo Alert Val	Low alert value for temperature	Set the threshold value for low side alarm	-40°C (deg C)	W

- *1: Handling: **R**=Read only, **W**=Read & Write, **M**=Method, **A**=Applicable for option code AL, **G**=Applicable for option code DG6, **D**=Applicable for differential pressure transmitters. Do not change these parameters for pressure transmitters.
- *2: Max three Burst Messages (Burst Message 1, Burst Message 2, Burst Message 3)
- *3: The default value shows MWP (Maximum working pressure) of the capsule.
Since the working pressure limit varies according to the Model, refer to the General Specifications section in each user's manual.
- *4: For output signal code J, refer to the subsection 3.3.19.
- *5: These parameters may contain adjustment values based on the customer range calibration at the factory upon shipment.
When executing "Clear P sensor trim", P LTD and P UTD will become "0", and P LTP and P UTP will become the value of LRV and URV respectively.

Function	Label	Item	Contents	Default value	Handling *1
Process variables	Engr Disp	User scaled value			R
	Engr Unit	User set engineering unit	Unit specified in Set Engr Unit 8 alphanumeric		R
	Loop Current (DD) AO (DTM) HART 7	Loop current value (Analog Output Current)	3.6 to 21.6 mA		R
	Loop Current Data Quality HART 7	Device variable process data quality	Device variable process data quality of Loop Current	Good	R
	Loop Current Limit Status HART 7	Device variable limit status	Device variable limit status of Loop Current	Not limited	R
	PV (DD) Pres (DTM)	Pressure/Differential pressure value			R
	PV (Pres) Data Quality HART 7	Device variable process data quality	Device variable process data quality of pressure	Good	R
	PV (Pres) Limit Status HART 7	Device variable limit status	Device variable limit status of pressure	Not limited	R
	PV Update time period (DD) Update time period (DTM) HART 7	PV (Pres) Update time period		45 ms	R
	% range (DD) Pres % (DTM) HART 7	Pressure value in %	-2.50 to 110.00%		R
	% rnge (Percent Range) Data Quality HART 7	Device variable process data quality	Device variable process data quality of % range (Percent Range)	Good	R
	% rnge (Percent Range) Limit Status HART 7	Device variable limit status	Device variable limit status of % range (Percent Range)	Not limited	R
	SV (DD), SP (DTM)	Static pressure value			RD
	SP %	Static pressure value in %	-10.0 to 100.00 %		RD
	SV (SP) Data Quality HART 7	Device variable process data quality	Device variable process data quality of SV (SP)	Good	R
	SV (SP) Limit Status HART 7	Device variable limit status	Device variable limit status of SV (SP)	Not limited	R
	SV Update time period (DD) SP update time (DTM) HART 7	SV (SP) Update time period		360 ms	R

- *1: Handling: **R**=Read only, **W**=Read & Write, **M**=Method, **A**=Applicable for option code AL, **G**=Applicable for option code DG6, **D**=Applicable for differential pressure transmitters. Do not change these parameters for pressure transmitters.
- *2: Max three Burst Messages (Burst Message 1, Burst Message 2, Burst Message 3)
- *3: The default value shows MWP (Maximum working pressure) of the capsule.
Since the working pressure limit varies according to the Model, refer to the General Specifications section in each user's manual.
- *4: For output signal code J, refer to the subsection 3.3.19.
- *5: These parameters may contain adjustment values based on the customer range calibration at the factory upon shipment.
When executing "Clear P sensor trim", P LTD and P UTD will become "0", and P LTP and P UTP will become the value of LRV and URV respectively.

Function	Label	Item	Contents	Default value	Handling *1
Process variables	TV (DD) Snsr temp (DTM)	Temperature value	Capsule temperature		R
	TV (Temp) Data Quality HART 7	Device variable process data quality	Device variable process data quality of TV (Temp)	Good	R
	TV (Temp) Limit Status HART 7	Device variable limit status	Device variable limit status of TV (Temp)	Not limited	R
	TV Update time period (DD) Temp update time (DTM) HART 7	TV (Temp) Update time period		1s	R
Range change	Apply values	Re range for measured pressure	4 mA, 20 mA, or Exit		M
	Min Span	Minimum span for pressure			R
	LRV	Lower range value for pressure		As specified	W
	LSL	Lower sensor limit for pressure			R
	URV	Upper range value for pressure		As specified	W
	USL	Upper sensor limit for pressure			R
Self test	Self test	Self-diagnostics			M
Sensor trim	Clear P snsr trim	Reset pressure trim to factory setting			M
	Clear SP snsr trim	Reset SP trim to factory setting			MD
	P LTD	Lower pressure trim deviation		*5	R
	P LTP	Lower temperature trim point		*5	R
	P UTD	Upper pressure trim deviation		*5	R
	P UTP	Upper temperature trim point		*5	R
	Pres trim	Pressure trim			M
	Pres Zero trim	Zeroing			M
	SP LTD	Lower SP trim deviation		0	RD
	SP LTP	Lower SP trim point		SP LRV	RD
	SP UTD	Upper SP trim deviation		0	RD
	SP UTP	Upper SP trim point		SP URV	RD
	Static Pres trim	Static pressure trim			MD
	Trim Date	Trim date	**/**/**		W
	Trim Desc	Trim description	16 alphanumerics		W
Trim Loc	Trim location	8 alphanumerics		W	
Trim Who	Trim person	8 alphanumerics		W	
Set Diag Mode	Set Diag Mode	ILBD operation mode	Stop, Calculation, or Reference		WG
Signal characterizer	Num of points	Number of coordinates	0 to 9	9	W
	Point setting	Coordinates editor			M
	S.C.	Signal characterizer permission	Disabled or Enabled	Disabled	W
	X End	End point of X		100.00%	R
	X Start	Start point of X		0.00%	R
	Y End	End point of Y		100.00%	R
	Y Start	Start point of Y		0.00%	R

- *1: Handling: **R**=Read only, **W**=Read & Write, **M**=Method, **A**=Applicable for option code AL, **G**=Applicable for option code DG6, **D**=Applicable for differential pressure transmitters. Do not change these parameters for pressure transmitters.
- *2: Max three Burst Messages (Burst Message 1, Burst Message 2, Burst Message 3)
- *3: The default value shows MWP (Maximum working pressure) of the capsule.
Since the working pressure limit varies according to the Model, refer to the General Specifications section in each user's manual.
- *4: For output signal code J, refer to the subsection 3.3.19.
- *5: These parameters may contain adjustment values based on the customer range calibration at the factory upon shipment.
When executing "Clear P sensor trim", P LTD and P UTD will become "0", and P LTP and P UTP will become the value of LRV and URV respectively.

Function	Label	Item	Contents	Default value	Handling *1
SP setup	A/G Select	Gauge/Abs select for static pressure	Gauge or Absolute	Absolute	WD
	Atm. Pres Value	Conversion coefficient		101.3 kPa	WD
	SP Apply values	Rerange for static pressure	"0%, 100%, or Exit"		MD
	SP Damp	Damping time constant for SP	0.00 to 100.00	2.00 s	WD
	SP H/L Select	H/L select for static pressure	High or Low	High	WD
	SP Min Span	Minimum span for static pressure			RD
	SP LRV	Lower range value for static pressure	Within measurement range	0.0 MPa	WD
	SP LSL	Lower sensor limit for static pressure			RD
	SP URV ³	Upper range value for static pressure	Within measurement range		WD
	SP USL	Upper sensor limit for static pressure			RD
Status	Device Status	Current operating status			R
	Status group 1	Device status information for hardware	Display the hardware error		R
	Status group 2	Device status information for hardware	Display the hardware error		R
	Status group 3	Device status information for process	Display the process error (Out of specification)		R
	Status group 4	Device status information for process	Display the process error (Out of setting range)		R
	Status group 5	Device status information for process	Display the process error (Alarm)		R
	Status group 6	Device status information for data	Display the setting error		R
	Status group 7	Device status information for data	Display the setting error		R
	Status group 8	Device status information for data	Display the diagnostic alarm		R
	Status group 9	Device status information for data	Display the diagnostic alarm		R
	Status group 10	Device status information for data	Display the simulation mode		R
		Ext dev status HART 7	Extended Device Status		
	Time Stamp	Time Stamp		00:00:00	R
Tag	Tag	Tag number	8 alphanumerics	As specified	W
	Long tag HART 7	Long tag	Max 32 alphanumerics	As specified	W
Temperature compensation	T.Z. Cmp mode	Temperature compensation mode	Off or On	Off	W
	Temp Zero	Zero shift compensation	-99.999 to 99.999%/degC	0.000%/degC	W
Temperature sensor	Amp temp	Amplifier temperature			R
	Snsr temp	Capsule temperature			R
Transfer function	Xfer fnctn	Output mode	Linear or Sq root	As specified or Linear	W
Units	Unit	Pressure, Differential pressure unit		As specified or kPa	W
	SP Unit	Static pressure unit		MPa	WD
	Temp Unit	Temperature unit	deg C, deg F, or Kelvin	deg C	W
Write protection menu	Enable wrt 10min	Write protection release	8 alphanumerics		M
	New password	User set password for write protection	8 alphanumerics		M
	Write protect	Write protection indicator	Yes or No	No	R

*1: Handling: **R**=Read only, **W**=Read & Write, **M**=Method, **A**=Applicable for option code AL, **G**=Applicable for option code DG6, **D**=Applicable for differential pressure transmitters. Do not change these parameters for pressure transmitters.

*2: Max three Burst Messages (Burst Message 1, Burst Message 2, Burst Message 3)

*3: The default value shows MWP (Maximum working pressure) of the capsule.

Since the working pressure limit varies according to the Model, refer to the General Specifications section in each user's manual.

*4: For output signal code J, refer to the subsection 3.3.19.

*5: These parameters may contain adjustment values based on the customer range calibration at the factory upon shipment.

When executing "Clear P sensor trim", P LTD and P UTD will become "0", and P LTP and P UTP will become the value of LRV and URV respectively.

Appendix 1. Safety Instrumented Systems Installation

When using the transmitters in a Safety Instrumented System application, refer to the Functional Safety Data Sheet (Document No.: TI 01C25A05-01EN or TI 01C25A05-21EN for option code SLT) and follow the instructions and procedures described there.

The document can be downloaded from the website of Yokogawa.

(Website address: <https://www.yokogawa.com/solutions/products-platforms/field-instruments/>)

In order to satisfy the requirement of Safety Instrumented System, executing parameters setting is required. Please refer to chapter 3. "Parameter Setting" for setting range.

Please also refer to the status output setting in the same clause. After installing the transmitter, confirm that the range and unit is set correctly. Calibration of the transmitters shall be done after completing the range setting.

Appendix 2. ILBD Check List

Fill out the below checklist according to the operation flow of the ILBD in order to keep the important information for the blockage detection.

Checklist (1/5)

No.	Items	Parameters	Result	Example
1	4-20 mA Analog Signal Setting • Select the output mode when an alarm is generated.	Diag Out Option	Off: <input type="checkbox"/>	<input checked="" type="checkbox"/>
			Burnout: <input type="checkbox"/>	<input type="checkbox"/>
		Diag Fixed Out Val	Fall back: <input type="checkbox"/>	<input type="checkbox"/>
			mA	21.6 mA
2	Status Output	DO Select	Pres: <input type="checkbox"/>	<input type="checkbox"/>
			SP: <input type="checkbox"/>	<input type="checkbox"/>
			Temp: <input type="checkbox"/>	<input type="checkbox"/>
			Diag: <input type="checkbox"/>	<input checked="" type="checkbox"/>
			All: <input type="checkbox"/>	<input type="checkbox"/>
3	Stability of Pres (differential pressure/pressure) under normal condition • Check that the status of Pres is "GOOD". • Check the maximum and minimum values of Pres .	Status		Good
		Pres	Max.: Min.:	Max.: 12.3 kPa Min.: 12.1 kPa
4	fDP under normal condition • Check that the value of fDP is more than 7×10^{-10} .	fDP	<input type="checkbox"/>	<input checked="" type="checkbox"/>
5	Start to obtain Reference values • Set "Reference" to Diag Mode .	Diag Mode	<input type="checkbox"/>	<input checked="" type="checkbox"/>
6	End of Reference Value Sampling • Check that Diag Mode is "Calculation" after the time set to "Diag Period" passed.	Diag Mode	<input type="checkbox"/>	<input checked="" type="checkbox"/>
7	Alarm setting • Record the status of Checkbox in Diag Option .	Diag Option		
		A Blocking	<input type="checkbox"/>	<input checked="" type="checkbox"/>
		Large Fluct L	<input type="checkbox"/>	<input checked="" type="checkbox"/>
		Large Fluct H	<input type="checkbox"/>	<input checked="" type="checkbox"/>
		L Side Blocking	<input type="checkbox"/>	<input checked="" type="checkbox"/>
		H Side Blocking	<input type="checkbox"/>	<input checked="" type="checkbox"/>
		B Blocking	<input type="checkbox"/>	<input checked="" type="checkbox"/>
		Invalid Ref F	<input type="checkbox"/>	<input checked="" type="checkbox"/>
		Invalid Ref SPH	<input type="checkbox"/>	<input type="checkbox"/>
		Invalid Ref SPL	<input type="checkbox"/>	<input type="checkbox"/>
		Invalid Ref DP	<input type="checkbox"/>	<input checked="" type="checkbox"/>
ILBD over range	<input type="checkbox"/>	<input type="checkbox"/>		

Checklist (2/5)

No.	Items	Parameters	Result	Example
8	Alarm status • Check the alarm status shown in Diag Error . • Check that the alarm status of “ILBD over range” is not shown in Diag Error .	Diag Error		
		A Blocking	<input type="checkbox"/>	<input type="checkbox"/>
		Large Fluct L	<input type="checkbox"/>	<input type="checkbox"/>
		Large Fluct H	<input type="checkbox"/>	<input type="checkbox"/>
		L Side Blocking	<input type="checkbox"/>	<input type="checkbox"/>
		H Side Blocking	<input type="checkbox"/>	<input type="checkbox"/>
		B Blocking	<input type="checkbox"/>	<input type="checkbox"/>
		Invalid Ref F	<input type="checkbox"/>	<input checked="" type="checkbox"/>
		Invalid Ref SPH	<input type="checkbox"/>	<input type="checkbox"/>
		Invalid Ref SPL	<input type="checkbox"/>	<input type="checkbox"/>
		Invalid Ref DP	<input type="checkbox"/>	<input type="checkbox"/>
		ILBD over range	<input type="checkbox"/>	<input type="checkbox"/>
9	ILBD parameters • Record the values of parameters for ILBD operation. • Check the status of parameters for ILBD operation. *: Record the value after checked that the status of each parameter is “GOOD”.	Diag Period		180
		Lim fDPmax		3.000000
		Lim fDPmin		0.300000
		Lim fSPImax		5.000000
		Lim fSPimin		0.500000
		Lim fSPHmax		5.000000
		Lim fSPHmin		0.500000
		Lim BlkFmax		0.600000
		Lim BlkFmin		-0.600000
		Lim DPAvgmax		1.000000
		Lim DPAvgmin		0.050000
		Diag Supp Count		3
		Ref fDP*		7.43245E-09
		Ref fSPI*		7.25765E-09
		Ref fSPH*		7.18374E-09
		Ref DPAvg*		5.36425E+00
		fDP*		7.48562E-09
		fSPI*		7.23277E-09
		fSPH*		7.14085E-09
		BlkF*		-0.287259
DPAvg*		0.055957		

Checklist (3/5)

Go to the following step according to the result of "Invalid Ref xx" shown in the **Diag Error** of 8th check item.

Diag Error			→	Check item
Invalid Ref SPH	Invalid Ref SPL	Invalid Ref DP		
<input type="checkbox"/>	<input type="checkbox"/>	<input type="checkbox"/>	→	10-a
<input checked="" type="checkbox"/>	<input checked="" type="checkbox"/>	<input type="checkbox"/>	→	10-b

- : The alarm is generated.
- : The alarm is not generated.

No.	Items	Parameters	Result	Example
10-a	Simulation of Blockage detection operation <ul style="list-style-type: none"> • H Side Blocking: 10-a-1 • L Side Blocking: 10-a-2 • Both Side Blocking: 10-a-3 			
10-a-1	H Side Blocking <ul style="list-style-type: none"> • Close the high-pressure side valve completely. • Record the values of fDP, fSPI, fSPH, BlkF, and DPAvg after the certain time, (Diag Period X Diag Supp Count), passed. *: Record the value after checked that the status is "GOOD".	fDP*		7.48562E-09
		fSPI*		7.23277E-09
		fSPH*		7.14085E-09
		BlkF		-0.287259
	<ul style="list-style-type: none"> • Record the status of Checkbox in Diag Option. • Check that the alarms status of "A Blocking" and "H Side Blocking" are set. Note: If the alarm of "ILBD over range" is generated, the valve may be closed too much tightly. Open valve a little and record the updated status of the parameters.	Diag Option		
		A Blocking	<input type="checkbox"/>	<input checked="" type="checkbox"/>
		Large Fluct L	<input type="checkbox"/>	<input type="checkbox"/>
		Large Fluct H	<input type="checkbox"/>	<input type="checkbox"/>
		L Side Blocking	<input type="checkbox"/>	<input type="checkbox"/>
		H Side Blocking	<input type="checkbox"/>	<input checked="" type="checkbox"/>
		B Blocking	<input type="checkbox"/>	<input type="checkbox"/>
		Invalid Ref F	<input type="checkbox"/>	<input type="checkbox"/>
		Invalid Ref SPH	<input type="checkbox"/>	<input type="checkbox"/>
	Invalid Ref SPL	<input type="checkbox"/>	<input type="checkbox"/>	
Invalid Ref DP	<input type="checkbox"/>	<input type="checkbox"/>		
ILBD over range	<input type="checkbox"/>	<input type="checkbox"/>		
<ul style="list-style-type: none"> • Check that the alarm of "H Side Blocking" is generated. • Check that the alarm of "L Side Blocking" is not generated. 	Diag Error			
	L Side Blocking	<input type="checkbox"/>	<input type="checkbox"/>	
	H Side Blocking	<input type="checkbox"/>	<input checked="" type="checkbox"/>	

Checklist (4/5)

No.	Items	Parameters	Result	Example
10-a-2	L Side Blocking			
	<ul style="list-style-type: none"> Close the low-pressure side valve completely. 			
	<ul style="list-style-type: none"> Record the values of fDP, fSPI, fSPH, BlkF, and DPAvg after the certain time, (Diag Period X Diag Supp Count), passed. <p>*: Record the value after checked that the status is "GOOD".</p>	fDP*		7.48562E-09
		fSPI*		7.23277E-09
		fSPH*		7.14085E-09
		BlkF		-0.287259
	<ul style="list-style-type: none"> Record the status of Checkbox in Diag Option. Check that the alarms status of "A Blocking" and "L Side Blocking" are set. <p>Note: If the alarm of "ILBD over range" is generated, the valve may be closed too much tightly. Open valve a little and record the updated status of the parameters.</p>	Diag Option		
		A Blocking	<input type="checkbox"/>	<input checked="" type="checkbox"/>
		Large Fluct L	<input type="checkbox"/>	<input type="checkbox"/>
		Large Fluct H	<input type="checkbox"/>	<input type="checkbox"/>
		L Side Blocking	<input type="checkbox"/>	<input checked="" type="checkbox"/>
		H Side Blocking	<input type="checkbox"/>	<input type="checkbox"/>
		B Blocking	<input type="checkbox"/>	<input type="checkbox"/>
		Invalid Ref F	<input type="checkbox"/>	<input type="checkbox"/>
		Invalid Ref SPH	<input type="checkbox"/>	<input type="checkbox"/>
		Invalid Ref SPL	<input type="checkbox"/>	<input type="checkbox"/>
		Invalid Ref DP	<input type="checkbox"/>	<input type="checkbox"/>
ILBD over range	<input type="checkbox"/>	<input type="checkbox"/>		
<ul style="list-style-type: none"> Check that the alarm of "L Side Blocking" is generated. Check that the alarm of "H Side Blocking" is not generated. 	Diag Error			
	L Side Blocking	<input type="checkbox"/>	<input checked="" type="checkbox"/>	
	H Side Blocking	<input type="checkbox"/>	<input type="checkbox"/>	
10-a-3	Both Side Blocking			
	<ul style="list-style-type: none"> Close the both-pressure side valves completely. 			
	<ul style="list-style-type: none"> Record the values of fDP, fSPI, fSPH, BlkF, and DPAvg after the certain time, (Diag Period X Diag Supp Count), passed. <p>*: Record the value after checked that the status is "GOOD".</p>	fDP*		7.48562E-09
		fSPI*		7.23277E-09
		fSPH*		7.14085E-09
		BlkF		-0.287259
	<ul style="list-style-type: none"> Record the status of Checkbox in Diag Option. Check that the alarms status of "H Side Blocking", "L Side Blocking", and "B Blocking" are set. <p>Note: If the alarm of "ILBD over range" is generated, the valve may be closed too much tightly. Open valve a little and record the updated status of the parameters.</p>	Diag Option		
		A Blocking	<input type="checkbox"/>	<input type="checkbox"/>
		Large Fluct L	<input type="checkbox"/>	<input type="checkbox"/>
		Large Fluct H	<input type="checkbox"/>	<input type="checkbox"/>
		L Side Blocking	<input type="checkbox"/>	<input checked="" type="checkbox"/>
		H Side Blocking	<input type="checkbox"/>	<input checked="" type="checkbox"/>
		B Blocking	<input type="checkbox"/>	<input checked="" type="checkbox"/>
		Invalid Ref F	<input type="checkbox"/>	<input type="checkbox"/>
		Invalid Ref SPH	<input type="checkbox"/>	<input type="checkbox"/>
		Invalid Ref SPL	<input type="checkbox"/>	<input type="checkbox"/>
		Invalid Ref DP	<input type="checkbox"/>	<input type="checkbox"/>
ILBD over range	<input type="checkbox"/>	<input type="checkbox"/>		
<ul style="list-style-type: none"> Check that the alarm of "B Blocking" is generated. 	Diag Error			
	B Blocking	<input type="checkbox"/>	<input checked="" type="checkbox"/>	

Checklist (5/5)

No.	Items	Parameters	Result	Example
10-b	Simulation of Blockage detection operation			
	<ul style="list-style-type: none"> Close completely the valve for the side where the alarm of Invalid Reference Value is not generated. 			
	For the case that the high-pressure side value is closed;	fDP*		7.48562E-09
	<ul style="list-style-type: none"> Record the values of fDP, fSPI, fSPH, BlkF, and DPAvg after the certain time, (Diag Period X Diag Supp Count), passed. 			
	: Record the value after checked that the status is "GOOD".	fSPH		7.14085E-09
	For the case that the low-pressure side value is closed;	fDP*		7.48562E-09
	<ul style="list-style-type: none"> Record the values of fDP, fSPI, fSPH, BlkF, and DPAvg after the certain time, (Diag Period X Diag Supp Count), passed. 			
	: Record the value after checked that the status is "GOOD".	fSPI		7.23277E-09
	<ul style="list-style-type: none"> Record the status of Checkbox in Diag Option. Check that the alarms status of "B Blocking" is set. 	Diag Option		
	Note: If the alarm of "ILBD over range" is generated, the valve may be closed too much tightly. Open valve a little and record the updated status of the parameters.	A Blocking	<input type="checkbox"/>	<input type="checkbox"/>
		Large Fluct L	<input type="checkbox"/>	<input type="checkbox"/>
		Large Fluct H	<input type="checkbox"/>	<input type="checkbox"/>
		L Side Blocking	<input type="checkbox"/>	<input type="checkbox"/>
H Side Blocking		<input type="checkbox"/>	<input type="checkbox"/>	
B Blocking		<input type="checkbox"/>	<input checked="" type="checkbox"/>	
Invalid Ref F		<input type="checkbox"/>	<input checked="" type="checkbox"/>	
Invalid Ref SPH		<input type="checkbox"/>	<input type="checkbox"/>	
Invalid Ref SPL		<input type="checkbox"/>	<input checked="" type="checkbox"/>	
Invalid Ref DP	<input type="checkbox"/>	<input type="checkbox"/>		
ILBD over range	<input type="checkbox"/>	<input type="checkbox"/>		
<ul style="list-style-type: none"> Check that the alarm of "B Blocking" is not generated. 	Diag Error			
	B Blocking	<input type="checkbox"/>	<input checked="" type="checkbox"/>	

Appendix 3. Parameter Setting for Previous Version

This chapter shows the parameter setting for the products of HART 7 Device Revision 10 and HART 5. Refer to chapter 3 for the information of the latest version.

Applied model	[HART]	[Dev.Rev.]	DD	DTM	DTM
EJA series	HART 7	10	A3.1.1	A3.1.1	EJA-NEXT FDT2.0 HART7 DTM (or EJA-NEXT HART7 DTM)
	HART 5	1			EJA-NEXT FDT2.0 HART DTM (or EJA-NEXT HART DTM)
EJX series	HART 7	10	A3.1.1	A3.1.1	EJX FDT2.0 HART7 DTM (or EJX HART7 DTM)
	HART 5	3		A3.1.2	EJX V3.1

A3.1 Group I: DD and DTM (excluding EJX HART 5 DTM based on FDT1.2)

When FieldMate with DD and DTM (excluding EJX HART 5 DTM based on FDT1.2) is used in order to set or refer to parameters, there is difference on the initial root menu as below.

I-1 DD

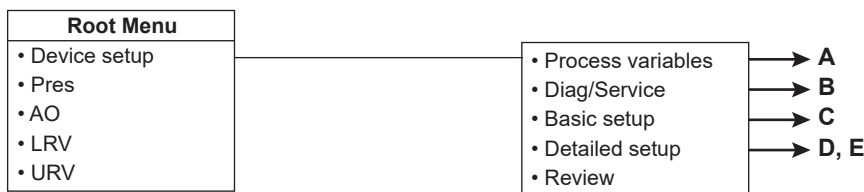

I-2 DTM

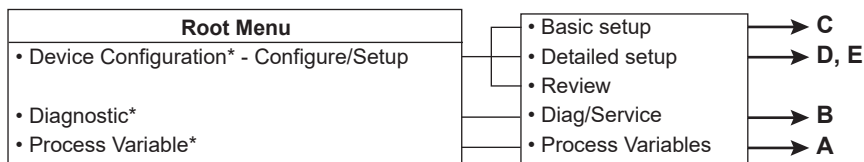

*: The next parameter is displayed on the top menu when using the DTM based or FDT2.0.

FA0301-01.ai

HART 7 : HART 7 only

A

<ul style="list-style-type: none"> • Process variables 	<ul style="list-style-type: none"> • Pres • Pres % • AO • SP • SP % • Snsr temp • Engr Disp • Engr exp • Engr Unit • Device Variables and Status HART 7 	DTM	DD
		<ul style="list-style-type: none"> • Pres • Pres Data Quality • Pres Limit Status • SP • SP Data Quality • SP Limit Status • Snsr temp • Temp Data Quality • Temp Limit Status • Pres % • Percent Range Data Quality • Percent Range Limit Status • AO • Loop Current Data Quality • Loop Current Limit Status 	<ul style="list-style-type: none"> • PV • PV Data Quality • PV Limit Status • SV • SV Data Quality • SV Limit Status • TV • TV Data Quality • TV Limit Status • % rng • % rng Data Quality • % rng Limit Status • Loop current • Loop current Data Quality • Loop current Limit Status

FA0301-02.ai

HART 7 : HART 7 only
EJX : EJX Series only

B

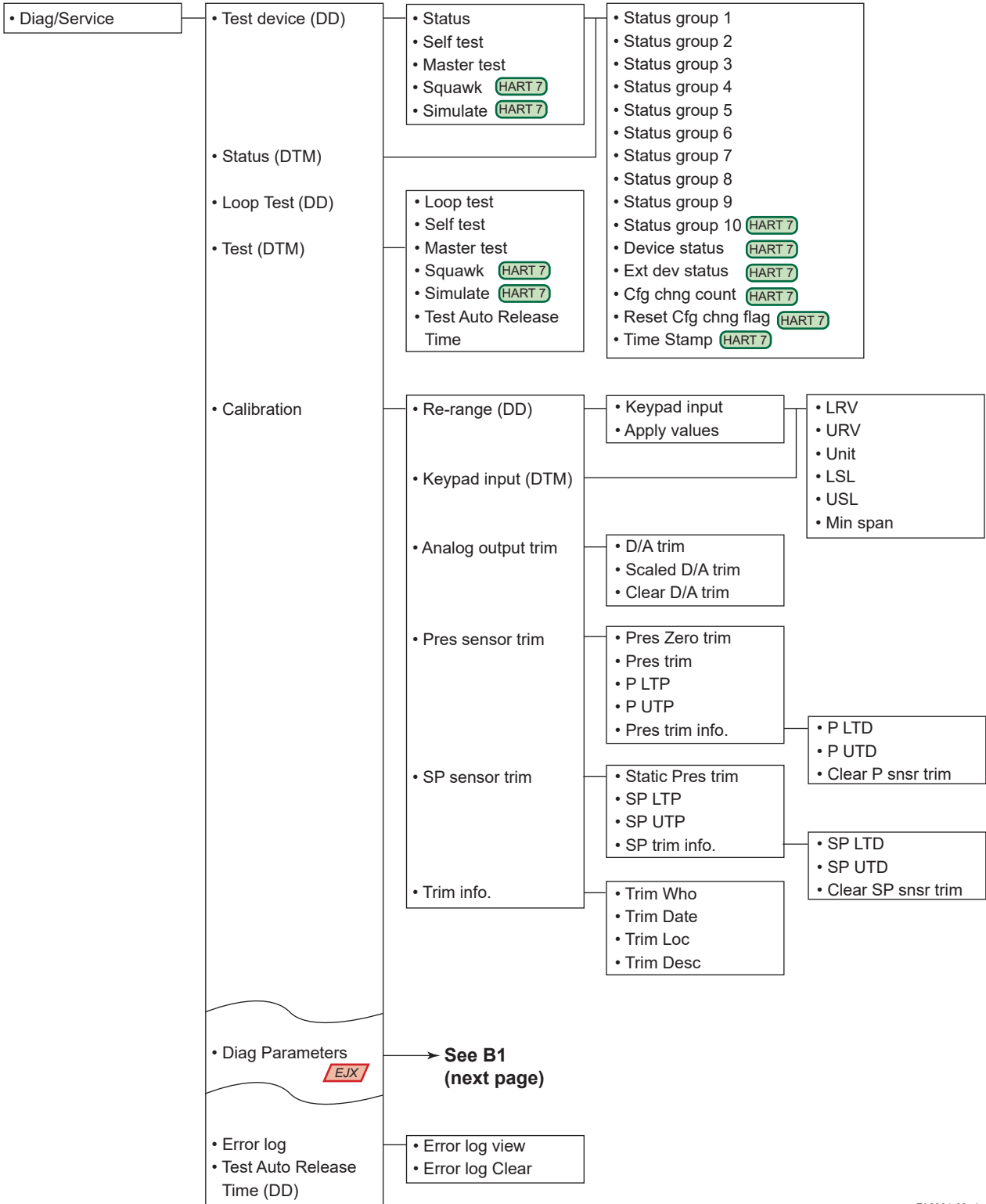

FA0301-03.ai

EJX : EJX Series only

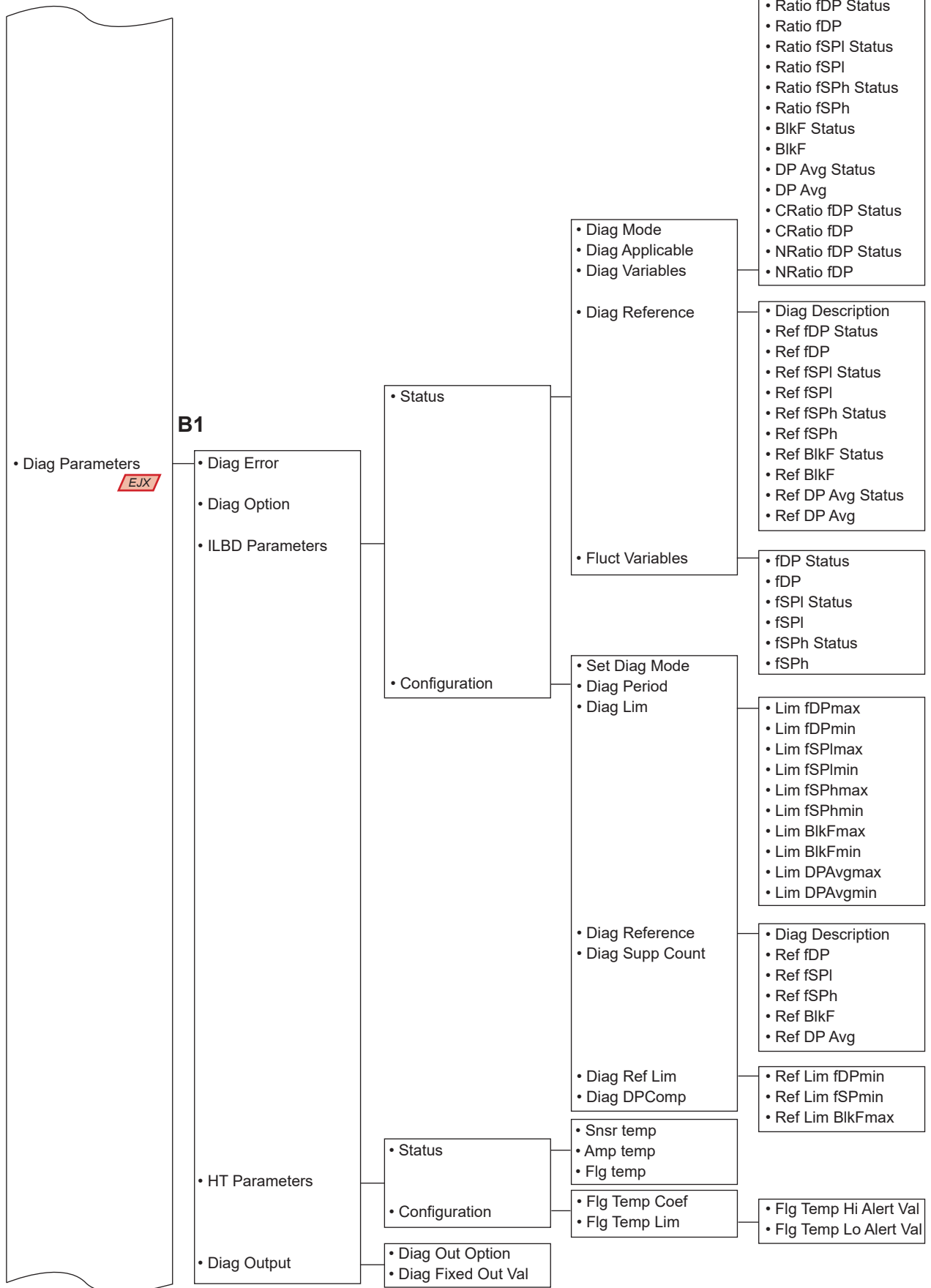

FA0301-04.ai

C

HART 7 : HART 7 only

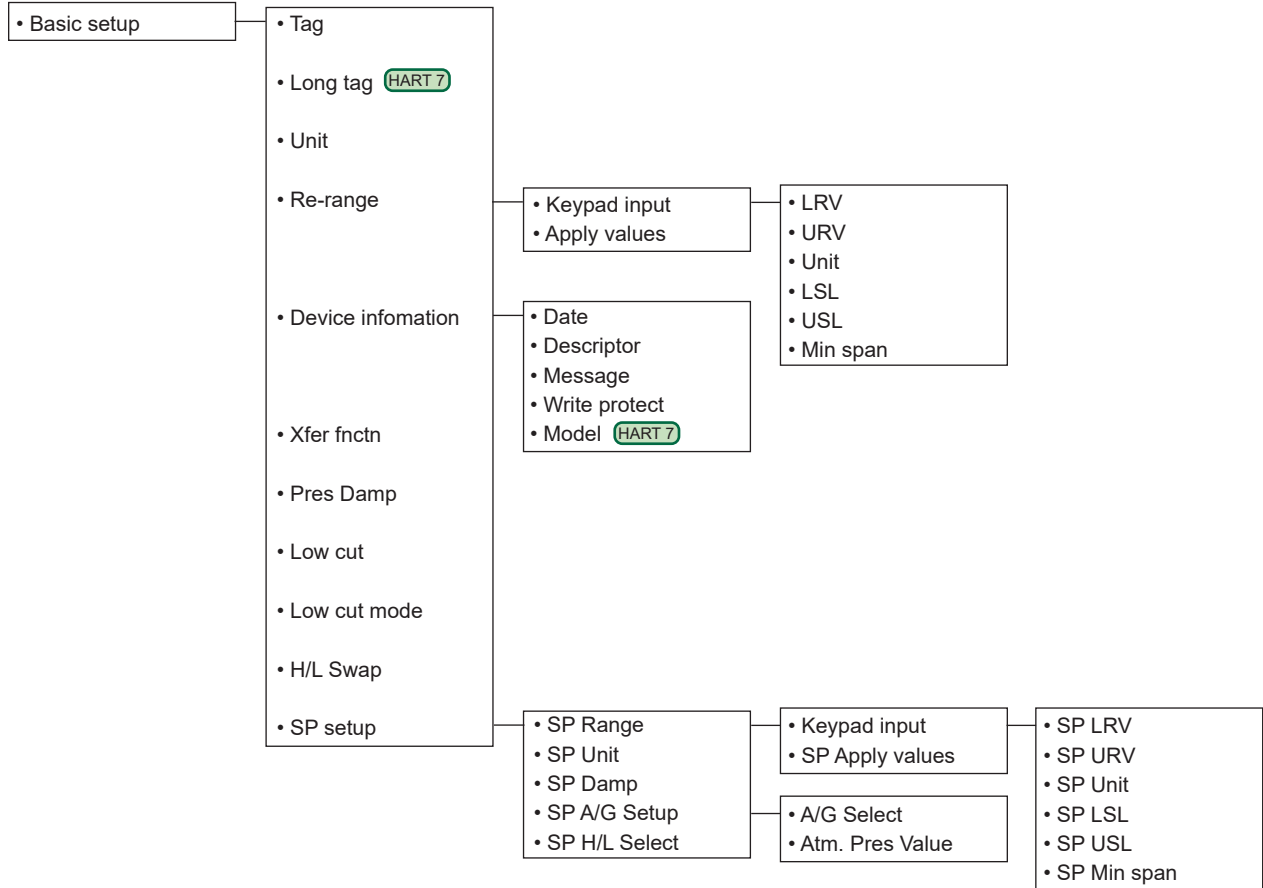

FA0301-05.ai

D

HART 7 : HART 7 only
EJX : EJX Series only

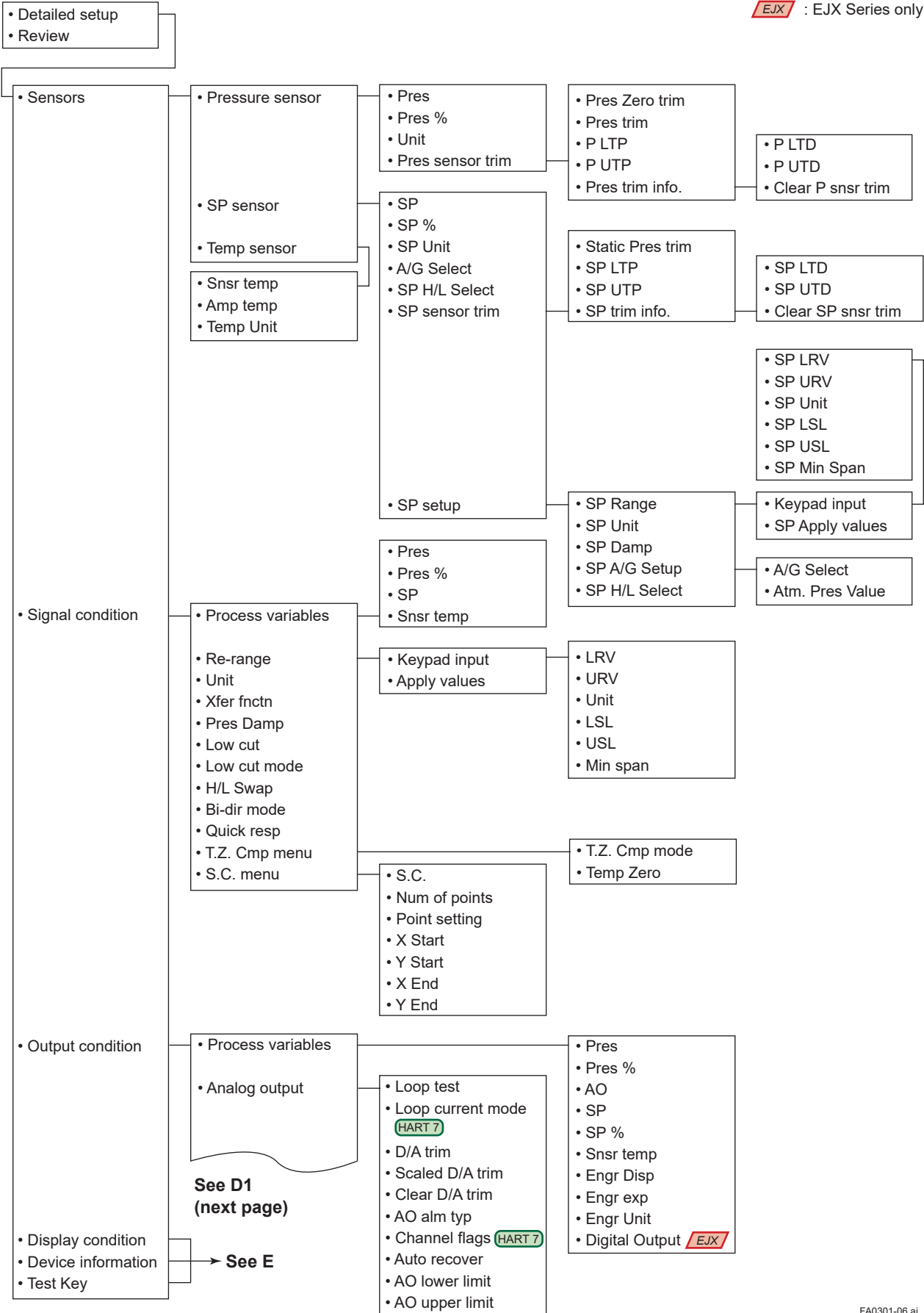

See D1
(next page)

See E

D1

HART 5 : HART 5 only
HART 7 : HART 7 only
EJX : EJX Series only
4-20mA : 4-20mA output only

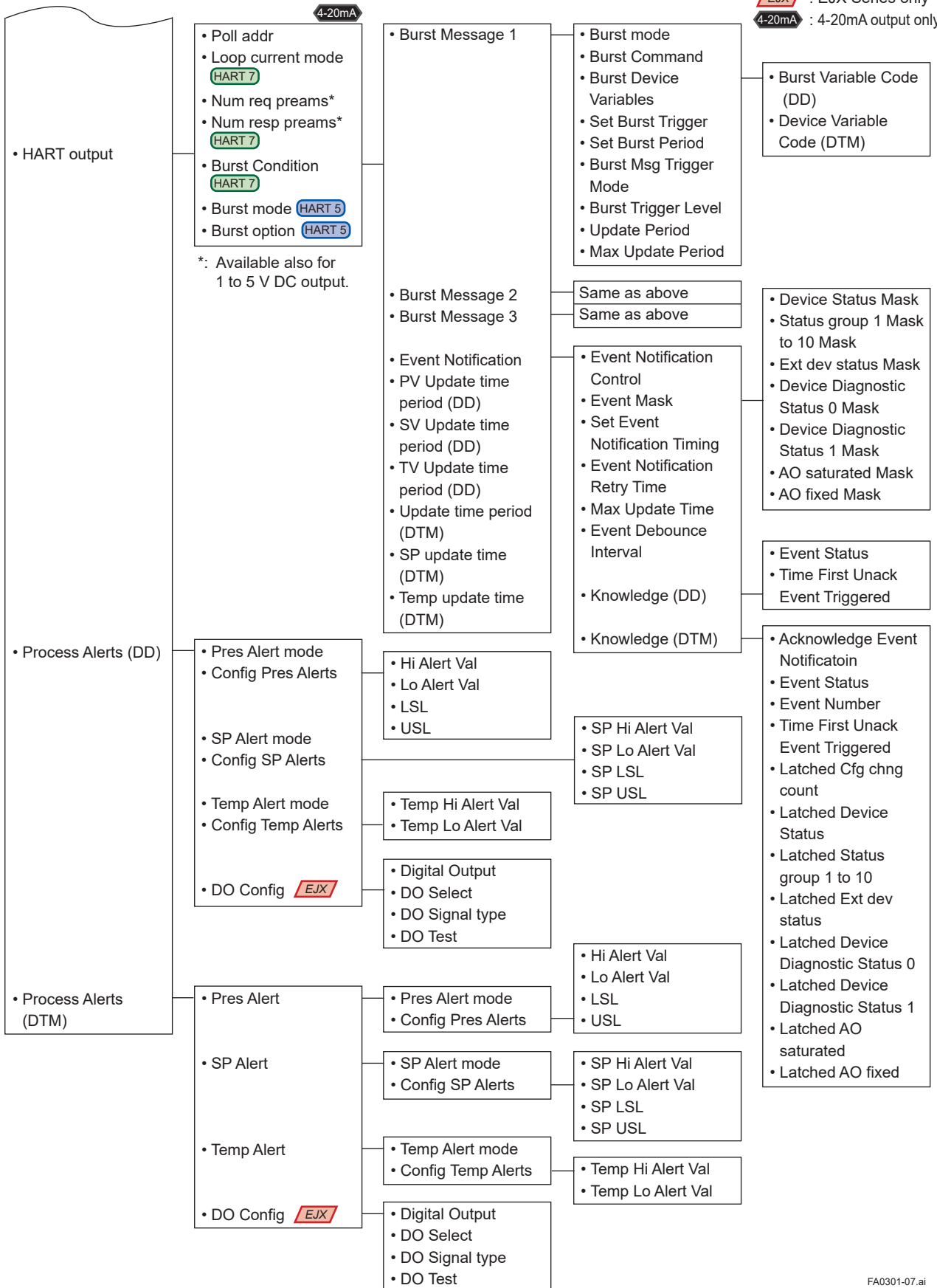

FA0301-07.ai

E

HART 7 : HART 7 only

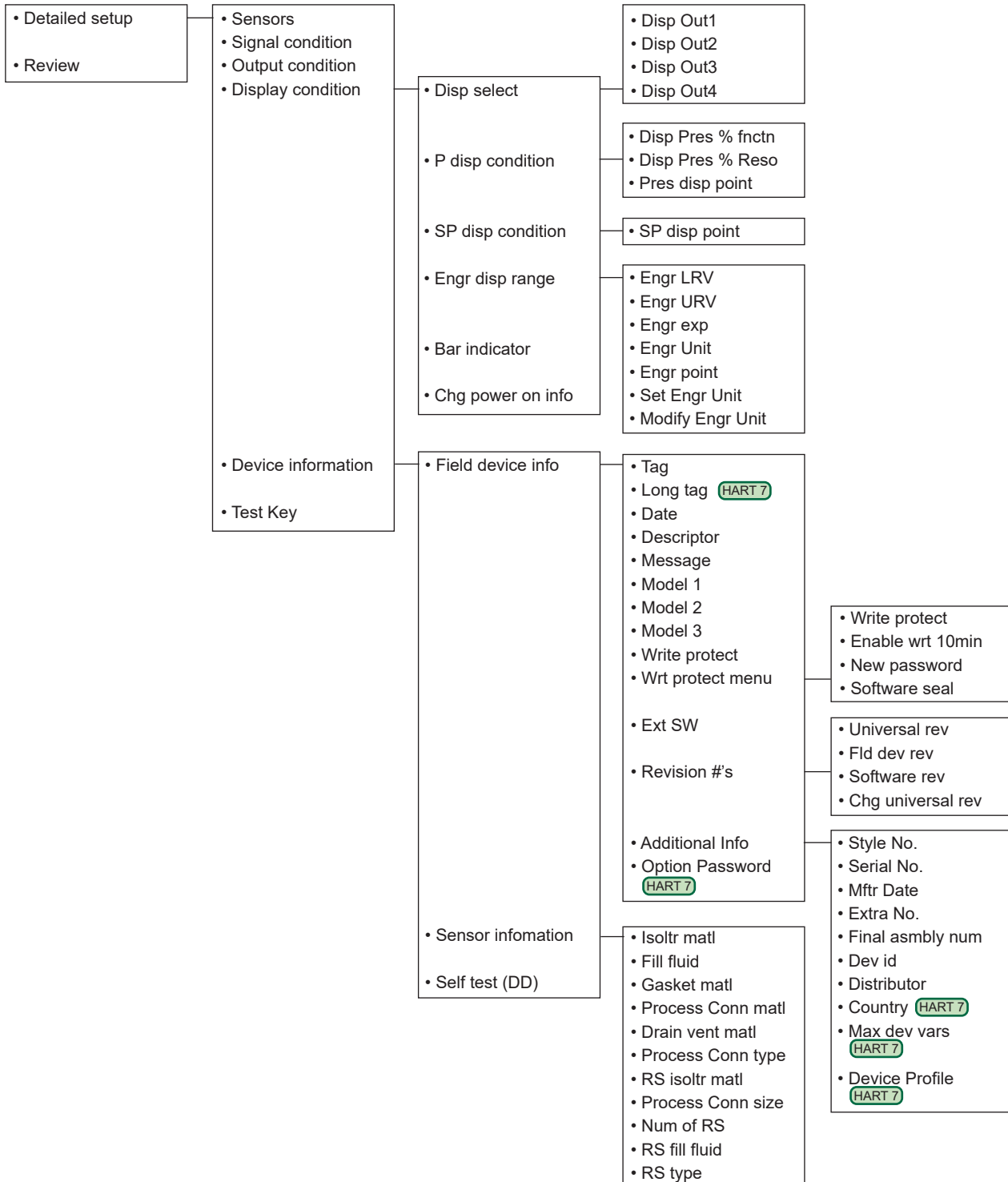

A3.2 Group II: EJX HART 5 DTM based on FDT1.2

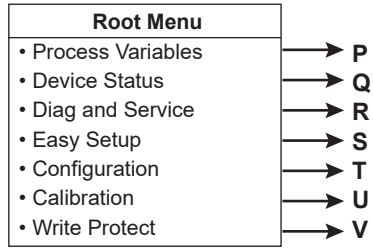

P

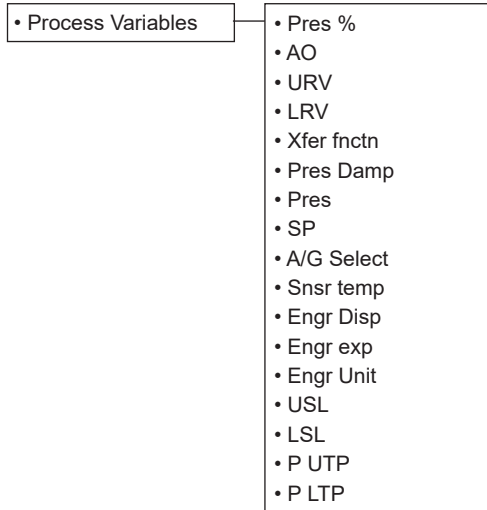

Q

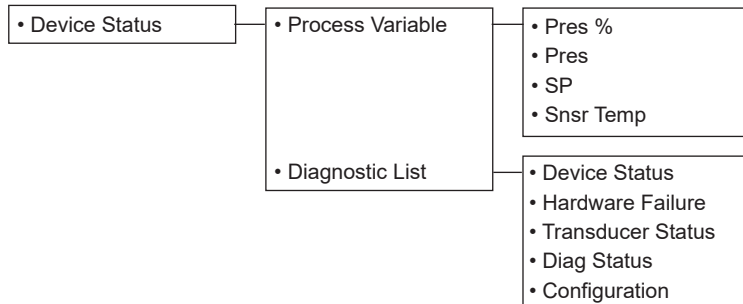

FA0301-21.ai

R

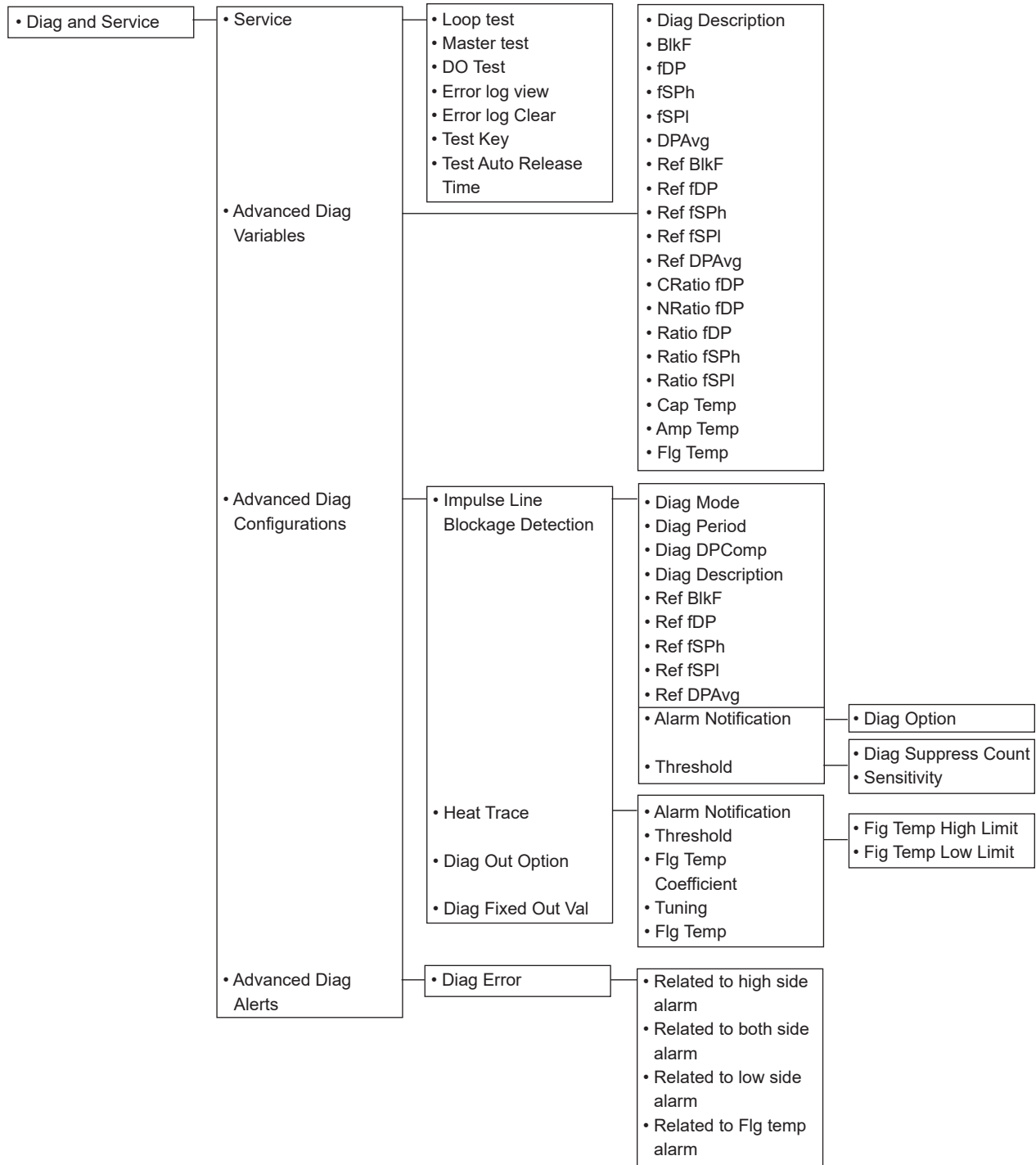

S

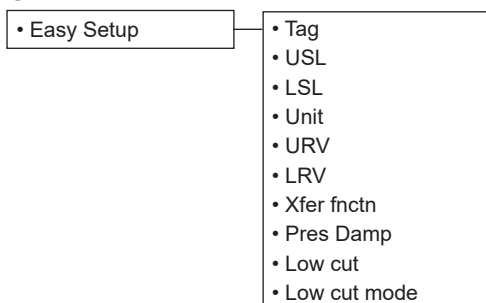

T

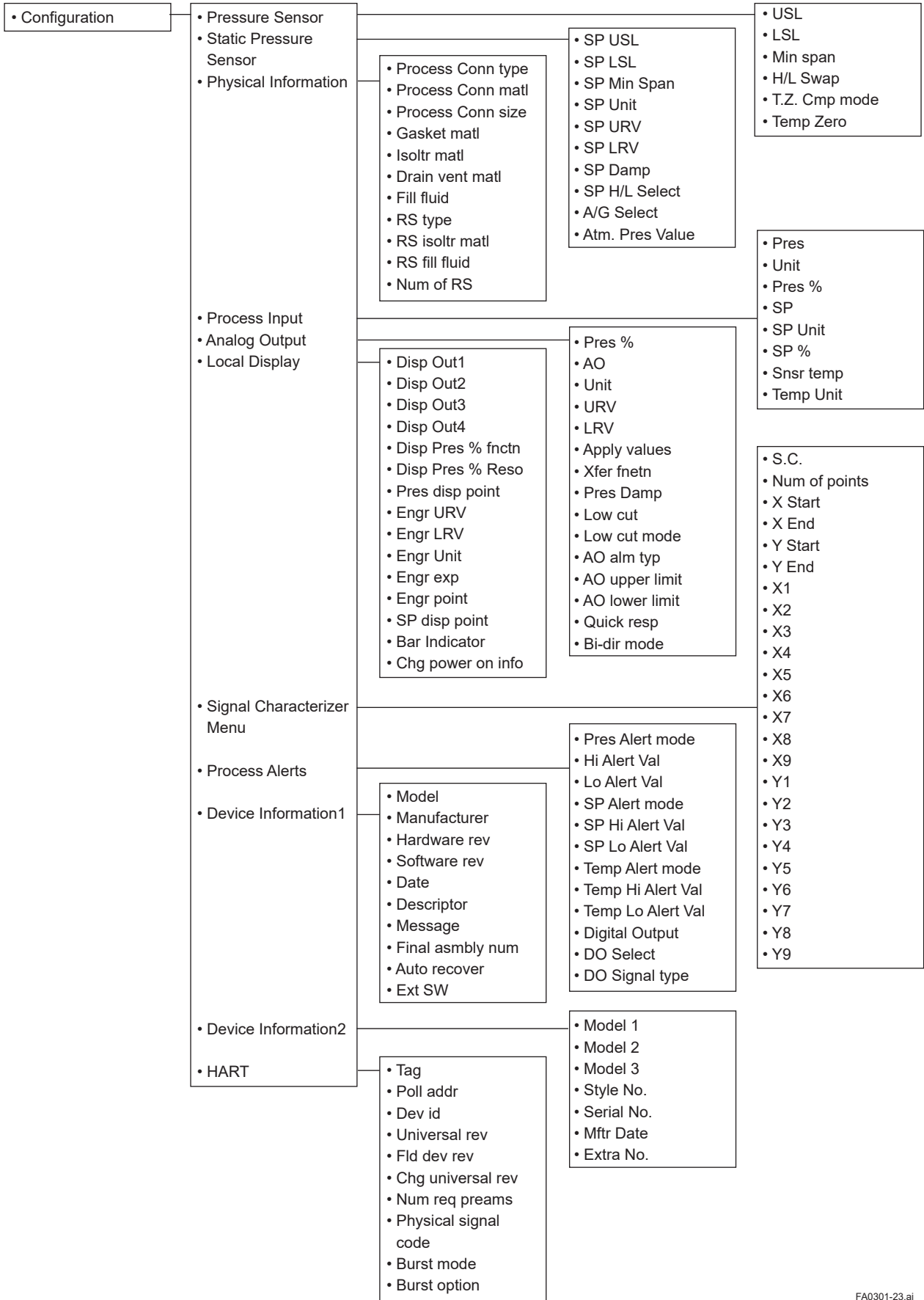

U

- Calibration
- Trim Who
 - Trim Date
 - Trim Loc
 - Trim Desc
 - Pres Zero trim
 - P UTP
 - P LTP
 - P UTD
 - P LTD
 - Pres trim
 - Clear P snsr trim
 - SP UTP
 - SP LTP
 - SP UTD
 - SP LTD
 - Static Pres trim
 - Clear SP snsr trim
 - D/A trim
 - Scaled D/A trim
 - Clear D/A trim

V

- Write Protect
- Write Protect
 - Enter new password

FA0301-24.ai

Revision Information

- Title : DPharp
HART 5/HART 7 Communication Type
(EJX□□□A, EJA□□□E)
- Manual No. : IM 01C25T01-06EN

Edition	Date	Page	Revised Item
1st	June 2010	—	New publication
2nd	Apr. 2012	— 2-1 3-34	Re-edit to a common User's Manual of HART 5 and HART 7. 2.1 Add integral indicator display when powering on. 3.3.18 Add switching procedure for HART protocol revision (HART 5/HART 7)
3rd	June 2012	—	Add EJA series
4th	June 2013	—	Add DTM for EJX and EJA based on FDT 2.0.
5th	June 2014	2-4 3-7, 5-6	Change terminal drawing. Add note for Option Password parameter.
6th	Oct. 2014	— 1-3 1-4 2-1 2-2 2-3 2-4 3-13 3-14 3-16 3-21 3-22 3-25 4-26, 4-30 5-1 5-2 5-2 to 5-6	Add 4-20mA mark. (2-1, 3-6, 3-27, 3-33, 5-1, 5-4, 5-5, A1-1) 1.3 Add descriptions for output signal. 1.4 Add information of Low Power type. 2.1 Add Software Revision display function. 2.2 Add output signal code Q in the table. 2.3 Add information of Low Power type. 2.5 Modify the descriptions. Add figure of 1 to 5 V output. 3.2.3 Add "1 to 5 V" in the NOTE. 3.2.5 Add NOTE. 3.2.6 Add "1 to 5 V". 3.3.2 Add value for 1 to 5 V output. 3.3.9 Change "4 to 20 mA DC" to "analog" 3.3.11 Change "4 to 20 mA" to "analog" 3.3.15 Add value for 1 to 5 V output. 4.3 Add EJX mark. 5 Add information for output type. Add *4. Add EJX mark.
7th	Apr. 2019	1-5 3-13 3-24 5-10 A1-1 A1-2	Delete "1.5 ATEX Documentation." 3.2.3 Add descriptions for Safety Instrumented System. 3.3.13 Add descriptions for Safety Instrumented System. 5. Add *5. A1.2.3 Add note. A1.2.9 Add document title and number.
8th	Nov. 2019	4-3 1-1, A1-1 A3-1 to A3-12	4.1.4 Add NE107 Status Information. Change the description for using the transmitters in Safety Instrumented Systems (SIS) application. Add Appendix 3.