



Miniature Sensors

WORLD-BEAM® Q12 page 44

- Universal housing provides consistent mounting regardless of sensing modes.
- Powerful sensor fits extremely confined areas.
- Opposed, retroreflective and fixed-field sensing modes are available.
- Three fixed-field models offer precise cutoff background suppression.
- Overmolded design delivers enhanced durability and shielding.
- Solid-state outputs are bipolar (NPN and PNP).



T8 page 47

- 8 mm thread ultra-miniature sensor
- Convenient T-shaped package
- 50 or 100 mm diffuse range
- Powerful 2 m opposed range



VS2 page 56

- Ultra-thin opposed and convergent
- Flat front mounting
- Range up to 3 m

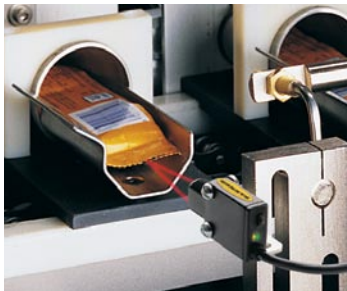

MINI-BEAM®2 page 50

- Single push-button programming
- Wrap-around status indicators
- 12 mm threaded barrel or side mount
- One-third the size of original MINI-BEAM®



VS3 page 59

- Advanced coaxial lens design
- Range up to 1200 mm
- Accurate detection of shiny objects
- Sensing up to the face of retroreflective models



VS1 page 53

- Convergent beam sensors
- 10 or 20 mm convergent point
- Repeatability of 250 microseconds



VS4 page 62

- Low-profile, long-range sensing
- Unique, optically correct lens for narrow side light emission
- Opposed mode, 1000 mm range

WORLD-BEAM® Q12 Series Universal Sensors

- Sets a new industry standard for ultra-miniature photoelectric sensors
- Features a housing just 22 by 8 by 12 mm with bipolar NPN/PNP outputs
- Delivers powerful sensing performance in extremely confined areas
- Rated IP67 for use in the widest range of locations and applications
- Mounts directly on or inside manufacturing equipment, with robust metal-lined mounting holes consistently located on all models
- Uses unique overmolded design for enhanced durability and shielding
- Available in dark- or light-operate models

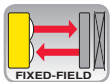
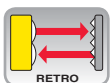
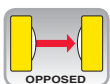

Bright LED operating status indicators visible from 360°

Rugged sealed housing, protected circuitry

Variety of cable and connector options



Ideal for confined applications, the Q12 has a visible red sensing point to simplify sensor setup.



Q12 Opposed

- 2 meter range
- 1.3 millisecond response time
- Embeddable in confined spaces



Q12 Retroreflective

- 700 microsecond response time
- Range of 1.5 m
- Ideal for difficult to access areas and detection of transparent objects (polarized retroreflective models)

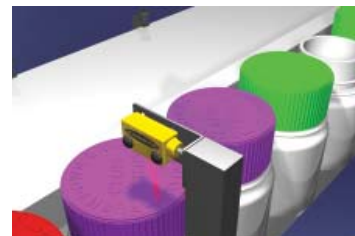

Q12 Fixed-Field

- Range of 15, 30, or 50 mm, depending on model
- Excellent background cutoff
- Low color sensitivity

WORLD-BEAM® Q12 Sensors

- Bright, visible red (640 nm) sensing beam
- Solid-state bipolar outputs: one current sourcing (PNP) and one current sinking (NPN)
- Integral cable or 150 mm pigtail with threaded Pico-style quick-disconnect
- Light operate (LO) or dark operate (DO) by model

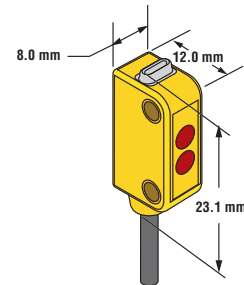
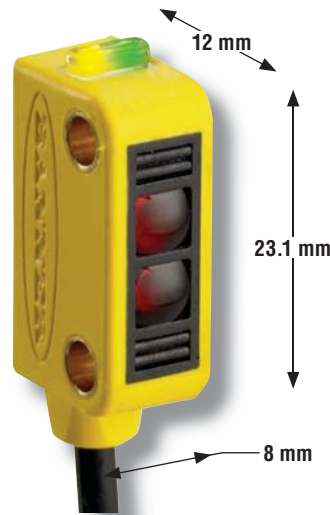



Polarized Retroreflective Models Suffix LP

Opposed, Retroreflective and Fixed-field Models Suffix E, R, LV and FF

WORLD-BEAM® Q12, 10-30V dc

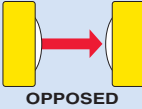
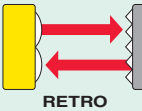

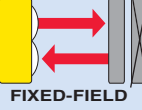
Models	Sensing Mode/LED*	Range	Cable**	Output Type	Excess Gain	Beam Pattern	Data Sheet
Q126E Emitter Q126EQ Emitter	 OPPOSED	2 m	2 m	—	EGCO-1 (p. 428)	BPO-1 (p. 450)	119223
Q12AB6R Q12AB6RQ			Threaded 4-Pin Pico Pigtail QD	Bipolar LO			
Q12RB6R Q12RB6RQ			Threaded 4-Pin Pico Pigtail QD	Bipolar DO			
Q12AB6LV Q12AB6LVQ	 RETRO	1.5 m†	2 m	Bipolar LO	EGCR-1 (p. 431)	BPR-1 (p. 453)	
Q12RB6LV Q12RB6LVQ			Threaded 4-Pin Pico Pigtail QD	Bipolar DO			
Q12AB6LP Q12AB6LPQ	 POLAR RETRO	1 m†	2 m	Bipolar LO	EGCR-2 (p. 431)	BPR-2 (p. 453)	
Q12RB6LP Q12RB6LPQ			Threaded 4-Pin Pico Pigtail QD	Bipolar DO			
Q12AB6FF15 Q12AB6FF15Q	 FIXED-FIELD	15 mm Cutoff	2 m	Bipolar LO	EGCF-1 (p. 441)	—	
Q12RB6FF15 Q12RB6FF15Q			Threaded 4-Pin Pico Pigtail QD	Bipolar DO			

*  Visible Red LED

** For 9 m cable, add suffix **W/30** to the 2 m model number (example, **Q126E W/30**). A model with a pigtail QD requires a mating cable (see page 379).

† Retroreflective range is specified using one model BRT-60X40C retroreflector. Actual sensing range may differ, depending on efficiency and reflective area of the retroreflector in use. See Accessories for more information.

WORLD-BEAM® Q12, 10-30V dc (cont'd)



Models	Sensing Mode/LED*	Range	Cable**	Output Type	Excess Gain	Beam Pattern	Data Sheet
Q12AB6FF30 Q12AB6FF30Q		30 mm Cutoff	2 m Threaded 4-Pin Pico Pigtail QD	Bipolar LO	EGCF-2 (p. 441)	—	119223
Q12RB6FF30 Q12RB6FF30Q			2 m Threaded 4-Pin Pico Pigtail QD	Bipolar DO			
Q12AB6FF50 Q12AB6FF50Q		50 mm Cutoff	2 m Threaded 4-Pin Pico Pigtail QD	Bipolar LO	EGCF-3 (p. 441)	—	
Q12RB6FF50 Q12RB6FF50Q			2 m Threaded 4-Pin Pico Pigtail QD	Bipolar DO			

* Visible Red LED

** For 9 m cable, add suffix **W/30** to the 2 m model number (example, **Q12AB6FF30 W/30**). A model with a pigtail QD requires a mating cable (see page 379).

WORLD-BEAM® Q12 Specifications

Supply Voltage and Current	10 to 30V dc (10% max. ripple) @ 20 mA max. current
Supply Protection Circuitry	Protected against reverse polarity and transient voltages
Output Configuration	Bipolar: One NPN (current sinking) and one PNP (current sourcing); light operate (LO) or dark operate (DO), depending on model
Output Rating	50 mA total across both outputs with overload and short circuit protection OFF-state leakage current: ON-state saturation voltage: NPN: 200 µA NPN: 1.25V @ 50 mA PNP: 10 µA PNP: 1.45V @ 50 mA
Output Protection Circuitry	Protected against false pulse on power-up; short-circuit protected.
Output Response Time	Opposed models: 1.3 milliseconds ON; 900 microseconds OFF All other models: 700 microseconds ON/OFF NOTE: 120 milliseconds delay on power-up; outputs do not conduct during this time.
Repeatability	175 microseconds
Switching Frequency	Opposed models: 385 Hz All other models: 715 Hz
Indicators	2 LED indicators: Green ON steady —Power ON Green flashing —Output overloaded Yellow ON steady —Light sensed Yellow flashing —Marginal signal
Construction	Polarized Retroreflective models: Thermoplastic elastomer housing with glass lens All other models: Thermoplastic elastomer housing with polycarbonate lens
Environmental Rating	IEC IP67
Connections	2 m or 9 m attached PVC cable, or 150 mm pigtail with threaded 4-pin Pico-style quick-disconnect fitting. QD cables are ordered separately. See page 379.
Operating Conditions	Temperature: -20° to +55° C Storage temperature: -30° to +75° C Relative humidity: 90% max. @ 50° C (non-condensing)
Certifications	
Hookup Diagrams	Emitters: DC03 (p. 476) DC Models: DC06 (p. 477)

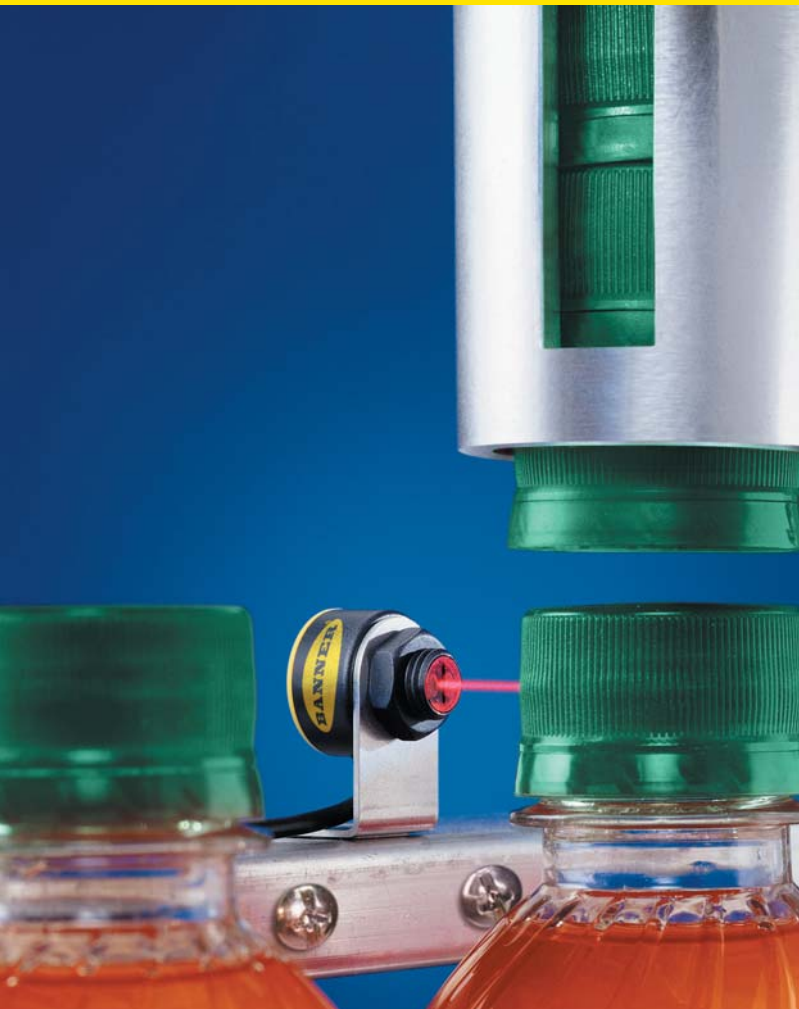

T8

8 mm Threaded-Mount Right-Angle Sensors

- Features EZ-BEAM® technology, with specially designed optics and electronics for reliable sensing without adjustments
- Ideal for presence sensing in small areas previously accessible only to remote sensors and fiber optic cable
- Can replace range-limited 8 mm threaded-mount inductive proximity sensors
- Offers visible sensing beam for easy alignment
- Available in dark- or light-operate models
- Available with integral cable or 150 mm pigtail quick-disconnect
- Offered in opposed mode with 2 m range and diffuse mode with 50 or 100 mm range

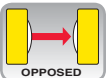

OPPOSED

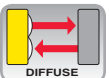

DIFFUSE



BRACKETS

PAGE 350



QD CABLES

8-Pin Threaded Pico

PAGE 378

T8 Sensors

- Visible red sensing beam for easy alignment
- Integral cable or 150 mm pigtail with threaded Pico-style quick-disconnect
- Bright LED indicator on backside of housing



Opposed and Diffuse Models
Suffix E, R and D

T8, 10-30V dc



Models	Sensing Mode/LED*	Range	Cable**	Output Type	Excess Gain	Beam Pattern	Data Sheet
T86EV Emitter T86EVQ Emitter	 OPPOSED	2.0 m	2 m Threaded 3-Pin Pico Pigtail QD	—	EGCO-2 (p. 428)	BPO-2 (p. 450)	68669
T8AN6R T8AN6RQ			2 m Threaded 3-Pin Pico Pigtail QD	NPN/LO			
T8RN6R T8RN6RQ			2 m Threaded 3-Pin Pico Pigtail QD	NPN/DO			
T8AP6R T8AP6RQ			2 m Threaded 3-Pin Pico Pigtail QD	PNP/LO			
T8RP6R T8RP6RQ			2 m Threaded 3-Pin Pico Pigtail QD	PNP/DO			
T8AN6D50 T8AN6D50Q	 DIFFUSE	50 mm	2 m Threaded 3-Pin Pico Pigtail QD	NPN/LO	EGCD-1 (p. 434)	BPD-1 (p. 456)	67584
T8RN6D50 T8RN6D50Q			2 m Threaded 3-Pin Pico Pigtail QD	NPN/DO			
T8AP6D50 T8AP6D50Q			2 m Threaded 3-Pin Pico Pigtail QD	PNP/LO			
T8RP6D50 T8RP6D50Q			2 m Threaded 3-Pin Pico Pigtail QD	PNP/DO			
T8AN6D100 T8AN6D100Q		100 mm	2 m Threaded 3-Pin Pico Pigtail QD	NPN/LO	EGCD-2 (p. 434)	BPD-2 (p. 456)	
T8RN6D100 T8RN6D100Q			2 m Threaded 3-Pin Pico Pigtail QD	NPN/DO			
T8AP6D100 T8AP6D100Q			2 m Threaded 3-Pin Pico Pigtail QD	PNP/LO			
T8RP6D100 T8RP6D100Q			2 m Threaded 3-Pin Pico Pigtail QD	PNP/DO			

* Visible Red LED

** For 9 m cable, add suffix **W/30** to the 2 m model number (example, **T8AN6D50 W/30**). A model with a pigtail QD requires a mating cable (see page 378).

T8 Specifications

Supply Voltage and Current	10 to 30V dc (10% max. ripple) at less than 25 mA (exclusive of load)
Supply Protection Circuitry	Protected against reverse polarity and transient voltages
Output Configuration	SPST solid-state switch NPN (current sinking) or PNP (current sourcing), depending on model. Light Operate (LO) or Dark Operate (DO), depending on model.
Output Rating	50 mA max. Off-state leakage current: less than 1 μ A at 24V dc On-state saturation voltage: less than 0.25V at 10 mA dc; less than 0.5V at 50 mA dc
Output Protection Circuitry	Protected against false pulse on power-up and continuous overload or short circuit of outputs Overload trip point \geq 100 mA
Output Response Time	1 millisecond ON and 0.5 milliseconds OFF NOTE: Maximum 100 milliseconds (150 milliseconds for Diffuse models) delay on power-up; output does not conduct during this time.
Repeatability	Opposed models: 100 microseconds Diffuse models: 160 microseconds

T8 Specifications (cont'd)	
Indicators	<p>Opposed Models: Receiver has both Green and Red LEDs Emitter has one Green LED Green ON steady: power to sensor is ON Green flashing: output overload Red ON steady: light is sensed Red flashing: marginal excess gain (1-1.5x) in light condition</p> <p>Diffuse Models: Red ON steady: On when light is sensed</p>
Construction	Reinforced polycarbonate/ABS alloy housing, acrylic window
Environmental Rating	IEC IP67; NEMA 6
Connections	2 m or 9 m attached cable: 3-wire with PVC outer cable jacket, or 150 mm pigtail with threaded 3-pin Pico-style quick-disconnect fitting. QD cables are ordered separately. See page 378.
Operating Conditions	Temperature: -20° to +55° C Relative humidity: 80% at 50° C (non-condensing)
Vibration and Mechanical Shock	<p>Vibration: All models meet IEC 60068-2-6, IEC 60947-5-2, UL491 Section 40, MIL-STD-202F Method 201A; 10 to 60 Hz, 0.5 mm peak to peak</p> <p>Shock: All models meet IEC 60068-2-27, IEC 60947-5-2; 30g peak acceleration, 11 millisecond pulse duration, half-sine wave pulse shape</p>
Application Notes	Reinforced polycarbonate/ABS alloy 8 mm threaded nut (included). Optional mounting bracket is available. See page 350.
Certifications	
Hookup Diagrams	Emitters: DC03 (p. 476) NPN Models: DC01 (p. 476) PNP Models: DC02 (p. 476)

MINI-BEAM® 2

12 mm Threaded-Barrel Right-Angle Sensors

- Delivers MINI-BEAM® performance in a package 66% smaller than the original
- Available in opposed, polarized and non-polarized retroreflective, diffuse and divergent diffuse, and convergent modes
- Features easy push-button setup
- Solid-state complementary (SPDT) outputs

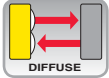
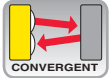
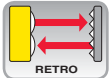
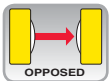

MINI-BEAM® 2 Sensors

- Incremental Gain control push button
- Dual-LED multi-function indicators
- 2 m or 9 m attached cable, or 150 mm Pico-style quick-disconnect pigtail
- Optional 12 mm threaded lens mounting on some models

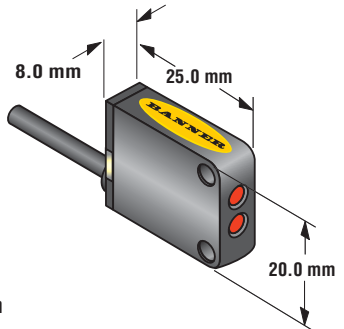
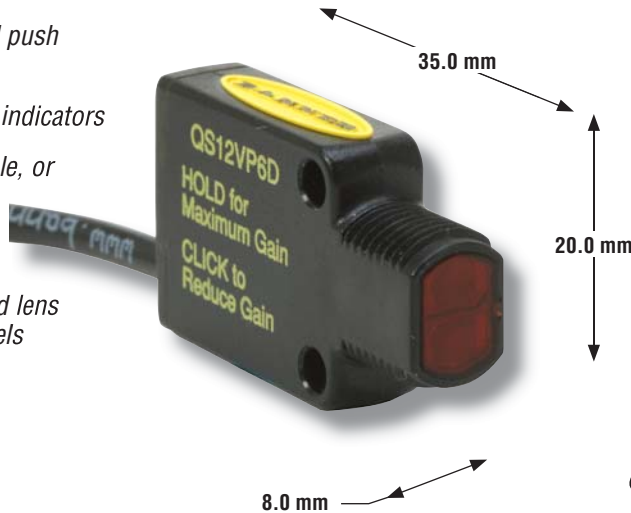

Divergent Diffuse Models
Suffix DBZ and W

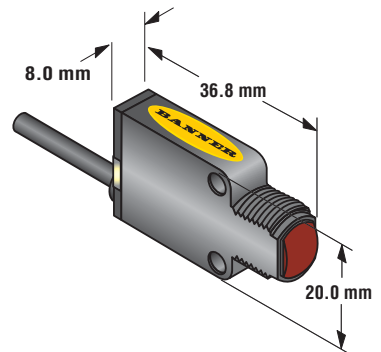

Opposed and Convergent Models
Suffix E, R and CV



Retroreflective and Diffuse Models
Suffix LV, LP and D



MINI-BEAM® 2, 10-30V dc

Models	Sensing Mode/LED*	Range	Cable**	Output Type	Excess Gain	Beam Pattern	Data Sheet
QS126E Emitter QS126EQ Emitter		4 m	2 m 4-pin Pico Pigtail QD	—	EGCO-3 (p. 428)	BPO-3 (p. 450)	59040
QS12VN6R QS12VN6RQ			2 m 4-pin Pico Pigtail QD	NPN			
QS12VP6R QS12VP6RQ			2 m 4-pin Pico Pigtail QD	PNP			
QS12VN6LV QS12VN6LVQ		2 m†	2 m 4-pin Pico Pigtail QD	NPN	EGCR-3 (p. 431)	BPR-3 (p. 453)	59040
QS12VP6LV QS12VP6LVQ			2 m 4-pin Pico Pigtail QD	PNP			
QS12VN6LP QS12VN6LPQ		1 m†	2 m 4-pin Pico Pigtail QD	NPN	EGCR-4 (p. 431)	BPR-4 (p. 453)	59040
QS12VP6LP QS12VP6LPQ			2 m 4-pin Pico Pigtail QD	PNP			
QS12VN6CV10 QS12VN6CV10Q		10 mm	2 m 4-pin Pico Pigtail QD	NPN	EGCC-1 (p. 437)	BPC-1 (p. 459)	59040
QS12VP6CV10 QS12VP6CV10Q			2 m 4-pin Pico Pigtail QD	PNP			
QS12VN6CV20 QS12VN6CV20Q		20 mm	2 m 4-pin Pico Pigtail QD	NPN	EGCC-2 (p. 437)	BPC-2 (p. 459)	
QS12VP6CV20 QS12VP6CV20Q			2 m 4-pin Pico Pigtail QD	PNP			
QS12VN6D QS12VN6DQ		180 mm	2 m 4-pin Pico Pigtail QD	NPN	EGCD-3 (p. 434)	BPD-3 (p. 456)	59040
QS12VP6D QS12VP6DQ			2 m 4-pin Pico Pigtail QD	PNP			
QS12VN6DBZ QS12VN6DBZQ			2 m 4-pin Pico Pigtail QD	NPN	EGCD-4 (p. 434)	BPD-4 (p. 456)	
QS12VP6DBZ QS12VP6DBZQ			2 m 4-pin Pico Pigtail QD	PNP			
QS12VN6W QS12VN6WQ				50 mm	2 m 4-pin Pico Pigtail QD	NPN	
QS12VP6W QS12VP6WQ	2 m 4-pin Pico Pigtail QD	PNP					

* → Visible Red LED

** For 9 m cable, add suffix **W/30** to the 2 m model number (example, **QS12VN6D W/30**). A model with a pigtail QD requires a mating cable (see page 378).

† Range specifications for retroreflective sensors are largely dependent on target size and design. See Accessories section for more information on reflectors.

MINI-BEAM® 2 Specifications

Supply Voltage and Current	10 to 30V dc (10% max. ripple) at less than 25 mA, exclusive of load
Supply Protection Circuitry	Protected against reverse polarity and transient voltages
Output Configuration	Solid state complementary (SPDT): NPN or PNP (current sinking or sourcing) output models available
Output Rating	150 mA max. each output at 25° C OFF-state leakage current: less than 10 µA @ 30V dc ON-state saturation voltage: less than 1V @ 10 mA; less than 2.0V @ 150 mA
Output Protection Circuitry	Protected against false pulse on power-up and continuous overload or short circuit of outputs
Output Response Time	Opposed Mode: 8 milliseconds ON, 4 milliseconds OFF All others: 1.5 milliseconds NOTE: 500 millisecond delay on power-up, outputs do not conduct during this time
Repeatability	Opposed Mode: 1 millisecond All others: 175 microseconds
Adjustments	One rubber-sealed push button Hold: Max. gain Click: Reduce gain one increment
Indicators	2 LEDs, visible from back and side of sensor: 1 green, 1 amber Green ON steady: Power ON Amber steady: Light sensed Green flashing rapidly 5 times: Max. gain Green Single flash: Click registered, gain reduced by one increment Amber/Green alternating: Minimum gain (can not reduce further)
Construction	Black polycarbonate/ABS alloy housing; totally encapsulated circuitry
Environmental Rating	IEC IP67; NEMA 6
Connections	2 m or 9 m PVC cable; or 4-pin Pico-style 150 mm pigtail QD. QD cables are ordered separately. See page 378.
Operating Conditions	Temperature: -20° to +55° C Relative humidity: 90% at 50° C (non-condensing)
Certifications	
Hookup Diagrams	Emitters: DC03 (p. 476) NPN Models: DC04 (p. 476) PNP Models: DC05 (p. 477)

VS1

Miniature Convergent-Mode Sensors

- Features EZ-BEAM® technology, with specially designed optics and electronics for reliable sensing without adjustments
- Available with 10 or 20 mm focus point
- Available in dark- or light-operate models
- Provides high-quality, low-cost replacement for competitive miniature sensors
- Available with integral cable or 150 mm pigtail quick-disconnect
- Includes M2 stainless steel mounting hardware; optional mounting brackets available

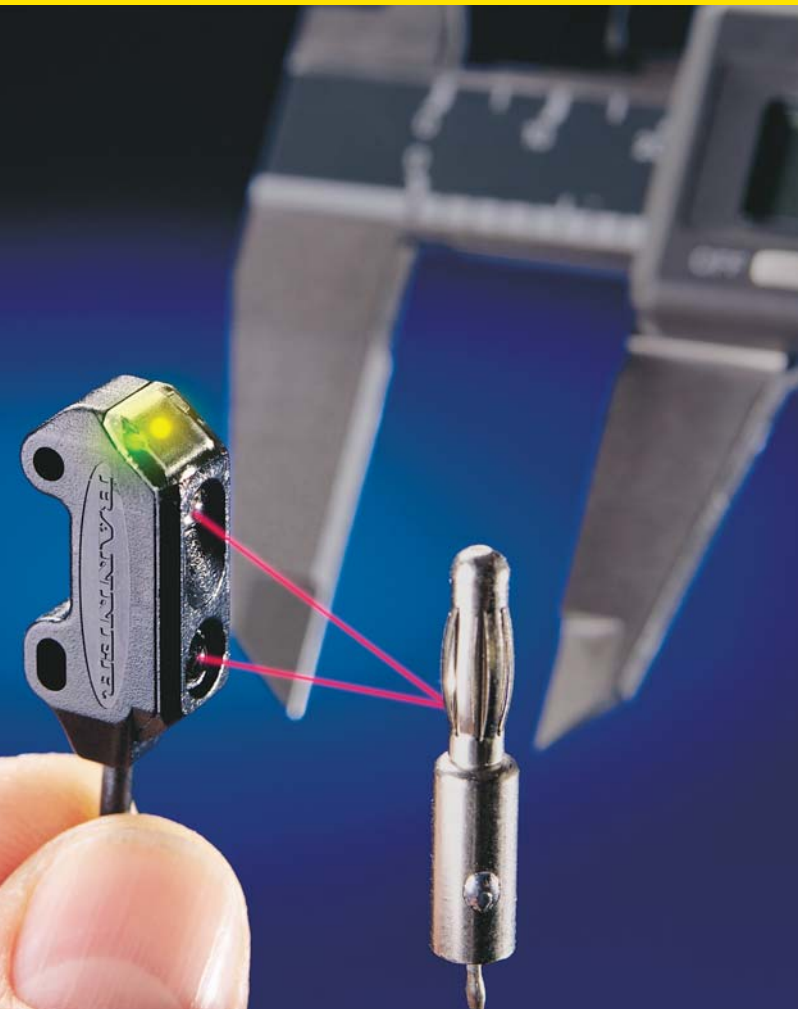

VS1 Sensors

- Dual-LED multi-function indicators
- Visible red or infrared convergent sensing beam
- 2 m or 9 m attached cable, or 150 mm pigtail with threaded 3-pin Pico-style quick-disconnect

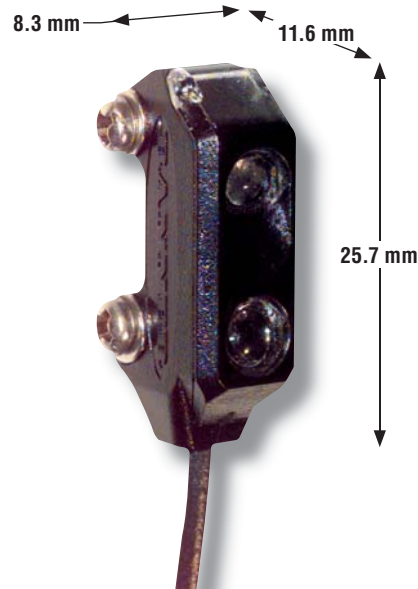

Convergent Models
Suffix CV, C1 and C2

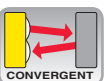

VS1, 10-30V dc

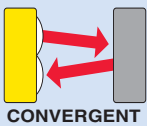
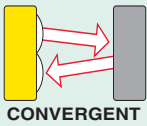

Models	Sensing Mode/LED*	Range	Cable**	Output Type	Excess Gain	Beam Pattern	Data Sheet
VS1AN5CV10 VS1AN5CV10Q		10 mm ±5 mm	2 m Threaded 3-Pin Pico Pigtail QD	NPN/ LO	EGCC-3 (p. 437)	BPC-3 (p. 459)	56465
VS1RN5CV10 VS1RN5CV10Q			2 m Threaded 3-Pin Pico Pigtail QD	NPN/ DO			
VS1AP5CV10 VS1AP5CV10Q			2 m Threaded 3-Pin Pico Pigtail QD	PNP/ LO			
VS1RP5CV10 VS1RP5CV10Q			2 m Threaded 3-Pin Pico Pigtail QD	PNP/ DO			
VS1AN5CV20 VS1AN5CV20Q		20 mm ±10 mm	2 m Threaded 3-Pin Pico Pigtail QD	NPN/ LO	EGCC-4 (p. 437)	BPC-4 (p. 459)	
VS1RN5CV20 VS1RN5CV20Q			2 m Threaded 3-Pin Pico Pigtail QD	NPN/ DO			
VS1AP5CV20 VS1AP5CV20Q			2 m Threaded 3-Pin Pico Pigtail QD	PNP/ LO			
VS1RP5CV20 VS1RP5CV20Q			2 m Threaded 3-Pin Pico Pigtail QD	PNP/ DO			
VS1AN5C10 VS1AN5C10Q		10 mm ±5 mm	2 m Threaded 3-Pin Pico Pigtail QD	NPN/ LO	EGCC-5 (p. 437)	BPC-5 (p. 459)	56939
VS1RN5C10 VS1RN5C10Q			2 m Threaded 3-Pin Pico Pigtail QD	NPN/ DO			
VS1AP5C10 VS1AP5C10Q			2 m Threaded 3-Pin Pico Pigtail QD	PNP/ LO			
VS1RP5C10 VS1RP5C10Q			2 m Threaded 3-Pin Pico Pigtail QD	PNP/ DO			
VS1AN5C20 VS1AN5C20Q		20 mm ±10 mm	2 m Threaded 3-Pin Pico Pigtail QD	NPN/ LO	EGCC-6 (p. 437)	BPC-6 (p. 459)	
VS1RN5C20 VS1RN5C20Q			2 m Threaded 3-Pin Pico Pigtail QD	NPN/ DO			
VS1AP5C20 VS1AP5C20Q			2 m Threaded 3-Pin Pico Pigtail QD	PNP/ LO			
VS1RP5C20 VS1RP5C20Q			2 m Threaded 3-Pin Pico Pigtail QD	PNP/ DO			

*  Infrared LED  Visible Red LED

** For 9 m cable, add suffix **W/30** to the 2 m model number (example, **VS1AN5CV10 W/30**). A model with a pigtail QD requires a mating cable (see page 378).

VS1 Specifications

Supply Voltage and Current	10 to 30V dc (10% max. ripple) at less than 25 mA (exclusive of load)
Supply Protection Circuitry	Protected against reverse polarity and transient voltages
Output Configuration	SPST solid-state switch NPN (current sinking) or PNP (current sourcing), depending on model. Light Operate (LO) or Dark Operate (DO) models
Output Rating	50 mA max. Off-state leakage current: less than 1 μ A at 24V dc On-state saturation voltage: less than 0.25V at 10 mA dc; less than 0.5V at 50 mA dc
Output Protection Circuitry	Protected against false pulse on power-up and continuous overload or short circuit of outputs Overload trip point \geq 100 mA
Output Response Time	1 millisecond ON and OFF
Repeatability	250 microseconds
Indicators	Two LEDs: Green and Yellow Green ON steady: power to sensor is ON Green flashing: output overload Yellow ON steady: light is sensed Yellow flashing: marginal excess gain (1-1.5x) in light condition
Construction	Black ABS/polycarbonate housing with clear acrylic lens
Environmental Rating	IP67; NEMA 6
Connections	2 m or 9 m attached cable: 3-wire with PVC outer cable jacket; or 150 mm pigtail with threaded 3-pin Pico-style quick-disconnect fitting. QD cables are ordered separately. See page 378.
Operating Conditions	Temperature: -20° to +55° C Relative humidity: 80% at 50° C (non-condensing)
Application Notes	M2 stainless steel mounting hardware included. Optional mounting brackets are available. See page 350.
Certifications	
Hookup Diagrams	NPN Models: DC01 (p. 476) PNP Models: DC02 (p. 476)

VS2

Ultra-Thin Miniature Sensors

- Features EZ-BEAM® technology, with specially designed optics and electronics for reliable sensing without adjustments
- Available in opposed and convergent modes
- Ideal as a low-cost, high-quality miniaturized solution for confined areas
- Includes M2 stainless steel mounting hardware; optional mounting brackets available
- Available with integral cable or 150 mm pigtail with threaded Pico-style quick-disconnect
- Available in dark- or light-operate models

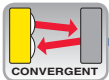
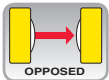
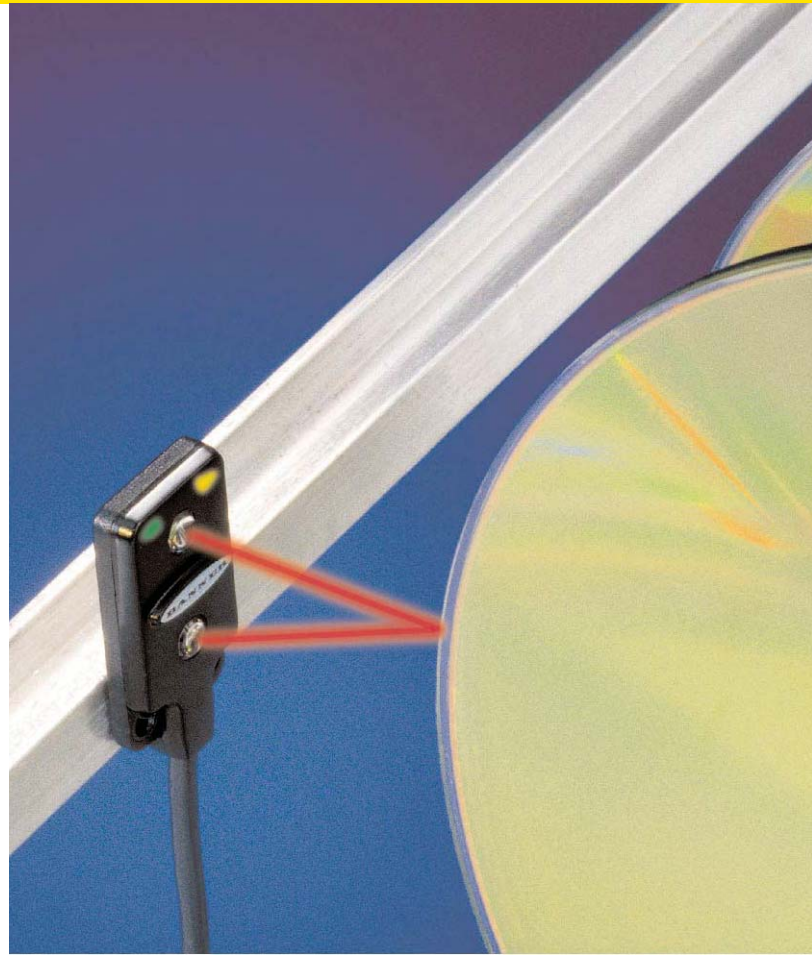

VS2 Sensors

- Dual-LED multi-function indicators
- 8 mm mounting centers
- Visible or infrared sensing beam
- 2 m or 9 m attached cable, or 150 mm pigtail with threaded 3-pin Pico-style quick-disconnect



**Opposed Models
Suffix E and R**

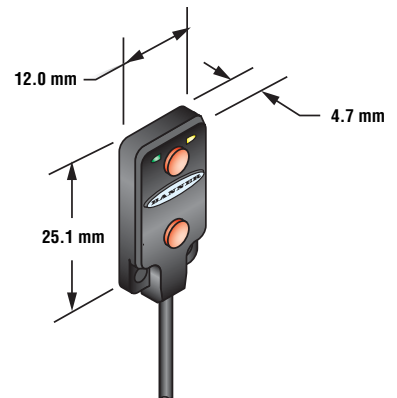

**Convergent Models
Suffix C**

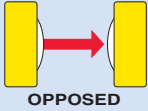
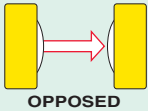
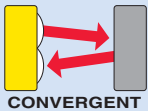

VS2, 10-30V dc

Models [†]	Sensing Mode/LED*	Range	Cable**	Output Type	Excess Gain	Beam Pattern	Data Sheet
VS25EV Emitter VS25EVQ Emitter		Optimum up to 600 mm, 1.2 m max.	2 m Threaded 3-Pin Pico Pigtail QD	—	EGCO-4 (p. 428)	BPO-4 (p. 450)	57248
VS2AN5R VS2AN5RQ			2 m Threaded 3-Pin Pico Pigtail QD	NPN/ LO			
VS2RN5R VS2RN5RQ			2 m Threaded 3-Pin Pico Pigtail QD	NPN/ DO			
VS2AP5R VS2AP5RQ			2 m Threaded 3-Pin Pico Pigtail QD	PNP/ LO			
VS2RP5R VS2RP5RQ			2 m Threaded 3-Pin Pico Pigtail QD	PNP/ DO			
VS25E Emitter VS25EQ Emitter		3.0 m	2 m Threaded 3-Pin Pico Pigtail QD	—	EGCO-5 (p. 428)	BPO-5 (p. 450)	57248
VS2AN5R VS2AN5RQ			2 m Threaded 3-Pin Pico Pigtail QD	NPN/ LO			
VS2RN5R VS2RN5RQ			2 m Threaded 3-Pin Pico Pigtail QD	NPN/ DO			
VS2AP5R VS2AP5RQ			2 m Threaded 3-Pin Pico Pigtail QD	PNP/ LO			
VS2RP5R VS2RP5RQ			2 m Threaded 3-Pin Pico Pigtail QD	PNP/ DO			
VS2AN5CV15 VS2AN5CV15Q		15 mm ±5 mm	2 m Threaded 3-Pin Pico Pigtail QD	NPN/ LO	EGCC-7 (p. 437)	BPC-7 (p. 459)	65411
VS2RN5CV15 VS2RN5CV15Q			2 m Threaded 3-Pin Pico Pigtail QD	NPN/ DO			
VS2AP5CV15 VS2AP5CV15Q			2 m Threaded 3-Pin Pico Pigtail QD	PNP/ LO			
VS2RP5CV15 VS2RP5CV15Q			2 m Threaded 3-Pin Pico Pigtail QD	PNP/ DO			
VS2AN5CV30 VS2AN5CV30Q		30 mm ±10 mm	2 m Threaded 3-Pin Pico Pigtail QD	NPN/ LO	EGCC-8 (p. 437)	BPC-8 (p. 459)	
VS2RN5CV30 VS2RN5CV30Q	2 m Threaded 3-Pin Pico Pigtail QD		NPN/ DO				
VS2AP5CV30 VS2AP5CV30Q	2 m Threaded 3-Pin Pico Pigtail QD		PNP/ LO				
VS2RP5CV30 VS2RP5CV30Q	2 m Threaded 3-Pin Pico Pigtail QD		PNP/ DO				

* Infrared LED Visible Red LED

** For 9 m cable, add suffix **W/30** to the 2 m model number (example, **VS2RP5R W/30**). A model with a pigtail QD requires a mating cable (see page 378).

† Opposed-mode models also sold as pairs. Contact factory for more information.

VS2 Specifications

Supply Voltage and Current	10 to 30V dc (10% max. ripple) at less than 25 mA (exclusive of load)
Supply Protection Circuitry	Protected against reverse polarity and transient voltages
Output Configuration	SPST solid-state switch: NPN (current sinking) or PNP (current sourcing), depending on model. Light Operate (LO) or Dark Operate (DO), depending on model.
Output Rating	50 mA max. Off-state leakage current: less than 1 μ A at 24V dc On-state saturation voltage: less than 0.25V at 10 mA dc; less than 0.5V at 50 mA dc
Output Protection Circuitry	Protected against false pulse on power-up and continuous overload or short circuit of outputs Overload trip point \geq 100 mA
Output Response Time	Opposed: 1 millisecond ON and 0.5 millisecond OFF; Convergent: 1 millisecond ON and OFF NOTE: Maximum 100 millisecond (opposed mode) and 150 millisecond (convergent) delay on power-up; output does not conduct during this time.
Repeatability	Opposed Mode: 100 microseconds Convergent: 160 microseconds
Indicators	Two LEDs: Green and Yellow Green ON steady: power to sensor is ON Green flashing: output overload Yellow ON steady: light is sensed Yellow flashing: marginal excess gain (1-1.5x) in light condition (opposed mode only)
Construction	Opposed: Black ABS housing with clear MABS lens Convergent: Black ABS housing with acrylic lens
Environmental Rating	IEC IP67; NEMA 6
Connections	2 m or 9 m attached cable, 3-wire with PVC outer cable jacket; or 3-pin Pico-style 150 mm threaded pigtail quick-disconnect fitting. QD cables are ordered separately. See page 378.
Operating Conditions	Temperature: -20° to +55° C Relative humidity: 80% at 50° C (non-condensing)
Vibration and Mechanical Shock	Vibration: All models meet IEC 60068-2-6, IEC 60947-5-2, UL491 Section 40, MIL-STD-202F Method 201A; 10 to 60 Hz, 0.5 mm peak to peak Shock: All models meet IEC 60068-2-27, IEC 60947-5-2; 30g peak acceleration, 11 millisecond pulse duration, half-sine wave pulse shape
Application Notes	M2 stainless steel mounting hardware included. Optional mounting brackets are available. See page 350.
Certifications	
Hookup Diagrams	Emitters: DC03 (p. 476) NPN Models: DC01 (p. 476) PNP Models: DC02 (p. 476)



VS3

Miniature Sensors with Advanced Optics

- Features EZ-BEAM® technology, with specially designed optics and electronics for reliable sensing without adjustments
- Offers extremely compact self-contained miniature design
- Available in opposed and retroreflective sensing modes
- Uses coaxial optics on retroreflective models to eliminate blind areas at close range
- Features visible sensing beam for easy alignment
- Available in dark- or light-operate models
- Available with integral cable or threaded Pico-style quick-disconnect

VS3 Sensors

- Dual-LED multi-function indicators
- 2 m or 9 m integral cable, or 3-pin threaded Pico-style quick disconnect
- Extremely compact housing



**Opposed, Non-Polarized Retroreflective Models
Suffix R, EV and LV**

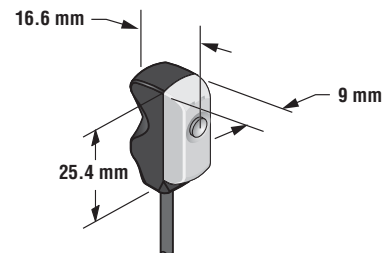

**Polarized Retroreflective Models
Suffix LP**

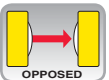

VS3, 10-30V dc



Models†	Sensing Mode/LED*	Range	Cable**	Output Type	Excess Gain	Beam Pattern	Data Sheet
VS35EV Emitter VS35EVQ Emitter		1.2 m	2 m Threaded 3-Pin Pico QD	—	EGCO-6 (p. 428)	BPO-6 (p. 450)	63227
VS3AN5R VS3AN5RQ			2 m Threaded 3-Pin Pico QD	NPN/LO			
VS3RN5R VS3RN5RQ			2 m Threaded 3-Pin Pico QD	NPN/DO			
VS3AP5R VS3AP5RQ			2 m Threaded 3-Pin Pico QD	PNP/LO			
VS3RP5R VS3RP5RQ			2 m Threaded 3-Pin Pico QD	PNP/DO			
VS3AN5XLV VS3AN5XLVQ		250 mm††	2 m Threaded 3-Pin Pico QD	NPN/LO	EGCR-5 (p. 431)	BPR-5 (p. 453)	63226
VS3RN5XLV VS3RN5XLVQ			2 m Threaded 3-Pin Pico QD	NPN/DO			
VS3AP5XLV VS3AP5XLVQ			2 m Threaded 3-Pin Pico QD	PNP/LO			
VS3RP5XLV VS3RP5XLVQ			2 m Threaded 3-Pin Pico QD	PNP/DO			
VS3AN5XLP VS3AN5XLPQ		250 mm††	2 m Threaded 3-Pin Pico QD	NPN/LO	EGCR-6 (p. 431)	BPR-6 (p. 453)	63226
VS3RN5XLP VS3RN5XLPQ			2 m Threaded 3-Pin Pico QD	NPN/DO			
VS3AP5XLP VS3AP5XLPQ			2 m Threaded 3-Pin Pico QD	PNP/LO			
VS3RP5XLP VS3RP5XLPQ			2 m Threaded 3-Pin Pico QD	PNP/DO			

* Visible Red LED

** For 9 m cable, add suffix **W/30** to the 2 m model number (example, **VS3AN5XLV W/30**). A model with a pigtail QD requires a mating cable (see page 378).

† Opposed-mode models also sold as pairs. Contact factory for more information.

†† Retroreflective range is specified using one model BRT-32X20AM retroreflector. Actual sensing range may differ, depending on efficiency and reflective area of the retroreflector in use. See Accessories for more information.

VS3 Specifications

Supply Voltage and Current	10 to 30V dc (10% max. ripple) at less than 25 mA (exclusive of load)
Supply Protection Circuitry	Protected against reverse polarity and transient voltages
Output Configuration	SPST solid-state switch NPN (current sinking) or PNP (current sourcing), depending on model. Light Operate (LO) or Dark Operate (DO), depending on model.
Output Protection Circuitry	Protected against false pulse on power-up and continuous overload or short circuit of outputs. Overload trip point \geq 100 mA
Output Rating	50 mA max. Off-state leakage current: less than 1 μ A at 24V dc On-state saturation voltage: less than 0.25V at 10 mA dc; less than 0.5V at 50 mA dc
Output Response Time	Opposed: 1 millisecond ON and 0.5 millisecond OFF; Retroreflective: 1 millisecond ON and OFF NOTE: Maximum 100 millisecond (opposed mode) and 150 millisecond (retroreflective) delay on power-up; output does not conduct during this time.
Repeatability	Opposed: 100 microseconds Retroreflective: 160 microseconds
Indicators	Two LEDs: Green and Yellow Green ON steady: power to sensor is ON Green flashing: output overload Yellow ON steady: light is sensed Yellow flashing: marginal excess gain (1-1.5x) in light condition (opposed mode only)
Construction	Opposed and Non-polarized Retroreflective Models: Black ABS housing with acrylic lens Polarized Retroreflective Models: Black ABS housing with glass lens and acrylic cover
Environmental Rating	IEC IP67; NEMA 6
Connections	2 m or 9 m attached cable, 3-wire with PVC outer cable jacket; or 3-pin Pico-style threaded quick-disconnect fitting. QD cables are ordered separately. See page 378.
Operating Conditions	Temperature: -20° to +55° C Relative humidity: 80% at 50° C (non-condensing)
Vibration and Mechanical Shock	Vibration: All models meet IEC 60068-2-6, IEC 60947-5-2, UL491 Section 40, MIL-STD-202F Method 201A; 10 to 60 Hz, 0.5 mm peak to peak Shock: All models meet IEC 60068-2-27, IEC 60947-5-2; 30g peak acceleration, 11 millisecond pulse duration, half-sine wave pulse shape
Application Notes	M3 stainless steel mounting hardware included. Optional mounting brackets are available. See page 350.
Certifications	
Hookup Diagrams	Emitters: DC03 (p. 476) NPN Models: DC01 (p. 476) PNP Models: DC02 (p. 476)

VS4 Series

Miniature Sensors

VS4

Ultra-Thin Right-Angle Miniature Sensors

- Features EZ-BEAM® technology, with specially designed optics and electronics for reliable sensing without adjustments
- Features totally self-contained opposed-mode miniature design
- Offers advanced sensing circuitry for powerful, precise sensing
- Features bright visible red sensing beam for easy alignment
- Delivers powerful 1.0 m sensing range
- Available in dark- or light-operate models
- Provides horizontal mounting capability and extremely small size for mounting in narrow confines

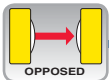

OPPOSED



BRACKETS

PAGE 350



QD CABLES

3-Pin Threaded Pico

PAGE 378



APERTURES

PAGE 407

VS4 Sensors

- Two bright LED indicators
- Visible red sensing beam
- 2 m or 9 m attached cable, or 150 mm pigtail with threaded 3-pin Pico-style quick-disconnect
- Low-profile housing—only 4.75 mm thick



Detailed Dimensions

**Opposed Models
Suffix E and R**



VS4, 10-30V dc

Models	Sensing Mode/LED*	Range	Cable**	Output Type	Excess Gain	Beam Pattern	Data Sheet
VS4EV Emitter VS4EVQ Emitter		1.0 m	2 m Threaded 3-pin Pico Pigtail QD	—	EGCO-7 (p. 428)	BPO-7 (p. 450)	69421
VS4AN5R VS4AN5RQ			2 m Threaded 3-pin Pico Pigtail QD	NPN/ LO			
VS4RN5R VS4RN5RQ			2 m Threaded 3-pin Pico Pigtail QD	NPN/ DO			
VS4AP5R VS4AP5RQ			2 m Threaded 3-pin Pico Pigtail QD	PNP/ LO			
VS4RP5R VS4RP5RQ			2 m Threaded 3-pin Pico Pigtail QD	PNP/ DO			

* Visible Red LED

** For 9 m cable, add suffix **W/30** to the 2 m model number (example, **VS4RP5R W/30**). A model with a pigtail QD requires a mating cable (see page 378).

VS4 Specifications

Supply Voltage and Current	10 to 30V dc (10% max. ripple) Emitter: 25 mA Receiver: 25 mA (exclusive of load)
Supply Protection Circuitry	Protected against reverse polarity and transient voltages
Output Configuration	SPST solid-state switch NPN (current sinking) or PNP (current sourcing), depending on model. Light Operate (LO) or Dark Operate (DO), depending on model.
Output Rating	50 mA max. Off-state leakage current: less than 1 µA at 24V dc On-state saturation voltage: less than 0.25V at 10 mA dc; less than 0.5V at 50 mA dc
Output Protection Circuitry	Protected against false pulse on power-up and continuous overload or short circuit of outputs Overload trip point ≥ 100 mA
Output Response Time	1 millisecond ON and 0.5 milliseconds OFF NOTE: 100 millisecond delay on power-up; output does not conduct during this time.
Repeatability	100 microseconds
Indicators	Two LEDs: Green and Yellow Green ON steady: power to sensor is ON Green flashing: output overload Yellow ON steady: light is sensed Yellow flashing: marginal excess gain (1 to 1.5x) in light condition
Construction	Polycarbonate mounting holes and lens Low pressure molded thermoplastic housing (UL 94-V0)
Environmental Rating	IP67; NEMA 6
Connections	2 m or 9 m attached cable, 3-wire with PVC outer cable jacket; or 150 mm pigtail with threaded 3-pin Pico-style quick-disconnect fitting. QD cables are ordered separately. See page 378.
Operating Conditions	Temperature: -20° to +55° C Relative humidity: 80% at 50° C (non-condensing)
Vibration and Mechanical Shock	Vibration: All models meet IEC 60068-2-6, IEC 60947-5-2, UL491 Section 40, MIL-STD-202F Method 201A; 10 to 60 Hz, 0.5 mm peak to peak Shock: All models meet IEC 60068-2-27, IEC 60947-5-2; 30g peak acceleration, 11 millisecond pulse duration, half-sine wave pulse shape
Application Notes	M2 stainless steel mounting hardware included. Optional mounting bracket available. See page 350.
Certifications	
Hookup Diagrams	Emitters: DC03 (p. 476) NPN Models: DC01 (p. 476) PNP Models: DC02 (p. 476)

Too many
sensor
choices?

Simplify your
world.

WORLD-BEAM[®]

One family. Complete solutions.

bannerengineering.com

NEW!

Announcing
one sensor family
that does it all.

Mode/Feature	Range/Performance
 Opposed	Up to 200 m
 Retro	Up to 18 m
 Diffuse	.45 – 1.5 m
 Background Suppression	50 – 600 mm
 Fiber Optic	Glass or Plastic
 Laser	Opposed, Retro & Diffuse
 Ultrasonic	30 – 300 mm
 TEACH	Push-button Programming
 AC/DC Voltage	12 – 250 V dc 24 – 250 V ac

Q12 Miniature

- ▶ Only 22 x 8 x 12 mm
- ▶ Rugged overmolded design (IP67 rated)
- ▶ No adjustments required



QS18 Value

- ▶ All sensing modes, including laser & ultrasonic
- ▶ Gain-pot adjust or push-button *Expert*[™]
- ▶ Innovative design for easy mounting



QS30 High Performance

- ▶ High power with ranges up to 200 m
- ▶ Laser models with advanced optics
- ▶ Smallest sensor to offer integrated e/m relay



www.bannerengineering.com/worldbeam

1.888.373.6767

BANNER[®]

more sensors, more solutions

© 2005 Banner Engineering Corp., Minneapolis, MN