



SMARTDAC+®

Data Acquisition & Control

Bulletin 04L52B01-01EN

www.smartdacplus.com

SMARTDAC+

Data Acquisition & Control

Your business environment is complex and fast changing.
You need smart and powerful systems that can adapt to your process.
SMARTDACPLUS is a fresh approach to data acquisition and control,
with smart and simple touch operation as a design priority.
Measure, display and archive process data with greater
levels of clarity, intelligence and accessibility.
The **SMARTDACPLUS** concept begins with the all-new GP,
an integrated I/O and recording system
with a familiar touch operator interface.
Highly adaptable, very capable and
easy to operate is the new GP.

Now that's SMART.

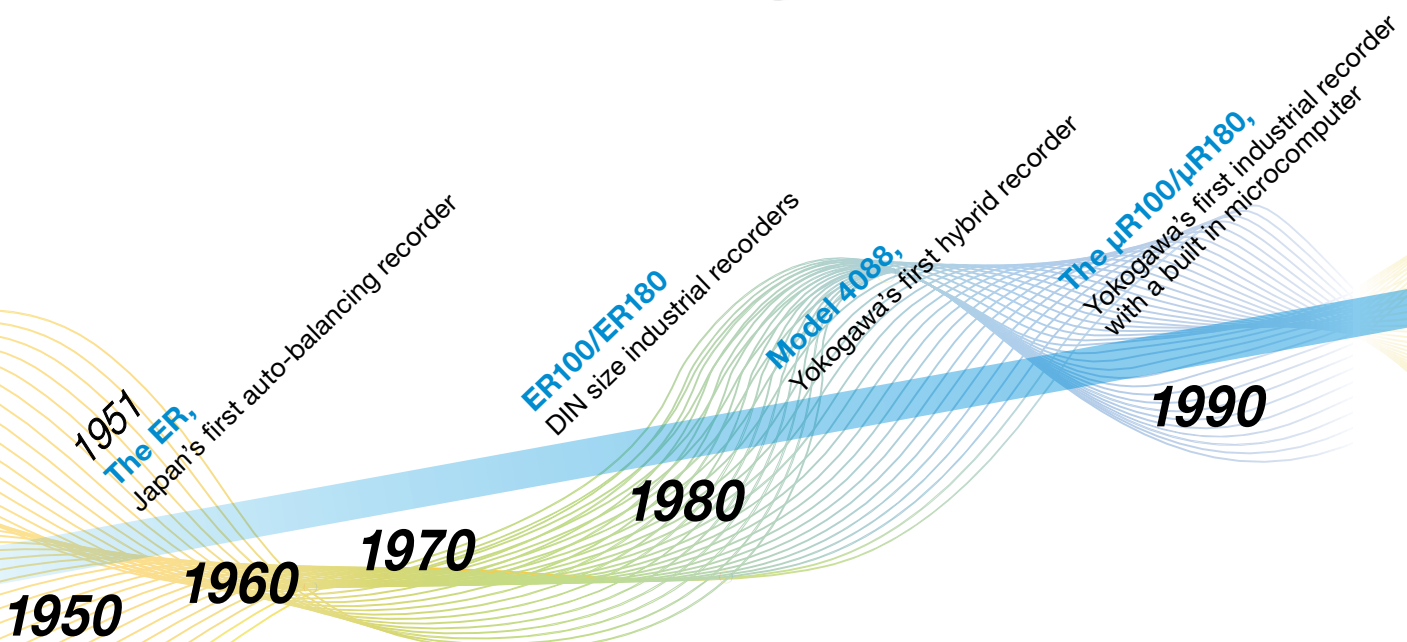



Classic precision and reliability, evolving.

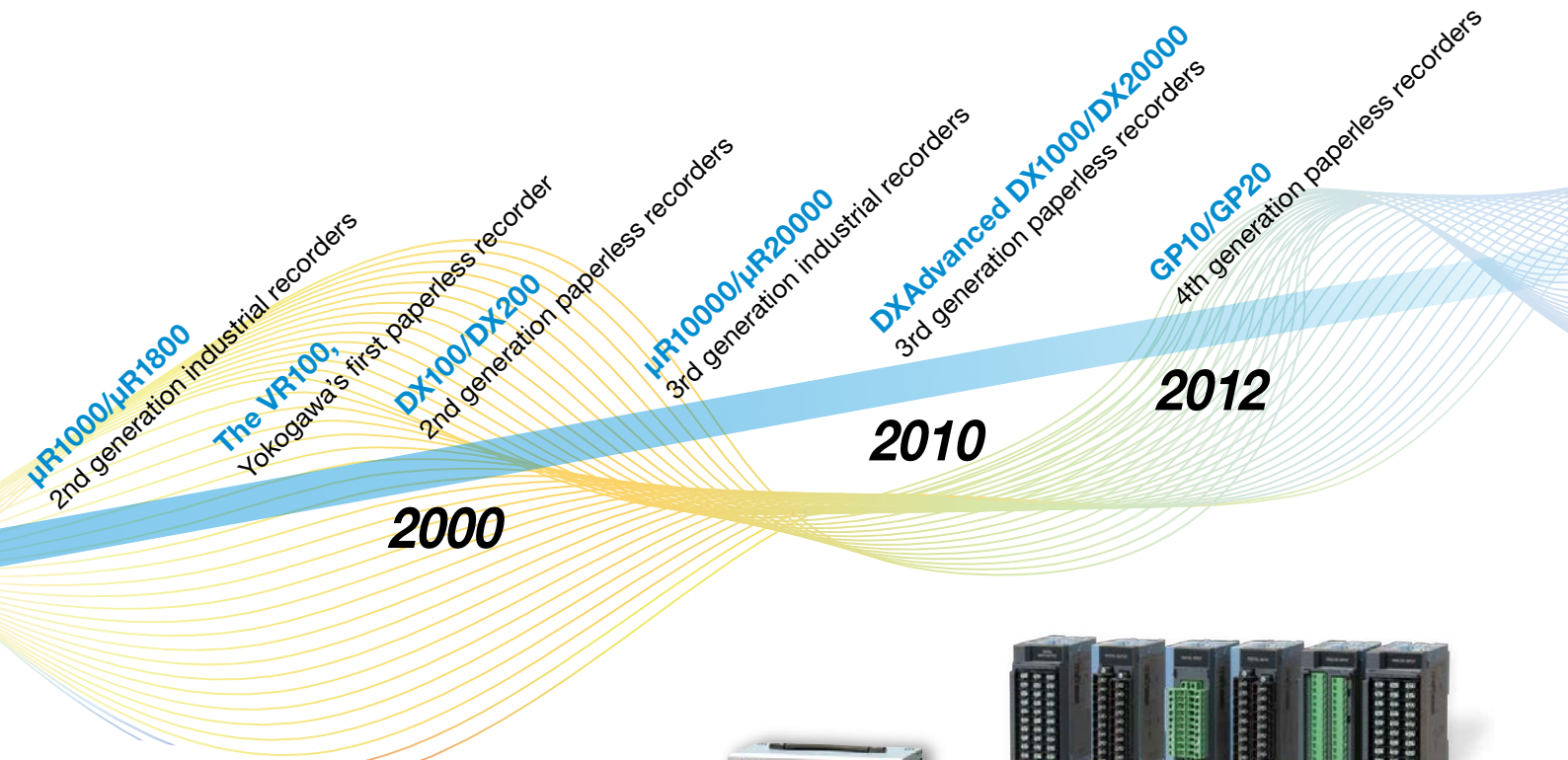

Data logging software



Paperless recorders (portable type)



Input/output modules



SMARTDAC+[®]

Data Acquisition & Control

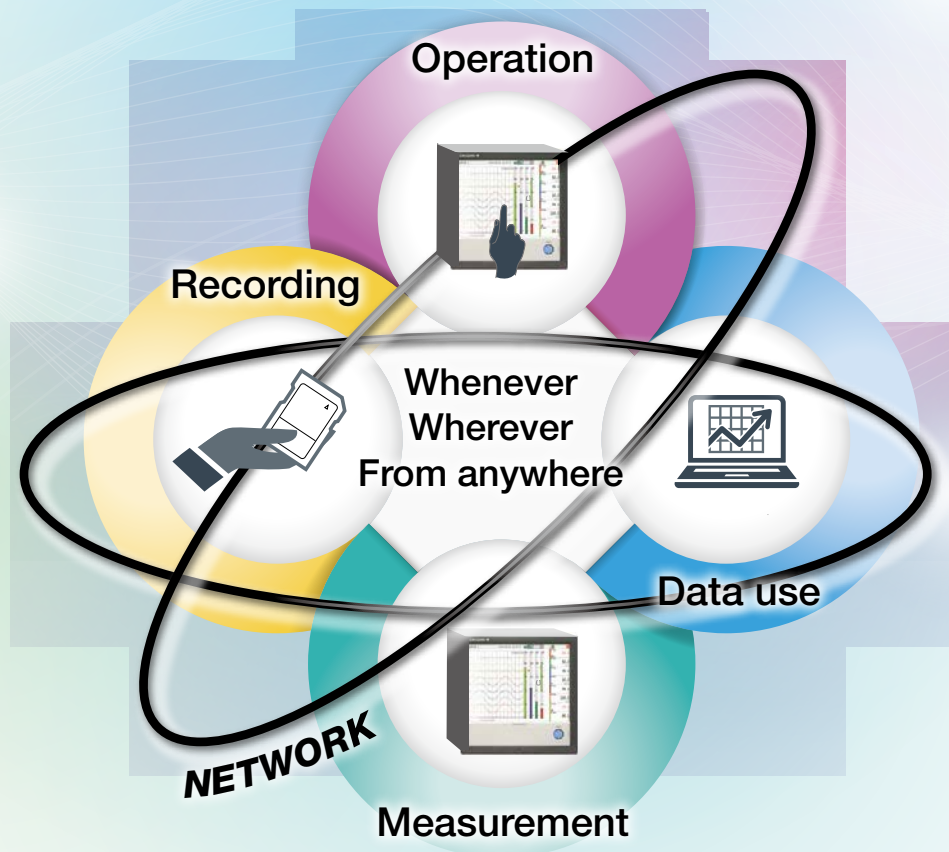

Measurement

Inputs and outputs that support a wide range of DUTs
 Modular construction for expandable input/output
 Multichannel measurement on up to 450 channels
 Pulse signal data acquisition, integral count

Recording

Supports multichannel recording over long durations
 Redundancy through internal memory and external media
 Saves binary data for enhanced security (also supports plain text)

Display & operation

Arrange screens any way you like with the Custom Display function (option)
 Wide variety of powerful display functions
 Touch screen for even greater ease of use
 Monitor remotely and edit GP settings from a web browser

Data use

Automatically create and print spreadsheets
 Powerful software for a variety of tasks including data analysis, settings, and acquisition
 Save to binary or text format
 SLMP Communication (Mitsubishi PLC)



Reliable technology

Reliability meets user empowerment in an expanding range of applications.

Smart User Interface

Provides a smooth, familiar user experience

- Observe**
 - Variety of display functions
 - Powerful data search functions
 - Alarm/Status indicator functions
- Interact**
 - Touch screen for intuitive operation
 - Easy-to-navigate, user-oriented design
 - Supports freehand messages



Smart Architecture

Enables a scalable data acquisition system

- Adapt**
 - Add I/O modules when you need more channels
 - Wide ambient temperature operation
 - Locking front panel for media security
- Measure**
 - Wide-ranging input/output specifications
 - Multichannel I/O
 - Easy-to-read screens



Smart Functionality

Offers a seamless data transfer environment

- Record**
 - Direct output to printers
 - User defined report creation tool
 - Viewer software for data analysis
- Connect**
 - Browser-based real time monitoring
 - Centralized data management via FTP server
 - Powerful networking functions

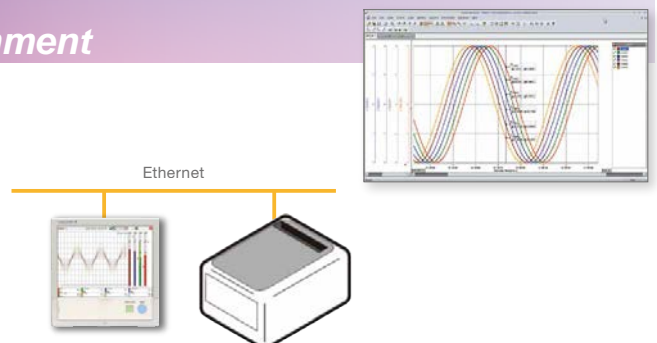

Smart User Interface

An intuitive UI engineered for ease-of-use

Efficiently search for key data

Easily review historical data

Seamless display of historical trends—flick or drag the trend display to scroll through the data, even during measurement.

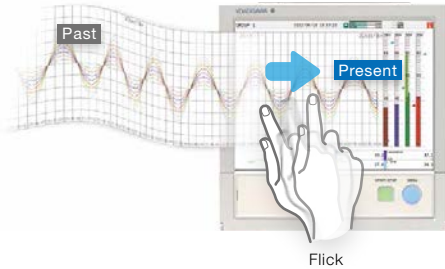

Quickly find data using calendars and summary screens

From a calendar, jump to waveforms of a specific date. From the alarm summary, jump to the waveform active during the alarm.

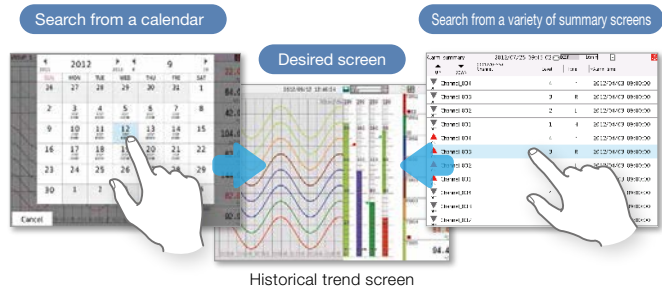

Easily check off trouble spots

Write freehand messages

Immediately clear areas of concern with a hand-written message.

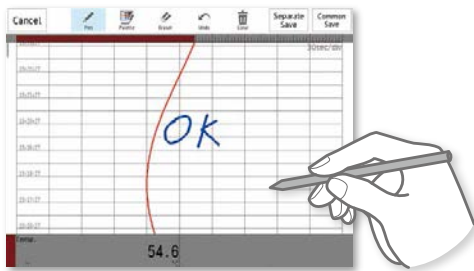

You can draw or hand-write on the waveform area using a stylus (standard accessory) or the tip of your finger. You can even select a color and line width. Alternatively, you can select from a list of preset messages.

Save and output image files

Save trend waveforms of interest or screens displayed during alarms as image (PNG) files, and print them out at the same time.

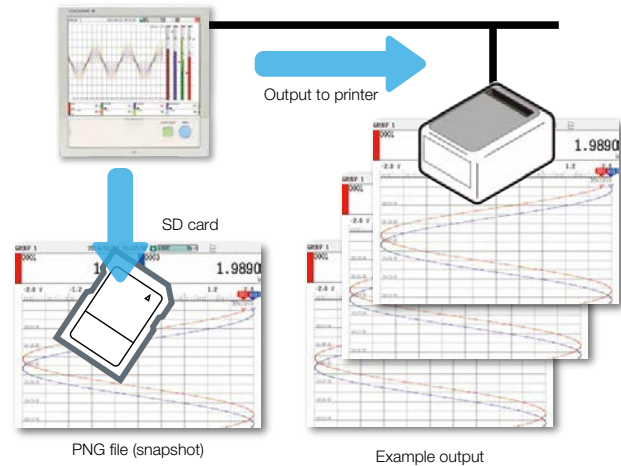

Check waveforms of concern in detail

Display digital values at any location

Move the scale to display the value corresponding to that position as a numeric value. Instantly check maximum/minimum measured values.

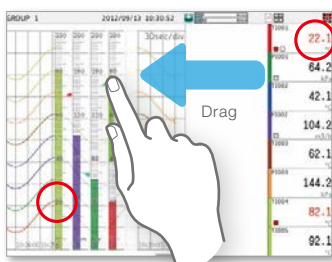

[Patent technology]

Ascertain long-duration trends at a glance

All historical trends display

Long-duration trends can be fitted to a single screen for easy viewing.

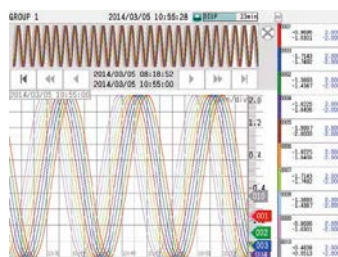

All historical trends display

Zoom in/out - time axis and engineering units

The time axis and engineering axis can be expanded and compressed using a simple pinch together or apart function.

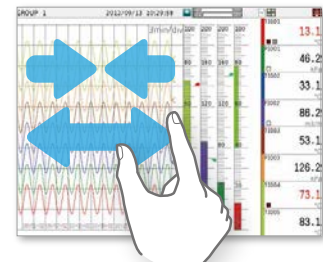

Pinch apart / Pinch together

Create your own screens

Custom display (/CG option)

You can arrange display objects such as trend, numeric, and bar graphs any way you like to create monitor displays that are customized to the environment.

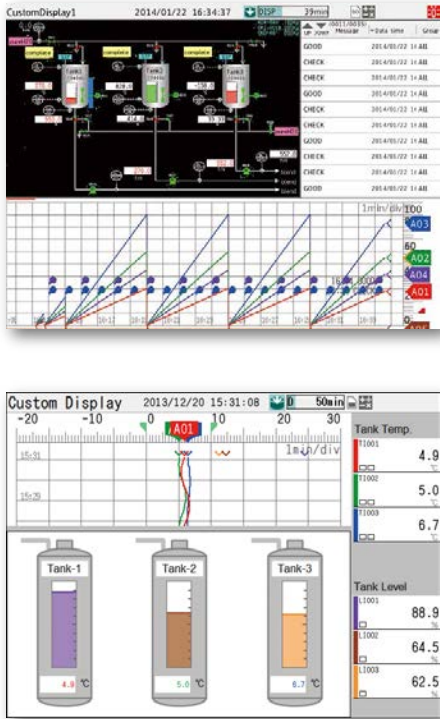

DAQStudio DXA170

Custom display building software

DAQStudio is software for creating custom displays. You can load screens you created onto the GP via Ethernet or external memory media (SD/USB) and display them.

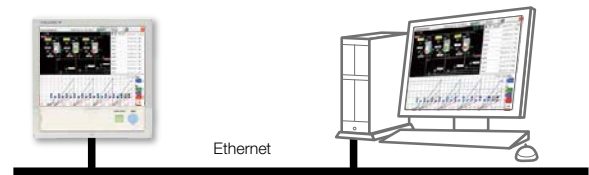

Common objects used in custom displays (DAQStudio)

Image (displays PNG files)



Digital



Trend

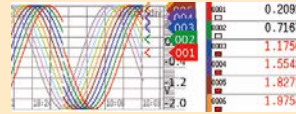

Label

Label

Bar graph



Alarm summary

IP	DOWN	Channel	Level	Type	Alarm time
▲	0003	1	H	2014/09/13 18:12:32.000	
▲	0004	1	H	2014/09/13 18:12:37.000	
▲	0005	1	H	2014/09/13 18:12:32.000	
▲	0006	1	H	2014/09/13 18:12:37.000	
▲	0007	1	H	2014/09/13 18:11:57.000	
▲	0008	1	H	2014/09/13 18:11:37.000	
▲	0010	1	H	2014/09/13 18:11:07.000	
▲	0089	1	H	2014/09/13 18:59:21.000	
▼	0092	1	H	2014/09/13 18:59:08.000	

Variety of display screens

Trend

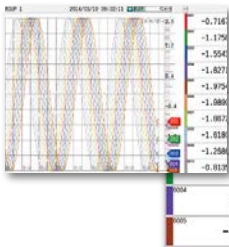

Bar graph



Overview



Alarm summary

Channel	Level	Type	Alarm time
Channel 001	1	H	2014/09/13 18:12:32.000
Channel 002	1	H	2014/09/13 18:12:37.000
Channel 003	1	H	2014/09/13 18:12:32.000
Channel 004	1	H	2014/09/13 18:12:37.000
Channel 005	1	H	2014/09/13 18:11:57.000
Channel 006	1	H	2014/09/13 18:11:37.000
Channel 007	1	H	2014/09/13 18:11:07.000
Channel 008	1	H	2014/09/13 18:59:21.000
Channel 009	1	H	2014/09/13 18:59:08.000

Message summary

Message ID	Time	Factor	Filter name
Message 100	2014/09/13 18:12:32.000	Factor 1	Filter 1
Message 101	2014/09/13 18:12:37.000	Factor 2	Filter 2
Message 102	2014/09/13 18:11:57.000	Factor 3	Filter 3
Message 103	2014/09/13 18:11:37.000	Factor 4	Filter 4
Message 104	2014/09/13 18:11:07.000	Factor 5	Filter 5
Message 105	2014/09/13 18:59:21.000	Factor 6	Filter 6
Message 106	2014/09/13 18:59:08.000	Factor 7	Filter 7

Memory summary

Physical quantities are displayed and recorded on a log scale.

Log scale display (LG option)



Log scale

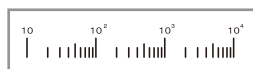

Displays exponents

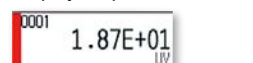

Multi-panel display

You can select from 9 layouts, and save up to 20 configurations.

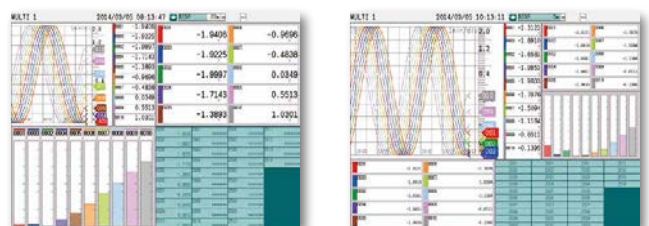

* Multi-panel display is for GP20 only.

Smart Architecture

Highly flexible and scalable architecture

Modular input/output

Inputs and outputs are modular for easy expandability.

The GP multichannel paperless recorder main unit alone provides up to 100 channels (GP20) of measurement.



Expandable to up to 450 channels (real actual input)

Supports up to 450 channels of measurement. Note that if MATH and communication channels are included, the GP20 large memory type can record on up to 1000 channels. The GP main unit and expandable I/O can both use the same input/output modules

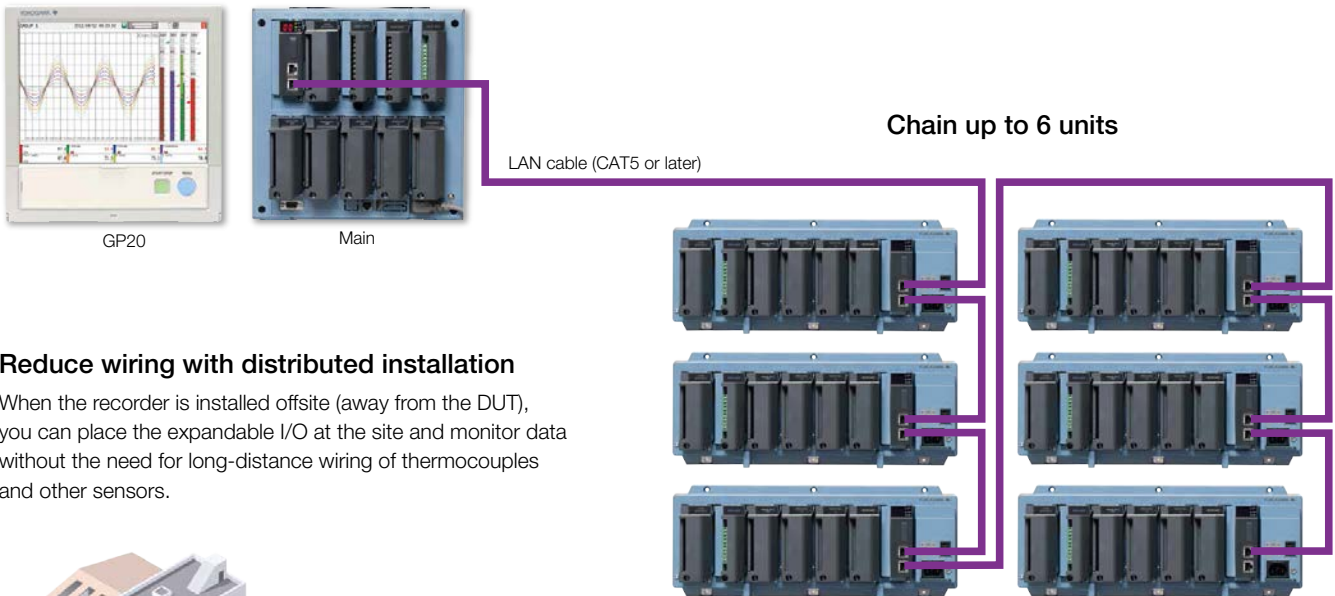

Reduce wiring with distributed installation

When the recorder is installed offsite (away from the DUT), you can place the expandable I/O at the site and monitor data without the need for long-distance wiring of thermocouples and other sensors.

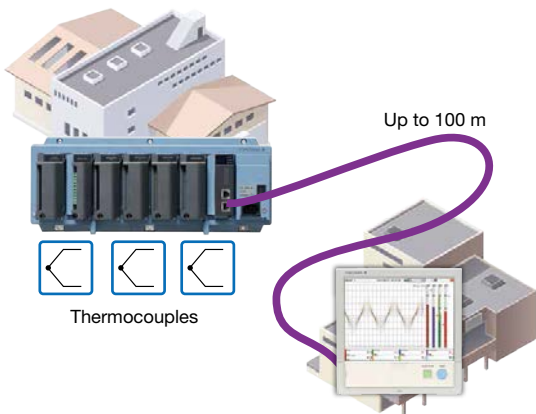

The maximum distance between units is 100 m

Model	Type	Max. channels	Number of channels by configuration	
GP10	Standard	100 ch	Main unit only	0-30
			Main + expandable I/O	0-100
GP20	Standard	100 ch	Main unit only	0-100
			Main + expandable I/O	0-100
	Large memory	450 ch	Main unit only	0-100
			Main + expandable I/O	0-450

The number of channels is for analog input only.

Wide variety of input/output modules

Select from a wide variety of input /output modules.



The I/O terminals are detachable.

Model	Name	Measurement/Application	Channels
GX90XA-10-U2	Analog input module	DC voltage, DC current, thermocouple, RTD, contact (semiconductor relay scanner type)	10
GX90XA-10-L1		Low withstand voltage DC voltage, thermocouple, contact	10
GX90XA-10-T1		DC voltage, thermocouple, contact (electromagnetic relay scanner type)	10
GX90XA-10-C1		DC current (mA)	10
GX90XD	Digital input module	Remote control input or operation recording	16
GX90YD	Digital output module	Alarm output	6
GX90WD	Digital input/output module	Remote control input or operation recording/ alarm output	DI:8/DO:6
GX90XP	Pulse Input Module	Pulse signal data acquisition, integral count	10

Component Names

GP20

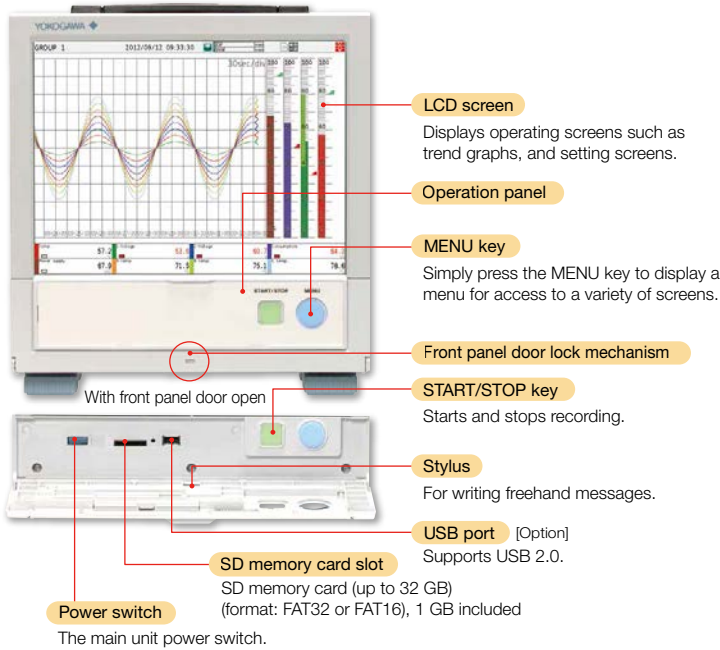

Easy-to-read display

GP20:12.1" TFT color LCD, 800 x 600 dots
GP10:5.7" TFT color LCD, 640 x 480 dots

GP10

Handle

The START/STOP key can be used when the operation panel is closed.

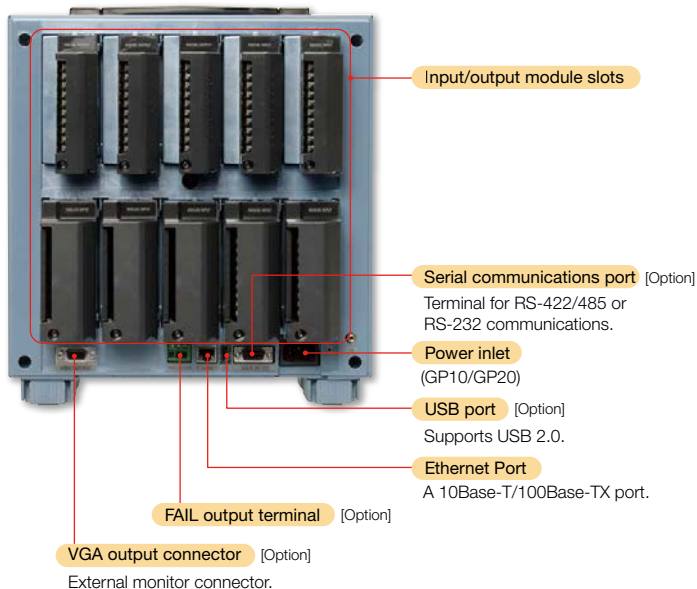
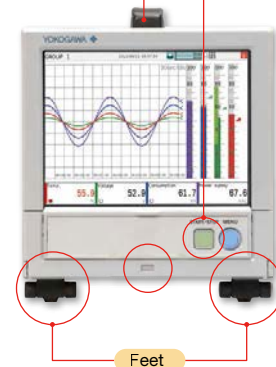

Portable models (GP10/GP20)



Report template function (/MT option)

This function automatically creates spreadsheets in PDF or Excel format.

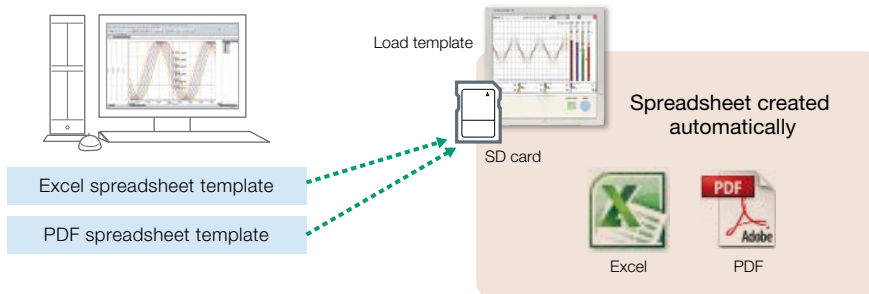

Spreadsheets are created according to the template loaded on the main unit. Templates are available for Excel and PDF. PDF spreadsheet templates are created with a free report template builder program.

Automatically generated spreadsheets (PDF or Excel) are saved to external memory media (SD card) at regular intervals. You can also transfer them via FTP.

Print spreadsheets (PDF) directly

Spreadsheets generated from PDF spreadsheet templates can be automatically output from the GP to a printer through a PC.

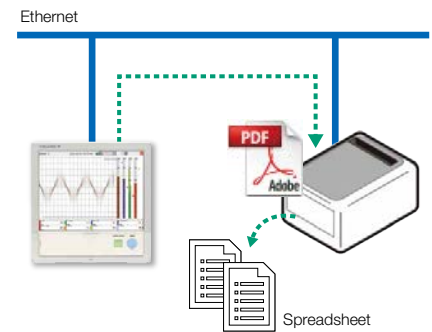

Aerospace Heat Treatment Supports heat treatment application AMS2750/NADCAP

Calibration correction schedule control function (optional code /AH)

Schedule management for periodically executing calibration correction configuration and the like.

Reminder		Sep/17/2015 11:25:20 ALL BATCH	
Furnace 1 Calibration	Furnace 4 Calibration	Time until due date 63 days	Time until due date 7 days
Furnace 2 Calibration	Furnace 5 Calibration	Time until due date 70 days	Time until due date 28 days
Furnace 3 Calibration	Furnace 6 Calibration	Time until due date 0 days	Time until due date 35 days

Calibration reminder display

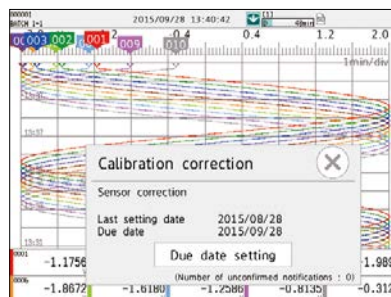

Message to prompt calibration

Calibration schedule setting

Record data in separate files per equipment set

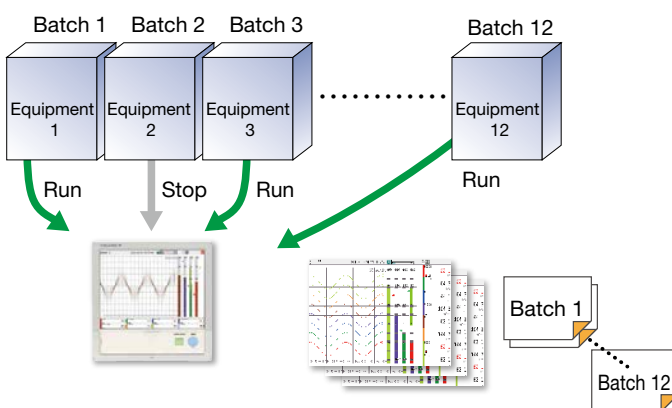

Multi-batch Function (optional code /BT)

Recorder pre-defined channel groups to separate data files with independent start and stop control. Up to 12 independent batches can be created.

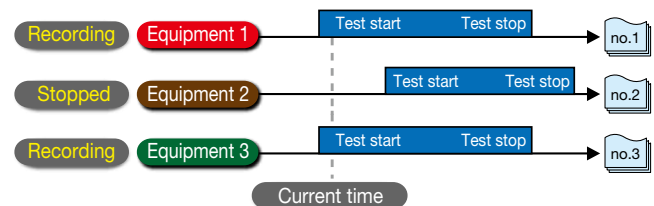

Networking

Provides a variety of convenient networking functions

FTP-based file transfer

The FTP client/server functions allow you to easily share and manage data from a centralized file server.

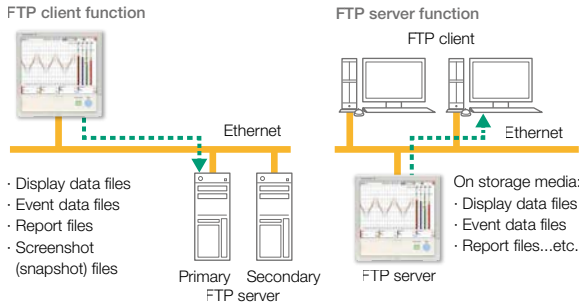

E-mail messaging function

The GP can send a variety of informative e-mail messages that include alarm notification reports, periodic instantaneous data values, scheduled report data and other information.

Sending e-mail using an existing mail system

In this type of setup, e-mail messages are sent through an existing mail server (SMTP server).

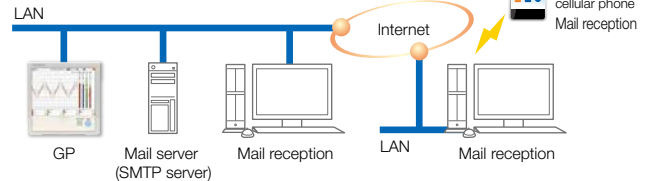

Modbus/TCP and Modbus/RTU Communications

GP supports Modbus TCP/IP client and server modes for Ethernet communications and Modbus RTU master and slave modes for optional serial communications.

Modbus TCP (Ethernet connection)

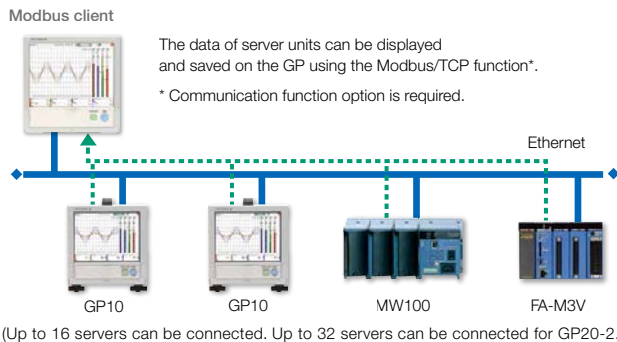

Modbus RTU (RS-422/485 connection)

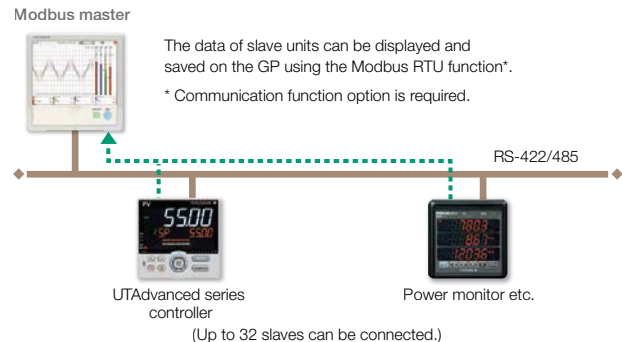

EtherNet/IP Function (optional code /E1)

GP supports EtherNet/IP server functions. You can access GP from PLCs or other devices and load measurement/MATH channels or write to communication input channels (GP10: max. 50 ch, GP20-1: max. 300 ch, GP20-2: max. 500 ch).

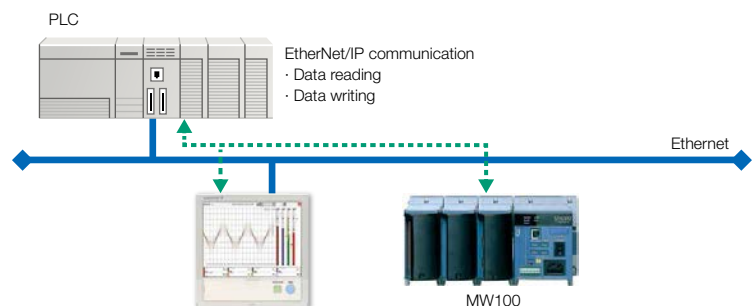

Automatic network setup (DHCP) function

Using Dynamic Host Configuration Protocol (DHCP), the GP can automatically acquire the settings it needs (IP address) for network communications from a DHCP server. This makes it easier than ever to install the unit on a plant network.

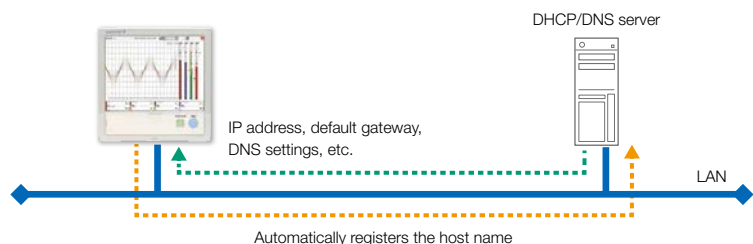

Time synchronization with network time servers

GP uses SNTP protocol in client mode to acquire time information from a network time-server. This function allows any number of GP units within a facility to have precisely synchronized time; all units will record data with coordinated date and time stamp information. In addition, GP can function as a server, providing time data to other SNTP client units on the network.

SLMP Communication (Mitsubishi PLC) (optional code /E4)

Protocol function that enables connection from a GP to Mitsubishi Electric PLCs without sequencer programs. The data of server units can be displayed and saved on the GP*.

* Communication channel option (optional code /MC) is required.

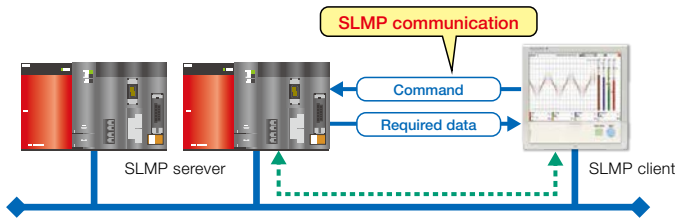

OPC-UA Server (optional code /E3)

Data acquired by the GP can be accessed through Ethernet communication from a host system (OPCUA client). The data of server units can be displayed and saved on the GP*.

* Communication channel option (optional code /MC) is required.

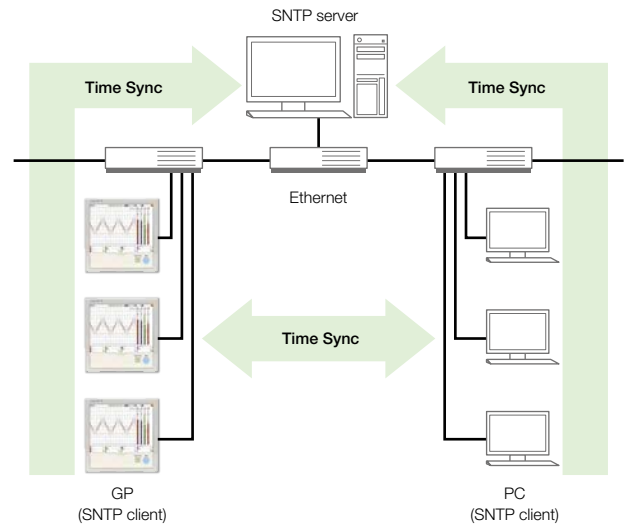
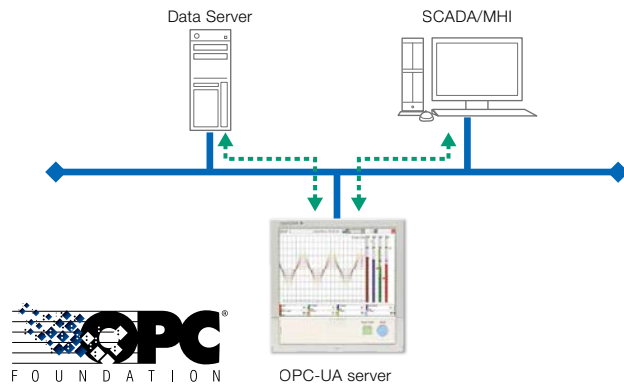

DARWIN-compatible communication

The GP supports DARWIN communication commands. Use your current DARWIN communication programs as-is on the GP.

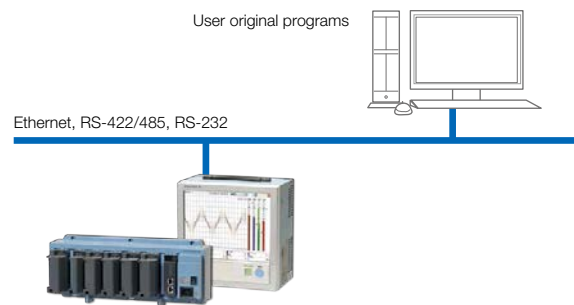

Powerful tool for instrument performance evaluation testing (/E2 and /MC options)

Highly precise measured data from power measuring instruments (WT series power analyzers) can be acquired without loss of fidelity on the GP, and recorded and displayed alongside the GP's own measured data.

This is ideal for performance evaluation testing because you can record instrument power consumption, temperature, and other phenomena simultaneously.

Models that can be connected
Yokogawa Meters & Instruments Corp.
WT series power analyzers
WT300/WT500/WT1800

Max. no. of connections
8 (GP10), 16 (GP20)

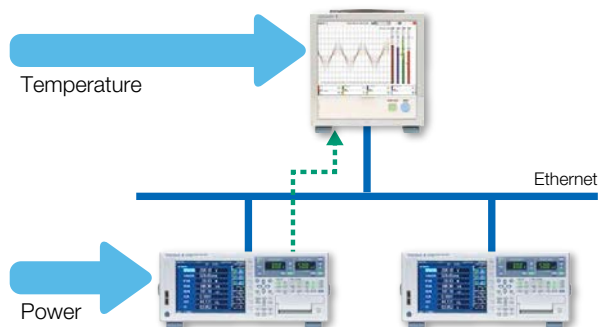
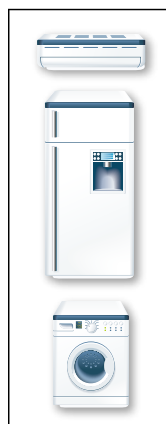

Reliability and durability

Rock-solid hardware and highly secure

Be confident that recorded data is saved

Measured and calculated data is continuously saved to secure, internal non-volatile memory. At manual or scheduled intervals, the files in memory are copied to the removable media. In addition, the files can be copied and archived to an FTP server.

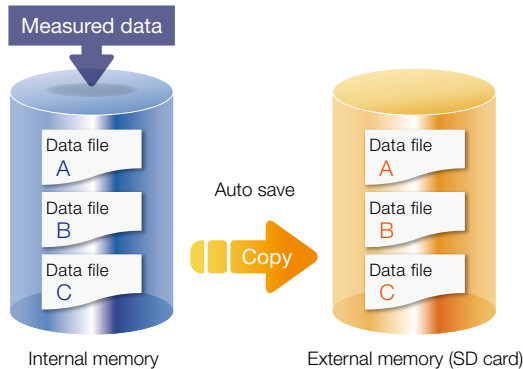

Because of the inherent reliability and security of non-volatile memory, the possibility of losing data under any operating condition or power failure event is extremely small.

High Capacity Internal Memory

Even longer recording durations, and multichannel recording.

Display data file sample time

Measurement CH = 30 channels. Math CH = 0 channels.

Internal Memory	500 MB
Display update (minute/div)	30 minutes
Sampling period (s)	60 s
Total sample time	Approx. 2.5 years

Event data file sample time

Measurement CH = 30 channels. Math CH = 0 channels.

Internal Memory	500 MB
Sampling period (s)	1 s
Total sample time	Approx. 1 months

21 CFR Part 11 support (/AS option)

With the advanced security function option, GP supports the USA FDA's Title 21 CFR Part 11 regulation.

It gives you access to a login function for requiring user names, IDs, and passwords, plus electronic signatures, audit trails, an anti-tampering function, and other security features.



FDA 21 CFR PART 11

Select file formats according to your application

For increased security, measured data can be saved in binary format. This format is very difficult to decipher or modify in traditional text editors or other programs. To enable easy and direct opening of the data in text editors or spreadsheet programs, choose text format. This allows you to work with your measurement data without dedicated software.

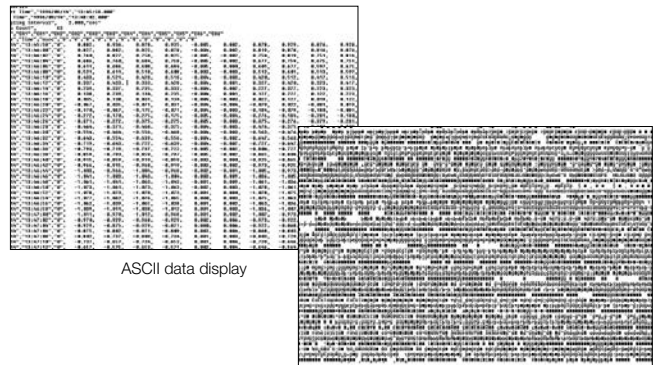

ASCII data display

Binary data display

High environmental worthiness for use in most any setting

The protective sheets on the touch panel display have a special coating on the front and back to prevent damage from scratches, chemicals, and solvents while maintaining a high display clarity and resistance to light interference.

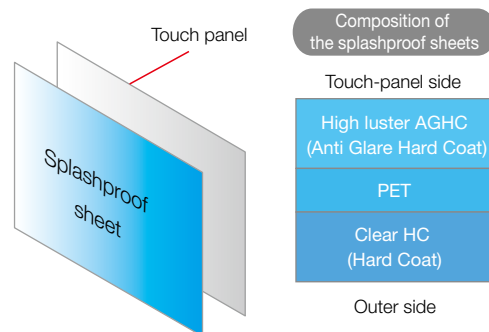

Security enhancements

Safely sends and receives customer data.

SSL support function

- FTP client
- SMTP client
- FTP server
- HTTP server

Digital signatures



SSL: An encryption protocol for data sent over TCP/IP networks.

Heat dissipating construction

The GP was built for heat dissipation to ensure an even temperature distribution between module terminals.

Heat analysis result

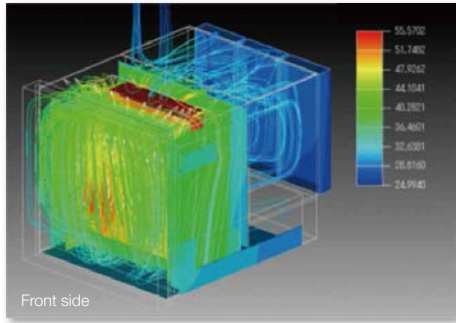

Multitouch operation even with gloves on

Traditional resistive touch screens can detect only one touch point. The built in controller and algorithm of the GP can detect two touch points, allowing intuitive pan and zoom functions during trend monitoring—a first among paperless recorders.

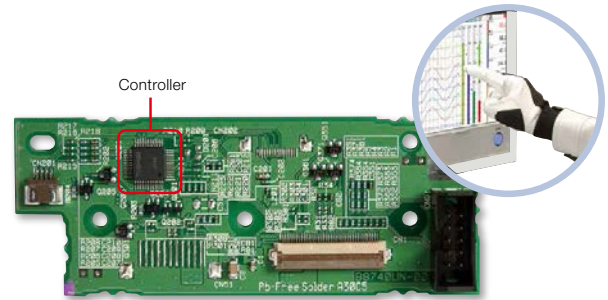

Actual values support high precision measurement

The measuring accuracies noted in the general specifications have a margin of error that takes into account the product's components and the equipment used for adjustment and testing. However, the actual values calculated from the accuracy testing data upon shipment of the instrument from the factory are as follows.

Input type		Measuring accuracy*1 (typical value*2)	
DCV	20mV	± (0.01% of rdg + 5 μV)	
	60mV	± (0.01% of rdg + 5 μV)	
	6V (1-5 V)	± (0.01% of rdg + 2 mV)	
TC ³	R	± 1.1°C	
	K	0.0~1370.0°C : ± (0.01% of rdg + 0.2°C)	-200.0~0.0°C : ± (0.15% of rdg + 0.2°C)
	K (-200~500 °C)	0.0~500.0°C : ± 0.2°C	-200.0~0.0°C : ± (0.15% of rdg + 0.2°C)
	J	0.0~1100.0°C : ± 0.2°C	-200.0~0.0°C : ± (0.10% of rdg + 0.2°C)
	T	0.0~400.0°C : ± 0.2°C	-200.0~0.0°C : ± (0.10% of rdg + 0.2°C)
RTD	N	0.0~1300.0°C : ± (0.01% of rdg + 0.2°C)	-200.0~0.0°C : ± (0.22% of rdg + 0.2°C)
	Pt100	± (0.02% of rdg + 0.2°C)	
	Pt100 (high resolution)	± (0.02% of rdg + 0.16°C)	

*1 Applies to GX90XA-10-U2, A/D integration time 16.67 ms or more, General operating conditions: 23±2 °C, 55±10% RH, supply voltage 90~132, 180~264 V AC, power frequency within 50/60 Hz ±1%, warm-up of 30 minutes or more, no vibrations or other hindrances to performance.

*2 For the measuring accuracy (guaranteed), see the module's general specifications (GS 04L53B01-01EN).

*3 These values do not include the reference junction compensation accuracy.

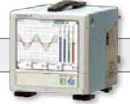

Model	GP20	GP10
Construction	Portable	Portable
Display	12.1" TFT color LCD (800 × 600 dots)	5.7" TFT color LCD (640 × 480 dots)
Touch screen	4 wire resistive touch screen, 2-point touch detection	
Max. no. of connectable modules	10 (When mounted on expansion module: 9)	3 (When mounted on expansion module: 2)
	* The maximum number of connectable modules is limited by the maximum number of I/O channels, and differs depending on the types and combinations of modules.	
Analog input channels	Standard: 100, Large memory: 450 (with expansion unit)	Standard: 30, 100 (with expansion unit)
No. of mathematical channels	GP20-1: 100, GP20-2: 200	50
No. of communication channels	Standard: 300, Large memory: 500	50
Internal memory (flash memory)	Standard: 500 MB, Large memory: 1.2 GB	500 MB
External storage media	SD memory card (up to 32 GB) (format: FAT32 or FAT16), 1 GB included USB interface (/UH option): USB 2.0 compliant (external storage media: USB flash memory) (Keyboard/mouse: HID Class Ver. 1.1 compliant)	
Communication functions	Ethernet (10BASE-T/100BASE-TX), IEEE802.3 compliant (Ethernet frame type: DIX) Connecting configuration: Cascade max. 4 level (10BASE-T), max. 2 level (100BASE-TX), segment length: Max. 100 m E-mail inform function (E-mail client), FTP client function, FTP server function, Web server function, SNMP client function, SNMP server function, DHCP client function Modbus/TCP (client*/server functions) */MC option is required.	
	Options	Serial communications (/C2: RS-232, /C3: RS-422 or RS-485), Modbus/RTU (master/slave functions) EtherNet/IP communication (PLC communication protocol) (/E1), WT communication (/E2), OPC-UA server (/E3), SLMC communication (Mitsubishi PLC) (/E4)
Other functions	Security functions: Key lock function, login function, Clock functions: With calendar function, accuracy: ±5 ppm (0 to 50°C), LCD saver function	
Rated supply voltage	100 to 240 VAC (allowable power supply voltage range: 90 to 132 VAC, 180 to 264 VAC) 12 VDC (allowable power supply voltage range: 10 to 20 VDC, only for a GP10 of power supply voltage code *2)	
Rated supply frequency	50/60 Hz	
Power consumption	Max. 90 VA (100 VAC), max. 110 VA (240 VAC)	Max. 45 VA (100 VAC), max. 60 VA (240 VAC)
Insulation resistance	Between the Ethernet, RS-422/485, and each insulation terminal and earth: 20 MΩ or greater (at 500 VDC)	
Withstand voltage	Between the power terminal and earth: 3000 V AC (50/60 Hz) for one minute	
External dimensions (W × H × D)	Main Unit	288 × 318 × 197 (mm)
	Including modules	288 × 318 × 248 (mm)
Weight (main unit only)	Approx. 5.4 kg	Approx. 1.9 kg

Analog input module (Universal input module)

Model	GX90XA			
Input type (Inputs: 10)	DCV	20 mV, 60 mV, 200 mV, 1 V, 2 V, 6 V, 20 V, 50 V	RTD	
	Standard signal	0.4-2 V, 1-5 V		
	Thermocouple	R, S, B, K, E, J, T, N, W, L, U, W97Re3-W75Re25, KpvsAu7Fe, Platinel 2, PR20-40, NiNiMo, W/WRe26, N(AWG14), XK GOST	DI	Level, Contact
			DC current	0-20 mA, 4-20 mA
Scan intervals	100 *1 *2/200 *1 *2/500 ms *1, 1/2/5 s			
Power supply and consumption	Supplied from main unit, power consumption: 0.7 W or less			
Insulation resistance	Between input circuits and internal circuitry : 20 MΩ or greater (at 500 V DC)			
Withstand voltage	Between the input circuits and the internal circuitry: 3000 VAC for one minute (current scanner type and low withstand voltage type: between the input circuits and the internal circuitry: 1500 VAC for one minute) Between analog input channels: 1000 V AC for one minute (excluding b terminals) (low withstand voltage type: between the analog input channels: 400 VAC for one minute (excluding b terminals))			
Terminal types	M3 screw terminals or clamp terminals			
Weight	Approx. 0.3 kg			

*1 Cannot be set for the electromagnetic relay type (type suffix code: -T1).
*2 Cannot be set for the low withstand voltage type (type suffix code: -L1).

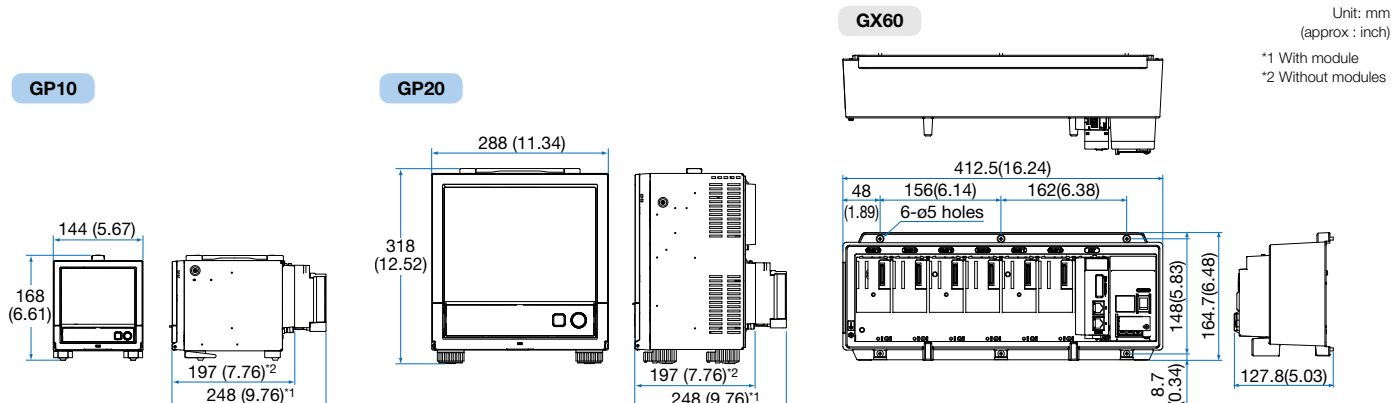

Digital input module

Model	GX90XD	
Input types (inputs: 16)		DI or pulse input*1 (Open collector or non-voltage contact)
	ON/OFF detection	Open collector: Voltage of 0.5 V DC or less when ON, leakage current of 0.5 mA or less when OFF Non-voltage contact: Resistance of 200 Ω or less when ON, 50 kΩ when OFF
Contact rating	12 V DC, 20 mA or more	
Power supply and consumption	Supplied from main unit, power consumption: 0.7 W or less	
Insulation resistance	Between input terminals and internal circuitry: 20 MΩ or greater (at 500 V DC)	
Withstand voltage	Between input terminals and internal circuitry: 1500 V AC for one minute	
Terminal types	M3 screw terminals or clamp terminals	
Weight	Approx. 0.3 kg	

Pulse input specifications¹

Counting system	The rising edge of the pulse is counted.
Max. pulse period	250Hz (The chattering filter : OFF) 125Hz (The chattering filter : ON)
Minimum detection pulse width	Low (close), High (open), both is 2 ms or more
Pulse detection period	1ms
Pulse measurement accuracy	± 1 pulse
Pulse count interval	Measurement interval
Filter	The chattering filter can be switched On/Off. (When the chattering filter is off, connect GP so that it is not affected by the noise.)

*1 Integration requires the math function (optional code /MT).

Digital output module

Model	GX90YD
Output types (outputs: 6)	Relay contact (c contact)
Rated load voltage	100 to 240 V AC or 5 to 24 V DC
Max. load voltage/current	264 VAC or 26.4 VDC, 3A/point (resistance load)
Power supply and consumption	Supplied from main unit, power consumption: 1.4 W or less
Insulation resistance	Between output terminals and internal circuitry: 20 MΩ (at 500 VDC)
Withstand voltage	Between output terminals and internal circuitry: 3000 V AC for one minute
Terminal types	M3 screw terminals
Weight	Approx. 0.3 kg

Pulse Input Module

Model	GX90XP
Number of inputs	10
Measurement interval	100 ms (shortest)
Input type	Contact (open collector, voltage-free contact), level (5 V logic)
Input range	Up to 20 kHz* * 30 Hz when the chattering filter is in use (On)
Minimum detection pulse width	25 μs* * 15 ms when the chattering filter is in use (On)
Measurement accuracy	Count ± 1 pulse During integration, the following accuracies are added. Upon MATH start: +1 measuring period Upon MATH stop: -1 measuring period * Integration requires the math function (optional code /MT).
Chattering filter	Removes chattering up to 5 ms (can be turned on/off on each channel)
Hysteresis width	Approx. 0.2 V
Contact, transistor rating	Contact: 15 V DC or higher and 30 mA or higher rating. Minimum applicable load current 1 mA or less. Transistor: With the following ratings: Vce>15 VDC, Ic>30 mA
Maximum input voltage	±10 V DC
Insulation resistance	Between input terminals and internal circuitry: 20 MΩ or greater at 500 V DC
Withstand voltage	Between input terminals and internal circuitry: 1500 V AC for 1 minute

Digital input/output module

Model	GX90WD	
Input type (inputs: 8)		DI or pulse input*2 (Open collector or non-voltage contact)
	ON/OFF detection	Open collector : Voltage of 0.5 V DC or less when ON, leakage current of 0.5 mA or less when OFF Non-voltage contact: Resistance of 200 Ω or less when ON, 50 kΩ when OFF
	Contact input rating	12 VDC, 20 mA or more
Output type (outputs: 6)		Relay contact (C contact)
	Rated load voltage	When connected to the main circuit (first-order power supply), 150 VAC or less When connected to a circuit derived from the main circuit (second-order power supply), 250 VAC or less (the main circuit is 300 VAC or less and uses an isolated transformer) or 30 VDC or less
	Max. load current	2 A (DC)/2 A (AC), resistive load
Power consumption	1.9 W or less	
Insulation resistance	Between input terminals and internal circuitry: 20 MΩ or greater (at 500 VDC) Between output terminals and internal circuitry: 20 MΩ or greater (at 500 VDC)	
Withstand voltage	Between input terminals and internal circuitry: 1500 VAC for one minute Between output terminals and internal circuitry: 3000 VAC for one minute	
Terminal types	M3 screw terminals	
Weight	Approx. 0.3 kg	

Each unit (GP main unit and expandable I/O), can use 1 module only.

Pulse input specifications

Please see the pulse input specifications of Digital Input Module.

*2 Integration requires the math function (optional code /MT).

Expandable I/O

Model	GX60
Rated supply voltage	100 to 240 VAC (allowable power supply voltage: 90 to 132 VAC, 180 to 264 VAC)
Rated supply frequency	50 to 60 Hz
Power consumption	Max. 40 VA (100 VAC), max. 55 VA (240 VAC)
Insulation resistance	Between Ethernet terminal, isolated terminals, and ground 20 MΩ or more (at 500 VDC)
Withstand voltage	Between power terminal and ground: 3000 VAC (500/60 Hz)/ 1 min. Between I/O modules and ground: between each module's internal circuitry and depends on the specification of I/O module.
Weight	Approx. 3.2 kg (installing 6 modules)

GP10/GP20 MODEL AND SUFFIX CODES

Model	Suffix Code	Optional code	Description	
GP10			Paperless recorder (Portable type, Small display)*14	*1 /C2 and /C3 cannot be specified together.
GP20			Paperless recorder (Portable type, Large display)*14	*2 /D5 can be specified only for the GP20.
Type	-1		Standard	*3 Only one option can be specified.
	-2		Large memory (Max. measurement channels: 500 ch) *12	*4 Only one option can be specified.
Display language	E		English, degF, DST (summer/winter time) *10	*5 /UC40, /UC50, /US40 and /US50 cannot be specified for the GP10.
Power supply		1	100 V AC, 240 V AC	*6 /CR20, /CR21, /CR40 and /CR41 cannot be specified for the GP10.
		2	12 VDC *17	*7 If /UC20 or /US20 is specified, /CR11 cannot be specified for the GP10.
Power cord		D	Power cord UL/CSA standard	*8 If /UC30 or /US30 is specified, /CR01, /CR10 and /CR11 cannot be specified for the GP10.
		F	Power cord VDE standard	*9 A digital input module has M3 screw terminals.
		R	Power cord AS standard	*10 The Display language is selectable from English, German, French, Russian, Korean, Chinese, Japanese. To confirm the current available languages, please visit the following website. URL: http://www.yokogawa.com/ns/language/
		Q	Power cord BS standard	
		H	Power cord GB standard*	
		N	Power cord NBR standard	
		W	Screw terminal, power cord not included	
Optional features		/AH	Aerospace heat treatment	*11 Solid state relay scanner type (type suffix code: -U2). If you need the electromagnetic relay scanner type, purchase it separately.
		/AS	Advanced security function (Part 11)	*12 Large memory type can be specified only for the GP20.
		/BT	Multi-batch function	*13 /MC option must be separately specified when the WT communication is selected.
		/C2	RS-232 *1	*14 To connect an expandable I/O, you will need one expansion module for the GP.
		/C3	RS-422/485 *1	*15 Creating custom displays requires DXA170 DAQStudio (sold separately). (GP does not have a creation function.)
		/CG	Custom display	*16 Power code can be specified the suffix code D, F, R, Q, H, or N.
		/D5	VGA output *2	*17 12 VDC power supply can be specified only for the GP10 without power code (suffix code: W).
		/E1	EtherNet/IP communication	*18 Optional code /MT (MATH) required if using the GX90XD's or GX90WD's pulse input.
		/E2	WT communication *13	*19 The /MT option (MATH) is required to perform pulse integration on GX90XP pulse input modules.
		/E3	OPC-UA sever	
		/E4	SLMP communication (Mitsubishi PLC)	
		/FL	Fail output, 1 point	
		/LG	Log scale	
		/MT	Mathematical function (with report function)	
		/MC	Communication channel function	
	/UH	USB interface (Host 2 ports)		

Analogue input module, Digital I/O module:When the built-in module

Please add the following suffix codes to the main unit model and specification codes.

Option	Optional code	Description	Models and numbers of units of modules included in the main unit
Optional features (Analog input) *3 *11	/UC10	With analog input module, 10 ch (Clamp terminal)	GX90XA-10-U2N-CN x 1
	/UC20	With analog input module, 20 ch (Clamp terminal) *7	GX90XA-10-U2N-CN x 2
	/UC30	With analog input module, 30 ch (Clamp terminal) *8	GX90XA-10-U2N-CN x 3
	/UC40	With analog input module, 40 ch (Clamp terminal) *5	GX90XA-10-U2N-CN x 4
	/UC50	With analog input module, 50 ch (Clamp terminal) *5	GX90XA-10-U2N-CN x 5
	/US10	With analog input module, 10 ch (M3 screw terminal)	GX90XA-10-U2N-3N x 1
	/US20	With analog input module, 20 ch (M3 screw terminal) *7	GX90XA-10-U2N-3N x 2
	/US30	With analog input module, 30 ch (M3 screw terminal) *8	GX90XA-10-U2N-3N x 3
	/US40	With analog input module, 40 ch (M3 screw terminal) *5	GX90XA-10-U2N-3N x 4
	/US50	With analog input module, 50 ch (M3 screw terminal) *5	GX90XA-10-U2N-3N x 5
Optional features (Digital I/O) *4	/CR01	With digital I/O module, (Output:0, Input:16) *8 *9	GX90XD-16-11N-3N x 1
	/CR10	With digital I/O module, (Output:6, Input:0) *8 *9	GX90YD-06-11N-3N x 1
	/CR11	With digital I/O module, (Output:6, Input:16) *7 *8 *9	GX90XD-16-11N-3N x 1, GX90YD-06-11N-3N x 1
	/CR20	With digital I/O module, (Output:12, Input:0) *6 *9	GX90YD-06-11N-3N x 2
	/CR21	With digital I/O module, (Output:12, Input:16) *6 *9	GX90XD-16-11N-3N x 1, GX90YD-06-11N-3N x 2
	/CR40	With digital I/O module, (Output:24, Input:0) *6 *9	GX90YD-06-11N-3N x 4
/CR41	With digital I/O module, (Output:24, Input:16) *6 *9	GX90XD-16-11N-3N x 1, GX90YD-06-11N-3N x 4	

Analogue input module, Digital I/O module:When the individual modules MODEL and SUFFIX Code (GX90XA)

Model	Suffix Code	Description
GX90XA		Analogue Input Module
Number of channels	-10	10 channels
Type	-C1	Current, scanner type (isolated between channels)
	-L1	Low withstand voltage DCV/TC/DI, scanner type (isolated between channels)
	-U2	Universal, Solid state relay scanner type (3-wire RTD b-terminal common)
	-T1	DCV/TC/DI, Electromagnetic relay scanner type (isolated between channels)
-	N	Always N
Terminal form	-3	Screw terminal (M3)
	-C	Clamp terminal
Area	N	General

MODEL and SUFFIX Code (GX90YD)

Model	Suffix Code	Description
GX90YD		Digital Output Module
Number of channels	-06	6 channels
Type	-11	Relay, SPDT(NO-C-NC)
-	N	Always N
Terminal form	-3	Screw terminal (M3)
Area	N	General

MODEL and SUFFIX Code (GX90WD)

Model	Suffix Code	Description
GX90WD		Digital Input/Output Module
Number of channels	-0806	8 channel DIs, 6 channel DOs
Type	-01	Open collector/non-voltage contact (shared common), rated 5 VDC; Relay, SPDT (NO-C-NC)
-	N	Always N
Terminal form	-3	Screw terminal (M3)
Area	N	General

MODEL and SUFFIX Code (GX90XD)

Model	Suffix Code	Description
GX90XD		Digital Input Module
Number of channels	-16	16 channels
Type	-11	Open collector/Non-voltage, contact (shared common), Rated 5 VDC
-	N	Always N
Terminal form	-3	Screw terminal (M3)
	-C	Clamp terminal
Area	N	General

GX90XP MODEL AND SUFFIX CODES

Model	Suffix code	Description
GX90XP		Pulse Input Module
Number of channels	-10	10 channels
Type	-11	DC voltage/open collector/non-voltage contact (shared common), rated 5 VDC
-	N	Always N
Terminal form	-3	Screw terminal (M3)
	-C	Clamp terminal
Area	N	General

MODEL and SUFFIX Code (GX60 Expandable I/O)

Model	Suffix Code	Description
GX60		I/O Base Unit
Type	-EX	I/O expansion
Area	N	General
Power supply	1	100V AC, 240V AC
Power code	D	Power cord UL/CSA standard
	F	Power cord VDE standard
	R	Power cord AS standard
	Q	Power cord BS standard
	H	Power cord GB standard
	N	Power cord NBR standard
	W	Screw terminal (power cord not included)

* With GX90EX (I/O expansion module).

* The dummy cover is not attached to the GX60 when shipped from the factory. If you need the dummy cover, please purchase it separately.

MODEL and SUFFIX Code (GX90EX Expansion Module)

Model	Suffix Code	Description
GX90EX		I/O Expansion Module
Port	-02	2 ports
Type	-TP1	Twisted pair cable
-	N	Always N
Area	-N	Standard Accessories

Standard Accessories

Product	Qty
SD memory card (1GB)	1
Stylus	1
Tag sheet	1
Sheet (paper)	1
Power cord (for GP10 or GP20 of AC power supply only)	1

Optional Accessories (Sold Separately)

Product	Part Number/Model
SD memory card (1GB)	773001
Stylus pen (touch pen)	B8740BZ
Shunt resistor for screw terminal (M3) (10 Ω ± 0.1%)	X010-010-3
Shunt resistor for screw terminal (M3) (100 Ω ± 0.1%)	X010-100-3
Shunt resistor for screw terminal (M3) (250 Ω ± 0.1%)	X010-250-3
Shunt resistor for clamp terminal (10 Ω ± 0.1%)	438922
Shunt resistor for clamp terminal (100 Ω ± 0.1%)	438921
Shunt resistor for clamp terminal (250 Ω ± 0.1%)	438920
Dummy cover	B8740CZ
Validation Documents (For /AS option)	773230

Application Software (sold separately)

Model	Description	OS
DXA170	DAQStudio	Windows Vista/7/8.1/10
GA10	Data Logging Software	Windows Vista/7/8.1/10 Windows Server 2008/2012

• Calibration certificate (sold separately)

When ordering the GP10/GP20 with options (analog input), the calibration certificate for the modules is included in and shipped with the calibration certificate of the main unit. When ordering an analog input module separately, each module gets its own calibration certificate (one certificate per module).

• Test certificate (QIC, sold separately)

When ordering the GP10/GP20 with options (analog/digital I/O), the QIC for each module is included in and shipped with the QIC of the main unit. When ordering analog input modules and digital I/O modules separately, each module gets its own QIC (one QIC per module).

• User's Manual

Product user's manuals can be downloaded or viewed at the following URL.
URL: www.smartdacplus.com/manual/en/

Configuration example

(When ordering individual instruments)
(with supply voltage of 100–240 VAC, universal input, and clamp terminal)

30 ch (analog input)

GP20-1E1D x 1
GX90XA-10-U2N-CN x 3



120 ch (analog input)

GP20-2E1D x 1
GX90EX-02-TP1N-N (for main unit) x 1
GX60-EXN1D (including GX60 Expandable I/O) x 1
GX90XA-10-U2N-CN x 12

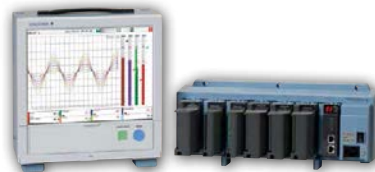

450 ch (analog input)

GP20-2E1D x 1
GX90EX-02-TP1N-N (for main unit) x 1
GX60-EXN1D (including GX60 Expandable I/O) x 6
GX90XA-10-U2N-CN x 45



GX60: 6 units

Analog input module scan interval and measurement type

Type	Channels	Scan interval (shortest)	Channels	TC	RTD	DCV	DI	mA	Feature
Universal (-U2)	10	100ms	SSR	○	○	○	○		Universal
Low withstand voltage relay (-L1)	10	500ms	SSR	○		○	○		Mid-price
Electromagnetic relay (-T1)	10	1s	Relay	○		○	○		Noise-resistance
DC current input (-C1)	10	100ms	SSR					○	mA only

Data Logging Software GA10 (sold separately)

Centrally acquire data from multiple devices on a PC

GA10 is a PC based software package that acquires real time data from SMARTDAC+ data acquisition systems and other devices connected to a network. Connected PCs can monitor real time and historical data, which can be stored on a PC harddrive or centrally on a network drive.

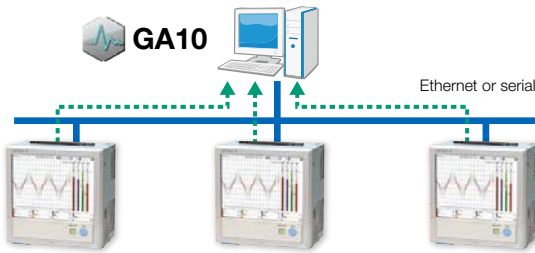

Max. connectable units: **100**
 Max. recording tags (channels): **2,000**
 Scan interval: **100 ms** (shortest)

Compatible with other models in addition to the GP!

Supports many other models. For details, see the GA10 catalog.



MV series

Aggregate data for monitoring!



Easy to read screen layouts provide operator friendly real time monitoring.

- Group channels any way you like
- Play back data up to recording start, even during measurement
- Instantly recognize alarms (in red)

Save the data all together!

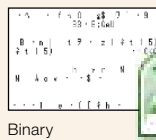

Binary



Excel

Data is stored in a binary tamper proof format preventing unauthorized access. Data can also be exported to excel format for data manipulation and analysis.

Application example

Data monitoring in manufacturing sites

Monitor factory data from the office. You can also add clients and share data across multiple PCs.

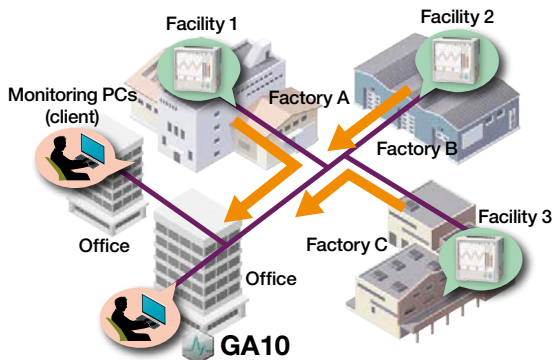

Effect: No more moving around large factories to do work!

Recording data from multiple equipments

Saves testing/manufacturing equipment data on a PC. In addition to simultaneous acquisition, you can acquire data from different equipment at different timing (multilogging).

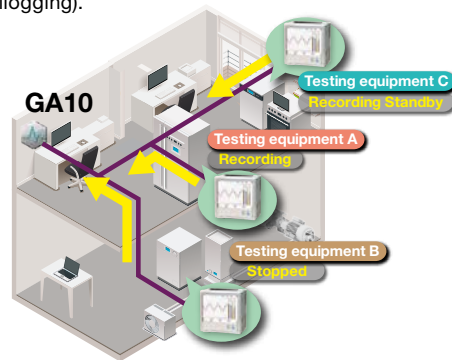

Effect: Manage all data on the PC, one set of equipment at a time!

vigilantplant, SMARTDAC+ and SMARTDACPLUS are registered trademarks of Yokogawa Electric Corporation.
 Microsoft and Windows are registered trademarks or trademarks of Microsoft Corporation in the United States and other countries.
 Other company names and product names appearing in this document are registered trademarks or trademarks of their respective holders.

NOTICE



Before operating the product, read the instruction manual thoroughly for proper and safe operation.

vigilantplant[®]

SEE CLEARLY

KNOW IN ADVANCE

ACT WITH AGILITY

The clear path to operational excellence

VigilantPlant is Yokogawa's automation concept for safe, reliable, and profitable plant operations. VigilantPlant aims to enable an ongoing state of Operational Excellence where plant personnel are watchful and attentive, well-informed, and ready to take actions that optimize plant and business performance.

YOKOGAWA ELECTRIC CORPORATION

Control Instruments Business Division/Phone: (81)-422-52-7179, Fax: (81)-422-52-6973

E-mail: ns@cs.jp.yokogawa.com

YOKOGAWA CORPORATION OF AMERICA

Phone: 800-258-2552, Fax: (1)-770-254-0928

YOKOGAWA EUROPE B.V.

Phone: (31)-88-4641000, Fax: (31)-88-4641111

YOKOGAWA ENGINEERING ASIA PTE. LTD.

Phone: (65)-62419933, Fax: (65)-62412606

Sign up for our free e-mail newsletter
www.yokogawa.com/ns/

Vig-RS-6E

Printed in Japan, 511 (AZ) [Ed : 06/d]

YOKOGAWA