

YOKOGAWA ELECTRIC CORPORATION

Headquarters
2-9-32, Nakacho, Musashino-shi, Tokyo, 180-8750 JAPAN
Phone : 81-422-52-5555
Branch Sales Offices
Osaka, Nagoya, Hiroshima, Kurashiki, Fukuoka, Kitakyusyu

YOKOGAWA CORPORATION OF AMERICA

Head Office
12530 West Airport Blvd., Sugar Land, Texas 77478, USA
Phone : 1-281-340-3800 Fax : 1-281-340-3838
Georgia Office
2 Dart Road, Newnan, Georgia 30265, USA
Phone : 1-800-888-6400/ 1-770-253-7000 Fax : 1-770-254-0928

YOKOGAWA AMERICA DO SUL LTDA.
Praça Acapulco, 31 - Santo Amaro, São Paulo/SP, BRAZIL, CEP-04675-190
Phone : 55-11-5681-2400 Fax : 55-11-5681-4434

YOKOGAWA EUROPE B. V.
Euroweg 2, 3825 HD Amersfoort, THE NETHERLANDS
Phone : 31-88-4641000 Fax : 31-88-4641111

YOKOGAWA ELECTRIC CIS LTD.
Grokhol'skiy per 13 Building 2, 4th Floor 129090, Moscow, RUSSIA
Phone : 7-495-737-7868 Fax : 7-495-737-7869

YOKOGAWA CHINA CO., LTD.
3F Tower D Cartello Crocodile Building, No.568 West Tianshan Road, Shanghai 200335, CHINA
Phone : 86-21-62396262 Fax : 86-21-62387866

YOKOGAWA ELECTRIC KOREA CO., LTD.
(Yokogawa B/D, Yangpyeong-dong 4-Ga), 21, Seonyu-ro 45-gil, Yeongdeungpo-gu, Seoul, 150-866, KOREA
Phone : 82-2-2628-6000 Fax : 82-2-2628-6400

YOKOGAWA ENGINEERING ASIA PTE. LTD.
5 Bedok South Road, Singapore 469270, SINGAPORE
Phone : 65-6241-9933 Fax : 65-6241-2606

YOKOGAWA INDIA LTD.
Plot No.96, Electronic City Complex, Hosur Road, Bangalore - 560 100, INDIA
Phone : 91-80-4158-6000 Fax : 91-80-2852-1442

YOKOGAWA AUSTRALIA PTY. LTD.
Tower A, 112-118 Talavera Road, Macquarie Park NSW 2113, AUSTRALIA
Phone : 61-2-8870-1100 Fax : 61-2-8870-1111

YOKOGAWA MIDDLE EAST & AFRICA B.S.C.(C)
P.O. Box 10070, Manama, Building 577, Road 2516, Busaiten 225, Muharraq, Kingdom of SAUDI ARABIA
Phone : 973-17358100 Fax : 973-17336100

SAFETY INSTRUCTIONS

Ex/I.S. installation:

- For correct use and installation the manufacturer's manual must be followed. When programming the Transmitter by PC and communication interface or a HART® terminal the intrinsically safe data shall be observed.
- The designation galvanic isolation between the transducer input and the loop supply indicates signal isolation only. It shall not be interpreted as an Intrinsically Safe galvanic isolation like an isolating barrier. Therefore ordinary care in selecting barrier and grounding shall be considered.
- The apparatus must be installed in an enclosure with an Ingress Protection of at least IP 20.
- The terminals 1 and 2 of the equipment have to be electrically connected to a linear barrier located in the non hazardous area.
- For Ex/I.S. data, see chapter 7. Approvals Options.

The YTA70 is a head mount type of temperature transmitter that accepts thermocouple or RTD input and converts it to a 4 to 20 mA DC signal for transmission. The YTA70 specifies HART communication protocol for remote configuration.

It is imperative that users observe the instructions in this manual to ensure the protection and safety of operators.

ATEX Documentation

This is only applicable to the countries in European Union.

- GB** All instruction manuals for ATEX Ex related products are available in English, German and French. Should you require Ex related instructions in your local language, you are to contact your nearest Yokogawa office or representative.
- DK** Alle brugervejledninger for produkter relateret til ATEX Ex er tilgængelige på engelsk, tysk og fransk. Skulle De ønske yderligere oplysninger om håndtering af Ex produkter på eget sprog, kan De rette henvendelse herom til den nærmeste Yokogawa afdeling eller forhandler.
- I** Tutti i manuali operativi di prodotti ATEX contrassegnati con Ex sono disponibili in inglese, tedesco e francese. Se si desidera ricevere i manuali operativi di prodotti Ex in lingua locale, mettersi in contatto con l'ufficio Yokogawa più vicino o con un rappresentante.
- E** Todos los manuales de instrucciones para los productos antiexplosivos de ATEX están disponibles en inglés, alemán y francés. Si desea solicitar las instrucciones de estos artículos antiexplosivos en su idioma local, deberá ponerse en contacto con la oficina o el representante de Yokogawa más cercano.
- NL** Alle handleidingen voor producten die te maken hebben met ATEX explosiebeveiliging (Ex) zijn verkrijgbaar in het Engels, Duits en Frans. Neem, indien u aanwijzingen op het gebied van explosiebeveiliging nodig hebt in uw eigen taal, contact op met de dichtstbijzijnde vestiging van Yokogawa of met een vertegenwoordiger.
- SF** Kaikkien ATEX Ex -tyyppisten tuotteiden käyttöohjeet ovat saatavilla englannin-, saksan- ja ranskan kielisinä. Mikäli tarvitsette Ex -tyyppisten tuotteiden ohjeita omalla paikallisella kielellänne, ottakaa yhteyttä lähimpään Yokogawa-toimistoon tai -edustajaan.
- P** Todos os manuais de instruções referentes aos produtos Ex da ATEX estão disponíveis em Inglês, Alemão e Francês. Se necessitar de instruções na sua língua relacionadas com produtos Ex, deverá entrar em contacto com a delegação mais próxima ou com um representante da Yokogawa.

- F** Tous les manuels d'instruction des produits ATEX Ex sont disponibles en langue anglaise, allemande et française. Si vous nécessitez des instructions relatives aux produits Ex dans votre langue, veuillez bien contacter votre représentant Yokogawa le plus proche.
- D** Alle Betriebsanleitungen für ATEX Ex bezogene Produkte stehen in den Sprachen Englisch, Deutsch und Französisch zur Verfügung. Sollten Sie die Betriebsanleitungen für Ex-Produkte in Ihrer Landessprache benötigen, setzen Sie sich bitte mit Ihrem örtlichen Yokogawa-Vertreter in Verbindung.
- S** Alla instruktionsböcker för ATEX Ex (explosionssäkra) produkter är tillgängliga på engelska, tyska och franska. Om Ni behöver instruktioner för dessa explosionsssäkra produkter på annat språk, skall Ni kontakta närmaste Yokogawakontor eller representant.
- GR** Όλα τα εγχειρίδια λειτουργίας των προϊόντων με ATEX Ex διατίθενται στα Αγγλικά, Γερμανικά και Γαλλικά. Σε περίπτωση που χρειάζεστε οδηγίες σχετικά με Ex στην τοπική γλώσσα παρακαλούμε επικοινωνήστε με το πλησιέστερο γραφείο της Yokogawa ή αντιπρόσωπο της.
- SK** Všetky návody na obsluhu pre prístroje s ATEX Ex sú k dispozícii v jazyku anglickom, nemeckom a francúzskom. V prípade potreby návodu pre Ex-prístroje vo Vašom národnom jazyku, skontaktujte prosím miestnu kanceláriu firmy Yokogawa.
- CZ** Všechny uživatelské příručky pro výrobky, na něž se vztahuje nevybušné schválení ATEX Ex, jsou dostupné v angličtině, němčině a francouzštině. Požadujete-li pokyny týkající se výrobků s nevybušným schválením ve vašem lokálním jazyku, kontaktujte prosím vaši nejbližší reprezentační kancelář Yokogawa.
- LT** Visos gaminio ATEX Ex kategorijos Eksploatavimo instrukcijos teikiami anglų, vokiečių ir prancūzų kalbomis. Norėdami gauti prietaisų Ex dokumentaciją kitomis kalbomis susisiekite su artimiausiu bendrovės "Yokogawa" biuru arba atstovu.
- LV** Visas ATEX Ex kategorijas izstrādājumu Lietošanas instrukcijas tiek piegādātas angļu, vācu un franču valodās. Ja vēlaties saņemt Ex ierīšu dokumentāciju citā valodā, Jums ir jāsazinās ar firmas Jokogava (Yokogawa) tuvāko ofisu vai pārstāvi.
- EST** Kõik ATEX Ex toodete kasutamishuendid on esitatud inglise, saksa ja prantsuse keeles. Ex seadmete muukeelse dokumentatsiooni saamiseks pöörduge lähima lokagava (Yokogawa) kontori või esindaja poole.
- PL** Wszystkie instrukcje obsługi dla urządzeń w wykonaniu przeciwwybuchowym Ex, zgodnych z wymaganiami ATEX, dostępne są w języku angielskim, niemieckim i francuskim. Jeżeli wymagana jest instrukcja obsługi w Państwa lokalnym języku, prosimy o kontakt z najbliższym biurem Yokogawy.
- SLO** Vsi predpisi in navodila za ATEX Ex sorodni pridelki so pri roki v angleščini, nemščini ter francoščini. Če so Ex sorodna navodila potrebna v vašem tujejnem jeziku, kontaktirajte vaš najbliži Yokogawa office ili predstavnika.
- H** Az ATEX Ex műszerek gépkönyveit angol, német és francia nyelven adjuk ki. Amennyiben helyi nyelven kér fel az Ex eszközök leírásait, kérjük keressék fel a legközelebbi Yokogawa irodát, vagy képviselőt.
- BG** Всички упътвания за продукти от серията ATEX Ex се предлагат на английски, немски и френски език. Ако се нуждаете от упътвания за продукти от серията Ex на родния ви език, се свържете с най-близкия офис или представителство на фирма Yokogawa.

- RO** Toate manualele de instructiuni pentru produsele ATEX Ex sunt in limba engleza, germana si franceza. In cazul in care doriti instructiunile in limba locala, trebuie sa contactati cel mai apropiat birou sau reprezentant Yokogawa.
- M** Il-manwali kollha ta' l-istruzzjonijiet għal prodotti marbuta ma' ATEX Ex huma disponibbli bl-Ingliż, bil-Germaniż u bil-Franċiż. Jekk tkun teħtiegħ struzzjonijiet marbuta ma' Ex fil-lingwa lokali tiegħek, għandek tikkuntattja lill-eqreb rappreżentant jew ufficiċċju ta' Yokogawa.

Control of Pollution Caused by the Product

This is an explanation for the product based on "Control of Pollution caused by Electronic Information Products" in the People's Republic of China.

電子情報製品汚染制御管理弁法 (中国版RoHS)

产品中有害物质或元素的名称及含量

型号	部件名称	有害物质					
		铅 (Pb)	汞 (Hg)	镉 (Cd)	六价铬 (Cr(VI))	多溴联苯 (PBB)	多溴二苯醚 (PBDE)
YTA110/310/320	壳体	×	○	○	○	○	○
TYA50/70	基板组件	×	○	○	○	○	○
YTA70P		×	○	○	○	○	○
温度变送器	电源连接线	×	○	○	○	○	○

○: 表示该部件的所有均质材料中的有害物质的含量均在 GB/T26572 标准中所规定的限量以下。
×: 表示至少该部件的某些均质材料中的有害物质的含量均在 GB/T26572 标准中所规定的限量以上。

环保使用期限:
该标识适用于 SJ /T11364 中所述, 在中华人民共和国销售的电子电气产品的环保使用期限。
注) 该年数为“环保使用期限”, 并非产品的质量保质期。

1. Model and Suffix Codes

Model	Suffix code	Descriptions
YTA70	Temperature Transmitter
Output Signal	-J	4 to 20mA DC with digital communication (HART 5/HART 7 protocol)
Optional Specifications	/KS2	ATEX intrinsically safe approval
	/SS2	IECEx intrinsically safe, FM intrinsically safe/ Nonincendive, and ATEX intrinsically safe approval combination

2. Warranty

The warranty period of the instrument is as of condition shown when purchasing. Any trouble arising during the warranty period shall be replaced at free of charge. The following problems or troubles shall not be eligible of charge-exempt repair.

- Caused by improper usage or storage of the customer which exceeds the specification requirements.
- Caused by mishandling or modification.
- Caused by fire, earthquake or other acts of God that are not directly a result of problems of the instrument.

3. Handling Precautions

- This manual and the identification tag attached on packing box are essential parts of the product; keep them in a safe place for future reference.
- Read this manual thoroughly and carefully before handling the instruments. Observe the instructions.
- This product is designed to be used by a person with specialized knowledge.
- Store the product in location that meets the following requirements.
 - No exposure to rain or water
 - No major mechanical vibration or shock
 - Humidity and Temperature limitations
 - Ordinary conditions(25°C, 65%) is preferable.
 Otherwise, as of specified in "Standard Specifications."
- Avoid corrosive atmosphere for storage and installation.
- For safe installation of the transmitter in hazardous area, the following must be observed. The module must only be installed by qualified personnels who are familiar with the national and international laws, directives, and standards that apply to this area.
- Yokogawa will not be liable for malfunctions or damage resulting from any modification made to this instrument by the customer.
- Product Disposal
The instrument should be disposed of in accordance with local and national legislation/regulations.
- Authorized Representative in EEA
In relation to the CE Marking, The authorized representative for this product in the EEA (European Economic Area) is:
Yokogawa Europe B.V.
Euroweg 2, 3825 HD Amersfoort, The Netherlands

Printed Manual

Document No.	Title
IM 01C50C03-02EN	YTA70 Temperature Transmitter

Electronic Manual

Document No.	Title
IM 01C50C03-02EN	YTA70 Temperature Transmitter

You can download the latest manual from the following website:

Website address: <http://www.yokogawa.com/fid/>

Note: When products whose suffix code or optional codes contain code "Z" and an exclusive document is attached, please read it along with this manual.

General Specifications

Document No.	Title
GS 01C50C03-00EN	YTA70 Temperature Transmitter

4. Standard Specifications

Accuracy (see table below)

Sensor type	Standard	Input ranges		Minimum span		Accuracy (value whichever is greater)
		°C	°F	°C	°F	
<T/C>						
B*1	IEC60584	400 to 1820	752 to 3308	200	360	±0.1% of span or ±1.0°C
E		-100 to 1000	-148 to 1832	50	90	±0.1% of span or ±0.5°C
J		-100 to 1200	-148 to 2192	50	90	
K		-180 to 1372	-292 to 2502	50	90	
N		-180 to 1300	-292 to 2372	100	180	
R		-50 to 1760	-58 to 3200	200	360	±0.1% of span or ±1.0°C
S		-50 to 1760	-58 to 3200	200	360	
T		-200 to 400	-328 to 752	50	90	±0.1% of span or ±0.5°C
L	DIN43710	-100 to 900	-148 to 1652	50	90	
U		-200 to 600	-328 to 1112	75	135	
Lr*2	GOST 3044-84	-200 to 800	-328 to 1472	50	90	±0.1% of span or ±1.0°C
W3	ASTM	0 to 2300	32 to 4172	200	360	
W5	E988-90	0 to 2300	32 to 4172	200	360	
<RTD>						
Pt100	IEC60751	-200 to 850	-328 to 1562	10	18	±0.1% of span or ±0.1°C
Ni100	DIN43760	-60 to 250	-76 to 482	10	18	±0.1% of span or ±0.2°C
DC Voltage		-800 to 800 [mV]		2.5 [mV]		±0.1% of span or ±0.01mV
Resistance		0 to 7000 [Ω]		25 [Ω]		±0.1% of span or ±0.1Ω

*1: In T/C type B for output signal code J, the minimum range value can be set from 0. However, the accuracy between 0 to 400 is not specified.

*2: Applicable for protocol revision of HART 7.

Cold Junction Compensation Accuracy(For T/C only)
±1°C (±1.8°F)

Ambient Temperature Effects (per 10°C Change)

For E, J, K, L, N, T and U thermocouple inputs:
±0.05% of span or ±0.25°C, whichever is greater
For R, S, B, Lr, W3 and W5 thermocouple inputs:
±0.05% of span or ±1°C, whichever is greater
For Pt100 and Ni100 RTD inputs:
±0.05% of span or ±0.05°C, whichever is greater
For DC voltage input:
±0.05% of span or ±5μV, whichever is greater
For Resistance(ohm) input:
±0.05% of span or ±0.05Ω, whichever is greater

Power Supply Effects

±0.005% of FS per Volt

EMC Conformity

EN 61326-1 Class A, Table2
EN 61326-2-3

EU RoHS Directive

Applicable standard: EN 50581

- The production date can be confirmed by the serial number following the caption "No." in the serial number label on the product.
Serial numbers (9 letters): NNYMnnnnn
NN: Identification code of production site
Y: Year of production
2015: Use "R" 2016: Use "S" 2017: Use "T" 2018: Use "U"
2019: Use "V"
M: Month of production
January to September: Use "1" to "9" (January: 1, September: 9).
October: Use "A". November: Use "B". December: Use "C".
nnnnn: 5-digit number assigned sequentially in each production date by the production site.
- Serial Number Label (affixed on the bottom side)

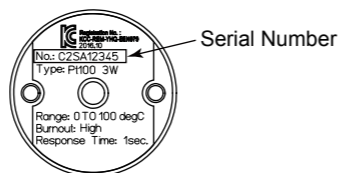

F15E.ai

CAUTION

This instrument is a Class A product, and it is designed for use in the industrial environment. Please use this instrument in the industrial environment only.

Maximum Zero Offset

±50% of selected maximum value

Input Signal Source Resistance (for T/C, mv)

10 MΩ, or 3 kΩ at power-off

Input Lead Wire Resistance (for RTD, ohm)

5 Ω per wire or lower
(up to 50 Ω per wire is configurable with reduced measurement accuracy)

Burnout

High(NAMUR NE43 upscale) , Low(NAMUR NE43 downscale) or value within 3.5 to 20 mA

Output

Two wire 4 to 20 mA DC

Response Time

1 to 60 sec programmable

Ambient Temperature Limits (Option code may affect limit)

-40 to 85°C (-40 to 185°F)

Ambient Humidity Limits

0% to 95% RH (non-condensation)

Supply Voltage

8 to 35 V DC
8 to 30 V DC for Intrinsically safe type
13.8 to 35 V DC for digital communication

Load Resistance

Limitation: 0 to (E-8)/0.0236 [Ω], where E is power supply voltage.
250 to 600 Ω, for digital communication

Isolation

Input/output isolated to 1500 V AC.

Mounting

DIN form B head mounting

Terminals

M3 screws

Weight

50 g (0.11 lb)

5. Block Diagram

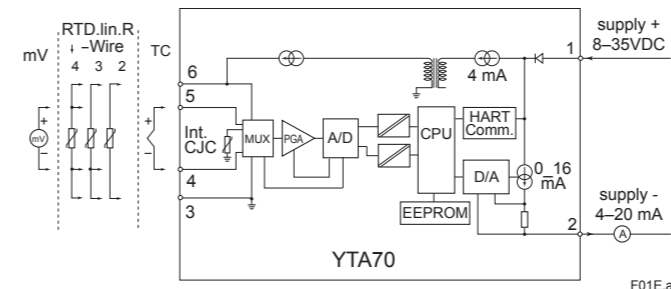

F01E.ai

6. Wiring

See wiring diagram. For output signal, use twisted pair or cables with performance equivalent to 600V vinyl insulate cable. For wiring in high or low temperature, use a wire or cable suitable for such temperature. Use cables and wires which meet atmospheric conditions. Take necessary measure to avoid corrosion or damage of cables and wires.

IMPORTANT

When mounting on a sensor head, do not overtighten the screws.

Wiring Diagram

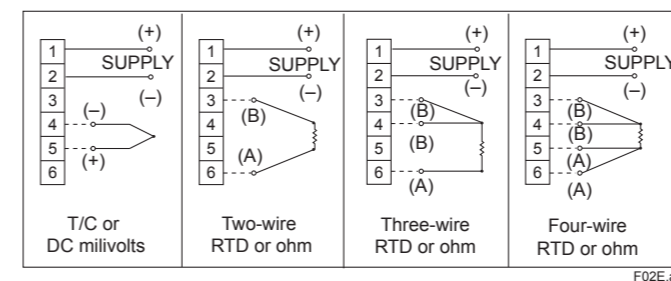

F02E.ai

Dimensions

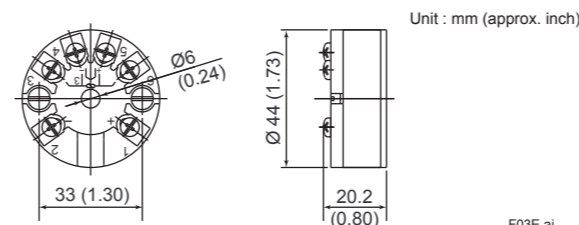

F03E.ai

7. Approvals Options

7.1 ATEX Intrinsically safe model (K/S2, /SS2)

ATEX Installation drawing YTA70QA01

For safe installation the following must be observed. The module shall only be installed by qualified personnel who are familiar with the national and international laws, directives and standards that apply to this area.
Year of manufacture can be taken from the first two digits in the serial number.

ATEX Certificate: KEMA 10ATEX 0027X

Marking: II 1 G Ex ia IIC T6 or T4 Ga
II 1 D Ex ia IIC Da

Standards: EN 60079-0: 2012+A11, EN 60079-11: 2012

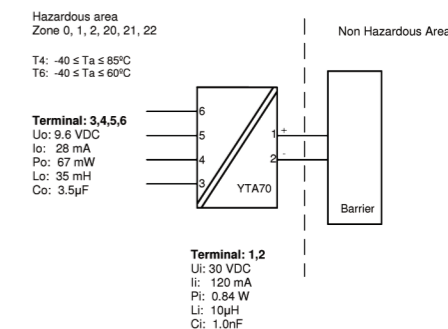

YTA70QA01 2016-02-01

ATEX Installation drawing YTA70QA01

General installation instructions

The sensor circuit is not intrinsically galvanic isolated from the supply output circuit. However, the galvanic isolation between the circuits is capable of withstanding a test voltage of 500Vac during 1 minute.
If the enclosure is made of aluminium, it must be installed such, that even in the event of rare incidents, ignition sources due to impact and friction, sparks are excluded.
If the enclosure is made of non-metallic material or painted metals electrostatic charging shall be avoided.

Special conditions for safe use

For installation in a potentially explosive gas atmosphere, the following instructions apply:
The transmitter shall be mounted in an enclosure form B according to DIN43729 or equivalent that is providing a degree of protection of at least IP20 according to EN60529 that is suitable for the application and correctly installed.
For installation in a potentially explosive dust atmosphere, the following instructions apply:
The transmitter shall be mounted in a metal enclosure form B according to DIN43729 or equivalent, that is providing a degree of protection of at least IP6X according to EN60529 that is suitable for the application and correctly installed.
Cable entries and blanking elements shall be used that are suitable for the application and correctly installed.
The surface temperature of the enclosure is equal to the ambient temperature +20 K, for a dust layer with a maximum thickness of 5 mm

YTA70QA01 2016-02-01

7.2 FM Intrinsically safe/Nonincendive model (/SS2)

Applicable Standard: Class 3600, Class 3610, Class 3611, Class 3810, ANSI/ISA-60079-0, and ANSI/ISA-60079-11

Installation diagram

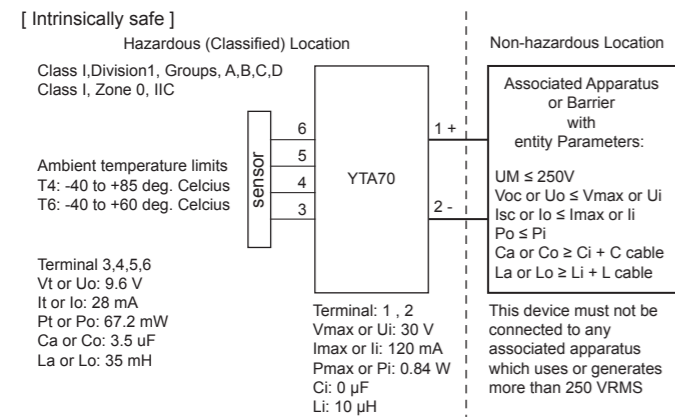

The entity concept

The Transmitter must be installed according to National Electrical Code (ANSI-NFPA 70) and shall be installed with the enclosure, mounting, and spacing segregation requirement of the ultimate application.

Equipment that is FM-approved for intrinsic safety may be connected to barriers based on the ENTITY CONCEPT. This concept permits interconnection of approved transmitters, meters and other devices in combinations which have not been specifically examined by FM, provided that the agency's criteria are met. The combination is then intrinsically safe, if the entity concept is acceptable to the authority having jurisdiction over the installation.

The entity concept criteria are as follows:

The intrinsically safe devices, other than barriers, must not be a source of power.

The maximum voltage $U_i(V_{MAX})$ and current $I_i(I_{MAX})$, and maximum power $P_i(P_{MAX})$, which the device can receive and remain intrinsically safe, must be equal to or greater than the voltage (U_o or V_{OC} or V_t) and current (I_o or I_{SC} or I_t) and the power P_o which can be delivered by the barrier.

The sum of the maximum unprotected capacitance (C_i) for each intrinsically device and the interconnecting wiring must be less than the capacitance (C_a) which can be safely connected to the barrier.

The sum of the maximum unprotected inductance (L_i) for each intrinsically device and the interconnecting wiring must be less than the inductance (L_a) which can be safely connected to the barrier.

The entity parameters U_o, V_{OC} or V_t and I_o, I_{SC} or I_t , and C_a and L_a for barriers are provided by the barrier manufacturer.

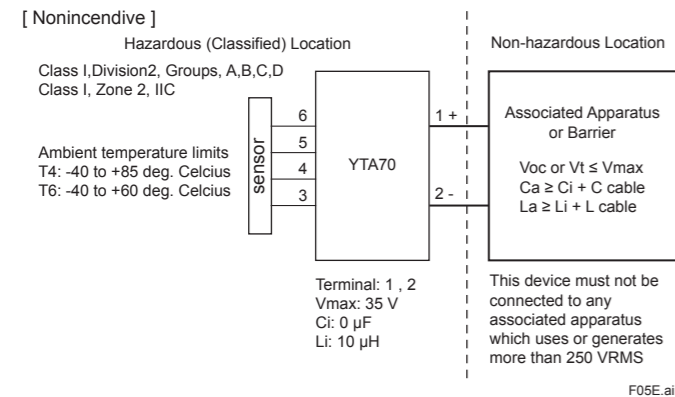

7.3 IECEx Scheme Intrinsically safe model (/SS2)

For safe installation of YTA70 the following must be observed. The module shall only be installed by qualified personnel who are familiar with the national and international laws, directives and standards that apply to this area. Year of manufacture can be taken from the first two digits in the serial number.

Certificate No.: IECEx KEM 10.0086

Applicable Standard: IEC 60079-0:2007-10, IEC 60079-11:2006, IEC 60079-26:2006, IEC 61241-11:2005

[Installation diagram]

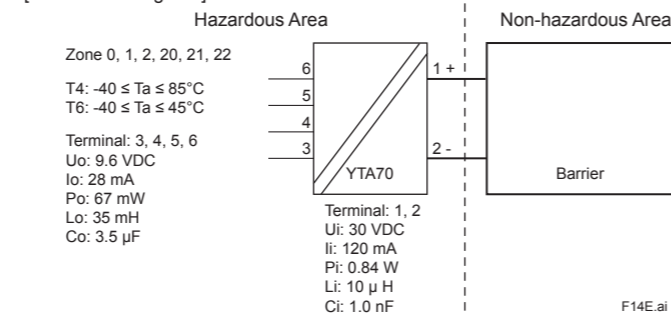

Installation notes

For installation in a potentially explosive gas atmosphere, the following instructions apply:

The sensor circuit is not infallibly galvanic isolated from the supply output circuit. However, the galvanic isolation between the circuits is capable of withstanding a test voltage of 500Vac during 1 minute.

The transmitter shall be mounted in an enclosure form B according to DIN43729 or equivalent that is providing a degree of protection of at least IP20 according to EN60529 that is suitable for the application and correctly installed.

If the enclosure is made of aluminium, it must be installed such, that even in the event of rare incidents, ignition sources due to impact and friction, sparks are excluded.

If the enclosure is made of non-metallic materials, electrostatic charging shall be avoided.

For installation in a potentially explosive dust atmosphere, the following instructions apply:

The transmitter shall be mounted in a metal enclosure form B according to DIN43729 or equivalent, that is providing a degree of protection of at least IP6X according to EN60529 that is suitable for the application and correctly installed.

Cable entries and blanking elements shall be used that are suitable for the application and correctly installed.

For an ambient temperature ≥60°C, heat resistant cables shall be used with a rating of at least 20 K above the ambient temperature.

For installation in mines the following instructions apply:

The transmitter shall be mounted in a metal enclosure that is providing a degree of protection of at least IP6X according to EN60529, and is suitable for the application and correctly installed.

Cable entries and blanking elements shall be used that are suitable for the application and correctly installed.

7.4 Name Plate

[/KS2]

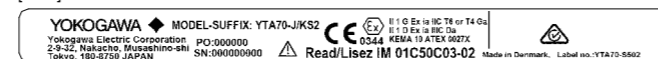

[/SS2]

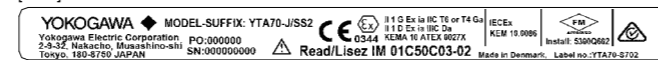

F06E.ai

8. HART Communication

8.1 Connection and Requirements

A standard HART communicator can be used for programming the YTA70. The HART communicator must be loaded with the appropriate DDL driver for YTA70.

Minimum loop resistance is 250Ω. If the receiving equipment has a lower resistance, a serial resistor must be inserted to communicate with the HART communicator.

[Connection]

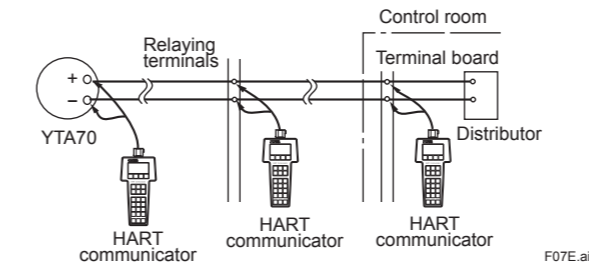

[Communication requirement]

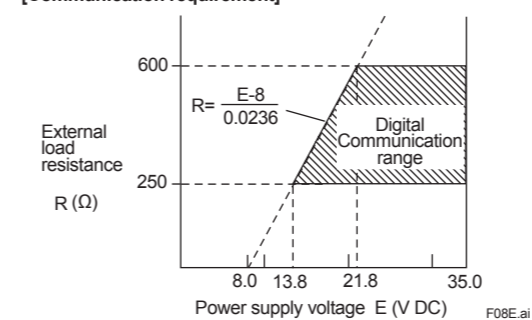

8.2 Switching HART Protocol Revision

HART protocol revision of the transmitter can be selectable from 5 or 7. The HART protocol revision is set and shipped as specified in the order. To change the HART protocol revision after shipment, follow the procedure shown below. Please note that selecting HART 5 will change the model code of YTA70-J to YTA70-E on the configuration tool.

- 1) Call up the parameter for protocol revision change.
Device setup -> Detailed setup -> Device information -> Revision numbers -> Chng universal rev
- 2) Activate the "Chg universal rev" method.
- 3) Select OK for confirmation message screen twice.
- 4) Select a HART protocol revision 5 or 7.
- 5) Enter a write protect password. The default password is "*****", eight asterisks.
- 6) The device will automatically restarts with a new HART protocol revision. Restart the HART configuration tool for parameter settings.

8.3 Parameters

YTA70 HART 7 DTM Menu Tree

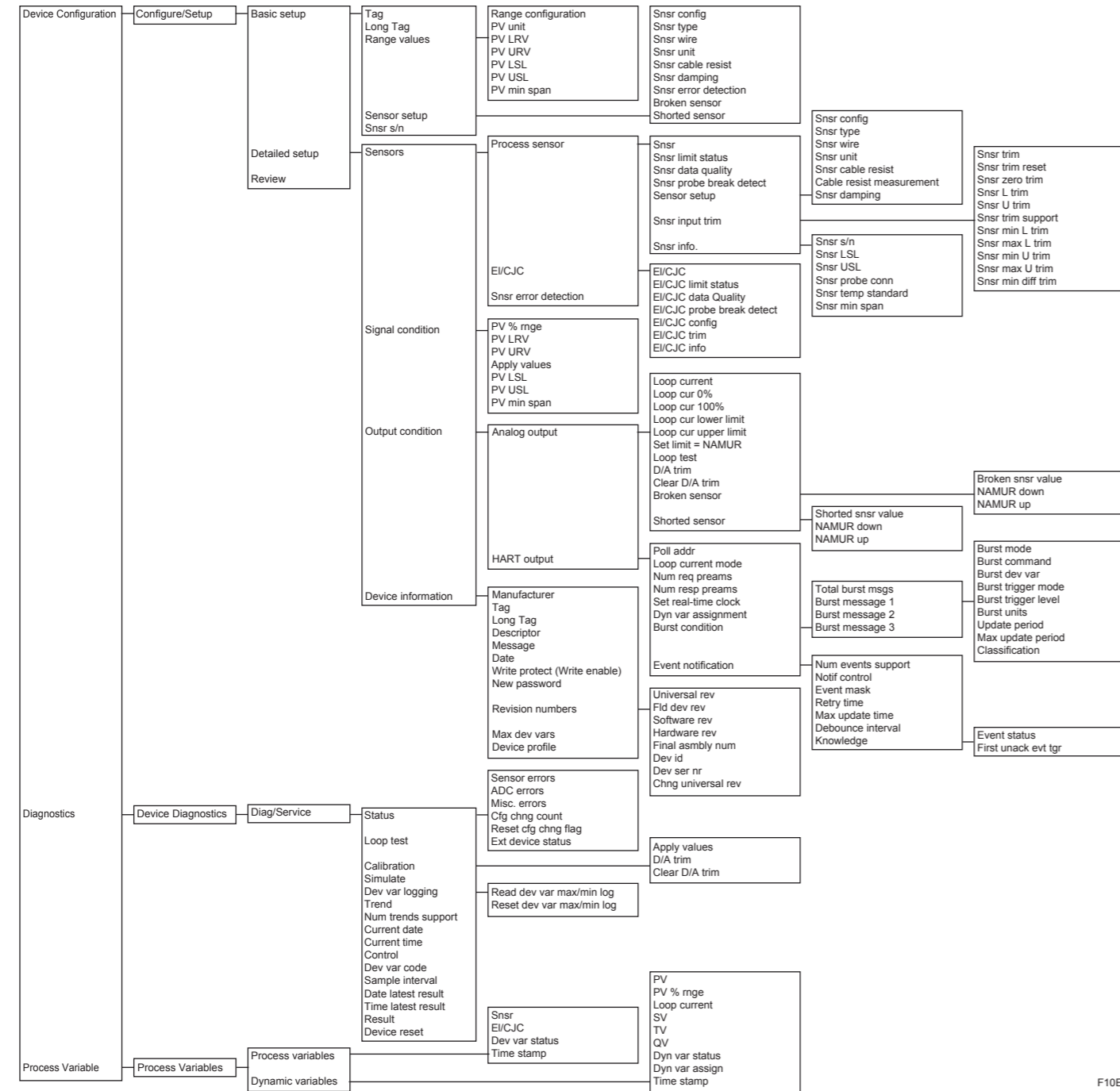

F10E.ai

YTA70 HART 7 DD Menu Tree

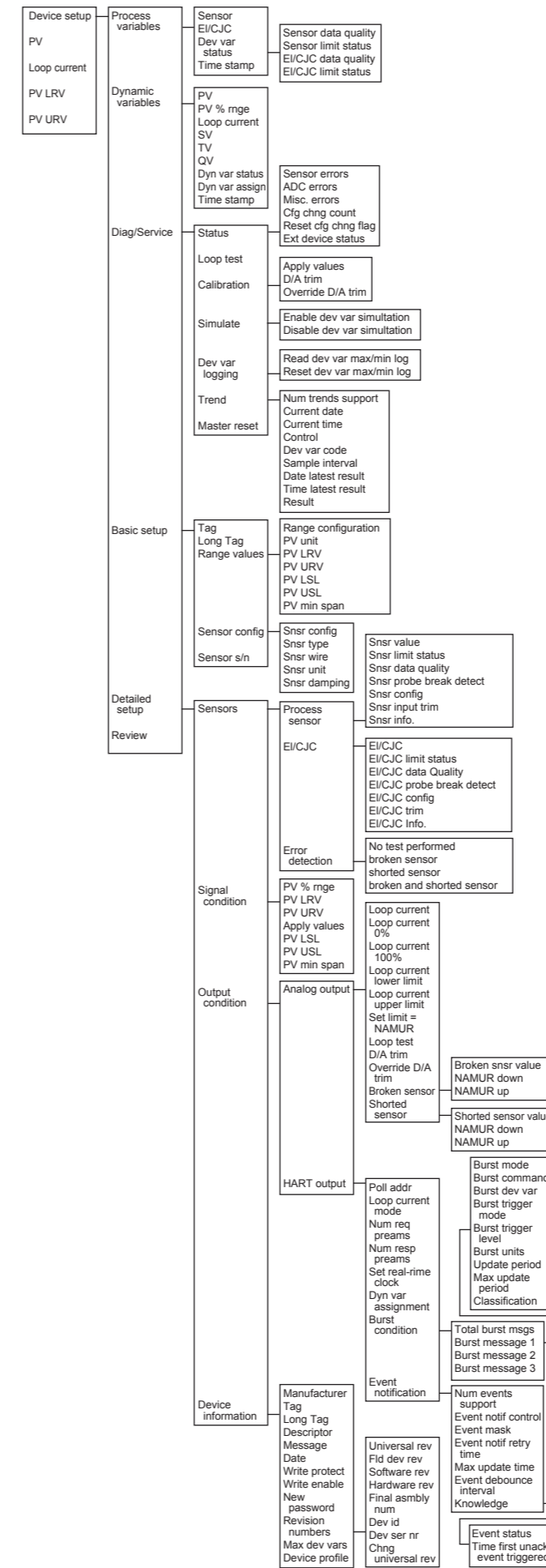

F11E.ai

YTA70 HART 5 DD Menu Tree

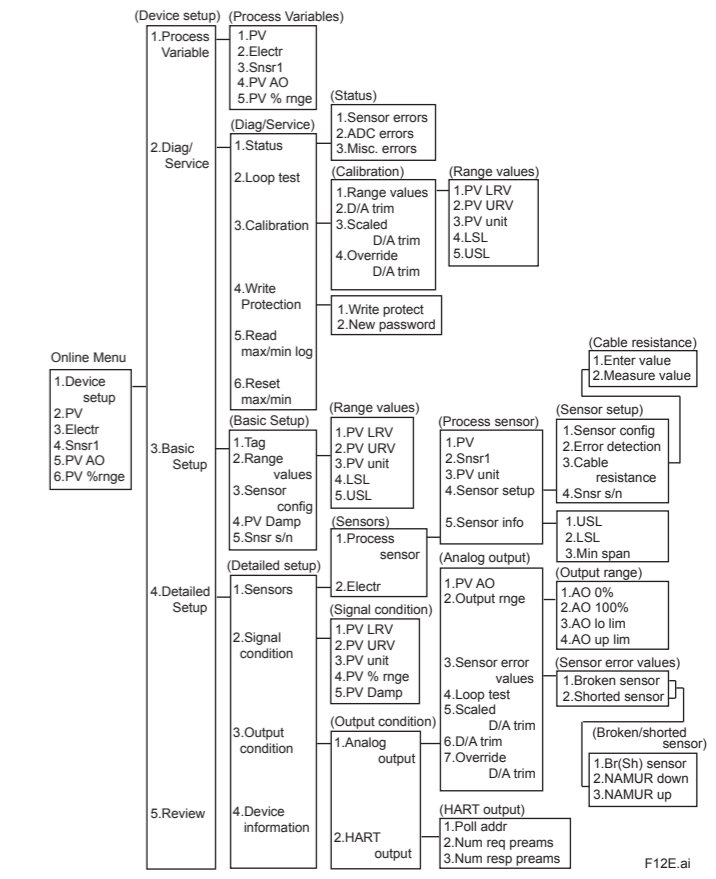

F12E.ai

Device Variables Mapping (HART 7)

There are two device variables available.

- 1) Sensor
- 2) Electronics/CJC (EI/CJC)

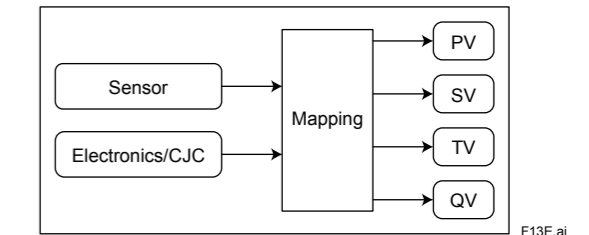

F13E.ai

Burst Parameters (HART 7)

Command Parameter	Burst Command	Burst Msg Trigger Mode	Burst Trigger Source	Burst Trigger Units
PV Temperature value assigned to PV	Cmd1: PV	Continuous Window Rising Falling On-change	- PV	- Depend on PV assignment
% range/Loop current	Cmd2: % range/Current	Continuous Window Rising Falling On-change	- % range	- %
Process variables/ Loop current	Cmd3: Dyanamic variables/Current	Continuous Window Rising Falling On-change	- PV	- Depend on PV assignment
Process vars/% range/Loop current with status	Cmd9: Device variables with status	Continuous Window Rising Falling On-change	- Sensor, EI/CJC, PV, SV, TV, QV(*1)	- Depend on burst trigger source
Process vars/% range/Loop Current	Cmd33: Device variables	Continuous Window Rising Falling On-change	- Sensor, EI/CJC, PV, SV, TV, QV(*1)	- Depend on burst trigger source
Self diagnosis information	Cmd48: Additional device status	Continuous	-	-

(*1) Loop current and % range are selectable from menu but not available.

Parameters List

Item	Parameter name	Protocol revision	Descriptions	Initial setting		
Process variables	Process variable	Snsr <PV>	7 <5>	Measured variables in engineering unit	-	
		EI/CJC <Electr>	7 <5>	Terminal temperature	-	
		Dev var status	7	Display data quality and limit status of Snsr and EI/CJC	-	
	Dynamic variable	PV/SV/TV/QV	7	Display dynamic variables	-	
		Dyn var status	7	Display data quality and limit status of PV/SV/TV/QV	-	
		Dyn var assign	7	Setting an assignment for PV/SV/TV/QV	PV=Sensor, SV=EI/CJC, TV=QV=None	
	Output value	Loop current <PV AO>	7 <5>	Output value in mA	-	
		PV % mge	7, 5	Output value with respect to the range in %	-	
	PV Log	Read max/min log	5	Reads the maximum/minimum PV stored in the memory	-	
		Reset max/min	5	Clears the PV maximum/minimum log and restart logging	-	
Signal Condition	Range value	Range configuration	7	Range setting for PV LRV/PV URV	-	
		PV LRV/PV URV	7, 5	Lower/upper range value to defines the 0%/100% value of the measurement	0°C/150°C	
		Apply values	7	Rerange by actual input	-	
	Range Limit	Snsr LSL/USL	7	Maximum/minimum values for range setting	-	
		EI/CJC LSL/USL	7	Maximum/minimum values for EI/CJC range	-40°C, 135°C	
		PV LSL/PV USL <LSL/USL>	7 <5>	Shows the max./min. usable value for upper/lower range value	-	
	Unit	Snsr unit	7	Unit of sensor	°C	
		EI/CJC unit	7	Unit of EI/CJC	°C	
		PV unit	7, 5	Unit of PV	°C	
	Damping	Snsr damping <PV Damp>	7 <5>	Damping time constant in seconds: 0.4 to 60.0s	0.4s	
		EI/CJC damping	7	Damping time constant in seconds: 0.4 to 60.0s	0.4s	
	Sensor Setup	Sensor config	Snsr config	7	Sensor type and related settings.	-
			Snsr type	7, 5	Sensor type and related settings. [When T/C or millivolts is selected] Always select "single" for a measurement type. [When RTD or ohm is selected] Always select 2-, 3- or 4-wire but others for the number of sensor wires.	Pt100, 3-wire, °C *1
			Snsr wire	7	Display the number of sensor	3-wire
Snsr EI/CJC type			7	Display Internal CJC or Fixed CJC	Internal sensor	
Snsr s/n			7	Setting of serial number for connected sensor	0	
RTD factor			5	For RTD only. Leave it to "1."	1	
Cold junction compensation			5	For T/C only. Always leave it to "1.internal sensor."	Internal sensor	
Cable resistance		Snsr cable resist	7	Display resistance of sensor cable	5.0Ω	
		Cable resist measurement <Measure value>	7 <5>	Actually measure the cable resistance of 2-wire RTD/ohm for compensation	-	
		Enter value	5	Enter new value of the RTD/ohm cable resistance for compensation	5.0Ω	
Minimum span limit		PV min span	7	Display PV minimum span	10°C	
		Snsr min span <Min. span>	7 <5>	Minimum settable span	10°C	
		EI/CJC min span	7	EI/CJC minimum span	10°C	
Sensor errors		Error detection	5	Type of sensor errors to be detected for burnout operation. (1)No test performed, (2) broken sensor, (3)shorted sensor*3, or (4)broken & shorted*3	broken sensor	
Output Condition	Analog output range	Loop cur 0%(100%) <AO 0%(100%)>	7 <5>	Output value for 0%(100%) in mA.	4mA(20mA)	
		Loop cur lower(upper) limit <AO lo(up) lim>	7 <5>	Output lower(upper) limit in mA. NAMUR, or 3.8 to 23mA	3.8mA(20.5mA)	
		Set limit = NAMUR	7	Setting for loop cur lower limit = 3.8mA, loop cur upper limit = 20.5mA	-	
		Loop test	7, 5	Change the output manually for testing the loop. 4mA, 20mA, or value within 3.5 to 23mA	-	
	Sensor error value	Broken snsr value	7	Setting for analog output value when sensor broken	23.0mA	
		Shorted snsr value	7	Setting for analog output value when sensor shorted	3.6mA	
		NAMUR down	7	Set analog output value to 3.5mA	-	
		NAMUR up	7	Set analog output value to 23mA	-	
		Sensor error values	5	Enter or select the output value when sensor error is detected. NAMUR upscale, NAMUR downscale, or value within 3.5 to 23mA	NAMUR upscale [high]*1	
		Diagnostics	Status	Snsr errors	7, 5	Show error status related to a sensor. When any one of the errors turns "ON", check the sensor and wiring
ADC errors	7, 5			Show error status related to analog to digital conversion. When any one of the errors turns "ON", restart the device. If error remains, replace the device	-	
Misc. errors	7, 5			Show error status related to a device. When any one of the errors turns "ON", restart the device. If error remains, replace the device.	-	
Ext device status	7			This bit is set if any Device Variable is in an Alarm or Warning State	Device Variable Alert (0x02)	
Cfg chng count	7			Configuration change counter	-	
Reset cfg chng flag	7			Reset configuration change counter	-	
Error detection	Snsr error detection			7	Type of sensor errors to be detected for burnout operation	broken and shorted sensor
	Snsr probe break detect		7	Display "Snsr probe break detect" when sensor error	None	
	Service		Device variable logging	Read dev var max/min log	7	Reads the maximum/minimum PV stored in the memory
Reset dev var max/min log				7	Clears the PV maximum/minimum log and restart logging	-
Data trending		Trend	7	Data trending support function	-	
Simulation	Simulate	7	Execution of device variable simulation	-		
Device reset	Master reset	7	Software reset	-		

Item	Parameter name	Protocol revision	Descriptions	Initial setting	
Calibration	Analog output trim	D/A trim	7, 5	Allows the calibration of a selected analog output with an external reference at the operating endpoint	-
		Clear D/A trim <Override D/A trim>	7 <5>	Overrides any previous D/A trimming by restoring factory calibration values	-
		Scaled D/A trim	5	Allows the calibration of the analog output with the external reference which is scaled at 0 to 100%	-
		Sensor trim	Snsr trim	7	Trimming
	Snsr zero trim		7	Zeroing	-
	Snsr trim reset		7	Reset sensor trim for factory setting	-
	Snsr L trim		7	Display lower point of sensor trim	200.0°C
	Snsr U trim		7	Display upper point of sensor trim	850.0°C
	HART output		Time stamp	7	date and the time information which the transmitter maintains from the time of the power on
		Polling address	Poll addr	7	Display and setting for multidrop (0 to 63)
Loop current mode			7	Loop current setting at multidrop	Off
Preambles		Num req preams	7	Number of requested preambles	5
		Num resp preams	7	Number of response preambles	5
Set real-time clock		Set real-time clock	7	Setting for date and time	1900/1/1 0:00
Burst mode		Total burst msgs	7	The number of burst mode functions	3
		Burst mode	7	Setting for burst mode	Off
		Burst command	7	Setting for burst command	cmd1
		Burst dev var	7	Setting for device variable of cmd9 or cmd33	First slot: DV0, the rest not used
	Burst trigger mode	7	Burst trigger mode selection from "Continuous", "Window", "Rising", "Falling", or "On change"	Continuous	
	Burst trigger level	7	Setting for burst trigger level	0°C	
	Burst units	7	Setting for unit of burst trigger level	°C	
	Update period	7	Update period for burst message	8s	
	Max update period	7	Maximum update period for burst message	60s	
	Event notification	Num events support	7	Maximum number of event support	1
Notif control		7	Enable event notification on token-passing data link layer	Off	
Event mask		7	Even masking	Off	
Retry time		7	Event notification retry time	8s	
Max update time		7	Maximum update time for event notification	60s	
Debounce interval		7	Debounce Interval to detect an event	8s	
Event status		7	Display event status	-	
First unack evt tgr		7	Display event time	-	
Device information		Manufacturer	7, 5	Manufacturer identification code	YOKOGAWA
		Model	7, 5	Model name	YTA70-J
	Tag	7, 5	Tag number, up to 8 alphanumeric characters	-	
	Long Tag	7, 5	Tag number, up to 32 alphanumeric characters.	-	
	Descriptor	7, 5	Text which can be used by user in any way. Up to 16 alphanumeric characters	-	
	Message	7, 5	Text which can be used by user in any way. Up to 32 alphanumeric characters	-	
	Date	7, 5	Date information. MM/DD/YY. Not incremented. The date is updated whenever changing on figuration via configuration tool	Factory calibration date	
	Write protect	7, 5	Enable write protect if correct password is entered*2	Not protected	
	Write enable	7	Disable write protect	-	
	New password	7, 5	Sets a new password for write protection, if correct password is entered	-	
Revision numbers	7, 5	Revision information for software and hardware	-		
Chng universal rev	7	HART protocol revision switch function	As specified in order		
Review	Input info	7, 5	List of input variables	-	
	Output info	7, 5	List of output variables	-	
	Device info	7, 5	See "Device information" in this table	-	

*1: Or as specified upon ordering.

*2: The initial setting of password upon shipment is "*****".

*3: With T/C or millivolts for sensor type, the alarm is generated when the input signal drops down below 2.5 mV.

◆ Revision Record

● Manual No. : IM 01C50C03-02EN

● Title : YTA70 Temperature Transmitter

Edition	Date	Page	Revised item
1st	Jan. 2014	—	New Publication.
2nd	Apr. 2016	P.1 3. Handling Precaution 4. Standard Specifications	Add (6) and (7) Delete RFI Effects Revised description of EMC conformity Revised description of Load resistance
		P.2 7. Approval Options	Revised ATEX intrinsically safe model Revised name plate

Edition	Date	Page	Revised item
3rd	June 2017	P.1	Add Control of Pollution Caused by the Product
		P.2 3. Handling Precaution 4. Standard Specifications	Add (1), (3) and Note Add EU RoHS Directive