

V150 Spring Lock – Threaded Components

The Most Accurate and Reliable Technology for Measuring Gas, Liquid and Steam...

Developed from aerospace technology, the VERIS Verabar® averaging pitot flow sensor provides unsurpassed accuracy and reliability. With its solid, one-piece construction and bullet shape, the VERIS Verabar® makes flow measurement leak resistant and precise.

The unique sensor shape reduces drag and flow induced vibration.

The location of the low-pressure ports significantly reduces the potential for clogging and improves signal stability.



V150

V150 Spring Lock	
Pipe Connection	Threaded (NPT)
Mounting Type	Spring loaded sensor with packing gland
Features and Benefits	<ul style="list-style-type: none"> • Best valued model • Blow-out and leak resistant design • Preloads sensor to opposite wall • Four times stronger than conventional mountings • Eliminates need for opposite end support • Compensates for changes in pipe diameter due to pressure, temperature or mechanical force
Applications	<ul style="list-style-type: none"> • Air (compressed, combustion) • Natural gas • Water (raw, cooling, feedwater) • High velocity fluids • Steam
Special Designs — Consult Factory	<ul style="list-style-type: none"> • Custom mounting, lengths, materials, instrument connections, etc. • Short straight run

Temperature Pressure Limits (ANSI Class)*
600#
1440 psig @ 100°F (99.3 bar @ 38°C)
825 psig @ 800°F (56.9 bar @ 426°C)

Model Specifications	V150		
Sensor Code	05	10	15
Sensor Diameter	7/16" (11mm)	7/8" (22mm)	1-3/8" (35mm)
Accuracy	±1% of flow rate; up to +/-0.5% if calibrated		
ANSI Class*	600#	600#	600#
Pipe Size	2" - 6" (50mm-150mm)	6" - 42" (150mm-1050mm)	12" - 60" (300mm-1500mm)
Instrument Connection	1/2" NPT or Direct Mount		
Components Furnished	Weld coupling, Spring lock mounting assembly		
Weld Coupling Size	3/4" NPT	1" NPT	2" NPT

* DIN and JIS flanges available. Consult factory.

1. Enter Pipe Dimensions or Duct Dimensions

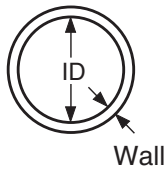

Pipe Size _____ Sch _____
 Pipe ID _____ and
 Wall _____ Pipe Material _____

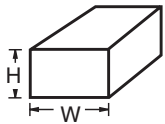

Height (H) _____
 Width (W) _____
 Wall _____
 Duct Material _____

Dimension
 Verabar® spans
 (H) or (W)

2. Pipe or Duct Orientation

(Check one box)

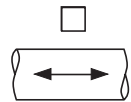

(H) Horizontal

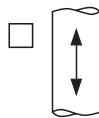

(V) Vertical

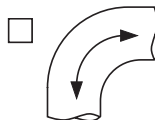

Short
 Straight Run
 Consult Factory

3. Enter Flow Conditions

Fluid Name:		Maximum	Nominal	Minimum	Units
Flow Rate					
All Fluids	Pressure @ Flow				
	Temperature @ Flow				
Gas	Specific Gravity, or Molecular Weight				
Liquid	Specific Gravity				
Steam	VeraCalc Program can calculate Density from Temperature and Pressure				

4. Select Model

(From Page 3)

Use the Ordering Information table on Page 3 to determine your model number.

5. Flow Calculation

All VERIS Verabar® applications require a flow calculation to verify the DP, pressure and temperature limits, structural limits and to size the transmitter. VeraCalc is for use by representatives and end users. It is easy to operate and includes steam tables.

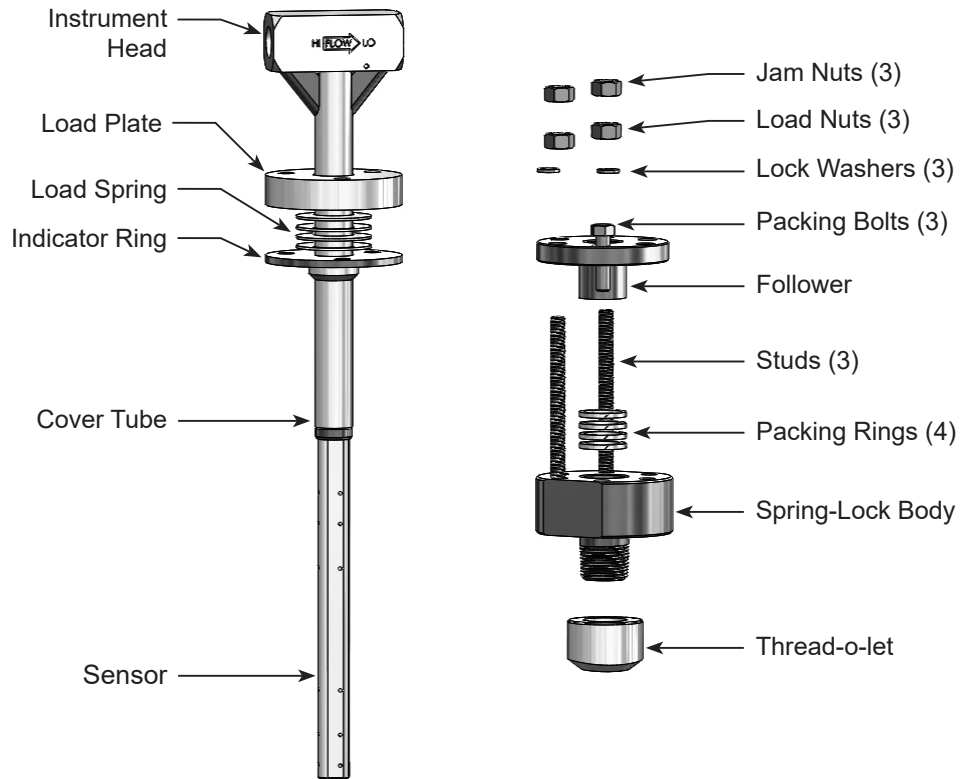







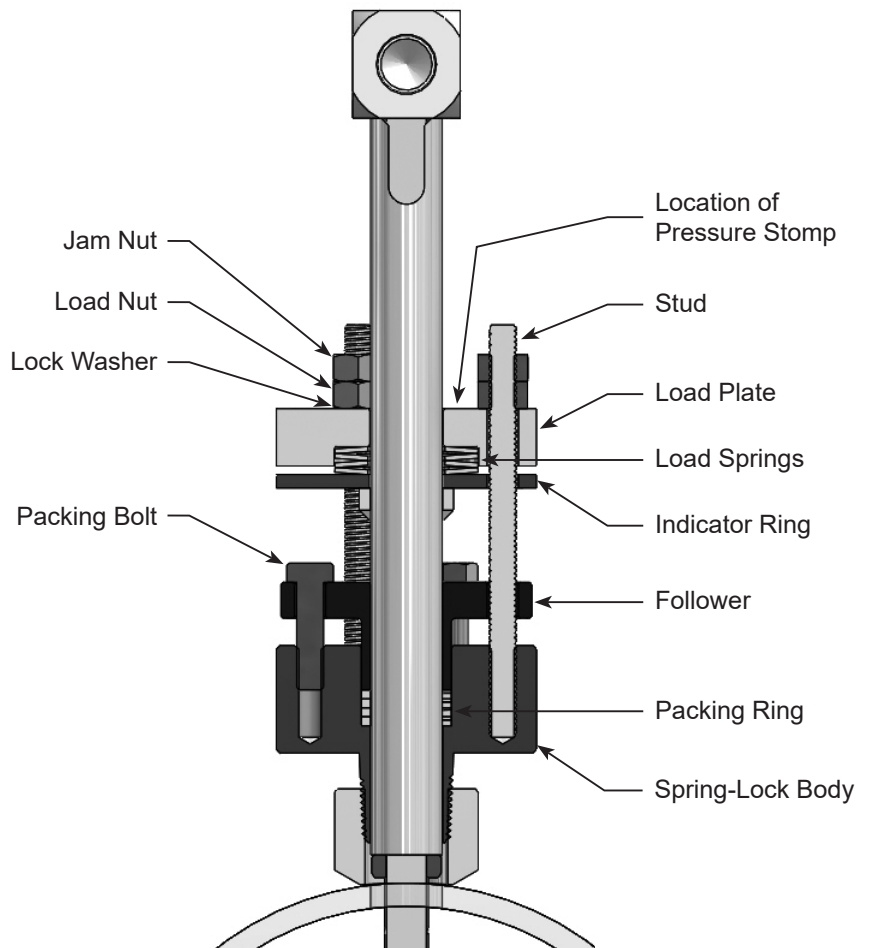

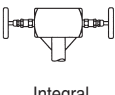
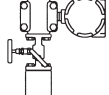
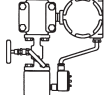
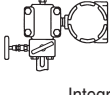

Verabar® Model V150

Spring Lock Mount

- Design ensures the sensor is sealed, locked and pre-loaded to the opposite wall, regardless of changes in pipe diameter due to pressure, temperature or mechanical vibrations.
- Leak resistant...compensates for differential in packing and body growth rates due to increased temperatures.
- Increases sensor strength (eliminates the need for an opposite wall support). A locked, pre-loaded sensor is four times stronger than a non pre-loaded, cantilevered sensor.
- By loading the sensor and packing independently, the sensor can move axially to maintain a precise load on the pipe wall.

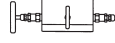

Model	Regular					
V150	Spring Lock					
Pipe Size and Schedule or Exact ID and Wall Thickness						
Code	Sensor Pipe Size Range					
05	2" to 6" (50mm to 150mm)					
10	6" to 48" (150mm to 1200mm)					
15	12" to 60" (300mm to 1500mm)					
Code	Pipe Orientation					
H	Horizontal					
V	Vertical					
Instrument Connections (Select Remote or Direct Mount) (Transmitter sold separately)						
 Remote Mount Transmitter (1/2" NPT)				 Direct Mount Transmitter (Flanged 450°F/232°C Max.)†		
Parallel	Regular	RTD*	Valve	Transmount	Mass Transmount	Manifold
			 Integral		 Integral RTD	 Integral
P	R	D	T	F	G	M
Instrument Valves (Opt.)			Manifolds (Optional)			
 Remote Mount			 Direct Mount			
Needle	Gate	3-Valve		5-Valve		
 1/2" NPT	 1/2" NPT	 Soft Seat Hard Seat		 Soft Seat Hard Seat		
C2NC (CS) C2NS (SS)	C2GC (CS) C2GS (SS)	F3SC (CS) F3SS (SS)	F3HC (CS) F3HS (SS)	F5SC (CS) F5SS (SS)	F5HC (CS) F5HS (SS)	
Optional						
Code	Options					
WNS	For stainless steel pipes. For V150, furnished with one SS weld coupling.					
V150	8"sch40	10	H	R	C2NC	Typical Model Number

* For high pressure (>500psig) or high temperature (>500°F), remote mount RTD in a thermowell is preferred.

† Assuming adequate heat dissipation for transmitter.

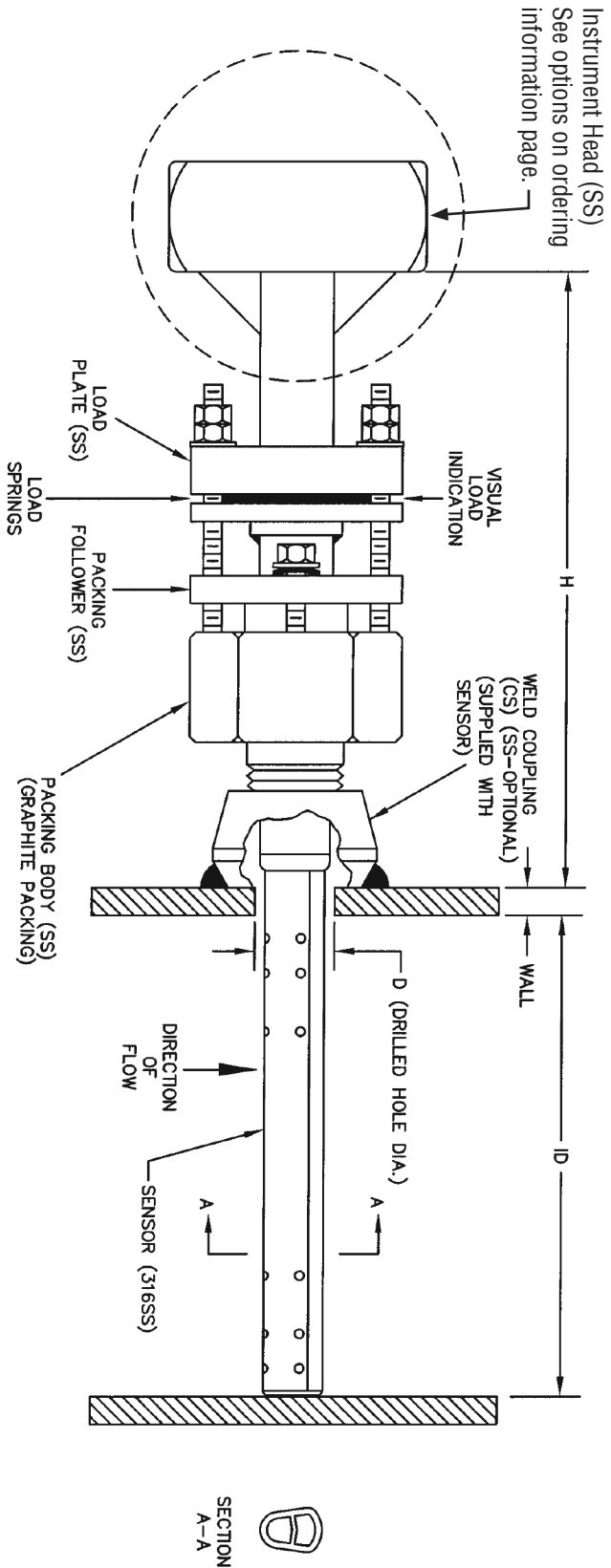

ITEM	SENSOR -05	SENSOR -10	SENSOR -15
ANSI RATING	CLASS 600#	CLASS 600#	CLASS 600#
SENSOR DIA.	7/16" (11mm)	7/8" (22mm)	1-3/8" (35mm)
DIM "D" DRILLED HOLE DIAMETER	1/2" (13mm)	1" (26mm)	1-1/2" (39mm)
COUPLING SIZE	3/4" NPT	1" NPT	2" NPT
DIM "H"	7.5" (191mm)	10.2" (259mm)	11.7" (297mm)

		
VERIS Flow Measurement Group armstronginternational.com/veris		
DATE: 09/20/01	DWG. No. SUB-3935	Rev: A
Scale: NTS	Page 1 of 1	

VERIS Verabar® V150
Spring Lock,
Threaded



Armstrong VERIS Flow Measurement Group
 6315 Monarch Park Pl, Niwot, CO 80503 - USA Phone: 303-652-8550 Fax: 303-652-8552
 armstronginternational.com