



SIDOR

SETTING NEW STANDARDS FOR EXTRACTIVE PHOTOMETERS

Extractive gas analyzers

SICK
Sensor Intelligence.

UNCOMPLICATED, SUPERIOR AND VERY GOOD VALUE FOR MONEY

Superior in its field: with never-before-seen long-time stability in measurements, the SIDOR extractive gas analyzer – depending on the measuring task – measures gas components CO, NO, SO₂, CO₂, CH₄ and O₂. It satisfies all requirements for emission measurements in accordance with 13 and 27 of the BImSchV (Federal Immission Control Act), is ideal for combustion optimization in small boilers and makes operational measurements in power plants.



With the innovative SIDOR gas analyzer, SICK is focusing on consistent standardization and optimization of measurement technology. This pays off at the latest with the savings in running operating costs. The SIDOR is an extractive gas analyzer for the measurement of one or two gas components. Additionally, oxygen can be measured by an electrochemical or paramagnetic measuring cell (optional). A variety of freely-configurable digital inputs and outputs greatly simplifies the arrangement of a measurement system.

The shallow installation depth allows for installation even when space is tight or when the replacement of old analog equipment is necessary. The fully-automatic and low-maintenance operation with control functions for the operational measurement technology characterizes the SIDOR, as does easy readjustment, self-monitoring and fault diagnosis. The easy-to-understand displays on a large LC screen and help texts in various languages round out the convenient operation of the device.

Innovative device concept

Thanks to the shallow installation depth, the 19" rack housing with 3 height units (HU) can be used anywhere space is tight or old equipment has to be replaced. The basic device contains a keyboard and display in the front view, electronics and gas connections (6 mm PVDF) with integrated measuring gas pressure correction as well as an analyzer module for measuring an IR component.

Options for expansion are:

- An additional SIDOR module for measuring a second gas component
- O₂ sensor OXOR-E (electro-chemical) or OXOR-P (paramagnetic)
- Measuring gas pump
- Humidity monitor
- Flow monitor
- Gas connections: 6 mm SWAGELOK
- Gas connections: ¼" SWAGELOK

Proven measurement technology

A microprocessor controls the fully-automatic and low-maintenance operation, readjustment of the SIDOR as well as self-monitoring and fault diagnosis. The measured values are automatically standardized using the ultra-modern signal evaluation system, which also considerably reduces the influence of interference.

The chopper wheel unit can supply a second SIDOR module with a second emitter so that two IR active gases can be simultaneously measured completely independently of each other.

Long-term stability

The intelligent signal processing and highly stable detectors make long-term sensitivity stability possible. It is therefore only necessary to readjust the zero point with measuring-gas-free ambient air once a week and the sensitivity with test gas every six months.

On-site repair options

The innovative concept makes uncomplicated on-site repairs possible. For example, cells can be exchanged on-site without complex alignment work. This is made possible due to the symmetrical structure of the cell which always locks into the correct position of the guide. The exchange of other device components is as easy as it is quick. The high precision in the production of devices enables on-site repairs without elaborate temperature compensation in the factory. The SIDOR is designed for quick and easy exchange of old analyzers. The compact and extremely short 19" housing can be installed into existing systems even if space is very tight.



Cell with locking function for simple mounting

SIDOR E – completely configured analyzer devices

for the measurement of the most common components and measuring ranges with defined product variants.

- **Flexible use:** Within the specified ranges, the desired measuring range can be conveniently set for the application in question.
- **Flexible adaptation:** The devices are delivered with the setting “mg/m³”. They can be converted to ppm with ease at any time.
- **Easy and efficient ordering:**
 - Via part number
 - Via regional sales organization
 - Direct online via www.sick.com/SIDOR
- **Short delivery time:** The devices are fully configured stock items and are delivered within a few days once the order has been received.

For details refer to “Ordering information” on page 7.

WE SET STANDARDS FOR EXTRACTIVE PHOTOMETERS

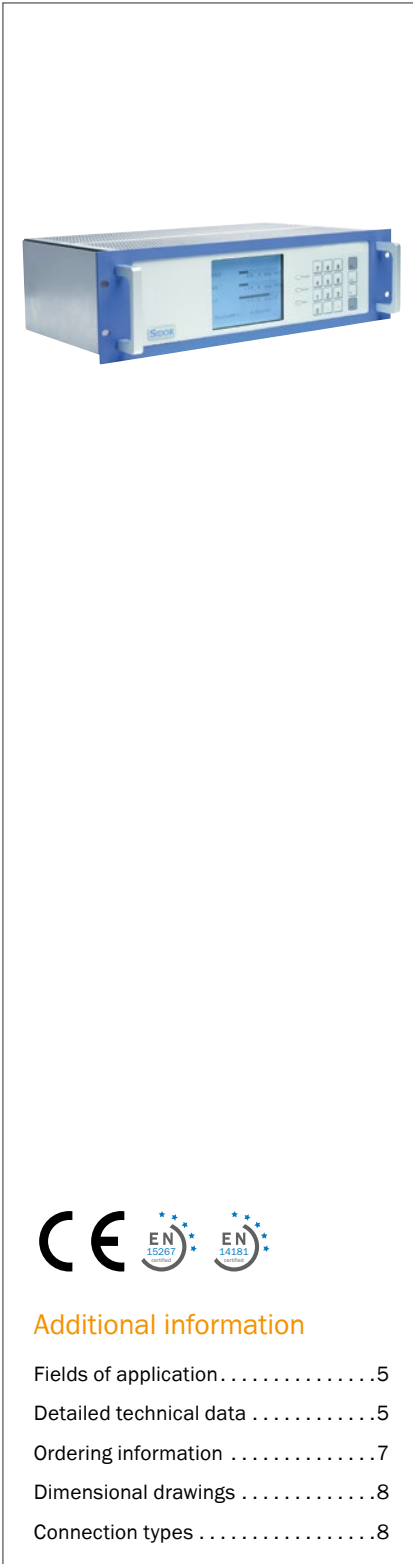

Product description

The SIDOR is a gas analyzer for measurement of up to 2 infrared components. Additionally oxygen can be measured by integration of an electrochemical or paramagnetic measuring cell. A significant characteristic is a half-yearly maintenance interval with test gases.

The stability of the measuring cells allows an adjustment with only inert gas or ambient air within this half-year period. Sample gas pressure compensation is included as a standard. The SIDOR was type approved for large combustion plants and crematories.

At a glance

- Detector with high long-term stability
- Paramagnetic or electrochemical O₂ measurement
- Automated adjustment with component-free ambient air
- Immune to contamination

Your benefits

- Automated readjustment, self-monitoring, and fault diagnosis
- Test gas only needs to be checked every 6 months
- Long maintenance intervals
- TÜV suitability testing and MCERTS certification according to EN 15267
- Can be repaired on-site in many cases
- Replacement of components without complicated factory temperature calibration



Additional information

Fields of application	5
Detailed technical data	5
Ordering information	7
Dimensional drawings	8
Connection types	8

→ www.sick.com/SIDOR

For more information, simply visit the above link to obtain direct access to technical data, CAD design models, operating instructions, software, application examples, and much more.

Fields of application

- Emission monitoring according to 13th (2001/80/EC) and 27th German Federal Emission Protection Directive (BImSchV).
- Combustion optimization of small boilers
- Monitoring of landfill gas and bio fermenters
- Operational measurements in power stations

Detailed technical data

The exact device specifications and performance data of the product may deviate from the information provided here, and depend on the application in which the product is being used and the relevant customer specifications.

SIDOR system

Gas flow rate	30 l/h ... 60 l/h
Sample gas temperature	0 °C ... +45 °C Temperature at analyzer inlet
Process pressure	-200 hPa ... 300 hPa
Process gas humidity	Non-condensing
Dust load	Free of dust and aerosols
Ambient temperature	+5 °C ... +45 °C
Storage temperature	-20 °C ... +70 °C
Ambient humidity	≤ 95 % Relative humidity; non-condensing
Conformities	Approved for plants requiring approval 2001/80/EC (13. BImSchV) 2000/76/EC (17. BImSchV) 27.BImSchV TA-Luft (Prevention of Air Pollution) EN 15267 EN 14181 MCERTS
Electrical safety	CE, cCSAus
Enclosure rating	IP 20
Analog outputs	4 outputs: 4 ... 20 mA, 500 Ω Electrically isolated
Digital outputs	8 relay contacts: 30 V AC, 500 mA / 48 V DC, 500 mA Three relay outputs preset for failure, service and maintenance 8 transistor outputs: 24 V DC, 500 mA Freely adjustable
Digital inputs	8 optical coupler inputs: 24 V DC Electrically isolated; freely programmable
Interfaces and bus protocols	RS-232c Modbus RTU
Indication	LC display
Operation	Menu-driven operation via LC-display and membrane keyboard
Menu languages	German, English, French, Italian, Dutch, Polish, Swedish, Spanish
Model	19" rack enclosure with 3 rack units, for integration in cabinets
Dimensions (W x H x D)	483 mm x 132.5 mm x 332 mm (for details see dimensional drawings)
Weight	9 kg ... 12 kg Depending on configuration

Power supply	Voltage	100 V / 115 V / 230 V
	Frequency	48 ... 62 Hz
	Power consumption	≤ 150 W
		Depending on system configuration
Sample gas connections	PVDF bulkhead fitting For hose 6 x 1 mm Option: Swagelok 6 mm Option: Swagelok 1/4"	
Corrective functions	Manual or automatic single-point adjustment with ambient air Manual or automated adjustment with test gases	
Options	Integrated sample gas pump Flow sensor Humidity sensor	

SIDOR analyzer module

Description	Selective NDIR analyzer for continuous measurement of one gas component which absorbs in the infra-red spectral range	
Measurement principles	NDIR spectroscopy	
Measuring ranges	CH ₄	0 ... 5,000 ppm / 0 ... 100 Vol.-%
	CO	0 ... 60 ppm / 0 ... 100 Vol.-%
	CO ₂	0 ... 500 ppm / 0 ... 100 Vol.-%
	NO	0 ... 93 ppm / 0 ... 3 Vol.-%
	N ₂ O	0 ... 100 ppm / 0 ... 100 Vol.-%
	SO ₂	0 ... 35 ppm / 0 ... 3 Vol.-%
Certified measuring ranges	CO	0 ... 75 mg/m ³ / 0 ... 375 mg/m ³ / 0 ... 3,000 mg/m ³
	NO	0 ... 125 mg/m ³ / 0 ... 600 mg/m ³
	SO ₂	0 ... 100 mg/m ³ / 0 ... 200 mg/m ³ / 0 ... 500 mg/m ³
Response time (t₉₀)	3 s Typical at 60 l/h, depending on cell length and gas flow	
Sensitivity drift	≤ 2 % per quarter with regular 1-point adjustment	
Zero point drift	≤ 2 % per quarter with regular 1-point adjustment	
Material in contact with media	Viton B, PVDF, glass, Aluminum, stainless steel 1.4571	

OXOR-E analyzer module

Description	Determination of oxygen content using an electrochemical cell	
Measurement principles	Electrochemical cell	
Measuring ranges	O ₂	0 ... 10 Vol.-% / 0 ... 25 Vol.-%
Certified measuring ranges	O ₂	0 ... 25 Vol.-% / 0 ... 10 Vol.-%
Response time (t₉₀)	30 s Typical at 60 l/h, depending on gas flow	
Sensitivity drift	≤ 1 % of measuring range full scale per week ≤ 2 % per quarter with regular 1-point adjustment	
Zero point drift	≤ 2 % of the measuring range full scale value per month ≤ 0.2 % per quarter with regular 1-point adjustment	
Material in contact with media	Viton B, PVDF, stainless steel 1.4571	

OXOR-P analyzer module

Description	Accurate oxygen analyzer which operates according to the paramagnetic measurement principle
Measurement principles	Paramagnetic dumbbell principle
Measuring ranges	O ₂ 0 ... 3 Vol.-% / 0 ... 100 Vol.-%
Certified measuring ranges	O ₂ 0 ... 25 Vol.-% / 0 ... 10 Vol.-%
Response time (t₉₀)	≤ 4 s At a gas flow of 60 l/h
Sensitivity drift	≤ 1 % of measuring range full scale per week ≤ 2 % per quarter with regular 1-point adjustment
Zero point drift	≤ 1 % of smallest measuring range per week Measuring ranges smaller 5 vol%: ≤ 0.05 Vol.-% per week ≤ 0.2 % per quarter with regular 1-point adjustment
Material in contact with media	Viton B, PVDF, glass, stainless steel 1.4571, platinum, nickel, Aluminum

Ordering information

The analyzer devices listed below are completely configured and available with a short delivery time. Furthermore, a large number of device configurations – also customized – are available on request. Our regional sales organization will help you to select the optimum device configuration. → www.sick.com/SIDOR

Smallest measuring range	Largest measuring range	Integrated components	Type	Part no.
CO: 0 ... 75 mg/m ³ O ₂ : 0 ... 10 Vol.-% SO ₂ : 0 ... 100 mg/m ³	0 ... 750 mg/m ³ 0 ... 25 Vol.-% 0 ... 1,000 mg/m ³	2 SIDOR analyzer modules OXOR-E analyzer module PVDF bulkhead fitting	SIDOR E 1217519	1217519
CO: 0 ... 600 mg/m ³ O ₂ : 0 ... 10 Vol.-% SO ₂ : 0 ... 800 mg/m ³	0 ... 3,000 mg/m ³ 0 ... 25 Vol.-% 0 ... 8,000 mg/m ³	2 SIDOR analyzer modules OXOR-E analyzer module PVDF bulkhead fitting	SIDOR E 1217520	1217520
NO: 0 ... 125 mg/m ³ O ₂ : 0 ... 10 Vol.-% SO ₂ : 0 ... 100 mg/m ³	0 ... 1,250 mg/m ³ 0 ... 25 Vol.-% 0 ... 1,000 mg/m ³	2 SIDOR analyzer modules OXOR-E analyzer module PVDF bulkhead fitting	SIDOR E 1217521	1217521
NO: 0 ... 1,000 mg/m ³ O ₂ : 0 ... 10 Vol.-% SO ₂ : 0 ... 800 mg/m ³	0 ... 5,000 mg/m ³ 0 ... 25 Vol.-% 0 ... 8,000 mg/m ³	2 SIDOR analyzer modules OXOR-E analyzer module PVDF bulkhead fitting	SIDOR E 1217522	1217522
CO: 0 ... 75 mg/m ³ NO: 0 ... 125 mg/m ³ O ₂ : 0 ... 10 Vol.-%	0 ... 750 mg/m ³ 0 ... 1,250 mg/m ³ 0 ... 25 Vol.-%	2 SIDOR analyzer modules OXOR-E analyzer module PVDF bulkhead fitting	SIDOR E 1217523	1217523
CO: 0 ... 600 mg/m ³ NO: 0 ... 125 mg/m ³ O ₂ : 0 ... 10 Vol.-%	0 ... 3,000 mg/m ³ 0 ... 1,250 mg/m ³ 0 ... 25 Vol.-%	2 SIDOR analyzer modules OXOR-E analyzer module PVDF bulkhead fitting	SIDOR E 1217524	1217524
CO: 0 ... 600 mg/m ³ NO: 0 ... 1,000 mg/m ³ O ₂ : 0 ... 10 Vol.-%	0 ... 3,000 mg/m ³ 0 ... 5,000 mg/m ³ 0 ... 25 Vol.-%	2 SIDOR analyzer modules OXOR-E analyzer module PVDF bulkhead fitting	SIDOR E 1217525	1217525
CO: 0 ... 100 mg/m ³ O ₂ : 0 ... 10 Vol.-%	0 ... 1,000 mg/m ³ 0 ... 25 Vol.-%	1 SIDOR analyzer module OXOR-E analyzer module PVDF bulkhead fitting	SIDOR E 1217526	1217526

Dimensional drawings (Dimensions in mm (inch))

Analyzer

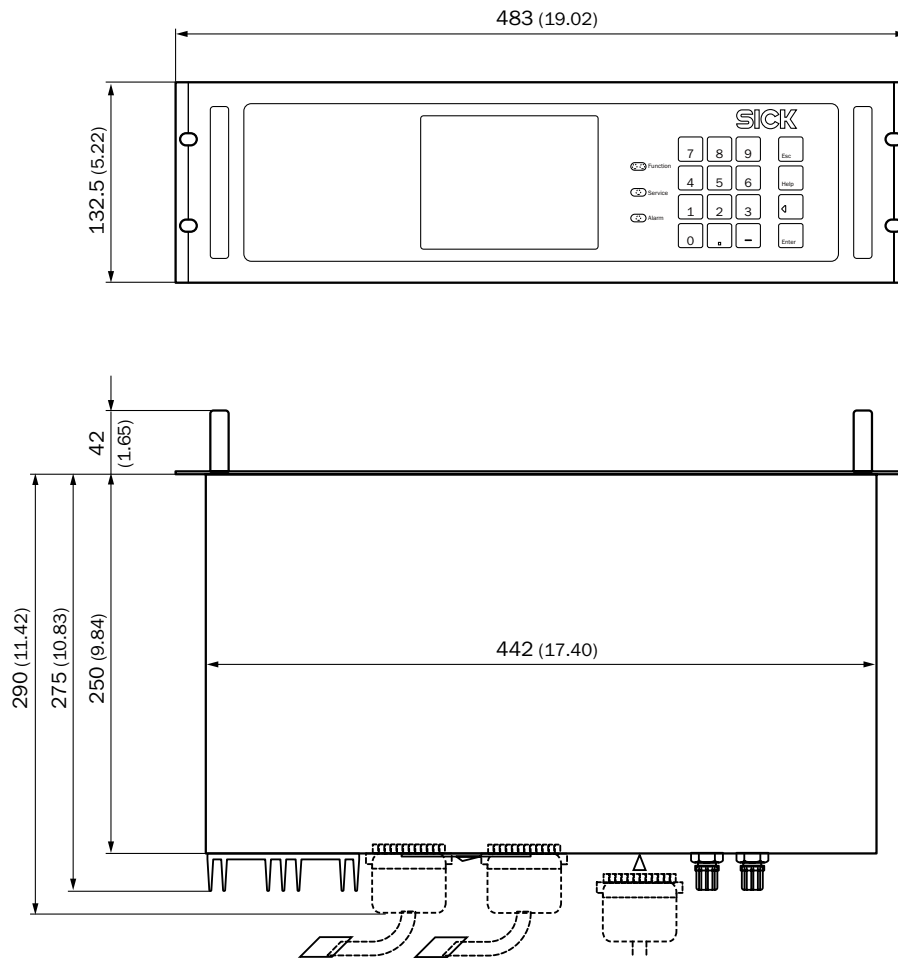

Connection types

Gas connections

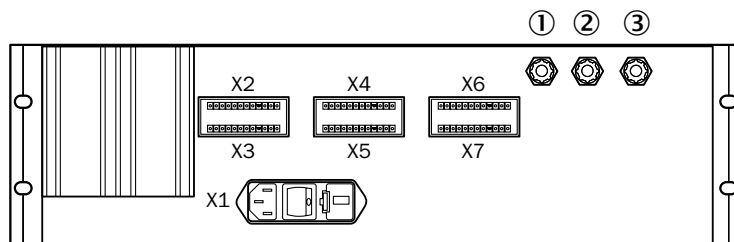

- ① Sample gas inlet
- ② Exhaust gas outlet
- ③ Zero gas

Plug connectors X2 (interfaces) and X3 (control inputs)

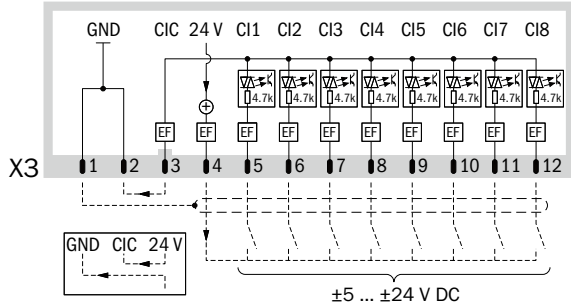
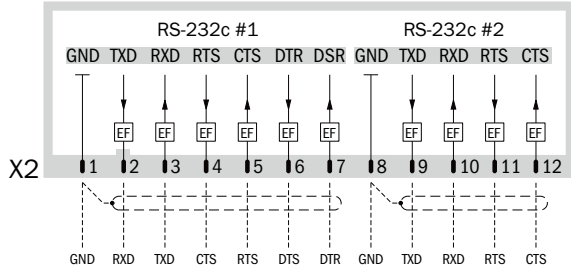

Keep away from external voltages!

X6 (transistor switching outputs) and X7 (measured value outputs) male connectors

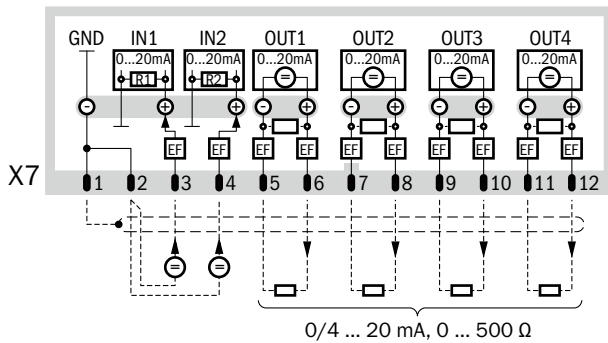
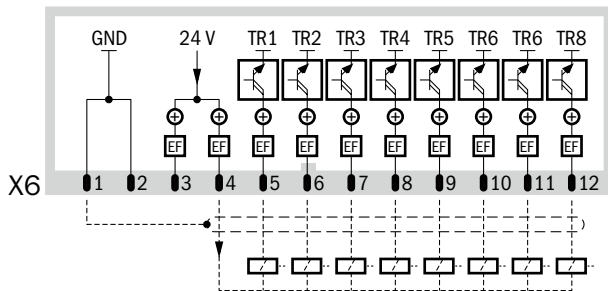

Only use internal voltage sources (24 V DC), max. 500 mA single, max. 1000 mA total (TR1 ... TR8). Inductive loads must be equipped with discharging diodes.

X4 and X5 male connectors (relay switching outputs)

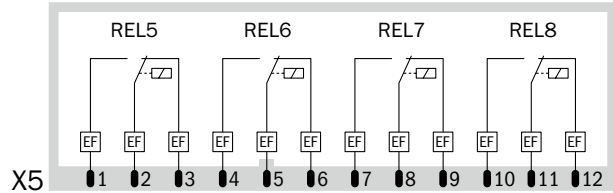
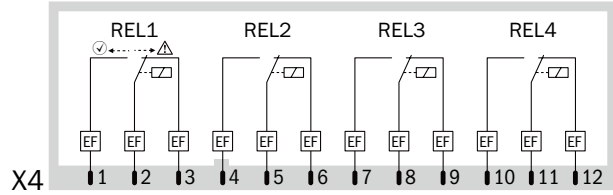

Max. 48 V peak voltage (34 V AC / 48 V DC), max. 500 mA. Inductive loads must be equipped with discharging diodes.

REGISTER AT WWW.SICK.COM TODAY AND ENJOY ALL THE BENEFITS





- ✔ Select products, accessories, documentation and software quickly and easily.
- ✔ Create, save and share personalized wish lists.
- ✔ View the net price and date of delivery for every product.
- ✔ Requests for quotation, ordering and delivery tracking made easy.
- ✔ Overview of all quotations and orders.
- ✔ Direct ordering: submit even very complex orders in moments.
- ✔ View the status of quotations and orders at any time. Receive e-mail notifications of status changes.
- ✔ Easily repeat previous orders.
- ✔ Conveniently export quotations and orders to work with your systems.



SERVICES FOR MACHINES AND SYSTEMS: SICK LifeTime Services

Our comprehensive and versatile LifeTime Services are the perfect addition to the comprehensive range of products from SICK. The services range from product-independent consulting to traditional product services.



- 
Consulting and design
 Safe and professional
- 
Product and system support
 Reliable, fast and on-site
- 
Verification and optimization
 Safe and regularly inspected
- 
Upgrade and retrofits
 Easy, safe and economical
- 
Training and education
 Practical, focused and professional

SICK AT A GLANCE

SICK is a leading manufacturer of intelligent sensors and sensor solutions for industrial applications. With more than 7,400 employees and over 50 subsidiaries and equity investments as well as numerous agencies worldwide, we are always close to our customers. A unique range of products and services creates the perfect basis for controlling processes securely and efficiently, protecting individuals from accidents and preventing damage to the environment.

We have extensive experience in various industries and understand their processes and requirements. With intelligent sensors, we can deliver exactly what our customers need. In application centers in Europe, Asia and North America, system solutions are tested and optimized in accordance with customer specifications. All this makes us a reliable supplier and development partner.

Comprehensive services round out our offering: SICK LifeTime Services provide support throughout the machine life cycle and ensure safety and productivity.

For us, that is “Sensor Intelligence.”

Worldwide presence:

Australia, Austria, Belgium, Brazil, Canada, Chile, China, Czech Republic, Denmark, Finland, France, Germany, Great Britain, Hungary, India, Israel, Italy, Japan, Malaysia, Mexico, Netherlands, New Zealand, Norway, Poland, Romania, Russia, Singapore, Slovakia, Slovenia, South Africa, South Korea, Spain, Sweden, Switzerland, Taiwan, Thailand, Turkey, United Arab Emirates, USA, Vietnam.

Detailed addresses and further locations → www.sick.com