

EZ-LIGHT® TL50BL Beacon Tower Light

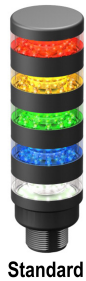

Datasheet

Compact Beacon Tower Light



Standard Audible



Sealed Audible



Omni-Directional Sealed Audible

- Rugged, cost-effective, and easy-to-install multi-segment indicators
- Illuminated segments provide easy-to-see operator guidance and indication of equipment status
- Displays up to 5 colors
- Steady on, flashing, and rotating models available
- Audible models available with standard, sealed, or omni-directional audible element
- Available in black or light gray housing
- Continuous, pulsed, and staccato tones available
- 12 V dc to 30 V dc or 24 V ac operation
- No assembly required

Models

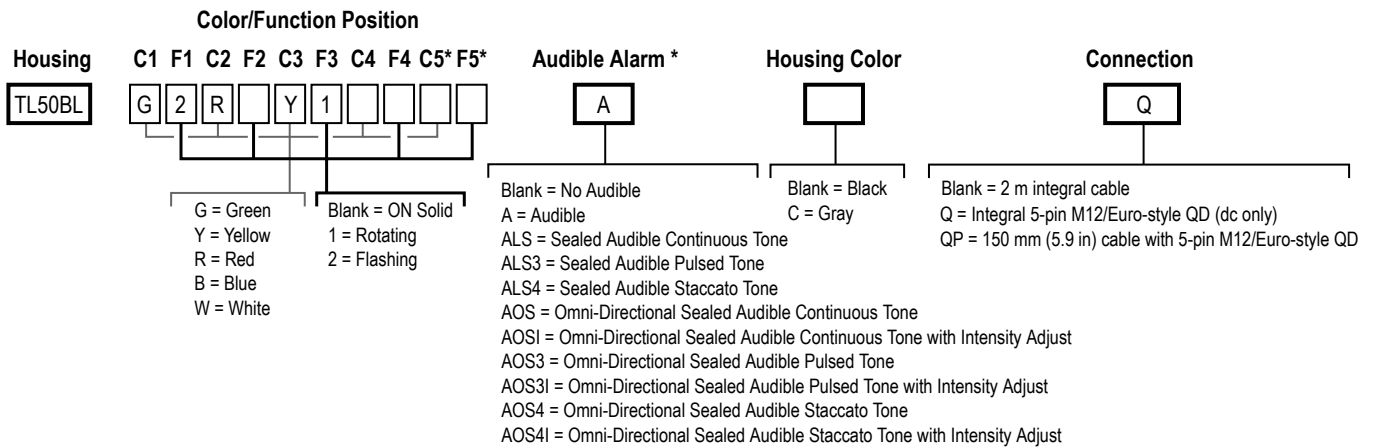

* Not available with Audible

Wiring Diagram — 4-Pin Models

Models with 1 to 3 segments

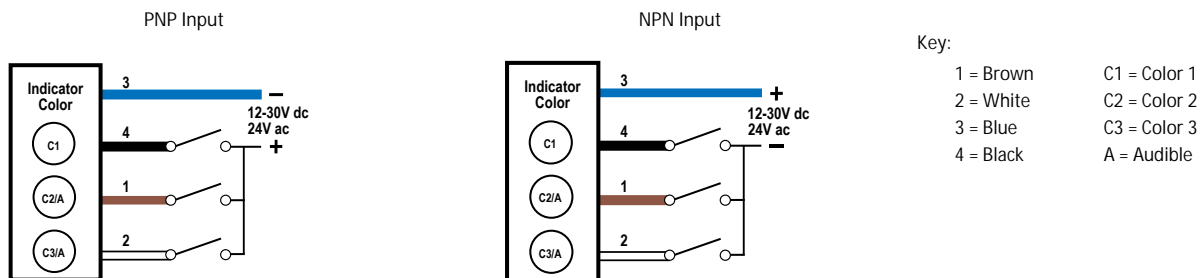

Pins 1 and 2 could activate the corresponding color or the audible function, if available.



Wiring Diagram — 5-Pin Models

Models with 4 segments

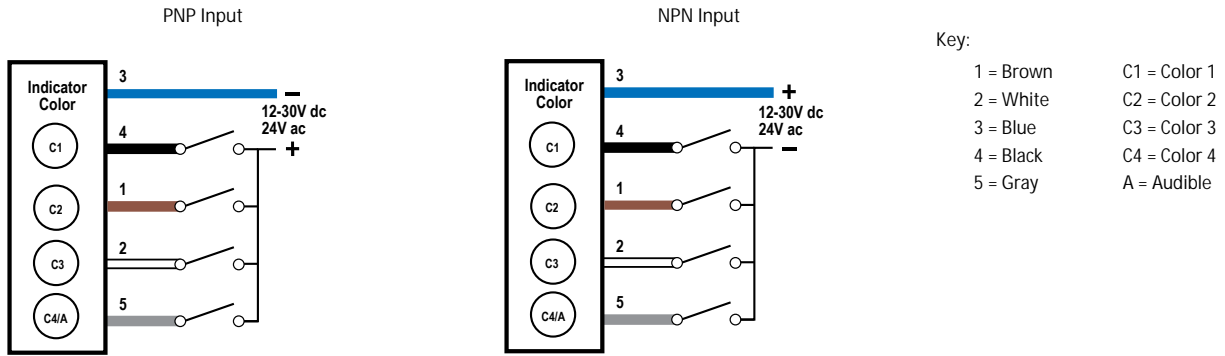

Pin 5 could activate the corresponding color or the audible function, if available.

Wiring Diagram — 8-Pin Models

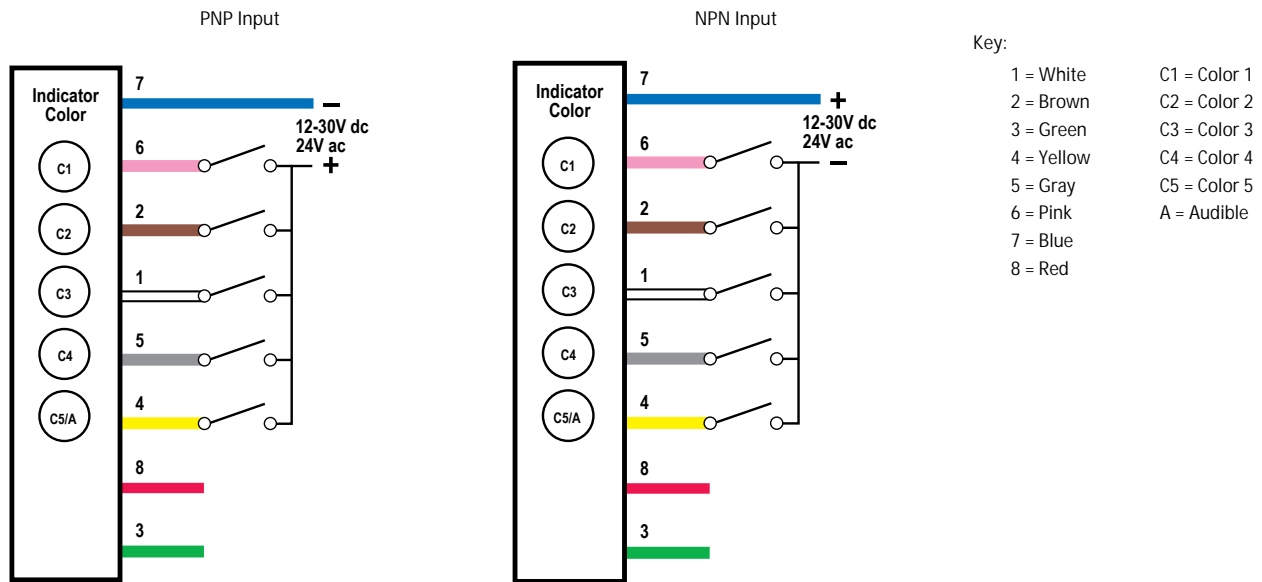

Pin 4 could activate the corresponding color or the audible function, if available. Pins 3 and 8 are not used.

Specifications

Supply Voltage and Current

12 V dc to 30 V dc; or 24 V ac (± 3 V) at 50 Hz to 60 Hz

Indicators—maximum current per LED color:

125 mA at 12 V dc

60 mA at 30 V dc

75 mA at 24 V ac

Standard Audible Alarm: 25 mA maximum current

Sealed Audible Alarm: 35 mA maximum current

Omni-Directional Sealed Audible Alarm: 45 mA maximum current

Use only with a suitable Class 2 power supply or transformer.

Supply Protection Circuitry

Protected against transient voltages

Audible Adjustment

Standard Audible Alarm: Unscrew the cover (up to 1.5 turns maximum) to adjust the audible intensity. (Do not exceed 1.5 turns or the cover may detach during operation.) For maximum intensity, rotate the center plug 180° counterclockwise to remove it.

Sealed Audible Alarm and **Omni-Directional** Sealed Audible Alarm with Intensity Adjustment: Rotate the front cover until the desired intensity is reached.

Omni-Directional Sealed Audible Alarm: No adjustment.

Audible Alarm

Standard Audible Alarm: 2.7 kHz \pm 500 Hz oscillation frequency; maximum intensity 92 dB at 1 m (3.3 ft) (typical)

Sealed Audible Alarm: 2.9 kHz \pm 250 Hz oscillation frequency; maximum intensity 94 dB at 1 m (3.3 ft) (typical)

Omni-Directional Sealed Audible Alarm: 2.1 kHz \pm 250 Hz oscillation frequency; maximum intensity 99 dB at 1 m (3.3 ft) (typical)

Omni-Directional Sealed Audible Alarm with Intensity Adjustment: 2.1 kHz \pm 250 Hz oscillation frequency; maximum intensity 95 dB at 1 m (3.3 ft) (typical)

Typical **Reduction** in Sound Intensity with Audible Adjustment (maximum to minimum)

- Standard Audible: 30 dB
- Sealed Audible: 20 dB
- **Omni-Directional** Sealed Audible: 12 dB

Construction

Bases and Covers: ABS

Light Segment: Polycarbonate

Vibration and Mechanical Shock

All models meet Mil Std. 202F requirements. Method 201A (vibration: 10 Hz to 60 Hz max., double amplitude 0.06 inch, maximum acceleration 10G). Also meets IEC 947-5-2 requirements: 30G 11 ms duration, half sine wave.

Operating Conditions

Non-Audible: -40 °C to +50 °C (-40 °F to +122 °F)

Standard and Sealed Audible: -20 °C to +50 °C (-4 °F to +122 °F)

95% at +50 °C maximum relative humidity (non-condensing)

Environmental Rating

NEMA/UL Type 13

Non-Audible and Sealed Audible: IEC IP67

Standard Audible: IEC IP50

Certifications



Indicators

LEDs are independently selected; 1 to 5 colors depending on model

Indicator Functions

A color designation followed by an LED option number, indicates the LED status. For example: TL50BLR2Q or TL50BLG1AQ.

| LED Option | LED Status | Rotation or Flash Rate |
|------------|------------|------------------------|
| Blank | Steady On | – |
| 1 | Rotating | 200 RPM \pm 15% |
| 2 | Flashing | 1.6 Hz rate \pm 15% |

Indicator Characteristics

| Color | Dominant Wavelength (nm) or Color Temperature (CCT) | Lumen Output (Typical at 25 °C) |
|--------|---|---------------------------------|
| Green | 525 nm | 52 |
| Red | 626 nm | 24 |
| Yellow | 590 nm | 15 |
| Blue | 470 nm | 16 |
| White | 5000 K | 56 |

Input Response Time

Indicator On/Off: 1 ms (maximum)

Connections

Integral 4-pin, 5-pin, or 8-pin M12/Euro-style OD, 150 mm (6 in) PVC cable with OD, or 2 m (6.5 ft) integral cable, depending on model

Required Overcurrent Protection



WARNING: Electrical connections must be made by qualified personnel in accordance with local and national electrical codes and regulations.

Overcurrent protection is required to be provided by end product application per the supplied table.

Overcurrent protection may be provided with external fusing or via Current Limiting, Class 2 Power Supply.

Supply wiring leads < 24 AWG shall not be spliced.

For additional product support, go to www.bannerengineering.com.

| Supply Wiring (AWG) | Required Overcurrent Protection (Amps) |
|---------------------|--|
| 20 | 5.0 |
| 22 | 3.0 |
| 24 | 2.0 |
| 26 | 1.0 |
| 28 | 0.8 |
| 30 | 0.5 |

Dimensions

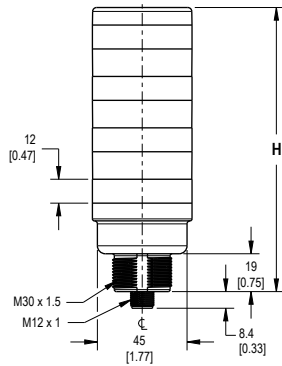

| # of Colors | Tower Height (H) | | | |
|-------------|-------------------|-------------------|-------------------|---------------------------------|
| | Non-Audible | Standard Audible* | Sealed Audible | Omni-Directional Sealed Audible |
| 1 | 46.2 mm (1.8 in) | 77.1 mm (3.1 in) | 100.2 mm (4.0 in) | 114.2 mm (4.5 in) |
| 2 | 72.0 mm (2.8 in) | 102.9 mm (4.1 in) | 126.0 mm (5.0 in) | 140.0 mm (5.5 in) |
| 3 | 97.8 mm (3.8 in) | 128.7 mm (5.1 in) | 151.8 mm (6.0 in) | 165.8 mm (6.5 in) |
| 4 | 123.6 mm (4.8 in) | 154.5 mm (6.1 in) | 177.6 mm (7.0 in) | 191.6 mm (7.5 in) |
| 5 | 149.4 mm (5.8 in) | - | - | - |

* Tower height (H) with top unscrewed approximately 3.5 mm to allow sound to escape

Accessories

Cordsets

| 4-Pin Threaded M12/Euro-Style Cordsets | | | | |
|--|----------------|----------|------------|---|
| Model | Length | Style | Dimensions | Pinout (Female) |
| MQDC-406 | 1.83 m (6 ft) | Straight | | <p>1 = Brown 2 = White 3 = Blue 4 = Black</p> |
| MQDC-415 | 4.57 m (15 ft) | | | |
| MQDC-430 | 9.14 m (30 ft) | | | |
| MQDC-450 | 15.2 m (50 ft) | | | |

| 5-Pin Threaded M12/Euro-Style Cordsets—Single Ended | | | | |
|---|-----------------|-------------|------------|--|
| Model | Length | Style | Dimensions | Pinout (Female) |
| MQDC1-501.5 | 0.50 m (1.5 ft) | Straight | | <p>1 = Brown 2 = White 3 = Blue 4 = Black 5 = Gray</p> |
| MQDC1-506 | 1.83 m (6 ft) | | | |
| MQDC1-515 | 4.57 m (15 ft) | | | |
| MQDC1-530 | 9.14 m (30 ft) | | | |
| MQDC1-506RA | 1.83 m (6 ft) | Right-Angle | | |
| MQDC1-515RA | 4.57 m (15 ft) | | | |
| MQDC1-530RA | 9.14 m (30 ft) | | | |

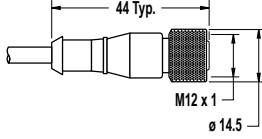
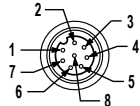
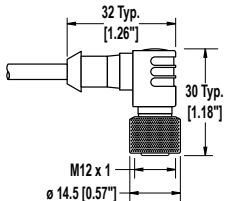
| 8-Pin Threaded M12/Euro-Style Cordsets with Open-Shield | | | | |
|---|----------------|-------------|--|--|
| Model | Length | Style | Dimensions | Pinout (Female) |
| MQDC2S-806 | 1.83 m (6 ft) | Straight |  |  <p>1 = White 2 = Brown 3 = Green 4 = Yellow 5 = Gray 6 = Pink 7 = Blue 8 = Red</p> |
| MQDC2S-815 | 4.57 m (15 ft) | | | |
| MQDC2S-830 | 9.14 m (30 ft) | | | |
| MQDC2S-850 | 15.2 m (50 ft) | | | |
| MQDC2S-806RA | 1.83 m (6 ft) | Right-Angle |  | |
| MQDC2S-815RA | 4.57 m (15 ft) | | | |
| MQDC2S-830RA | 9.14 m (30 ft) | | | |
| MQDC2S-850RA | 15.2 m (50 ft) | | | |

Mounting Brackets

SMB30A

- Right-angle bracket with curved slot for versatile orientation
- Clearance for M6 (¼ in) hardware
- Mounting hole for 30 mm sensor
- 12-ga. stainless steel

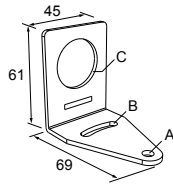

Hole center spacing: A to B=40
Hole size: A=ø 6.3, B= 27.1 x 6.3, C=ø 30.5

SMB30FA

- Swivel bracket with tilt and pan movement for precise adjustment
- Mounting hole for 30 mm sensor
- 12-ga. 304 stainless steel
- Easy sensor mounting to extrude rail T-slot
- Metric and inch size bolt available

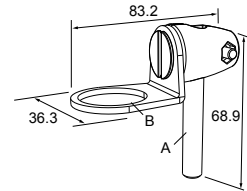

Bolt thread: SMB30FA, A= 3/8 - 16 x 2 in; SMB30FAM10, A= M10 - 1.5 x 50
Hole size: B= ø 30.1

SMB30MM

- 12-ga. stainless steel bracket with curved mounting slots for versatile orientation
- Clearance for M6 (¼ in) hardware
- Mounting hole for 30 mm sensor

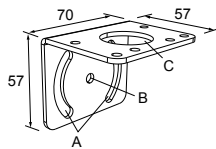

Hole center spacing: A = 51, A to B = 25.4
Hole size: A = 42.6 x 7, B = ø 6.4, C = ø 30.1

SMBAMS30P

- Flat SMBAMS series bracket
- 30 mm hole for mounting sensors
- Articulation slots for 90°+ rotation
- 12-ga. 300 series stainless steel

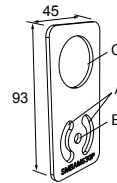

Hole center spacing: A=26.0, A to B=13.0
Hole size: A=26.8 x 7.0, B=ø 6.5, C=ø 31.0

SMBAMS30RA

- Right-angle SMBAMS series bracket
- 30 mm hole for mounting sensors
- Articulation slots for 90°+ rotation
- 12-ga. (2.6 mm) cold-rolled steel

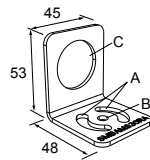

Hole center spacing: A=26.0, A to B=13.0
Hole size: A=26.8 x 7.0, B=ø 6.5, C=ø 31.0

SMB30SC

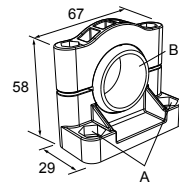

- Swivel bracket with 30 mm mounting hole for sensor
- Black reinforced thermoplastic polyester
- Stainless steel mounting and swivel locking hardware included





Hole center spacing: A=ø 50.8
Hole size: A=ø 7.0, B=ø 30.0

All measurements are listed in millimeters [inches], unless noted otherwise.

LMB Sealed Right-Angle Bracket

| Model | Description | Construction | |
|-----------|---|---------------------|---|
| LMB30RA | Direct-Mount Models: Bracket kit with base, 30 mm adapter, set screw, fasteners, o-rings, and gaskets | Black polycarbonate |  |
| LMB30RAC | | Gray polycarbonate | |
| LMBE12RA | Pipe-Mount Models: Bracket kit with base, 1/2-14 pipe adapter, set screw, fasteners, o-rings, and gaskets. For use with stand-off pipe (listed and sold separately) | Black polycarbonate |  |
| LMBE12RAC | | Gray polycarbonate | |

Elevated Mount System

| Model | Features | | | Components |
|--------------------------------------|--|--------------------------------------|---|---|
| SA-M30TE12 - Black Acetal | <ul style="list-style-type: none"> Streamlined black acetal or white UHMW stand-off pipe adapter/cover Connects between 30 mm light base and 1/2 in. NPSM/DN15 pipe Mounting hardware included | | |  |
| SA-M30TE12C - White UHMW | | | | |
| Polished 304 Stainless Steel | Black Anodized Aluminum | Clear Anodized Aluminum | <ul style="list-style-type: none"> Elevated-use stand-off pipe (1/2 in. NPSM/DN15) Polished 304 stainless steel, black anodized aluminum, or clear anodized aluminum surface 1/2 in. NPT thread at both ends Compatible with most industrial environments |  |
| SOP-E12-150SS 150 mm (6 in) long | SOP-E12-150A 150 mm (6 in) long | SOP-E12-150AC 150 mm (6 in) long | | |
| SOP-E12-300SS 300 mm (12 in) long | SOP-E12-300A 300 mm (12 in) long | SOP-E12-300AC 300 mm (12 in) long | | |
| SOP-E12-900SS 900 mm (36 in) long | SOP-E12-900A 900 mm (36 in) long | SOP-E12-900AC 900 mm (36 in) long | | |
| SA-E12M30 - Black Acetal | <ul style="list-style-type: none"> Streamlined black acetal or white UHMW mounting base adapter/cover Connects between 1/2 in. NPSM/DN15 pipe and 30 mm (1-3/16 in) drilled hole Mounting hardware included | | |  |
| SA-E12M30C - White UHMW | | | | |

Pipe Mounting Flange

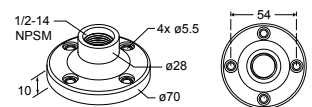
| Pipe Mounting Flange | | | |
|----------------------|--|-------------------------------------|---|
| Model | Features | Construction | |
| SA-F12 | <ul style="list-style-type: none"> For use elevated stand-off pipes (1/2 in, NPSM/DN15) M5 mounting hardware and nitrile gasket included | Die-cast zinc base with black paint |  |

Banner Engineering Corp. Limited Warranty

Banner Engineering Corp. warrants its products to be free from defects in material and workmanship for one year following the date of shipment. Banner Engineering Corp. will repair or replace, free of charge, any product of its manufacture which, at the time it is returned to the factory, is found to have been defective during the warranty period. This warranty does not cover damage or liability for misuse, abuse, or the improper application or installation of the Banner product.

THIS LIMITED WARRANTY IS EXCLUSIVE AND IN LIEU OF ALL OTHER WARRANTIES WHETHER EXPRESS OR IMPLIED (INCLUDING, WITHOUT LIMITATION, ANY WARRANTY OF MERCHANTABILITY OR FITNESS FOR A PARTICULAR PURPOSE), AND WHETHER ARISING UNDER COURSE OF PERFORMANCE, COURSE OF DEALING OR TRADE USAGE.

This Warranty is exclusive and limited to repair or, at the discretion of Banner Engineering Corp., replacement. IN NO EVENT SHALL BANNER ENGINEERING CORP. BE LIABLE TO BUYER OR ANY OTHER PERSON OR ENTITY FOR ANY EXTRA COSTS, EXPENSES, LOSSES, LOSS OF PROFITS, OR ANY INCIDENTAL, CONSEQUENTIAL OR SPECIAL DAMAGES RESULTING FROM ANY PRODUCT DEFECT OR FROM THE USE OR INABILITY TO USE THE PRODUCT, WHETHER ARISING IN CONTRACT OR WARRANTY, STATUTE, TORT, STRICT LIABILITY, NEGLIGENCE, OR OTHERWISE.

Banner Engineering Corp. reserves the right to change, modify or improve the design of the product without assuming any obligations or liabilities relating to any product previously manufactured by Banner Engineering Corp. Any misuse, abuse, or improper application or installation of this product or use of the product for personal protection applications when the product is identified as not intended for such purposes will void the product warranty. Any modifications to this product without prior express approval by Banner Engineering Corp will void the product warranties. All specifications published in this document are subject to change; Banner reserves the right to modify product specifications or update documentation at any time. Specifications and product information in English supersede that which is provided in any other language. For the most recent version of any documentation, refer to:

www.bannerengineering.com.