

**WT3000**  
**Precision Power Analyzer**  
**USER'S MANUAL**

---

# Product Registration

Thank you for purchasing YOKOGAWA products.

YOKOGAWA provides registered users with a variety of information and services.

Please allow us to serve you best by completing the product registration form accessible from our homepage.

<http://www.yokogawa.com/tm/>



---

Thank you for purchasing the WT3000 Precision Power Analyzer. The WT3000 is an instrument capable of measuring parameters such as voltage, current, and power with high precision.

This user's manual contains useful information about the instrument's functions and operating procedures and lists the handling precautions of the WT3000. To ensure correct use, please read this manual thoroughly before beginning operation. After reading the manual, keep it in a convenient location for quick reference whenever a question arises during operation.

Three manuals, including this one, are provided as manuals for the WT3000. Please read all of them.

Manual Title	Manual No.	Description
WT3000 Precision Power Analyzer User's Manual (Vol 1/3)	IM 760301-01E	This manual. Explains all functions and procedures of the WT3000 excluding the expansion functions and communication functions.
WT3000 Precision Power Analyzer Communication Interface User's Manual (CD-ROM) (Vol 2/3)	IM 760301-17E	Explains the functions for controlling the WT3000 using communication commands.
WT3000 Precision Power Analyzer Expansion Function User's Manual (Vol 3/3)	IM 760301-51E	Explains the expansion functions (motor evaluation function and options) of the WT3000 and their operating procedures.

## Note

- The contents of this manual are subject to change without prior notice as a result of continuing improvements to the instrument's performance and functions. The figures given in this manual may differ from those that actually appear on your screen.
- Every effort has been made in the preparation of this manual to ensure the accuracy of its contents. However, should you have any questions or find any errors, please contact your nearest YOKOGAWA dealer.
- Copying or reproducing all or any part of the contents of this manual without the permission of Yokogawa Electric Corporation is strictly prohibited.
- The TCP/IP software of this product and the document concerning the TCP/IP software have been developed/created by YOKOGAWA based on the BSD Networking Software, Release 1 that has been licensed from the University of California.

## Trademarks

- Microsoft, Internet Explorer, MS-DOS, Windows, Windows NT, and Windows XP are either registered trademarks or trademarks of Microsoft Corporation in the United States and/or other countries.
- Adobe, Acrobat, and PostScript are trademarks of Adobe Systems Incorporated.
- For purposes of this manual, the ® and TM symbols do not accompany their respective registered trademark names or trademark names.
- Other company and product names are registered trademarks or trademarks of their respective holders.

## Revisions

- |               |                |               |               |
|---------------|----------------|---------------|---------------|
| • 1st Edition | December 2004  | • 2nd Edition | June 2005     |
| • 3rd Edition | January 2006   | • 4th Edition | December 2006 |
| • 5th Edition | March 2007     | • 6th Edition | May 2009      |
| • 7th Edition | September 2013 | • 8th Edition | February 2014 |

# Checking the Contents of the Package

Unpack the box and check the contents before operating the instrument. If some of the contents are not correct or missing or if there is physical damage, contact the dealer from which you purchased them.

## WT3000

Check that the model name and suffix code given on the name plate on the side panel match those on your order.

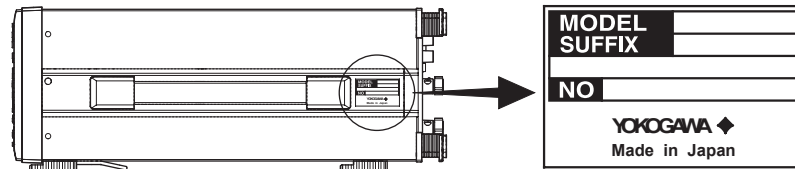

### • MODEL and SUFFIX Codes

Model/Item	Suffix Code	Description
760301		Number of installed input elements: 1
760302		Number of installed input elements: 2
760303		Number of installed input elements: 3
760304		Number of installed input elements: 4
		The power supply specifications are 100 to 240 VAC on all of the above models.
Element configuration	-01	30-A input element (selectable only for the 760301)
	-10	2-A input element (selectable only for the 760301)
	-02	30-A input element (selectable only for the 760302)
	-20	2-A input element (selectable only for the 760302)
	-03	30-A input element (selectable only for the 760303)
	-30	2-A input element (selectable only for the 760303)
	-04	30-A input element (selectable only for the 760304)
	-40	2-A input element (selectable only for the 760304)
Version	-SV	Standard version
	-MV	Motor version
Power cord <sup>*1</sup>	-D	UL, CSA standard power cord
	-F	VDE standard power cord
	-Q	BS standard power cord
	-R	AS standard power cord
	-H	GB standard power cord
	-N	NBR Standard power cord
Options	/G5 <sup>*2</sup>	Harmonic measurement (With the release of the /G6 option, the /G5 option has been discontinued in July 2006.)
	/G6 <sup>*2</sup>	Advanced computation (Harmonic measurement in normal measurement mode, wide bandwidth harmonic measurement, IEC harmonic measurement, waveform computation, FFT, and saving of waveform sampling data)
	/B5	Built-in printer
	/DT	Delta computation
	/FQ	Frequency measurement add-on (simultaneous measurement on all input elements possible)
	/DA	20-channel D/A output
	/V1	VGA output
	/C2 <sup>*3</sup>	RS-232 communications
	/C12 <sup>*3</sup>	USB port (PC)
	/C5	USB port (peripheral device)
	/C7	Ethernet communications
	/FL	Voltage fluctuation and flicker measurement
	/CC	Cycle-by-cycle measurement

\*1 Make sure that the attached power cord meets the designated standards of the country and area that you are using it in.

\*2 The relationship between the firmware version of the WT3000 and /G5 or G6 is as follows:

/G5: Firmware version 1.01 or later

/G6: Firmware version 3.01 or later

The description in this manual assumes the /G6 option. The /G5 option corresponds to the “harmonic measurement in normal measurement mode” in the explanation of the /G6 option.

\*3 Select either one.

**Suffix Code Example**

30-A input elements installed to input elements 1 and 2, motor version, UL, CSA standard power cord, built-in printer option, and 20-channel D/A output option: 760302-02-MV-D/B5/DA

• **No. (Instrument Number)**

When contacting the dealer from which you purchased the instrument, please give them the instrument number.

**Waste Electrical and Electronic Equipment (WEEE), Directive 2002/96/EC**

This product complies with the WEEE Directive (2002/96/EC) marking requirement.

The affixed product label (see below) indicates that you must not discard this electrical/electronic product in domestic household waste.

Product Category

With reference to the equipment types in the WEEE directive Annex 1, this product is classified as a “Monitoring and Control instrumentation” product.

Do not dispose in domestic household waste.

To return unwanted products, contact your local Yokogawa Europe B. V. office.



**New EU Battery Directive**

New EU Battery Directive, DIRECTIVE 2006/66/EC

(This directive is valid only in the EU.)

Batteries are included in this product. This marking indicates they shall be sorted out and collected as ordained in ANNEX II in DIRECTIVE 2006/66/EC.

Battery type

Lithium battery

You cannot replace batteries by yourself. When you need to replace batteries, contact your local Yokogawa Europe B.V.office.



## Checking the Contents of the Package

### Standard Accessories

The standard accessories below are supplied with the instrument.

Item	Model/Part No.	Quantity	Note
Power cord*1	One of the following power cords is included according to the suffix code on the previous page.		
	A1006WD	1	UL, CSA standard power cord Maximum rated voltage: 125 V
	A1009WD	1	VDE standard power cord Maximum rated voltage: 250 V
	A1054WD	1	BS standard power cord Maximum rated voltage: 250 V
	A1024WD	1	AS standard power cord Maximum rated voltage: 250 V
	A1064WD	1	GB standard power cord Maximum rated voltage: 250 V
	A1088WD	1	NBR standard power cord Maximum rated voltage: 250 V
Power fuse	A1463EF	1	250 V, 6.3 A, time lag Attached to the fuse holder
Rubber feet	A9088ZM	2	Two pieces in one set. Two sets provided.
Current input protective cover	B9318FX	1	With four attachment screws
Safety terminal adapter set	758931	See right	Same number as the number of installed input elements. 760301: 1 set with 1 hexagonal socket wrench 760302: 2 sets with 1 hexagonal socket wrench 760303: 3 sets with 1 hexagonal socket wrench 760304: 4 sets with 1 hexagonal socket wrench
Printer roll paper	B9316FX	2	For the built-in printer Provided only with option /B5
36-pin connector	A1005JD	1	For D/A output Provided only with option /DA
User's Manual (Vol 1/3)	IM760301-01E	1	This manual
Communication Interface User's Manual (Vol 2/3)	IM760301-17E	1	CD-ROM (CD-ROM part number: B9318ZZ)
Printed manuals can be purchased separately. Contact your nearest YOKOGAWA dealer.			
Expansion Function User's Manual (Vol 3/3)	IM760301-51E	1	Provided on models with suffix code -MV, /G5, /G6, /B5, /DT, /DA, /V1, /C7, /FL, or /CC.

Power cord (One of the following power cords is included according to the suffix code)

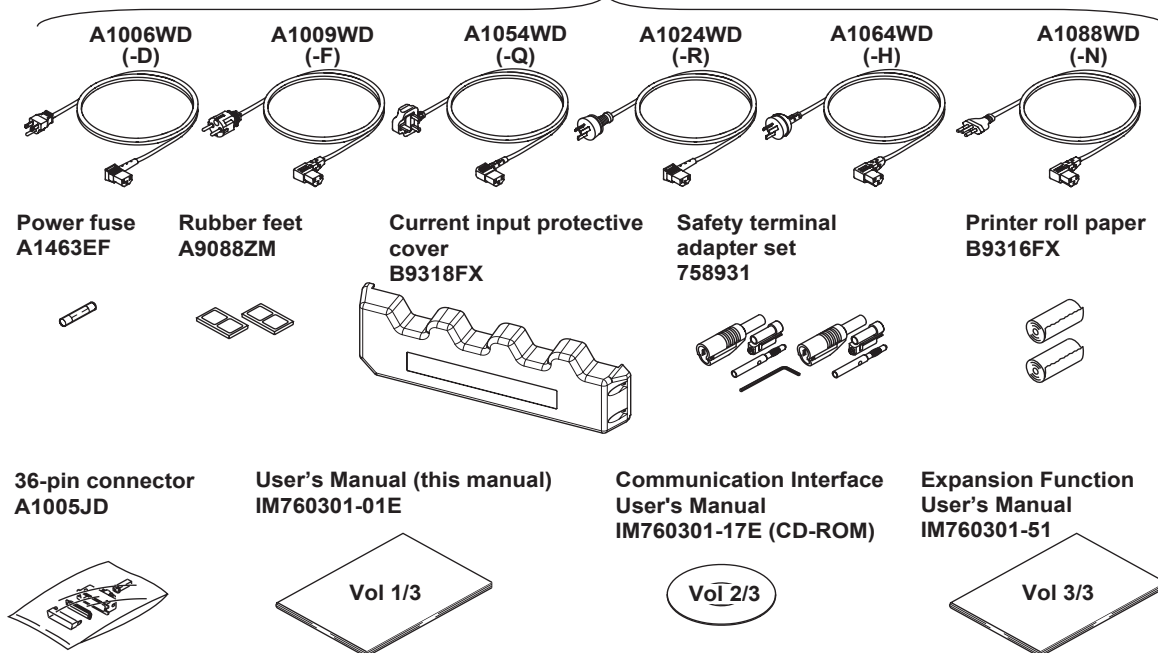

\*1 Make sure that the attached power cord meets the designated standards of the country and area that you are using it in.

### Optional Accessories (Sold Separately)

The optional accessories below are available for purchase separately.

Item	Model/ Part No.	Quantity	Note
Measurement lead	758917	1	Two leads in one set, used with the separately sold 758922 or 758929 adapter, length 0.75 m, ratings 1000 V
Safety terminal adapter set	758923	1	2 pieces in one set. Rated voltage 600 V.
	758931	1	2 pieces in one set. Rated voltage 1000 V.
Alligator clip adapter set	758922	1	Two pieces in one set, for the 758917 measurement lead. Rated voltage 300 V
	758929	1	Two pieces in one set, for the 758917 measurement lead. Rated voltage 1000 V
Fork terminal measurement lead adapter set	758921	1	Two pieces in one set, for the 758917 Rated voltage 1000 V, rated current 25 A
BNC-BNC measurement lead	366924	1	42 V or less, length 1 m
	366925	1	42 V or less, length 2 m
External sensor cable	B9284LK	1	For connecting the current sensor input connector of the WT3000, length 0.5 m
Conversion adapter	758924	1	BNC-4 mm socket adapter, rated voltage 500 V
Serial port adapter	366971	1	9 pin <sup>*1</sup> -25 pin <sup>*2</sup> adapter *1 EIA-574 Standard *2 EIA-232 Standard (RS-232)

Measurement lead  
758917

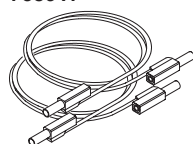

Safety terminal  
adapter set  
758923



Safety terminal  
adapter set  
758931



Alligator clip adapter set  
758922

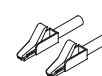

Alligator clip adapter set  
758929

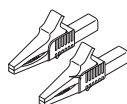

Fork terminal  
adapter set  
758921



BNC cable  
366924 (1 m)  
366925 (2 m)



External sensor cable  
B9284LK



Conversion  
adapter  
758924



Serial port  
adapter  
366971



### Spare Parts (Sold Separately)

The spare parts below are available for purchase separately.

Item	Model/ Part No.	Quantity	Note
Printer roll paper	B9316FX	10	One roll is one set, thermal-sensitive paper, total length 10 m
Power fuse	A1463EF	2	250 V, 6.3 A, time lag











---

# Safety Precautions

This instrument is an IEC safety class 01 instrument (provided with a terminal for protective earth grounding).

The general safety precautions described herein must be observed during all phases of operation. If the instrument is used in a manner not specified in this manual, the protection provided by the instrument may be impaired. Yokogawa Electric Corporation assumes no liability for the customer's failure to comply with these requirements.

## The following symbols are used on this instrument.

-  "Handle with care." (To avoid injury, death of personnel or damage to the instrument, the operator must refer to the explanation in the User's Manual or Service Manual.)
-  Electric shock, danger
-  Alternating current
-  Both direct and alternating current
-  ON (power)
-  OFF (power)
-  ON (power) state
-  OFF (power) state
-  Grounding

**Failure to comply with the precautions below could lead to injury or death or damage to the instrument.**

---

## WARNING

- **Use the Instrument Only for Its Intended Purpose**  
The WT3000 is a power measurement instrument that can measure parameters such as voltage, current, and power. Do not use this instrument for anything other than as a power measurement instrument.
- **Check the Physical Appearance**  
Do not use the instrument if there is a problem with its physical appearance.
- **Use the Correct Power Supply**  
Before connecting the power cord, ensure that the source voltage matches the rated supply voltage of the instrument and that it is within the maximum rated voltage of the provided power cord.
- **Use the Correct Power Cord and Plug**  
To prevent the possibility of electric shock or fire, be sure to use the power cord supplied by YOKOGAWA. The main power plug must be plugged into an outlet with a protective earth terminal. Do not disable this protection by using an extension cord without protective earth grounding.

- **Connect the Protective Ground Terminal**

Be sure to connect the protective earth to prevent electric shock before turning ON the power. The power cord that comes with the instrument is a three-prong type power cord. Connect the power cord to a properly grounded three-prong outlet.
  - **Do Not Impair the Protective Grounding**

Never cut off the internal or external protective earth wire or disconnect the wiring of the protective earth terminal. Doing so poses a potential shock hazard.
  - **Do Not Operate with Defective Protective Grounding or Fuse**

Do not operate the instrument if the protective earth or fuse might be defective. Also, make sure to check them before operation.
  - **Do Not Operate in an Explosive Atmosphere**

Do not operate the instrument in the presence of flammable liquids or vapors. Operation in such an environment constitutes a safety hazard.
  - **Do Not Remove the Covers or Disassemble or Alter the Instrument**

Only qualified YOKOGAWA personnel may remove the covers and disassemble or alter the instrument. The inside of the instrument is dangerous because parts of it have high voltages.
  - **Ground the Instrument before Making External Connections**

Securely connect the protective grounding before connecting to the item under measurement or to an external control unit. If you are going to touch the circuit, make sure to turn OFF the circuit and check that no voltage is present.
  - **Measurement Category**

This instrument is a measurement category II product. Do not use it for measurement category III or IV measurements.
  - **Installation Location**
    - This instrument is designed to be used indoors. Do not install or use it outdoors.
    - Install the instrument so that you can immediately remove the power cord if an abnormal or dangerous condition occurs.
- 
- 

## CAUTION

### **Operating Environment Limitations**

This product is a Class A (for industrial environments) product. Operation of this product in a residential area may cause radio interference in which case the user will be required to correct the interference.

---

---

# Conventions Used in This Manual

## Safety Markings

The following markings are used in this manual.



*Improper handling or use can lead to injury to the user or damage to the instrument.* This symbol appears on the instrument to indicate that the user must refer to the user's manual for special instructions. The same symbol appears in the corresponding place in the user's manual to identify those instructions. In the manual, the symbol is used in conjunction with the word "WARNING" or "CAUTION."

---

**WARNING**

Calls attention to actions or conditions that could cause serious or fatal injury to the user, and precautions that can be taken to prevent such occurrences.

---

**CAUTION**

Calls attentions to actions or conditions that could cause light injury to the user or damage to the instrument or user's data, and precautions that can be taken to prevent such occurrences.

**Note**

Calls attention to information that is important for proper operation of the instrument.

## Subheadings

On pages that describe the operating procedures in chapters 3 through 11, the following symbols, displayed characters, and terminology are used to distinguish the procedures from their explanations.

---

**Procedure**

Follow the numbered steps. All procedures are written with inexperienced users in mind; experienced users may not need to carry out all the steps.

---

**Explanation**

This subsection describes the setting parameters and the limitations on the procedures. It may not give a detailed explanation of the function. For a detailed explanation of the function, see chapter 2.

---

**Displayed Characters and Terminology Used in the Procedural Explanations**

---

**Panel Keys and Soft keys**

Bold characters used in the procedural explanations indicate characters that are marked on the panel keys or the characters of the soft keys or menus displayed on the screen.

---

**SHIFT+Panel Key**

*SHIFT+key* means you will press the SHIFT key to turn ON the SHIFT key followed by the operation key. The setup menu marked in purple below the panel key that you pressed appears on the screen.

---

## Unit

---

k Denotes 1000. Example: 12 kg, 100 kHz

---

K Denotes 1024. Example: 459 KB (file data size)

---

# Flow of Operation

The figure below is provided to familiarize the first-time user with the general flow of the WT3000 operation. For a description of each item, see the relevant section or chapter. In addition to the sections and chapters that are referenced in the figure below, this manual also contains safety precautions for handling the instrument and performing wiring work. Keep them in mind and make sure to observe them.

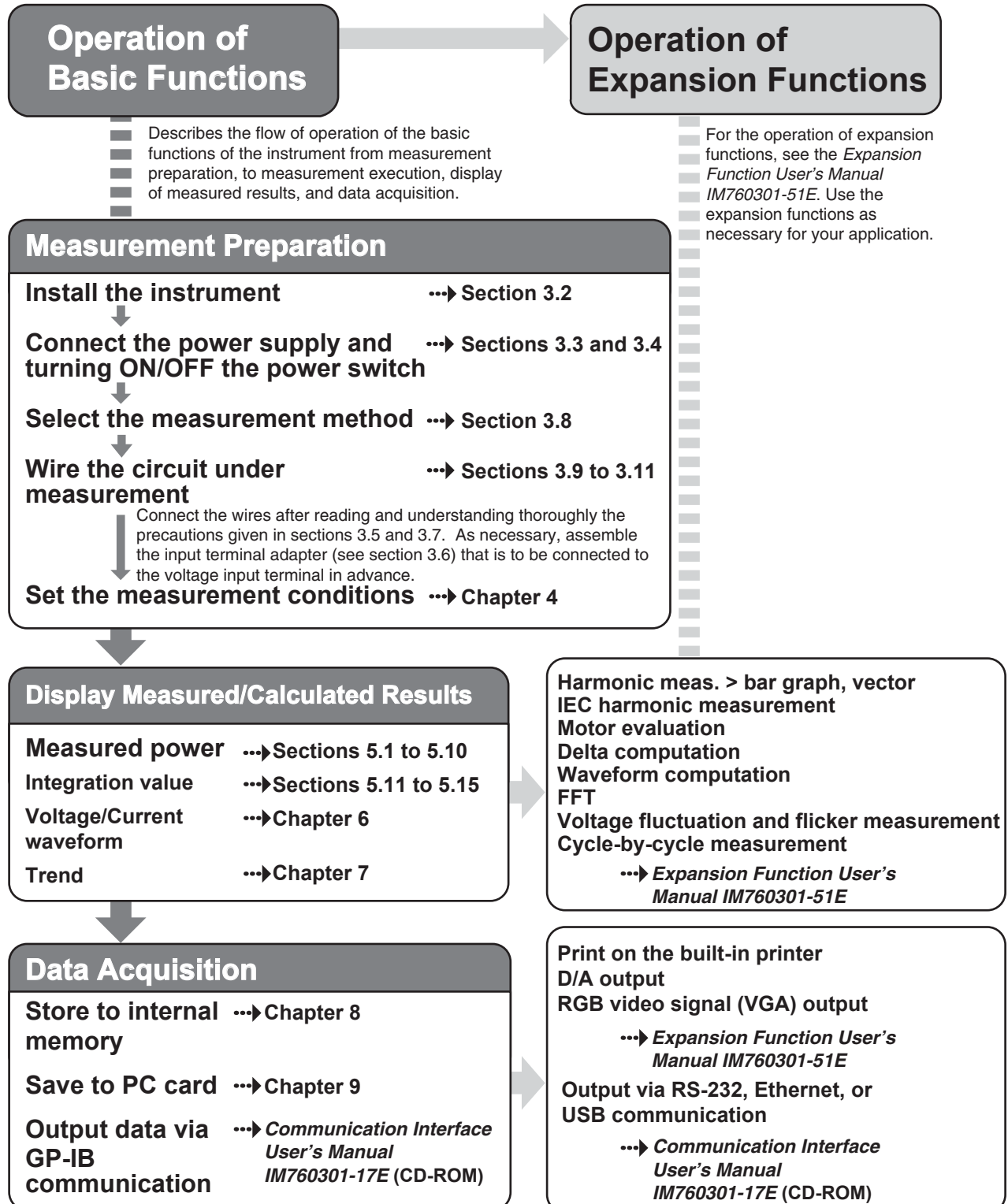

---

# Contents

Checking the Contents of the Package .....	ii
Safety Precautions .....	vi
Conventions Used in This Manual .....	viii
Flow of Operation .....	ix

## Chapter 1 Names and Functions of Parts

1.1 Front Panel, Rear Panel, and Top Panel .....	1-1
1.2 Setup Menu Display Key and Execution Key .....	1-3
1.3 Display Screen .....	1-10

## Chapter 2 Functional Description

2.1 System Configuration and Block Diagram .....	2-1
2.2 Measurement Modes and Measurement Functions .....	2-3
2.3 Measurement Conditions .....	2-9
2.4 Power Measurement .....	2-15
2.5 Computation .....	2-17
2.6 Integration .....	2-21
2.7 Waveform Display .....	2-24
2.8 Trend, Bar Graph, and Vector Displays .....	2-31
2.9 Waveform Computation and FFT .....	2-33
2.10 Voltage Fluctuation and Flicker and Cycle-by-Cycle Measurements .....	2-34
2.11 Saving and Loading Data and Other Functions .....	2-35

## Chapter 3 Before Starting Measurements

3.1 Handling Precautions .....	3-1
3.2 Installing the Instrument .....	3-2
△ 3.3 Connecting the Power Supply .....	3-4
3.4 Turning ON/OFF the Power Switch .....	3-5
△ 3.5 Wiring Precautions .....	3-7
3.6 Assembling the Adapter to Be Connected to the Voltage Input Terminal .....	3-10
3.7 Wiring for Making Accurate Measurements .....	3-12
3.8 Guide for Selecting the Method Used to Measure the Power .....	3-13
3.9 Wiring the Circuit under Measurement for Direct Input .....	3-14
3.10 Wiring the Circuit under Measurement When Using the Current Sensor .....	3-17
3.11 Wiring the Circuit under Measurement When Using the VT/CT .....	3-21
3.12 Setting the Date/Time .....	3-24
3.13 Initializing the Settings .....	3-26
3.14 Entering Values and Character Strings .....	3-28
3.15 Entering Character Strings on the USB Keyboard .....	3-32
3.16 Switching the Measurement Mode and Display .....	3-34
3.17 Displaying the Setup Parameter List .....	3-39
3.18 Selecting the Message Language .....	3-41
3.19 Setting the USB Keyboard Language .....	3-43

**Chapter 4 Measurement Conditions**

4.1	Selecting the Wiring System .....	4-1
4.2	Selecting Independent Setting of Input Elements .....	4-4
4.3	Setting the Measurement Range for Direct Input .....	4-6
4.4	Setting the Measurement Range When Using the External Current Sensor .....	4-12
4.5	Setting the Scaling Function When Using VT/CT .....	4-15
4.6	Selecting the Crest Factor .....	4-18
△ 4.7	Setting the Measurement Period .....	4-19
4.8	Selecting the Input Filter .....	4-22
4.9	Selecting the Averaging Function .....	4-24
4.10	Selecting the Data Update Rate .....	4-27
4.11	Hold and Single Measurement .....	4-29

**Chapter 5 Power Measurement**

5.1	Displaying Numeric Data and Changing the Displayed Items .....	5-1
5.2	Selecting the Voltage/Current Mode (RMS, MEAN, DC, or RMEAN) .....	5-9
5.3	Selecting the Frequency Measurement Source .....	5-10
5.4	Setting the User-Defined Function .....	5-12
5.5	Setting MAX hold .....	5-17
5.6	Measuring the Average Active Power .....	5-19
5.7	Setting the Equation for Efficiency .....	5-20
5.8	Setting the Wiring, Efficiency, and Two-Wattmeter Method Compensations .....	5-22
5.9	Setting the Equations for Apparent Power, Reactive Power, and Corrected Power .....	5-25
5.10	Selecting the Display Format of the Phase Difference .....	5-28
5.11	Integration .....	5-30
5.12	Setting the Manual Integration .....	5-35
5.13	Setting the Normal Integration and Repetitive Integration .....	5-38
5.14	Setting the Real-Time Integration and Real-Time Repetitive Integration .....	5-41
5.15	Turning ON/OFF the Integration Auto Calibration .....	5-45

**Chapter 6 Waveform Display**

6.1	Waveform Display .....	6-1
6.2	Selecting the Waveform to Be Displayed .....	6-3
6.3	Setting the Time Axis .....	6-5
△ 6.4	Setting the Trigger .....	6-7
6.5	Zooming Vertically and Moving the Vertical Position .....	6-12
6.6	Waveform Display on Divided Windows .....	6-15
6.7	Selecting the Display Interpolation and Graticule .....	6-18
6.8	Turning ON/OFF the Scale Value and Waveform Label .....	6-21
6.9	Cursor Measurement .....	6-23

**Chapter 7 Trend Display**

7.1	Trend Display .....	7-1
7.2	Selecting the Trend Data to Be Displayed .....	7-3
7.3	Selecting the Trend Display Target .....	7-5
7.4	Setting the Time Axis .....	7-8
7.5	Setting the Scale .....	7-10
7.6	Displaying Trends on Divided Windows .....	7-12
7.7	Selecting the Display Interpolation and Graticule and Turning ON/OFF the Scale Value and Waveform Label .....	7-14
7.8	Restarting the Trend .....	7-16
7.9	Cursor Measurement .....	7-17

**Chapter 8 Storing and Recalling Data and Saving the Stored Data**

8.1 Setting the Store Mode ..... 8-1  
8.2 Setting the Numeric Data and Waveform Display Data to Be Stored ..... 8-3  
8.3 Setting the Store Count, Store Interval, Store Reservation Time, and Alert Indication  
of Internal Memory Initialization ..... 8-7  
8.4 Storing Data ..... 8-11  
8.5 Saving the Stored Data ..... 8-14  
8.6 Recalling the Stored Data ..... 8-21

**Chapter 9 Saving and Loading Data**

9.1 PC Card and USB Memory ..... 9-1  
9.2 Formatting the Storage Media ..... 9-3  
9.3 Saving Setup Parameters, Waveform Display Data, Numeric Data,  
Waveform Sampling Data ..... 9-6  
9.4 Saving the Screen Image Data ..... 9-20  
9.5 Loading Setup Parameters ..... 9-24  
9.6 Specifying the File to Be Displayed, Displaying File Properties, and Selecting File  
Attributes ..... 9-27  
9.7 Deleting Files ..... 9-30  
9.8 Copying Files ..... 9-33  
9.9 Renaming Files or Directories and Creating Directories ..... 9-37

**Chapter 10 Other Functions**

10.1 Zero-Level Compensation ..... 10-1  
10.2 NULL Function ..... 10-2  
10.3 Selecting the Sampling Frequency ..... 10-4  
10.4 Selecting the Display Font ..... 10-5  
10.5 Selecting the Screen Brightness ..... 10-7  
10.6 Setting the Display Color ..... 10-8  
10.7 Setting the Key Lock and Shift Lock Function ..... 10-11  
10.8 Help Function ..... 10-13  
△ 10.9 Master/Slave Synchronization Measurement ..... 10-14

**Chapter 11 Troubleshooting, Maintenance, and Inspection**

11.1 Troubleshooting ..... 11-1  
11.2 Error Messages and Corrective Actions ..... 11-2  
11.3 Self-Test ..... 11-7  
△ 11.4 Checking the System Condition ..... 11-9  
11.5 Replacing the Power Fuse ..... 11-10  
11.6 Recommended Replacement Parts ..... 11-11

**Chapter 12 Specifications**

12.1	Input Section .....	12-1
12.2	Display .....	12-2
12.3	Measurement Functions (Measurement Items) Related to Normal Measurement .....	12-3
12.4	Accuracy .....	12-5
12.5	Functions .....	12-9
12.6	Input/Output of the Master/Slave Synchronization Signal .....	12-13
12.7	External Clock Input .....	12-13
12.8	Storage .....	12-14
12.9	USB PERIPHERAL Interface .....	12-14
12.10	GP-IB Interface .....	12-15
12.11	Safety Terminal Adapter .....	12-15
12.12	General Specifications .....	12-16
12.13	External Dimensions .....	12-18

**Appendix**

Appendix 1	Symbols and Determination of Measurement Functions .....	App-1
Appendix 2	List of Initial Settings and Display Order of Numeric Data .....	App-4
Appendix 3	ASCII Header File Format .....	App-13
Appendix 4	Power Basics (Power, Harmonics, and RLC of AC Circuits) .....	App-16
Appendix 5	For Making Accurate Measurements .....	App-24
Appendix 6	Setting the Measurement Period .....	App-26
Appendix 7	Data Update Rate and Computing Equation .....	App-33
Appendix 8	Compensation Function .....	App-34
Appendix 9	Key Assignments of the USB Keyboard .....	App-36
Appendix 10	Measurement Modes and Functional Limitations .....	App-40
Appendix 11	Measurement Functions That Can Be Measured in Each Measurement Mode .....	App-41
Appendix 12	Operands of User-Defined Functions That Can Be Used in Each Measurement Mode .....	App-43
Appendix 13	Parameters in the Operands of User-Defined Functions .....	App-45

**Index**

<b>1</b>
<b>2</b>
<b>3</b>
<b>4</b>
<b>5</b>
<b>6</b>
<b>7</b>
<b>8</b>
<b>9</b>
<b>10</b>
<b>11</b>
<b>12</b>
<b>App</b>
<b>Index</b>



# 1.1 Front Panel, Rear Panel, and Top Panel

## Front Panel

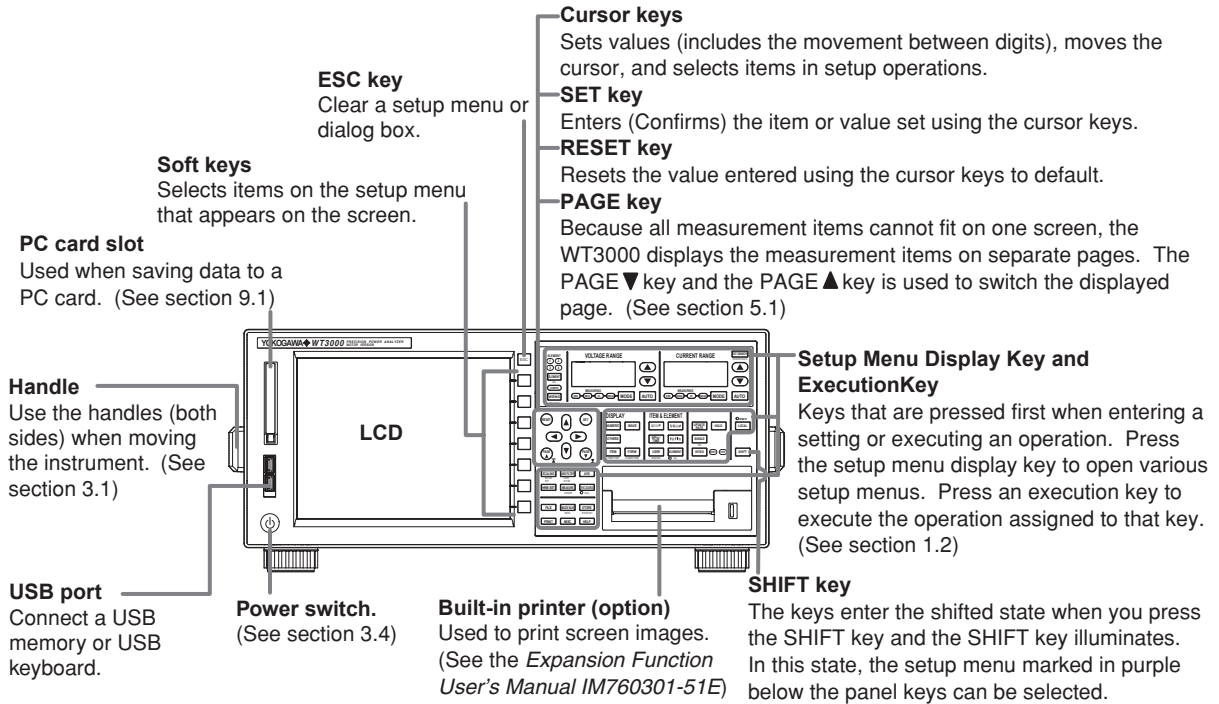

## Rear Panel

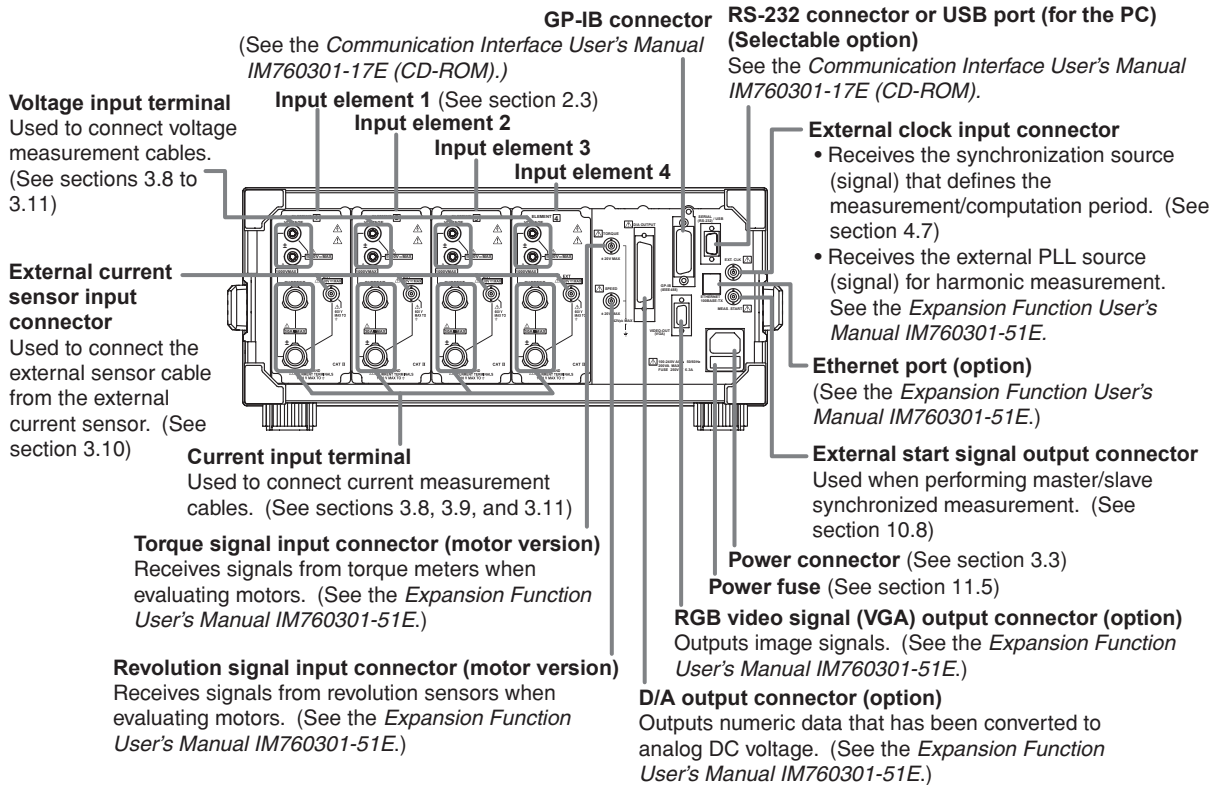

### Top Panel

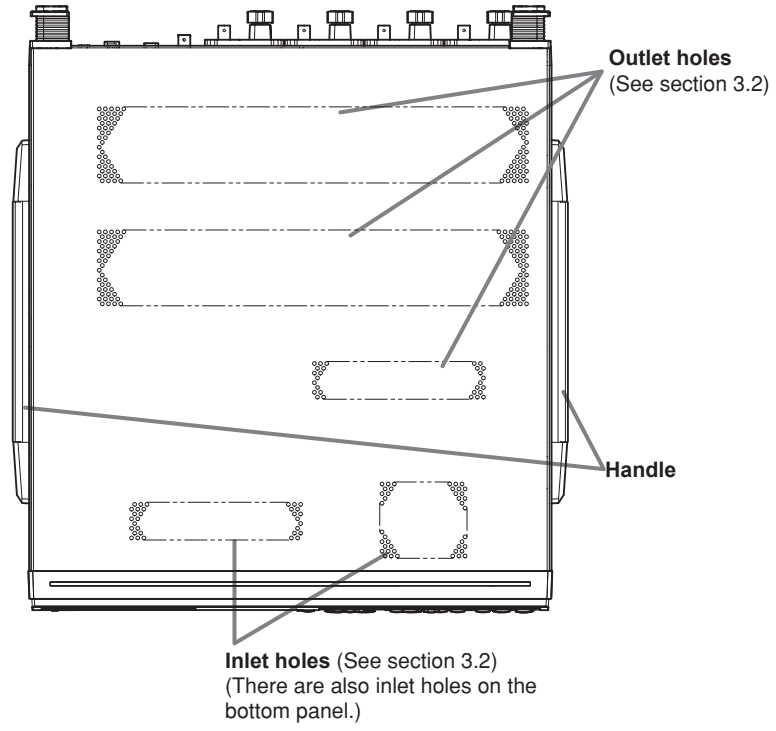

## 1.2 Setup Menu Display Key and Execution Key

### Setting the Measurement Conditions

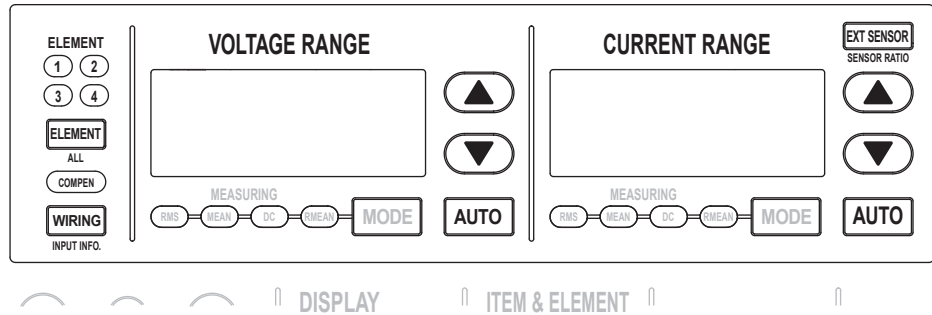

- **WIRING Key (See sections 4.1, 4.2, 5.7, and 5.8)**  
Displays a menu for selecting the wiring system, selecting independent setting of input elements, setting the computing equation for efficiency, setting the wiring compensation, setting the efficiency compensation, etc. When the wiring compensation or efficiency compensation is enabled, the COMPEN indicator illuminates.
- **SHIFT+WIRING (INPUT INFO.) Key (See sections 3.16 and 4.1)**  
Displays a list of conditions for receiving voltage/current signals and acquiring the signals as data such as the wiring system of each input element, wiring unit, measurement range, input filter, scaling, and synchronization source.
- **ELEMENT Key (See section 4.1 and 4.2)**
  - Selects the input element for setting the measurement range. The selected input element switches each time the ELEMENT key is pressed.
  - Input elements that are assigned to the same wiring unit in the wiring system selection are selected simultaneously.
- **SHIFT+ELEMENT (ALL) Key (See section 4.1 and 4.2)**  
Collectively sets the voltage range or current range of all installed input elements. Pressing only the ELEMENT key again enables individual input elements to be configured.
- **▲ Key and ▼ Key (See section 4.3 and 4.4)**  
Selects the voltage range, the current range, or the current sensor range. The selected range is enabled when the AUTO key is not turned ON (manual range function).
- **AUTO Key (See section 4.3 and 4.4)**  
When the AUTO key is pressed and the AUTO indicator illuminates, the auto range function is enabled. The voltage range, current range, and current sensor range are automatically switched according to the amplitude of the input electric signal. Pressing the AUTO key again turns OFF the AUTO indicator and enables the manual range function.
- **EXT SENSOR Key (See section 4.4)**  
When the EXT SENSOR key is pressed and the “EXT SENSOR” indicator illuminates, the current sensor range for measuring the current sensor output on the WT3000 can be selected using the ▲ or ▼ key in the CURRENT RANGE section. Pressing the EXT SENSOR key again turns OFF the EXT SENSOR indicator and enables the selection of the current range for direct input.
- **SHIFT+EXT SENSOR (SENSOR RATIO) Key (See section 4.4)**  
Displays a menu for setting the current sensor transformation ratio for each input element. These transformation ratios are used to convert the current sensor output to current.

## 1.2 Setup Menu Display Key and Execution Key

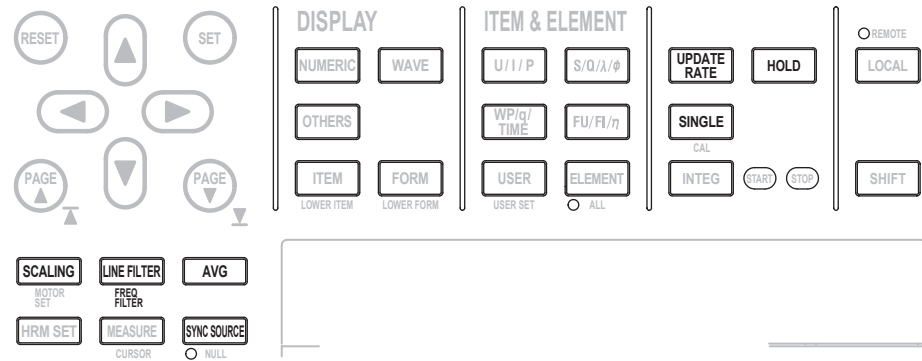

- **SCALING Key (See section 4.5)**  
 Displays a menu for setting the VT ratio, CT ratio, or power coefficient for each input element. These coefficients are used to convert the VT/CT output or the power derived from measuring the VT and CT outputs to the voltage, current, and power of the object being measured.
- **LINE FILTER Key (See section 4.8)**  
 Displays a menu for setting the filter that is inserted into the measurement circuit within the WT3000 for each input element.
- **SHIFT+LINE FILTER (FREQ FILTER) Key (See section 4.8)**  
 Displays a menu for setting the filter that is inserted into the frequency measurement circuit within the WT3000 for each input element.
- **AVG Key (See section 4.9)**  
 Displays a menu for setting the function that calculates the average of measured values.
- **SYNC SOURCE Key (See section 4.7)**

  - Displays a menu for setting the synchronization source for each wiring unit. The synchronization source defines the period (measurement period) over which the sample data is acquired for determining the numeric data (measured values) such as voltage, current, and power.
  - If all elements are selected with the SHIFT+ELEMENT (ALL) key as explained on the previous page, the synchronization source of all input elements can be set collectively.
- **UPDATE RATE Key (See section 4.10)**  
 Displays a menu for selecting the acquisition interval (data update rate) of the sampled data that is used to determine the numeric data (measured values) such as voltage, current, and power.
- **HOLD Key (See section 4.11)**  
 When the HOLD key is pressed and the HOLD indicator illuminates, the measurement and display operation is aborted, and the numeric data display is held. Pressing the HOLD key again turns OFF the HOLD indicator and restarts the updating of the numeric data display.
- **SINGLE Key (See section 4.11)**  
 If the SINGLE key is pressed while in the hold condition, the measurement is performed once at the specified data update rate and the WT3000 returns to the hold condition.

## Displaying the Measured/Computed Results

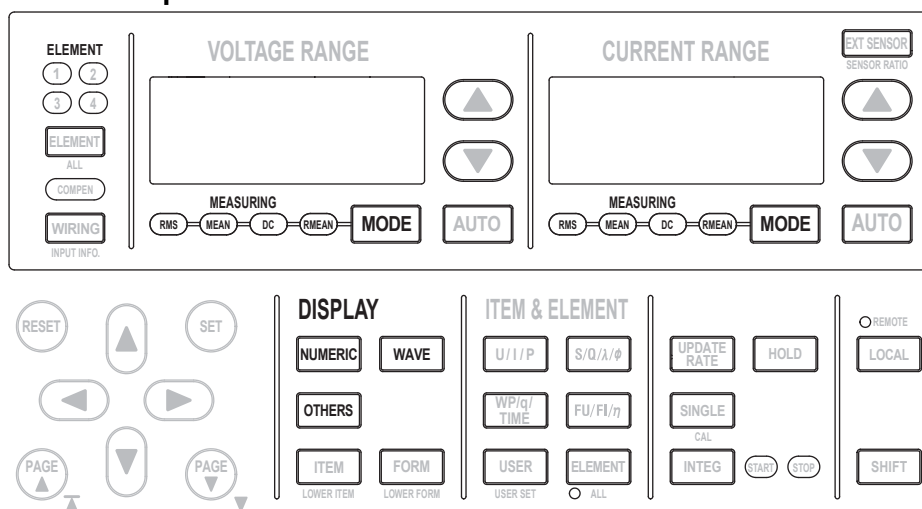

- MODE Key (See section 5.2)**  
 Switches the voltage mode and current mode. The mode can be set to true rms value (RMS), rectified mean value calibrated to the rms value (MEAN), simple average (DC), or rectified mean value (RMEAN) for the voltage mode and current mode, separately.
- NUMERIC Key (See section 3.15 and 5.1. For details on the harmonic measurement (/G6 or /G5 option), see the *Expansion Function User's Manual IM760301-51E.*)**  
 Displays the screen that shows the numeric data.
  - Pressing the ITEM key (explained later) while showing the numeric data opens a menu for changing the displayed items.
  - Pressing the FORM key (explained later) while showing the numeric data opens a menu for changing the number of displayed items. For harmonic measurement (/G6 or /G5 option), a list showing the measured values for each harmonic order can also be selected.
- WAVE Key (See section 3.15 and 6.1 to 6.8)**  
 Displays the screen that shows the waveform.
  - Pressing the ITEM key (explained later) while showing the waveform opens a menu for selecting the displayed waveform or a menu for zooming the waveform.
  - Pressing the FORM key (explained later) while showing the waveform opens a menu for setting the time axis of the displayed waveform, the trigger for displaying the waveform on screen, the number of divided waveform display windows, the assignment of waveforms to the divided windows, etc.
- OTHERS Key (See section 3.15, 7.1 to 7.6, and 7.8. For details on bar graphs or vector displays (option), see the *Expansion Function User's Manual IM760301-51E.*)**  
 Displays a menu for selecting the screen that shows the trend, bar graph,<sup>\*1</sup> vector,<sup>\*1</sup> IEC harmonic measurement,<sup>\*2</sup> waveform computation,<sup>\*2</sup> FFT,<sup>\*2</sup> voltage fluctuation and flicker measurement,<sup>\*3</sup> and cycle-by-cycle measurement.<sup>\*4</sup>
  - <sup>\*1</sup> Only on models with the /G6 or /G5 option.
  - <sup>\*2</sup> Only on models with the /G6 option.
  - <sup>\*3</sup> Only on models with the /FL option.
  - <sup>\*4</sup> Only on models with the /CC option.

## 1.2 Setup Menu Display Key and Execution Key

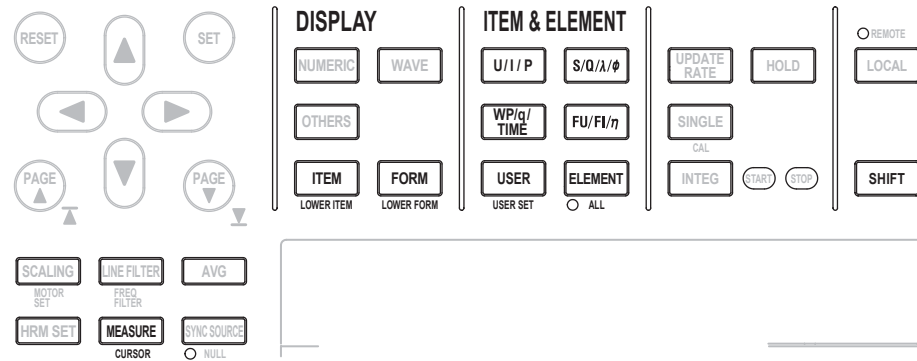

- **ITEM Key (See section 5.1, 6.4, 6.5, 7.2, 7.3, and 7.6. For details on bar graphs and vector displays (option), see the *Expansion Function User's Manual IM760301-51E.*)**

Displays a menu for selecting the displayed items according to the display type selected with the NUMERIC, WAVE, or OTHERS key on the previous page.
- **SHIFT+ITEM (LOWER ITEM) Key (See section 5.1, 6.4, 6.5, 7.2, 7.3, and 7.6. For details on bar graphs and vector displays (option), see the *Expansion Function User's Manual IM760301-51E.*)**

Displays a menu for selecting the displayed item on the bottom half of the display when two types of displays are displayed simultaneously on the top and bottom halves of the display using the setup menu shown with the OTHERS key on the previous page. The menu configuration is the same as when the bottom half of the display is shown by itself (full screen).
- **FORM Key (See section 5.1, 6.2, 6.3, 6.6 to 6.8, 7.4, 7.5, and 7.8. For details on bar graphs and vector displays (option), see the *Expansion Function User's Manual IM760301-51E.*)**

Displays a menu for selecting the display format according to the display type selected with the NUMERIC, WAVE, or OTHERS key on the previous page.
- **SHIFT+FORM (LOWER FORM) Key (See section 5.1, 6.2, 6.3, 6.6 to 6.8, 7.4, 7.5, and 7.8. For details on bar graphs and vector displays (option), see the *Expansion Function User's Manual IM760301-51E.*)**

Displays a menu for selecting the display format for the bottom half of the display when two types of displays are displayed simultaneously on the top and bottom halves of the display using the setup menu shown with the OTHERS key on the previous page. The menu configuration is the same as when the bottom half of the display is shown by itself (full screen).
- **U/I/P Key, S/Q/λ/φ Key, WP/q/TIME Key, FU/FI/η Key (See section 5.1)**

Each time the U/I/P key is pressed, the measurement function of the displayed item at the cursor switches in the following order: U -> I -> P -> the measurement function before the U/I/P key was pressed -> U, and so on. The numeric data of the selected measurement function is displayed.

  - The above operation is carried out when numeric data is displayed and the menu is not displayed or the ITEM key has been pressed.
  - Only the measurement function switches.
  - The measurement function of U and I varies depending on the voltage mode or current mode. For example, if the voltage mode is set to RMS, Urms and its numeric data are displayed.
  - When the S/Q/λ/φkey, WP/q/TIME key, or FU/FI/η key is pressed, the measurement function also switches in order similar to the U/I/P key.

- **USER Key (See section 5.1)**  
Each time the USER key is pressed, the measurement function of the displayed item at the cursor switches to the preset (user-defined) measurement function, and the numeric data of the selected measurement function is displayed.
  - The above operation is carried out when numeric data is displayed and the menu is not displayed or the ITEM key has been pressed.
  - Up to four measurement functions can be preset (user defined).
  - After displaying the user-defined measurement functions, the measurement function that was displayed before the USER key was pressed is shown.
  - Only the measurement function switches.
- **SHIFT+USER (USER SET) Key (See section 5.1)**  
Displays a menu for registering (defining) the measurement functions that you wish to display when the USER key is pressed.
- **ELEMENT Key (See section 5.1)**  
Each time the ELEMENT key is pressed on models with four input elements installed, the input element or wiring unit of the displayed item at the cursor switches in the following order: 1 -> 2 -> 3 -> 4 ->  $\Sigma A$  ->  $\Sigma B$  -> 1, and so on. The numeric data of the selected input element or wiring unit is displayed.
  - The above operation is carried out when numeric data is displayed and the menu is not displayed or the ITEM key has been pressed.
  - Only the input element or wiring unit switches.
  - The input element or wiring unit that is displayed varies depending on the number of input elements that are installed in the WT3000 or the selected wiring system.
- **SHIFT+ELEMENT (ALL) Key (See section 5.1)**  
If the ALL indicator is illuminated by pressing the SHIFT+ELEMENT (ALL) key on models with four input elements installed, each time the ELEMENT key is pressed, the input elements or wiring units displayed on one page switches in the following order: 1 -> 2 -> 3 -> 4 ->  $\Sigma A$  ->  $\Sigma B$  -> 1, and so on. The numeric data of the selected input elements or wiring units is displayed. If the SHIFT+ELEMENT (ALL) key is pressed again the ALL indicator turns OFF, and the function for switching the input elements or wiring units displayed on one page is released.
  - The above operation is carried out when numeric data is displayed and the menu is not displayed or the ITEM key has been pressed.
  - Only the input element or wiring unit switches.
  - The input element or wiring unit that is displayed varies depending on the number of input elements that are installed in the WT3000 or the selected wiring system.
- **MEASURE Key (See section 5.4 to 5.6, 5.9, 5.10, 10.3, and 10.9)**  
Displays a menu for setting the user-defined functions, setting the MAX hold function, setting the average active power, setting the computing equation for apparent/reactive power, setting the computing equation for corrected power, selecting the display format of phase difference, selecting the sampling frequency, setting the master/slave synchronized measurement, and so on.
- **SHIFT+MEASURE (CURSOR) Key (See section 6.9 and 7.7. For details on bar graphs (option), see the *Expansion Function User's Manual IM760301-51E.*)**  
Displays a menu for measuring values with cursors when waveforms, trends, or bar graphs (harmonic measurement option) are displayed.

## 1.2 Setup Menu Display Key and Execution Key

### Integration, D/A Output (Option), Motor Evaluation (Motor Version), and Harmonic Measurement (Option)

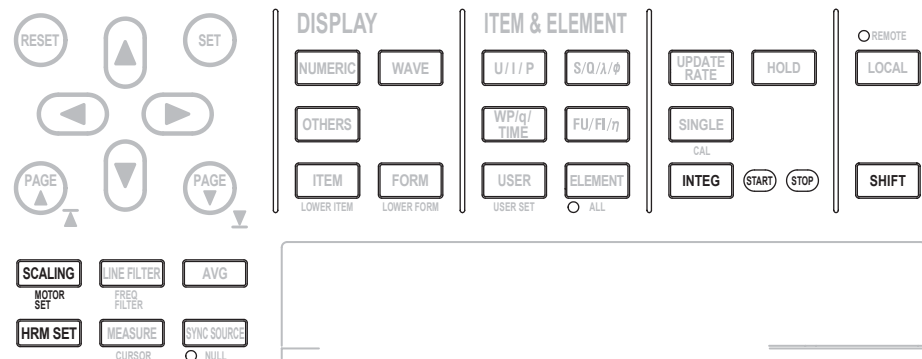

- **INTEG Key (See section 5.11 to 5.14. For details on the rated time of integrated D/A output (option), see the *Expansion Function User's Manual IM760301-51E*.)**  
Displays a menu for setting the integration mode, integration timer, reservation time, integration auto calibration, integration start/stop/reset, and rated time of integrated D/A output (option).
- **SHIFT+SCALING (MOTOR SET) Key (See the *Expansion Function User's Manual IM760301-51E* )**  
Displays a menu for setting the motor evaluation function.
- **HRM SET Key (See the *Expansion Function User's Manual IM760301-51E* )**  
Displays a menu for setting the harmonic measurement function.

### Storing/Recalling Data, Saving/Loading Data, and Printing on the Built-in Printer

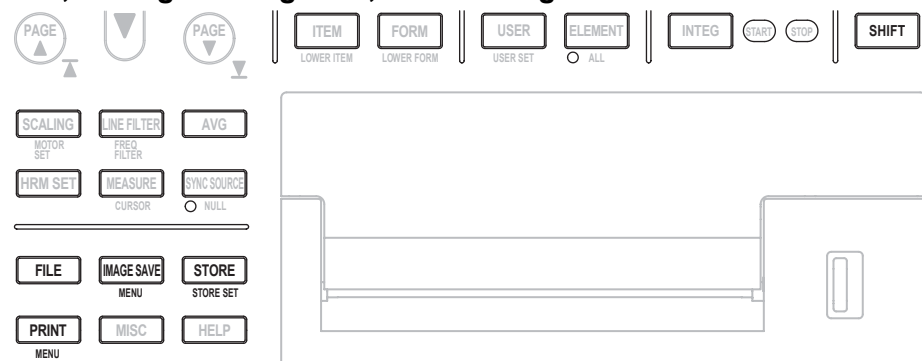

- **STORE Key (See section 8.4)**  
Starts or stops the store operation or clears the internal memory.
- **SHIFT+STORE (STORE SET) Key (See section 8.1 to 8.3, 8.5, and 8.6)**  
Displays the store and recall setup menu.
- **FILE Key (See section 9.1 to 9.3, and 9.5 to 9.9)**  
Displays a menu for formatting the external storage medium, saving/loading setup parameters, saving measured data, changing file attributes, deleting files, copying files, renaming directories/files, creating directories, etc.
- **IMAGE SAVE Key (See section 9.4)**  
Saves the screen image data.



- **SHIFT+IMAGE SAVE (MENU) Key (See section 9.4)**  
Displays a menu for setting the file name, data format, color mode, data compression, and comment shown on the display when saving the screen image data.
- **PRINT Key (See the *Expansion Function User's Manual IM760301-51E*)**  
Prints the screen image data or numeric data list.
- **SHIFT+PRINT (MENU) Key (See the *Expansion Function User's Manual IM760301-51E*)**  
Displays menu for setting the print destination, setting the print format, setting the comment, setting the auto print function, feeding the paper, and etc.

## Other Functions

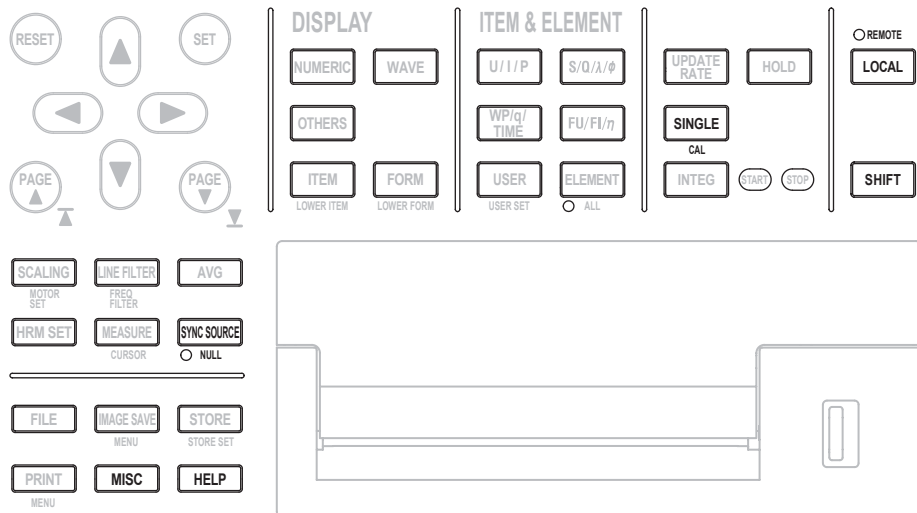

- **SHIFT+SINGLE (CAL) Key (See section 10.1)**  
Executes zero-level compensation. Creates a zero input condition inside the WT3000 and sets the level at that point as the zero level.
- **SHIFT+SYNC SOURCE (NULL) Key (See section 10.2)**  
When the SHIFT+SYNC SOURCE (NULL) key is pressed and the NULL indicator illuminates, the NULL function, which subtracts the DC component of the measurement circuit from the sampled data, is activated. Pressing the SHIFT+SYNC SOURCE (NULL) key again turns OFF the NULL indicator and the NULL function is deactivated.
- **MISC Key (See section 3.12, 3.13, 3.17, 4.6, 10.4 to 10.7, 11.3, and 11.4 For details on the D/A output, RS-232 communication, and Ethernet communication, see the *Expansion Function User's Manual IM760301-51E*.)**  
Displays a menu for setting the date/time, initializing setup parameters, selecting the message language, selecting the menu language, selecting the crest factor, selecting the display font, selecting the display brightness, setting the display color, setting key lock and shift lock, setting the self-test function, checking the system status, setting the D/A output (option), setting the remote control function (through the communication protocol of GP-IB/RS-232 (option)/Ethernet (option)) using communication commands, setting the Ethernet communication LAN function (option), etc.
- **HELP key (See section 10.8)**  
Displays a help window that provides information about the setup menu that is displayed.
- **LOCAL Key (See the *Communication Interface User's Manual IM760301-17E (CD-ROM)*)**  
Switches the WT3000 from remote mode (REMOTE indicator illuminated) to local mode (enable front panel key operation on the WT3000). However, the key is invalid when the WT3000 is in local lockout mode.

## 1.3 Display Screen

### Screen Example When Measuring Power (Numeric Display) in Normal Measurement Mode

For a description of the screens in other measurement modes and display modes other than power measurement (numeric display), see the respective chapters covering each mode.

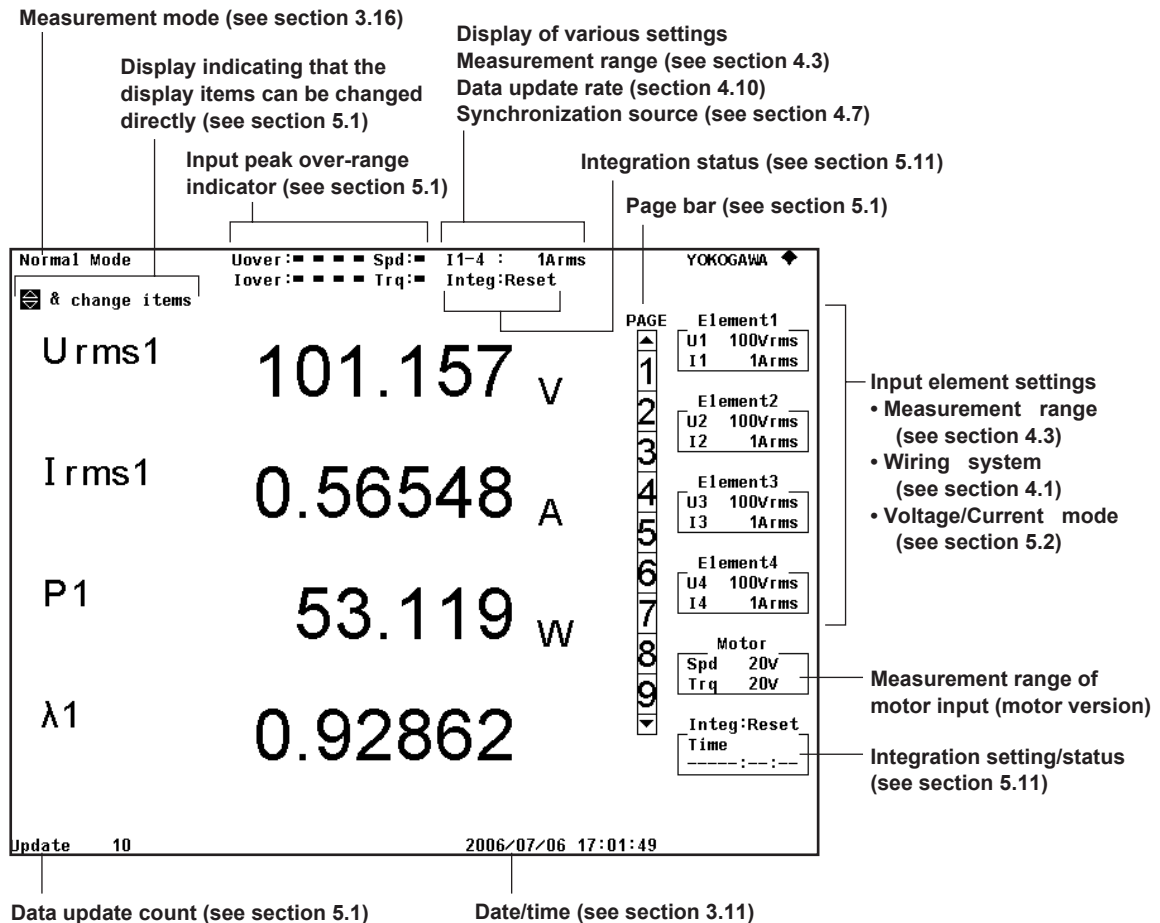

### Displays Other than Values

- OL--** **Over-range display**  
Displayed if the measured value exceeds 140% of the measurement range.
- OF--** **Overflow display**  
Displayed if the measured or computed result cannot be displayed using the specified decimal position or unit.
- **No data display**  
Displayed if a measurement function is not selected or if no numeric data is present.
- Error** **Error display**  
Displayed such as when the measured value is outside a given range.

# 2.1 System Configuration and Block Diagram

## System Configuration

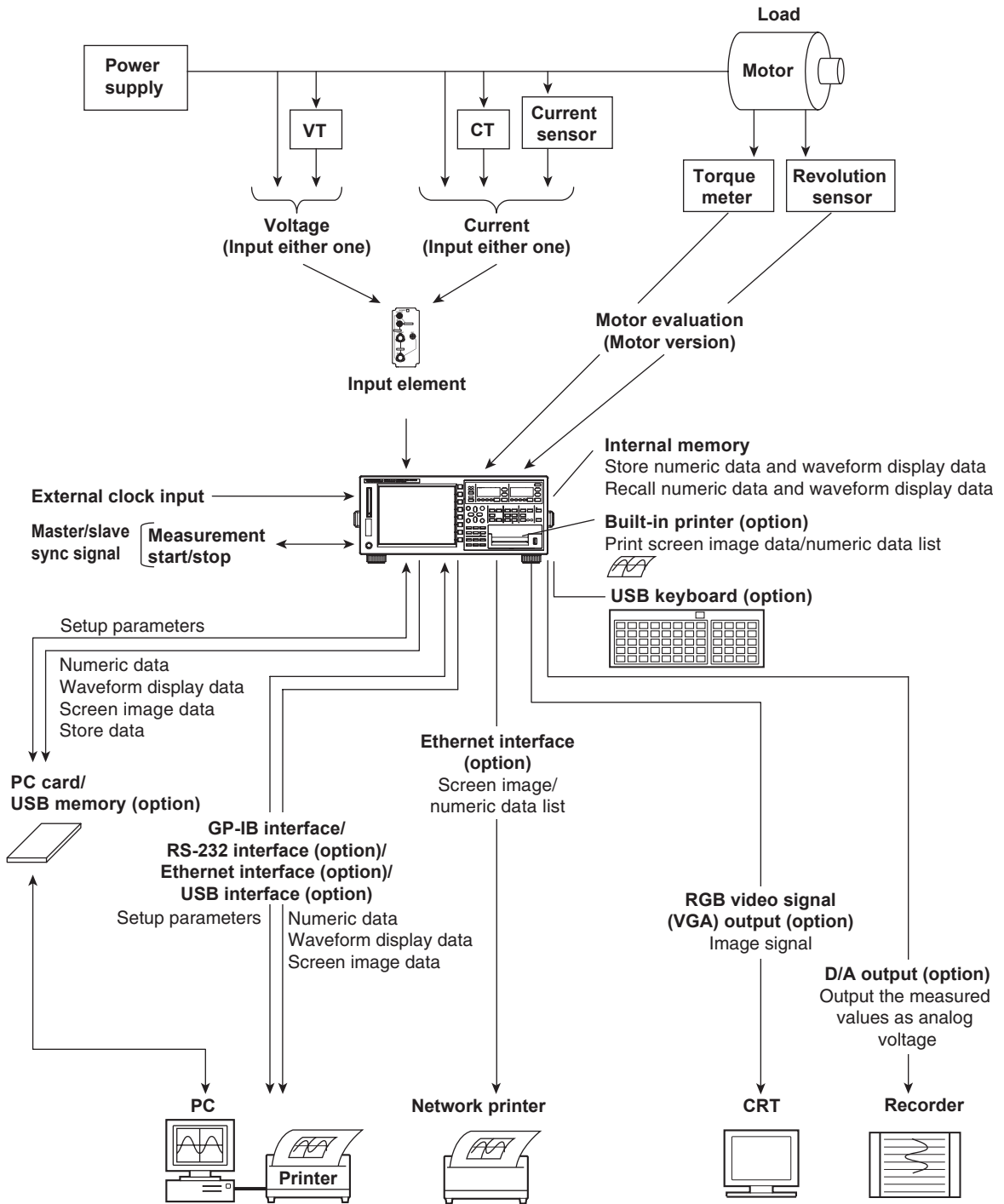

## 2.1 System Configuration and Block Diagram

### Block Diagram

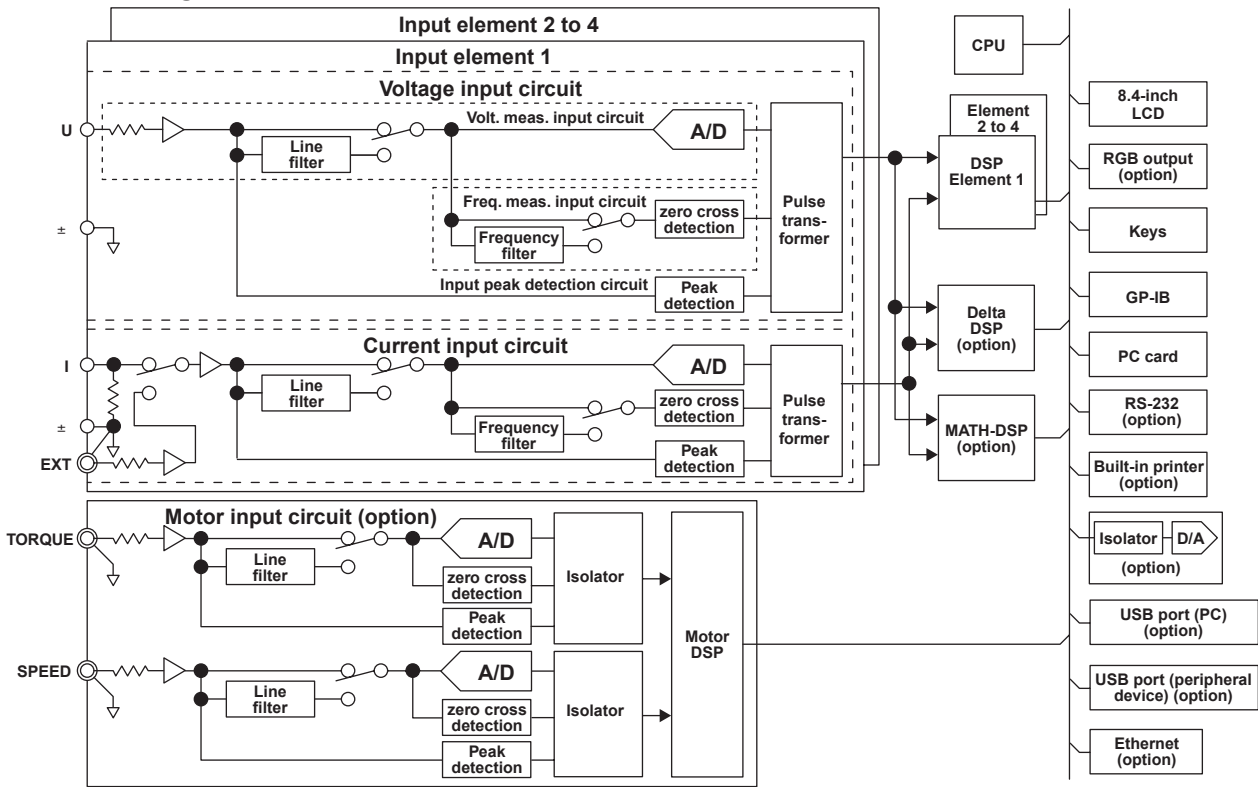

### Input Signal Flow and Process

The input elements 1 through 4, consist of a voltage input circuit and a current input circuit. The input circuits are mutually isolated. They are also isolated from the case.

The voltage signal that is applied to the voltage input terminal (U, ±) is normalized using the voltage divider of the voltage input circuit and an operational amplifier (OP AMP). It is then input to a voltage A/D converter.

The current input circuit is equipped with two types of input terminals, a current input terminal (I, ±) and a current sensor input connector (EXT). Either one can be used at any given time. The voltage signal from the current sensor that is received at the current sensor input connector is normalized using the voltage divider and an operational amplifier (OP AMP). It is then input to a current A/D converter. The current signal that is applied to the current input terminal is converted to a voltage. Then, it is input to the current A/D converter in the same fashion as the voltage signal from the current sensor.

The voltage signal that is input to the voltage A/D converter or current A/D converter is converted to digital values at an interval of approximately  $5 \mu\text{s}$ . The digital values are isolated by the pulse transformer and passed to the DSP. In the DSP, the measured values are derived based on the digital values. The measured values are then transmitted to the CPU. Various computed values are determined from the measured values. These measured values and computed values are displayed as measurement functions of normal measurement, output through a D/A converter, or output through communications.

The measurement functions of harmonic measurement (option) are derived in the following manner. The voltage signal input to the A/D converter is converted to digital values at a sampling frequency that is determined by the PLL source signal. The measured value of each item of harmonic measurement is derived by performing an FFT based on the converted digital values using the DSP.

## 2.2 Measurement Modes and Measurement Functions

### Measurement Modes

The normal measurement mode on the WT3000 allows you to measure voltage, current, power, etc. If the advanced computation (/G6) option is installed, measurements can be performed in a mode specific to each of the functions listed below in addition to the normal measurement mode. Switch the measurement mode according to your application.

- **Normal Measurement Mode (Normal Mode)**

This mode is used to measure voltage, current, power, and integrated values. If the /G6 option is installed, harmonic measurement\*<sup>1</sup> as well as bar graph and vector displays become available in normal measurement mode.

\*<sup>1</sup> Equivalent to the /G5 (harmonic measurement) option. This harmonic measurement does not conform to IEC61000-3-2.

- **Wide Bandwidth Harmonic Measurement Mode (Wide-Band Harmonics Mode) (/G6 Option)**

Harmonic measurement up to 50<sup>th</sup> order can be performed on a signal with a 1-kHz fundamental frequency. Use this mode for harmonic measurement of signals whose fundamental frequency is higher than the commercial power supply frequency.

- **IEC Harmonic Measurement Mode (IEC Harmonics Mode) (/G6 Option)**

This mode in combination with the Harmonic/Flicker Measurement Software (761922) sold separately allows you to perform harmonic measurement conforming to IEC61000-3-2. Use this mode to check that the harmonics of electric home appliances and office automation equipment comply with the IEC standards.

- **Waveform Computation Mode (Math Mode) (/G6 Option)**

This mode allows you to perform various computations on the waveform sampling data of the input signal. For example, the waveform sampling data of the voltage and current input signals can be multiplied together to display the waveform of instantaneous power.

- **FFT Mode (/G6 Option)**

This mode allows the power spectrum of the input signal to be displayed through FFT (fast Fourier transform). Use this mode to check the frequency distribution of the input signal.

- **Voltage Fluctuation and Flicker Measurement Mode (Flicker Mode) (/FL Option)**

This mode allows you to perform voltage fluctuation and flicker measurements conforming to IEC61000-3-3. You can use the Harmonic/Flicker Measurement Software for the WT3000 (761922) to execute measurements or set measurement conditions from a PC and create a report of measurement results.

- **Cycle-by-Cycle Measurement Mode (/CC Option)**

This mode allows the voltage, current, power, and other parameters for each cycle of the AC input signal to be measured.

## 2.2 Measurement Modes and Measurement Functions

The selectable displays and main functions of each measurement mode are given below. For a list of selectable functions, see appendix 10.

Measurement Mode		Normal Measurement	Wide Bandwidth Harmonic	IEC Harmonic	Waveform Computation	FFT	Voltage Fluctuation and Flicker	Cycle by Cycle	
Option		None	/G6, /G5 Harmonics	/G6	/G6	/G6	/FL	/CC	
Display	Numeric	Yes	Yes	Limit <sup>*1</sup>	Limit <sup>*1</sup>	Yes	Yes	No	No
	Waveform	Yes	Yes	No	No <sup>*2</sup>	No	Yes	No	No
	Trend	Yes	Yes	No	No	No	No	No	No
	Bar graph	No	Yes	Yes	No <sup>*2</sup>	No	No	No	No
	Vector	No	Yes	Yes	No	No	No	No	No
	Waveform computation	No	No	No	No	Yes	No	No	No
	FFT	No	No	No	No	No	Yes	No	No
	Flicker	No	No	No	No	No	No	Yes	No
Cycle by Cycle	No	No	No	No	No	No	No	Yes	
Data update rate		Yes	Yes	No	No	Yes	Yes	No <sup>*3</sup>	No
Integration		Yes	Yes	No	No	No	No	No	No
Motor		Yes	Yes	No	No	Yes	Yes	No	Yes
D/A		Yes	Yes	Yes	No	Yes	Yes	No	No
Delta computation		Yes	Yes	No	No	Yes	Yes	No	No

\*1 The rms values of the voltage or current are the total of the specified harmonic components, not the values that include all frequency components.

\*2 Can be monitored using the IEC harmonic measurement software.

\*3 Fixed to 2 s.

- **Differences in the Harmonic Measurement of Each Measurement Mode**

In IEC harmonic measurement mode, limitation is placed on a portion of the functions of the WT3000 as compared with the harmonic measurement in normal measurement mode due to the measurement conditions and constraints in the standard. For details, see the table above. During the development or inspection of a device, you can use the harmonic measurement in normal measurement mode to measure simultaneously the rms voltage, the rms current, the power, and harmonics in a simplified manner. To strictly evaluate whether the device complies with the IEC standard, you can use the IEC harmonic measurement mode. When measuring the harmonics of a high frequency power supply whose fundamental frequency is in the order of hundred Hertz, use the wide bandwidth harmonic measurement mode.

## Measurement Functions

The physical values such as rms voltage, average current, power, and phase difference that the WT3000 measures and displays are called measurement functions. Each measurement function is displayed using a symbol corresponding to the respective physical value. For example, “Urms” represents the true rms value of the voltage.

## Elements

Element refers to a set of input terminals that can input a single phase of voltage and current to be measured. The WT3000 can contain up to four elements, which are numbered from 1 to 4. An element number is appended to the measurement function symbol for the measured data that the WT3000 displays, so that the correspondence between the numeric data and the element can be seen. For example, “Urms1” represents the true rms value of the voltage of element 1.

## Wiring System

You can specify five wiring systems--single-phase, two-wire; single-phase, three-wire; three-phase, three-wire; three-phase, four-wire; and three-phase, three-wire (three-voltage, three current)--on the WT3000 to measure the power of various single-phase and three-phase power transmission systems. For details, see section 2.3.

## Wiring Unit

A wiring unit refers to a set of two or three input elements of the same wiring system that are grouped to measure three-phase power. Depending on the wiring system pattern (see section 2.3), up to two wiring units can be constructed, which are represented by symbols  $\Sigma A$  and  $\Sigma B$ . The measurement function of a wiring unit is called a  $\Sigma$  function. For example, “Urms $\Sigma A$ ” represents the true rms value of the average of the voltage of the input elements that are assigned to wiring unit  $\Sigma A$ .

- Configuration example of wiring systems and wiring units

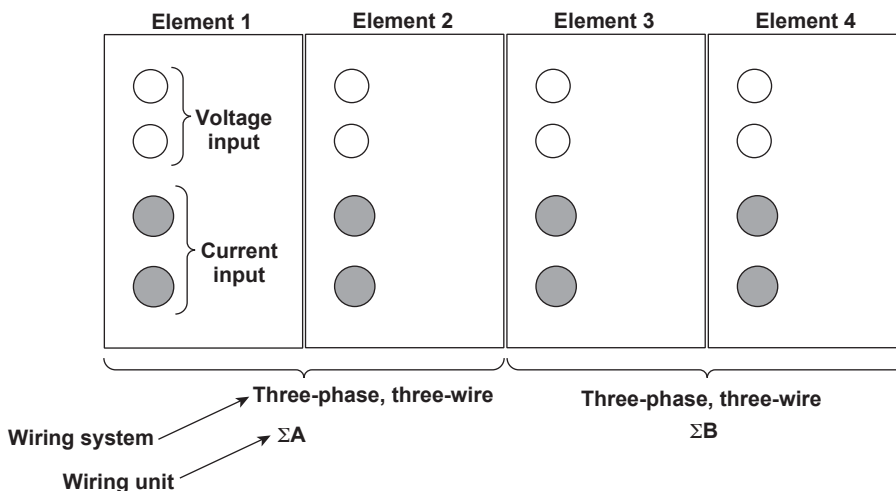

### Types of Measurement Functions during Normal Measurement

The data (numeric data) of measurement functions is measured or computed from the sampled data<sup>\*1</sup> described in "Measurement Period" on page 2-7.

\*1 The WT3000 samples the instantaneous values of the voltage and current signals at a specified sample rate<sup>\*2</sup>. The sampled data is processed as numeric data or data used to display waveforms on the screen (waveform display data).

\*2 Sample rate represents the number of data points that are sampled within 1 s. For example, at a sample rate of 200 kS/s, 200000 data points are sampled every second.

- **Types of Measurement Functions**

- **Measurement Functions on Each Input Element**

The following 22 measurement functions are available. For details related to the determination of measurement function data, see "Appendix 1."

U (voltage Urms, Umn, Udc, Urmn), I (current Irms, Imn, Idc, Irmn), P (active power), S (apparent power), Q (reactive power),  $\lambda$  (power factor),  $\phi$  (phase difference), fU/fl (also expressed as fU: FreqU and fl: FreqI, measures the frequencies of up to two voltage/current signals<sup>\*3</sup>), U+pk/U-pk (maximum/minimum values of voltage), I+pk/I-pk (maximum/minimum values of current), CfU/CfI (crest factor of voltage/current), Pc (Corrected Power)

\*3 The frequencies of voltage and current on all input elements can be measured on models with the frequency measurement add-on option.

- **Measurement Functions of Wiring Units  $\Sigma A$  and  $\Sigma B$  ( $\Sigma$  Functions)**

The following 14 measurement functions are available. For details related to the determination of measurement function data, see "Appendix 1."

U $\Sigma$  (voltage average Urms $\Sigma$ , Umn $\Sigma$ , Udc $\Sigma$ , Urmn $\Sigma$ ), I $\Sigma$  (current average Irms $\Sigma$ , Imn $\Sigma$ , Idc $\Sigma$ , Irmn $\Sigma$ ), P $\Sigma$  (sum of active powers), S $\Sigma$  (sum of apparent powers), Q $\Sigma$  (sum of reactive powers),  $\lambda\Sigma$  (power factor average),  $\phi\Sigma$  (phase difference average), Pc $\Sigma$  (sum of corrected powers)

- **Efficiency ( $\Sigma$  Functions), User-Defined Function**

Four efficiency functions  $\eta_1$  to  $\eta_4$  are available. 20 user-defined functions, F1 to F20, are available. See section 2.5.

- **Measurement Functions of Integration**

See section 2.6.

- **Delta Computation (Option)**

Four delta functions,  $\Delta F_1$  to  $\Delta F_4$ , are available. See the *Expansion Function User's Manual IM760301-51E*.

### Types of Measurement Functions for Harmonic Measurement (Option)

Harmonics can be measured on models with the advanced computation (/G6) option. Harmonic measurement consists of three types: harmonic measurement in normal measurement mode, wide bandwidth harmonic measurement, and IEC harmonic measurement. In addition, the rms voltage and current consist of two types: normal measurement value and total value. For details, see the *Extension Function User's Manual IM760301-51E*.



## Types of Measurement Functions of the Motor Evaluation Function (Motor Version)

By using the motor evaluation function (motor version), the rotating speed, torque, and output of a motor can be determined from the DC voltage (analog signal) or pulse count signal received from a revolution sensor, which is proportional to the rotating speed of the motor, and the DC voltage (analog signal) or pulse count signal received from a torque meter, which is proportional to the motor's torque. In addition, the synchronous speed and slip of a motor can be determined by setting the motor's number of poles. Furthermore, the active power and frequency that are measured by the WT3000 and the motor output can be used to compute the motor efficiency and the total efficiency. For details, see chapter 1, "Motor Evaluation Function (Motor Version)" in the *Expansion Function User's Manual IM760301-51E*.

### Voltage Mode and Current Mode

You can select equations for voltage (U) and current (I) from the following:

- **Urms, Irms (True Rms Value)**

These values are the true rms values of the voltage and current. The instantaneous values over one period are squared and averaged. Then, the square root of the value is determined.  $f(t)$  and  $T$  represent the input signal as a function of time and the period of the input signal, respectively.

$$U_{rms} \text{ or } I_{rms} = \sqrt{\frac{1}{T} \int_0^T f(t)^2 dt}$$

- **Umn, Imn (Rectified Mean Value Calibrated to the Rms Value)**

This function rectifies one period of the voltage or current signal, determines the average, and multiplies the result by a coefficient. The coefficient is a value that when applied to a sinusoidal input signal, gives the true rms value. When the input signal is a distorted or is a DC waveform, these values will differ from the true rms values.  $f(t)$  and  $T$  represent the input signal as a function of time and the period of the input signal, respectively.

$$U_{mn} \text{ or } I_{mn} = \frac{\pi}{2\sqrt{2}} \cdot \frac{1}{T} \int_0^T |f(t)| dt$$

- **Udc, Idc (Simple Average, DC)**

These are the average values over one period of the voltage and current signal. This function is useful when determining the average value of a DC input signal or a DC component that is superimposed on an AC input signal.

$$U_{dc} \text{ or } I_{dc} = \frac{1}{T} \int_0^T f(t) dt$$

- **Urmn, Irmn (Rectified Mean Value)**

This function rectifies one period of the voltage or current signal and determines the average.

$$U_{rmn} \text{ or } I_{rmn} = \frac{1}{T} \int_0^T |f(t)| dt$$

The WT3000 may use an averaging process through digital filter computation in addition to the averaging method using the equations above to derive the measured values of voltage (U) and current (I). For details, see "Data Update Interval" on page 2-14.

**Measurement Period**

- **Measurement Functions of Normal Measurement**

The measurement period varies depending on the data update rate (see section 2.3) as follows:

- **When the Data Update Rate Is 50 ms, 100 ms, 5 s, 10 s, or 20 s**

- The measurement period is set between the first point where the reference input signal (synchronization source) crosses the level zero point (center of the amplitude) on the rising slope (or falling slope)<sup>\*1</sup> within the data update interval<sup>\*2</sup> and the last point where the synchronization source crosses the level zero point (center of the amplitude) on the rising slope (or falling slope) within the data update interval. However, the measurement period for determining the numeric data of the peak voltage or peak current is the entire span within the data update interval. Therefore, the measurement period for the measurement functions U+pk, U-pk, I+pk, I-pk, CfU, and CfI that are determined from the maximum value of the voltage and current is also the entire span within the data update period.
- The rising or falling edge is automatically selected for the one that allows the interval to be longer.
- If the number of rising slope or falling slope is less than or equal to 1 within the data update interval, the measurement period is set to the entire span within the data update interval.
- You can select which input signal will be the synchronization source (synchronized to the zero-crossing point of the input signal) for each element. You can set the synchronization source signal to the voltage, current, or external clock that is input to the element.
- For details, see appendix 6.

\*1 Trigger slope refers to the movement of the signal from a low level to a high level (rising edge) or from a high level to a low level (falling edge).

\*2 The data update interval is the interval by which the data is sampled for determining the measurement functions. This is equivalent to the value you can specify in “Data Update Rate” of section 2.3.

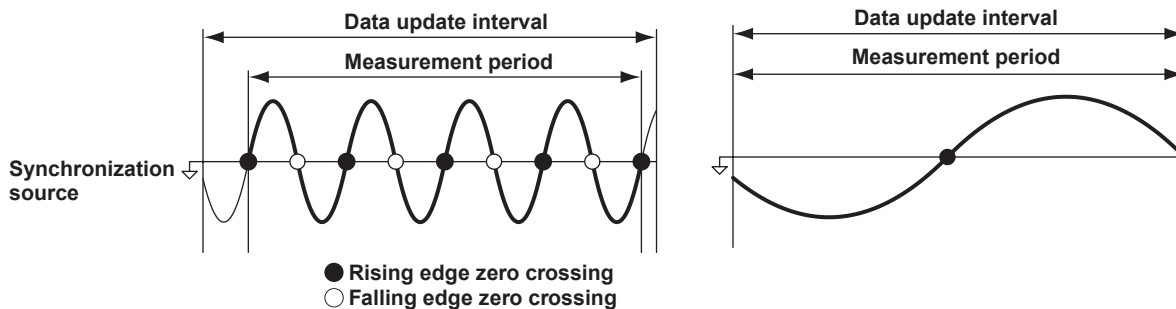

- **When the data update rate is 250 ms, 500 ms, 1 s, or 2 s**

The measurement period is within the data update interval.

- **Measurement Functions of Harmonic Measurement**

The measurement period is the first 9000 points from the beginning of the data update interval at the harmonic sampling frequency.

- **FFT**

The measurement period is over the number of FFT points (200,000 points or 20,000 points) at a sampling frequency of 200 KHz. Thus, the measurement period is as follows:

Number of Computed Points	Measurement Period
200,000	1 s
20,000	100 ms

## 2.3 Measurement Conditions

### Number of Installed Input Elements and Wiring Systems «For procedures, see section 4.1.»

#### Wiring System

- There are five wiring systems available on the WT3000.

1P2W: Single-phase, two-wire system

1P3W: Single-phase, three-wire system

3P3W\*: Three-phase, three-wire system

3P4W: Three-phase, four-wire system

3P3W\* (3V3A): Three voltage, three current system

\* In this manual, the symbolic expression 3P3W is used to indicate both three-phase, three-wire system and three-voltage, three-current system. To differentiate between the two, three-voltage, three-current system is expressed as 3P3W (3V3A).

- Limitations are placed on the wiring systems that can be selected depending on the number of input elements that are installed in the instrument.

#### Wiring Unit

A wiring unit refers to a set of two or three input elements of the same wiring system that are grouped. Up to two wiring units can be defined, each represented by the symbol  $\Sigma A$  and  $\Sigma B$ .

For example, "Urms $\Sigma A$ " represents the true rms value of the average of the voltage of the input elements that are assigned to wiring unit  $\Sigma A$

#### Wiring System Pattern

- The following table shows the relationship between the number of installed input elements, the selectable wiring system patterns, and the assignment of input elements to wiring units  $\Sigma A$  or  $\Sigma B$ .

For example, there are seven wiring system patterns on a WT3000 that has four input elements installed.

- The input element assignment to wiring units  $\Sigma A$  or  $\Sigma B$  is determined from the wiring system pattern. This allows  $\Sigma$  functions of voltage, current, active power, apparent power, reactive power, power factor, phase difference, and other parameters to be determined. For the relationship between the wiring system and the determination of the  $\Sigma$  function, see appendix 1.

Installed input elements	1			
Wiring system Pattern 1	1P2W			
Installed input elements	1	2		
Wiring system Pattern 1	1P2W	1P2W		
Wiring system Pattern 2	1P3W or 3P3W: $\Sigma A$			
Installed input elements	1	2	3	
Wiring system Pattern 1	1P2W	1P2W	1P2W	
Wiring system Pattern 2	1P3W or 3P3W(3V3A): $\Sigma A$		1P2W	
Wiring system Pattern 3	1P2W	1P3W or 3P3W(3V3A): $\Sigma A$		
Wiring system Pattern 4	3P4W or 3P3W(3V3A): $\Sigma A$			
Installed input elements	1	2	3	4
Wiring system Pattern 1	1P2W	1P2W	1P2W	1P2W
Wiring system Pattern 2	1P3W or 3P3W: $\Sigma A$		1P2W	1P2W
Wiring system Pattern 3	1P2W	P3W or 3P3W: $\Sigma B$		1P2W
Wiring system Pattern 4	1P2W	1P2W	1P3W or 3P3W: $\Sigma A$	
Wiring system Pattern 5	1P3W or 3P3W: $\Sigma A$		1P3W or 3P3W: $\Sigma B$	
Wiring system Pattern 6	3P4W or 3P3W(3V3A): $\Sigma A$			1P2W
Wiring system Pattern 7	1P2W	3P4W or 3P3W(3V3A): $\Sigma A$		

**Measurement Range «For procedures, see section 4.3.»**

Set the measurement range using an rms level. When directly applying voltage or current signals to the input element, two types of measurement ranges is available, fixed range and auto range. When waveforms are displayed, the vertical display range corresponds to 3 or 6 times the measurement range when the crest factor (see section 4.6) is set to 3 or 6, respectively. For details on waveform display, see section 2.7, “Waveform Display.”

- **Fixed Range**

Select each range from a number of choices. The selected range does not switch even if the amplitude of the input signal changes. For voltage, the maximum and minimum selectable ranges are 1000 V and 15 V, respectively, when the crest factor is set to 3. When the crest factor is set to 6, the maximum and minimum selectable ranges are 500 V and 7.5 V, respectively.

- **Auto Range**

The measurement range switches automatically depending on the amplitude of the input signal. The different ranges used in the auto range are the same as those available for fixed range.

- **Range Increase**

- When the data of measurement function  $U_{rms}$  or  $I_{rms}$  exceeds 110% of the current measurement range, the measurement range is increased.
- When the peak value of the input signal exceeds 330% or 660% of the current measurement range when the crest factor is set to 3 or 6, respectively, the range is increased.

- **Range Decrease**

When the data of the measurement function  $U_{rms}$  or  $I_{rms}$  is less than or equal to 30% of the measurement range and  $U_{pk}$  and  $I_{pk}$  is less than or equal to 300% or 600% of the next lower range when the crest factor is set to 3 or 6, respectively, the range is decreased.

- **Power Range**

The measurement ranges (power ranges) of active power, apparent power, and reactive power are determined by the wiring method, voltage range, and current range as shown below. For the actual values of the power range, see section 4.3, “Setting the Measurement Range during Direct Input.”

Wiring System	Power Range
1P2W (single-phase, two-wire)	voltage range × current range
1P3W (single-phase, three-wire)	voltage range × current range × 2
3P3W (three-phase, three-wire)	(when the voltage and current ranges on the corresponding elements are set to the same range)
3P3W (3V3A, three-voltage, three-current)	
3P4W (three-phase, four-wire)	voltage range × current range × 3 (when the voltage and current ranges on the corresponding elements are set to the same range)

**Scaling «For procedures, see sections 4.4 and 4.5.»**

When applying current signals via an external current sensor or applying voltage or current signals via the external VT (voltage transformer) or CT (current transformer), the transformation ratio or coefficient can be specified.

- **When Applying Current Signals via an External Current Sensor**

The output of current sensors that output voltage, such as shunts and clamps, can be input to the current sensor connector (EXT) and measured. Set how many millivolts the current sensor outputs when 1 A of current flows (transformation ratio). Then, the input signal can be made to correspond to the numeric data or waveform display data that are obtained when the current is directly applied to the input terminals.

Measurement Function	Transformation Ratio	Data before Transformation	Transformation Result
Current I	E	$I_S$ (current sensor output)	$I_S/E$
Active power P	E	$P_S$	$P_S/E$
Apparent power S	E	$S_S$	$S_S/E$
Reactive power Q	E	$Q_S$	$Q_S/E$
Max./Min. current value I <sub>pk</sub>	E	$I_{pkS}$ (current sensor output)	$I_{pkS}/E$

- **When Applying Voltage or Current Signals via an External VT or CT**

- **VT ratio and CT ratio**

The input signal can be converted into numeric data or waveform display data of the voltage or current before transformation by setting the VT ratio, CT ratio, and power coefficient (coefficient multiplied to the power determined from the voltage and current).

- **Power factor**

You can multiply a coefficient to the measured active power, apparent power, and reactive power to be displayed by setting a power factor (SF).

Measurement Function	Data before Transformation	Transformation Result
Voltage U	$U_2$ (secondary output voltage of the VT)	$U_2 \times V$ V: VT ratio
Current I	$I_2$ (secondary output of the CT)	$I_2 \times C$ C: CT ratio
Active power P	$P_2$	$P_2 \times V \times C \times SF$ SF: Power coefficient
Apparent power S	$S_2$	$S_2 \times V \times C \times SF$
Reactive power Q	$Q_2$	$Q_2 \times V \times C \times SF$
Max./Min. voltage value U <sub>pk</sub>	$U_{pk2}$ (secondary output of the VT)	$U_{pk2} \times V$
Max./Min. current value I <sub>pk</sub>	$I_{pk2}$ (secondary output of the CT)	$I_{pk2} \times C$

**Crest Factor «For procedures, see section 4.6.»**

The crest factor is defined as the ratio of the peak value of the waveform to the rms value.

$$\text{Crest factor (CF)} = \frac{\text{Peak value}}{\text{Rms value}}$$

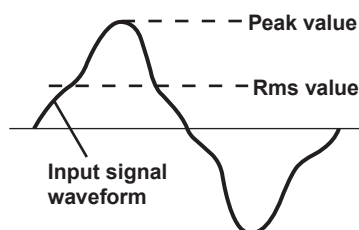

The crest factor on the WT3000 is determined by the maximum peak value that can be applied for rated input in terms of a multiplication factor.

$$\text{Crest factor (CF)} = \frac{\text{Peak value that can be input}}{\text{Measurement range}}$$

## 2.3 Measurement Conditions

---

The crest factor can be set to 3 or 6 on the WT3000. The measurable crest factor is as follows:

$$\text{Crest factor (CF)} = \frac{\{\text{measurement range} \times \text{CF setting (3 or 6)}\}}{\text{Measured value (rms value)}}$$

\* However, the peak value of the input signal must be less than or equal to the maximum allowable input.

If the crest factor of the measured signal is greater than the specifications of the measurement instrument (the crest factor defined at the rated input), the signal can be measured by setting a greater measurement range.

For example, even if CF is set to 3, measurement is possible for signals with a crest factor greater than 5 when the measured value (rms value) is less than 60% of the measurement range.

If the minimum effective input (1% of the measurement range) is being applied at CF = 3, measurement for CF = 300 is possible.

The voltage range, current range, effective input range, and measurement accuracy vary depending on the crest factor setting. For details, see chapter 12, "Specifications."

### Input Filter «For procedures, see section 4.8.»

There are two types of input filters. The WT3000 makes measurements by synchronizing to the input signal. Therefore, the frequency of the input signal must be measured accurately.

- **Line Filter**

The line filter is inserted into the voltage, current, and power measurement input circuit and directly affects the voltage, current, and power measurements (see the block diagram in section 2.1). When the line filter is turned ON, the measured value does not contain high frequency components. Measurement of voltage, current, and power is possible by eliminating high frequency components from inverter waveforms, strain waveforms, etc. The cutoff frequency is selectable.

- **Frequency Filter**

The frequency filter is inserted into the frequency measurement input circuit and affects frequency measurements. If the display update rate of the WT3000 is set to 50 ms, 100 ms, 5 s, 10 s, or 20 s, it affects the detection of the measurement period for voltage, current, and power measurements (see section 4.7 and appendix 6). In addition, if the data update rate is as indicated above, the frequency filter is also used to accurately detect the zero crossing (see section 2.2 and appendix 6). The frequency filter is not inserted into the voltage, current, and power measurement input circuit. Therefore, the measured values include high frequency components even when the frequency filter is turned ON.

**Averaging «For procedures, see section 4.9.»**

The averaging function is effective when reading of the numeric display is difficult due to fluctuations. This occurs when the fluctuation of the power supply or the load is large or when the input signal frequency is low.

- **Measurement Functions of Normal Measurement**

Two types, exponential average and moving average, are available.

- **Exponential Average**

The numeric data can be exponentially averaged using a specified attenuation constant. Averaging is performed according to the following equation.

$$D_n = D_{n-1} + \frac{(M_n - D_{n-1})}{K}$$

$D_n$ : Displayed value that has been exponentially averaged  $n$  times. (The displayed value  $D_1$  at the first time is  $M_1$ .)

$D_{n-1}$ : Displayed value that has been exponentially averaged  $n-1$  times.

$M_n$ : Measured data at the  $n^{\text{th}}$  time.

$K$ : Attenuation constant (select from 2, 4, 8, 16, 32, and 64)

- **Moving Average**

The numeric data can be linearly averaged using a specified average count. Averaging is performed according to the following equation.

$$D_n = \frac{M_{n-(m-1)} + \dots + M_{n-2} + M_{n-1} + M_n}{m}$$

$D_n$ : Displayed value obtained by linearly averaging  $m$  points of numeric data from the  $n-(m-1)^{\text{th}}$  to  $n^{\text{th}}$  time

$M_{n-(m-1)}$ : Measured data at the  $n-(m-1)^{\text{th}}$  time.

.....

.....

$M_{n-2}$ : Measured data at the  $(n-2)^{\text{th}}$  time.

$M_{n-1}$ : Measured data at the  $(n-1)^{\text{th}}$  time.

$M_n$ : Measured data at the  $n^{\text{th}}$  time.

$m$ : Average count (select from 8, 16, 32, 64, 128, and 256)

- **Measurement Functions of Harmonic Measurement**

- **Harmonic Measurement in Normal Measurement Mode**

When averaging is turned ON, averaging is performed on the measurement functions of harmonic measurement when exponential averaging (above) is specified.

If averaging is set to moving average, averaging is performed only on the measurement functions of normal measurement and not the measurement functions of harmonic measurement.

- **Measurement Functions of Wide Bandwidth Harmonic Measurement Mode**

Performs exponential averaging. The attenuation constant can be selected from above.

- **Measurement Functions of IEC Harmonic Measurement Mode**

Performs exponential averaging. The attenuation constant cannot be selected.

- **Measurement Functions of Voltage Fluctuation and Flicker Measurement Mode and Cycle-by-Cycle Measurement Mode**

Averaging is not performed. The average setting is invalid.

### Data Update Interval «For the procedure, see section 4.10.»

- **Limitation on the Data Update Rate by Measurement Modes**
  - **Normal Measurement Mode, Waveform Computation Mode, and FFT Mode**

The data update rate setting is valid. However, the display update interval in waveform computation mode and FFT mode is the data update rate + computation time.
  - **Wide Bandwidth Harmonic Measurement Mode and IEC Harmonic Measurement Mode**

The data update rate setting is invalid. The data update rate is automatically determined by the fundamental frequency and the number of periods of the PLL source.
  - **Voltage Fluctuation and Flicker Measurement Mode**

The data update rate is fixed to 2 s.
  - **Cycle-by-Cycle Measurement Mode**

The data update rate setting is invalid. The data update rate is automatically determined by the fundamental frequency and the number of measurement cycles of the synchronization source.
- **Data Update Rate in Normal Measurement Mode, Waveform Computation Mode, and FFT Mode**

You can select the value from 50 ms, 100 ms, 250 ms, 500 ms, 1 s, 2 s, 5 s, 10 s, and 20 s. The numeric data is updated at the selected interval. To capture relatively fast load fluctuations in the power system, select a fast data update rate. To capture relatively low frequency signals, select a slow data update rate.

The WT3000 automatically selects the computing method from the two averaging computations below according to the data update rate. For details, see appendix 7.

  - **When the Data Update Rate Is 50 ms, 100 ms, 5 s, 10 s, or 20 s**

Computation is performed using ASSP (Average for the Synchronous Source Period) on the sampled data within the data update interval to calculate the measured value. (However, integrated power WP as well as integrated current q during DC mode are excluded.)

This method requires the period of the assigned synchronous source signal to be detected accurately.

Check to see that the frequency of the synchronous source signal is being measured correctly according to the procedures given in sections 5.1 and 5.3.

\* For a description of the synchronous source, see appendix 6, "Setting the Measurement Period."
  - **When the Data Update Rate Is 250 ms, 500 ms, 1 s, or 2 s**

Computation is performed using EAMP (Exponential Average for Measuring Period) on the sampled data within the data update interval to calculate the measured value. This method does not require the input signal period to be detected accurately.

### Hold «For procedures, see section 4.11.»

The data display of each measurement function can be held. The communication output data while the display is held is the held numeric data.

### Single Measurement «For procedures, see section 4.11.»

While in the hold condition, a measurement is performed once at the specified data update rate and enters the hold condition.



## 2.4 Power Measurement

The measured data of voltage, current, power, and so on can be displayed by setting the screen to numeric display. By dividing the screen into top and bottom halves, waveform (section 2.7), trend (section 2.8), bar graph<sup>\*1</sup> (section 2.8), waveform computation<sup>\*2</sup> (section 2.9), and FFT<sup>\*2</sup> (section 2.9) can be displayed simultaneously.

\*1 Only on models with the advanced computation (/G6) or harmonic measurement (/G5) option.

\*2 Only on models with the advanced computation (/G6) option.

### Display Resolution

The display resolution for voltage, current, active power, apparent power, reactive power, and so on is 600000. When the range rating (rated value of the specified range) is applied, the  $\Sigma$  function of voltage, current, active power, apparent power, reactive power, and so on is set to the decimal point position and unit of the element with the lowest display resolution of the target elements. For the display resolution during integration, see section 5.13.

### Numeric Display Related to Power Measurement «For procedures, see section 5.1.»

- **Selecting the Number of Displayed Items**

The number of items can be selected from 4, 8, 16, All, Single List,<sup>\*3</sup> and Dual List.<sup>\*3</sup>

\*3 Only on models with the advanced computation (/G6) or harmonic measurement (/G5) option.

- **Example in Which Eight Items Are Displayed**

Measurement function	Data
U rms1	0.10639 kV
I rms1	1.6741 A
P 1	0.1651 kW
S 1	0.1781 kVA
Q 1	-0.0669 kvar
$\lambda$ 1	0.92688
$\phi$ 1	D 22.046 °
fU1	4.1004 kHz

- **Example in Which All Items Are Displayed**

Measurement function	Element and wiring system				
		Element1	Element2	Element3	Element4
		100Vrms 500mA rms	100Vrms 500mA rms	100Vrms 500mA rms	100Vrms 500mA rms
U [V ]	105.715	105.746	105.620	0.000	
I [A ]	569.215m	565.763m	0.000m	1.592m	
P [W ]	55.8692	55.5459	0.0000	-0.0000	
S [VA ]	60.1748	59.8274	0.0000	0.0000	
Q [var]	-22.3526	-22.2255	0.0000	0.0000	
$\lambda$ [ ]	0.92845	0.92844	-----	Error	
$\phi$ [° ]	D 21.806	D 21.808	-----	Error	
fU [Hz ]	50.000	50.000	50.000	Error	
fI [Hz ]	1.7288k	1.9361k	Error	Error	
U+pk[V ]	148.617	148.676	148.509	0.119	
U-pk[V ]	-148.622	-148.669	-148.506	-0.104	
I+pk[A ]	1.04405	1.04036	0.000m	6.537m	
I-pk[A ]	-1.04668	-1.04046	0.000m	-5.616m	
cfU [ ]	1.406	1.406	1.406	Error	
cfI [ ]	1.839	1.839	-----	4.105	
Pc [W ]	55.9683	55.6440	0.0000	Error	

## 2.4 Power Measurement

- **Changing the Displayed Items**

By selecting a displayed item, the numeric data value that is displayed at the position can be changed.

Urms1	0.10496	<small>kV</small>		Urms1	0.10513	<small>kV</small>
Irms1	1.6946	<small>A</small>	Change the measurement function of the third item	Irms1	1.6929	<small>A</small>
P1	0.1650	<small>kW</small>		λ1	0.92791	
S1	0.1779	<small>kVA</small>	Change the element of the third item	S1	0.1780	<small>kVA</small>
				Urms1	0.10476	<small>kV</small>
			Irms1	1.7020	<small>A</small>	
			P2	-0.0000	<small>W</small>	
			S1	0.1783	<small>kVA</small>	

- **Scrolling the Page**

The numeric display consists of up to nine pages. The number pages varies depending on the installed options and the number of displayed items. The displayed items can be assigned for each page. The page can be scrolled to switch the page, and the displayed items can be changed collectively.

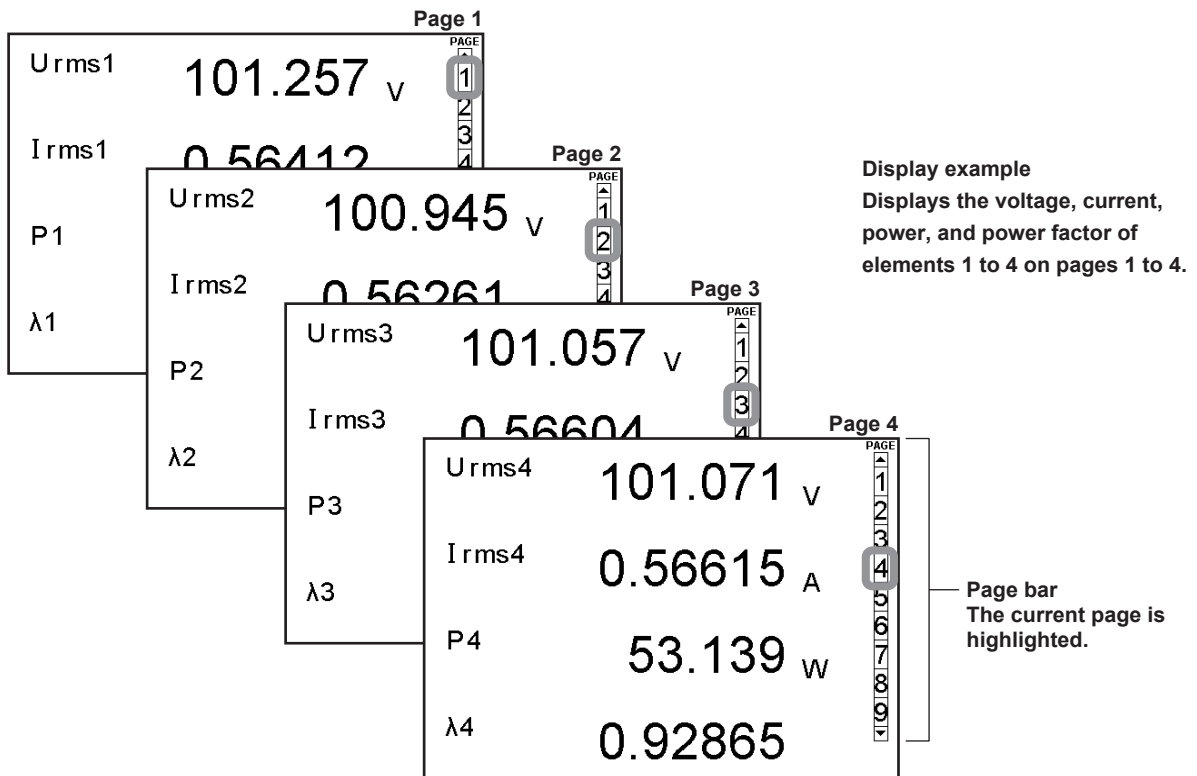

- **Resetting the Numeric Display**

If the number of displayed items is set to a value other than All, the display order of measurement functions can be reset to a default order (1 default set).

### Numeric Display Related to Harmonic Measurement «See the *Expansion Function User's Manual IM760301-51E.*»

Single list or dual list can be displayed on models with the advanced computation (/G6) or harmonic measurement (/G5) option.

## 2.5 Computation

By using the data of measurement functions, the following computations can be performed. In addition, a function is provided in which the equation used to determine the measurement function data can be selected.

### User-Defined Functions «For procedures, see section 5.4.»

Equations can be created (defined) by combining the measurement function symbols and operators. The numeric data corresponding to the equation can then be determined. The combination of a measurement function and element number (U1:U(E1, ORT), for example) constitutes an operand. 20 equations (F1 through F20) can be defined.

- **Operator**

There are 11 operators: +, -, \*, /, ABS (absolute value), SQR (square), SQRT (square root), LOG (logarithm), LOG10 (common logarithm), EXP (exponent), and NEG (negation).

- **Number of Operands**

There can be up to 16 operands in one equation.

### MAX Hold «For procedures, see section 5.5.»

Holds the maximum value of the numeric data. The measurement function of which the maximum value is to be held is specified using the user-defined function.

### Setting the Average Active Power «For procedures, see section 5.6.»

The average active power can be computed on devices on which the power fluctuates such as an intermittent control device. The computing equation for average active power is specified using the user-defined function.

### Setting the Computing Equation for Efficiency «For procedures, see section 5.7.»

By setting equations for  $\eta_1$  to  $\eta_4$ , the input/output efficiency of a device can be measured. For example, if the input power to a device is  $P_{\Sigma A}$  and the output power is  $P_{\Sigma B}$ , the power conversion efficiency of the device can be computed by setting the equation  $\eta = (P_{\Sigma B}) / (P_{\Sigma A}) \times 100$ . On models with the motor evaluation function (motor version), the energy conversion efficiency of the motor can be computed by setting the equation  $\eta = ((P_m) / (P_{\Sigma A}) \times 100)$  or  $((P_m) / (P_{\Sigma B}) \times 100)$ .

### Setting the Efficiency Compensation «For procedures, see section 5.8.»

Compensates for the measurement loss that occurs due to the wiring used for measurement or the internal impedance of the power meter. There are two functions used to compensate for the loss caused by the measurement instrument. For details, see appendix 8.

- **Wiring Compensation**

Compensates for the loss caused by the wiring system of each element.

- **Efficiency Compensation**

The power measurement on the secondary side of a power transformer such as an inverter includes loss caused by the measurement instrument. This loss appears as error in the efficiency computation. This function compensates for this loss.

**Setting the Compensation for Two-Wattmeter Method «For procedures, see section 5.8.»**

In the two-wattmeter method, an error results when current flows through the neutral line. This function computes the current the flows through the neutral line for measurements using the two-wattmeter method with a three-phase, three wire (3V3A) system and adds the compensation value to the measured power. For details, see appendix 8. This function can be set on models with the delta computation option.

**Selecting the Computing Equation for Apparent Power and Reactive Power «For procedures, see section 5.9.»**

There are three types of powers: active power, reactive power, and apparent power. In general, each type is defined by the following equations.

Active power  $P = UI\cos\phi$  ..... (1)

Reactive power  $Q = UI\sin\phi$  ..... (2)

Apparent power  $S = UI$  ..... (3)

where U: rms voltage, I: rms current, and  $\phi$ : Phase between voltage and current

For three-phase power, it is the sum of the powers of each phase.

In addition, these power values are related as follows:

$(\text{Apparent power } S)^2 = (\text{active power } P)^2 + (\text{reactive power } Q)^2$  ..... (4)

These definitions apply only for sine waves. The measured values for apparent power and reactive power vary for distorted waveform measurement depending on which definitions above are combined for the computation. Because the equations for deriving the power for distorted waveforms are not defined, none of the equations can be said to be more correct than the other. Therefore, the WT3000 provides three equations for determining the apparent power and reactive power.

Because active power is derived directly from the sampled data, errors resulting from different definitions do not occur such as in the apparent power and reactive power.

• **TYPE 1 (The Method Used by Normal Mode of Conventional WT Series Power Meters)**

The apparent power of each phase is calculated using equation (3), and the reactive power of each phase is calculated using equation (2). The results are summed to derive the power.

Active power for three-phase, four-wire system  $P\Sigma = P1 + P2 + P3$

Apparent power for three-phase, four-wire system  $S\Sigma = S1 + S2 + S3 (= U1 \times I1 + U2 \times I2 + U3 \times I3)$

Reactive power for three-phase, four-wire system  $Q\Sigma = Q1 + Q2 + Q3$

$(= s1 \times \sqrt{(U1 \times I1)^2 - P1^2} + s2 \times \sqrt{(U2 \times I2)^2 - P2^2} + s3 \times \sqrt{(U3 \times I3)^2 - P3^2})$

However, the sign for s1, s2, and s3 is negative when the current leads the voltage and positive when the current lags the voltage.

• **TYPE2**

The apparent power of each phase is determined from equation (3), and the results are added to derive the three-phase apparent power. The three-phase reactive power is calculated from the three-phase apparent power and three-phase active power using equation (4).

Active power for three-phase, four-wire system  $P\Sigma = P1 + P2 + P3$

Apparent power for three-phase, four-wire system  $S\Sigma = S1 + S2 + S3 (= U1 \times I1 + U2 \times I2 + U3 \times I3)$

Reactive power for three-phase, four-wire system  $Q\Sigma = \sqrt{S\Sigma^2 - P\Sigma^2}$

- **TYPE 3 (The Method Used by Harmonic Measurement Mode on the WT1600 and PZ4000)**

The reactive power of each phase is calculated directly using equation (2). The three-phase apparent power is calculated using equation (4). This computing equation can be selected on models with the advanced computation (/G6) or harmonic measurement (/G5) option.

$$\begin{aligned} \text{Active power for three-phase, four-wire system} & \quad PS = P1 + P2 + P3 \\ \text{Apparent power for three-phase, four-wire system} & \quad S_{\Sigma} = \sqrt{P_{\Sigma}^2 + Q_{\Sigma}^2} \\ \text{Reactive power for three-phase, four-wire system} & \quad QS = Q1 + Q2 + Q3 \end{aligned}$$

- **Measurement Mode and Computing Equation**

The computing equations that can be selected in each measurement mode are as follows:

Measurement Mode	S and Q Equations		
	TYPE 1	TYPE 2	TYPE 3*1
Normal Measurement	Yes	Yes	Yes
Wide Bandwidth Harmonic*2	Fixed to TYPE3*3		
IEC Harmonic*2	Fixed to TYPE3*3		
Waveform Computation	Yes	Yes	No*4
FFT Yes		Yes	No*4
Voltage Fluctuations and Flicker*2, *5	No No		No
Cycle by Cycle*2	Fixed to TYPE2*6		

Yes: Selectable.  
No: Not selectable.

\*1 Selectable only on models with the advanced computation (/G6) option.

\*2 The setup menu of the equations of S and Q is not displayed.

\*3 If TYPE1 or 3 is selected and you select wide bandwidth harmonic measurement mode or IEC harmonics mode, the equation switches to TYPE3.

\*4 If TYPE3 is selected and you select waveform computation mode or FFT mode, the equation switches to TYPE1.

\*5 S and Q are not measured in voltage fluctuation and flicker measurement mode. Thus, the S and Q equation settings are invalid.

\*6 If TYPE1 or 3 is selected and you select cycle-by-cycle measurement mode, the equation switches to TYPE2.

### Corrected Power «For procedures, see section 5.9.»

Depending on the applicable standard, when the load that is connected to the potential transformer is extremely small, the active power of the potential transformer that is measured needs to be compensated. In such cases, set the compensating equation and the coefficient.

**IEC76-1(1976), IEEE C57.12.90-1993**

$$P_c = \frac{P}{P_1 + P_2 \left( \frac{U_{rms}}{U_{mn}} \right)^2}$$

P<sub>c</sub>: Corrected Power

P: Active power

U<sub>rms</sub>: True rms voltage

U<sub>mn</sub>: Voltage (rectified mean value calibrated to the rms value)

P<sub>1</sub>, P<sub>2</sub>: Coefficient as defined in the applicable standard

**IEC76-1(1993)**

$$P_c = P \left( 1 + \frac{U_{mn} - U_{rms}}{U_{mn}} \right)$$

### **Phase Difference «For procedures, see section 5.10»**

The display format of the phase difference between the voltage and current of each element can be selected. With the voltage of each element as a reference, one format displays the phase difference using  $360^\circ$  in the clockwise direction, and the other format displays lead up to  $180^\circ$  in the counterclockwise direction (D) and lag up to  $180^\circ$  in the clockwise direction (G). The phase difference of harmonic order 1 to 100 of the voltage and current on the harmonic measurement option is displayed using a  $360^\circ$  format or a  $180^\circ$  format (negative sign for lead and no sign for lag).

### **Delta Computation «See the *Expansion Function User's Manual IM760301-51E*.»**

Delta computation can be performed on models with the delta computation function option.

### **Equation for Distortion Factor «See the *Expansion Function User's Manual IM760301-51E*.»**

The distortion factor can be computed on models with the advanced computation (/G6) or harmonic measurement (/G5) option. You can select one of two equations available for computing the distortion factor.

## 2.6 Integration

The WT3000 can integrate the active power (watt hour), the current (ampere hour), the apparent power (volt-ampere-hour), and the reactive power (var-hour). During integration, the measured and computed values of normal measurements can be displayed in addition to the watt hour, current hour, volt-ampere-hour, var-hour and integration time.

### Measurement Functions of Integration

- **Measurement Functions on Each Input Element**

The following nine types of numeric data can be determined. For details related to the determination of measurement function data, see "Appendix 1."

WP (watt hour, sum of positive and negative watt hours), WP+ (positive watt hour consumed), WP- (negative watt hour returned to the power supply (regenerated energy)), q (current hour, sum of positive and negative current hours), q+ (positive current hour consumed), q- (negative current hour returned to the power supply), WS (volt-ampere-hour), WQ (var-hour), and Time (integration time).

- **Measurement Functions of wiring units  $\Sigma A$  and  $\Sigma B$  ( $\Sigma$  Functions)**

The following eight types of numeric data can be determined. For details related to the determination of measurement function data, see "Appendix 1."

WP $\Sigma$  (sum of WP), WP+ $\Sigma$  (sum of WP+), WP- $\Sigma$  (sum of WP-), q $\Sigma$  (sum of q), q+ $\Sigma$  (sum of q+), q- $\Sigma$  (sum of q-), WS $\Sigma$  (sum of S $\Sigma$ ), and WQ $\Sigma$  (sum of Q $\Sigma$ )

### Integration Mode «For procedures, see sections 5.11 and 5.12.»

There are five modes in the integration function: manual integration mode, normal integration mode, repetitive integration mode, real-time integration mode, and real-time repetitive integration mode.

- **Manual Integration Mode**

Integration continues from the point when it is started to the point it is stopped. However, when the integration time reaches its maximum (10000 hours) or the integration value reaches its maximum or minimum (see section 5.11), the integration is stopped and the integration time and integration value at that point are held.

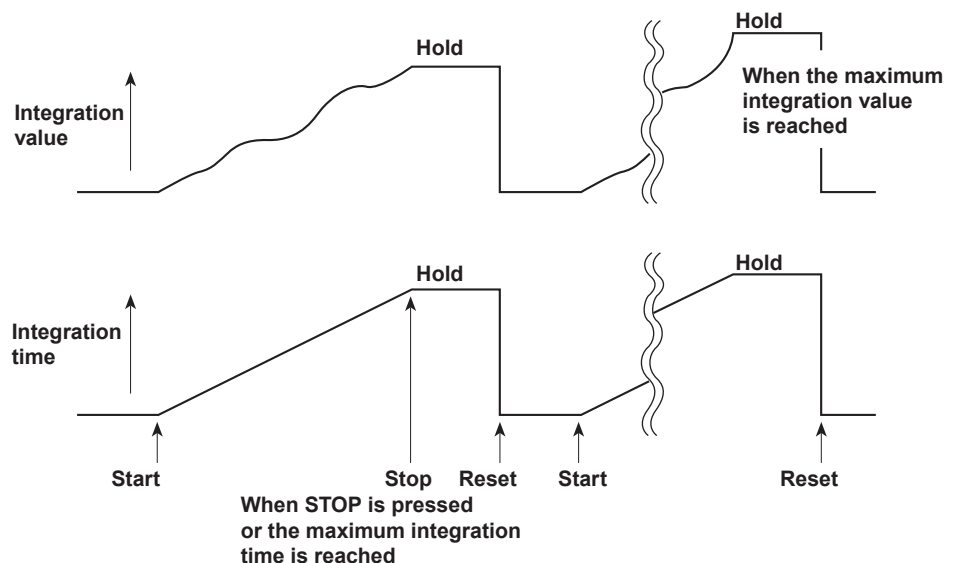

- **Normal Integration Mode**

The integration time is set in relative time. The integration is stopped after the specified time elapses or when the integration value reaches the maximum or minimum integration display value. The integration time and value are held at that point.

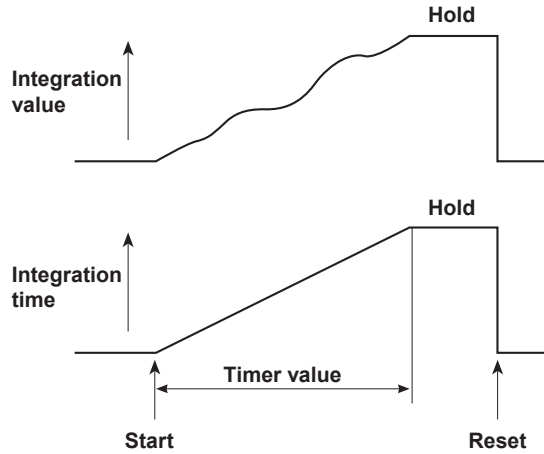

- **Repetitive Integration Mode (Continuous Integration)**

The integration time is set in relative time. When the specified time elapses, the operation is automatically reset and restarted. Integration is repeated until STOP is pressed. When the integration value reaches the maximum or minimum integration display value, the integration time and value are held.

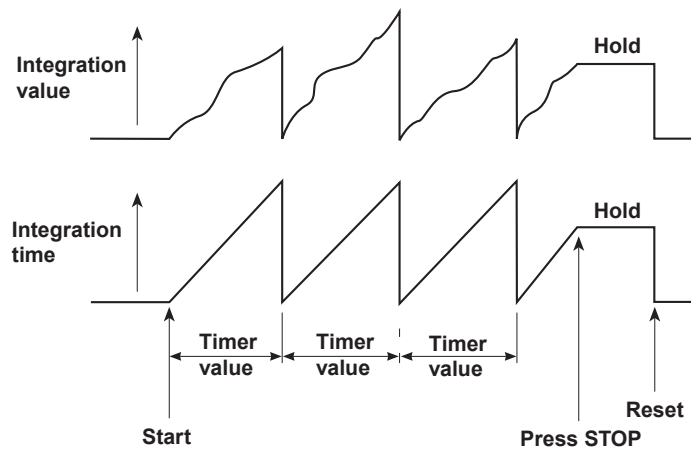



- **Real-Time Normal Integration Mode**

The date and time of start and stop of the integration operation are set. The integration is stopped at the specified time or when the integration value reaches the maximum or minimum integration display value. The integration time and value are held at that point.

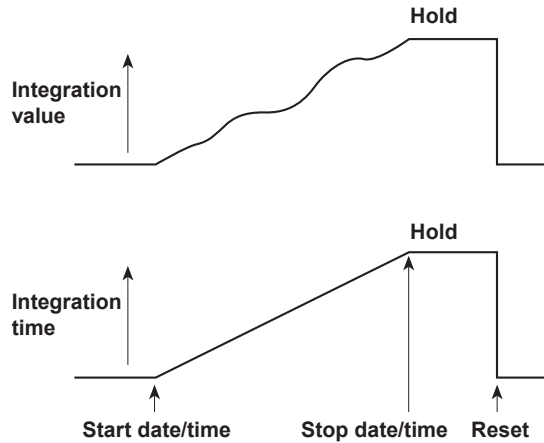

- **Real-Time Repetitive Integration Mode (Continuous Integration)**

The start and stop of the integration operation are set with the date and time. The integration is repeated at the specified timer setting during that time. When the time specified by the timer elapses, the operation is automatically reset and restarted. The integration is stopped at the specified time or when the integration value reaches the maximum or minimum integration display value. The integration time and value are held at that point.

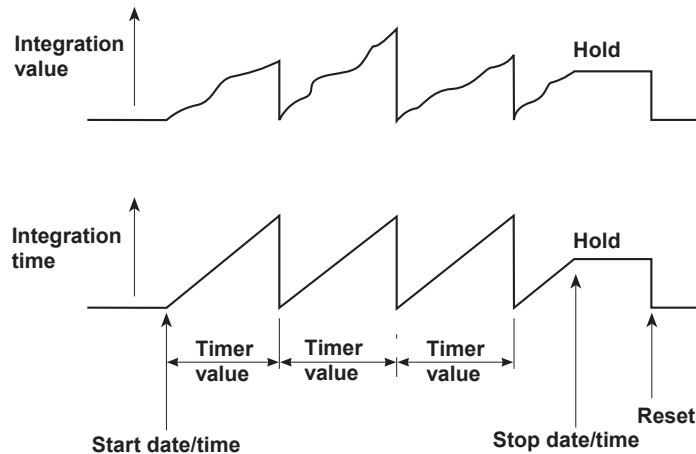

## 2.7 Waveform Display

The WT3000 displays waveforms based on the data sampled within the data update rate.

### Selecting the Waveform to Be Displayed «For procedures, see section 6.2.»

You can select whether to show or hide the voltage and current waveforms of each input element. This feature enables easy viewing of waveforms as only the required waveforms can be displayed.

### Vertical (Amplitude) Axis

The vertical display range is determined based on the specified measurement range. For example, if the crest factor is set to 3 and the voltage measurement range is set to "100 Vrms," then the display range is set so that the top of the screen is 300 Vpk ( $100 \text{ Vrms} \times 3$ ) and the bottom is  $-300 \text{ Vpk}$  ( $-100 \text{ Vrms} \times 3$ ) with the zero input line at the center. If the crest factor is set to 6 and the voltage measurement range is set to "50 Vrms," then the display range is set so that the top of the screen is 300 Vpk ( $50 \text{ Vrms} \times 6$ ) and the bottom is  $-300 \text{ Vpk}$  ( $-50 \text{ Vrms} \times 6$ ) with the zero input line at the center. The waveform clips if this range is exceeded.

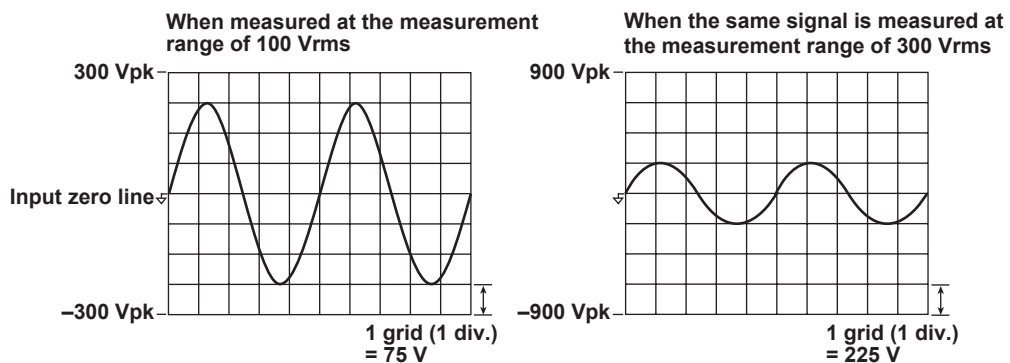

### Horizontal (Time) Axis «For procedures, see section 6.3.»

Set the horizontal (time) axis by specifying the time per grid (1 division). The time axis can be set in 1, 2, or 5 steps in the range up to the point in which the time corresponding to one screen is equal to the data update rate. For example, if the data update rate is 500 ms, the time per division can be changed in the order, 0.5 ms, 1 ms, 2 ms, 5 ms, 10 ms, 20 ms, and 50 ms. This allows the time of one screen to be changed in the order, 5 ms, 10 ms, 20 ms, 50 ms, 100 ms, 200 ms, and 500 ms.

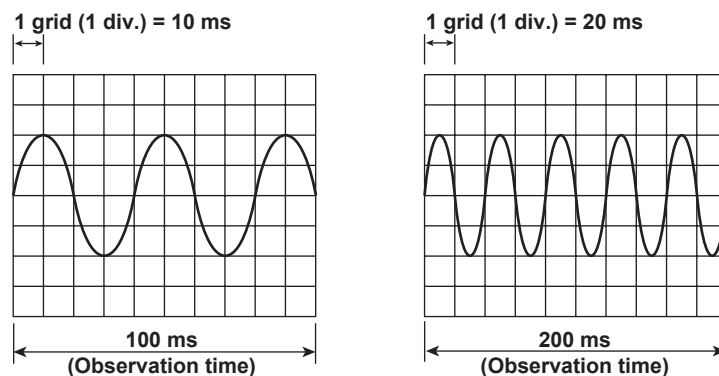

**Note**

- **Waveform sampling data and waveform display data (the number of displayed points on the screen)**

The waveform sampling data and waveform display data are both measured data of the waveform, but they differ as described below.

**Waveform sampling data: Data derived by making an A/D conversion of the input signal**

The A/D conversion rate is approximately 200 kS/s on the WT3000. Therefore, if the data update rate is set to 1 s, the number of waveform sampling data points in a single measurement is approximately 200,000 for an input signal (see the figure below). The waveform sampling data is also called acquisition data or raw wave data.

**Waveform display data: Waveform display data on the WT3000 screen (1002 points)**

When displaying waveforms on the WT3000, data points are displayed in horizontal rasters (along the time axis). The number of rasters is 501. Each raster contains two points of waveform display data. The two data points are the maximum and minimum values of the waveform data in each raster. Therefore, the number of waveform display data points (the number of points displayed on the screen) is 1002 for an input signal.

**Extraction of the waveform display data from the waveform sampling data (p-p compression)**

Let us consider an example when a 2-Hz sine wave is measured at the data update rate of 1 s. To display this waveform on the WT screen, the number of data points is converted from approximately 200,000 to 1002 (501 pairs of maximum and minimum values). Thus, two points (a pair) of waveform display data is derived from approximately 400 points of waveform sampling data. This conversion is called p-p (peak-peak) compression. The compression rate of p-p compression varies depending on the data update rate and the horizontal scale (time axis) of the WT waveform display.

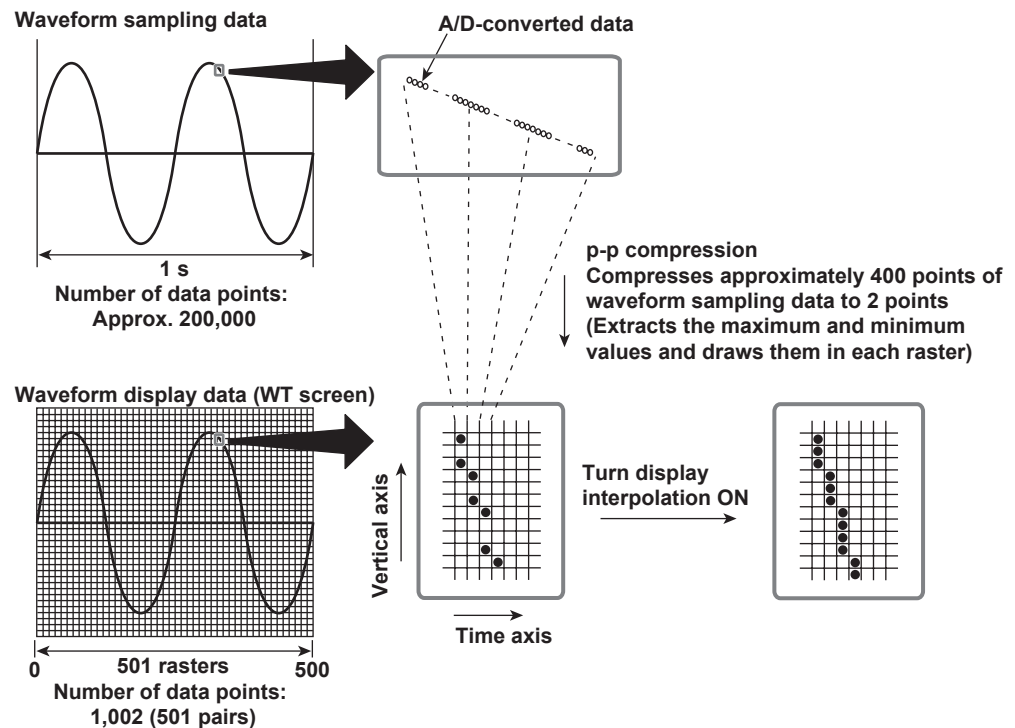

## 2.7 Waveform Display

---

- **Aliasing**

When the sampling rate is comparatively low with respect to the input signal frequency, the harmonics contained in the signal are lost. In this case, some of the harmonics will appear at low frequencies due to the effects described by the Nyquist sampling theorem. This phenomenon is called aliasing.

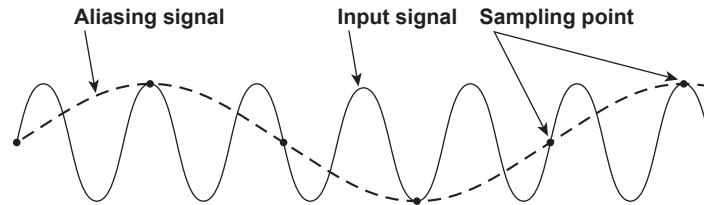

- **Retrieval of waveform display data**

The WT3000 retrieves waveform display data to the memory at a sampling rate of approximately 200 kS/s. The frequency that allows displaying of waveforms that are close to the input signal is up to approximately 10 kHz.

---

**Trigger «For procedures, see section 6.4.»**

A trigger is a cue used to display the waveform on the screen. The trigger is activated when the specified trigger condition is met. At this point, the waveform is ready to be displayed on the screen.

- **Trigger Mode**

Trigger mode specifies the conditions for updating the screen display.

- **Auto Mode**

If a trigger occurs within a specified amount of time (about 100 ms, referred to as the timeout period), the waveform display is updated. If a trigger does not occur within the timeout time, the display is automatically updated when the timeout time elapses.

- **Normal Mode**

The display is updated only when the trigger occurs. The display is not updated if the trigger does not occur.

- **Trigger Source**

Trigger source refers to the signal that is used in checking the trigger condition.

- **Trigger Slope**

Trigger slope refers to the movement of the signal from a low level to a high level (rising edge) or from a high level to a low level (falling edge). When the slope is used as one of the trigger conditions, it is called a trigger slope.

- **Trigger Level**

Trigger level refers to the level through which the trigger slope passes.

When the slope of the trigger source passes through the specified trigger level on a rising or falling edge, a trigger is activated. You can select the input signal of each element or external clock input signal as a trigger source.

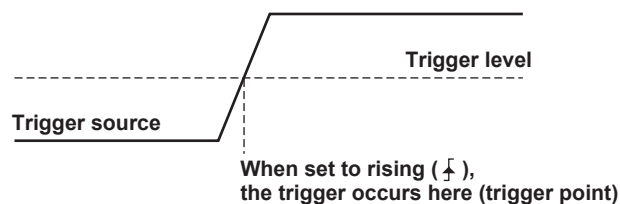

- **Trigger Point**

Trigger point refers to the point at which a trigger occurred. The trigger point is always at the left end of the screen. The waveform after the trigger point is displayed from the left to the right of the screen as the time progresses.

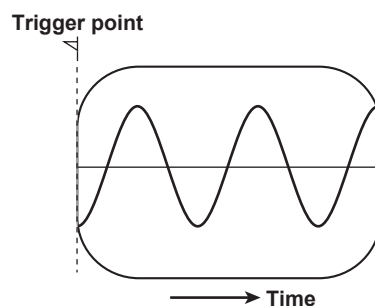

**Zooming Vertically on the Waveform «For procedures, see section 6.5.»**

Each displayed waveform can be expanded or reduced vertically by the zoom factor in the range of 0.1 to 100. The waveform is zoomed around the zero input line.

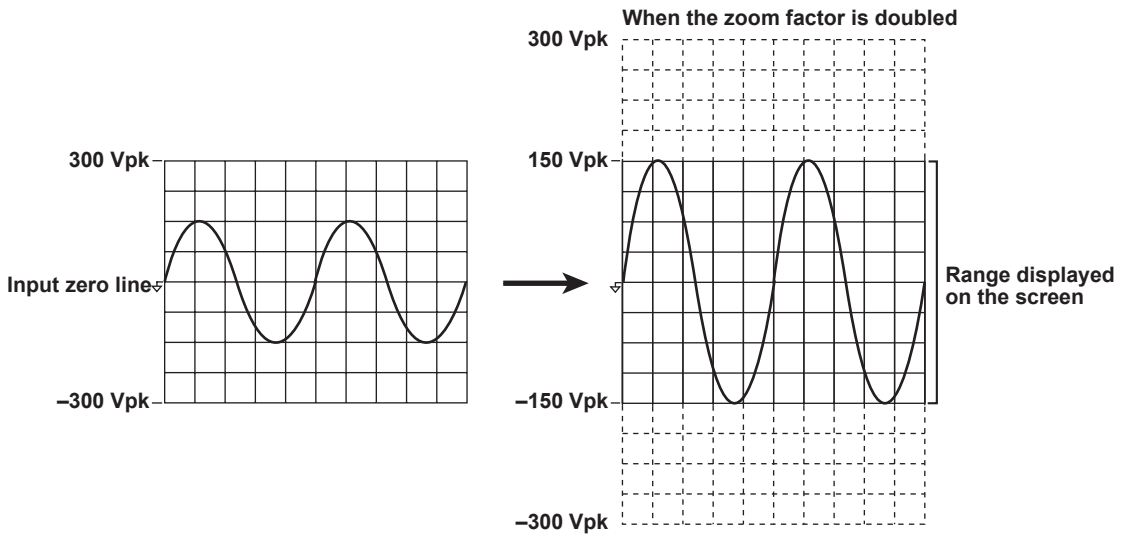

**Vertical Position of the Waveform «For procedures, see section 6.5.»**

The displayed position of the waveform can be moved vertically to the desired position such as when you wish to view the mutual relationship between the voltage and current waveforms or when the section of the waveform you wish to view goes out of the display frame.

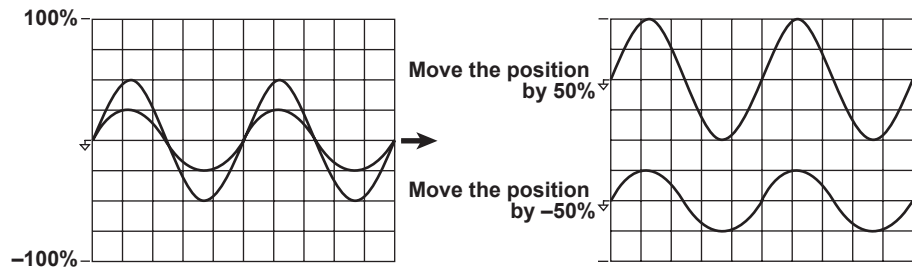

### Split Display of the Waveform and Assignment of Waveforms «For procedures, see section 6.6.»

The screen can be evenly divided and the waveforms can be assigned to the divided windows. The screen can be divided into up to four windows. This function is useful when there are many waveforms on the screen. You can select the method of assignment from the choices below:

- Auto  
The waveforms that are turned ON are assigned in order according to the element number to the divided windows, voltage first and then current.
- Fixed  
The waveforms are assigned in order by element number in the order voltage and current to the divided windows regardless of whether or not the display is turned ON.
- User  
The waveforms can be assigned arbitrarily to the divided windows regardless of whether or not the display is turned ON.

### Display Interpolation of the Waveform «For procedures, see section 6.7.»

The waveform display data can be connected linearly to display the waveform smoothly.

- **Linear Interpolation**  
Linearly interpolates between two points.

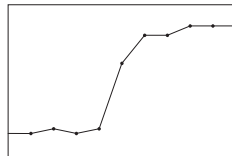

- **Interpolation OFF**  
No interpolation is performed. Only the data points are displayed.

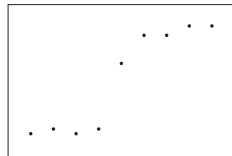

### Graticule «For procedures, see section 6.7.»

A grid or cross scale can be displayed on the screen. You can also select not to display the grid or cross scale.

### Displaying Scale Values «For procedures, see section 6.8.»

The upper and lower limits of the vertical axis and the values at the left and right ends of the horizontal axis (time axis) of each waveform can be turned ON or OFF.

**Displaying Waveform Labels «For procedures, see section 6.8.»**

Waveform labels can be turned ON or OFF.

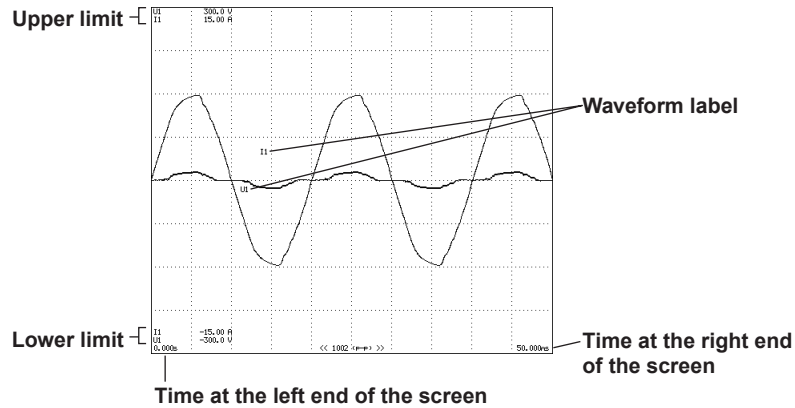

**Cursor Measurement «For procedures, see sections 6.9 and 7.8.»**

The value at the crossing point of the waveform and cursor can be measured and displayed. It can be used to measure the voltage and current of various sections of the waveform and the data on the horizontal axis (X-axis). Cursor measurements are performed on the data that is displayed on the screen.

Cursors are the “+” and “x” marks that are displayed on the screen. The vertical value and the X-axis value from the left end of the screen for each cursor can be measured. In addition, the difference in the vertical values and in the X-axis values between the cursors can be measured.

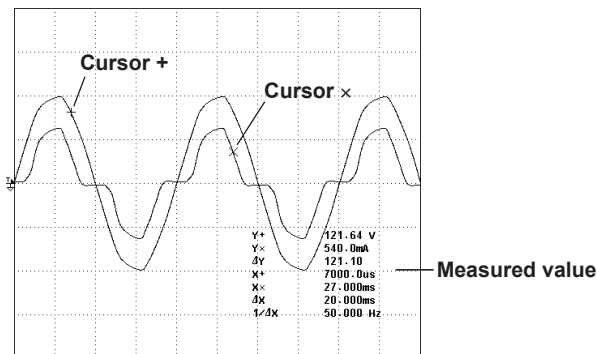



## 2.8 Trend, Bar Graph, and Vector Displays

Trends of each measurement function, bar graphs of harmonics of each order, and vectors of the fundamental signal of each element (when using the harmonic measurement option) can be displayed.

### Trend display

The trends of all measurement functions that are measured during normal measurement and harmonic measurement are displayed.

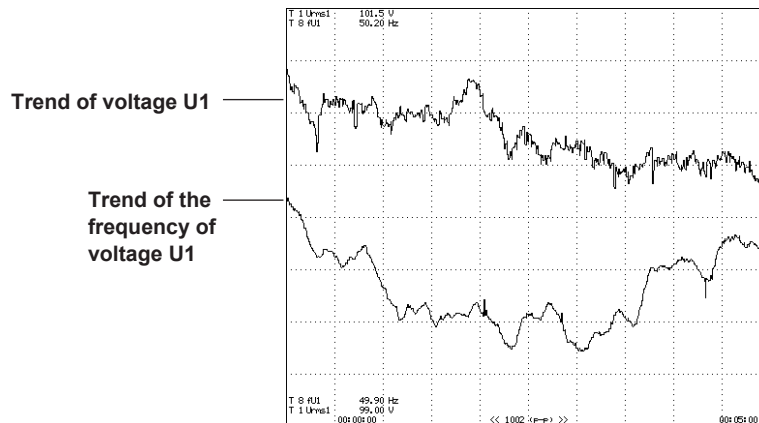

- **Trend Display Data**

When the retrieval of waveform display data is OFF during normal measurement, the numeric data of measurement functions that are determined for each data update rate is P-P compressed\* for each display segment (raster) and made into trend display data.

When the retrieval of waveform display data is ON during normal measurement, the numeric data of measurement functions that are determined each time a trigger occurs is P-P compressed\* for each display segment (raster) and made into trend display data.

\* In some cases, P-P compression is not performed.

- **Horizontal (Time) Axis «For procedures, see section 7.4.»**

The time per division can be set in the range of 3 s to 1 day.

- **Setting the Scale «For procedures, see section 7.5.»**

Auto scaling is provided in which the upper and lower limits of the screen are determined automatically from the maximum and minimum values of the trend display data. Manual scaling is also available in which the upper and lower limits can be set arbitrarily as necessary.

- **Split Display Display and Assignments «For procedures, see section 7.6.»**

Up to 16 lines (T1 through T16) of trends can be displayed. You can select the measurement function of any element to be assigned to T1 through T16. During harmonic measurement, you can also specify the harmonic.

The screen is divided up to 4 windows and the trends that are turned ON are assigned to the divided windows in order from T1 through T16.

- **Display Interpolation, Graticule, and Label Display «For procedures, see sections 6.6 and 6.7.»**

The settings specified for waveform display are used.

**Bar Graph Display of Harmonic Data** «See the *Expansion Function User's Manual IM760301-51E.*»

On models with the advanced computation (/G6) or harmonic measurement (/G5) option, the amplitude of each harmonic can be displayed on the bar graph. The horizontal axis represents harmonic order, and the vertical axis represents the amplitude of each harmonic.

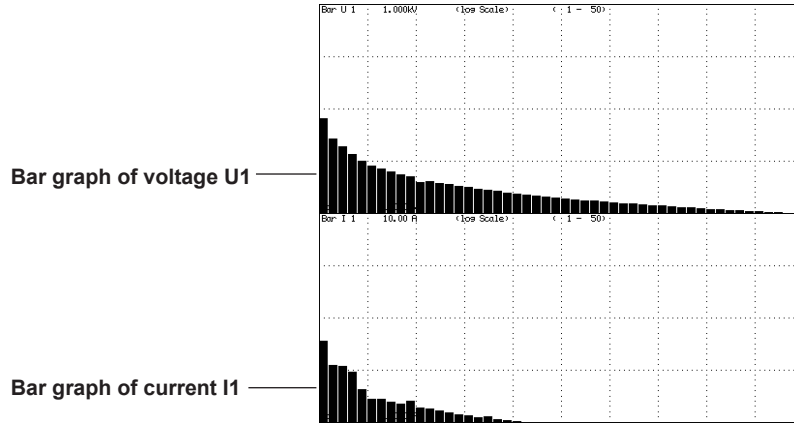

**Vector Display of Harmonics** «See the *Expansion Function User's Manual IM760301-51E.*»

During harmonic measurement on models with the advanced computation (/G6) or harmonic measurement (/G5) option, vectors can be displayed to show the relationship between the phase difference and amplitude (rms value) of the fundamental signals U(1) and I(1) of each element that is assigned to the selected wiring unit.

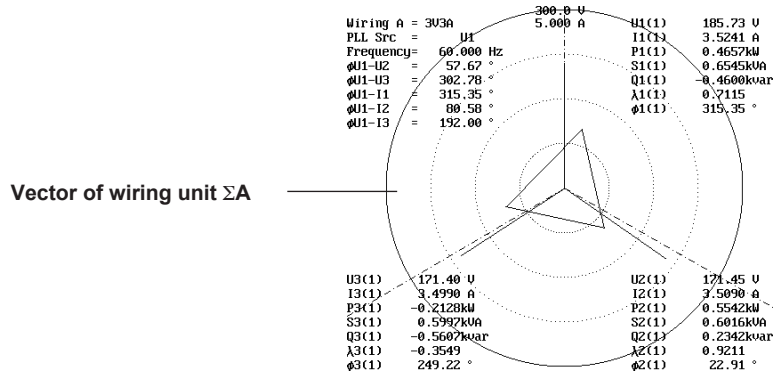

## 2.9 Waveform Computation and FFT

### Waveform Computation «See the *Expansion Function User's Manual IM760301-51E*.»

Various computations can be performed on the waveform data of the input signal on models with the advanced computation (/G6) option. For example, the waveform data of the voltage and current input signals can be multiplied together to display the waveform of instantaneous power.

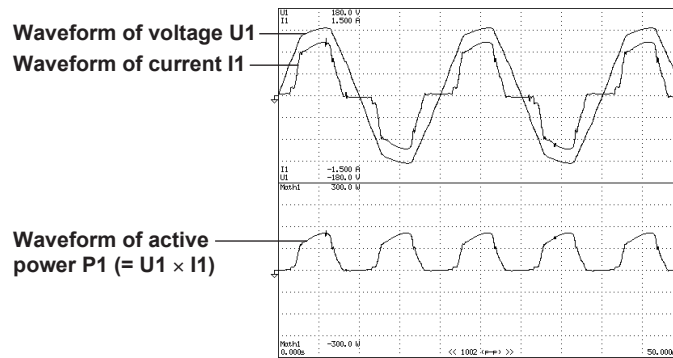

### FFT «See the *Expansion Function User's Manual IM760301-51E*.»

The power spectrum of the input signal can be displayed through FFT (fast Fourier transform) on models with the advanced computation (/G6) option. This is useful when you wish to check the frequency distribution of the input signal.

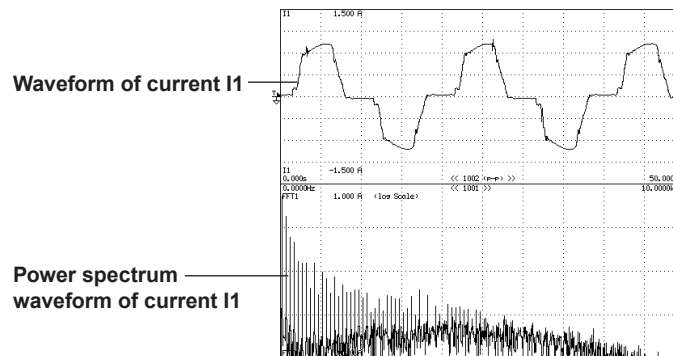

## 2.10 Voltage Fluctuation and Flicker and Cycle-by-Cycle Measurements

### Voltage Fluctuation and Flicker Measurement *Expansion Function User's Manual IM760301-51E.*

Voltage fluctuation and flicker measurements conforming to IEC61000-3-3 can be performed on models with the voltage fluctuation and flicker measurement (/FL) option.

Flicker Mode Uover: ■ ■ ■ ■ Spd: ■ U1-4 : 300V  
Iover: ■ ■ ■ ■ Trq: ■ Flicker: Complete 2:00:00

Count **12/12**  
Interval **10m00s/10m00s**  
Element **1**  
Volt Range **300V/50Hz** Element1 Judgement: Pass  
Un (U1) **0.23077kV** Total Judgement: Pass  
Freq(U1) **49.998 Hz** (Element1)

	dc[%]	dmax[%]	d(t)[ms]	Pst	Plt
Limit	3.30	4.00	500 3.30(%)	1.00	0.65 N:12
No. 1	0.34 Pass	0.60 Pass	0 Pass	0.37 Pass	
2	1.54 Pass	1.94 Pass	0 Pass	0.41 Pass	
3	0.24 Pass	0.44 Pass	0 Pass	0.23 Pass	
4	0.21 Pass	0.48 Pass	0 Pass	0.26 Pass	
5	0.16 Pass	0.41 Pass	0 Pass	0.26 Pass	
6	0.26 Pass	0.48 Pass	0 Pass	0.29 Pass	
7	0.20 Pass	0.46 Pass	0 Pass	0.28 Pass	
8	1.12 Pass	1.45 Pass	0 Pass	0.33 Pass	
9	0.19 Pass	0.54 Pass	0 Pass	0.26 Pass	
10	0.24 Pass	0.43 Pass	0 Pass	0.26 Pass	
11	0.48 Pass	0.57 Pass	0 Pass	0.28 Pass	
12	0.22 Pass	1.17 Pass	0 Pass	0.27 Pass	
Result	Pass	Pass	Pass	Pass	0.30 Pass

### Cycle-by-Cycle Measurement «See the *Expansion Function User's Manual IM760301-51E.*»

The voltage, current, power, and other parameters for each cycle of the AC input signal can be measured on models with the cycle-by-cycle measurement (/CC) option.

Cycle by Cycle Mode Uover: ■ ■ ■ ■ Spd: ■ I1-4 : 500mA Arms  
Iover: ■ ■ ■ ■ Trq: ■ CBC: Complete

Sync Source **U1**  
Cycle Count **100**

No.	Freq[Hz]	U1 [V]	I1 [A]	P1 [W]	S1 [VA]
1	50.000	100.380	↑+ 572.547m	53.1891	57.4721
2	49.975	100.354	569.683m	53.2064	57.1700
3	50.000	100.434	570.109m	53.3339	57.2586
4	50.000	100.423	568.562m	53.1483	57.0965
5	49.988	100.390	568.144m	53.0864	57.0358
6	49.975	100.387	↓- 571.923m	53.1613	57.4137
7	50.000	100.415	568.813m	53.1918	57.1171
8	49.988	100.407	569.107m	53.2024	57.1422
9	50.000	100.410	568.581m	53.1674	57.0912
10	49.963	100.328	↓- 571.212m	53.0456	57.3085
11	50.013	100.383	569.012m	53.2195	57.1190
12	49.988	100.404	569.590m	53.2449	57.1893
13	49.988	100.419	568.745m	53.1938	57.1129
14	49.988	100.425	↓- 571.397m	53.1492	57.3827
15	50.000	100.463	568.506m	53.1801	57.1140
16	49.988	100.426	568.047m	53.1140	57.0465
17	49.988	100.421	568.742m	53.1842	57.1138
18	49.963	100.373	↓- 572.551m	53.1713	57.4686
19	50.013	100.463	569.249m	53.2619	57.1884
20	49.988	100.434	568.199m	53.1188	57.0665

## 2.11 Saving and Loading Data and Other Functions

### Storing and Recalling «For procedures, see chapter 8.»

The numeric data and waveform display data can be stored in the internal memory. The data is stored at the data update rate or a specified time interval to the internal memory. Data stored to the internal memory can be saved on a PC card. The data that is saved to the PC card cannot be recalled.

### Saving and Loading from the Storage Medium «For procedures, see chapter 12.»

The WT3000 comes standard with a PC card drive. A USB port (peripheral devices) is also available as an option. The numeric data, waveform display data, waveform sampling data, screen image data, and setup parameters can be saved to a PC card or USB memory. The saved setup parameters can be loaded as necessary. The screen image data can be pasted to documents on a word-processing application.

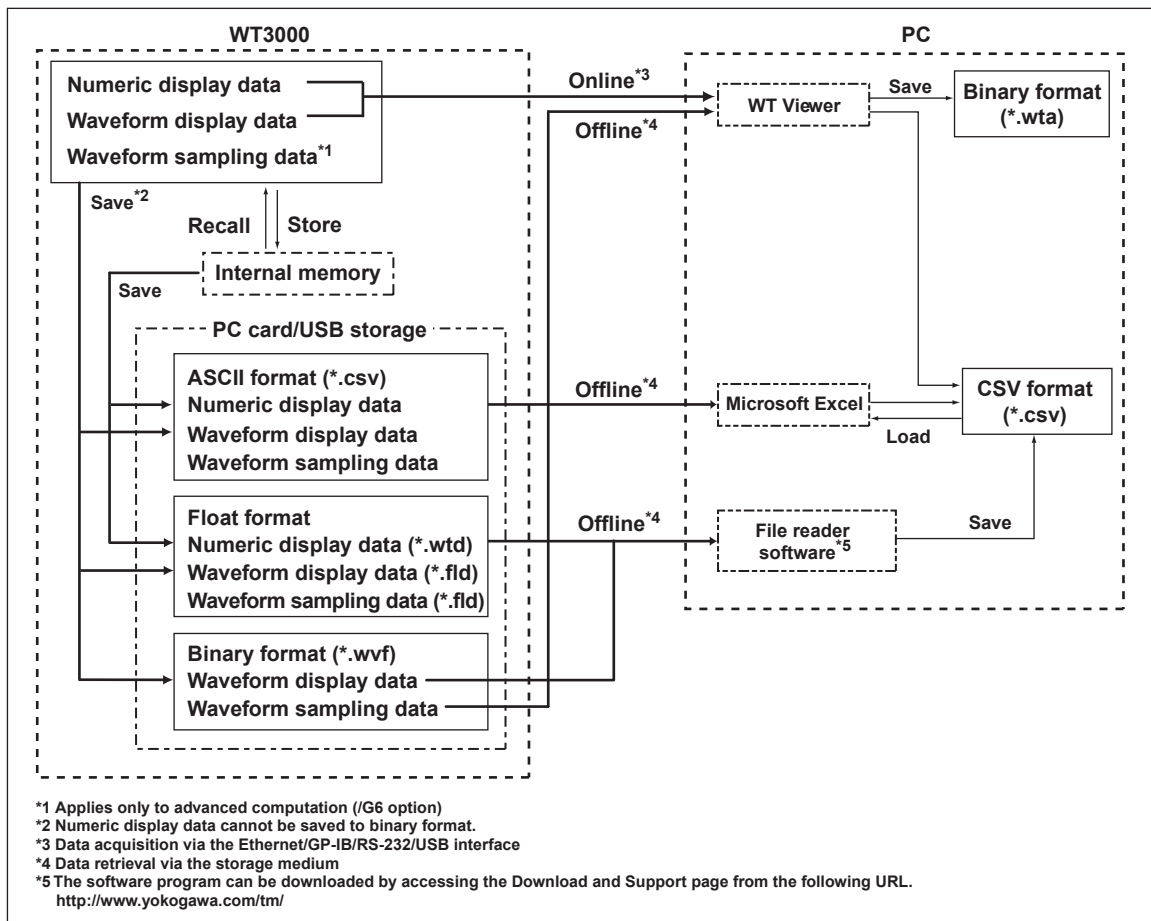
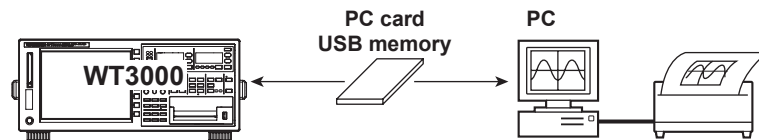

### Printing on the Built-in Printer

The screen image and numeric data list can be printed on the built-in printer (optional). For details, see chapter 2 in the *Expansion Function User's Manual IM760301-51E*.

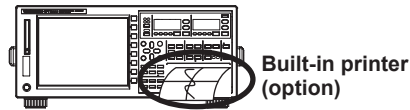

### Ethernet Communication (Option)

The numeric data, waveform display data, screen image data, and setup parameters can be saved to a device connected via the Ethernet interface or information about the WT3000 can be transmitted.

- **Saving and Loading from an FTP Server on the Network (FTP Client Function)**  
The numeric data, waveform display data, screen image data, and setup parameters can be saved to an FTP server\* on the network in the same fashion as the PC card. The saved setup parameters can also be loaded as necessary.

\* PC or workstation on which the FTP server function is running.

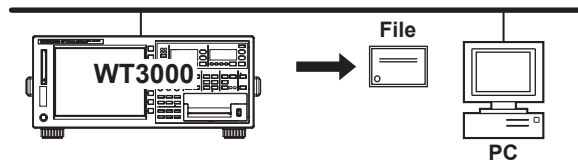

- **Accessing the WT3000 from a PC or Workstation (FTP Server Function)**  
You can access the WT3000 from an FTP client\* on the network and retrieve the files on the PC card of the WT3000 or USB storage (optional). The FTP server function can be used when a PC card or USB storage is connected to the WT3000.

\* A PC or workstation on which the FTP client function is running.

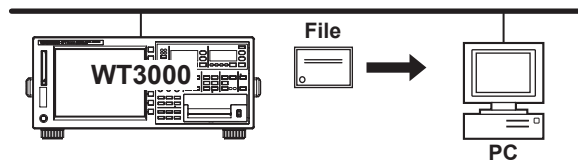

- **Printing on a Network Printer (LPR Client Function)**  
The screen image can be printed on a network printer in the same fashion as the built-in printer.

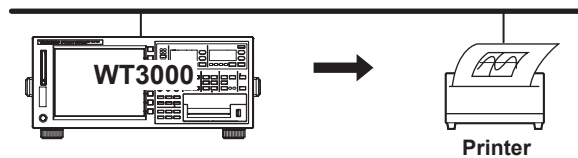

- **Sending Mail (SMTP Client Function)**  
The information of the WT3000 can be transmitted periodically to a specified mail address.

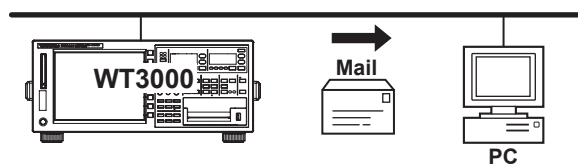

**GP-IB/Serial/USB Communication «See the *Communication Interface User's Manual IM760301-17E.*»**

The measured data can be transferred via the GP-IB interface (standard equipped), the serial interface (conforming to EIA-574 (9-pin EIA-232 (RS-232)), option), or the USB port (option) to a PC for analysis or an external controller can be used to control the instrument for making measurements.

**Entering Values and Strings on the USB Keyboard «For procedures, see section 3.15»**

You can connect a USB keyboard to the USB port (peripheral device) (option) and enter file names, comments, and so on.

**D/A Output (Option) «See the *Expansion Function User's Manual IM760301-51E.*»**

The numeric data can be output using a  $\pm 5$  V FS DC analog voltage. A maximum of 20 items can be set.

**RGB Video Signal (VGA) Output (Option) «See the *Expansion Function User's Manual IM760301-51E.*»**

The RGB video signal (VGA, Video Graphics Array) can be output to an external monitor. This allows values and waveforms to be displayed on a large screen.

**Initialization «For procedures, see section 3.13.»**

The settings entered using keys and soft keys can be restored to factory default settings. For details on the initial settings, see appendix 2, "List of Initial Settings and Display Order of Numeric Data."

**Selecting the Message Language «For procedures, see section 3.17.»**

The language of the error messages displayed on the screen during operation can be set to English or Japanese.

**Selecting the Menu Language «For procedures, see section 3.17.»**

The language of the software menus displayed on the screen can be set to English or Japanese.

**Checking the System Conditions «For procedures, see section 11.4.»**

The instrument configuration such as the model, firmware version (ROM version), input element configuration, and installed options can be checked.

**Zero-Level Compensation «For procedures, see section 10.1.»**

Zero-level compensation refers to creating a zero input condition inside the WT3000 and setting the level at that point as the zero level. Zero-level compensation must be performed in order to satisfy the specifications of this instrument (see chapter 12). Zero-level compensation is automatically performed when the measurement range or input filter is changed. However, if the measurement range, and input filter are not changed over an extended time, the zero level may change due to the changes in the environment surrounding the instrument. In such cases, you can manually perform zero-level compensation. There is also a function that automatically performs zero-level compensation during integration.

### **NULL Function «For procedures, see section 10.2.»**

When the NULL function is turned ON, the Udc and Idc (numeric data of the simple average of the voltage and current during normal measurement) are set as NULL values. The NULL values are subtracted from the sampled data of voltage and current. Hence, all measurement functions are affected by the NULL values.

### **Selecting the Sampling Frequency «For procedures, see section 10.3.»**

The WT3000 has three types of sampling frequencies at approximately 200 kHz to prevent the input waveform from being measured as a DC signal due to aliasing (see section 2.7). The sampling frequency can be automatically switched or fixed to one of three types.

### **Setting the Display Font «For procedures, see section 10.4.»**

The text font that is displayed can be selected from two types of fonts.

### **Setting the Brightness of the Screen «For procedures, see section 10.5.»**

The brightness of the LCD monitor can be adjusted.

### **Setting the Display Colors «For procedures, see section 10.6.»**

The colors for graphical elements such as the waveform, background, scale, and cursor and text elements such as the menu and the menu background can be selected. Set the color using a ratio of red (R), green (G), and blue (B).

### **Setting the Key Lock or Shift Lock «For procedures, see section 10.7.»**

Key lock can be used to prevent inadvertent operation errors. Shift lock can be used to reduce the number of times you press the Shift key.

### **Help Function «For the procedure, see section 10.8.»**

A brief explanation on operation or function can be viewed.

### **Master/Slave Synchronized Measurement «For procedures, see section 10.9.»**

With the master instrument outputting a measurement start signal and the slave instrument receiving the signal, synchronized measurement on two instruments can be achieved.

### **Self-Test Function «For procedures, see section 11.3.»**

A self-test can be performed to check whether the instrument is operating properly. Components such as the internal memory (ROM and RAM) and the operation keys can be tested.



## 3.1 Handling Precautions

### Read the Safety Precautions

- **Safety Precautions**  
If you are using this instrument for the first time, make sure to thoroughly read “Safety Precautions” given on pages v and vi.
- **Do Not Remove the Case**  
Do not remove the case from the instrument. Some parts of the instrument use high voltages, which are extremely dangerous. For internal inspection and adjustment, contact your nearest YOKOGAWA dealer.
- **Unplug If Abnormal Behavior Occurs**  
If you notice smoke or unusual odors coming from the instrument, immediately turn OFF the power and unplug the power cord. In addition, turn OFF the power to the circuit under measurement that is connected to the input terminals. If these symptoms occur, contact your nearest YOKOGAWA dealer.
- **Do Not Damage the Power Cord**  
Nothing should be placed on top of the power cord. The power cord should also be kept away from any heat sources. When unplugging the power cord from the outlet, never pull by the cord itself. Always hold and pull by the plug. If the power cord is damaged, check the part number indicated on page iii and purchase a replacement.

### General Handling Precautions

- **Do Not Place Objects on Top of the Instrument**  
Never stack the instruments or place other instruments or any objects containing water on top of the instrument. This may damage the recorder.
- **Keep Electrically Charged Objects Away from the Instrument**  
Keep electrically charged objects away from the input terminals. They may damage the internal circuitry.
- **Do Not Damage the LCD**  
Since the LCD screen is very vulnerable and can be easily scratched, do not allow any sharp objects near it. Also, do not apply vibration or shock to it.
- **Unplug during Extended Non-Use**  
Turn OFF the power to the circuit under measurement and the instrument and remove the power cord from the outlet.
- **Carry the Instrument Properly**  
First, turn OFF the circuit under measurement and remove the measurement cables. Then, turn OFF the instrument and remove power and other cables. When moving the instrument, hold the handle on each side of the instrument as shown below.

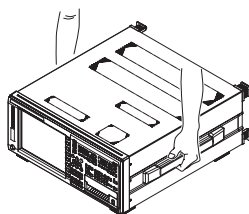

- **When Wiping off Dirt**  
When cleaning the case or the operation panel, first turn OFF the circuit under measurement and the instrument and remove the instrument's power cord from the outlet. Do not use volatile chemicals since this might cause discoloring and deformation.

---

## 3.2 Installing the Instrument

---

### WARNING

- This instrument is designed to be used indoors. Do not install or use it outdoors.
  - Install the instrument so that you can immediately remove the power cord if an abnormal or dangerous condition occurs..
- 

---

### CAUTION

If you block the inlet or outlet holes on the WT3000, the WT3000 will become hot and may break down.

---

### Installation Conditions

Install the instrument indoors that meets the following conditions.

- **Flat, Even Surface**

If the instrument is not installed on a stable horizontal surface, the printer's recording quality may degrade and precise measurements may be impeded.

- **Well-Ventilated Location**

Inlet/Vent holes are located on the top and bottom of the instrument. To prevent internal overheating, allow at least 20 mm of space around the inlet and vent holes.

When connecting measurement wires and other various cables or when opening or closing the built-in printer cover, allow extra space for operation.

- **Ambient Temperature and Humidity**

Ambient temperature: 5 to 40° C

Ambient humidity: 20 to 80%RH (when the printer is not used)

35 to 80%RH (when using the printer)

No condensation in either case.

- **Do not install the instrument in the following places:**

- Outdoors.
- In direct sunlight or near heat sources.
- Where the instrument is exposed to water or other liquids.
- Where an excessive amount of soot, steam, dust, or corrosive gas is present.
- Near strong magnetic field sources.
- Near high voltage equipment or power lines.
- Where the level of mechanical vibration is high.
- On an unstable surface.

### Note

- For the most accurate measurements, use the instrument in the following environment.  
Ambient temperature: 23±5°C Ambient humidity: 30 to 75%RH (no condensation)  
When using the instrument in a place where the ambient temperature is 5 to 18°C or 28 to 40°C, add the temperature coefficient to the accuracy as specified in chapter 12.
  - When installing the instrument in a place where the ambient humidity is 30% or below, take measures to prevent static electricity such as using an anti-static mat.
  - Condensation may occur if the instrument is moved to another place where the ambient temperature is higher, or if the temperature changes rapidly. In this case, let the instrument adjust to the new environment for at least one hour before using the instrument.
-

## Storage Location

When storing the instrument, avoid the following places:

- Where the relative humidity is 80% or more.
- In direct sunlight.
- Where the temperature is 60° C or higher.
- Near a high humidity or heat source.
- Where the level of mechanical vibration is high.
- Where corrosive or explosive gas is present.
- Where an excessive amount of soot, dust, salt, and iron are present.
- Where water, oil, or chemicals may splash.

It is recommended that the instrument be stored in an environment where the temperature is between 5 and 40° C and the relative humidity is between 20 and 80% RH.

## Installation Position

### • Desktop

Place the instrument on a flat, even surface as shown in the figure below. If the instrument is installed in a horizontal position, rubber stoppers can be attached to the feet to prevent the instrument from sliding. Two sets (four pieces) of rubber feet are included in the package.

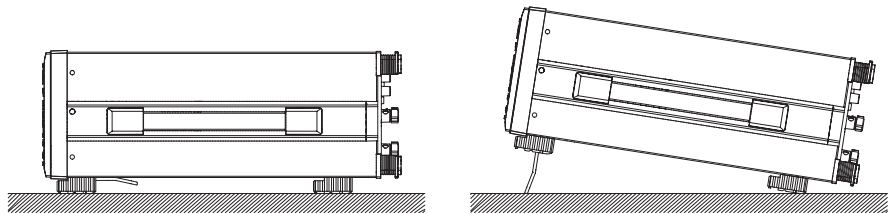

### • Rack Mount

To rack mount the instrument, use the rack mount kit that is sold separately.

Part Name	Model	Note
Rack mount kit	751535-E4	For EIA
Rack mount kit	751535-J4	For JIS

An outline of the attachment procedures is given below. For details regarding the attachment procedures, see the instructions that are included with the rack mount kit.

1. Remove the handles from each side of the instrument.
2. Remove the four feet from the bottom of the instrument.
3. Remove the two plastic rivets and the four seals covering the rack mount attachment holes on each side of the instrument near the front.
4. Place seals over the feet and handle attachment holes.
5. Attach the rack mount kit.
6. Mount the instrument on the rack.

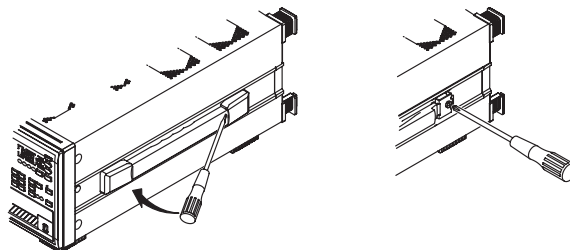

### Note

- When rack mounting the instrument, allow at least 20 mm of space around the inlet and vent holes to prevent internal overheating.
- Make sure to provide adequate support from the bottom of the instrument. But, do not block the inlet or vent holes in the process.

## 3.3 Connecting the Power Supply

### Before Connecting the Power Supply

To prevent the possibility of electric shock and damage to the instrument, follow the warnings below.



#### WARNING

- Make sure that the power supply voltage matches the instrument's rated supply voltage and that it does not exceed the maximum voltage range specified for the power cord.
- Connect the power cord after checking that the power switch of the instrument is turned OFF.
- To prevent electric shock or fire, always use the power cord supplied by YOKOGAWA.
- Make sure to perform protective grounding to prevent the possibility of electric shock. Connect the power cord to a three-prong power outlet with a protective earth terminal.
- Do not use an extension cord without protective earth ground. Otherwise, the protection function will be compromised.
- Use an AC outlet that complies with the power cord provided and securely connect the protective grounding. If such an AC outlet is unavailable and protective grounding cannot be furnished, do not use the instrument.

### Connecting the Power Cord

1. Check that the power switch is OFF.
2. Connect the power cord plug to the power connector on the rear panel. (Use the power cord that comes with the package.)
3. Connect the plug on the other end of the power cord to the outlet that meets the conditions below. The AC outlet must be of a three-prong type with a protective earth ground terminal.

Item	Specifications
Rated supply voltage	100 to 240 VAC
Permitted supply voltage range	90 to 264 VAC
Rated power supply frequency	50/60 Hz
Permitted supply voltage frequency range	48 to 63 Hz
Maximum power consumption (when using the printer)	150 VA

\* The instrument can use a 100-V or a 200-V system for the power supply. Check that the voltage supplied to the instrument is less than or equal to the maximum rated voltage of the provided power cord (see page iii) before using it.

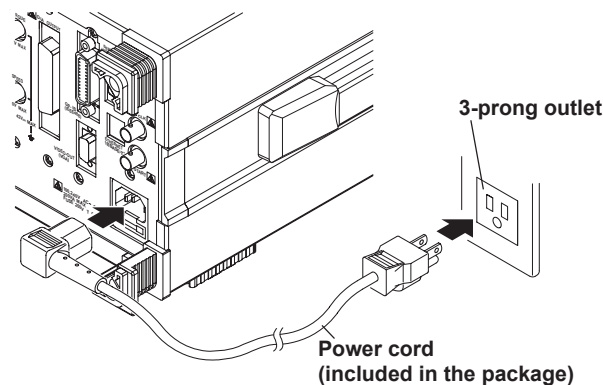

## 3.4 Turning ON/OFF the Power Switch

### Items to Be Checked before Turning ON the Power

- Check that the instrument is installed properly (see section 3.2, “Installing the Instrument”).
- Check that the power cord is connected properly (see section 3.3, “Connecting the Power Supply”).

### Location of the Power Switch

The power switch is located in the lower left corner of the front panel.

### Turning the Power Switch ON/OFF

The power switch is a push button. Press the button once to turn it “ON” and press it again to turn it “OFF.”

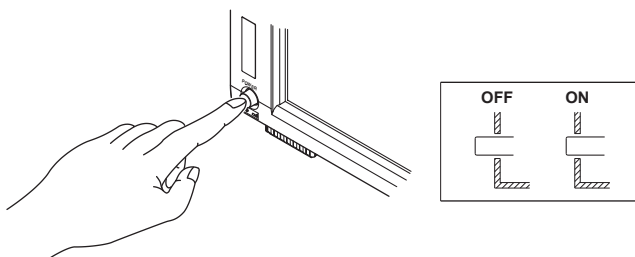

### Power ON Operation

When the power switch is turned ON, the self-test starts automatically. When the self-test completes successfully, the display shows the screen that was displayed immediately before the power switch was turned OFF. Before using the instrument, check that the self-test completes successfully.

#### When the Power-on Operation Does Not Finish Normally

Turn OFF the power switch and check the following points.

- That the power cord is securely connected.
- That the correct voltage is coming to the power outlet (see section 3.3, “Connecting the Power Supply”).
- That the fuse is not blown (see section 11.5, “Replacing the Power Fuse”).
- If the power switch is turned ON while holding down RESET, the setup parameters are initialized to their factory default values. For the initial settings, see appendix 3.13.

If the instrument still does not work properly when the power switch is turned ON after checking these items, contact your nearest YOKOGAWA dealer for repairs.

#### For Making Accurate Measurements

- Allow the instrument to warm up for at least 30 minutes after turning ON the power switch.
- Perform zero-level compensation after warm-up (see section 10.1, “Performing Zero-Level Compensation”).

#### Shutdown Operation

The setup parameters that exist immediately before the power switch is turned OFF are stored in memory. The same is true when the power cord gets disconnected from the outlet. The next time the power switch is turned ON, the instrument powers up using the stored setup parameters.

#### **Note**

---

A lithium battery is used to retain the setup parameters. When the lithium battery voltage falls below a certain level, a message is displayed on the screen (see section 11.2) when the power switch is turned ON. If this message appears frequently, the battery must be replaced quickly. The user cannot replace the battery. Contact your nearest YOKOGAWA dealer to have the battery replaced. For information regarding battery life, see section 11.6.

---

## 3.5 Wiring Precautions

To prevent the possibility of electric shock and damage to the instrument, follow the warnings below.



### WARNING

- Employ protective earth ground before connecting measurement cables. The power cord that comes with the instrument is a three-pin type power cord. Connect the power cord to a properly grounded three-prong outlet.
- Turn OFF the power to the circuit under measurement, when wiring or disconnecting the circuit. Connecting or removing measurement cables while the power is ON is dangerous.
- Take special caution not to wire a current circuit to the voltage input terminal or a voltage circuit to the current input terminal.
- Strip the insulation cover of the measurement cable so that when it is wired to the input terminal, the conductive parts (bare wires) do not protrude from the terminal. Also, make sure to fasten the input terminal screws securely so that the cable does not come loose.
- Use cables with safety terminals that cover the conductive parts for connecting to the voltage input terminals. Using a terminal with bare conductive parts (such as a banana plug) is dangerous if the terminal comes loose.
- Use cables with safety terminals that cover the conductive parts for connecting to the current sensor input terminals. Using a terminal with bare conductive parts is dangerous if the terminal comes loose.
- When the voltage of the circuit under measurement is being applied to the current input terminals, do not touch the current sensor input terminals. Since these terminals are electrically connected inside the instrument, this act is dangerous.
- When connecting measurement cables from an external current sensor to the current sensor input connector, remove the cables connected to the current input terminals. In addition, when the voltage of the circuit under measurement is being applied to the current sensor input terminal, do not touch the current input terminals. Since these terminals are electrically connected inside the instrument, this act is dangerous.
- When using the external voltage transformer (VT) or current transformer (CT), make sure it has enough withstand voltage with respect to the voltage (U) being measured ( $2U + 1000$  V recommended). Also, make sure that the secondary side of the CT does not become an open circuit while the power is being applied. If this happens, high voltage will appear at the secondary side of the CT, making it extremely dangerous.
- When applying a current exceeding 10 A from a current transformer (CT) to this instrument, provide protection.
- When using an external current sensor, make sure to use a sensor that comes in a case. The conductive parts and the case should be insulated, and the sensor should have enough withstand voltage with respect to the voltage being measured. Using a bare sensor is dangerous, because you might accidentally come in contact with it.
- When using a shunt-type current sensor as an external current sensor, turn OFF the circuit under measurement. Connecting or removing a sensor while the power is ON is dangerous.
- When using a clamp-type current sensor as an external current sensor, have a good understanding of the voltage of the circuit under measurement and the specifications and handling of the clamp-type sensor. Then, confirm that there are no shock hazards.
- For safety reasons, when using the instrument on a rack mount, furnish a switch for turning OFF the circuit under measurement from the front side of the rack.

### 3.5 Wiring Precautions

---

- After connecting the measurement cable, attach the current input protection cover using the screws provided for your safety (screw tightening torque: 0.6 N•m). Make sure that the conductive parts are not exposed from the protection cover.
- To make the protective functions effective, check the following items before applying the voltage or current of the circuit under measurement.
  - That the power cord provided with the instrument is used to connect to the power supply and the instrument is grounded.
  - That the power switch of the instrument is turned ON.
  - That the current input protective cover provided with the instrument is being used.
- When the power switch of the instrument is turned ON, do not apply a signal that exceeds the following values to the voltage or current input terminals. When the instrument is turned OFF, turn OFF the circuit under measurement. For a description of other input terminals, see the specifications of each module in chapter 12.

#### **Instantaneous Maximum Allowable Input (1 s or less)**

---

##### **Voltage Input**

Peak value of 2500 V or RMS value of 1500 V, whichever is less.

---

##### **Current Input**

###### **Direct Input**

2-A input element

Peak value of 9 A or RMS value of 3 A, whichever is less.

30-A input element

Peak value of 150 A or RMS value of 50 A, whichever is less.

###### **External Sensor Input**

Peak value less than or equal to 10 times the range.

---

#### **Continuous Maximum Allowable Input**

---

##### **Voltage Input**

Peak value of 1600 V or RMS value of 1100 V, whichever is less.

---

##### **Current Input**

###### **Direct Input**

2-A input element

Peak value of 6 A or RMS value of 2.2 A, whichever is less.

30-A input element

Peak value of 90 A or RMS value of 33 A, whichever is less.

###### **External Sensor Input**

Peak value less than or equal to 5 times the range.

---

---

---

### **CAUTION**

---

- Use measurement cables that have adequate margins of withstand voltage and current capacity with respect to the voltage or current being measured. It should also have proper ratings that are suited to the measurement.  
Example: When making measurements on a current of 20 A, use copper wires that have a conductive cross-sectional area of 4 mm<sup>2</sup>.
  - Connecting cables may cause radio interference in which case the user is required to correct the interference.
-



#### **Note**

- After wiring, the wiring system must be selected. See section 4.1, "Selecting the Wiring System."
  - When measuring large currents, voltages or currents that contain high frequency components, take special care in dealing with mutual interference and noise when wiring.
  - Keep the measurement cables as short as possible to minimize the loss between the circuit under measurement and the instrument.
  - The thick lines on the wiring diagrams shown in sections 3.9 to 3.11 are the sections where the current flows. Use appropriate wires that are suitable for the current.
  - In order to make accurate measurements of the voltage of the circuit under measurement, connect the cable to the circuit as closely as possible.
  - In order to make correct measurements, separate the measurement cables as far away from the earth ground wires and the instrument's case as possible to minimize the static capacitance to earth ground.
  - To measure the apparent power and power factor more accurately on an unbalanced three-phase circuit, it is recommended that a three-voltage, three-current system using three-phase, three-wire 3P3W (3V3A) be used to make the measurement.
  - If you supply current exceeding approximately 2.8 Arms to the 2-A input element, the protection circuit activates and bypasses the measurement circuit of the WT3000. This prevents damage to the measurement circuit. Because current does not flow through the measurement circuit of the WT3000, the measured value may become 0 A, but the input peak over-range indicator at the top section of the screen illuminates in red. If this happens, the measured value is approximately 0 A, but current is actually flowing through the circuit under measurement. Therefore, do not disconnect the wires to the measurement terminals.
-

## 3.6 Assembling the Adapter to Be Connected to the Voltage Input Terminal

### Assembling the 758931 Safety Terminal Adapter

When connecting a measurement cable to the voltage input terminal of the WT3000, use the 758931 Safety Terminal Adapter that comes with the package or the 758923 Safety Terminal Adapter that is sold separately. When using the 758931 Safety Terminal Adapter, assemble it according to the following procedure.

- **Assembling the Safety Terminal Adapter**

1. Remove approximately 10 mm of the covering from the end of the cable and pass it through the internal insulator.

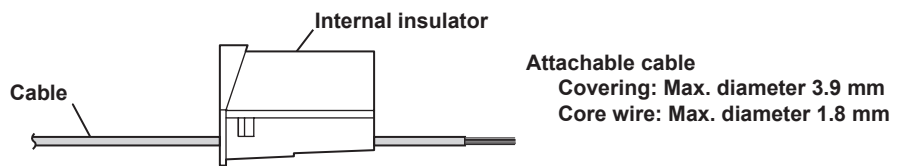

2. Insert the tip of the cable into the plug. Fasten the cable in place using the hexagonal wrench.

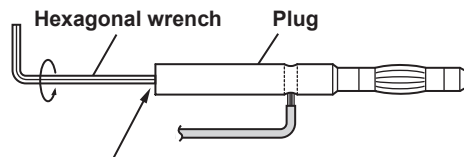

Insert the hexagonal wrench into the plug and tighten

3. Insert the plug into the internal insulator.

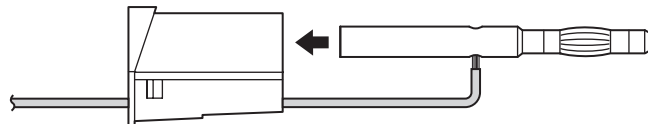

4. Attach the external cover. Check that the cover does not come off.

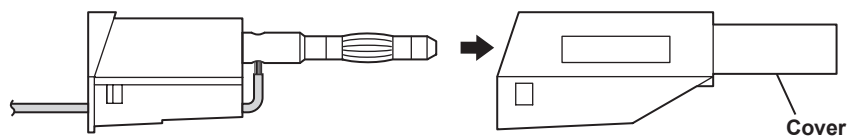

**Note**

Once the cover is attached, disassembly is difficult. Use care when attaching the cover.

Below is an illustration of the adapter when the work is completed.

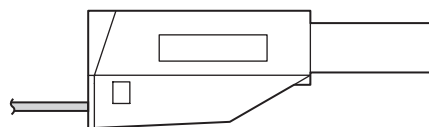

**Explanation**

Use the adapters that come with the WT3000 or the adapters and various sensors sold separately for the WT3000 according to the object being wired as follows:

• **Wiring to the Voltage Measurement Terminal**

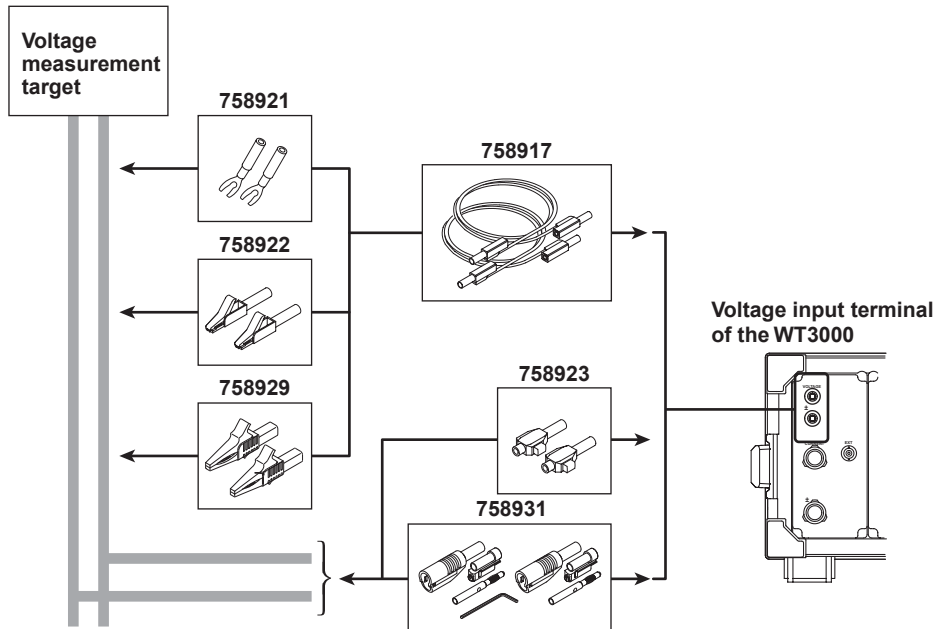

When using the clamp-on probe that is sold separately, use it as follows:

• **Wiring to the Current Measurement Terminal**

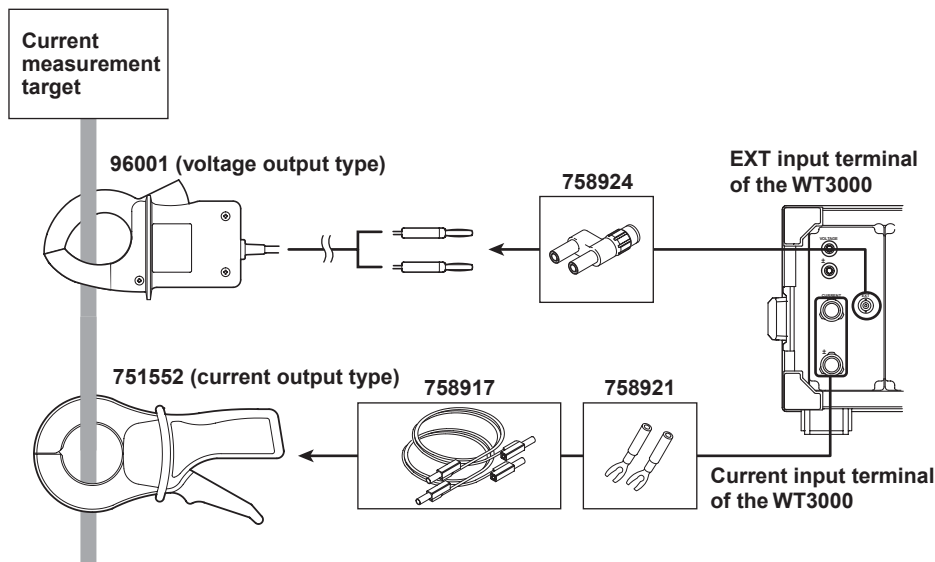

Connecting the clamp-on probe

\* The current input terminal and EXT input terminal cannot be wired (used) simultaneously.

## 3.7 Wiring for Making Accurate Measurements

To make accurate measurements, wire the voltage input terminal and current input terminal by referring to the items below.

- **Effects of Stray Capacitance**

When measuring a single-phase device, the effects of stray capacitance on the measurement accuracy can be minimized by connecting the current input terminal of the instrument to the side that is close to the earth potential of the power source (SOURCE).

- **Easily affected**

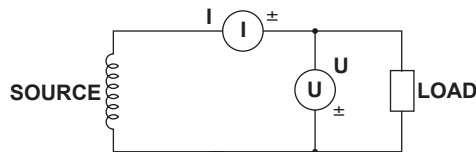

- **Not easily affected**

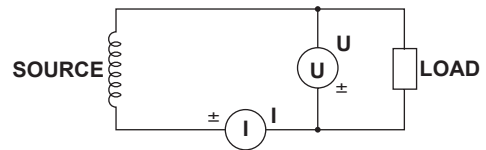

- **Effects due to the Amplitude of the Measured Voltage and Current**

- **When the measurement current is relatively large**

Connect the voltage measurement terminal to the load side.

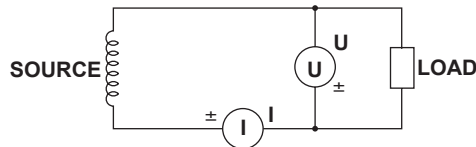

- **When the measurement current is relatively small**

Connect the current measurement terminal to the load side.

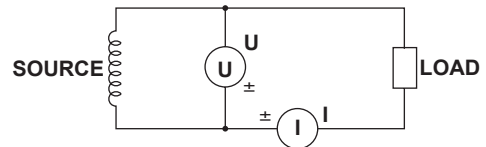

### Explanation

For details on the effects of stray capacitance and the effects due to the amplitude of the measured voltage and current, see appendix 5, "For Making Accurate Measurements."

## 3.8 Guide for Selecting the Method Used to Measure the Power

Select the measurement method according to the amplitude of the measured voltage or current from the table below. For details on the wiring methods, see the respective sections.

- **Measurement Method of Voltage**

		When the voltage is less than or equal to 1000 V	When the voltage exceeds 1000 V
Voltage wiring	Direct input	See section 3.9	Direct input is not possible
	VT (voltage transformer)	See section 3.11	

- **Measurement Method of Current**

		When the voltage is less than or equal to 1000 V		When the voltage exceeds 1000 V
Input element	30 A	When the current is less than or equal to 30 A	When the current exceeds 30 A	
		2 A	When the current is less than or equal to 2 A	When the current exceeds 2 A
Current wiring	Direct input	See section 3.9*	Direct input is not possible	
	Shunt-type current sensor	See section 3.10**		Shunt-type current sensors cannot be used
	Clamp-type current sensor (voltage output type)	See section 3.10		
	Clamp-type current sensor (current output type)	See section 3.11		
	CT (current transformer)	See section 3.11		

\* Voltage: 1000 V or less (maximum allowable voltage that can be measured)  
600 V or less (rating voltage of EN61010-2-030)

Do not touch the inside of the external current sensor input BNC connector.

\*\* The voltage is less than or equal to 600 V.

- **Notes when Replacing Other Power Meters with the WT3000**

In three-phase, three-wire systems (3P3W) and three-phase, three-wire systems [(3P3W) 3V3A] (three-voltage, three-current systems), the wiring system may be different between the WT3000 and another product (another digital power meter) due to the differences in whether the reference voltage used to measure the line voltage (see appendix 4) is of S phase or T phase. To make correct measurements, see the referenced sections in the selection guide above and check the wiring method of the three-phase, three-wire system.

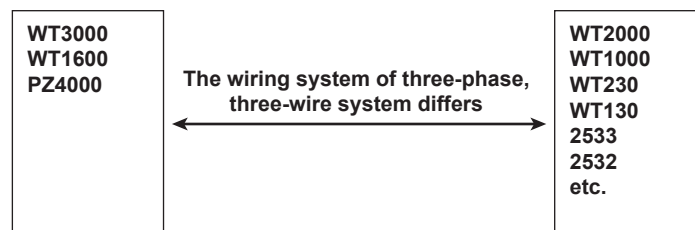

For example, if you replace the WT2000 (used in a three-phase, three-wire system) with the WT3000 and leave the wiring unchanged, the measured power of each element is different between the WT2000 and the WT3000. Refer to this manual and wire the system correctly.

## 3.9 Wiring the Circuit under Measurement for Direct Input

The measurement cable is wired directly from the circuit under measurement to the voltage/current input terminal.

To prevent the possibility of electric shock and damage to the instrument, follow the precautions given in section 3.5, "Wiring Precautions."

### Connecting to the Input Terminal

- **Voltage Input Terminal**

The terminal is a  $\phi 4$ -mm safety banana jack (female).

Insert the safety terminal (the conductive parts are not exposed) into the voltage input terminal. When using the 758931 Safety Terminal Adapter that comes with the package, see section 3.6.

- **Current Input Terminal**

- When the voltage of the circuit under measurement is being applied to the current input terminals, do not touch the current sensor input terminals. Since these terminals are electrically connected inside the instrument, this act is dangerous.

- When connecting measurement cables from an external current sensor to the current sensor input connector, remove the cables connected to the current input terminals. In addition, when the voltage of the circuit under measurement is being applied to the current sensor input terminal, do not touch the current input terminals. Since these terminals are electrically connected inside the instrument, this act is dangerous.

- The terminal is a binding post, and the screws are M6. Either wind the wire around the screw or pass the crimp-on lugs through the screw axis, then tighten firmly by holding the terminal knob.

### CAUTION

- When doing so, make sure that no foreign objects are present in the contacts between the current input terminal and crimp-on lugs.
- Periodically check whether the current input terminal knob is loose, and whether any foreign objects are present in the contacts between the current input terminal and crimp-on lugs.

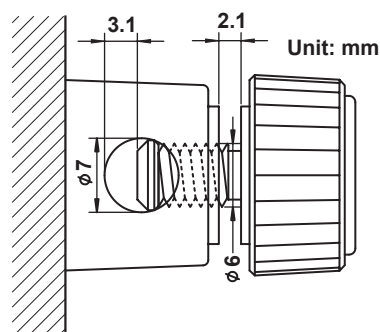

### Number of Installed Input Elements and Wiring Systems

Limitations are placed on the wiring systems that can be selected depending on the number of input elements that are installed in the instrument. For example, three-phase, four-wire (3P4W) cannot be selected on models with two input elements. For details, see "Number of Installed Input Elements and Wiring Systems" in section 2.3, "Measurement Conditions."

The assignment of elements to the input terminals in the figures of the wiring examples below varies depending on the number of installed input elements. For details, see “Number of Installed Input Elements and Wiring Systems” in section 2.3, “Measurement Conditions.”

**Note**

- After wiring, the wiring system must be selected. See section 4.1, “Selecting the Wiring System.”
- The thick lines on the wiring diagrams are the sections where the current flows. Use appropriate wires that are suitable for the current.

**Wiring Example of a Single-Phase, Two-Wire System (1P2W)**

If four input elements are available, four single-phase, two-wire systems can be set up. See section 3.7 for details on which wiring system below should be selected.

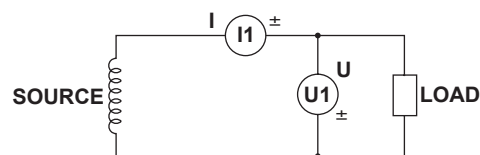
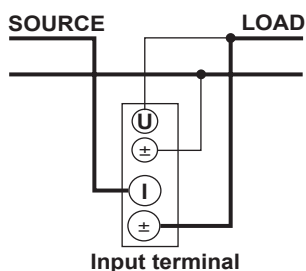
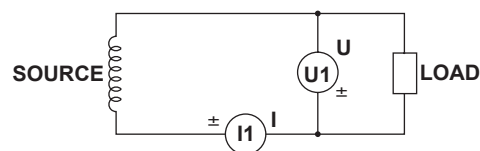
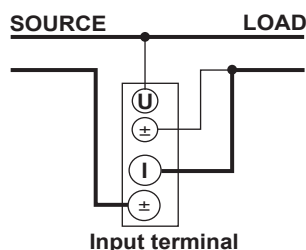

**Wiring Example of a Single-Phase, Three-Wire System (1P3W)**

If four input elements are available, two single-phase, three-wire systems can be set up (elements 1 and 2 and elements 3 and 4).

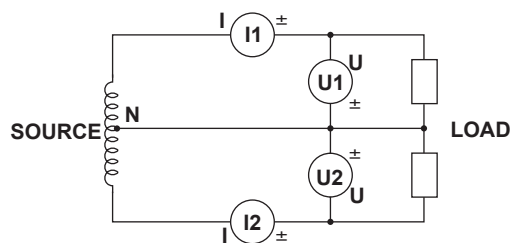
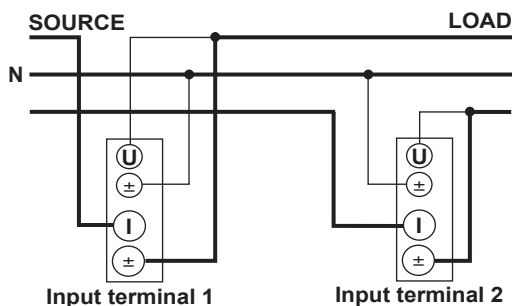

**3.9 Wiring the Circuit under Measurement for Direct Input**

**Wiring Example of a Three-Phase, Three-Wire System (3P3W)**

If four input elements are available, two three-phase, three-wire systems can be set up (elements 1 and 2 and elements 3 and 4).

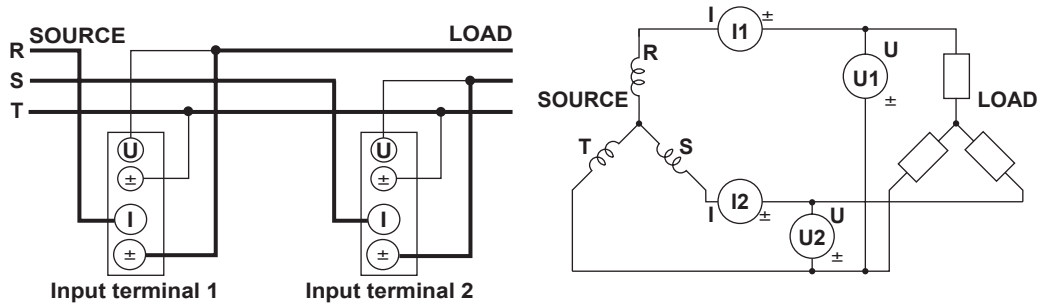

**Wiring Example of Three-Phase, Three-Wire (Three-Voltage, Three-Current System) [3P3W (3V3A)]**

If four input elements are available, one three-phase, three-wire system (three-voltage, three-current system) can be set up (elements 1, 2, and 3 or elements 2, 3, and 4).

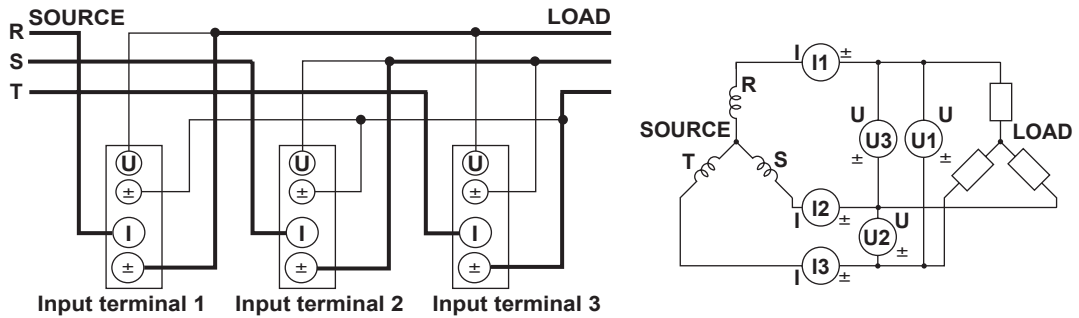

**Wiring Example of a Three-Phase, Four-Wire System (3P4W)**

If four input elements are available, one three-phase, four-wire system can be set up (elements 1, 2, and 3 or elements 2, 3, and 4).

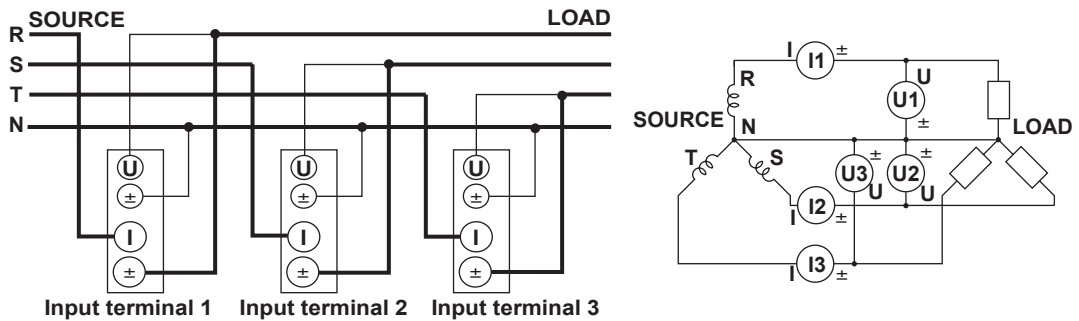

**Note**

For the relationship between the wiring systems and the method of determining the measured values or computed values, see Appendix 1, "Symbols and Determination of Measurement Functions."



## 3.10 Wiring the Circuit under Measurement When Using the Current Sensor

To prevent the possibility of electric shock and damage to the instrument, follow the precautions given in section 3.5, “Wiring Precautions.”

If the maximum current value of the circuit under measurement exceeds the maximum range of the current input terminal as described below, an external sensor can be connected to the current sensor input connector in order to measure the current of the measurement circuit.

- 2-A input element  
When the maximum current exceeds 2 Arms
- 30-A input element  
When the maximum current exceeds 30 Arms

### Current sensor output type

- In the wiring example in this section, a shunt-type current sensor or a clamp-type current sensor that outputs voltage can be used for an external current sensor.
- When using the clamp-type current sensor that outputs current, see section 3.11.

### Connecting to the Input Terminal

#### • Voltage Input Terminal

The terminal is a  $\phi 4$ -mm safety banana jack (female).

Insert the safety terminal (the conductive parts are not exposed) into the voltage input terminal.

When using the 758931 Safety Terminal Adapter that comes with the package, see section 3.6.

#### • External Current Sensor Input Terminal

Connect an external sensor cable with the BNC connector (B9284LK, sold separately) to the external current sensor input connector.

Remove the measurement cable connected to the current input terminal. Because the current sensor input terminal and the current input terminal are connected internally, connecting both terminals simultaneously not only results in measurement errors but also may cause damage to the instrument.

In addition, when the voltage of the circuit under measurement is being applied to the current sensor input terminal, do not touch the current input terminals. Since these terminals are electrically connected inside the instrument, this act is dangerous.

### Number of Installed Input Elements and Wiring Systems

The selectable wiring systems vary depending on the number of input elements that are installed in the instrument. For details, see “Number of Installed Input Elements and Wiring Systems” in section 2.3, “Measurement Conditions.”

### 3.10 Wiring the Circuit under Measurement When Using the Current Sensor

**Note**

- After wiring, the wiring system must be selected. See section 4.1, “Selecting the Wiring System.”
- The thick lines on the wiring diagrams are the sections where the current flows. Use appropriate wires that are suitable for the current.
- To measure the apparent power and power factor more accurately on an unbalanced three-phase circuit, it is recommended that a three-phase, three-wire system (three-voltage, three-current system) [3P3W (3V3A)] be used to make the measurement.
- The current sensor input transformation function can be used to transform the input signal to data that correspond to direct measurements. For the setup procedure, see section 4.4, “Setting the Measurement Range When Using the Current Sensor.”
- Note that the frequency and phase characteristics of the current sensor affect the measured data.
- Make sure you have the polarities correct when making the connections. Otherwise, the polarity of the measurement current will be reversed and correct measurements cannot be made. Be especially careful when connecting the clamp type current sensor, because it is easy to reverse the connection.
- To minimize error when using a shunt-type current sensor, note the following points when connecting the external sensor cable.
  - Connect the shielded wire of the external sensor cable to the L side of the shunt output terminal (OUT).
  - Minimize the area created between the wires connecting the current sensor to the external sensor cable. The effects due to the line of magnetic force (caused by the measurement current) and noise that enter this area of space can be reduced.

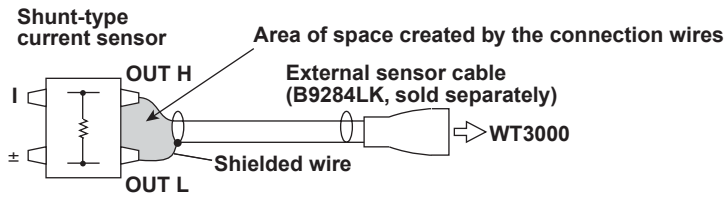

- For a shunt-type current sensor, connect it to the power earth ground side as shown in the figure below. If you have to connect the sensor to the non-earth side, use a wire that is thicker than AWG18 (conductive cross-sectional area of approx. 1 mm<sup>2</sup>) between the sensor and the instrument to reduce the effects of common mode voltage. Take safety and error reduction into consideration when constructing an external sensor cable.

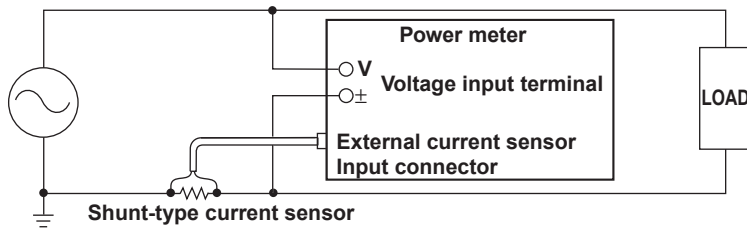

- When the circuit under measurement is not grounded and the signal is high in frequency or large in power, the effects of the inductance of the connection cable for the shunt-type current sensor become large. In this case, use an isolation sensor (CT, DC-CT, or clamp).

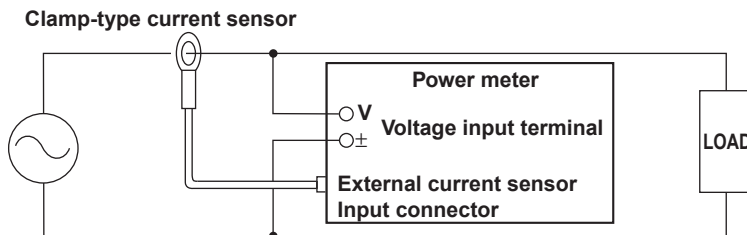

### 3.10 Wiring the Circuit under Measurement When Using the Current Sensor

The following wiring examples are for connecting shunt-type current sensors. When connecting a clamp-type current sensor that outputs voltage, substitute the shunt-type current sensor with the clamp-type. In addition, the assignment of elements to the input terminals in the following figure varies depending on the number of installed input elements. For details, see “Number of Installed Input Elements and Wiring Systems” in section 2.3, “Measurement Conditions.”

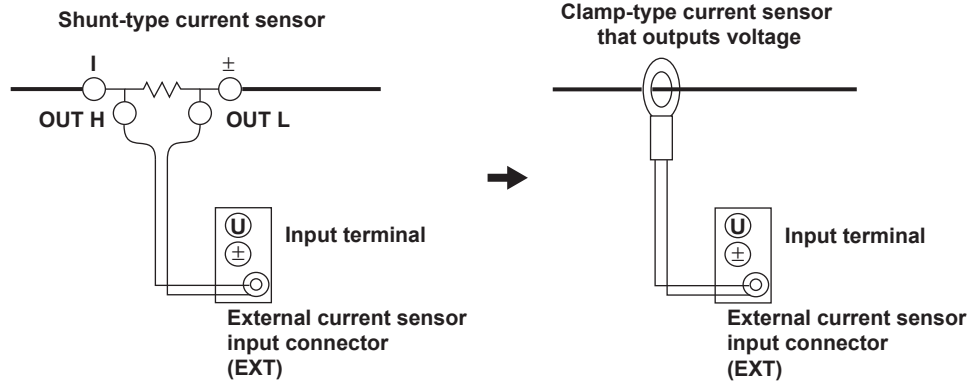

#### Wiring Example of a Single-Phase, Two-Wire System (1P2W) Using a Shunt-Type Current Sensor

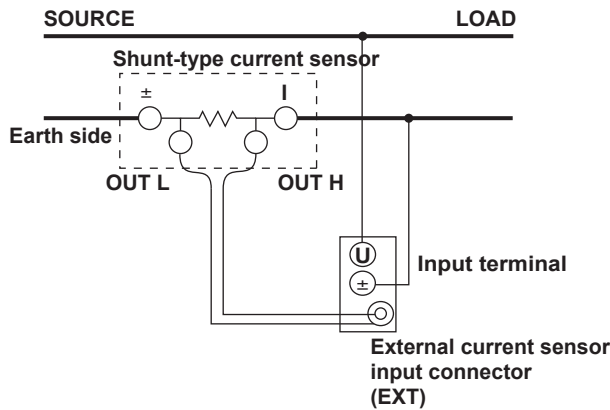

#### Wiring Example of a Single-Phase, Three-Wire System (1P3W) Using a Shunt-Type Current Sensor

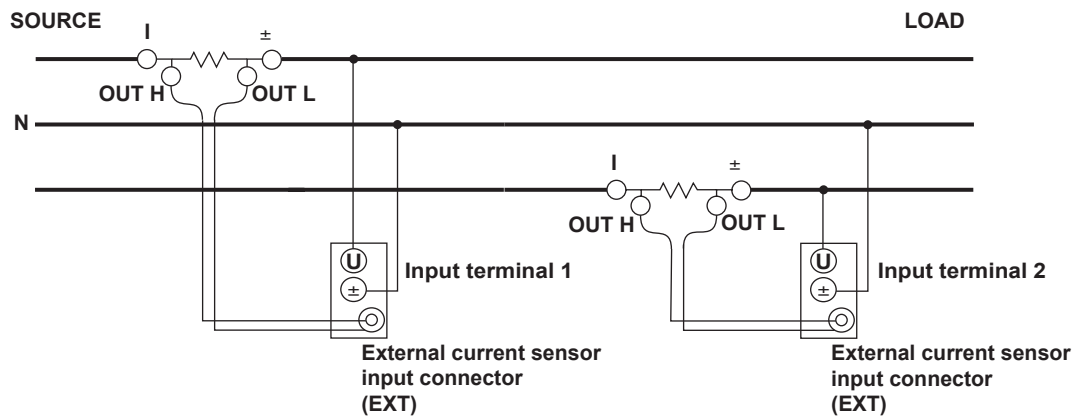

**Wiring Example of a Three-Phase, Three-Wire System (3P3W) Using a Shunt-Type Current Sensor**

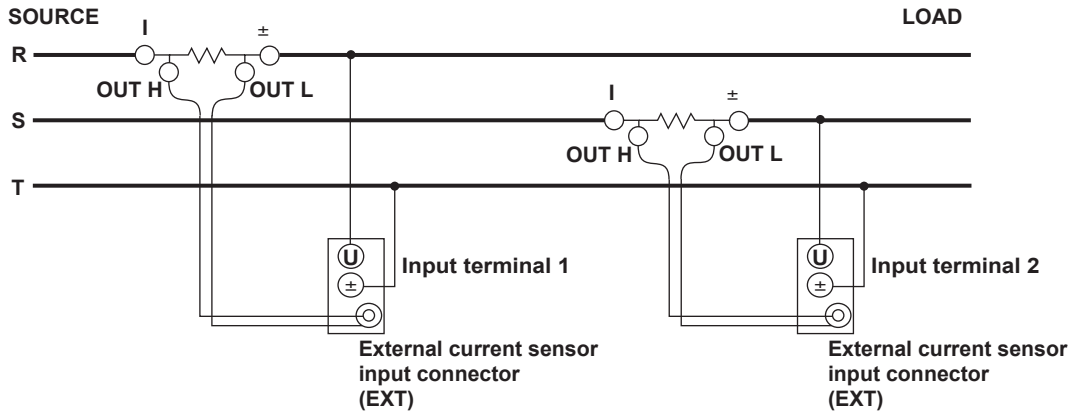

**Wiring Example of a Three-Phase, Three-Wire System (Three-Voltage, Three-Current System) [3P3W (3V3A)] Using a Shunt-Type Current Sensor**

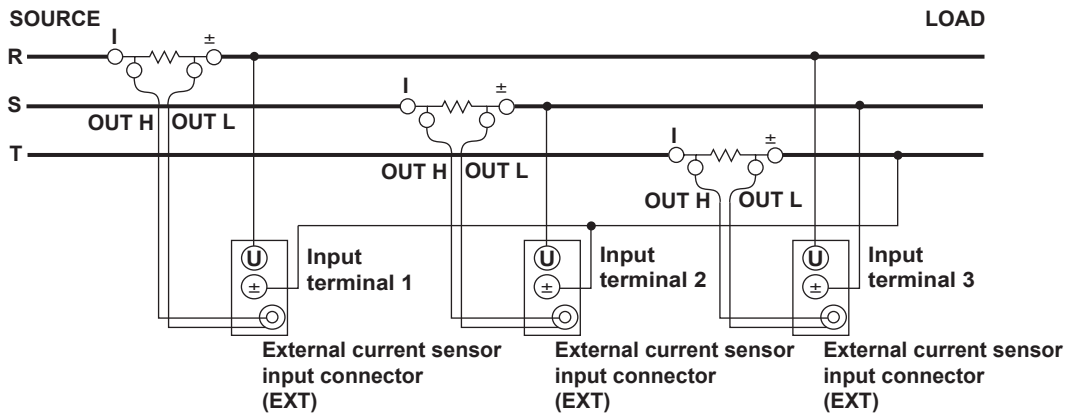

**Wiring Example of a Three-Phase, Four-Wire System (3P4W) Using a Shunt-Type Current Sensor**

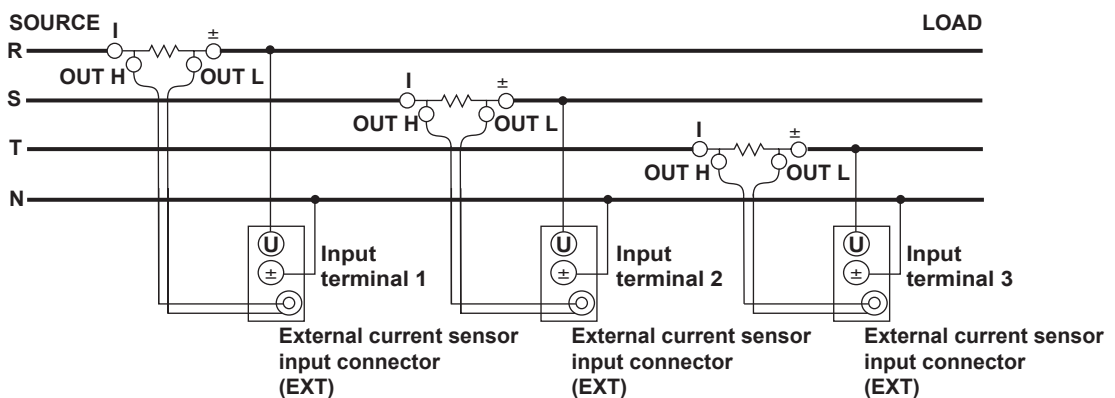

**Note**

For the relationship between the wiring systems and the method of determining the measured values or computed values, see Appendix 1, "Symbols and Determination of Measurement Functions."

## 3.11 Wiring the Circuit under Measurement When Using the VT/CT

Connect a measurement cable from an external voltage transformer (VT) or current transformer (CT) to the voltage or current input terminal of the input element. Wire according to the procedure in this section also when using a clamp-type current sensor that outputs current.

To prevent the possibility of electric shock and damage to the instrument, follow the precautions given in section 3.5, "Wiring Precautions."

An external VT can be connected to the voltage input terminal to make measurements when the maximum voltage of the circuit under measurement exceeds 1000 Vrms. If the maximum current of the circuit under measurement exceeds the maximum range of the input element as described below, measurement can be made by connecting an external CT or a clamp-type current sensor that outputs current to the current input terminal.

- 2-A input element  
When the maximum current exceeds 2 Arms
- 30-A input element  
When the maximum current exceeds 30 Arms

### Connecting to the Input Terminal

- **Voltage Input Terminal**

The terminal is a  $\phi 4$ -mm safety banana jack (female). Insert the safety terminal (the conductive parts are not exposed) into the voltage input terminal.

When using the 758931 Safety Terminal Adapter that comes with the package, see section 3.6.

- **Current Input Terminal**

- When the voltage of the circuit under measurement is being applied to the current input terminals, do not touch the current sensor input terminals. Since these terminals are electrically connected inside the instrument, this act is dangerous.
- When connecting measurement cables from an external current sensor to the current sensor input connector, remove the cables connected to the current input terminals. In addition, when the voltage of the circuit under measurement is being applied to the current sensor input terminal, do not touch the current input terminals. Since these terminals are electrically connected inside the instrument, this act is dangerous.
- The screws used on the terminal (binding post) are M6 screws. Use one of the following methods: wind the wire around the screw, use the 758921 Fork Terminal Adapter that is sold separately, or pass the crimp-on lugs through the screw axis. Then, tighten firmly by holding the terminal knob.
- For the dimensions of the parts of the terminal, see section 3.9.
- For precautions during and after connection of the current input terminal and crimp-on lugs, see section 3.9.

### Number of Installed Input Elements and Wiring Systems

The selectable wiring systems vary depending on the number of input elements that are installed in the instrument. For details, see "Number of Installed Input Elements and Wiring Systems" in section 2.3, "Measurement Conditions."

### General Handling Precautions of the VT and CT

- Do not short the secondary side of the VT as it may damage the VT.
  - Do not open the secondary side of the CT as it may damage the CT.
- For other handling precautions of the VT or CT, follow the information that comes with the VT or CT that you are using.

### 3.11 Wiring the Circuit under Measurement When Using the VT/CT

**Note**

- After wiring, the wiring system must be selected. See section 4.1, “Selecting the Wiring System.”
- The thick lines on the wiring diagrams are the sections where the current flows. Use appropriate wires that are suitable for the current.
- Make sure you have the polarities correct when making the connections. Otherwise, the polarity of the measurement current will be reversed and correct measurements cannot be made. Be especially careful when connecting the clamp type current sensor, because it is easy to reverse the connection.
- The scaling function can be used to transform the input signal to data that correspond to direct measurements. For the setup procedure, see section 4.5, “Setting the Scaling Function When Using the VT/CT.”
- Note that the frequency and phase characteristics of the VT or CT affect the measured data.
- For safety reasons, this section indicates wiring diagrams in which the common terminals (+/-) of the secondary side of the VT or CT are grounded. However, the necessity of grounding and the grounding location (ground near the VT or CT or ground near the power meter) vary depending on the object being measured.
- To measure the apparent power and power factor more accurately on an unbalanced three-phase circuit, it is recommended that a three-phase, three-wire system (three-voltage, three-current system) [3P3W (3V3A)] be used to make the measurement.

The following wiring examples are for connecting CTs. When connecting a clamp-type current sensor that outputs current, substitute the CT with the clamp-type current sensor. The assignment of elements to the input terminals in the following figure varies depending on the number of installed input elements. For details, see “Number of Installed Input Elements and Wiring Systems” in section 2.3, “Measurement Conditions.”

#### Wiring Example of a Single-Phase, Two-Wire System (1P2W) Using VT and CT

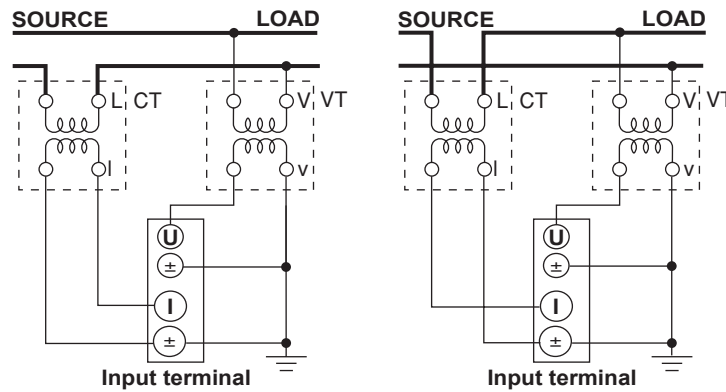

#### Wiring Example of a Single-Phase, Three-Wire System (1P3W) Using VT and CT

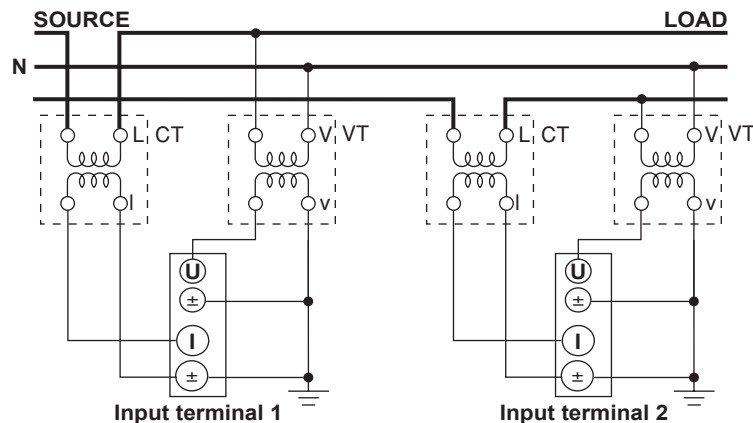

Wiring Example of a Three-Phase, Three-Wire System (3P3W) Using VT and CT

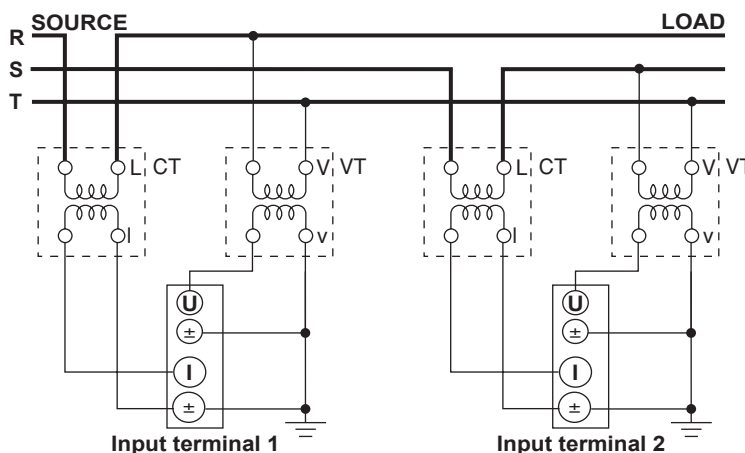

Wiring Example of a Three-Phase, Three-Wire System (Three-Voltage, Three-Current System) [3P3W (3V3A)] Using VT and CT

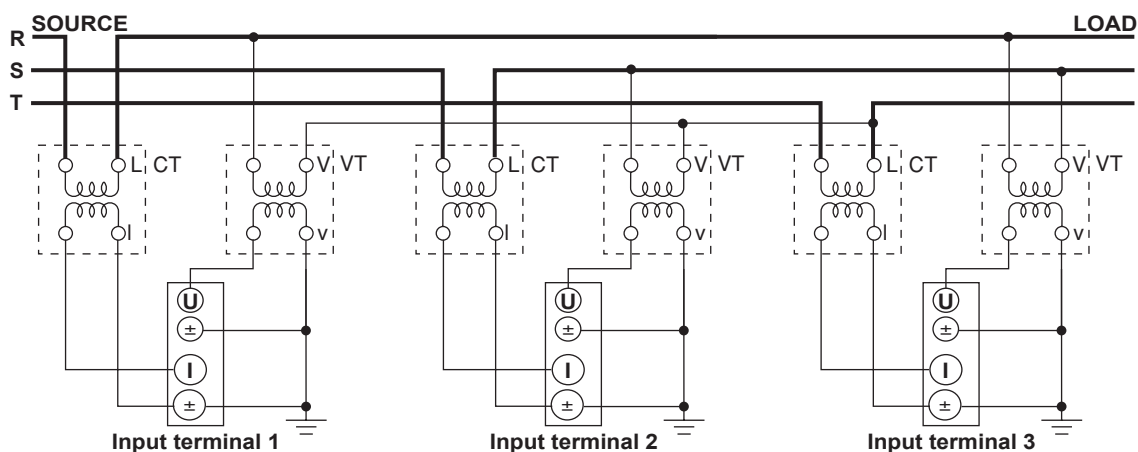

Wiring Example of a Three-Phase, Four-Wire System (3P4W) Using VT and CT

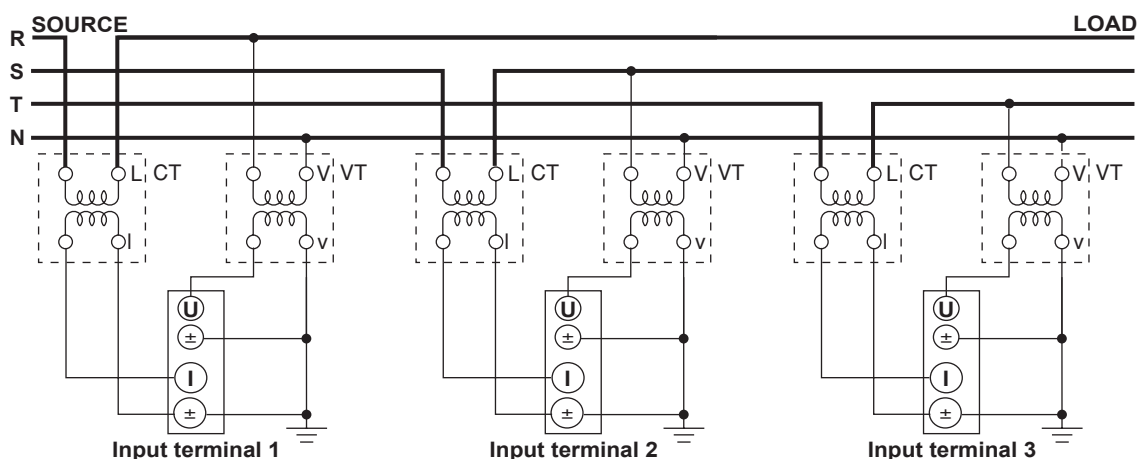

**Note**

For the relationship between the wiring systems and the method of determining the measured values or computed values, see Appendix 1, "Symbols and Determination of Measurement Functions."

## 3.12 Setting the Date/Time

### Procedure

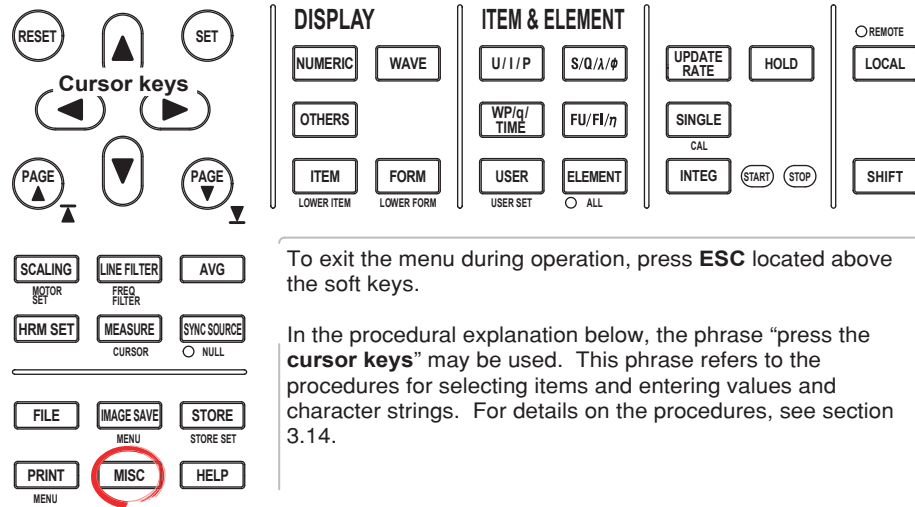

To exit the menu during operation, press **ESC** located above the soft keys.

In the procedural explanation below, the phrase “press the **cursor keys**” may be used. This phrase refers to the procedures for selecting items and entering values and character strings. For details on the procedures, see section 3.14.

1. Press **MISC** to display the Misc menu.
  2. Press the **Date/Time** soft key to display the Date/Time dialog box.
- **Turning ON/OFF the Date/Time Display**
    3. Press the **cursor keys** to select Display.
    4. Press **SET** to select ON or OFF.
  - **Setting the Date or Time Manually**

If the Ethernet interface option is installed, proceed to step 5.  
If it is not, proceed to step 7.

    5. Press the **cursor keys** to select Type.
    6. Press **SET** to set Type to Manual.
    7. Press the **cursor keys** to select the Date (year, month, and day) or Time (hour, minute, second) box.
    8. Press **SET** to display the entry box.
    9. Press the **cursor keys** to set the year, month, date, hour, minute, or second that you selected in step 5.
    10. Press **SET** or **ESC** to close the box.
    11. Repeat steps 5 to 8 to set the entire year, month, date, hour, minute, and second.
    12. Press the **cursor keys** to select Set.
    13. Press **SET**. If ON was selected in step 4, the new date and time are displayed in the lower right corner of the screen. If the procedure is aborted without pressing SET, the new settings are not reflected on the display.

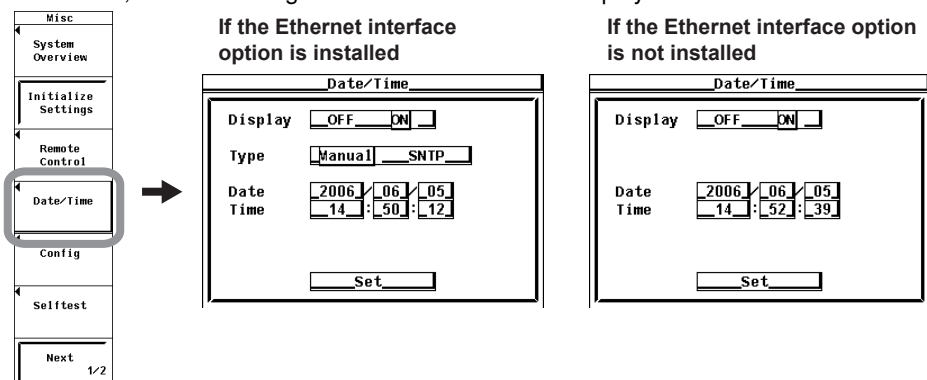



- **Setting the Time Using the SNTP Server**

**(Available when the Ethernet interface option is installed)**

To obtain the time from the SNTP server, you must first connect to the network and then to the SNTP server. For details, see section 5.2, “Setting TCP/IP” and section 5.7, “Setting the Time Difference from GMT (Greenwich Mean Time)/Setting SNTP” in the *Expansion Function User’s Manual IM760301-51E*.

5. After step 4, press the **cursor keys** to select Type.
6. Press **SET** to set Type to SNTP.
7. Press the **cursor keys** to select Time Hour under Time Difference from GMT.
8. Press **SET**. An entry box appears.
9. Press the **cursor keys** to set the hour.
10. Press **SET** to confirm.
11. Likewise, set the minute.
12. Press the **cursor keys** to select Set and press SET. The time is obtained from the SNTP server, and the date and time calculated from the specified GMT time difference are set.

### Explanation

- **Turning ON/OFF the Date/Time display**

You can select whether or not to display the date and time in the lower right corner of the screen.

- OFF: Do not display the date and time.
- ON: Display the date and time.

- **Setting the Date/Time**

- **Setting the Date**

You can set the date in the form YY/MM/DD (year/month/day). Set the lower two digits of the year.

- **Setting the Time**

You can set the time in the form HH:MM:SS (hour:minute:second). The hour is set using a 24-hour clock.

- **Setting the Time Using the SNTP Server**

You can use the SNTP server time to set the date and time on the instrument. This function is available if the Ethernet interface option is installed. For details on the SNTP and GMT, see section 5.7, “Setting the Time Difference from GMT (Greenwich Mean Time)/Setting SNTP” in the *Expansion Function User’s Manual IM760301-51E*. The time difference from GMT specified here is linked to the setting of 5.7 above.

### Note

- The date and time information is backed up with the lithium battery when the power is turned OFF.
- The instrument contains leap year information. The instrument determines the leap year calendar when the new settings are confirmed. If you enter [2/29] on a non-leap year, an error message will be displayed.

## 3.13 Initializing the Settings

### Procedure

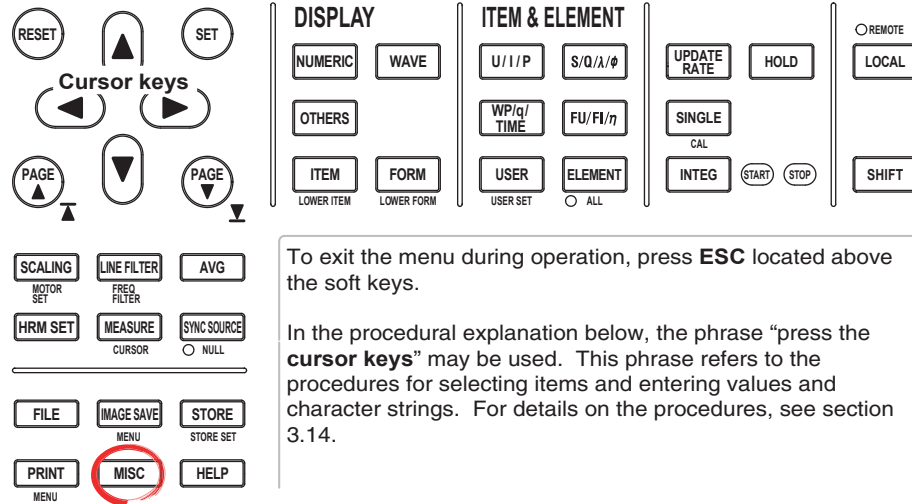

### Note

Check that it is okay to initialize the settings before actually initializing the settings. You cannot set the settings back after initialization. It is recommended that the setup parameters be saved (see section 9.3) before initialization.

1. Press **MISC** to display the Misc menu.
2. Press the **Initialize Settings** soft key. An Alert dialog box appears.
3. Press the **cursor keys** to select OK.
4. Press **SET** to execute the initialization.

To cancel the initialization, select Cancel in step 3 and press SET.

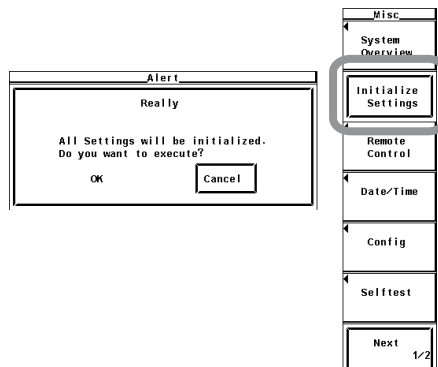

**Explanation**

The values specified by the panel keys can be reset to the factory default values. This is useful when you wish to clear previous settings or start the settings from scratch. For details on the initial settings, see appendix 2, “List of Initial Settings and Display Order of Numeric Data.”

- **Settings That Cannot Be Initialized**

- Date/Time settings
- Menu and message language settings
- Setting of the time difference from GMT (when the Ethernet option is installed)
- Designation of file to be displayed (Filter)
- File utility operation (Function)
- Settings related to the GP-IB communication, serial communication (option), USB communication (option) and Ethernet communication (option).

- **Initializing at Power Up**

If the power switch is turned ON while holding down RESET, the WT3000 powers up using initial settings. In this case, “Settings That Cannot Be Initialized” as indicated above excluding the date and time are also initialized. A message indicating that settings have been initialized is shown on the screen.

## 3.14 Entering Values and Character Strings

### Entering Values

After selecting the setup parameter with the SET key and soft keys, the value can be changed using the cursor keys. Use the left and right cursor keys to move along the digits and the up and down cursor keys to set the value of that digit.

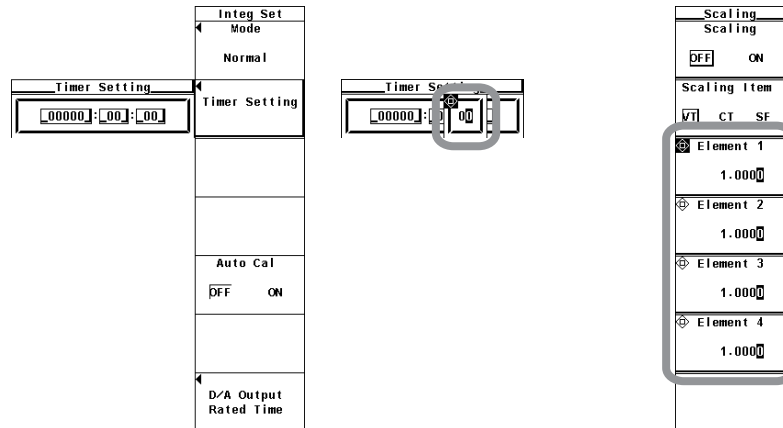

#### Note

Some of the parameters that can be changed using the cursor keys are reset to their initial values when the RESET key is pressed.

### Entering Character Strings

The equation for the user-defined function, units, file names, and comments can be entered using the keyboard that is displayed on the screen. The cursor keys and SET are used to operate the keyboard to enter the character strings.

- **Entering the Equation for the User-Defined Function**

The figure below shows the keyboard that appears when setting the equation for the user-defined function. Long equations can be temporarily held in the internal memory so that it can be used in other equations.

- **Entering the Equation and Temporarily Storing It**

1. Press the ▲ and ▼ **cursor keys** to select the desired character. You can move the cursor quickly by holding down ▲ or ▼ to make the cursor skip. (Long function names can be selected by pressing one key.)
2. Press **SET** to enter characters in the entry box. If there are characters already in the entry box, use the ◀ and ▶ **cursor keys** to select the entry position.
3. Repeat steps 1 and 2 to enter all the characters.
4. After entering all the characters, select **ENT** on the keyboard and press **SET**. The string is confirmed and the keyboard disappears. At the same time, the equation is temporarily stored in the internal memory.
  - When the equation is not correct and an error message is displayed, it is still stored in the memory.
  - Up to five equations can be stored. After five equations have been stored, a new equation overwrites the oldest equation.

- **Recalling the Temporarily Stored Equation**

The procedure varies depending on the WT3000 firmware version as follows:



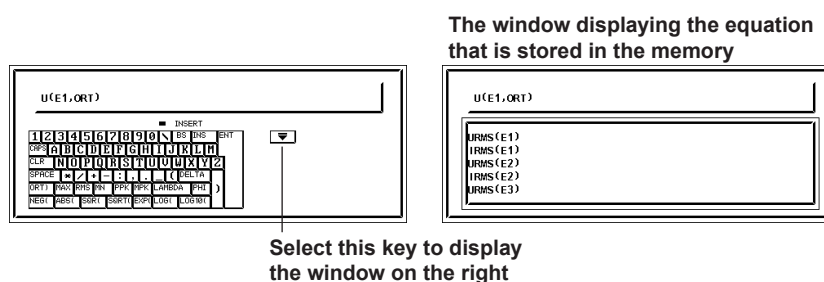



- Version 1.0x
  1. Select  on the keyboard and press **SET**. A window opens and the temporarily stored equation is displayed.
  2. Select the equation you wish to recall and press **SET**. The selected equation appears in the entry box on the keyboard. If there are characters already in the entry box, they are overwritten with the recalled equation.
  3. Correct the recalled equation according to steps 1 to 4 in “Entering the equation and temporary storage” described above and enter it. At this point, the equation is temporarily stored in the internal memory. The temporary memory is cleared when the power is turned OFF.

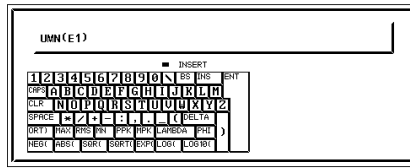

- Version 2.00 or later
  1. Press the ↻ soft key. Each time the soft key is pressed the temporarily stored strings are displayed in the entry box of the keyboard in order. When the eight strings that are temporarily stored are displayed, the most recent string is displayed again. If there are characters already in the entry box, they are overwritten with the recalled string.
  2. Correct the recalled equation according to steps 1 to 4 in “Entering the Equation and Temporarily Storing It” described above and enter it. The string is temporarily stored in the internal memory.

### 3.14 Entering Values and Character Strings



-  Moves the cursor upward.
-  Moves the cursor downward.
-  Switches between upper case and lower case.
-  Deletes the character before the entry position.
-  Switches between insert and overwrite mode.
-  Recalls the temporarily stored string.
-  Enters the string.

- **Entering the Unit, File Name, and Comment (the server name, user name, password, and e-mail address, etc. for Ethernet communication)**

The figure below shows the keyboard that appears when entering the file name or comment. File names and comments can be temporarily held in the internal memory so that they can be used in other file names and comments.

- **Entering the File Name and Comment and Temporarily Storing Them**





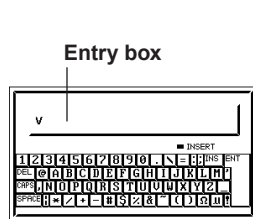

1. Press the ▲ and ▼ **cursor keys** to select the desired character. You can move the cursor quickly by holding down ▲ or ▼ to make the cursor skip. You can also press the ▲ and ▼ soft keys to move the cursor vertically.
2. Press **SET** to enter characters in the entry box.  
If there are characters already in the entry box, use the ◀ and ▶ **cursor keys** to select the entry position.
3. Repeat steps 1 and 2 to enter all the characters.
4. After entering all the characters, select **ENT** on the keyboard and press **SET**. The string is confirmed and the keyboard disappears (you can also press the **ENT** key to achieve the same result). At the same time, the confirmed string is temporarily stored in the internal memory.

Up to 8 sets of strings can be stored. After eight strings have been stored, a new string overwrites the oldest string.

- **Recalling the Temporarily Stored String**

1. Press the ⌂ soft key. Each time the soft key is pressed the temporarily stored strings are displayed in the entry box of the keyboard in order. When the eight strings that are temporarily stored are displayed, the most recent string is displayed again.  
If there are characters already in the entry box, they are overwritten with the recalled string.
2. Correct the recalled equation according to steps 1 to 4 in “Entering the File Name and Comment and Temporarily Storing Them” described above and enter it. The string is temporarily stored in the internal memory.



-  Moves the cursor upward.
-  Moves the cursor downward.
-  Switches between upper case and lower case.
-  Deletes the character before the entry position.
-  Switches between insert and overwrite mode.
-  Recalls the temporarily stored string.
-  Enters the string.

- **Keys Other Than the Character Keys**
  - BS: Deletes the character before the entry position.
  - INS: Switches between insert and overwrite mode. During insert mode, the INSERT indicator on the keyboard illuminates. When a new character is entered in insert mode, the new character is placed at the entry position and all following characters are moved backward.
  - CLR: Clears all displayed characters. On the keyboard used to enter the file name and comment, RESET on the front panel can also be used to achieve the same result.
  - CAPS: Switches between uppercase and lowercase.
  - SPACE: Enters a space.
  - ENT: Enters the displayed characters.

- **Number of Characters and Types That Can Be Used**

Item	Number of Characters	Characters That Can Be Used
Date/Time	Specified number	0 to 9 (/, :)
Equation	1 to 50 characters	Characters that are displayed on the keyboard and spaces
Unit	1 to 8 characters	Characters that are displayed on the keyboard and spaces
File name	1 to 8 characters	0-9, A-Z, %, _, ( ) (parentheses), – (minus sign)
Comment	0 to 25 characters	Characters that are displayed on the keyboard and spaces
Server name	0 to 40 characters	Characters that are displayed on the keyboard and spaces
User name	0 to 40 characters	Characters that are displayed on the keyboard and spaces
Password	0 to 40 characters	Characters that are displayed on the keyboard and spaces
E-mail address	0 to 40 characters	Characters that are displayed on the keyboard and spaces (the @ character cannot be entered consecutively.)

**Note**

File names are not case-sensitive. Comments are case-sensitive. In addition, the following file names cannot be used due to limitations of MS-DOS.

AUX, CON, PRN, NUL, CLOCK, COM1 to COM9, and LPT1 to LPT9

## 3.15 Entering Character Strings on the USB Keyboard

On models with the USB port (peripheral device) option, you can connect a USB keyboard and enter file names, comments, and so on.

### USB PERIPHERAL Connector

Use a USB cable to connect the USB keyboard to the USB PERIPHERAL connector on the left side of the front panel. There are two USB PERIPHERAL connectors (ports).

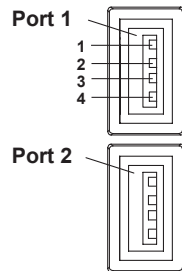

Pin No.	Signal Name
1	VBUS: +5 V
2	D-: -Data
3	D+: *Data
4	GND: Ground

### Keyboards That Can Be Used

The following keyboards conforming to USB Human Interface Devices (HID) Class Ver1.1 can be used.

- When the USB keyboard language is English: 104 keyboard
- When the USB keyboard language is Japanese: 109 keyboard

Select either keyboard in section 3.19.

### Note

- For USB keyboards that have been tested for compatibility, contact your nearest YOKOGAWA dealer.
- Do not connect USB devices other than a USB keyboard or a USB memory to the USB PERIPHERAL connector.
- The WT3000 has two USB PERIPHERAL ports. However, USB devices whose maximum consumption current exceeds 100 mA cannot be connected simultaneously to the two ports.

### Connection Procedure

Connect the USB keyboard to the WT3000 directly using a USB cable as shown below. You can connect/disconnect a USB cable at any time regardless of the power ON/OFF state of the WT3000 (supports hot-plugging). Connect the type A connector of the USB cable to the WT3000; connect the type B connector to the keyboard. When the power switch is ON, the keyboard is detected and enabled approximately six seconds after it is connected.





**Note**

- Connect the keyboard directly without going through a USB hub.
- Do not connect USB devices other than a USB keyboard or a USB memory to the USB PERIPHERAL connector.
- Do not connect multiple keyboards.
- Holding down a key on the keyboard does not enter the character or value repetitively.
- Do not connect and disconnect multiple USB devices repetitively. To do so, allow at least 10 s between connection and disconnection.
- Do not connect or disconnect the USB cable after the power is turned ON until key operation is ready (approximately 20 to 30 s).

**Confirming the Keyboard That Is Connected**

To confirm the keyboard that is connected to the WT3000, carry out the procedure below.

1. Press **MISC**.
2. Press the **USB** soft key.
3. Press the **Device List** soft key to display the USB Device List. Check the USB keyboard that is connected.

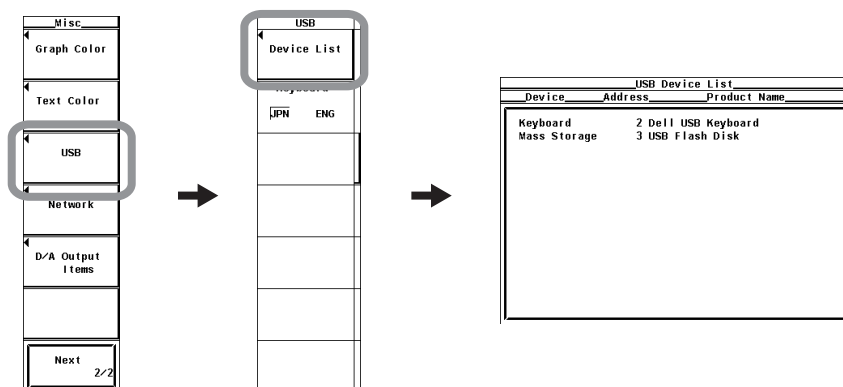
**Entering File Names, Comments, Etc.**

When a keyboard is displayed on the screen, you can enter the file name, comment, and other items using a USB keyboard. The character that is entered through each key of the USB keyboard varies depending on the keyboard type.

**Executing functions corresponding to the keys on the front panel of the WT3000**

The functions corresponding to the front panel keys of the WT3000 are assigned to the keys on the USB keyboard. By pressing the keys on the keyboard, you can operate the WT3000 in a similar fashion. The assignment of functions varies depending on the keyboard type. For details, see appendix 9.

## 3.16 Switching the Measurement Mode and Display

### Procedure

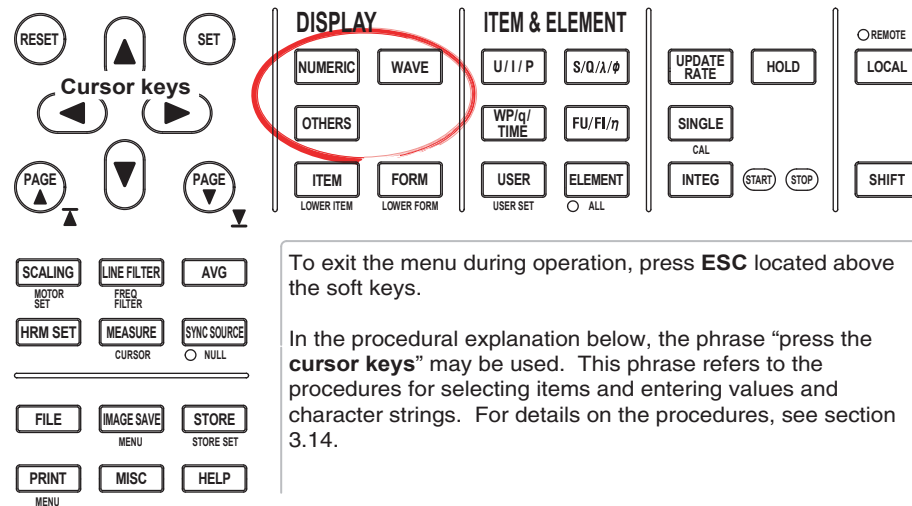

Measurement modes other than normal measurement mode can be used on models with the advanced computation (/G6), voltage fluctuation and flicker measurement (/FL), or cycle-by-cycle measurement (/CC) option.

- **Switching between Normal Measurement/Wide Bandwidth Harmonic Measurement, IEC Harmonic Measurement, Waveform Computation, FFT, Voltage Fluctuation and Flicker Measurement, and Cycle-by-Cycle Measurement Modes**
  - **Enabling Normal Measurement or Wide Bandwidth Harmonic Measurement Mode**
    - **Numeric Display**
      1. Press **NUMERIC** to display numeric values.
    - **Waveform Display**
      1. Press **WAVE**. The waveform is displayed in normal measurement mode.
        - \* The waveform is not displayed in wide bandwidth harmonic measurement mode.
    - **Trend, Bar Graph, Vector, and Split Displays**
      1. Press **OTHERS** to display the Others menu.
      2. Press a soft key to select the display mode.
        - \* The trend is not displayed in wide bandwidth harmonic measurement mode.
  - **Enabling IEC Harmonic Measurement, Waveform Computation, FFT, Voltage Fluctuation and Flicker Measurement, or Cycle-by-Cycle Measurement Mode**
    1. Press **OTHERS** to display the Others menu.
    2. Press a soft key to select the measurement mode.

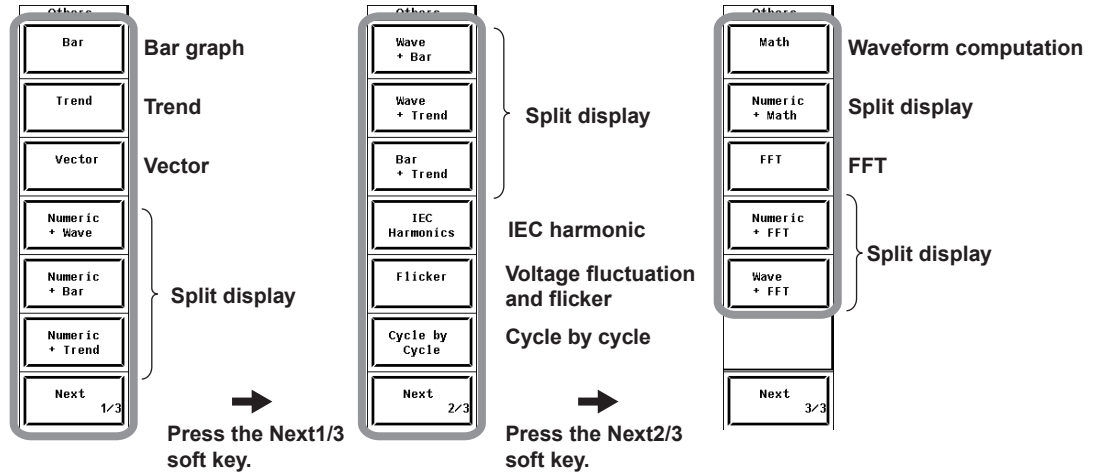

- **Switching the Display in Normal Measurement Mode (or Wide Bandwidth Harmonic Measurement Mode)**

Carry out the procedure given in “Enabling Normal Measurement or Wide Bandwidth Harmonic Measurement Mode” on the previous page.

- **Switching between Normal Measurement Mode and Wide Bandwidth Harmonic Measurement Mode**

1. Press **HRM SET** to display the Harmonics menu.
2. Press the **Freq Band** soft key to select Normal or Wide.

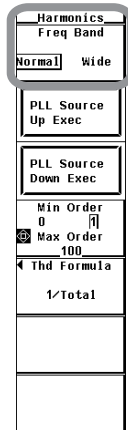

**Explanation**

- **Measurement Mode Indication**

The measurement mode is displayed at the upper left of the screen as shown below.

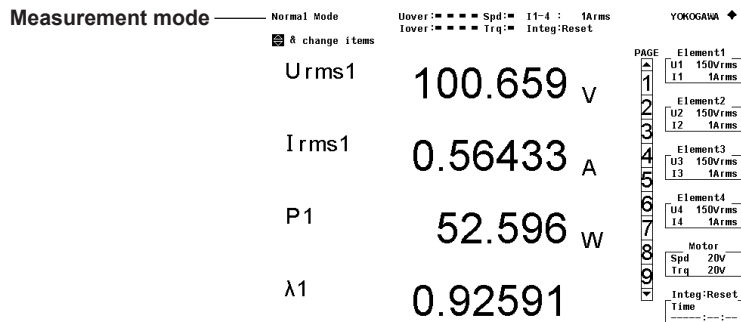

### 3.16 Switching the Measurement Mode and Display

Measurement Mode	Display
Normal measurement mode	Normal Mode
Wide bandwidth harmonic measurement mode <sup>*1</sup>	Wide-Band Harmonics
IEC harmonic measurement mode <sup>*1</sup>	IEC Harmonics Mode
Waveform computation mode <sup>*1</sup>	Math Mode
FFT mode <sup>*1</sup>	FFT Mode
Voltage Fluctuation and Flicker Measurement Mode <sup>*2</sup>	Flicker Mode
Cycle-by-Cycle Measurement Mode <sup>*3</sup>	Cycle by Cycle Mode

\*1 Can be set only on models with the advanced computation (/G6) option.

\*2 Can be set only on models with the voltage fluctuation and flicker measurement (/FL) option.

\*3 Can be set only on models with the cycle-by-cycle measurement (/CC) option.

#### Note

When waveforms are displayed in normal measurement mode, the measurement mode indication is set to Normal Mode (Trg). For details, see section 6.1.

There are two methods to switch the measurement mode. One is to use the DISPLAY key, and the other is to use the HRM SET key.

- **Switching between Normal Measurement/Wide Bandwidth Harmonic Measurement, IEC Harmonic Measurement, Waveform Computation, FFT, Voltage Fluctuation and Flicker Measurement, and Cycle-by-Cycle Measurement Modes**

Press the DISPLAY key (the black arrow in the figure below).

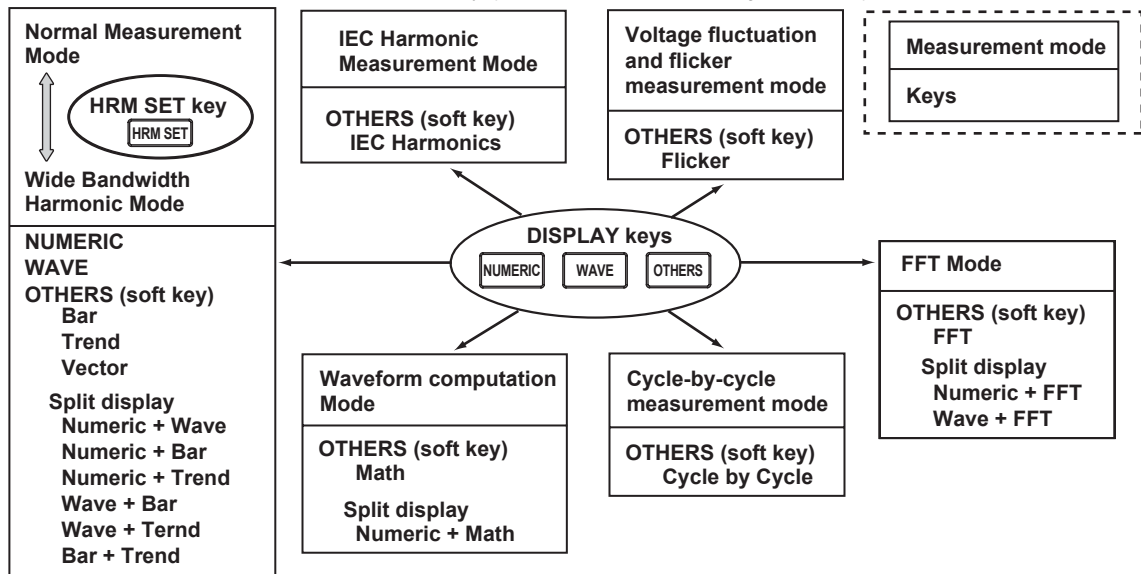

If you change from IEC harmonic, waveform computation, FFT, voltage fluctuation and flicker measurement, or cycle-by-cycle measurement mode to normal measurement/wide bandwidth harmonic measurement mode, the measurement mode that was valid before changing to IEC harmonic, waveform computation, FFT, voltage fluctuation and flicker measurement, or cycle-by-cycle measurement mode is enabled. For example, if you change from wide bandwidth harmonic measurement mode to IEC harmonic mode and then press NUMERIC, wide bandwidth harmonic measurement mode is enabled, not normal measurement mode.

- **Switching between Normal Measurement Mode and Wide Bandwidth Harmonic Measurement Mode**

Press the HRM SET key and switch using the Harmonics menu (the gray yellow in the figure above).

**Explanation**

You can select the display on the WT3000 as indicated below. On models with the advanced computation option, you can select the measurement mode and display in addition to normal measurement mode as shown on the next page.

• **Display Modes in Normal Measurement Mode**

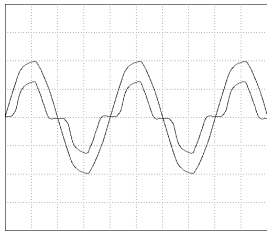
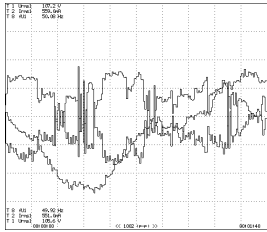
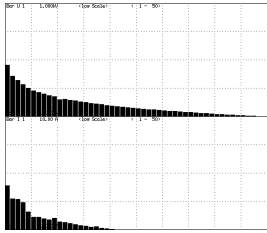
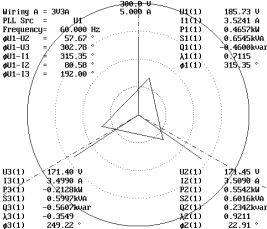
Display mode	Normal measurement mode	
	Without the advanced computation option	With the advanced computation option*1
<b>Power measurement <math>U_{rms1}</math> (numeric display)</b> $U_{rms1}$ 106.183 V $I_{rms1}$ 566.992 mA $P1$ 55.8659 W $\lambda1$ 0.92793	For the operating procedure, see chapter 5. For a functional description, see 2.4.	See chapter 7 in the <i>Expansion Function User's Manual (IM760301-51E)</i> .
<b>Waveform display</b> 	For the operating procedure, see chapter 6. For a functional description, see 2.7.	
<b>Trend display</b> 	For the operating procedure, see chapter 7. For a functional description, see 2.8.	
<b>Bar graph display</b> 	Bar graph display is not possible.	See chapter 7 in the <i>Expansion Function User's Manual (IM760301-51E)</i> .
<b>Vector display</b> 	Vector display is not possible.	See chapter 7 in the <i>Expansion Function User's Manual (IM760301-51E)</i> .

\*1 The /G5 (harmonic measurement) option is equivalent to the harmonic measurement in normal measurement mode.

• **Split Display**

The display is divided into top and bottom halves, and two types of displays can be shown simultaneously.

### 3.16 Switching the Measurement Mode and Display

- **Measurement Modes and Display Modes on Models with the Advanced Computation (/G6), Voltage Fluctuation and Flicker Measurement (/FL), or Cycle-by-Cycle Measurement (/CC) Option**

Display Mode	Measurement Mode					
	/G6				Voltage Fluctuation and Flicker	Cycle by Cycle
	Wide Bandwidth Harmonic	IEC Harmonic	Waveform Computation	FFT		
Power measurement (Numeric)	Yes <sup>*1</sup>	Yes <sup>*1</sup>	Yes	Yes	No	No
Waveform display (Wave)	No	No <sup>*2</sup>	No	Yes	No	No
Trend display (Trend)	No	No	No	No	No	No
Bar graph display (Bar)	Yes	No	No	No	No	No
Vector display (Vector)	Yes	No	No	No	No	No
Waveform computation display (Math)	No	No	Yes	No	No	No
FFT display (FFT)	No	No	No	Yes	No	No
Voltage Fluctuation and Flicker	No	No	No	No	Yes	No
Cycle by Cycle	No	No	No	No	No	Yes

Yes: Selectable.

No: Not selectable.

\*1 The rms values of the voltage or current are the total of the specified harmonic components, not the values that include all frequency components. For details, see chapter 7 in the *Extension Function User's Manual (IM760301-51E)*.

\*2 The waveform can be monitored using the Harmonic/Flicker Measurement Software sold separately.

## 3.17 Displaying the Setup Parameter List

### Procedure

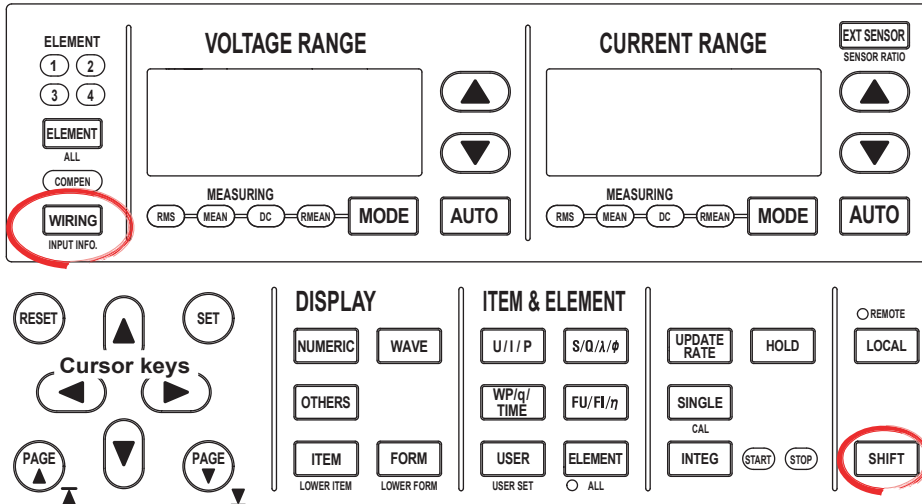

To exit the menu during operation, press **ESC** located above the soft keys.

In the procedural explanation below, the phrase “press the **cursor keys**” may be used. This phrase refers to the procedures for selecting items and entering values and character strings. For details on the procedures, see section 3.14.

- **Displaying the Relation Table of Elements and Measurement Ranges**
  1. Press **SHIFT+WIRING(INPUT INFO.)**. The relation table of measurement ranges, input filters, transformation ratios, scaling factors, and other parameters are displayed for each element.
- **Displaying the Relation Table of Rotating Speeds and the Input Ranges of Torque\*1**
  2. Press **PAGE ▼** to display the list of motor settings. A relation table of the rotating speed and the input range, filter, scaling factor, unit, and synchronization source of torque, number of poles, frequency measurement source, and other parameters is displayed.
 

\*1 Displayed only on models with the motor evaluation function (motor version).
- **Displaying the Relation Table of Trend Targets and Measurement Functions**
  2. Press **PAGE ▼** to display the list of trend settings. The relation table of trend targets and measurement functions is displayed.
- **Displaying the Relation Table of D/A Output Channels and Measurement Functions\*2**
  2. Press **PAGE ▼** to display the list of D/A output settings. The relation table of D/A output channels and measurement functions is displayed.
 

\*2 Displayed only on models with the D/A output (option).
- **Closing the List of Setup Parameters**
  3. Press **SHIFT+WIRING (INPUT INFO.)**. The list of setup parameters closes.

### Explanation

The setup parameter list is shown as in the example on the next page.

### Note

The relation table of elements and measurement ranges and the relation table of the measurement ranges of the motor evaluation function show the settings that existed when the measurement was carried out. If you change the parameters such as the measurement range while the hold function is ON, the change is not reflected in the relation table.

### 3.17 Displaying the Setup Parameter List

- **Relation Table of Elements and Measurement Ranges (Page 1)**

The following figure shows an example when the crest factor is set to 3.

#### Power Element Settings

	Element 1 1P2W	Element 2 1P2W	Element 3 1P2W	Element 4 1P2W
Wiring				
Voltage	1000Vrms	1000Vrms	1000Vrms	1000Vrms
Current	30Arms	30Arms	30Arms	30Arms
Sensor Ratio (mV/A)	10.0000	10.0000	10.0000	10.0000
Line Filter	Off	Off	Off	Off
Freq Filter	Off	Off	Off	Off
Scaling	Off	Off	Off	Off
VT Ratio	1.0000	1.0000	1.0000	1.0000
CT Ratio	1.0000	1.0000	1.0000	1.0000
Scaling Factor	1.0000	1.0000	1.0000	1.0000
Sync Source	I1	I2	I3	I4

- **Relation Table of the Rotating Speed of Motor Evaluation Function (Motor Version) and Input Ranges of Torque (Page 2)**

Displayed only on models with the motor evaluation function (motor version).

#### Motor Element Settings

	Speed 1.0000 rpm	Torque 1.0000 Nm	Pm 1.0000 W
Scaling Unit	Analog	Analog	
Sense Type			
[Analog]			
Auto Range	Off	Off	
Range	20v	20v	
Line Filter	Off	Off	
Sync Source	None	None	
[Pulse]			
Range Upper	10000.0000	50.0000	
Lower	0.0000	-50.0000	
Rated Upper		50.0000 :	15000Hz
Lower		-50.0000 :	5000Hz
Pulse N	60		
[Sync Spd]			
Pole	2		
Source	<input checked="" type="checkbox"/> I1		

- **Relation Table of Trend Targets and Measurement Functions (Page 3)**

#### Trend Settings

	Item	Scale
<input checked="" type="checkbox"/> T 1	Urms1	Auto
<input checked="" type="checkbox"/> T 2	Irms1	Auto
<input checked="" type="checkbox"/> T 3	P1	Auto
<input checked="" type="checkbox"/> T 4	S1	Auto
<input checked="" type="checkbox"/> T 5	Q1	Auto
<input checked="" type="checkbox"/> T 6	λ1	Auto
<input checked="" type="checkbox"/> T 7	φ1	Auto
<input checked="" type="checkbox"/> T 8	fU1	Auto
<input type="checkbox"/> T 9	Urms2	Auto
<input type="checkbox"/> T10	Irms2	Auto
<input type="checkbox"/> T11	P2	Auto
<input type="checkbox"/> T12	S2	Auto
<input type="checkbox"/> T13	Q2	Auto
<input type="checkbox"/> T14	λ2	Auto
<input type="checkbox"/> T15	φ2	Auto
<input type="checkbox"/> T16	fU2	Auto

- **Relation Table of D/A Output Channels and Measurement Functions (Page 4)**

Displayed only on models with the D/A output (option).

#### D/A Output Settings

	Item	Rate
Ch. 1	Urms1	Fixed
Ch. 2	Irms1	Fixed
Ch. 3	P1	Fixed
Ch. 4	S1	Fixed
Ch. 5	Q1	Fixed
Ch. 6	λ1	Fixed
Ch. 7	φ1	Fixed
Ch. 8	fU1	Fixed
Ch. 9	fI1	Fixed
Ch. 10	----	Fixed
Ch. 11	----	Fixed
Ch. 12	----	Fixed
Ch. 13	----	Fixed
Ch. 14	----	Fixed
Ch. 15	----	Fixed
Ch. 16	----	Fixed
Ch. 17	----	Fixed
Ch. 18	----	Fixed
Ch. 19	----	Fixed
Ch. 20	----	Fixed



## 3.18 Selecting the Message Language

### Procedure

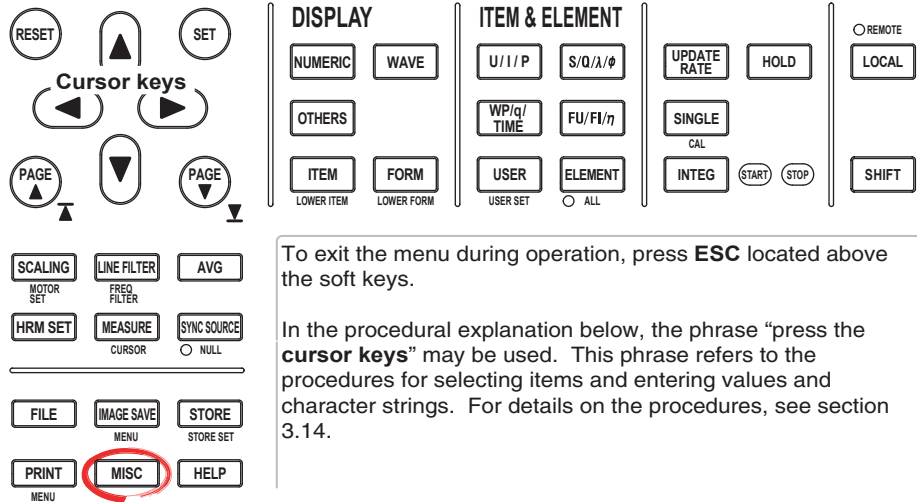

1. Press **MISC** to display the Misc menu.
2. Press the **Config** soft key to display the Config menu.

- **Selecting the Message Language**

3. Press the **Message Language** soft key to display the Message menu.
4. Press the **ENG** or **JPN** soft key to select the message language.

- **Selecting the Menu Language**

3. Press the **Menu Language** soft key.
4. Press the **JPN** or **ENG** soft key to select the menu language.

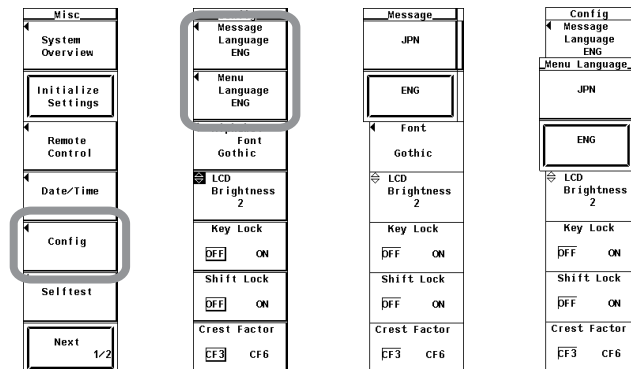

#### Explanation

- **Selecting the Message Language**

An error message is displayed when an error occurs. Select the language to use to display these messages and help messages (see section 10.8) from the choices below. The error codes for the error messages are the same for both English and Japanese. For details on the error messages, see section 11.2.

- JPN: Japanese
- ENG: English

- **Selecting the Menu Language**

The language used on the menu can be selected from the following:

- JPN: Japanese
- ENG: English

## 3.19 Setting the USB Keyboard Language

### Procedure

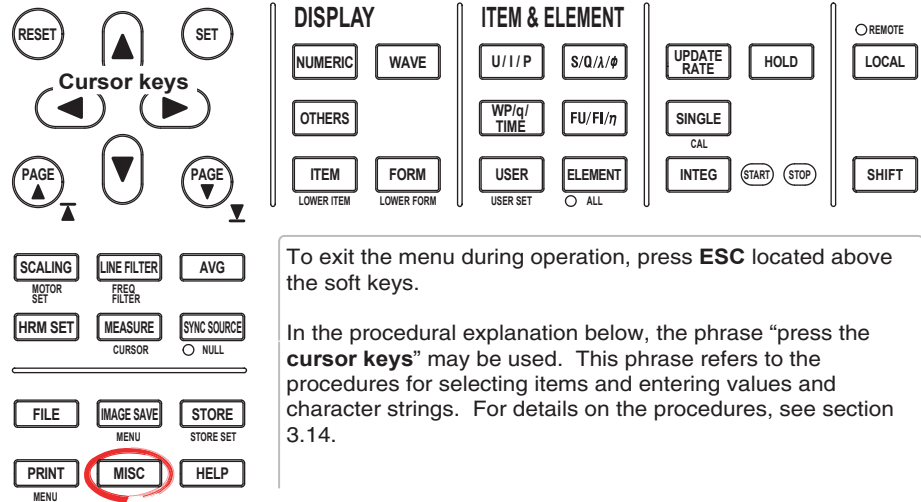

1. Press **MISC** to display the Misc menu.
2. Press the **USB** soft key to display the USB menu.
3. Press the **Keyboard** soft key to select ENG or JPN.

### Explanation

Set the language when entering file names, comments, and other items from the USB keyboard (see section 3.15) on models with the USB port (peripheral devices) option. The following keyboards conforming to USB Human Interface Devices (HID) Class Ver1.1 can be used.

- ENG: 104 keyboard
- JPN: 109 keyboard

The character that is entered through each key of the USB keyboard varies depending on the keyboard type. For details, see appendix 9.

### Note

For USB keyboards that have been tested for compatibility, contact your nearest YOKOGAWA dealer.

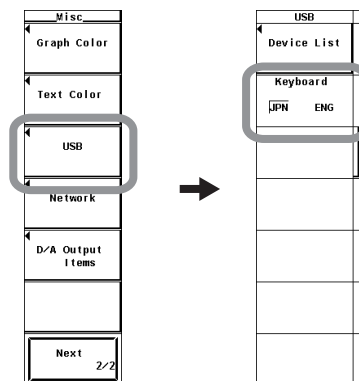

# 4.1 Selecting the Wiring System

## Procedure

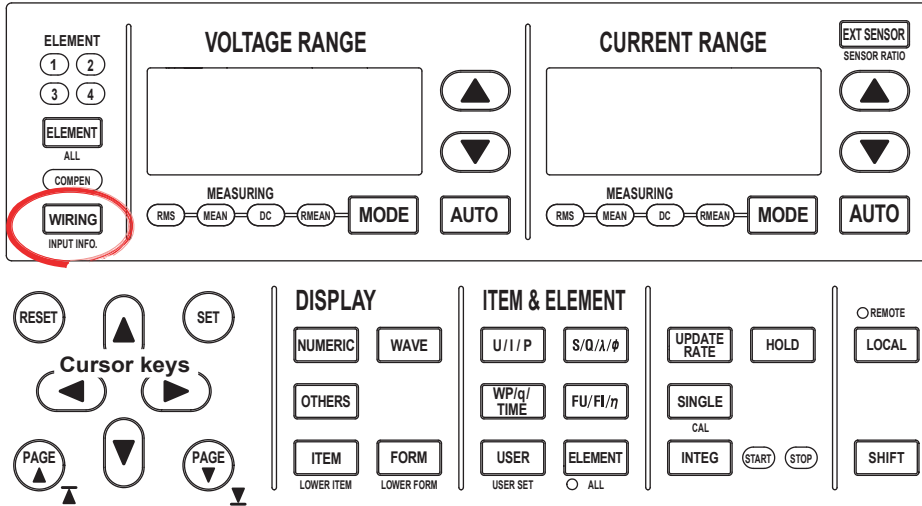

To exit the menu during operation, press **ESC** located above the soft keys.

In the procedural explanation below, the phrase “press the **cursor keys**” may be used. This phrase refers to the procedures for selecting items and entering values and character strings. For details on the procedures, see section 3.14.

1. Press **WIRING** to display the Wiring menu.

• **Selecting the Wiring System Pattern**

2. Press the **Wiring Setting** soft key to display the Wiring Setting dialog box.
3. Press the **cursor keys** to select the target element.

Example in which four elements are installed

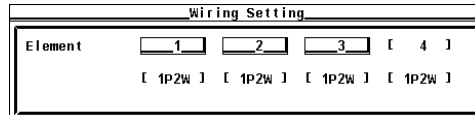

4. Press **SET**. The pattern selection window opens.
5. Press the **cursor keys** to select the pattern.
6. Press **SET** to confirm the new pattern.

Example in which four elements are installed

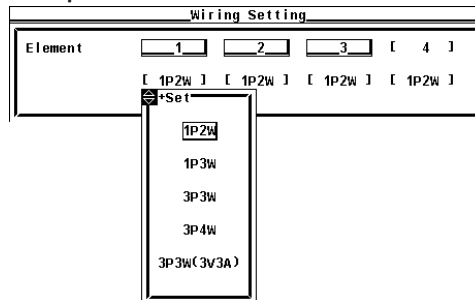

## 4.1 Selecting the Wiring System

### Explanation

- **Wiring System Pattern**

- The five wiring systems below are available. Limitations are placed on the wiring systems that can be selected depending on the number of input elements that are installed in the instrument.

1P2W (single-phase, two-wire), 1P3W (single-phase, three-wire), 3P3W (three-phase, three-wire), 3P4W (three-phase, four-wire), and 3P3W (3V3A, three-voltage, three-current)

- The input element assignment to wiring units  $\Sigma A$  and  $\Sigma B$  is determined from the wiring system pattern. This allows  $\Sigma$  functions of voltage, current, active power, apparent power, reactive power, power factor, phase difference, and other parameters to be determined. For the relationship between the wiring system and the determination of the  $\Sigma$  function, see appendix 1.
- The following table shows the relationship between the number of installed elements, the selectable wiring system patterns, and the assignment of input elements to wiring units  $\Sigma A$  or  $\Sigma B$ .

Installed input elements	1			
Wiring system Pattern 1	1P2W			
Installed input elements	1	2		
Wiring system Pattern 1	1P2W	1P2W		
Wiring system Pattern 2	1P3W or 3P3W: $\Sigma A$			
Installed input elements	1	2	3	
Wiring system Pattern 1	1P2W	1P2W	1P2W	
Wiring system Pattern 2	1P3W or 3P3W(3V3A): $\Sigma A$		1P2W	
Wiring system Pattern 3	1P2W	1P3W or 3P3W(3V3A): $\Sigma A$		
Wiring system Pattern 4	3P4W or 3P3W(3V3A): $\Sigma A$			
Installed input elements	1	2	3	4
Wiring system Pattern 1	1P2W	1P2W	1P2W	1P2W
Wiring system Pattern 2	1P3W or 3P3W: $\Sigma A$		1P2W	1P2W
Wiring system Pattern 3	1P2W	P3W or 3P3W: $\Sigma B$		1P2W
Wiring system Pattern 4	1P2W	1P2W	1P3W or 3P3W: $\Sigma A$	
Wiring system Pattern 5	1P3W or 3P3W: $\Sigma A$		1P3W or 3P3W	
Wiring system Pattern 6	3P4W or 3P3W(3V3A): $\Sigma A$			1P2W
Wiring system Pattern 7	1P2W	3P4W or 3P3W(3V3A): $\Sigma A$		

### Note

- Select the wiring system to match the circuit under measurement that is actually wired. The method in which the  $\Sigma$  function is determined varies depending on the wiring system. If the selected wiring system does not match the actual circuit, measurements and computation will not be correct.
- For the relationship between the wiring system and the determination of the  $\Sigma$  function, see appendix 1.

- **Wiring System Display**

The wiring system configuration is displayed at the right side of the screen. Because it is displayed behind the menu, press the ESC key to hide the menu (allowing the configuration to be viewed). Below are examples showing the wiring systems on a model with four input elements installed.

When elements 1 to 4 are set to single-phase two-wire

```
Element 1
┌ U1 1000Vrms
└ I1 30Arms
```

```
Element 2
┌ U2 1000Vrms
└ I2 30Arms
```

```
Element 3
┌ U3 1000Vmean
└ I3A 30Arms
```

```
Element 4
┌ U4 1000Vmean
└ I4A 30Arms
```

When elements 1 and 2 are set to single-phase, three-wire and elements 3 and 4 are set to three-phase, three-wire

```
Σ A (1P3W)
┌ U1 1000Vrms
└ I1 30Arms
┌ U2 1000Vrms
└ I2 30Arms
```

Wiring unit and wiring system

Displays the elements that compose the wiring unit with a frame

```
Σ B (3P3W)
┌ U3 1000Vmean
└ I3A 30Arms
┌ U4 1000Vmean
└ I4A 30Arms
```

- **Settings of Elements Grouped as a Wiring Unit**

If the independent setting of input elements is OFF and a wiring system other than 1P2W is selected when the measurement range or synchronization source setting of each input element is different, these settings are changed as follows:

- The measurement range is set to the maximum range on all input elements included in the wiring unit. The external sensor input range has precedence over the direct input range for the current range.
- The voltage/current mode and auto range settings are changed to match the settings of the input element with the maximum measurement range. If multiple input elements with maximum measurement range exist, the settings of the input element with the smallest input element number takes precedence.
- The synchronization source setting is changed to match the setting of the input element with the smallest input element number among the input elements included in the wiring unit.

When you press the ELEMENT key to select the element to be configured, the LEDs of input elements in the wiring unit illuminate simultaneously.

## 4.2 Selecting Independent Setting of Input Elements

### Procedure

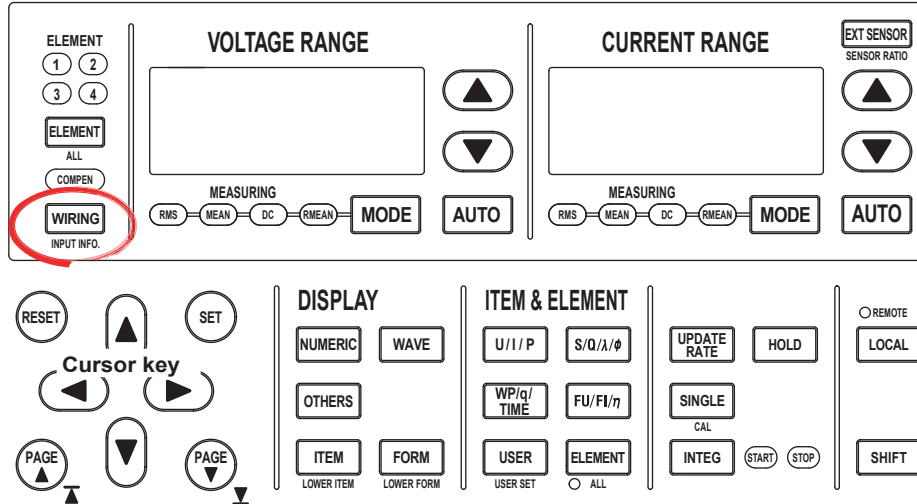

To exit the menu during operation, press **ESC** located above the soft keys.

In the procedural explanation below, the phrase “press the **cursor keys**” may be used. This phrase refers to the procedures for selecting items and entering values and character strings. For details on the procedures, see section 3.14.

- **Turning ON/OFF the Independent Setting**
  1. Press **WIRING** to display the Wiring menu.
  2. Press the **Element Independent** soft key to select ON or OFF.

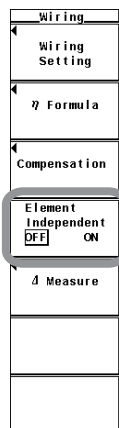

**Explanation**

In the wiring system settings, you can select whether to set the measurement range or synchronization source of input elements in the same wiring unit collectively or independently.

- **Turning ON/OFF the Independent Setting of Input Elements**

For example, assume that the wiring system on a model with three input elements is set as follows:

Input elements 1 to 3: Three-phase, four-wire system (3P4W). Input elements 1 to 3 are assigned to a single wiring unit  $\Sigma A$ .

- ON

The measurement range or synchronization source can be set independently for each input element included in the wiring unit.

- OFF

The measurement range or synchronization source of input elements 1 to 3 is set to the same setting. This is convenient in that the settings of the measurement range and synchronization source of all input elements included in the wiring unit can be done simultaneously when measuring a three-phase device.

- **Settings That Are Matched between Input Elements When the Independent Setting of Input Elements Is Turned OFF**

- Measurement range (including auto range ON/OFF)
- Voltage/Current mode
- Synchronization source setting

- **Settings That Can Be Set Independently Even When the Independent Setting of Input Elements Is Turned OFF**

- Scaling value (VT ratio, CT ratio, and power coefficient)
- Input filter (line filter and frequency filter)

These settings can be set independently for each input element regardless of whether the independent setting of input elements is turned ON/OFF.

- **If a wiring unit ( $\Sigma A$  or  $\Sigma B$ ) is specified and the independent setting of input elements is changed from ON to OFF, the measurement range and synchronization source settings of each input element are changed as follows:**

- The measurement range is set to the maximum range on all input elements included in the wiring unit. The external sensor input range has precedence over the direct input range for the current range.
- The voltage/current mode and auto range settings are changed to match the settings of the input element with the maximum measurement range. If multiple input elements with maximum measurement range exist, the settings of the input element with the smallest input element number takes precedence.
- The synchronization source setting is changed to match the setting of the input element with the smallest input element number among the input elements included in the wiring unit.



## 4.3 Setting the Measurement Range for Direct Input

### Procedure

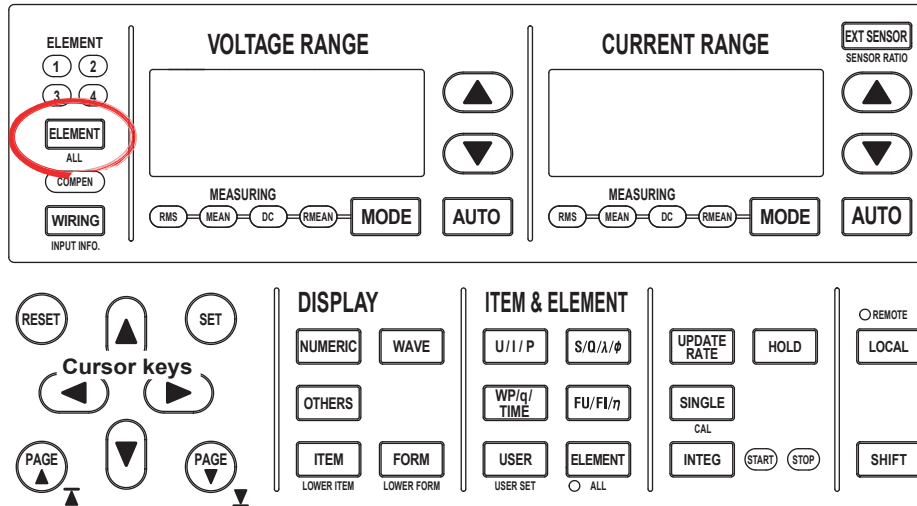

To exit the menu during operation, press **ESC** located above the soft keys.

In the procedural explanation below, the phrase “press the **cursor keys**” may be used. This phrase refers to the procedures for selecting items and entering values and character strings. For details on the procedures, see section 3.14.

- **Selecting the Target Element**

1. Press **ELEMENT** to select the target element. The corresponding element indicator above of the ELEMENT key illuminates. To select all elements, press **SHIFT+ELEMENT (ALL)**.

- **Setting the Voltage Range**

2. Press the **voltage range selection key (UP ▲ and DOWN ▼ keys)** to set the voltage range. The specified range is displayed with the voltage range indicator to the left of the select keys and on the upper-right corner of the screen where the element is displayed.
  - Press the voltage range UP key to increase the voltage range.
  - Press the voltage range DOWN key to decrease the voltage range.
  - Press AUTO to specify auto range. The AUTO key illuminates.

- **Setting the Current Range**

- **Selecting the Current Input Terminal**

3. Check that the EXT SENSOR key is not illuminated. If it is, press **EXT SENSOR**. The EXT SENSOR key turns OFF.

- **Setting the Current Range**

4. Press the **current range selection key (UP ▲ and DOWN ▼ keys)** to set the current range. The specified range is displayed with the current range indicator to the left of the select keys and on the upper-right corner of the screen where the element is displayed.
  - Press the current range UP key to increase the current range.
  - Press the current range DOWN key to decrease the current range.
  - Press AUTO to specify auto range. The AUTO key illuminates.

5. Repeat steps 1 and 4 to set the measurement range of all elements.

## Explanation

- **Display Position of the Target Element and Specified Range**

When a voltage or current range selection key is pressed, the element is displayed in the voltage or current range indicator (7-segment LED) and at the upper-right corner of the screen.

Example of the display at the upper-right corner

Element Voltage range Voltage mode  
Voltage U1 : 1000Vrms Auto YOKOGAWA ◆

Displayed when set to auto range.

Element 1  
U1A 1000Vrms  
I1 30Arms

Element 2  
U2 1000Vrms

- **Selecting the Target Element to Be Configured**

Only the indicators of installed elements illuminate sequentially. When the independent setting of input elements is OFF, the element switches for each wiring unit according to the wiring system.

- **Setting the Voltage and Current Ranges**

There are two types of ranges, fixed and auto.

- **Fixed Range**

The range is set in reference to the RMS value of the input signal.

- Voltage Range

- When the crest factor is set to 3  
Select 15 V, 30 V, 60 V, 100 V, 150 V, 300 V, 600 V, or 1000 V.
- When the crest factor is set to 6  
Select 7.5 V, 15 V, 30 V, 50 V, 75 V, 150 V, 300 V, or 500 V.

- Current range

- 2-A input element
  - When the crest factor is set to 3  
Select 5 mA, 10 mA, 20 mA, 50 mA, 100 mA, 200 mA, 500 mA, 1 A, or 2 A.
  - When the crest factor is set to 6  
Select 2.5 mA, 5 mA, 10 mA, 25 mA, 50 mA, 100 mA, 250 mA, 500 mA, or 1 A.
- 30-A input element
  - When the crest factor is set to 3  
Select 500 mA, 1 A, 2 A, 5 A, 10 A, 20 A, or 30 A.
  - When the crest factor is set to 6  
Select 250 mA, 500 mA, 1 A, 2.5 A, 5 A, 10 A, or 15 A.

### 4.3 Setting the Measurement Range for Direct Input

---

#### Note

---

- The range is set in reference to the RMS value of the input signal. For example, if a 100-Vrms sinusoid is to be applied, set the range to 100 V.
  - When measuring a signal other than a sine wave such as a distorted wave, accurate measurements can be obtained by selecting the smallest measurement range that does not meet the conditions below.
    - The input peak over-range indicator at the top center of the screen illuminates or blinks.
    - The measured values of the voltage and current indicate over range [-OL-].
  - The peak over-range indicator may not illuminate or blink in the following cases.
    - If the pulse width is narrow, and the peak value of the waveform cannot be acquired at the sampling rate of the WT3000 (approximately 200 ks/S).
    - If the high frequency components of the pulse waveform attenuate due to the bandwidth limiting by the WT3000 measurement circuit and the waveform peak value is less than the peak over-range detection level.
  - For the list of the range settings of all input elements, see section 3.16, "Displaying the Setup Parameter List." You can change the measurement range with the list displayed.
- 

- **Auto Range**

When **AUTO** is pressed, the AUTO key illuminates and auto range is enabled. The range switches automatically depending on the magnitude of the input signal as described below. The different ranges used in the auto range are the same as those available for fixed range.

- **Range Increase**
  - When the voltage/current mode is RMS, the measurement range is increased if the data of measurement function  $Urms^{*1}$  or  $Irms^{*1}$  exceeds 110% of the current measurement range.
  - If the peak value of the input signal exceeds 330% or 660% of the current measurement range when the crest factor is set to 3 or 6, respectively, the range is increased.
  - If all the installed input elements are selected (all the element indicators are illuminated), the measurement range is increased on all input elements when the range increase condition above of any input element is met.
  - When a wiring unit is configured, the measurement range is increased on all input elements in the wiring unit when the range increase condition above of any input element in the wiring unit is met.
- **Range Decrease**

When the voltage/current mode is RMS, the range is decreased if the data of the measurement function  $Urms^{*1}$  or  $Irms^{*1}$  is less than or equal to 30% of the measurement range and  $Upk$  and  $Ipk$  is less than or equal to 300% or 600% of the next lower range when the crest factor is set to 3 or 6, respectively.

\*1 When the voltage/current mode is MEAN, DC, or RMEAN, the measurement functions are  $Umn$  and  $Imn$ ,  $Udc$  and  $Idc$ , or  $Urmn$  and  $Irmn$ , respectively.

  - If all the installed input elements are selected (all the element indicators are illuminated), the measurement range is decreased on all input elements when the range decrease condition above of all input elements is met.
  - When a wiring unit is configured, the measurement range is decreased on all input elements in the wiring unit when the range decrease condition above of all input elements in the wiring unit is met.

#### Note

---

When non-periodic pulse waveforms are applied during auto range, the range may not remain constant. If this happens, use the fixed range setting.

---

- **Power Range**

The measurement ranges (power ranges) of active power (P), apparent power (S), and reactive power (Q) are as follows:

Wiring System	Power Range
1P2W (single-phase, two-wire)	voltage range × current range
1P3W (single-phase, three-wire)	voltage range × current range × 2
3P3W (three-phase, three-wire)	(when the voltage and current ranges on the corresponding elements are set to the same range)
3P3W (3V3A, three-voltage, three-current)	
3P4W (three-phase, four-wire)	voltage range × current range × 3 (when the voltage and current ranges on the corresponding elements are set to the same range)

- When the result of the equation *voltage range × current range* exceeds 1000 W (VA or var), the displayed unit changes to kW (kVA or kvar).
- The display resolution is 600000.

**Note**

Because the voltage and current ranges switch independently according to range increase and decrease conditions in auto range mode, different power ranges may be set for the same power value.

### 4.3 Setting the Measurement Range for Direct Input

The combinations of the actual voltage and current ranges and the power range are listed below according to the table on the previous page (when the voltage or current range of each element is set to the same range). The table shows the active power range (unit: W). The same ranges are set for apparent power (unit: VA) and reactive power (unit: var). Just replace the unit with VA or var when looking at the tables.

- When the crest factor (see section 4.6) is set to 3

**Active Power Range of Each Element**

Current Range [A]	Voltage Range (V)							
	15.0000	30.0000	60.0000	100.000	150.000	300.000	600.000	1000.00
5.00000m	75.000 mW	150.000 mW	300.000 mW	500.000 mW	0.75000 W	1.50000 W	3.00000 W	5.00000 W
10.0000m	150.000 mW	300.000 mW	600.000 mW	1.00000 W	1.50000 W	3.00000 W	6.00000 W	10.0000 W
20.0000m	300.000 mW	600.000 mW	1.20000 W	2.00000 W	3.00000 W	6.00000 W	12.0000 W	20.0000 W
50.0000m	0.75000 W	1.50000 W	3.00000 W	5.00000 W	7.5000 W	15.0000 W	30.0000 W	50.0000 W
100.000m	1.50000 W	3.00000 W	6.00000 W	10.0000 W	15.0000 W	30.0000 W	60.0000 W	100.000 W
200.000m	3.00000 W	6.00000 W	12.0000 W	20.0000 W	30.0000 W	60.0000 W	120.000 W	200.000 W
500.000m	7.5000 W	15.0000 W	30.0000 W	50.0000 W	75.000 W	150.000 W	300.000 W	500.000 W
1.00000	15.0000 W	30.0000 W	60.0000 W	100.000 W	150.000 W	300.000 W	600.000 W	1.00000 kW
2.00000	30.0000 W	60.0000 W	120.000 W	200.000 W	300.000 W	600.000 W	1.20000 kW	2.00000 kW
5.00000	75.000 W	150.000 W	300.000 W	500.000 W	0.75000 kW	1.50000 kW	3.00000 kW	5.00000 kW
10.0000	150.000 W	300.000 W	600.000 W	1.00000 kW	1.50000 kW	3.00000 kW	6.00000 kW	10.0000 kW
20.0000	300.000 W	600.000 W	1.20000 kW	2.00000 kW	3.00000 kW	6.00000 kW	12.0000 kW	20.0000 kW
30.0000	450.000 W	0.90000 kW	1.80000 kW	3.00000 kW	4.50000 kW	9.00000 kW	18.0000 kW	30.0000 kW

**Active Power Range of the Wiring Unit with 1P3W, 3P3W, or 3P3W (3V3A) Wiring System**

Current Range [A]	Voltage Range (V)							
	15.0000	30.0000	60.0000	100.000	150.000	300.000	600.000	1000.00
5.00000m	150.000 mW	300.000 mW	600.000 mW	1000.000 mW	1.50000 W	3.00000 W	6.00000 W	10.00000 W
10.0000m	300.000 mW	600.000 mW	1200.000 mW	2.00000 W	3.00000 W	6.00000 W	12.00000 W	20.0000 W
20.0000m	600.000 mW	1200.000 mW	2.40000 W	4.00000 W	6.00000 W	12.00000 W	24.0000 W	40.0000 W
50.0000m	1.50000 W	3.00000 W	6.00000 W	10.00000 W	15.0000 W	30.0000 W	60.0000 W	100.0000 W
100.000m	3.00000 W	6.00000 W	12.00000 W	20.0000 W	30.0000 W	60.0000 W	120.0000 W	200.000 W
200.000m	6.00000 W	12.00000 W	24.0000 W	40.0000 W	60.0000 W	120.0000 W	240.000 W	400.000 W
500.000m	15.0000 W	30.0000 W	60.0000 W	100.0000 W	150.000 W	300.000 W	600.000 W	1000.000 W
1.00000	30.0000 W	60.0000 W	120.0000 W	200.000 W	300.000 W	600.000 W	1200.000 W	2.00000 kW
2.00000	60.0000 W	120.0000 W	240.000 W	400.000 W	600.000 W	1200.000 W	2.40000 kW	4.00000 kW
5.00000	150.000 W	300.000 W	600.000 W	1000.000 W	1.50000 kW	3.00000 kW	6.00000 kW	10.00000 kW
10.0000	300.000 W	600.000 W	1200.000 W	2.00000 kW	3.00000 kW	6.00000 kW	12.00000 kW	20.0000 kW
20.0000	600.000 W	1200.000 W	2.40000 kW	4.00000 kW	6.00000 kW	12.00000 kW	24.0000 kW	40.0000 kW
30.0000	900.000 W	1.80000 kW	3.60000 kW	6.00000 kW	9.00000 kW	18.0000 kW	36.0000 kW	60.0000 kW

**Active Power Range of the Wiring Unit with 3P4W Wiring System**

Current Range [A]	Voltage Range (V)							
	15.0000	30.0000	60.0000	100.000	150.000	300.000	600.000	1000.00
5.00000m	225.000 mW	450.000 mW	900.000 mW	1500.000 mW	2.25000 W	4.50000 W	9.00000 W	15.00000 W
10.0000m	450.000 mW	900.000 mW	1800.000 mW	3.00000 W	4.50000 W	9.00000 W	18.00000 W	30.0000 W
20.0000m	900.000 mW	1800.000 mW	3.60000 W	6.00000 W	9.00000 W	18.00000 W	36.0000 W	60.0000 W
50.0000m	2.25000 W	4.50000 W	9.00000 W	15.00000 W	22.5000 W	45.0000 W	90.0000 W	150.0000 W
100.000m	4.50000 W	9.00000 W	18.00000 W	30.0000 W	45.0000 W	90.0000 W	180.0000 W	300.000 W
200.000m	9.00000 W	18.00000 W	36.0000 W	60.0000 W	90.0000 W	180.0000 W	360.000 W	600.000 W
500.000m	22.5000 W	45.0000 W	90.0000 W	150.0000 W	225.000 W	450.000 W	900.000 W	1500.000 W
1.00000	45.0000 W	90.0000 W	180.0000 W	300.000 W	450.000 W	900.000 W	1800.000 W	3.00000 kW
2.00000	90.0000 W	180.0000 W	360.000 W	600.000 W	900.000 W	1800.000 W	3.60000 kW	6.00000 kW
5.00000	225.000 W	450.000 W	900.000 W	1500.000 W	2.25000 kW	4.50000 kW	9.00000 kW	15.00000 kW
10.0000	450.000 W	900.000 W	1800.000 W	3.00000 kW	4.50000 kW	9.00000 kW	18.00000 kW	30.0000 kW
20.0000	900.000 W	1800.000 W	3.60000 kW	6.00000 kW	9.00000 kW	18.00000 kW	36.0000 kW	60.0000 kW
30.0000	1350.000 W	2.70000 kW	5.40000 kW	9.00000 kW	13.50000 kW	27.0000 kW	54.0000 kW	90.0000 kW

### 4.3 Setting the Measurement Range for Direct Input

- When the crest factor is set to 6

#### Active Power Range of Each Element

Current Range [A]	Voltage Range (V)							
	7.5000	15.0000	30.0000	50.0000	75.0000	150.0000	300.0000	500.0000
2.50000m	18.7500 mW	37.5000 mW	75.0000 mW	125.000 mW	187.500 mW	375.000 mW	0.75000 W	1.25000 W
5.00000m	37.5000 mW	75.0000 mW	150.000 mW	250.000 mW	375.000 mW	0.75000 W	1.50000 W	2.50000 W
10.0000m	75.0000 mW	150.000 mW	300.000 mW	500.000 mW	0.75000 W	1.50000 W	3.00000 W	5.00000 W
25.0000m	187.500 mW	375.000 mW	0.75000 W	1.25000 W	1.87500 W	3.75000 W	7.5000 W	12.5000 W
50.0000m	375.000 mW	0.75000 W	1.50000 W	2.50000 W	3.75000 W	7.5000 W	15.0000 W	25.0000 W
100.000m	0.75000 W	1.50000 W	3.00000 W	5.00000 W	7.5000 W	15.0000 W	30.0000 W	50.0000 W
250.000m	1.87500 W	3.75000 W	7.5000 W	12.5000 W	18.7500 W	37.5000 W	75.000 W	125.000 W
500.000m	3.75000 W	7.5000 W	15.0000 W	25.0000 W	37.5000 W	75.000 W	150.000 W	250.000 W
1.00000	7.5000 W	15.0000 W	30.0000 W	50.0000 W	75.000 W	150.000 W	300.000 W	500.000 W
2.50000	18.7500 W	37.5000 W	75.0000 W	125.000 W	187.500 W	375.000 W	0.75000 kW	1.25000 kW
5.00000	37.5000 W	75.0000 W	150.000 W	250.000 W	375.000 W	0.75000 kW	1.50000 kW	2.50000 kW
10.0000	75.0000 W	150.000 W	300.000 W	500.000 W	0.75000 kW	1.50000 kW	3.00000 kW	5.00000 kW
15.0000	112.500 W	225.000 W	450.000 W	0.75000 kW	1.12500 kW	2.25000 kW	4.50000 kW	7.5000 kW

#### Active Power Range of the Wiring Unit with 1P3W, 3P3W, or 3P3W (3V3A) Wiring System

Current Range [A]	Voltage Range (V)							
	7.5000	15.0000	30.0000	50.0000	75.0000	150.0000	300.0000	500.0000
2.50000m	37.5000 mW	75.0000 mW	150.000 mW	250.000 mW	375.000 mW	750.000 mW	1.50000 W	2.50000 W
5.00000m	75.0000 mW	150.000 mW	300.000 mW	500.000 mW	750.000 mW	1.50000 W	3.00000 W	5.00000 W
10.0000m	150.000 mW	300.000 mW	600.000 mW	1000.000 mW	1.50000 W	3.00000 W	6.00000 W	10.00000 W
25.0000m	375.000 mW	750.000 mW	1.50000 W	2.50000 W	3.75000 W	7.50000 W	15.0000 W	25.0000 W
50.0000m	750.000 mW	1.50000 W	3.00000 W	5.00000 W	7.50000 W	15.0000 W	30.0000 W	50.0000 W
100.000m	1.50000 W	3.00000 W	6.00000 W	10.00000 W	15.0000 W	30.0000 W	60.0000 W	100.0000 W
250.000m	3.75000 W	7.50000 W	15.0000 W	25.0000 W	37.5000 W	75.0000 W	150.000 W	250.000 W
500.000m	7.50000 W	15.0000 W	30.0000 W	50.0000 W	75.0000 W	150.000 W	300.000 W	500.000 W
1.00000	15.0000 W	30.0000 W	60.0000 W	100.0000 W	150.000 W	300.000 W	600.000 W	1000.000 W
2.50000	37.5000 W	75.0000 W	150.000 W	250.000 W	375.000 W	750.000 W	1.50000 kW	2.50000 kW
5.00000	75.0000 W	150.000 W	300.000 W	500.000 W	750.000 W	1.50000 kW	3.00000 kW	5.00000 kW
10.0000	150.000 W	300.000 W	600.000 W	1000.000 W	1.50000 kW	3.00000 kW	6.00000 kW	10.00000 kW
15.0000	225.000 W	450.000 W	900.000 W	1.50000 kW	2.25000 kW	4.50000 kW	9.00000 kW	15.0000 kW

#### Active Power Range of the Wiring Unit with 3P4W Wiring System

Current Range [A]	Voltage Range (V)							
	7.5000	15.0000	30.0000	50.0000	75.0000	150.0000	300.0000	500.0000
2.50000m	56.2500 mW	112.5000 mW	225.000 mW	375.000 mW	562.500 mW	1125.000 mW	2.25000 W	3.75000 W
5.00000m	112.5000 mW	225.000 mW	450.000 mW	750.000 mW	1125.000 mW	2.25000 W	4.50000 W	7.50000 W
10.0000m	225.000 mW	450.000 mW	900.000 mW	1500.000 mW	2.25000 W	4.50000 W	9.00000 W	15.00000 W
25.0000m	562.500 mW	1125.000 mW	2.25000 W	3.75000 W	5.62500 W	11.25000 W	22.5000 W	37.5000 W
50.0000m	1125.000 mW	2.25000 W	4.50000 W	7.50000 W	11.25000 W	22.5000 W	45.0000 W	75.0000 W
100.000m	2.25000 W	4.50000 W	9.00000 W	15.00000 W	22.5000 W	45.0000 W	90.0000 W	150.0000 W
250.000m	5.62500 W	11.25000 W	22.5000 W	37.5000 W	56.2500 W	112.5000 W	225.000 W	375.000 W
500.000m	11.25000 W	22.5000 W	45.0000 W	75.0000 W	112.5000 W	225.000 W	450.000 W	750.000 W
1.00000	22.5000 W	45.0000 W	90.0000 W	150.0000 W	225.000 W	450.000 W	900.000 W	1500.000 W
2.50000	56.2500 W	112.5000 W	225.000 W	375.000 W	562.500 W	1125.000 W	2.25000 kW	3.75000 kW
5.00000	112.5000 W	225.000 W	450.000 W	750.000 W	1125.000 W	2.25000 kW	4.50000 kW	7.50000 kW
10.0000	225.000 W	450.000 W	900.000 W	1500.000 W	2.25000 kW	4.50000 kW	9.00000 kW	15.00000 kW
15.0000	337.500 W	675.000 W	1350.000 W	2.25000 kW	3.37500 kW	6.75000 kW	13.50000 kW	22.5000 kW

## 4.4 Setting the Measurement Range When Using the External Current Sensor

### Procedure

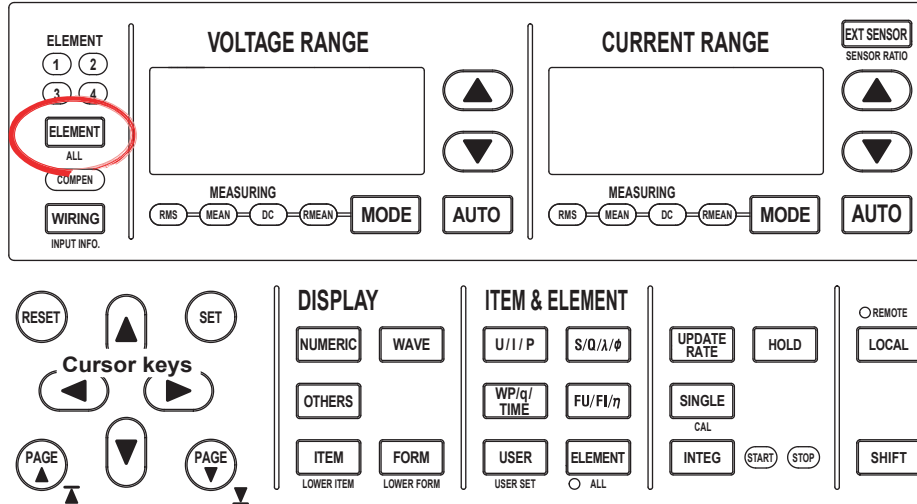

To exit the menu during operation, press **ESC** located above the soft keys.

In the procedural explanation below, the phrase “press the **cursor keys**” may be used. This phrase refers to the procedures for selecting items and entering values and character strings. For details on the procedures, see section 3.14.

- **Selecting the Target Element**
  1. Press **ELEMENT** to select the target element. The corresponding element indicator above of the key illuminates. To select all elements, press **SHIFT+ELEMENT (ALL)**.
- **Selecting the External Current Sensor Input Connector**
  2. Press **EXT SENSOR** to turn ON the EXT SENSOR key. If it is already illuminated, proceed to step 3.
- **Setting the External Current Sensor Range**
  3. Press the **current range selection key (UP and DOWN keys)** to set the external current sensor range. The specified range is displayed with the current range indicator to the left of the keys and on the upper-right corner of the screen where the elements are displayed.
    - Press the current range UP key to increase the external current sensor range.
    - Press the current range DOWN key to decrease the external current sensor range.
    - Press AUTO to specify auto range. The AUTO key illuminates.
  4. Repeat steps 1 and 3 to set the external current sensor range of all elements.

## 4.4 Setting the Measurement Range When Using the External Current Sensor

- **Setting the External Current Sensor Transformation Ratio**

1. Press **SHIFT+EXT SENSOR (SENSOR RATIO)** to display the Sensor Ratio menu.

Only the installed elements are displayed.

- **Selecting the Target Element**

2. Press one of the soft keys corresponding to the displayed element to select the target element.

- **Setting the External Current Sensor Transformation Ratio**

3. Press the **cursor keys** to set the transformation ratio.

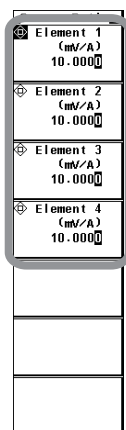



## 4.4 Setting the Measurement Range When Using the External Current Sensor

---

### Explanation

The output of current sensors that output voltage, such as shunts and clamps, can be input to the current sensor input connector of an element and measured. When using a current sensor that outputs current, set the transformation ratio as a CT ratio (see section 4.5).

- **Display Position of the Target Element and Specified Range**

It is the same as section 4.3, "Setting the Measurement Range during Direct Input."

- **Selecting the External Current Sensor Input Connector**

To measure the current using the input signal from the external current sensor input connector, EXT SENSOR must be selected (EXT SENSOR key illuminated) by pressing EXT SENSOR, and then the external current sensor range must be specified.

- **Selecting the External Current Sensor Range**

Two types of range settings are available: fixed and auto.

- **Fixed Range**

- When the crest factor is set to 3  
Select 50 mV, 100 mV, 200 mV, 500 mV, 1 V, 2 V, 5 V, or 10 V.
- When the crest factor is set to 6  
Select 25 mV, 50 mV, 100 mV, 250 mV, 500 mV, 1 V, 2.5 V, or 5 V.

- **Auto Range**

When AUTO is pressed, the AUTO key illuminates and auto range is enabled. The range changes automatically depending on the amplitude of the input signal. The switching conditions and precautions are the same as the descriptions given in section 4.3, "Setting the Measurement Range during Direct Input." The different ranges used in the auto mode are the same as those available for fixed range.

- **Setting the External Current Sensor Transformation Ratio**

The transformation ratio can be set in the range of 0.0001 to 99999.9999.

- **Configuration Example of the External Current Sensor Range and Transformation Ratio**

When measuring a current with a maximum value of 100 A using a current sensor that outputs 10 mV when 1 A of current is flowing, the maximum voltage that the current sensor outputs is  $10 \text{ mV/A} \times 100 \text{ A} = 1 \text{ V}$ . Therefore, set 1 V for the external current sensor range and 10 mV/A for the external current sensor transformation ratio.

### Note

---

- When attempting to directly read the current of the circuit under measurement by multiplying the output of the external current sensor by the transformation ratio, turn OFF the external VT/CT scaling function (see section 4.5). If it is turned ON, the value will be multiplied by the CT ratio.
  - When measuring a signal other than a sine wave such as a distorted wave, accurate measurements can be obtained by selecting the minimum measurement range that does not meet the conditions below.
    - The input peak over-range indicator at the top center of the screen illuminates or blinks.
    - The measured values of the voltage and current indicate over range [-OL-].
  - For the list of the ranges and transformation ratios of all input elements, see section 3.17, "Displaying the Setup Parameter List." You can change the measurement range and the external current sensor transformation ratio with the list displayed. However, for input elements whose current measurement range is not set to external current sensor input range, the change in the transformation ratio is not applied to the list display.
-

## 4.5 Setting the Scaling Function When Using VT/CT

### Procedure

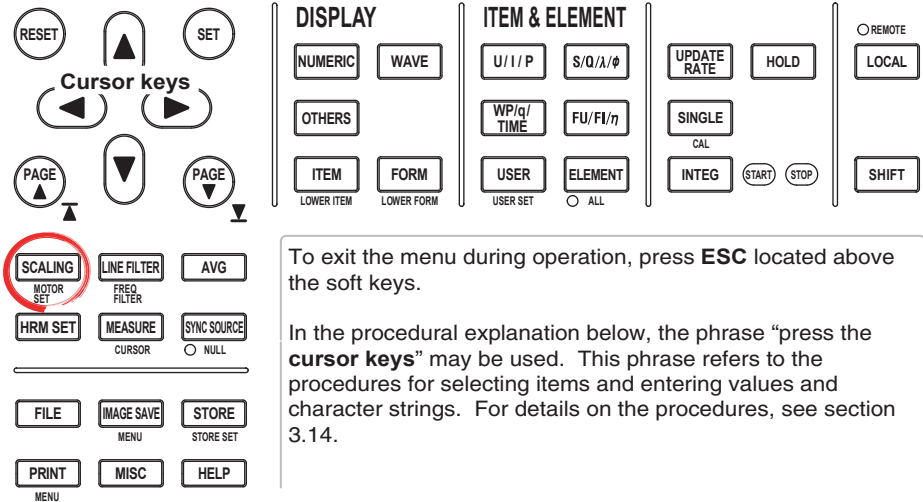

1. Press **SCALING** to display the Scaling menu.
- **Turning ON/OFF the Scaling Function**
    2. Press the **Scaling** soft key to select ON or OFF. The SCALING key illuminates when ON is selected.
  - **Setting the VT Ratio**
    3. Press the **Scaling Item** soft key to select VT.
  - **Selecting the Target Element**
    4. Press one of the soft keys corresponding to the displayed element to select the target element.
    5. Press the **cursor keys** to set the VT ratio.
    6. Repeat steps 4 and 5 to set the VT ratio for all elements.

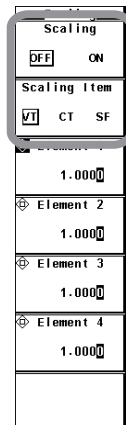

## 4.5 Setting the Scaling Function When Using VT/CT

---

- **Setting the CT Ratio**

3. Press the **Scaling Item** soft key to select CT.

- **Selecting the Target Element**

4. Press one of the soft keys corresponding to the displayed element to select the target element.
5. Press the **cursor keys** to set the CT ratio.
6. Repeat steps 4 and 5 to set the CT ratio for all elements.

Scaling
Scaling
OFF ON
Scaling Item
VT CT SF
Element 1
1.0000
Element 2
1.0000
Element 3
1.0000
Element 4
1.0000

- **Setting the Power Coefficient**

3. Press the **Scaling Item** soft key to select SF (Scaling Factor).

- **Selecting the Target Element**

4. Press one of the soft keys corresponding to the displayed element to select the target element.
5. Press the **cursor keys** to set the power coefficient.
6. Repeat steps 4 and 5 to set the SF ratio for all elements.

Scaling
Scaling
OFF ON
Scaling Item
VT CT SF
Element 1
1.0000
Element 2
1.0000
Element 3
1.0000
Element 4
1.0000

**Explanation**

Set the VT ratio when applying the output from the secondary side to the voltage input terminal. Then, set the voltage range according to the maximum value of the VT output (see section 4.3). In addition, set the CT ratio (or the transformation ratio of the current sensor that outputs current) when applying the secondary output of the CT or clamp-type current sensor that outputs current to the current input terminal. Then, set the current range according to the maximum value of the current sensor output. For details, see section 2.3.

- **Turning ON/OFF the Scaling Function**

You can select whether to multiply the applicable measurement function by the VT ratio, CT ratio, or power coefficient. When reading the measured value directly using VT or CT (or current sensor), select ON. The SCALING key illuminates when ON is selected.

Applicable measurement function: Voltage U, current I, power (P, S, and Q), maximum and minimum voltages (U+pk and U-pk), and maximum and minimum currents (I+pk and I-pk)

- ON: The measurement functions above are multiplied by the VT ratio, CT ratio, and power factor.
- OFF: The measurement functions above are not multiplied by the VT ratio, CT ratio, and power factor. The output values of the VT and CT are displayed directly as numeric data.

- **Setting the VT Ratio (VT)**

The VT ratio can be set in the range of 0.0001 to 99999.9999.

- **Setting the CT Ratio (CT)**

The CT ratio can be set in the range of 0.0001 to 99999.9999.

- **Setting the Power Factor (SF (Scaling Factor))**

The power coefficient (SF) can be set in the range of 0.0001 to 99999.9999.

**Note**

- If the result of multiplying the VT ratio, CT ratio, or power coefficient (scaling factor) to the measured value exceeds 9999.99M, the display frame of the numeric data will display [-OF-].
- For the list of the VT, CT, and power factor of all input elements, see section 3.17, "Displaying the Setup Parameter List." When the scaling function is OFF, VT, CT, and power factor are displayed as 1.0000 in the list.
- To correctly compute the power and efficiency of  $\Sigma$  functions, set the power factors of all elements so that all power units used in the computation are the same. For example, the efficiency over elements or wiring units with mixed power units of W (watt) and J (joule) cannot be computed correctly. Unify the power unit to W or J.

## 4.6 Selecting the Crest Factor

### Procedure

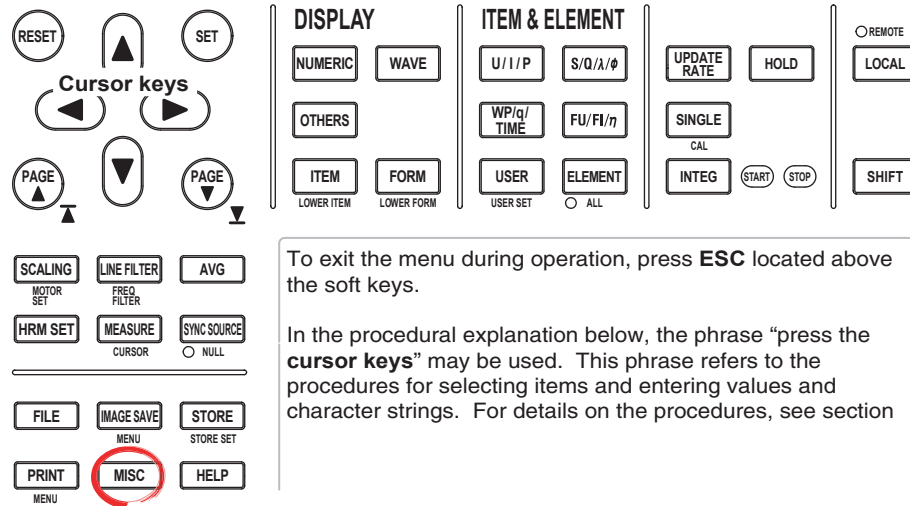

To exit the menu during operation, press **ESC** located above the soft keys.

In the procedural explanation below, the phrase “press the **cursor keys**” may be used. This phrase refers to the procedures for selecting items and entering values and character strings. For details on the procedures, see section

1. Press **MISC** to display the Misc menu.
  2. Press the **Config** soft key to display the Config menu.
- **Selecting the Crest Factor**
    3. Press **Crest Factor** to select CF3 or CF6.

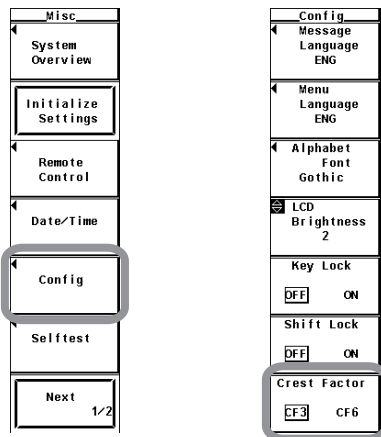

### Explanation

For details, see section 2.3.

#### • Selecting the Crest Factor

The crest factor is a ratio of the amplitude with respect to the rms value. You can select CF3 or CF6.

#### Note

- If the crest factor is selected, the voltage range and current range are set to the maximum range on all elements.
- If the crest factor is set to 6, the measurement conditions of crest factor 5 and higher required by IEC62018 are met.
- When measuring waveforms whose crest factor is less than or equal to 3, accurate measurements can be achieved by setting the crest factor to 3.

## 4.7 Setting the Measurement Period

### Procedure

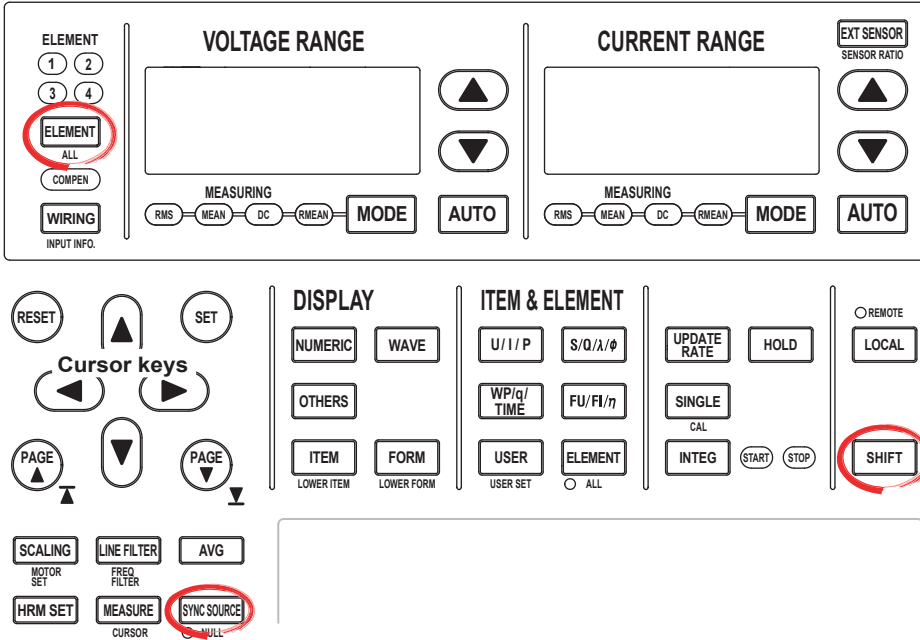

To exit the menu during operation, press **ESC** located above the soft keys.

In the procedural explanation below, the phrase “press the **cursor keys**” may be used. This phrase refers to the procedures for selecting items and entering values and character strings. For details on the procedures, see section 3.14.

1. Press **SYNC SOURCE** to display the Sync Src menu.

- **Selecting the Target Element**

2. Press **ELEMENT** to select the target element. The selected element is displayed in the upper right corner of the screen (if you selected element 1, Sync Src1 are displayed). To select all elements, press **SHIFT+ELEMENT (ALL)**.

- **Setting the Synchronization Source**

3. Press the **Item Up Exec** or **Item Down Exec** soft key to set the synchronization source. The specified synchronization source is displayed by the element displayed in the upper right corner of the screen.



## 4.7 Setting the Measurement Period

### Explanation

The measurement period is determined by the data update rate and the synchronization source specified by carrying out the procedure in this section. For details, see appendix 6. During normal measurement, the numeric data is measured/computed from the data sampled within the measurement period.

- **Display Position of the Target Element and Synchronization Source**

The target element and the synchronization source are displayed in the upper right corner of the screen when **SYNC SOURCE** is pressed.

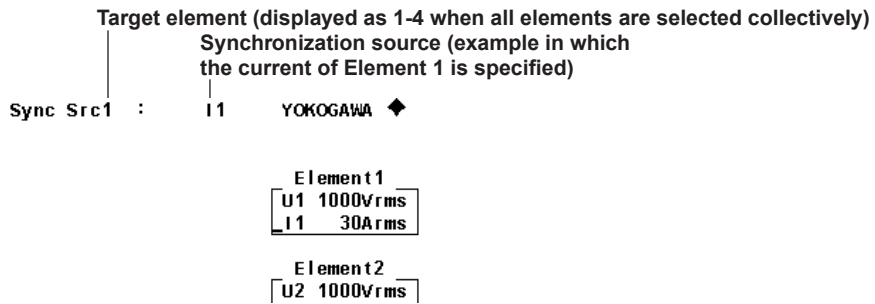

- **Selecting the Target Element to Be Specified**

Only the indicators of installed elements illuminate sequentially. When the independent setting of input elements is OFF, the element switches according to the wiring system. All elements can also be selected collectively.

- **Setting the Synchronization Source**

You can select which input signal will be the synchronization source (the zero-crossing point of the input signal to which the measurement period is synchronized) for each element or all elements collectively. Select the signal to be the synchronization source from the choices below. The selectable items vary depending on the installed elements.

U1, I1, U2, I2, U3, I3, U4, I4, Ext Clk (external clock), and None

### Note

If you specify no synchronization source by selecting "None," the entire sampled data within the data update interval is the data used to determine the numeric data. When measuring DC signals, this method can be used to prevent errors in the detection of the measurement period caused by noise.

- **When Setting the Synchronization Source to Ext Clk**

Apply a clock signal to the external clock input connector (EXT CLK) on the rear panel according to the following specifications.



- **Ext Clk Specifications**

Item	Specifications
Connector type	BNC connector
Input level	TTL
Input waveform	50% duty ratio rectangular wave



### CAUTION

Applying a voltage outside the range of 0 to 5 V to the external clock input connector (EXT CLK) can damage the instrument.

- **Measurement Period**

- When the data update rate is 50 ms, 100 ms, 5 s, 10 s, or 20 s  
You must set the measurement period. The measurement period is set between the first point where the synchronization source crosses the level zero point (center of the amplitude) on the rising slope (or falling slope) within the data update period and the last point where the synchronization source crosses the level zero point (center of the amplitude) on the rising slope (or falling slope) within the update period. If there is one or no zero crossing in the data update interval, the measurement period is set equal to the data update interval. For details, see appendix 6.

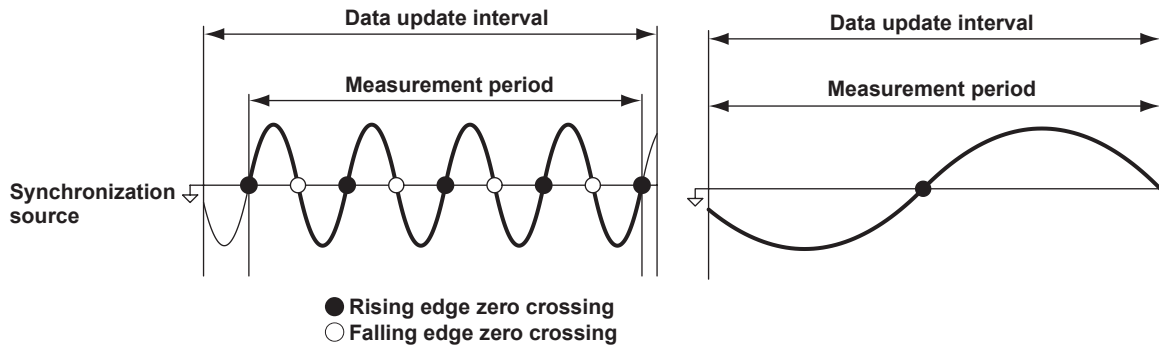

- When the data update rate is 250 ms, 500 ms, 1 s, or 2 s  
You do not have to set the measurement period. The measurement period is equal to the data update interval.

**Note**

- The measurement period for the numeric data of the maximum value (Peak) for voltage and current is the entire span within the data update period regardless of the settings above. Therefore, the measurement period for the measurement functions U+pk, U-pk, I+pk, I-pk, CfU, Cfl, FfU, and Ffl that are determined from the maximum value of the voltage and current is also the entire span within the data update period.
- The measured value may fluctuate or may not be correct if the synchronization source is not set correctly. Refer to appendix 6 when setting the synchronization source.
- For the list of measurement period (synchronization source) settings of all input elements, see section 3.17, "Displaying the Setup Parameter List." You can change the measurement period (synchronization source) with the list displayed.



## 4.8 Selecting the Input Filter

### Procedure

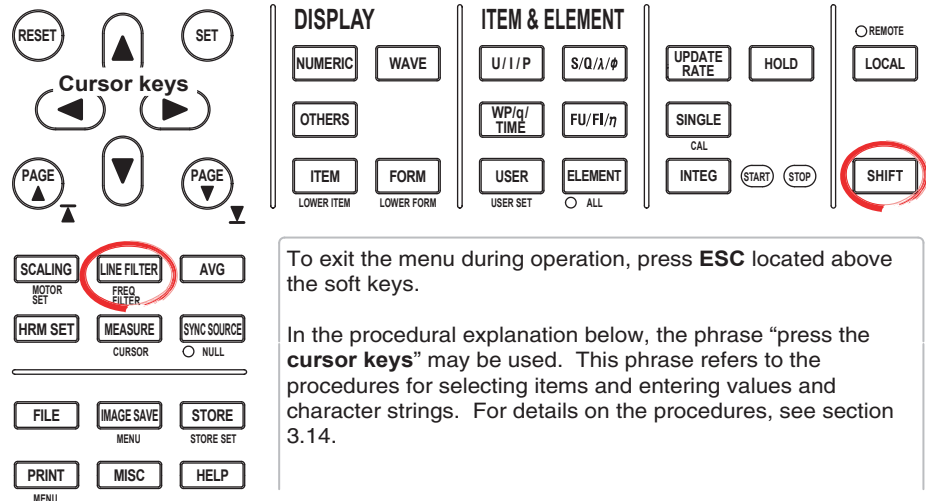

- **Selecting the Line Filter**

1. Press **LINE FILTER** to display the LINE FILTER menu.  
Only the installed elements are displayed.

- **Selecting the Target Element**

2. Press one of the soft keys corresponding to the displayed element to select the target element.

- **Selecting the Line Filter**

3. Press the **cursor keys** to select a value between OFF and 50 kHz. If any of the target elements is set to a setting other than OFF, LINE FILTER illuminates.

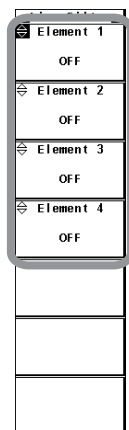

- **Selecting the Frequency Filter**

4. Press **SHIFT+LINE FILTER (FREQ FILTER)** to display the Freq Filter menu.  
Only the installed elements are displayed.
5. Press the soft key corresponding to the target element to select ON or OFF.

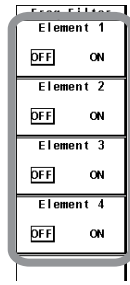

### Explanation

There are two types of input filters, line filter and frequency filter.

- **Selecting the Line Filter**

Because the line filter is inserted into the voltage and current measurement input circuit, it directly affects the voltage, current, and power measurements (see the block diagram in section 2.1). When the line filter is turned ON, the measured value does not contain high frequency components. Therefore, measurement of voltage, current, and power is possible by eliminating high frequency components from inverter waveforms, strain waveforms, etc.

- The cutoff frequency can be selected from the list of choices below.  
OFF, 500 Hz, 5.5 kHz, and 50 kHz
- If any of the target elements is set to a setting other than OFF, the LINE FILTER key illuminates.
- Selecting OFF disables the line filter.

- **Line Filter and Measurement Mode**

- The line filter setting is common to all measurement modes except cycle-by-cycle measurement mode. The initial setting is OFF.
- The line filter setting in cycle-by-cycle measurement mode is independent of the setting in other measurement modes. The initial setting is 50 kHz.

- **Selecting the Frequency Filter**

Because the frequency filter is inserted into the frequency measurement input circuit, it affects frequency measurements. In addition, if the display update interval of the WT3000 is set to 50 ms, 100 ms, 5 s, 10 s, or 20 s, it affects the detection of the measurement period for voltage, current, and power measurements (see appendix 6 and 7). In this case, the filter also acts as a filter for detecting the zero-crossing of the synchronization source signal (see section 2.2) more accurately. The frequency filter is not inserted into the voltage and current measurement input circuit. Therefore, the measured values include high frequency components even when the frequency filter is turned ON.

- The WT3000 detects the zero crossing point with a hysteresis of approximately 5% of the measurement range.
- If the line filter described above is ON, the line filter affects the frequency measurement even when the frequency filter is OFF.
- It is recommended that the frequency filter be turned ON when the input signal frequency is less than or equal to 440 Hz.

### Note

For details on selecting the line filter for the motor evaluation function, see the *Expansion Function User's Manual IM760301-51E*.

## 4.9 Selecting the Averaging Function

### Procedure

The diagram shows the instrument's soft key layout. The 'AVG' key is circled in red. The layout includes sections for Cursor keys, DISPLAY, ITEM & ELEMENT, and various soft keys like SCALING, LINE FILTER, HRM SET, MEASURE, SYNC SOURCE, FILE, IMAGE SAVE, STORE, PRINT, MISC, and HELP.

To exit the menu during operation, press **ESC** located above the soft keys.

In the procedural explanation below, the phrase “press the **cursor keys**” may be used. This phrase refers to the procedures for selecting items and entering values and character strings. For details on the procedures, see section 3.14.

1. Press **AVG** to display the Avg menu.
- **Turning ON/OFF the Averaging Function**
    2. Press the **Averaging** soft key to select ON or OFF.
  - **Selecting the Averaging Type**
    3. Press the **Avg Type** soft key to select Exp or Lin.
  - **Setting the Attenuation Constant or Average Count**
    4. Press the **cursor keys** to set the attenuation constant or the average count.  
If the averaging type is Exp (exponential averaging), set the attenuation constant. If the averaging type is Lin (moving averaging), set the average count.

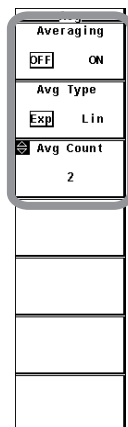

**Explanation**

For functional details, see section 2.3.

The averaging function is effective when reading of the numeric display is difficult due to fluctuations. This occurs when the fluctuation of the power supply or the load is large or when the input signal frequency is low.

**Measurement Functions of Normal Measurement**

- **Turning ON/OFF Averaging**

You can select whether to perform the specified averaging operation.

- ON: Performs averaging.
- OFF: Does not perform averaging.

- **Selecting the Averaging Type**

Select one of the choices below. For the equation of each type, see section 2.3.

- Exp: Performs exponential averaging.
- Lin: Performs moving averaging.

- **Setting the Attenuation Constant or Average Count**

If the averaging type is Exp (exponential averaging), set the attenuation constant. If the averaging type is Lin (moving averaging), set the average count.

- For Exp: Select the attenuation constant from 2, 4, 8, 16, 32, and 64.
- For Lin: Select the average count from 8, 16, 32, 64, 128, and 256.

- **Measurement Functions That Are Averaged**

The measurement functions that are directly averaged are indicated below. Other functions that use these functions in their computation are also affected by the averaging. For details regarding the determination of each measurement function, see appendix 1.

- U, I, P, S, and Q
- $\Delta F1$  to 4 (models with the delta computation function)
- Torque, speed, and Pm (models with the delta computation function)
- $\lambda$ ,  $\phi$ , Cfu, Cfl, Pc, q, q+, q-, WS, WQ,  $\eta 1$  to  $\eta 4$  are computed from the averaged P and Q.
- Slip is computed from the averaged speed.

**Measurement Functions of Harmonic Measurement (Option)**

- **Turning ON/OFF Averaging**

- **Harmonic Measurement in Normal Measurement Mode**

- If averaging is turned ON and the averaging type is Exp (exponential averaging), averaging is performed on the measurement functions of harmonic measurement (option).
    - If averaging is turned ON but the averaging type is Lin (moving averaging), averaging is not performed on the measurement functions of harmonic measurement (option).

- **Wide Bandwidth Harmonic Measurement Mode**

When averaging is turned ON, exponential averaging is performed on the measurement functions of harmonic measurement.

- **IEC Harmonic Measurement Mode**

When averaging is turned ON, exponential averaging is performed on the measurement functions of harmonic measurement.

## 4.9 Selecting the Averaging Function

---

- **Setting the Attenuation Constant**
  - **Harmonic Measurement in Normal Measurement Mode**

If averaging is turned ON and the averaging type is Exp (exponential averaging), exponential averaging is performed using the selected attenuation constant (2, 4, 8, 16, 32, or 64).
  - **Wide Bandwidth Harmonic Measurement Mode**

When averaging is turned ON, exponential averaging is performed using the attenuation constant that you select from 2, 4, 8, 16, 32, and 64.
  - **IEC Harmonic Measurement Mode**

You cannot select the attenuation constant. Averaging is performed using the attenuation constant that is defined by the standard.
- **Measurement Functions That Are Averaged**

The measurement functions that are directly averaged are indicated below. Other functions that use these functions in their computation are also affected by the averaging. For details regarding the determination of each measurement function, see appendix 1.

  - $U(k)$ ,  $I(k)$ ,  $P(k)$ ,  $S(k)$ , and  $Q(k)$
  - $\lambda(k)$  and  $\phi(k)$  are computed from the averaged  $P(k)$  and  $Q(k)$ .
  - $Z$ ,  $R_s$ ,  $X_s$ ,  $R_p$ ,  $X_p$ ,  $Uhdf$ ,  $lhdf$ ,  $Phdf$ ,  $Uthd$ ,  $lthd$ ,  $Pthd$ ,  $Uthf$ ,  $lthf$ ,  $Utif$ ,  $ltif$ ,  $hvf$ , and  $hcf$
  - \*  $k$ : harmonic order

### Note

---

- When averaging is turned ON, the average value of multiple measurements is determined and displayed. Therefore, if the input signal changes steeply, the response for the measured value to follow up on the change is slow.
  - The larger the value of the attenuation constant of exponential averaging or the average count of moving average, the more stable the measured value (response to the input change is slow).
  - The following measurement functions are not affected by averaging.
    - Measurement functions of normal measurement  
 $fU$ ,  $fl$ ,  $U+pk$ ,  $U-pk$ ,  $I+pk$ ,  $I-pk$ ,  $Time$ ,  $WP$ ,  $WP+$ ,  $WP-$ ,  $WPS$ ,  $WP+S$ ,  $WP-S$ , and  $SyncSp$   
(models with the motor evaluation function)
    - Measurement functions of harmonic measurement (option)  
 $\phi U(k)$ ,  $\phi I(k)$ ,  $\phi U_i-U_j$ ,  $\phi U_i-U_k$ ,  $\phi U_i-l_i$ ,  $\phi U_i-l_j$ , and  $\phi U_i-l_k$   
\*  $k$ : harmonic order
- 

## Measurement Functions of Voltage Fluctuation and Flicker Measurement Mode and Cycle-by-Cycle Measurement Mode

Averaging is not performed. The average setting is invalid.

## 4.10 Selecting the Data Update Rate

### Procedure

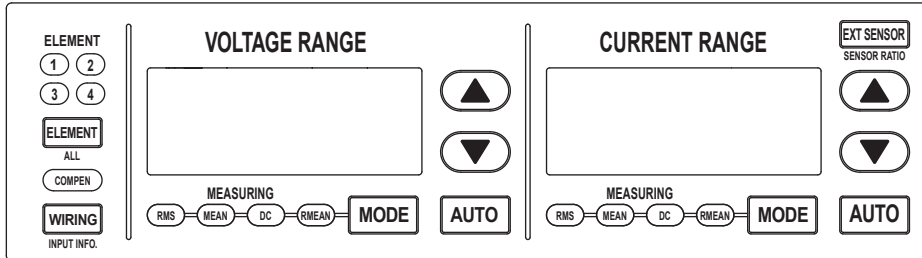

To exit the menu during operation, press **ESC** located above the soft keys.

In the procedural explanation below, the phrase “press the **cursor keys**” may be used. This phrase refers to the procedures for selecting items and entering values and character strings. For details on the procedures, see section 3.14.

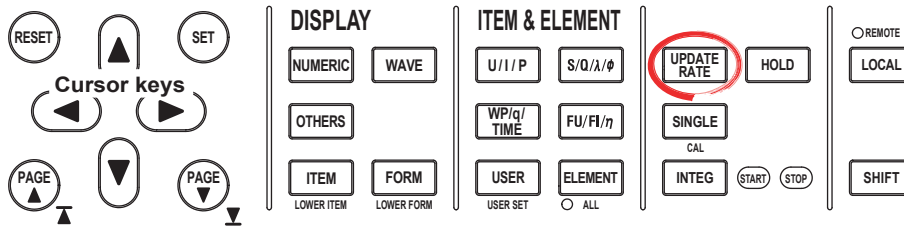

1. Press **UPDATE RATE** to display the Update Rate menu.
2. Press the **Update Rate Up Exec** or **Update Rate Down Exec** soft key to change the data update rate. The specified data update rate is displayed in the upper right corner of the screen.
  - Pressing the Update Rate Up Exec soft key increases data update rate.
  - Pressing the Update Rate Down Exec soft key decreases data update rate.



## 4.10 Selecting the Data Update Rate

### Explanation

For details, see section 2.3.

Excluding the cases when the screen is set to the displays listed below, the selected interval is used pass the numeric data to the D/A output and communication output as well as storing the numeric data (to the internal memory).

- Waveform display
- Split display including a waveform display

- **Display Position of the Data Update Rate**

The data update rate is displayed in the upper right corner of the screen when the UPDATE RATE key is pressed.

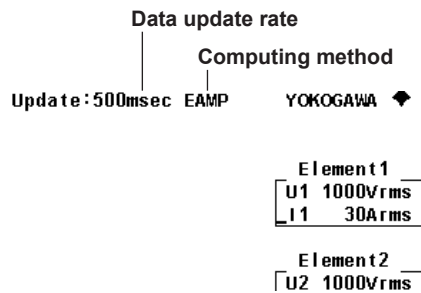

- **Limitation on the Data Update Rate by Measurement Modes**

- **Normal Measurement Mode, Waveform Computation Mode, and FFT Mode**

Select from the choices below. The numeric data is updated at the selected interval. To capture relatively fast load fluctuations in the power system, select a fast data update rate. To capture relatively low frequency signals, select a slow data update rate.

50 ms, 100 ms, 250 ms, 500 ms, 1 s, 2 s, 5 s, 10 s, and 20 s

- **Wide Bandwidth Harmonic Measurement Mode and IEC Harmonic Measurement Mode**

The data update rate setting is invalid. The data update rate is determined automatically by the fundamental frequency of the PLL source and the number of periods of the PLL source used for the analysis.

- **Voltage Fluctuation and Flicker Measurement Mode**

The data update rate is fixed to 2 s.

- **Cycle-by-Cycle Measurement Mode**

The data update rate setting is invalid. The data update rate is automatically determined by the fundamental frequency and the number of measurement cycles of the synchronization source.

### Note

- In some cases, the display update rate of the numeric data and waveform data that are displayed on the screen may take longer than the data update rate.
- The lower frequency limit of the AC signal that can be measured varies depending on the data update rate. The measured value may not be stable if an AC signal of a frequency lower than the lower limit of measurement frequency (see section 12.4) is measured.
- The WT3000 automatically switches the method of computing the measured values according to the data update rate. For details, see appendix 7.
- The data update rate of the FFT is determined automatically from the number of FFT points. For details, see chapter 11 in the *Extension Function User's Manual IM760301-51E*.
- The display update interval in waveform computation mode and FFT mode is the data update rate + computation time.

## 4.11 Hold and Single Measurement

### Procedure

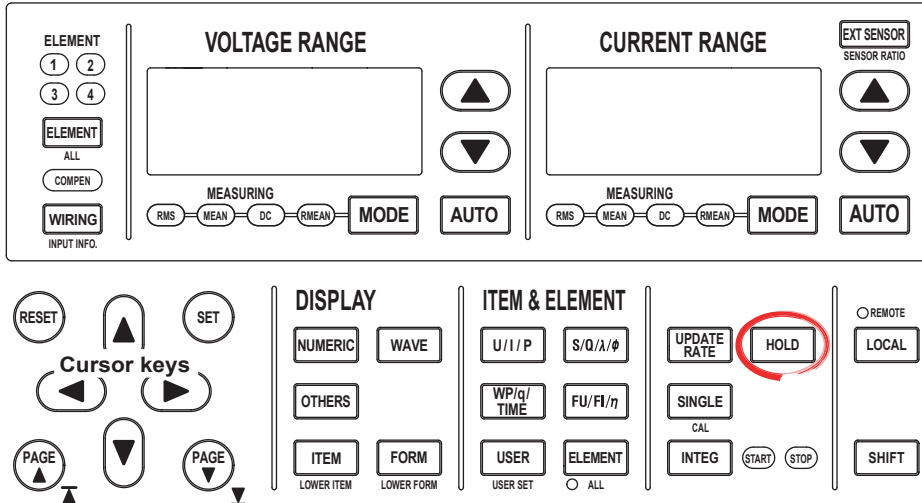

To exit the menu during operation, press **ESC** located above the soft keys.

In the procedural explanation below, the phrase “press the **cursor keys**” may be used. This phrase refers to the procedures for selecting items and entering values and character strings. For details on the procedures, see section 3.14.

- **Holding the Numeric Data Display**

1. Press **HOLD**. The HOLD key illuminates, and the numeric data display is held.

- **Performing a Single Measurement**

2. Press **SINGLE**. The measurement is performed once and the instrument enters the hold condition.

- **Releasing the Hold Operation**

3. Press **HOLD** while the values are held. The HOLD key turns OFF, and the numeric data display is updated.

### Explanation

- **Hold**

This function aborts the measurement and display operations that are performed at the data update rate and holds the data display of various functions. The D/A output, the numeric data list that the built-in printer prints, the communication output, and other values are set to the held numeric data.

- **Single Measurement**

While in the hold condition, the measurement is performed once at the specified data update rate and enters the hold condition. If you press the SINGLE key when not in hold condition, measurement is restarted from that point.

### Note

For details on the hold function during integration, see section 5.14.



# 5.1 Displaying Numeric Data and Changing the Displayed Items

## Procedure

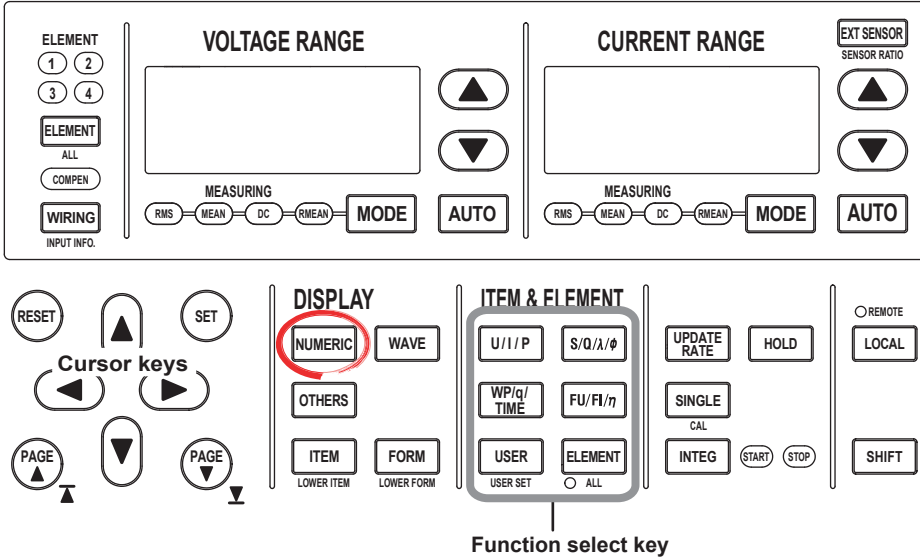

To exit the menu during operation, press **ESC** located above the soft keys.

In the procedural explanation below, the phrase “press the **cursor keys**” may be used. This phrase refers to the procedures for selecting items and entering values and character strings. For details on the procedures, see section 3.14.

- **Displaying Numeric Data on the Entire Screen**
  1. Press **NUMERIC** to display numeric data.
- **Displaying Numeric Data by Dividing the Display into Halves (Split Display)**
  1. Press **OTHERS** to display the Others menu.
  2. Press any of the soft keys from **Numeric+wave**, **Numeric+Bar**<sup>\*1</sup>, **Numeric+Trend**, **Numeric+Math**<sup>\*2</sup>, and **Numeric+FFT**<sup>\*2</sup> to select the display mode.

<sup>\*1</sup> Displayed only on models with the advanced computation (/G6) or harmonic measurement (/G5) option.

<sup>\*2</sup> Displayed only to products with the advanced computation (/G6) option.

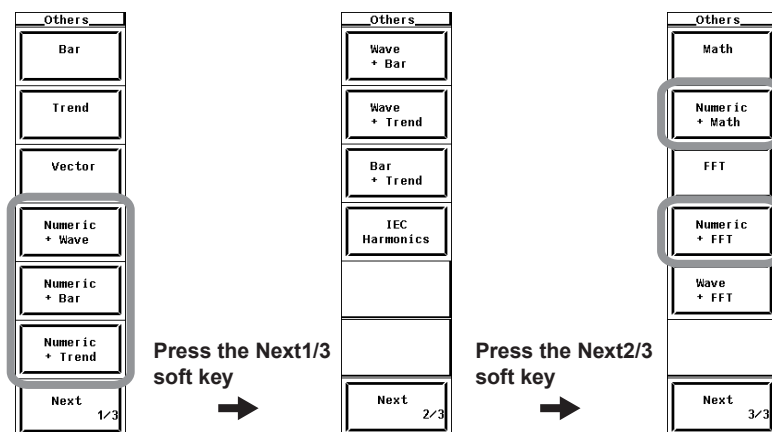

If wide bandwidth harmonic measurement mode is enabled on models with the advanced computation (/G6) option, switch to normal measurement mode. For the procedure, see section 3.16.

## 5.1 Displaying Numeric Data and Changing the Displayed Items

---

The following procedures are given as typical examples in which the display mode is set to Numeric (numeric data on the entire screen).

- **Selecting the Number of Displayed Items**

2. Press **FORM** to display the Numeric Form menu.
3. Press any of the soft keys from **4 Items**, **8 Items**, **16 Items**, **All Items**, **Single List**<sup>\*</sup>, and **Dual List**<sup>\*</sup> to select the number of displayed items.

<sup>\*</sup> Only on models with the advanced computation (/G6) or harmonic measurement (/G5) option.

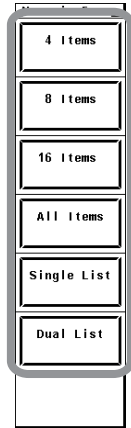

There are three methods to select the item to change, measurement function, and element/wiring unit.

- Select using the function select keys.
- Select using the user-defined function select key (USER key).
- Select from the menu.

• **Changing Using the Function Select Keys**

The display of measurement functions of U, I, P, S, Q, λ, φ, WP, q, TIME, FU, FI, and η and the element/wiring unit can be changed using function select keys.

• **Selecting the Item to Be Changed**

4. Press **ESC** to clear the Numeric Form menu.
5. Press the **cursor keys** to select the item to be changed. The item to be changed is highlighted.

• **Changing the Measurement Function**

6. Press the **U/I/P, S/Q/λ/φ, WP/q/Time, or FU/FI/η** function select key to select the displayed measurement function.  
 Press the key corresponding to the measurement function you wish to display.  
 The display switches each time the key is pressed as follows: U -> I -> P -> original display.

• **Changing the Element/Wiring Unit**

7. Press **ELEMENT** to select the element/wiring unit.

• **Changing the Element/Wiring Unit Collectively**

8. Press **SHIFT+ELEMENT (ALL)**. ALL LED illuminates, and the element/wiring unit of all the displayed items on the displayed page can be changed collectively. This completes the procedure for changing the displayed items using the function select keys.

• **Changing Using the Function Select Key (USER Key)**

By assigning measurement functions to the USER key, up to four measurement functions can be directly displayed.

• **Assigning Measurement Functions to the USER Key**

9. Press **SHIFT+USER (USER SET)** to display the User Reserved menu.
10. Press any of the soft keys from Function 1 to 4 to select the desired Function.  
 The measurement function selection box appears.
11. Press the **cursor keys** to select any of the measurement functions starting with None.
12. Press **SET**. The symbol for the selected measurement function is displayed at the highlighted position.

• **Changing the Measurement Function with the USER Key**

13. Press **USER** to select the measurement function in the same fashion as step 6.

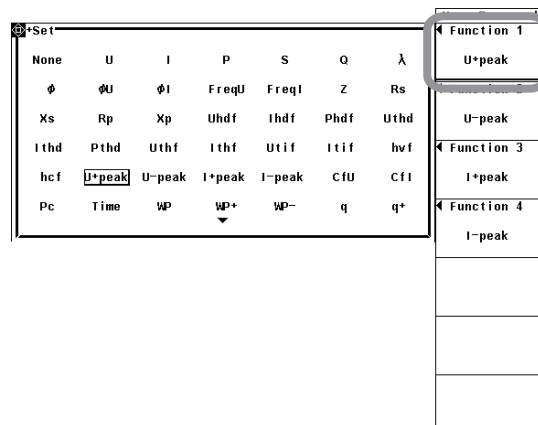

## 5.1 Displaying Numeric Data and Changing the Displayed Items

- **Selecting from the Menu**

4. Press **ITEM** to display the Numeric menu.

- **Selecting the Item to Be Changed**

5. Press the **Item No.** soft key.
6. Press the **cursor keys** to select the item to be changed. The item to be changed is highlighted.

- **Changing the Measurement Function**

7. Press the **Function** soft key to display the measurement function selection box.
8. Press the **cursor keys** to select any of the measurement functions starting with None.
9. Press **SET**. The symbol for the selected measurement function and the numeric data are displayed at the highlighted position.

- **Changing the Element/Wiring Unit**

10. Press the **Element/Σ** soft key to display the element/wiring unit selection box.
11. Press the **cursor keys** to select any of the elements/wiring units starting with Element1.
12. Press **SET**. The symbol for the selected element number or wiring unit and the numeric data are displayed at the highlighted position. This completes the procedure for changing the displayed items using the menu.

\* For details on changing the harmonic order of the measurement functions of harmonic measurement, see the *Expansion Function User's Manual IM760301-51E*.

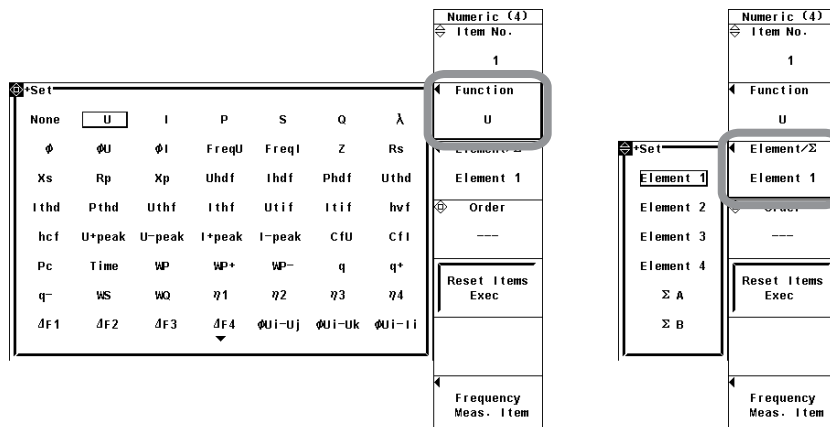

- **Page Scrolling the Display**

15. Press **PAGE ▼** or **PAGE ▲** to scroll the page.
  - Press **PAGE ▼** to display the next page.
  - Press **PAGE ▲** to display the previous page.

- **Jumping to the Last or First Page**

16. Press **SHIFT+PAGE ▼ (▼)** or **SHIFT+PAGE ▲ (▲)** to jump the page.
  - Press **SHIFT+▼ (▼)** to display the last page.
  - Press **SHIFT+▲ (▲)** to display the first page.

• **Resetting the Order of the Displayed Items**

1. Press **ITEM** to display the Numeric menu.
2. Press the **Reset Items Exec** soft key. An Alert dialog box appears.
3. Press the **cursor keys** to select OK or Cancel.
4. Select OK and press **SET** to reset the order of the displayed items on all pages. If you select Cancel and press **SET** the order of the displayed items are not reset.

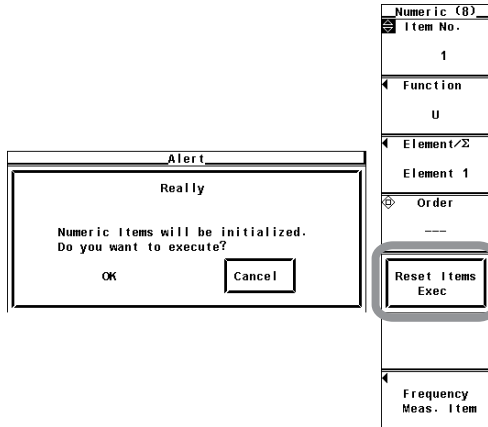

**Explanation**

A display example is shown below.

Displayed when the displayed item can be changed using the function select key. The item to be changed is highlighted.

The color changes from green to red when the input signal level exceeds approx. three or six times the specified measurement range when the crest factor is set to 3 or 6, respectively. The first and second lines correspond to voltage and current, respectively. The conditions of the input signals of elements 1 to 4 are displayed in order from the left.

Displayed only on models with the motor evaluation function (motor version). The color changes from green to red when the analog revolution/torque signal level exceeds approx. 150% of the specified measurement range. For pulse revolution signal, the color changes from green to red when approx. ±5 V is exceeded. The first and second lines correspond to the conditions of rotating speed and torque, respectively.

**Page bar**

The current page is highlighted. If page scrolling is possible using PAGE ▼ or PAGE ▲, the top and bottom sections of the page bar shows ▲▼. If page scrolling is not possible, △▽ is shown.

**Data update count**

- The data update count is displayed under Update in the lower left corner of the screen.
- Press HOLD to hold the data update count. Press HOLD again to release.
- When the value exceeds 65535, it returns to 0.
- The data update count is reset to 0 if the power is turned OFF or a setting such as the measurement range or filter is changed.

**Measurement Functions of Normal Measurement**

• **Symbol and Meaning of the Displayed Measurement Functions**

U (voltage Urms, Umn, Udc, Urmn),	I (current Irms, Imn, Idc, Irmn)
P (active power),	S (apparent power)
Q (reactive power),	$\lambda$ (power factor)
$\phi$ (phase difference),	fU/fl (or freqU/freqI voltage/current frequency)
U+pk/U-pk (voltage maximum/minimum),	I+pk/I-pk (current maximum/minimum)
CfU/CfI (voltage/current crest factor),	Pc (corrected power)
WP (watt hour, sum of positive and negative watt hours),	WP+ (positive watt hour consumed)
WP- (negative watt hour returned to the power supply),	q (ampere hour, sum of positive and negative ampere hours)
q+ (positive current hour consumed),	q- (negative current hour returned to the power supply)
WS (volt-ampere-hour),	WQ (var-hour)
Time (integration time),	$\eta$ 1 to $\eta$ 4 (efficiency)
F1 to F20 (user-defined functions),	$\Delta$ F1 to F4 (delta computation: option)
Speed* (rotating speed),	Torque*
Pm* (motor output, mechanical power),	SyncSp* (synchronous speed)
Slip,*	

and the measurement functions of harmonic measurement (for details, see chapter 7 in the *Expansion Function User's Manual IM760301-51E*)

\* Displayed on models with the motor version.

**Example The True Rms Value of the Voltage of Element 1**

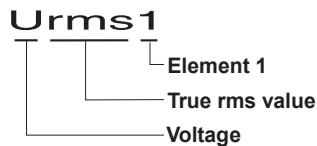

**Simple Average of the Current of the Elements Combined by Wiring Unit  $\Sigma$ A**

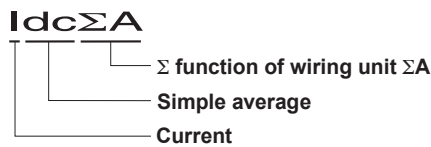

• **Selecting the Display Mode**

Select the display format of the numeric data from below. [-----] (no data) is displayed in places where the measurement function is not selected or where no numeric data is present.

• **Displaying the Numeric Data on the Entire Screen**

Press the NUMERIC key to display the numeric data on the entire screen.

• **Displaying Numeric Data by Dividing the Display into Halves (Split Display)**

• **Numeric+Wave**

The numeric data and waveform are displayed separately in the top and bottom windows. For details on setting the waveform display, see section 4.2 and chapter 9.

• **Numeric+Trend**

The numeric data and trend are displayed separately in the top and bottom windows. For details on setting the trend display, see section 4.5 and chapter 10.

• **Numeric+Bar**

This mode is selectable only on models with the advanced computation (/G6) or harmonic measurement (/G5) option.

The numeric data and bar graph of harmonics are displayed separately in the top and bottom windows. For details on how to set the bar graph display, see the *Expansion Function User's Manual IM760301-51E*.

- **Selecting the Number of Displayed Items**

Select the number of numeric data items that are displayed simultaneously from the choices below.

- 4 Items
  - When the display mode is Numeric, Numeric + Wave, Numeric + Bar<sup>\*1</sup>, and Numeric + Trend, four numeric data values are displayed in one column.
- 8 Items
  - When the display mode is Numeric, eight numeric data values are displayed in one column.
  - When the display mode is Numeric + Wave, Numeric + Bar<sup>\*1</sup>, and Numeric + Trend, eight numeric data values are displayed in two columns.
- 16 Items
  - When the display mode is Numeric, Numeric + Wave, Numeric + Bar<sup>\*1</sup>, 16 numeric data values are displayed in two columns.
- All Items
 

A table is displayed indicating the numeric data of items with measurement functions listed vertically and symbols indicating elements and wiring units listed horizontally. The number of displayed items varies depending on the number of installed elements. The displayed item cannot be changed independently using the ITEM key. Switch the display by page scrolling.
- Single List<sup>\*1</sup>
  - When the display mode is Numeric, 42 numeric data values for a single measurement function are displayed in two columns.
  - When the display mode is Numeric + Wave, Numeric + Bar<sup>\*1</sup>, 22 numeric data values for a single measurement function are displayed in two columns.
- Dual List<sup>\*1</sup>
  - When the display mode is Numeric, 22 numeric data values each for two measurement functions are displayed in each column.
  - When the display mode is Numeric + Wave, Numeric + Bar<sup>\*1</sup>, 11 numeric data values each for two measurement functions are displayed in each column.

<sup>\*1</sup> Displayed only on models with the advanced computation (/G6) or harmonic measurement (/G5) option. For the procedure of changing the displayed items on the Single List or Dual List, see chapter 7 in the Expansion Function User's Manual IM760301-51E.

**Note**

- [-----] (no data) is displayed in places where the measurement function is not selected or where no numeric data is present.
- If Urms, Umn, Udc, Urmn, Irms, Imn, Idc, or Irmn exceeds 140% of the measurement range, overrange [-OL-] is displayed.
- P shows overrange [-OL-] if the measured values of either the voltage or current exceeds 140% of the measurement range.
- If the measured or computed result cannot be displayed using the specified decimal position or unit, overflow [-OF-] is displayed.
- If Urms or Irms is less than or equal to 0.3% (when the crest factor is set to 3, less than or equal to 0.6% if the crest factor is set to 6) or Umn, Urmn, Imn, or Irmn is less than or equal to 1% of the measurement range (when the crest factor is set to 3, less than or equal to 2% if the crest factor is set to 6), Urms, Umn, Urmn, Irms, Imn, Irmn, and the measurement functions that are determined using these measurement functions display zeroes.  $\lambda$  or  $\phi$  displays an error.
- The value of U+pk and I+pk when there are no positive measured values, and the value of U-pk and I-pk when there are no negative measured values are as follows.
  - Products of Firmware Version 4.04 or Later: The maximum value measured is displayed for U+pk and I+pk, and the minimum value measured is displayed for U-pk and I-pk.
  - Products of Firmware Versions Prior to 4.04: Zero is displayed for U+pk, I+pk, U-pk and I-pk.
- If the measured value of frequency is outside the measurement range, fU or fI displays an error.
- If the power factor  $\lambda$  is greater than 1 and less than or equal to 2,  $\lambda$  becomes [1].  $\phi$  displays zero.
- If the power factor  $\lambda$  is greater than 2,  $\lambda$  and  $\phi$  display errors.
- If the voltage or current mode is not RMS, CfU or CfI displays no numeric data [-----].

## 5.1 Displaying Numeric Data and Changing the Displayed Items

- **Changing the Measurement Function**

- The types of measurement functions that can be selected are the items that are indicated in “Types of Measurement Functions during Normal Measurement” of section 2.2, “User-Defined Function” and Corrected Power of section 2.5, “Measurement Functions of Integration,” “Motor Evaluation Function (Motor Version),” “Delta Computation (Option),” and “Harmonic Measurement (Option)” in section 2.6.

\* For details, see the *Expansion Function User’s Manual IM760301-51E*.

- You can also select not to display the measurement functions (None).
- The number (1, 2, 3, and 4) that is attached to the measurement function symbol of the delta computation has no relation to the element number.
- The number attached to the user-defined function F1 to F20 is a portion of the measurement function symbol. It is not related to the element number.

- **Changing the Element/Wiring Unit**

- You can select the element/wiring unit from the choices below. The selectable items vary depending on the installed elements. Element1, Element2, Element3, Element4, ΣA, and ΣB
- If there are no elements that are assigned to the selected wiring unit, there is no numeric data. Thus, [-----] (no data) is displayed in this case. For example, if elements are assigned to ΣA and no elements are assigned to ΣB, then the measurement function for ΣB shows [-----] (no data).

U rms1	0.10496	<sub>kV</sub>		U rms1	0.10513	<sub>kV</sub>
I rms1	1.6946	<sub>A</sub>	Change the measurement function of the third item →	I rms1	1.6929	<sub>A</sub>
P 1	0.1650	<sub>kW</sub>		λ 1	0.92791	
S 1	0.1779	<sub>kVA</sub>	Change the element of the third item ↘	S 1	0.1780	<sub>kVA</sub>
				U rms1	0.10476	<sub>kV</sub>
				I rms1	1.7020	<sub>A</sub>
				P 2	-0.0000	<sub>W</sub>
				S 1	0.1783	<sub>kVA</sub>

- **Resetting the Order of Display Items**

You can reset the displayed order of numeric data to a preset order. For details on the reset items, see appendix 2, “List of Initial Settings and Display Order of Numeric Data.”

**Note**

- For the meanings of the measurement function symbols that are displayed, see section 2.2, “Measurement Functions and Measurement Periods,” 2.5, “Computation,” 2.6, “Integration,” appendix 1, “Symbols and Determination of Measurement Functions,” and chapter 6, “Delta Computation” in the *Expansion Function User’s Manual IM760301-51E*.
- For the procedure of changing the displayed items of the measurement functions of harmonic measurement, see chapter 7 in the *Expansion Function User’s Manual IM760301-51E*.
- For details on the wiring units expressed as ΣA and ΣB, see section 4.1, “Selecting the Wiring System.”
- If you supply current exceeding approximately 2.8 Arms to the 2-A input element, the protection circuit activates. The measured value may become 0 A, but the input peak over-range indicator at the top section of the screen illuminates in red.



## 5.2 Selecting the Voltage/Current Mode (RMS, MEAN, DC, or RMEAN)

### Procedure

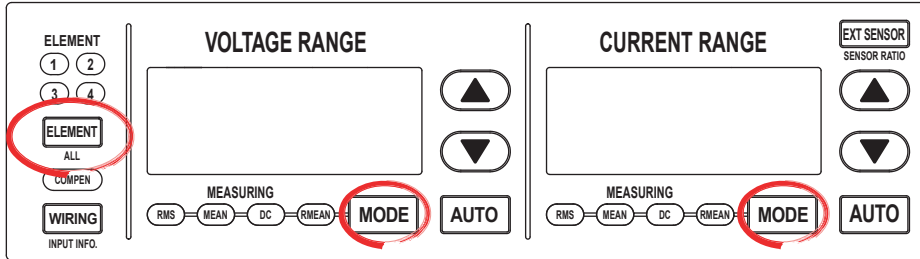

To exit the menu during operation, press **ESC** located above the soft keys.

In the procedural explanation below, the phrase “press the **cursor keys**” may be used. This phrase refers to the procedures for selecting items and entering values and character strings. For details on the procedures, see section 3.14.

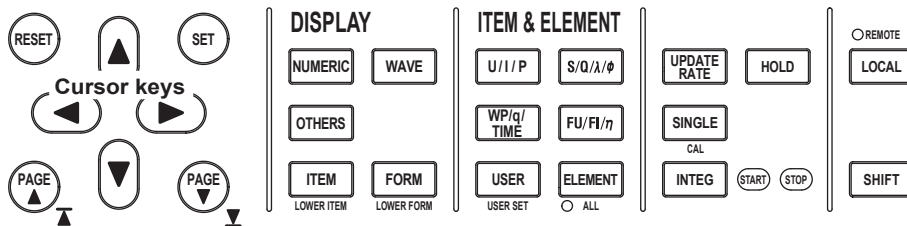

#### • Selecting the Target Element

1. Press **ELEMENT** to select the target element. The corresponding element indicator above the key illuminates.

#### • Selecting the Voltage Mode

2. Press **VOLTAGE RANGE MODE** to select one of the modes from RMS to RMEAN.
3. Repeat steps 1 and 2 to select the voltage mode of all elements.

#### • Selecting the Current Mode

4. Press **CURRENT RANGE MODE** to select one of the modes from RMS to RMEAN.
5. Repeat steps 1 to 4 to select the current mode of all elements.

### Explanation

- The voltage and current modes can be selected from the following four modes.
  - RMS: True rms value
  - MEAN: Rectified mean value calibrated to the rms value
  - DC: Simple average
  - RMEAN: Rectified mean value
- The initial setting is RMS. For the method of computing the voltage and current in each mode, see appendix 1.
- When the independent setting of input elements is OFF, the element switches according to the wiring system.
- To measure the RMS and MEAN of voltage simultaneously, use the user-defined function. For details, see section 5.4.
- The voltage and current mode selections are invalid in wide bandwidth harmonic measurement mode and IEC harmonic measurement mode. In this case, the total value of the rms values of each order in the range between the maximum and minimum values of the measured order specified in the harmonic measurement (option) menu is displayed.
- The voltage and current mode selections are invalid in voltage fluctuation and flicker measurement mode.

## 5.3 Selecting the Frequency Measurement Source

### Procedure

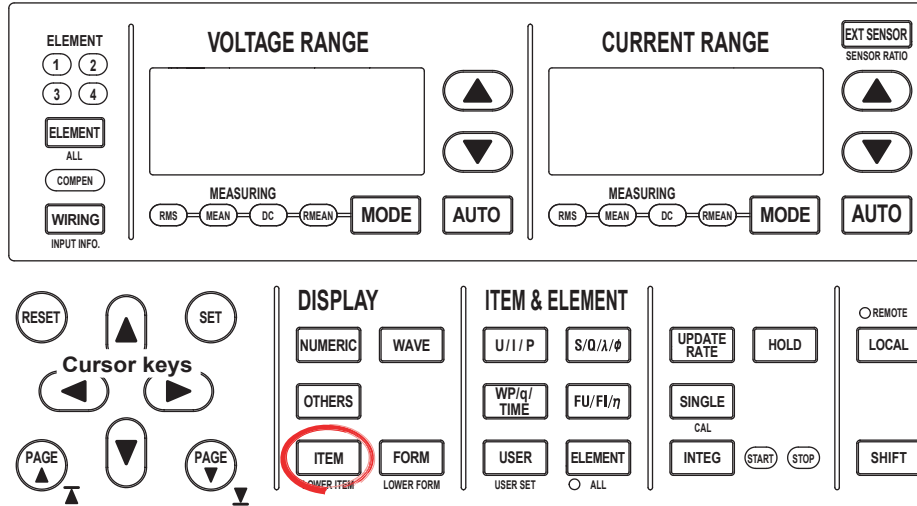

To exit the menu during operation, press **ESC** located above the soft keys.

In the procedural explanation below, the phrase “press the **cursor keys**” may be used. This phrase refers to the procedures for selecting items and entering values and character strings. For details on the procedures, see section 3.14.

1. Press **ITEM** to display the Numeric menu.
2. Press the **Frequency Meas Item** soft key to display the Frequency Meas Item dialog box.  
Only the input signal of installed elements are displayed.
3. Press the **cursor keys** to select Freq1 or Freq2.
4. Press **SET**. A box used to select the frequency measurement source appears.
5. Press the **cursor keys** to select the input signal for measuring the frequency.
6. Press **SET** to confirm the frequency measurement source.

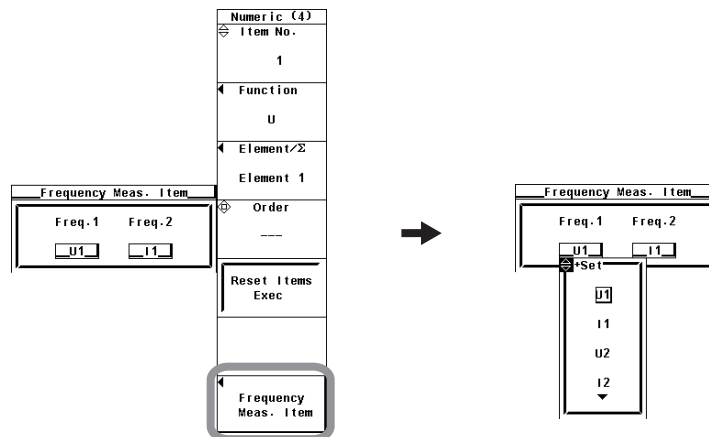

#### Explanation

- You can select two of the input signals of the installed elements to measure the frequency. However, there is no need to specify the frequency measurement signals on the models with the frequency measurement add-on option, because frequencies of all elements can be measured. Thus, the Frequency Meas Item soft key does not appear even when ITEM is pressed.
- The frequency measurement source selection is invalid in cycle-by-cycle measurement mode.

#### Note

- If the frequency measurement is not stable such as due to noise, try using the frequency filter as explained in section 4.8.
  - Frequency cannot be detected if the AC amplitude is small. For details on the detection level for frequency measurement, see section 12.5.
  - The measured data for the frequencies of input signals that are not specified for the frequency measurement are shown as [-----] (no data).
-

## 5.4 Setting the User-Defined Function

### Procedure

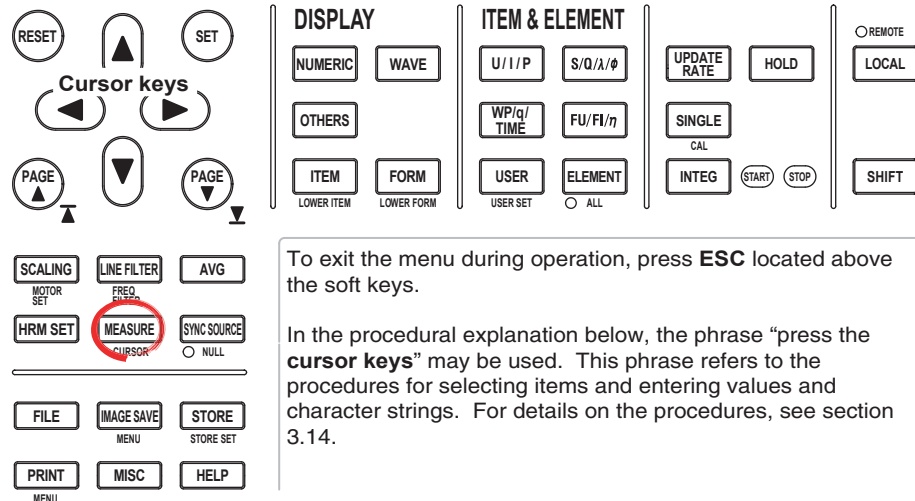

1. Press **MEASURE** to display the Measure menu.
  2. Press the **User Defined Function** soft key to display the User Defined Function menu.
  3. Press any of the soft keys from **User Defined F1 to F20** to select the user-defined function to be assigned. The User Defined Function dialog box opens.
- **Turning ON/OFF the User-Defined Function Computation**
    4. Press the **cursor keys** to select the desired user-defined function.
    5. Press **SET** to select ON or OFF.

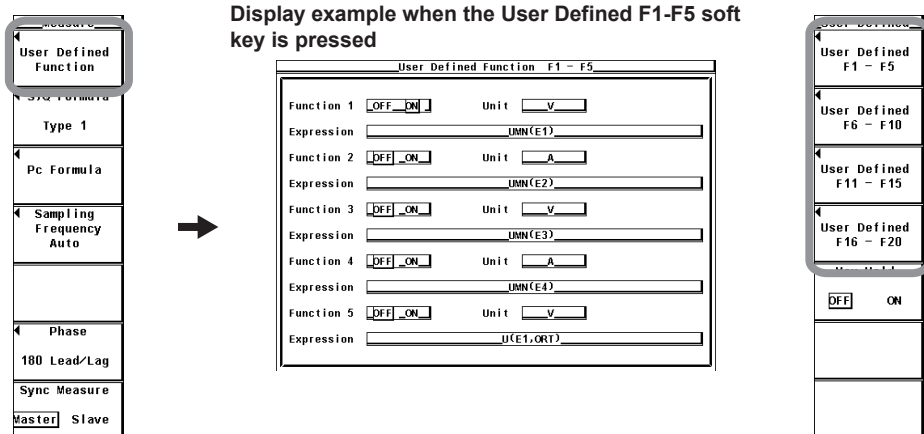

- **Setting the Unit**

5. Press the **cursor keys** to select Unit.
6. Press **SET**. A keyboard appears.
7. Use the **keyboard** to set the unit.

For keyboard operations, see section 3.14, “Entering Values and Strings.”

- **Setting the Equation**

8. Press the **cursor keys** to select Expression.
9. Press **SET**. A keyboard appears.
10. Use the **keyboard** to set the equation.

For keyboard operations, see section 3.14, “Entering Values and Strings.”

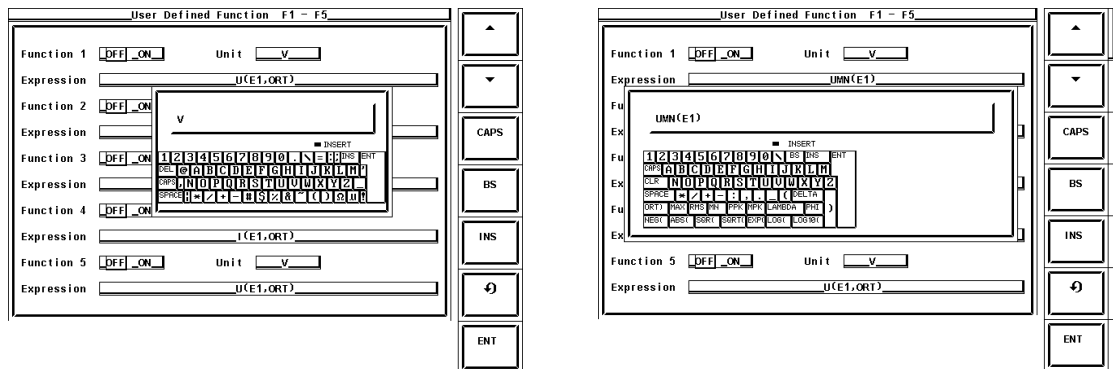

### Explanation

An equation can be created by combining the measurement function symbols. Using the numeric values of the measurement functions, the numeric data of the new equation can be determined. It is convenient to use a USB keyboard (option) when entering an equation or string with many characters.

- **Limitation on the User-Defined Functions by Measurement Mode**

There are limitations on the user-defined functions in measurement modes other than normal measurement mode.

- **IEC Harmonics Measurement, Voltage Fluctuation and Flicker Measurement, and Cycle-by-Cycle Measurement Modes**

The user-defined function cannot be used.

- **Wide Bandwidth Harmonic Measurement Mode, Waveform Computation Mode, and FFT Mode**

Some operands cannot be computed. For details, see appendix 12.

- **Turning ON/OFF the User-Defined Function Computation**

You can select whether to perform the specified user-defined function computation.

- ON  
Executes the computation.
- OFF  
Does not perform the computation.

- **Setting the Unit**

- Number of Characters  
Eight characters or less. However, not all eight characters can be shown on the numeric data display. This depends on the number of displayed items (see section 5.1).
- Types of Characters  
Characters that are displayed on the keyboard and spaces

## 5.4 Setting the User-Defined Function

- **Equation Types**

The combination of the measurement function and element number (Urms1, for example) can be used as an operand to create up to 20 equations (F1 to F20). There can be up to 16 operands in one equation. Some operands cannot be computed in measurement modes other than normal measurement mode. For details, see appendix 12.

- **Measurement Functions for Computation**

The operators for the measurement functions are shown below in the form **measurement function: operand**.

U: U( , )	Urms: URMS( )	Umn: UMN( )	I: I( , )
P: P( , )	S: S( , )	Q: Q( , )	λ: LAMBDA( , )
φ: PHI( , )	fU: FU( )	fl: FI( )	U+pk: UPPK( )
U-pk: UMPK( )	I+pk: IPPK( )	I-pk: IMPK( )	P+pk: IPPK( ) <sup>*1</sup>
P-pk: IMPK( ) <sup>*1</sup>	CfU: CFU( )	Cfl: CFI( )	Pc: PC( )
η1: ETA1( )	η2: ETA2( )	η3: ETA3( )	η4: ETA4( )
Wp: WH( )	Wp+: WHP( )	Wp-: WHM( )	q: AH( )
q+: AHP( )	q-: AHM( )	WS:SH( )	WQ:QH( )
Time: TI( )			

<sup>\*1</sup> Can be used on WT3000s with firmware version 5.01 or later.

- **The following measurement functions can also be specified on models with the motor evaluation function (motor version).**

Speed: SPEED( )	Torque: TORQUE( )	Pm: PM( )
Slip: SLIP( )	SyncSp: SYNC( )	

- **The following measurement functions can also be specified on models with delta computation (option).**

ΔF1: DELTA1( )	ΔF1rms( ): DELTAF1RMS( ) <sup>*2</sup>	ΔF1mn( ): DELTAF1MN( ) <sup>*2</sup>
ΔF2: DELTA2( )	ΔF2rms( ): DELTAF2RMS( ) <sup>*2</sup>	ΔF2mn( ): DELTAF2MN( ) <sup>*2</sup>
ΔF3: DELTA3( )	ΔF3rms( ): DELTAF3RMS( ) <sup>*2</sup>	ΔF3mn( ): DELTAF3MN( ) <sup>*2</sup>
ΔF4: DELTA4( )	ΔF4rms( ): DELTAF4RMS( ) <sup>*2</sup>	ΔF4mn( ): DELTAF4MN( ) <sup>*2</sup>
ΔF1rmn( ): DELTAF1RMN( ) <sup>*2</sup>	ΔF1dc( ): DELTAF1DC( ) <sup>*2</sup>	
ΔF1rmn( ): DELTAF1RMN( ) <sup>*2</sup>	ΔF1dc( ): DELTAF1DC( ) <sup>*2</sup>	
ΔF1rmn( ): DELTAF1RMN( ) <sup>*2</sup>	ΔF1dc( ): DELTAF1DC( ) <sup>*2</sup>	
ΔF1rmn( ): DELTAF1RMN( ) <sup>*2</sup>	ΔF1dc( ): DELTAF1DC( ) <sup>*2</sup>	

<sup>\*2</sup> Can be used on WT3000s with firmware version 4.07 or later.

- **The measurement functions below can be computed on models with the advanced computation (/G6) or harmonic measurement (/G5) option.**

φU: UPHI( , )	φI: IPHI( , )	Z: Z( , )	Rs: RS( , )
Xs: XS( , )	Rp: RP( , )	Xp: XP( , )	Uhdf: UHDF( , )
Ihdf: IHDF( , )	Phdf: PHDF( , )	Uthd: UTHD( )	Ithd: ITHD( )
Pthd: PTHD( )	Uthf: UTHF( )	Ithf: ITHF( )	Utif: UTIF( )
I.tif: ITIF( )	hvf: HVF( )	hcf: HCF( )	
φU1-U2: PHIU1U2( )	φU1-U3: PHIU1U3( )	φU1-I1: PHIU1I1( )	
φU1-I2: PHIU1I2( )	φU1-I3: PHIU1I3( )		

- **On WT3000s with firmware versions 3.01 or later, user-defined functions F1 to F19 can be set.**

F1: F1( )	F2: F2( )	F3: F3( )	F4: F4( )
F5: F5( )	F6: F6( )	F7: F7( )	F8: F8( )
F9: F9( )	F10: F10( )	F11: F11( )	F12: F12( )
F13: F13( )	F14: F14( )	F15: F15( )	F16: F16( )
F17: F17( )	F18: F18( )	F19: F19( )	

• **Setting the Operand Parameters**

There are two types of operands with parameters.

• **Setting Operands with Two Parameters**

Set a symbol representing the element in the left parameter and the order in the right parameter. For example, set the parameters as in (E1,OR2).

• Symbols representing elements

- E1 to E4: Elements 1 to 4
- E5 and E6:  $\Sigma A$  and  $\Sigma B$

• Symbols representing orders

- ORT: Normal measured value or total value\*1
- OR0: DC\*2
- OR1: Fundamental wave\*2
- OR2 to OR100: Harmonics\*2

\*1 A normal value or total value (requires the /G6 option) is substituted depending on the measurement mode.

\*2 Requires the /G5 or /G6 option.

• **Setting Operands with a Parameter**

Set a symbol representing the element. You do not have to set the order. For example, set the parameter as in (E1).

For the symbols that can be set in the parameters of each operand, see appendix 13.

• **Values Substituted in Operands**

- Urms, Umn, Udc, or Urmn is substituted into U( , ) according to the specified voltage mode.
- Irms, Imn, Idc, or Irmn is substituted into I( , ) according to the specified current mode.
- Values are substituted into URMS ( ) and UMN ( ) according to the voltage/ current mode as follows:

	Voltage mode			
	RMS	MEAN	DC	RMEAN
URMS( )	Yes	Yes	No	No
UMN( )	Yes	Yes	Yes	Yes

- If the voltage and current modes are set to RMS and UMN( ) is assigned for the user-defined function, Urms, Umn, Irms, and P can be measured simultaneously.
- If the voltage and current modes are set to MEAN and URMS( ) is assigned for the user-defined function, Urms, Umn, Imn, and P can be measured simultaneously.
- Urms, Umn, Irms, and Imn cannot be measured simultaneously.
- The substituted value of TI( ) is the same regardless of which element symbol (E1 to E4) is set in TI( ). The unit of TI ( ) is seconds (S).
- Functions  $\eta_1$  to  $\eta_4$  (efficiency 2) are displayed as percentages as indicated by the equations given in appendix 1, "Symbols and Determination of Measurement Functions." However, ETA1 to ETA4 described in this section are displayed as ratios.

Example  $\eta_1$ : 80 %, ETA1 = 0.8

- The U1 of PHIU1U2 represents the voltage signal of the element whose element number is the smallest in the wiring unit ( $\Sigma A$  or  $\Sigma B$ ). For example, if input elements 2, 3, and 4 are assigned to wiring unit  $\Sigma A$ , PHIU1U2 is the phase difference between the voltage signal of input element 2 and that of input element 3.

## 5.4 Setting the User-Defined Function

The user-defined functions allow you to determine physical values other than those of the measurement functions by combining operands. The measurement functions that can be assigned to the efficiency equation (section 5.7) are fixed to power and motor output. However, by using the user-defined function, an equation consisting of measurement functions other than power and motor output can be set up to determine ratios other than efficiency.

- On WT3000s with firmware versions 1.XX or 2.XX, equations (F1 to F20) cannot be placed inside another equation (F1 to F20).
- On WT3000s with firmware version 3.01 or later, user-defined equations with a smaller equation number can be used as operands in a user-defined equation. For example, F1( ) + F2( ) can be defined as an equation for user-defined function F3. This allows equations that would otherwise exceed 50 characters in length to be computed. For example, set equations in F1 and F2, and define F3 as F1( )+F2( ) or F1( )/F2( ). This feature is also convenient when defining multiple equations that include common operands. For example, set common operands in F1, and define F4=F3( )/F1( ), F5=F4( )/F1( ). Note that if you enter an equation number that is greater than equal to its own number, correct results will not be obtained. For example, if you set user-defined function F3 to F1( )+F3( ) or F1( )+F4( ), the computed result displays no data [- - - - -] or overflow [- OF -].
- On WT3000s with firmware version 4.02 or later, if you set the measurement period to ASSP (Average for the Synchronous Source Period), regardless of the selected voltage or current modes, computations for all voltage and current modes (RMS, MEAN, DC, and RMEAN) can be performed simultaneously.

### • Operators

The following operators can be used to create an equation.

Operator	Example	Description
+, -, *, /	U(E1,OR1) – U(E2,OR1)	Basic arithmetic of the measurement functions
ABS	ABS(P(E1,ORT) + P(E2,ORT))	Absolute value of the measurement function
SQR	SQR(I(E1,OR0))	Square of the measurement function
SQRT	SQRT(ABS(I(E1,OR3)))	Square root of the measurement functions
LOG	LOG(U(E1,OR25))	Natural log of the measurement functions
LOG10	LOG10(U(E1,OR25))	Common log of the measurement function
EXP	EXP(U(E1,OR12))	Exponent of the measurement function
NEG	NEG(U(E1,OR12))	Negation of the measurement function

### Number and Type of Characters That Can Be Used in the Equation

- Number of characters  
50 characters or less
  - Types of characters  
Characters that are displayed on the keyboard and spaces
- **Equation Examples**  
When determining the rms value of the harmonic components of the voltage signal of input element 2.

$$\sqrt{(\text{Total rms value of the voltage})^2 - (\text{Rms value of the fundamental wave of the voltage})^2}$$

$$\text{SQRT}(\text{SQR}(\text{U}(\text{E2}, \text{ORT})) - \text{SQR}(\text{U}(\text{E2}, \text{OR1})))$$

### Note

If an operand in the equation is undetermined, the computation result displays [-----] (no data). For example, this occurs if a measurement function of a delta computation is in the equation, but the delta computation is turned OFF or a measurement function of an element that is installed is in the equation.



# 5.5 Setting MAX hold

## Procedure

To exit the menu during operation, press **ESC** located above the soft keys.

In the procedural explanation below, the phrase “press the **cursor keys**” may be used. This phrase refers to the procedures for selecting items and entering values and character strings. For details on the procedures, see section 3.14.

### Turning ON/OFF the Maximum Hold Function of the Numeric Data Display

1. Press **MEASURE** to display the Measure menu.
2. Press the **User Defined Function** soft key to display the User Defined Function menu.
3. Press the **Max Hold** soft key to select ON or OFF.

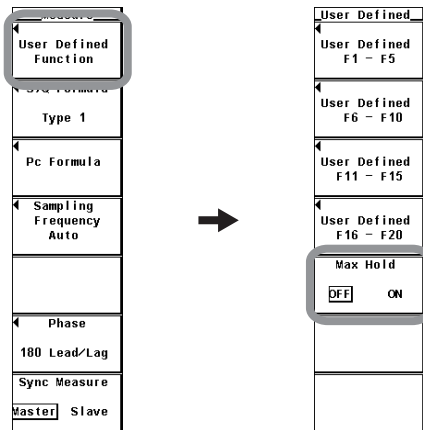

**Explanation**

**Maximum Hold**

This function enables the maximum value of the numeric data to be held.

- The item to be held at the maximum value is set using the user-defined function. The operators for the measurement functions are shown below in the form measurement function: MAX value (equation for defining the MAX hold).

U: UMAX( )	Urms: URMSMAX( )	Umn: UMEANMAX( )
I: IMAX( )	P: PMAX( )	S: SMAX( )
Q: QMAX( )	U+pk: UPPEAKMAX( )	U-pk: UMPEAKMAX( )
I+pk: IPPEAKMAX( )	I-pk: IMPEAKMAX( )	P+pk: PPPEAKMAX( ) <sup>*2</sup>
P-pk: PMPEAKMAX( ) <sup>*2</sup>		

\*1 To hold the MAX value of U, enter UMAX ( ) in the equation for the user-defined function.

\*2 Can be used on WT3000s with firmware version 5.01 or later.

- One symbol from E1 to E6 can be entered in the parentheses for UMAX( ), IMAX( ), PMAX( ), SMAX( ), and QMAX( ).
- One symbol from E1 to E4 can be entered in the parentheses for URMSMAX( ) and UMEANMAX( ).
- One symbol from E1 to E4 can be entered in the parentheses for UPPEAKMAX( ) to PMPEAKMAX( ).
- The maximum value of the data above is held while the MAX hold function is enabled.
- Values are substituted in URMSMAX( ) and UMEANMAX( ) only when the voltage mode is RMS and MEAN, respectively.
- The D/A output, the numeric data list that the built-in printer prints, the communication output, and other values are set to the maximum held values.
- **Limitations on the MAX Hold Function by Measurement Modes.**  
The MAX hold function cannot be used in IEC harmonics measurement, voltage fluctuation and flicker measurement, and cycle-by-cycle measurement modes.

**Note**

---

In wide bandwidth harmonic measurement mode,<sup>\*3</sup> the total value (the total value of each harmonic component)<sup>\*4</sup> is substituted in the equation.

\*3 Can be set on models with the advanced computation (/G6) option.

\*4 For details, see section 7.1 in the *Extension Function User's Manual IM760301-51E*.

---

---

## 5.6 Measuring the Average Active Power

### Explanation

The average active power is specified using the user-defined function as follows:

$$\text{Average active power} = \frac{\text{Integrated power}}{\text{Elapsed time of integration}}$$

For example, to determine the average active power of element 1, the equation of the user-defined function is set as follows:

$$\text{WH(E1)}/(\text{TI(E1)}/3600)$$

The unit of TI ( ) is seconds (S). For the procedure of setting equations, see section 5.4.

## 5.7 Setting the Equation for Efficiency

### Procedure

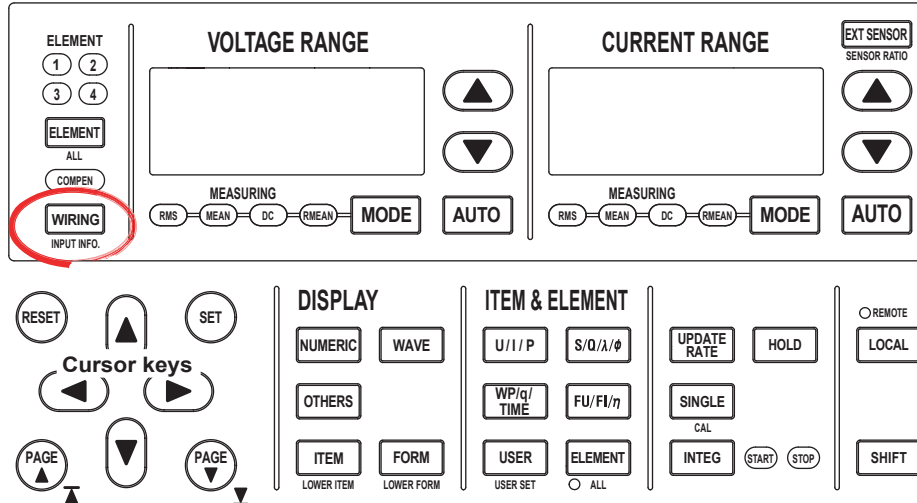

To exit the menu during operation, press **ESC** located above the soft keys.

In the procedural explanation below, the phrase “press the **cursor keys**” may be used. This phrase refers to the procedures for selecting items and entering values and character strings. For details on the procedures, see section 3.14.

- **Setting the Equation for Efficiency**

1. Press **WIRING** to display the Wiring menu.
2. Press the **η Formula** soft key to display the η Formula dialog box.
3. Press the **cursor keys** to set the numerator or denominator of the efficiency equation from η1 to η4.
4. Press **SET**. A box used to select the parameters for computing the efficiency appears.
5. Press the **cursor keys** to select the parameter for computing the efficiency.
  - To set the sum of multiple parameters to the numerator or denominator in the equation, select Udef1 or Udef2.
6. Press **SET** to confirm.

- **Setting the Parameters for Computing the Efficiency**

1. Press the **cursor keys** to set the operand of the equation to Udef1 or Udef2.
2. Press **SET**. A box used to select the computation parameter appears.
3. Press the **cursor keys** to select the computation parameter.
4. Press **SET** to confirm.

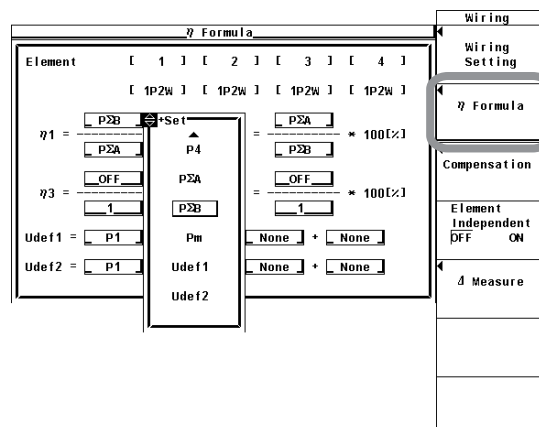

**Explanation**

An efficiency equation can be created by combining the measurement function symbols. Using the numeric values of the measurement functions, the energy conversion efficiency of the device can be determined.

- **Setting the Equation**

Four efficiency equations (h1 to h4) can be defined by assigning the power of an element, the power of a S function, or the motor output as an operand. To set the sum of multiple measurement function symbols in the operand of the equation, an equation consisting of up to 4 terms can be created using Udef1 and Udef2.

**Equation Examples**

- **Efficiency of a Single-Phase, Two-Wire Input/Single-Phase, Two-Wire Output Device**

Given

Input: Power of element 1 (P1) and

Output: Power of element 2 (P2)

Efficiency equation:  $P2/P1$

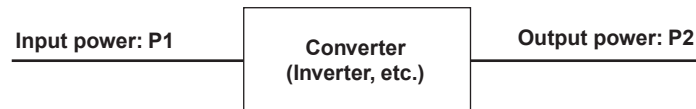

- **Efficiency of a Single-Phase, Two-Wire Input/Three-Phase, Three-Wire Output Device**

Given

Input: Power of element 1 (P1) and

Output:  $\Sigma$  power of elements 2 and 3 ( $P\Sigma A$ )

Efficiency equation:  $P\Sigma A/P1$

- **Efficiency of a Three-Phase, Three-Wire Input/Three-Phase, Three-Wire Output Device**

Given

Input:  $\Sigma$  power of elements 1 and 2 ( $P\Sigma A$ ) and

Output:  $\Sigma$  power of elements 3 and 4 ( $P\Sigma B$ )

Efficiency equation:  $P\Sigma B/P\Sigma A$

- **Efficiency of a Single-Phase, Two-Wire Input Motor**

Given

Input: Power of element 1 (P1) and

Output: Motor output ( $P_m$ )

Efficiency equation:  $P_m/P1$

- **Efficiency of a Three-Phase, Three-Wire Input Motor**

Given

Input:  $\Sigma$  power of elements 1 and 2 ( $P\Sigma A$ ) and

Output: Motor output ( $P_m$ )

Efficiency equation:  $P_m/P\Sigma A$

**Note**

To correctly compute the efficiency, set the power factor of all elements so that all power units used in the computation are the same. For example, the efficiency over elements or wiring units with mixed power units of W (watt) and J (joule) cannot be computed correctly.

- **Limitations on the Efficiency Computation by Measurement Modes**

Efficiency cannot be computed in wide bandwidth harmonic measurement, IEC harmonics measurement, voltage fluctuation and flicker measurement, and cycle-by-cycle measurement modes.

## 5.8 Setting the Wiring, Efficiency, and Two-Wattmeter Method Compensations

### Procedure

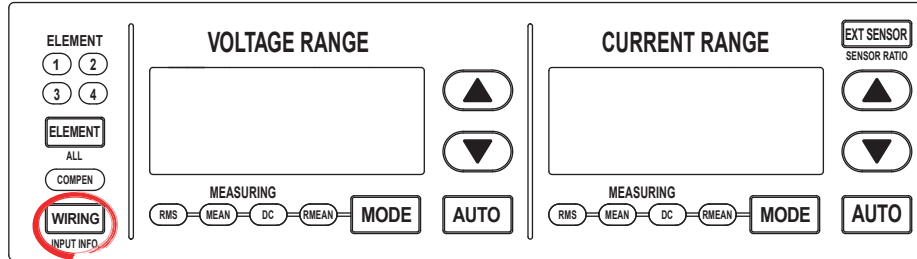

To exit the menu during operation, press **ESC** located above the soft keys.

In the procedural explanation below, the phrase “press the **cursor keys**” may be used. This phrase refers to the procedures for selecting items and entering values and character strings. For details on the procedures, see section 3.14.

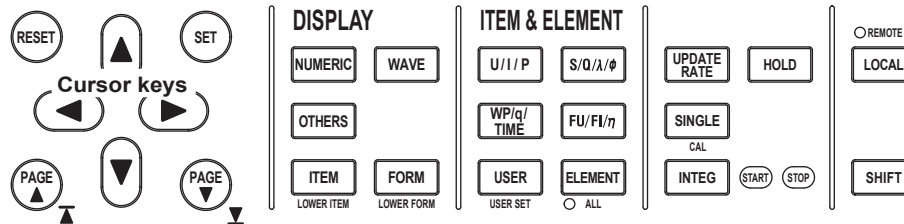

1. Press **WIRING** to display the Wiring menu.
  2. Press the **Compensation** soft key to display the Compensation dialog box.
- **Selecting the Wiring Compensation**
    3. Press the **cursor keys** to select the wiring compensation of the desired element from element 1 to 4.
    4. Press **SET**. A wiring compensation selection box appears.
    5. Press the **cursor keys** to select a value between OFF and I-U.

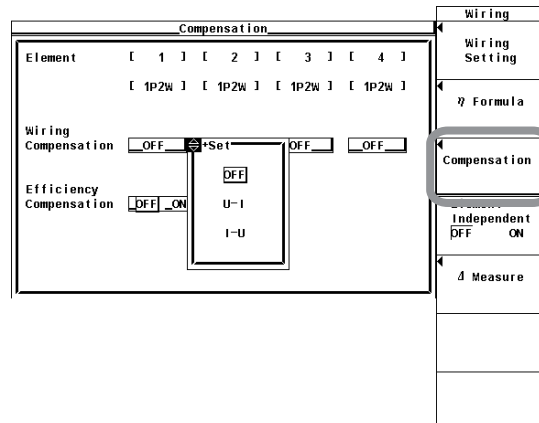

- **Turning ON/OFF the Efficiency Compensation**

3. Press the **cursor keys** to select Efficiency Compensation.
4. Press **SET** to select ON or OFF.

- **Turning ON/OFF the Compensation for Two-Wattmeter Method**

This appears only when the wiring system is set to 3P3W (3V3A) on models with the delta computation option.

3. Press the **cursor keys** to select 3P3W(3V3A):ΣA Compensation.
4. Press **SET** to select ON or OFF.

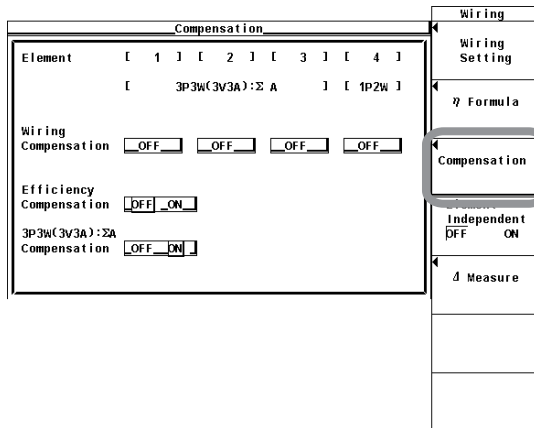

**Explanation**

- **Wiring Compensation**

Compensates for the loss caused by the wiring of each element. For details, see appendix 8. Set the compensation according to the setting specified for “Effects due to the Amplitude of the Measured Voltage and Current” in section 3.7.

- If wiring for “When the Measurement Current Is Relatively Small” is used: U-I
- If wiring for “When the Measurement Current Is Relatively Large” is used: I-U

- **When Set to U-I**

The measured voltage is determined by subtracting “the voltage applied to the current terminal” from the voltage value of each element. The voltage applied to the current terminal is derived by the equation: the measured current × the input resistance of the current terminal.

- **When Set to I-U**

The measured current is determined by subtracting “the current that flows through the voltage terminal” from the current value of each element. The current that flows through the voltage terminal is derived by the equation: the measured voltage/the input resistance of the voltage terminal.

- **When Set to OFF**

Neither of the above compensation is performed.

## 5.8 Setting the Wiring, Efficiency, and Two-Wattmeter Method Compensations

---

- **Efficiency Compensation**

The power measurement on the secondary side of a power transformer such as an inverter includes loss caused by the measurement instrument. This loss appears as error in the efficiency computation. This function compensates for this loss. For details, see appendix 8.

- **Compensation for the Two-Wattmeter Method**

In the two-power wattmeter method, an error results when current flows through the neutral line. This function computes the current that flows through the neutral line for measurements using the two-wattmeter method with a three-phase, three wire (3V3A) system and adds the compensation value to the measured power. For details, see appendix 8. This function can be set on models with the delta computation option.

**Note**

---

- If the current input is an external sensor input (EXT) and the wiring compensation is U-I wiring, wiring compensation is not performed. This is because the instrumental loss of the current measurement is unknown.
  - If the current input is an external sensor input (EXT), efficiency compensation is not performed. This is because the instrumental loss of the current measurement is unknown.
  - Efficiency compensation and two-wattmeter method compensation are not performed in wide bandwidth harmonic measurement and IEC harmonic measurement modes on models with the advanced computation (/G6) option.
  - Wiring compensation, efficiency compensation, and two-wattmeter method compensation are not performed in voltage fluctuation and flicker measurement, and cycle-by-cycle measurement modes. Settings for these compensation functions are invalid.
-



## 5.9 Setting the Equations for Apparent Power, Reactive Power, and Corrected Power

### Procedure

To exit the menu during operation, press **ESC** located above the soft keys.

In the procedural explanation below, the phrase “press the **cursor keys**” may be used. This phrase refers to the procedures for selecting items and entering values and character strings. For details on the procedures, see section 3.14.

1. Press **MEASURE** to display the Measure menu.
- **Selecting the Equation for Apparent Power and Reactive Power**
  2. Press the **S, Q Formula** soft key to display the S, Q Formula menu.
  3. Press one of the soft keys from **Type1**, **Type2**, **Type3**\* to select the equation for apparent power.
    - \* Displayed only on models with the advanced computation (/G6) or harmonic measurement (/G5) option.

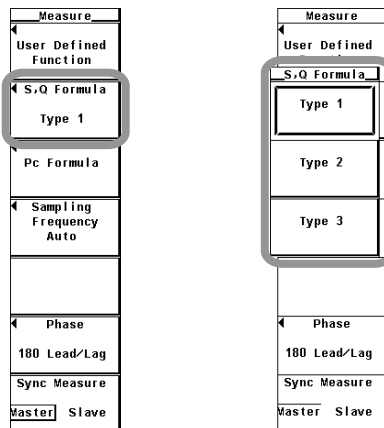

## 5.9 Setting the Equations for Apparent Power, Reactive Power, and Corrected Power

- **Setting the Equation for Corrected Power**
  2. Press the **Pc Formula** soft key to display the Pc Formula dialog box.
- **Selecting the Applicable Standard**
  3. Press the **cursor keys** to select the standard for Pc Formula.
  4. Press **SET** to select either IEC76-1(1976), IEEE C57.12.90-1993 or IEC76-1(1993).
- **Setting the Coefficient**  
**(When the applicable standard of the equation is IEC76-1(1976), IEEE C57.12.90-1993)**
  5. Press the **cursor keys** to select P1=.
    6. Press **SET**. A box used to set coefficient P1 appears.
    7. Press the **cursor keys** to set P1.
    8. Press **SET** or **ESC** to close the box.
  9. Press the **cursor keys** to select P2=.
    10. Press **SET**. A box used to set coefficient P2 appears.
    11. Press the **cursor keys** to set P2.
    12. Press **SET** or **ESC** to close the box.

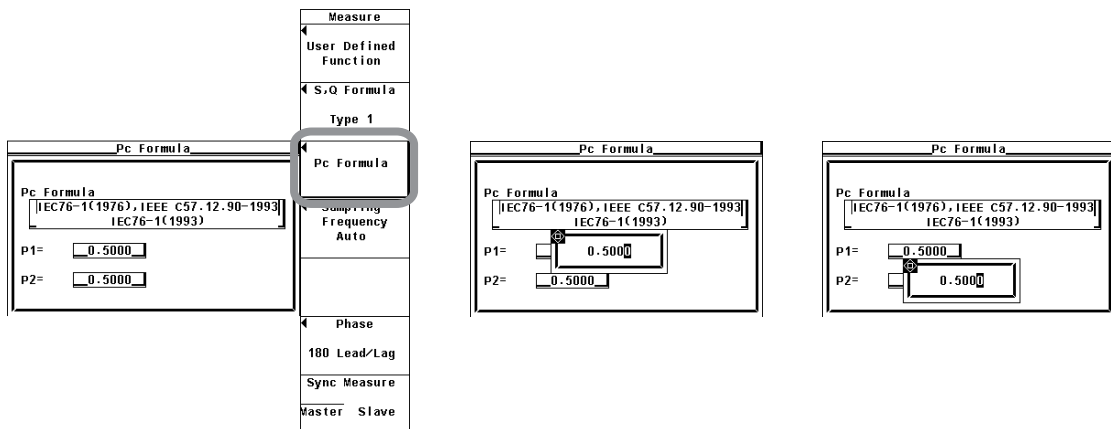

**Explanation**

• **Selecting the Equations for Apparent Power and Reactive Power**

The equations for apparent power and reactive power can be selected from three types. For details, see section 2.5.

• **TYPE 1 (Method Used by Normal Mode of Conventional WT Series Power Meters)**

Active power for three-phase, four-wire system  $P_{\Sigma} = P1 + P2 + P3$   
 Apparent power for three-phase, four-wire system  $S_{\Sigma} = S1 + S2 + S3 (= U1 \times I1 + U2 \times I2 + U3 \times I3)$   
 Reactive power for three-phase, four-wire system  $Q_{\Sigma} = Q1 + Q2 + Q3$

• **TYPE 2**

Active power for three-phase, four-wire system  $P_{\Sigma} = P1 + P2 + P3$   
 Apparent power for three-phase, four-wire system  $S_{\Sigma} = S1 + S2 + S3 (= U1 \times I1 + U2 \times I2 + U3 \times I3)$   
 Reactive power for three-phase, four-wire system  $Q_{\Sigma} = \sqrt{S_{\Sigma}^2 - P_{\Sigma}^2}$

• **TYPE 3 (Method Used by Harmonic Mode on the WT1600 and PZ4000)**

This computing equation can be selected on models with the advanced computation (/G6) or harmonic measurement (/G5) option. The harmonic measurement must be performed correctly. For details on harmonic measurement, see chapter 7 in the *Expansion Function User's Manual IM760301-51E*.

Active power for three-phase, four-wire system  $P_{\Sigma} = P1 + P2 + P3$   
 Apparent power for three-phase, four-wire system  $S_{\Sigma} = \sqrt{P_{\Sigma}^2 + Q_{\Sigma}^2}$   
 Reactive power for three-phase, four-wire system  $Q_{\Sigma} = Q1 + Q2 + Q3$

**Note**

There are limitations to setting equations for apparent power and reactive power depending on the measurement mode. For details, see page 2-19.  
 For example, if you set the equation to TYPE1 in normal measurement mode and switch to IEC harmonic measurement mode, the equation automatically switches to TYPE3. If you switch the measurement mode back to normal measurement, the equation automatically reverts to TYPE1.

• **Setting the Equation for Corrected Power**

Depending on the applicable standard, when the load that is connected to the potential transformer is extremely small, the active power of the potential transformer that is measured needs to be compensated. In such cases, set the compensating equation and the coefficient. Corrected power (Pc) is a measurement function in the normal measurement mode.

• **Selecting the Applicable Standard**

Select the standard from below. For the equations of each applicable standard, see section 2.5.

- IEC76-1(1976), IEEE C57.12.90-1993
- IEC76-1(1993)

• **Setting the Coefficient**

Coefficients P1 and P2 can be specified.  
 Set the coefficients in the range of 0.0001 to 9.9999.

**Note**

Corrected power is computed only when the voltage mode is RMS or MEAN.

## 5.10 Selecting the Display Format of the Phase Difference

### Procedure

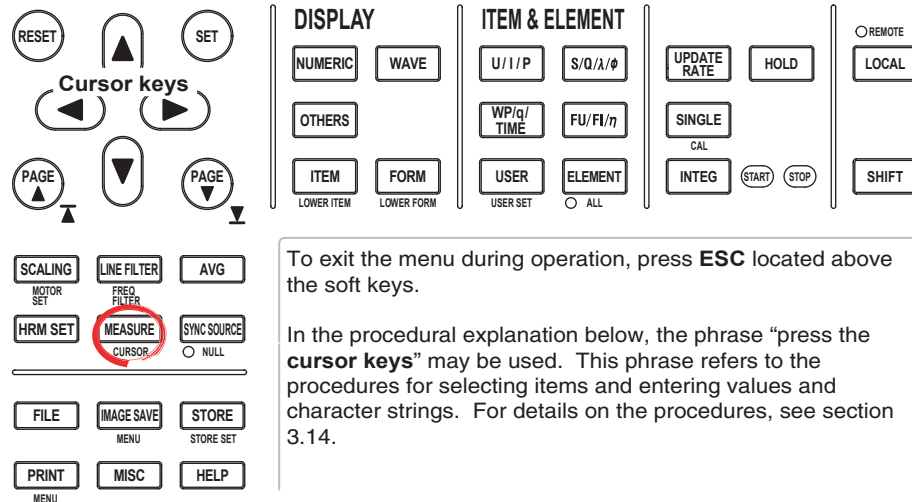

1. Press **MEASURE** to display the Measure menu.
2. Press the **Phase** soft key to display the Phase menu.
3. Press either the **180 Lead/Lag** or **360 degrees** soft key to select the display format of the phase difference.

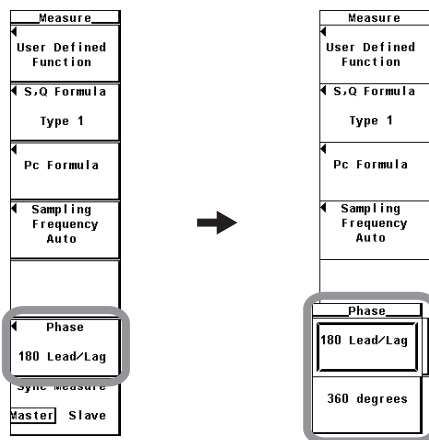

**Explanation**

The phase difference  $\phi$  between the voltage and current indicates the position of the current phase with respect to the voltage of each element. You can select the display mode from below.

- 180 Lead/Lag  
If the current phase is in the counterclockwise direction with respect to voltage, the current is leading (D) the voltage. If the current phase is in the clockwise direction with respect to the voltage, the current is lagging (G) the voltage. The phase difference is expressed by an angle between 0 to 180°.
- 360 Degrees  
The phase difference is expressed using an angle between 0 and 360° in the clockwise direction.

**Note**

- If the measured value of the voltage or current input is zero, [Error] is displayed.
- When both the voltage and current are sinusoids and the ratio of the voltage and current inputs do not differ greatly with respect to the measurement range, the phase difference  $\phi$  of lead and lag are detected and displayed correctly.
- If the computation result of power factor  $\lambda$  exceeds "1,"  $\phi$  is displayed as follows:
  - If the power factor  $\lambda$  is greater than 1 and less than equal to 2,  $\phi$  displays zero.
  - If the power factor  $\lambda$  is greater than 2,  $\phi$  displays an error.
- The phase difference,  $\phi_U$  and  $\phi_I$ , of harmonic order 1 to 100 of the voltage and current on the harmonic measurement option is always displayed using an angle between 0 and 180° (no sign for lead and negative sign for lag).

## 5.11 Integration

The integration function has the following five modes.

Integration Mode	Start	Stop	Repetitive Operation	Reference
<b>Manual integration mode</b> The WT3000 keys are used to start/stop the integration.	Key operation	Key operation	---	Section 5.12
<b>Normal integration mode</b> A WT3000 key is used to start the integration. When a specified timer value elapses, the integration is stopped.	Key operation	Stopped by a timer	---	Section 5.13
<b>Repetitive integration mode</b> A WT3000 key is used to start the integration. When a specified timer value elapses, the integration value is reset and restarted. The above operation is repeated until STOP is pressed.	Key operation	Key operation	Repeated by a timer	Section 5.13
<b>Real-time normal integration mode</b> Integration start and stop are specified by date/time.	Date/time	Date/time	---	Section 5.14
<b>Real-time repetitive integration mode</b> Integration start and stop are specified by date/time. When a specified timer value elapses, the integration value is reset and restarted.	Date/time	Date/time	Repeated by a timer	Section 5.14

For details on each integration mode, see section 2.6.

- **Starting, Stopping, and Resetting the Integration**

- The integration can be started, stopped, or reset from the front panel keys or through communication commands.
- The following figure shows the relationship between the integration operation and start, stop, and reset. Pressing RESET after the integration has stopped resets the integration value and the integration time.

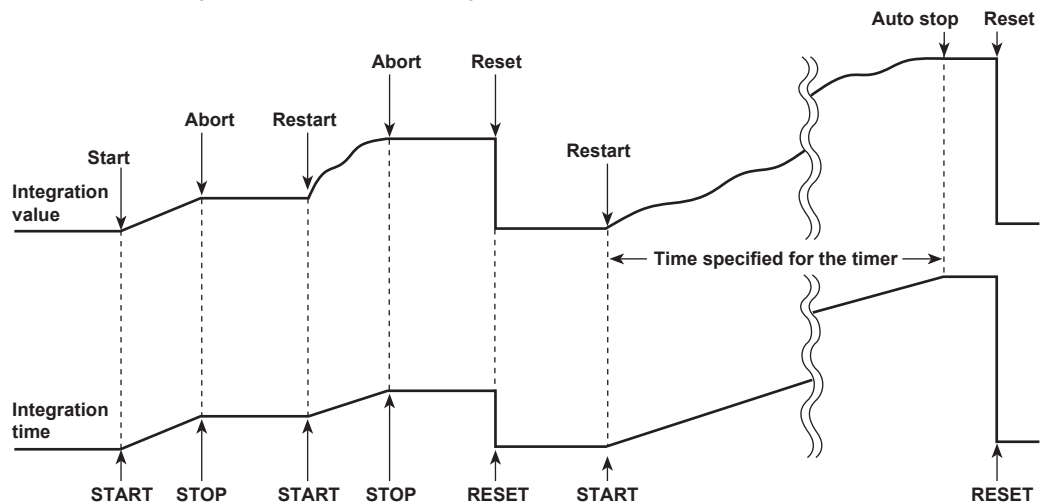

• **Limitations on the Start, Stop, and Reset of Integration by Measurement Modes**

Integration cannot be started, stopped, or reset in measurement modes\* other than normal measurement mode.

\* Wide bandwidth harmonics measurement, IEC harmonic measurement, waveform computation, FFT, voltage fluctuation and flicker measurement, and cycle-by-cycle measurement modes are available.

• **Display Related to Integration**

The screenshot shows the 'Normal Mode' display with the following data:

- U<sub>rms1</sub>: 0.10778 kV
- I<sub>rms1</sub>: 1.6532 A
- P<sub>1</sub>: 0.1650 kW
- λ<sub>1</sub>: 0.92619

At the top, it shows: U<sub>over</sub>: [ ] Spd: U1 : 1000Vrms, I<sub>over</sub>: [ ] Trq: Integ:Reset. The right side of the screen features a vertical menu with buttons: Integ, Start, Stop, Reset, Integ Set, and Integ. The 'YOKOGAWA' logo is at the top right.

- Integ: Reset**  
Displays Reset when the integrated value is reset and integration can be started
- Integ: Start**  
Displays Start and the elapsed time of integration when integration is in progress
- Integ: Stop**  
Displays Stop and the elapsed time of integration when integration is aborted, canceled, or done
- Integ: Ready**  
Displays Ready when ready in real-time integration mode

**Note**

In addition to Reset, Start, Stop, and Ready as displays for indicating the integration status, the displays shown in the following table are available.

- **TimeUp:** When integration continues up to the time specified by the integration timer, it automatically stops. The integration status in this condition is considered TimeUp status.
- **Error:** The WT3000 stores and holds the integration result even when a power failure occurs while integration is in progress. When the power recovers, the integration result calculated up to the point when the power failure occurred is displayed with the integration operation stopped. The integration status in this condition is considered Error status.

**Displayed when the integration time is set to a value other than 0**

& change items

The screenshot shows the following data:

- U<sub>rms1</sub>: 97.824 V
- I<sub>rn1</sub>: 475.806 mA
- P<sub>1</sub>: 51.9010 W
- S<sub>1</sub>: 46.5455 VA

The screenshot shows the following data:

- Element1: U1 100Vrms, I1 500mAmean
- Element2: U2 100Vrms, I2 500mAmean
- Element3: U3 100Vrms, I3 500mAmean
- Element4: U4 100Vrms, I4 500mAmean
- Motor: Spd 20V, Trq 20V
- Integ:Stop Time: 0:00:13
- Integ:Ready Time: 0:10:00

Annotations: 'Elapsed time of integration' points to the Integ:Stop Time; 'Integration timer' points to the Integ:Ready Time.

**Displayed when ready**

The screenshot shows the following data:

- Element1: U1 100Vrms, I1 500mAmean
- Element2: U2 100Vrms, I2 500mAmean
- Element3: U3 100Vrms, I3 500mAmean
- Element4: U4 100Vrms, I4 500mAmean
- Motor: Spd 20V, Trq 20V
- Integ:Ready Start Time: 2004/12/01 00:00:00

Annotation: 'Integration start reservation time' points to the Integ:Ready Start Time.

• **Holding, Starting, and Stopping the Integration**

When the display is held, the display of the integration result and communication output are held. The integration operation continues regardless of whether the hold function is ON or OFF. The relationship between the hold function and the start and stop operations is as follows:

- If the integration is started while the display is held, the display and communication output do not change. When the hold function is released (OFF) or a single measurement (by pressing SINGLE) is made, the integration result at that point is displayed or output via communications.

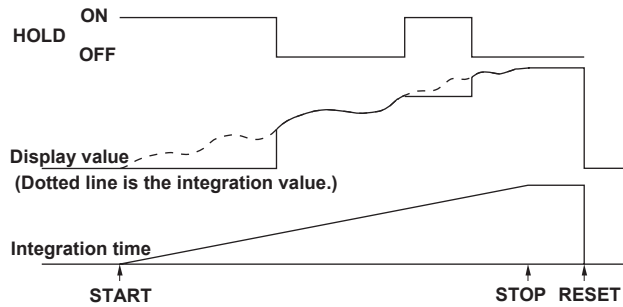

- If the integration is stopped while the display is held, the display and communication output values do not change from the held values. When the hold function is released (OFF) or a single measurement (by pressing SINGLE) is made, the integration result at the point when integration is stopped is displayed or output via communications.

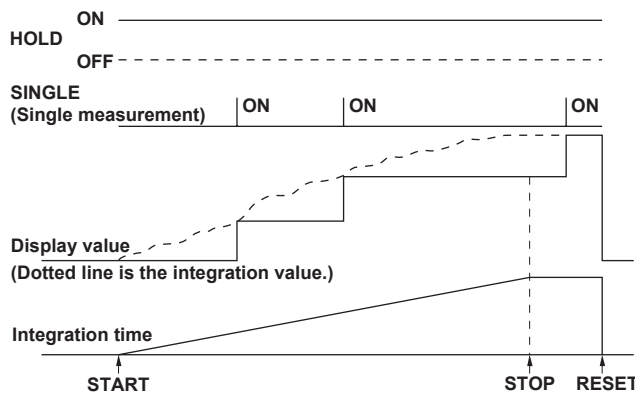

• **Sample Rate and Valid Frequency Range for Integration**

The sample rate is approximately 200 kHz. The voltage/current signal frequencies that are valid for the integration are as follows:

Integrated Item	Valid Frequency Range for Integration	
Active power	DC to 100 kHz	
Current	When integrating $I_{rms}$	DC, lower limit of frequency determined by the data update rate to 100 kHz
	When integrating $I_{mn}$	DC, lower limit of frequency determined by the data update rate to 100 kHz
	When integrating $I_{dc}$	DC to 100 kHz
	When integrating $I_{rmn}$	DC, lower limit of frequency determined by the data update rate to 100 kHz



- **Display Resolution**

The maximum display resolution of the integration value is 999999. When the integrated value reaches 1000000 counts, the decimal point shifts automatically. For example, if 0.001 mWh is added to 999.999 mWh, the display shows 1.00000 Wh.

- **Display When Integration Overflow Occurs**

If either of the conditions below is met, the integration is stopped, and the integration time and integration value are held.

- The integration time reaches the maximum integration time (10000 hours).
- The integration value of WP, q, WS, or WQ reaches the maximum or minimum integration value given below.

- **Maximum/Minimum Displayed Integration Value**

Active power (WP):  $\pm 999999$  MWh  
 Current (q):  $\pm 999999$  MAh  
 Apparent power (WS):  $\pm 999999$  MVAh  
 Reactive power (WQ):  $\pm 999999$  Mvarh

- **Integration When MAX Hold Function Is Enabled**

The integration value is determined and displayed by summing the value that is measured at every display update rate, irrespective of the MAX hold function (section 5.5).

- **Integration When the Measured Value Exceeds the Measurement Limit**

If the instantaneous voltage or current of the sampled data exceeds 300% of the measurement range when the crest factor is set to 3, the value is considered to be the value corresponding to 300% for the purpose of integration. If the instantaneous voltage or current of the sampled data exceeds 600% of the measurement range when the crest factor is set to 6, the value is considered to be the value corresponding to 600% for the purpose of integration.

- **Integration When Current Input Is Small**

Integration is performed assuming a current of zero when the current input with respect to the measurement range is as indicated below.

- **When the crest factor is set to 3**  
When  $I_{rms}$  is less than or equal to 0.3% or  $I_{mn}$  or  $I_{mnn}$  is less than or equal to 2%
- **When the crest factor is set to 6**  
When  $I_{rms}$  is less than or equal to 0.6% or  $I_{mn}$  or  $I_{mnn}$  is less than or equal to 4%

- **Using an External Signal to Control Integration (Option)**

On models with the 20-channel D/A output option, you can use the remote control feature to use an external signal to start, stop, and reset integration. For details about the remote control feature, see section 3.4 in the *Extension Function User's Manual IM760301-51E*.

- **Backup during Power Failures**

- If a power failure occurs when integration is in progress, the integration result is held. When the power recovers, the integration result calculated up to the point when the power failure occurred is displayed with the integration operation stopped.
- If the integration is reset after the power recovers, integration can be started once again.

## 5.11 Integration

- **Limitation on Modifying the Settings during Integration**

When the integration is in progress, settings of some functions cannot be changed as shown below.

	<u>Integration Operation Condition</u>		
	<u>Integration Reset</u>	<u>Integrating</u>	<u>Integration Suspended</u>
(START indicator)	OFF	ON	OFF
(STOP indicator)	OFF	OFF	ON
<b>Function</b>			
Wiring system	Yes	No	No
Measurement range	Yes	No	No
Scaling	Yes	No	No
Filter	Yes	No	No
Averaging	Yes	No	No
Synchronization source	Yes	No	No
Hold	Yes	Yes	Yes
Single measurement	Yes	Yes	Yes
Data update rate	Yes	No	No
Display mode	Yes	Yes	Yes
Integration mode	Yes	No (Displayable)	No (Displayable)
Integration timer	Yes	No (Displayable)	No (Displayable)
Integration start	Yes	No	Yes
Integration stop	No	Yes	No
Integration reset	Yes	No	Yes
Store (excludes integration synchronization mode)	Yes	Yes	Yes
Printer	Yes	No	Yes
Zero-level crossing	Yes	No	No
Null	Yes	No	No

Yes: Settings can be modified.

No: Settings cannot be modified.

Starting integration in auto range mode switches the measurement range to fixed range mode.

- **Limitation on the Waveform Display Function during Integration**

The trigger function (see section 6.3) for waveform display does not work while integration is in progress or is suspended. Therefore, the signal level of the waveform display at the left end of the screen may not be stable.

## 5.12 Setting the Manual Integration

### Procedure

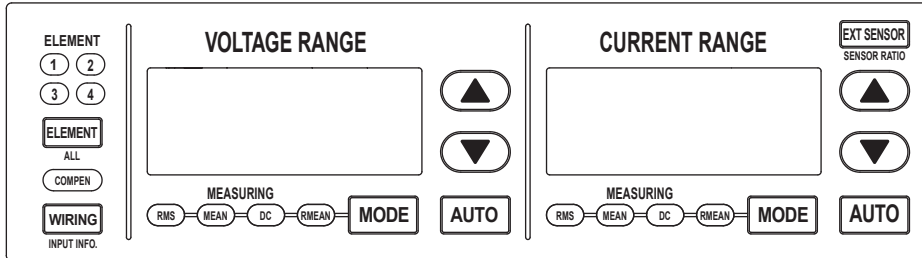

To exit the menu during operation, press **ESC** located above the soft keys.

In the procedural explanation below, the phrase “press the **cursor keys**” may be used. This phrase refers to the procedures for selecting items and entering values and character strings. For details on the procedures, see section 3.14.

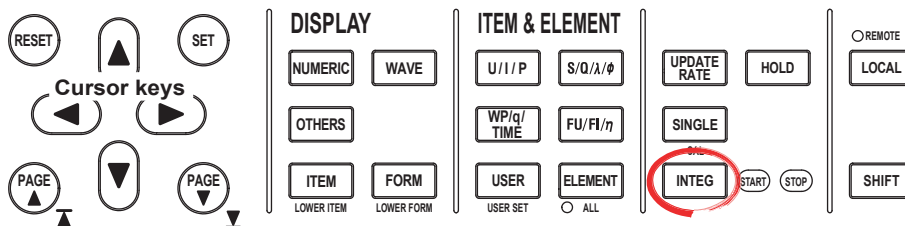

1. Press **INTEG** to display the Integ menu.
2. Press the **Integ Set** soft key to display the Integ Set menu.

- **Selecting the Normal Integration Mode**

3. Press the **Mode** soft key to display the Mode menu.
4. Press the **Normal** soft key to select the integration mode.

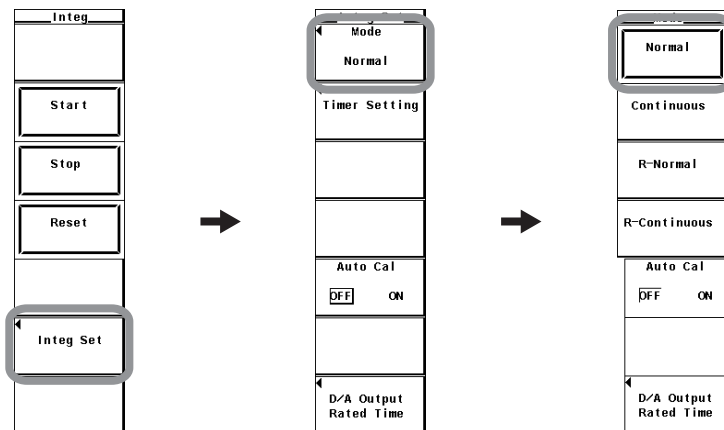

## 5.12 Setting the Manual Integration

- **Setting the Integration Timer**

5. Press the **Timer Setting** soft key to display the Timer Setting dialog box.
6. Press the **cursor keys** to select the hour, minute, or second box.
7. Press **SET** to display the entry box.
8. Press the **cursor keys** to set the hour, minute, or second that you selected in step 6 to 0.
9. Press **SET** or **ESC** to close the box.
10. Repeat steps 6 to 9 to set the hour, minute, and second to 00000:00:00.

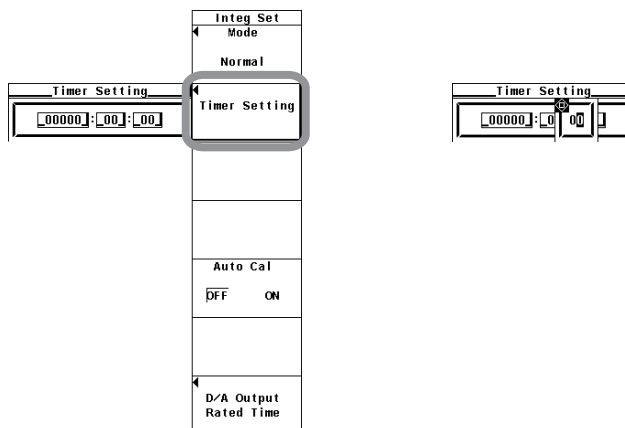

- **Performing Integration in the Manual Integration Mode**

- **Starting the Integration**

11. Press **INTEG** to display the Integ menu.
12. Press the **START** soft key. The START indicator to the right of the INTEG key illuminates, and the integration is started.

- **Holding the Integration**

13. Press **HOLD**. The HOLD key illuminates, and the numeric data display is held. Integration continues inside the WT3000.

- **Releasing the Hold Operation**

14. Press **HOLD** while the values are held. The HOLD key turns OFF, and the numeric data display is updated. In the hold condition, the display can be updated by carrying out single measurements (by pressing SINGLE).

- **Stopping the Integration**

15. Press the **STOP** soft key. The START indicator turns OFF and the STOP indicator illuminates. The integration time and integration value are held. Integration continues if you press START at this point.

- **Resetting the Integration**

16. Press the **RESET** soft key. The STOP indicator turns OFF, the integration time and integration value are reset, and the display of integration measurement functions such as WP shows [-----] (no data).

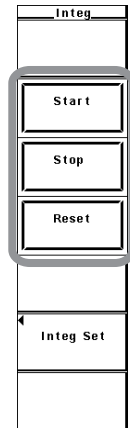
**Explanation**

For functional details, see section 2.6.

To perform integration, the integration mode and integration time must be set before starting the operation.

- **Selecting the Integration Mode and Setting the Integration Timer**

If the integration mode is set to normal integration and the integration timer is set to 00000:00:00, the integration is performed in manual integration mode.

For a description of starting, stopping, and resetting the integration and other items, see section 5.11.

**Note**

Integration cannot be started, stopped, or reset in measurement modes other than normal measurement mode.

## 5.13 Setting the Normal Integration and Repetitive Integration

### Procedure

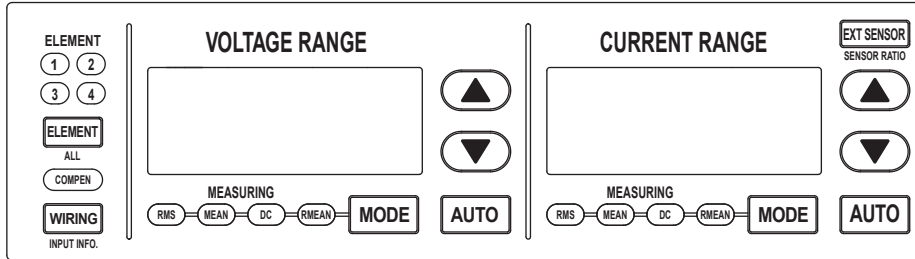

To exit the menu during operation, press **ESC** located above the soft keys.

In the procedural explanation below, the phrase “press the **cursor keys**” may be used. This phrase refers to the procedures for selecting items and entering values and character strings. For details on the procedures, see section 3.14.

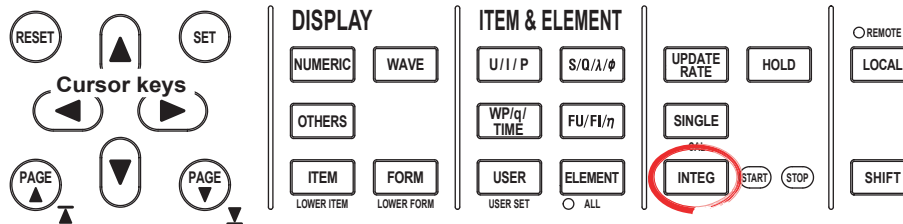

1. Press **INTEG** to display the Integ menu.
  2. Press the **Integ Set** soft key to display the Integ Set menu.
- **Selecting Normal Integration Mode or Repetitive Integration Mode (Continuous)**
    3. Press the **Mode** soft key to display the Mode menu.
    4. Press the **Normal** or **Continuous** soft key to select the integration mode.

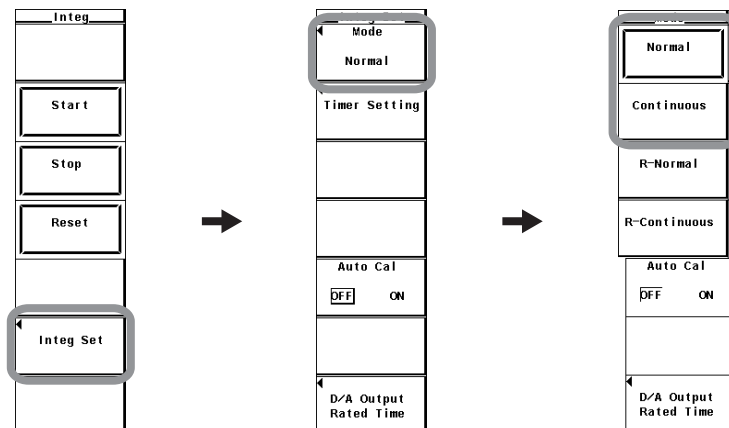

- **Setting the Integration Timer**

5. Press the **Timer Setting** soft key to display the Timer Setting dialog box.
6. Press the **cursor keys** to select the hour, minute, or second box.
7. Press **SET** to display the entry box.
8. Press the **cursor keys** to set the hour, minute, or second that you selected in step 6.
9. Press **SET** or **ESC** to close the box.
10. Repeat steps 6 to 9 to set the hour, minute, and second.

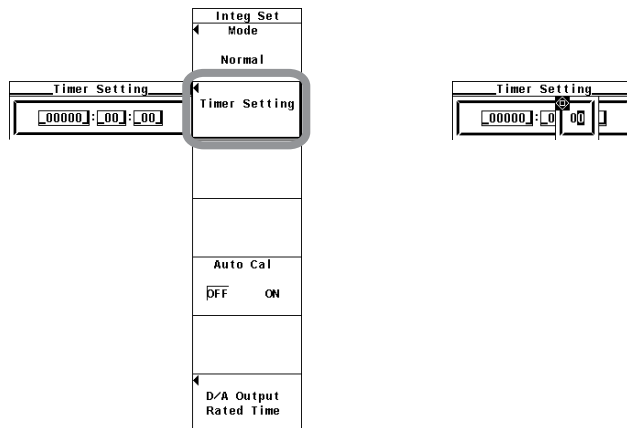

- **Integrating in Normal Integration Mode or Repetitive Integration Mode**

- **Starting the Integration**

11. Press **INTEG** to display the Integ menu.
12. Press the **START** soft key. The START indicator to the right of the INTEG key illuminates, and the integration is started.

- **Holding the Integration**

13. Press **HOLD**. The HOLD key illuminates, and the numeric data display is held. Integration continues.

- **Releasing the Hold Operation**

14. Press **HOLD** while the values are held. The HOLD key turns OFF, and the numeric data display is updated. In the hold condition, the display can be updated by carrying out single measurements (by pressing SINGLE).

- **Stopping the Integration**

15. Press the **STOP** soft key. The START indicator turns OFF and the STOP indicator illuminates. The integration time and integration value are held. If you press STOP before the time specified by the integration timer is reached and then press START, integration continues up to the time specified by the integration timer.  
 If the time specified by the integration timer elapses in the normal integration mode, the START indicator turns OFF and the STOP indicator illuminates. The integration time and integration value are held.  
 If the time specified by the integration timer elapses in the repetitive integration mode, the integration time and integration value are automatically reset, and the integration is repeated until STOP is pressed.

- **Resetting the Integration**

16. Press the **RESET** soft key. The STOP indicator turns OFF, the integration time and integration value are reset, and the display shows [-----] (no data).

## 5.13 Setting the Normal Integration and Repetitive Integration

---

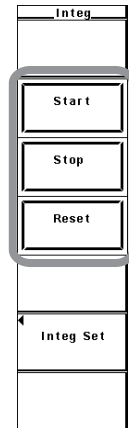

### Explanation

For functional details, see section 2.6.

To perform integration, the integration mode and integration time must be set before starting the operation.

- **Selecting the Normal Integration Mode or Repetitive Integration Mode**  
In this mode, the integration time is set in relative time and the integration is performed over the specified time. This mode consists of the following two types.
  - **Normal Integration Mode**  
The integration time is set in relative time. The integration is stopped after the specified time elapses, when the maximum integration time of 10000 hours is exceeded, when STOP is pressed, or when the integration value reaches the maximum or minimum integration display value (see section 5.11). The integration time and value are held at that point.
  - **Repetitive Integration Mode (Continuous Integration)**  
The integration time is set in relative time. When the specified time elapses, the operation is automatically reset and restarted. Integration is repeated until STOP is pressed. When the integration value reaches the maximum or minimum integration display value, the integration time and value are held.
- **Setting the Integration Timer**
  - The time in units of hour:minute:second can be set in the following range.  
00000:00:00 to 10000:00:00

### Note

---

If the integration timer is set to 00000:00:00 in normal integration mode, the integration is performed in manual integration mode (see section 2.6 and 5.14).

---

For a description of starting, stopping, and resetting the integration and other items, see section 5.11.

### Note

---

Integration cannot be started, stopped, or reset in measurement modes other than normal measurement mode.

---



## 5.14 Setting the Real-Time Integration and Real-Time Repetitive Integration

### Procedure

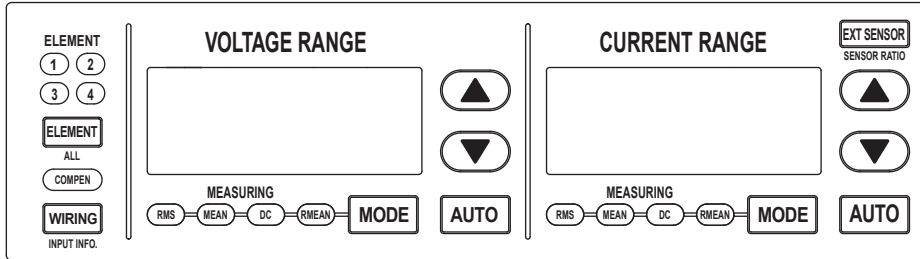

To exit the menu during operation, press **ESC** located above the soft keys.

In the procedural explanation below, the phrase “press the **cursor keys**” may be used. This phrase refers to the procedures for selecting items and entering values and character strings. For details on the procedures, see section 3.14.

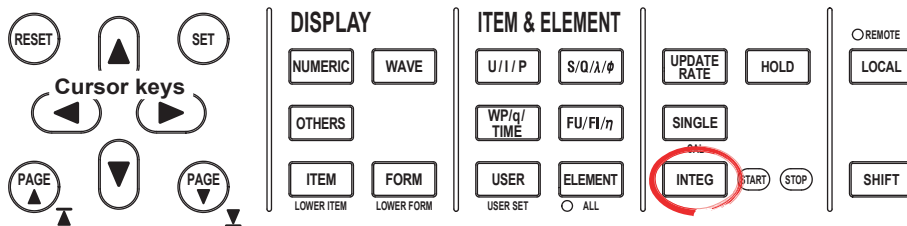

1. Press **INTEG** to display the Integ menu.
2. Press the **Integ Set** soft key to display the Integ Set menu.

- **Selecting the Real-Time Normal Integration Mode (R-Normal) and Real-Time Repetitive Integration Mode (R-Continuous)**

3. Press the **Mode** soft key to display the Mode menu.
4. Press either the **R-Normal** or **R-Continuous** soft key to select the integration mode.

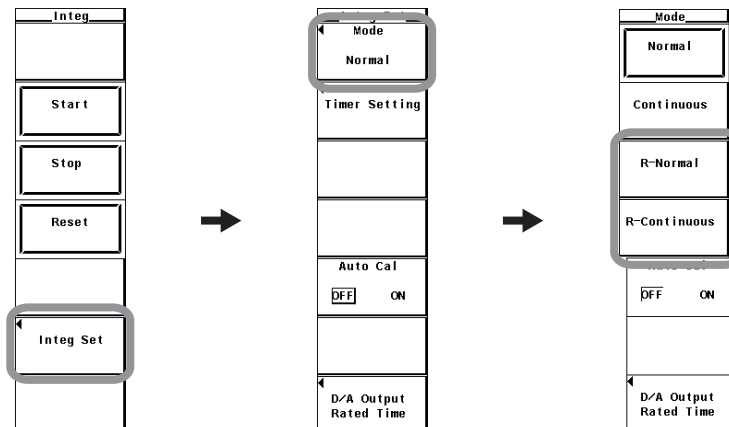

## 5.14 Setting the Real-Time Integration and Real-Time Repetitive Integration

- **Setting the Integration Timer**

5. Press the **Timer Setting** soft key to display the Timer Setting dialog box.
6. Press the **cursor keys** to select the hour, minute, or second box.
7. Press **SET** to display the entry box.
8. Press the **cursor keys** to set the hour, minute, or second that you selected in step 6.
9. Press **SET** or **ESC** to close the box.
10. Repeat steps 6 to 9 to set the hour, minute, and second.

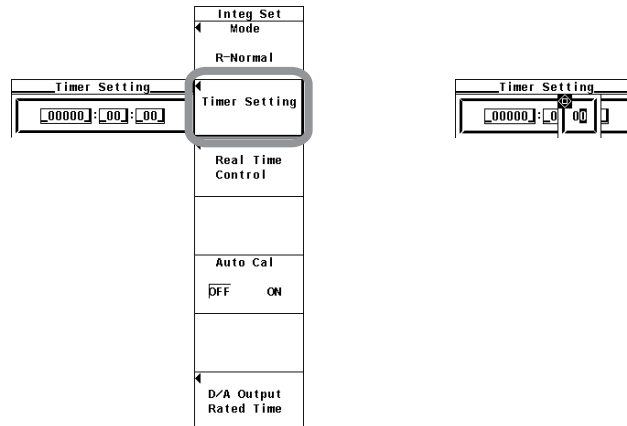

- **Setting the Reservation Time**

11. Press the **Real Time Control** soft key to display the Real Time Control dialog box.
12. Press the **cursor keys** to select one of the reservation year, month, date, hour, minute, and second boxes for specifying when the integration operation will start.
13. Press **SET** to display the entry box.
14. Press the **cursor keys** to set the year, month, date, hour, minute, or second that you selected in step 12.
15. Press **SET** or **ESC** to close the box.
16. Repeat steps 12 to 15 to set the year, month, date, hour, minute, and second.
17. Press the **cursor keys** to select one of the reservation year, month, date, hour, minute, and second boxes for specifying when the integration operation will end.
18. Repeat steps 13 to 16 to set the year, month, date, hour, minute, and second.

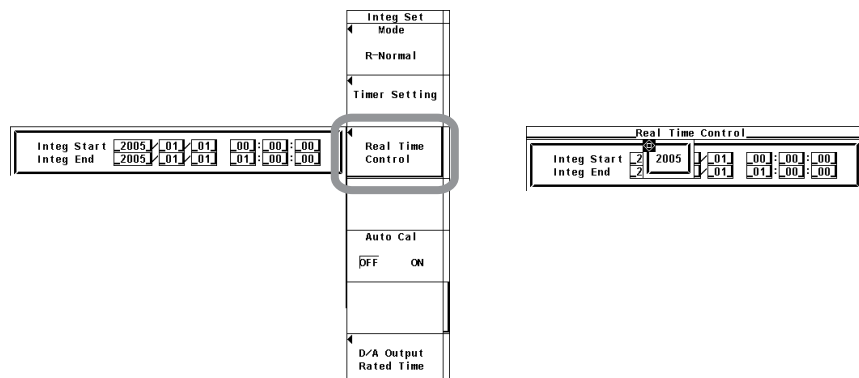

- **Integrating in Real-time Normal Integration Mode or Real-time Repetitive Integration Mode**

- **Starting the Integration**

19. Press **INTEG** to display the Integ menu.
20. Press the **START** soft key. The START indicator to the right of the INTEG key illuminates and the instrument enters the ready condition. When the reservation time for starting the integration is reached, the START indicator changes to illumination and the integration is started.

- **Holding the Integration**

21. Press **HOLD**. The HOLD key illuminates, and the numeric data display is held. Integration continues.

- **Releasing the Hold Operation**

22. Press **HOLD** while the values are held. The HOLD key turns OFF, and the numeric data display is updated. In the hold condition, the display can be updated by carrying out single measurements (by pressing SINGLE).

- **Stopping the Integration**

23. Press the **STOP** soft key. The START indicator turns OFF and the STOP indicator illuminates. The integration time and integration value are held. If you press STOP before the time specified by the integration timer is reached and then press START, integration continues up to the time specified by the integration timer.

If the reservation time for stopping the integration is reached in the real-time normal integration mode, the START indicator turns OFF and the STOP indicator illuminates. The integration time and integration value are held.

If the time specified by the integration timer elapses in the real-time repetitive integration mode, the integration time and integration value are automatically reset, and the integration is repeated until STOP is pressed or when the reservation time for stopping the integration is reached..

- **Resetting the Integration**

24. Press the **RESET** soft key. The STOP indicator turns OFF, the integration time and integration value are reset, and the display shows [-----] (no data).

## 5.14 Setting the Real-Time Integration and Real-Time Repetitive Integration

---

### Explanation

For functional details, see section 2.6.

To perform integration, the integration mode and integration time must be set before starting the operation.

- **Selecting the Real-time Normal Integration Mode or Real-time Repetitive Integration Mode**

In this mode, integration is performed between the times specified by integration start and stop. This mode consists of the following two types.

- **Real-Time Normal Integration Mode**

The date, time, and integration timer time of start and stop of the integration operation is set. The integration is stopped at the specified time, when the maximum integration time of 10000 hours is exceeded, or when the integration value reaches the maximum or minimum integration display value (see section 5.11). The integration time and value are held at that point.

- **Real-Time Repetitive Integration Mode (Continuous Integration)**

The start and stop of the integration operation is set through date and time and the integration timer time. The integration is repeated at the specified timer setting during that time. When the time specified by the timer elapses, the operation is automatically reset and restarted. The integration is stopped at the specified time or when the integration value reaches the maximum or minimum integration display value. The integration time and value are held at that point.

- **Setting the Integration Timer**

- The time in units of hour:minute:second can be set in the following range.  
00000:00:00 to 10000:00:00

### Note

---

If you set the integration timer time to 00000:00:00 in real-time normal integration mode, the integration starts at the specified start date/time. The integration is stopped at the specified time, when the maximum integration time of 10000 hours is exceeded, or when the integration value reaches the maximum or minimum integration display value. The integration time and value are held at that point.

---

- **Setting the Reservation Time**

Set the time to start/stop the integration in year:month:day, hour:minute:second. Make sure the reservation time for stopping the integration is after the reservation time for starting the integration.

The selectable range of the values is as follows:

Year: 4-digit year  
Hour:minute:second: 00:00:00 to 23:59:59

### Note

---

- The reservation time allows up to 31 days to be specified for February. In this case, an error message is displayed at the time of execution of the integration operation (section 5.13).  
Reset the reservation time.
  - Leap years are recognized at the time of execution of the integration operation.
- 

For a description of starting, stopping, and resetting the integration and other items, see section 5.11.

## 5.15 Turning ON/OFF the Integration Auto Calibration

### Procedure

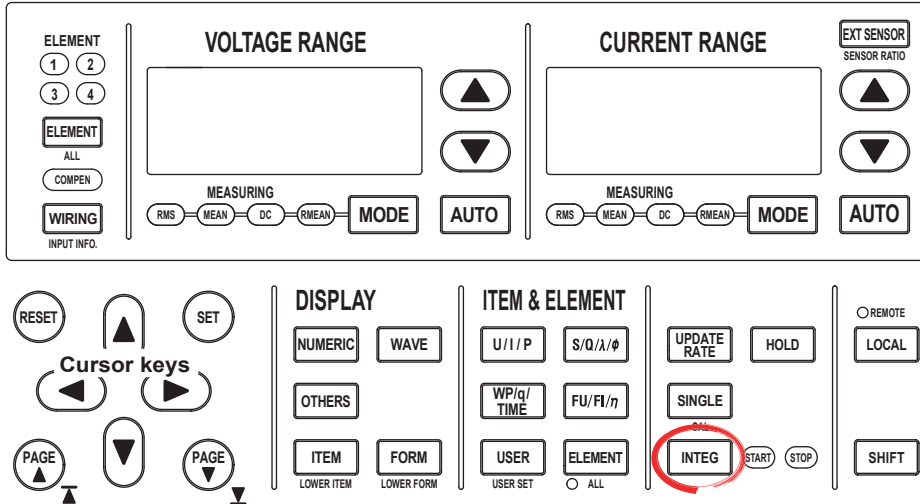

To exit the menu during operation, press **ESC** located above the soft keys.

In the procedural explanation below, the phrase “press the **cursor keys**” may be used. This phrase refers to the procedures for selecting items and entering values and character strings. For details on the procedures, see section 3.14.

1. Press **INTEG** to display the Integ menu.
2. Press the **Integ Set** soft key to display the Integ Set menu.

### Turning ON/OFF the Integration Auto Calibration

3. Press the **Auto Cal** soft key to select ON or OFF.

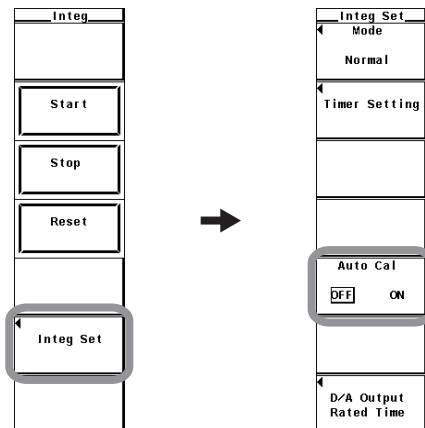

### Explanation

#### Turning ON/OFF Integration Auto Calibration

Zero-level compensation is normally performed when the measurement range or line filter is changed. However, zero-level compensation can be automatically performed during integration.

- **ON:** Zero-level compensation is automatically performed every hour while integration is in progress.
- **OFF:** Zero-level compensation is not automatically performed while integration is in progress.

#### Note

When integration auto calibration is ON and zero-level compensation is in progress, the power or current value measured immediately before is integrated.

# 6.1 Waveform Display

## Procedure

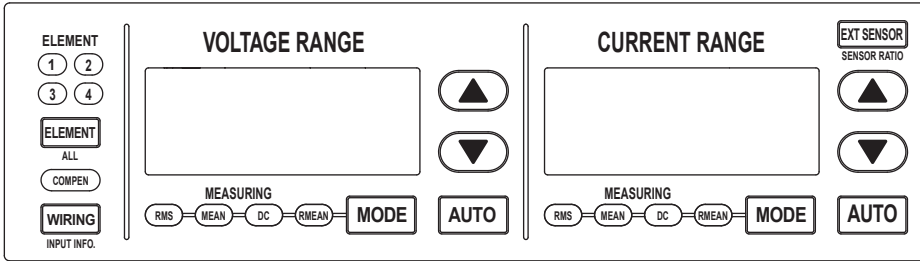

To exit the menu during operation, press **ESC** located above the soft keys.

In the procedural explanation below, the phrase “press the **cursor keys**” may be used. This phrase refers to the procedures for selecting items and entering values and character strings. For details on the procedures, see section 3.14.

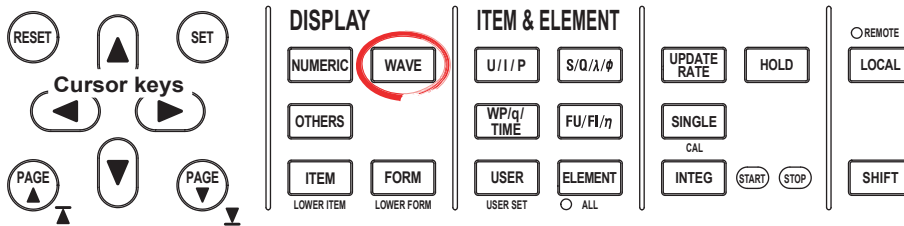

- **Displaying the Waveform on the Entire Screen**

1. Press **WAVE** to display the waveform screen.

If wide bandwidth harmonic measurement mode is enabled on models with the advanced computation (/G6) option, switch to normal measurement mode. For the procedure, see section 3.16.

- **Displaying the Waveform by Dividing the Display into Halves (Split Display)**

2. Press **OTHERS** to display the Others menu.
3. Press any of the soft keys from **Numeric+Wave**, **Wave+Bar**,<sup>\*1</sup> **Wave+Trend**, and **Wave+FFT**<sup>\*2</sup> to select the display mode.

<sup>\*1</sup> Displayed only on models with the advanced computation (/G6) or harmonic measurement (/G5) option.

<sup>\*2</sup> Displayed only to products with the advanced computation (/G6) option.

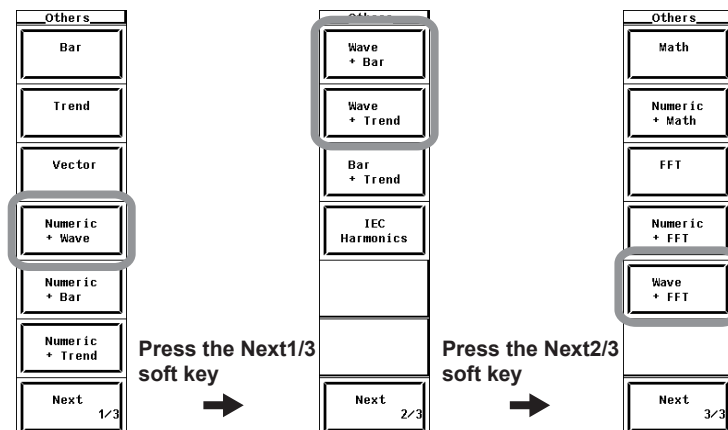

**Explanation**

For functional details, see section 2.7.

A display example is shown below. For the procedure to change the displayed items and contents of waveforms, see sections 6.2 to 6.8.

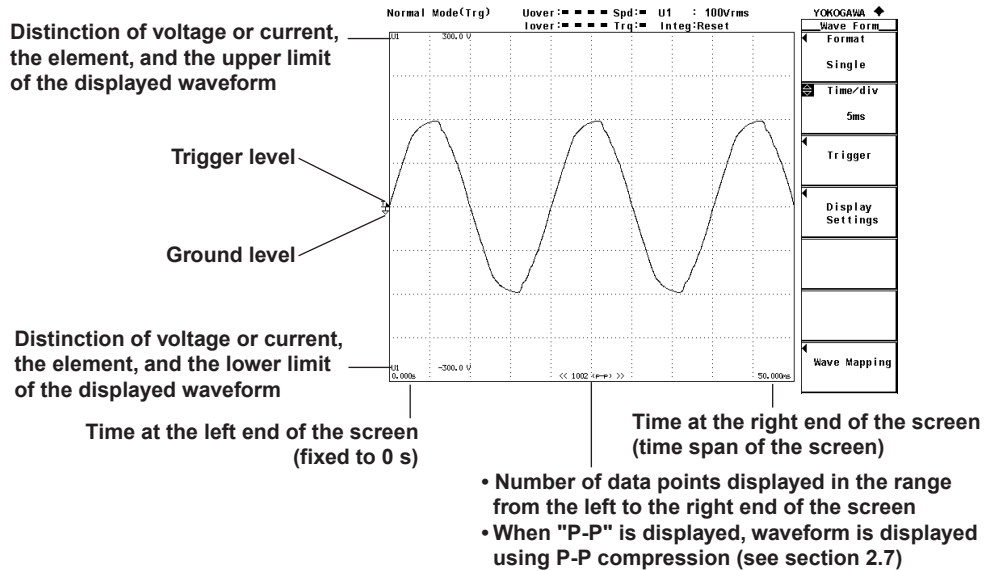

• **Selecting the Display Mode**

Select the waveform display format from the following:

- **Displaying the Waveform on the Entire Screen**  
Press the WAVE key to display the waveform on the entire screen.
- **Displaying the Waveform by Dividing the Display into Halves (Split Display)**
  - **Numeric+Wave**  
The numeric data and waveform are displayed separately in the top and bottom windows. For details on how to set the numeric data display, see section 3.15 and chapter 5.
  - **Wave+Bar**  
The waveform and bar graph are displayed separately in the top and bottom windows. For details on how to set the bar graph display, see the *Expansion Function User's Manual IM760301-51E*.
  - **Wave+Trend**  
The waveform and trend are displayed separately in the top and bottom windows. For details on how to set the trend, see chapter 7.

In addition, the measurement period of the numeric data and that of the waveform data may not be synchronized.

**Measurement Mode during Waveform Display**

When waveforms are displayed, the measurement mode indication at the upper left corner of the screen is set to Normal Mode (Trg). This mode in normal measurement mode (normal mode) allows a measurement to be made after a trigger (see section 6.3) is detected for each update interval.

**Note**

- If the trigger is not set correctly, the start position (the signal level at the left end of the screen) of the waveform display may be unstable, or waveforms may not be displayed.
- While integration is in progress or is suspended, the measurement mode indication at the upper left corner of the screen is set to Normal Mode even when waveforms are displayed. In this mode, the sampled data is automatically updated for each interval. In this case, the trigger function for waveform display does not work. Therefore, the start position of the waveform display (the signal level at the left end of the screen) may not be stable. In addition, the measurement period of the numeric data and that of the waveform data may not be synchronized.

## 6.2 Selecting the Waveform to Be Displayed

### Procedure

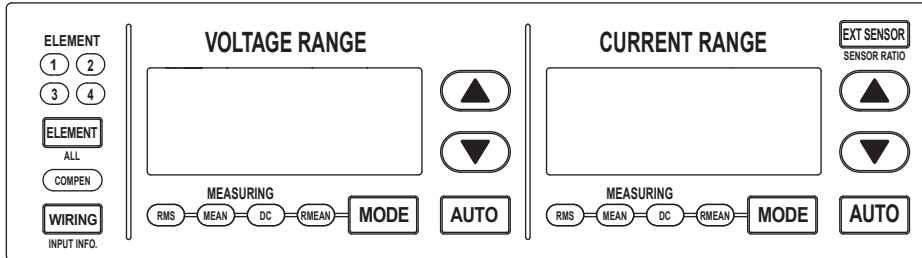

To exit the menu during operation, press **ESC** located above the soft keys.

In the procedural explanation below, the phrase “press the **cursor keys**” may be used. This phrase refers to the procedures for selecting items and entering values and character strings. For details on the procedures, see section 3.14.

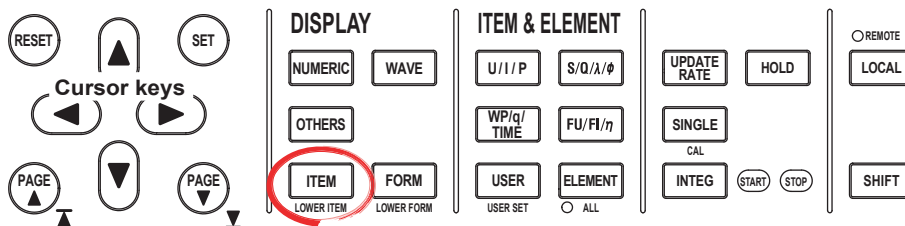

1. Press **ITEM** to display the Wave Items menu.  
If the waveform display is at the lower section of the screen on the split display, press **SHIFT+ITEM (LOWER ITEM)**.
2. Press the **Wave Display** soft key to display the Wave Display dialog box.

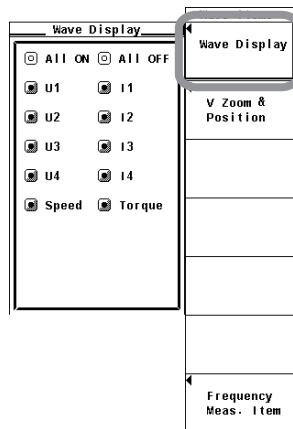



## 6.2 Selecting the Waveform to Be Displayed

---

- **Turning ON/OFF the Display the Input Signal Waveforms Collectively**
  - **Displaying the Waveforms Collectively**
    3. Press the **cursor keys** to select All ON.
    4. Press **SET**. All the buttons to the left of the input signal are highlighted, and all the waveforms are displayed.
  - **Hiding the Waveforms Collectively**
    3. Press the **cursor keys** to select All OFF.
    4. Press **SET**. The highlighting of all the buttons to the left of the signal is cleared, and the waveforms are no longer displayed.
- **Turning ON/OFF the Input Signal Waveforms One at a Time**
  3. Press the **cursor keys** to select the input signal you wish to set.
  4. Press **SET**. The button to the left of the selected input signal is highlighted, and the corresponding waveform is displayed. If the highlighting of the button is cleared, the waveform of that input signal is no longer displayed.

### Explanation

Only the input signals corresponding to the installed elements are displayed. The waveform display can be turned ON/OFF for those input signals. For models with the motor evaluation function (motor version), the waveform display for Speed and Torque input signals can be turned ON/OFF through this procedure.

## 6.3 Setting the Time Axis

### Procedure

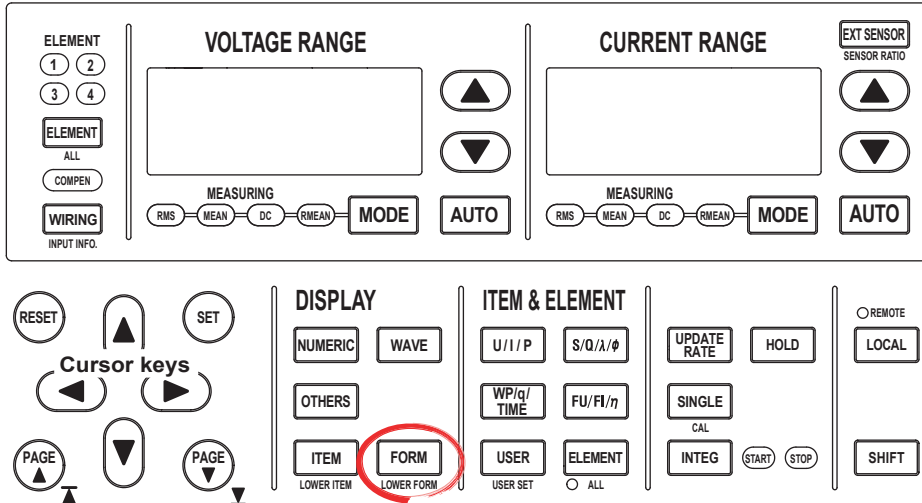

To exit the menu during operation, press **ESC** located above the soft keys.

In the procedural explanation below, the phrase “press the **cursor keys**” may be used. This phrase refers to the procedures for selecting items and entering values and character strings. For details on the procedures, see section 3.14.

1. Press **FORM** to display the Wave Form menu.  
If the waveform display is at the lower section of the screen on the split display, press **SHIFT+FORM (LOWER FORM)**.
2. Press the **cursor keys** to set the time axis. When the display of scale values is turned ON (see section 6.8), the times at the left end (fixed to 0 s) and the right end of the screen are displayed in the lower left corner and lower right corner of the screen, respectively.

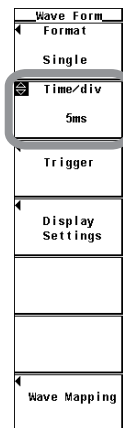

### 6.3 Setting the Time Axis

#### Explanation

For functional details, see section 2.7.

Set the time axis in terms of Time/div (time per grid).

The time axis can be set in 1, 2, or 5 steps in the range up to the point in which the time corresponding to one screen is equal to the data update interval. For example, changing the time per division in the order 0.5 ms, 1 ms, 2 ms, 5 ms, 10 ms, 20 ms, and 50 ms when the data update interval is 500 ms changes the time corresponding to one screen in the order 5 ms, 10 ms, 20 ms, 50 ms, 100 ms, 200 ms, and 500 ms.

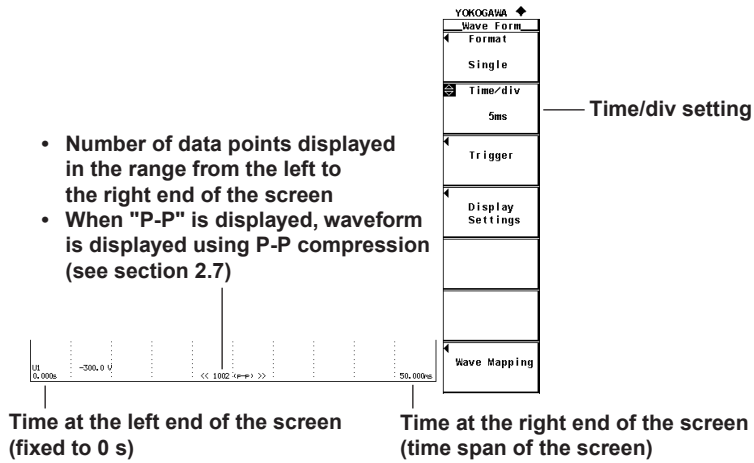

## 6.4 Setting the Trigger

### Procedure

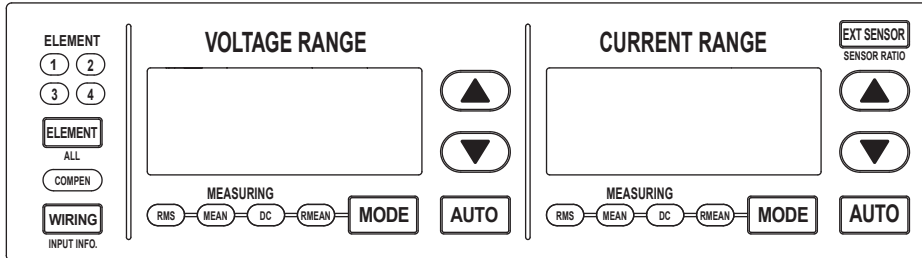

To exit the menu during operation, press **ESC** located above the soft keys.

In the procedural explanation below, the phrase “press the **cursor keys**” may be used. This phrase refers to the procedures for selecting items and entering values and character strings. For details on the procedures, see section 3.14.

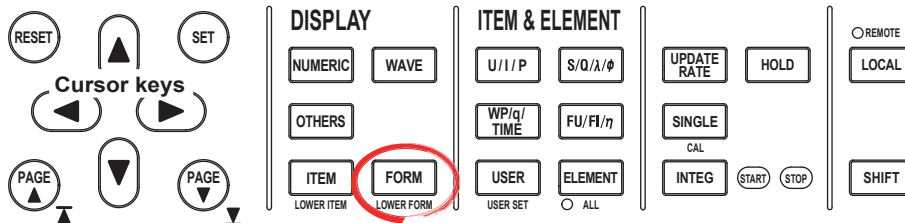

1. Press **FORM** to display the Wave Form menu.  
If the waveform display is at the lower section of the screen on the split display, press **SHIFT+FORM (LOWER FORM)**.
2. Press the **Trigger** soft key to display the Trigger menu.

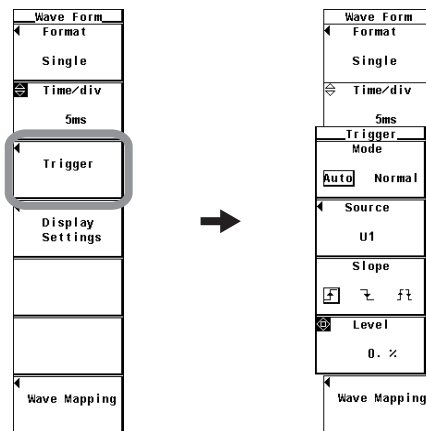

## 6.4 Setting the Trigger

- **Selecting the Trigger Mode**

3. Press the **Mode** soft key to select Auto or Normal.

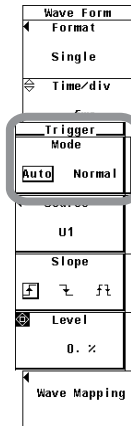

- **Selecting the Trigger Source**

3. Press the **Source** soft key. A trigger source selection box appears.
4. Press the **cursor keys** to select any of the elements/wiring units starting with U1.
5. Press **SET** to confirm the new trigger source.

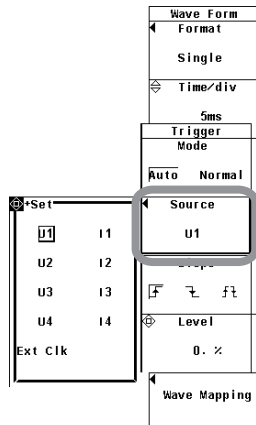

- **Selecting the Trigger Slope**

3. Press the **Slope** soft key to select f, ꞑ, or ft.

- **Setting the Trigger Level**

3. Press the **cursor keys** to set the trigger level.

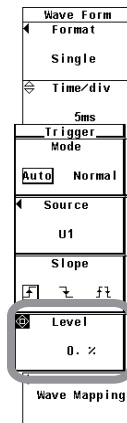
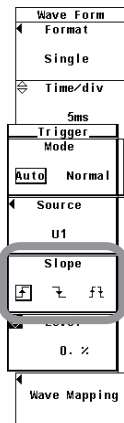

**Explanation**

For functional details, see section 2.7.

A trigger is a cue used to display the waveform on the screen. The trigger is activated when the specified trigger condition is met. At this point, the waveform is ready to be displayed on the screen.

- **Selecting the Trigger Mode.**

Trigger mode specifies the conditions for updating the screen display. You can select the measurement range from the following:

- **Auto**  
Enables auto mode.
  - If a trigger occurs within the timeout time (approx. 100 ms), the display is updated using that trigger.
  - If a trigger does not occur within the timeout time, the display is automatically updated when the timeout time elapses.
  - When the trigger signal period is greater than or equal to 100 ms, the two conditions above are met alternately and the display is updated. In this happens, use normal mode.
- **Normal**  
Enables normal mode.
  - The display is updated when the trigger occurs.
  - The display is not updated if the trigger does not occur.

- **Selecting the Trigger Source**

Select the target to which the trigger condition is applied (trigger source) from below. The selectable items vary depending on the installed elements.

U1, I1, U2, I2, U3, I3, U4, I4, and Ext Clk (external clock)\*

\* If the trigger source is set to Ext Clk, apply a signal according to the following specifications. If the trigger source is set to Ext Clk, the trigger level settings are void.

- **When Setting the Trigger Source to Ext Clk**

Apply a trigger signal to the external clock input connector (EXT CLK) on the rear panel according to the following specifications.



Item	Specifications
Connector type	BNC connector
Input level	TTL
Minimum pulse width	1 $\mu$ s
Trigger delay time	Within (1 $\mu$ s + 1 sample interval)



### **CAUTION**

Applying a voltage outside the range of 0 to 5 V to the external clock input connector (EXT CLK) can damage the instrument.

• **Input Circuit for the External Trigger Signal and Time Chart**

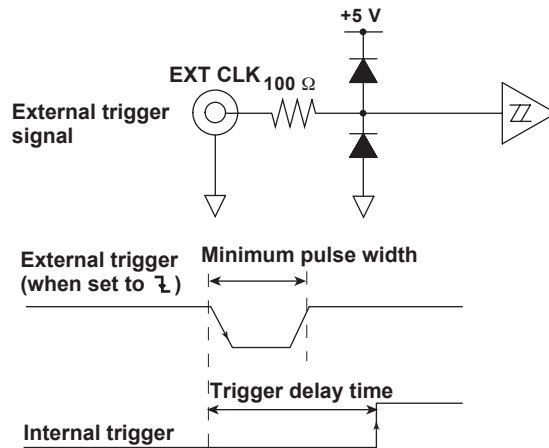

• **Selecting the Trigger Slope**

The up and down movement of a signal level is called a slope. When the slope is used as one of the trigger conditions, it is called a trigger slope. You can select the trigger slope from the following:

- $\nearrow$ : The trigger occurs when the trigger source signal rises above the trigger level from a lower level.
- $\searrow$ : The trigger occurs when the trigger source signal falls below the trigger level from a higher level.
- $\nearrow\searrow$ : Trigger occurs on both the rising and falling cases.

• **Setting the Trigger Level**

Trigger level refers to the level through which the trigger slope passes. When the slope of the trigger source passes through the specified trigger level on a rising or falling edge, a trigger occurs.

- The level can be set in the range of 0.0 to  $\pm 100.0\%$ .
- Half of the total vertical span of the waveform display screen is considered to be 100%. With the vertical center of the screen taken to be the input zero line, the upper and lower limits of the waveform display screen are 100% and  $-100\%$ , respectively. If the crest factor is set to 3, the upper and lower limits of the waveform display screen correspond to three times the measurement range (if scaled, the range after scaling) of the voltage/current that is set for each element. Likewise, if the crest factor is set to 6, the upper and lower limits correspond to six times the measurement range.
- The trigger level setting is void when the trigger source is set to Ext Clk.
- **Measurement range: 100 Vrms when the crest factor is 3, 50 Vrms when the crest factor is 6**
- **Trigger level: 25%**

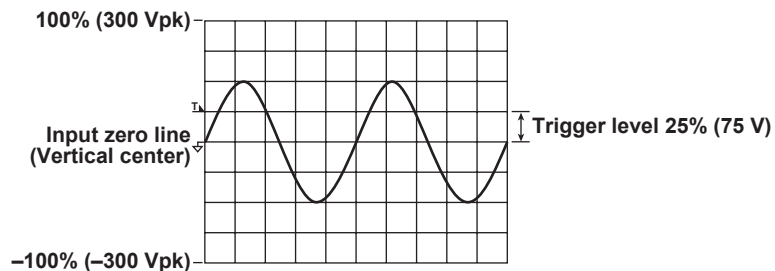

### **Note**

- To prevent erroneous operation caused by noise, the trigger function uses approximately 2% hysteresis if the crest factor is set to 3. For example, if the trigger slope is set to  $\uparrow$ , a trigger occurs if the input signal passes through the trigger level on the rising edge after the input signal level falls approximately 2% below the trigger level. The trigger function uses approximately 4% hysteresis if the crest factor is set to 6.
  - The trigger function for waveform display does not work while integration is in progress or is suspended. Therefore, the start position of the waveform display (the signal level at the left end of the screen) may not be stable. In addition, the measurement period of the numeric data and that of the waveform data may not be synchronized.
-



## 6.5 Zooming Vertically and Moving the Vertical Position

### Procedure

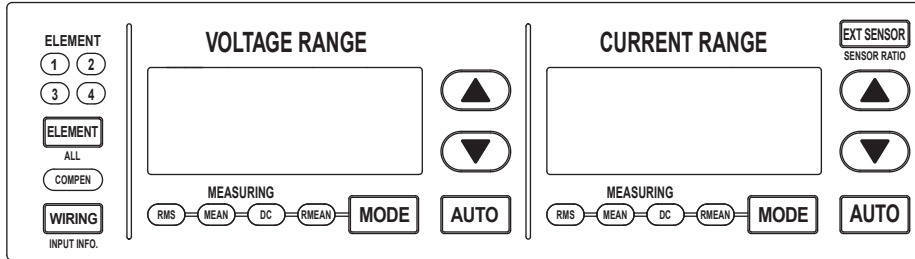

To exit the menu during operation, press **ESC** located above the soft keys.

In the procedural explanation below, the phrase “press the **cursor keys**” may be used. This phrase refers to the procedures for selecting items and entering values and character strings. For details on the procedures, see section 3.14.

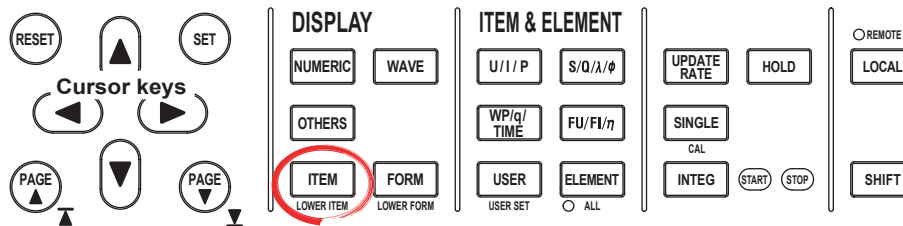

1. Press **ITEM** to display the Wave Items menu.  
If the waveform display is at the lower section of the screen on the split display, press **SHIFT+ITEM (LOWER ITEM)**.
  2. Press the **V Zoom & Position** soft key to display the V Zoom & Pos menu.
- **Selecting the Target Element**
    3. Press the **Element** soft key to display the Element menu.  
Only the installed elements are displayed.
    4. Press one of the soft keys corresponding to the displayed element to select the target element.

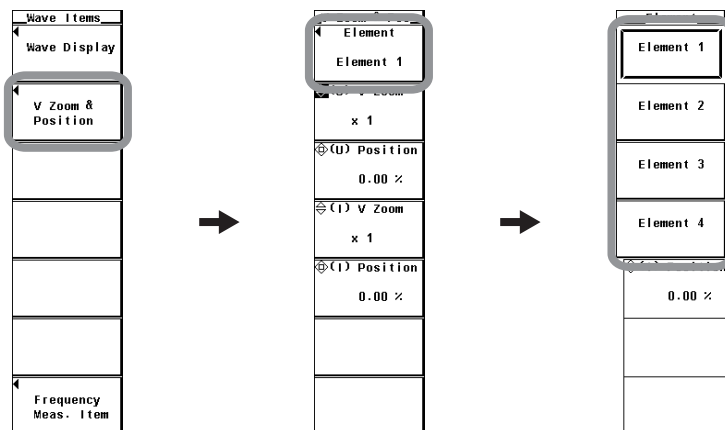

- **Zooming in on the Voltage Waveform**
  5. Press the **(U) V Zoom** soft key.
  6. Press the **cursor keys** to set the zoom rate.
  
- **Moving the Voltage Waveform Position**
  5. Press the **(U) Position** soft key.
  6. If the crest factor is set to 3 or 6, press the **cursor keys** to set the position in terms of a percentage with the value equal to measurement range  $\times$  3 or measurement range  $\times$  6, respectively, taken to be 100%.
  
- **Zooming in on the Current Waveform**
  5. Press the **(I) V Zoom** soft key.
  6. Press the **cursor keys** to set the zoom rate.
  
- **Moving the Current Waveform Position**
  5. Press the **(I) Position** soft key.
  6. If the crest factor is set to 3 or 6, press the **cursor keys** to set the position in terms of a percentage with the value equal to measurement range  $\times$  3 or measurement range  $\times$  6, respectively, taken to be 100%.

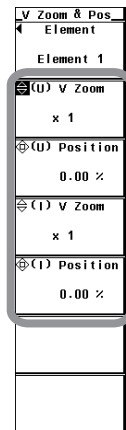

## 6.5 Zooming Vertically and Moving the Vertical Position

### Explanation

- **Selecting the Target Element to Be Specified**

Only the installed elements are displayed. The Element menu is displayed according to the element configuration of the product.

- **Zoom (Vertical Direction Only)**

You can expand or reduce each displayed waveform (voltage/current). You can select the zoom factor from the following:

0.1, 0.2, 0.25, 0.4, 0.5, 0.75, 0.8, 1, 1.14, 1.25, 1.33, 1.41, 1.5, 1.6, 1.77, 2, 2.28, 2.66, 2.83, 3.2, 3.54, 4, 5, 8, 10, 12.5, 16, 20, 25, 40, 50, and 100

- **Moving the Position (Vertical Direction Only)**

The displayed position of the waveform can be moved vertically to the desired position such as when you wish to view the mutual relationship between the voltage and current waveforms or when the section of the waveform you wish to view goes out of the display frame.

- The position can be set in the range from 0.000 to  $\pm 130.000\%$ .
- When the zoom factor is 1, half of the total vertical span of the waveform display screen (equal to measurement range  $\times 3$  or measurement range  $\times 6$  when the crest factor is set to 3 or 6, respectively) is considered to be 100%. The span between the vertical center of the screen to the upper limit of the screen is 100%; the span between the vertical center of the screen to the lower limit of the screen is  $-100\%$ .

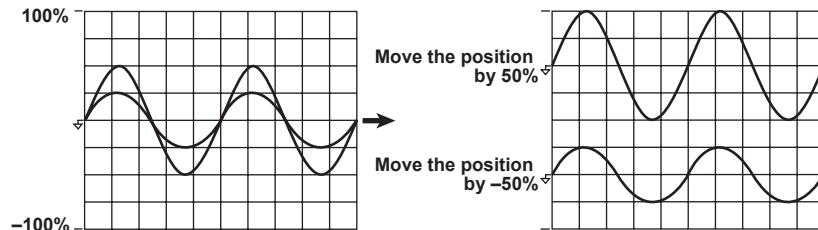

- When the zoom factor is not 1, the value equal to the measurement range  $\times 3$  (100%) or measurement range  $\times 6$  (100%) when the crest factor is set to 3 or 6, respectively, is not located at the upper and lower limits of the screen as shown in the following figure. Set the position by paying attention to the zoom factor. The following figure shows an example when the crest factor is set to 3.

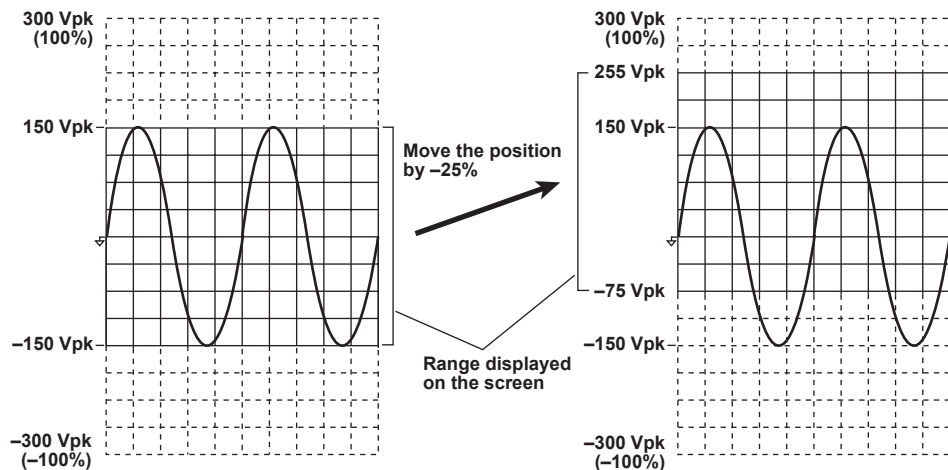

### Note

To expand and view a section of the waveform, we recommend the following procedure.

1. Set the zoom factor to 1.
2. Move the vertical position so that the desired section of the waveform is at the center position (according to the procedure described in this section).
3. Set the vertical zoom factor.

## 6.6 Waveform Display on Divided Windows

### Procedure

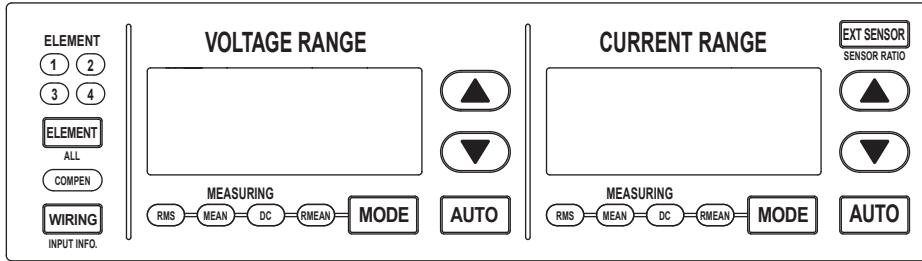

To exit the menu during operation, press **ESC** located above the soft keys.

In the procedural explanation below, the phrase “press the **cursor keys**” may be used. This phrase refers to the procedures for selecting items and entering values and character strings. For details on the procedures, see section 3.14.

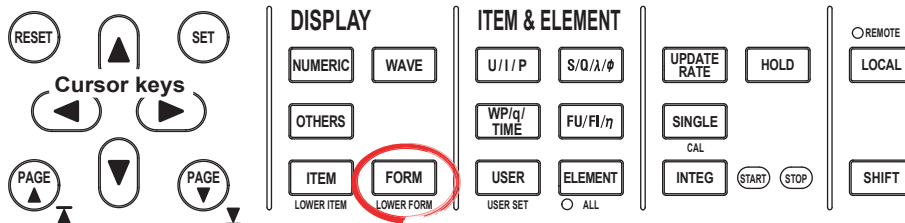

1. Press **FORM** to display the Wave Form menu.

If the waveform display is at the lower section of the screen on the split display, press **SHIFT+FORM (LOWER FORM)**.

- **Selecting the Number of Screen Divisions**

2. Press the **Format** soft key to display the Format menu.
3. Press any of the keys from **Single to Quad** to select the number of windows.

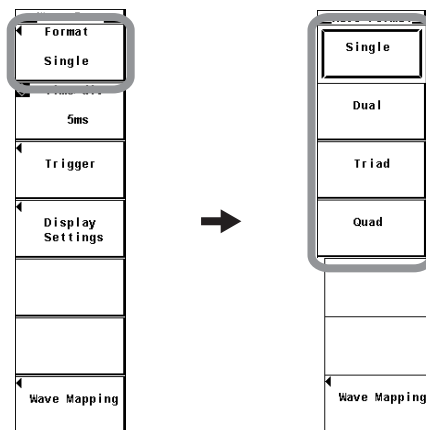

## 6.6 Waveform Display on Divided Windows

- **Selecting the Waveform Mapping**
  4. Press the **Wave Mapping** soft key to display the Wave Mapping dialog box.
  5. Press **SET** to set the mode to Auto, Fixed, or User. If you selected User, proceed to step 6.
  6. Press the **cursor keys** to select the input signal you wish to set.
  7. Press **SET**. A box used to set the display position number appears.
  8. Press the **cursor keys** to select a value between 0 and 3.
  9. Press **SET** to confirm the new display position.

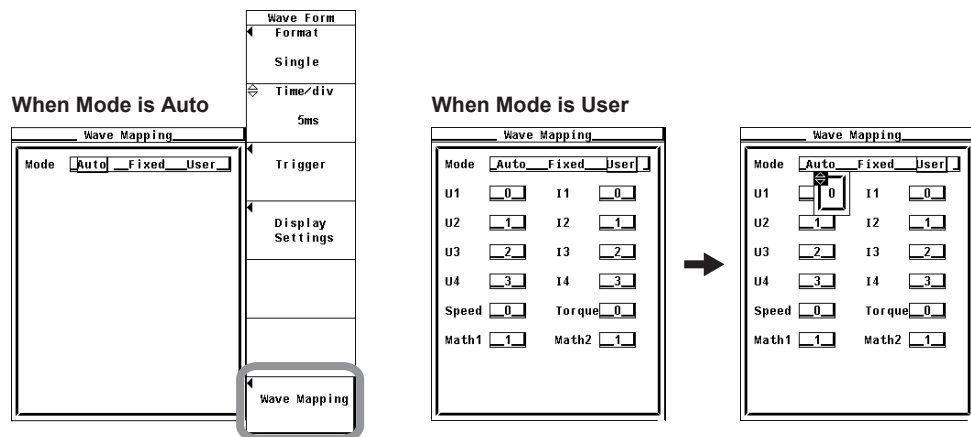

**Explanation**

The screen can be evenly divided and the waveforms can be assigned to the divided windows.

• **Selecting the Number of Divisions**

Select the number of divisions of the screen from the choices below.

- Single: No division
- Dual: 2 divisions
- Triad: 3 divisions
- Quad: 4 divisions

The number of displayed points in the vertical direction of one divided window varies depending on the number of divisions as follows:

Single: 432 points, Dual: 216 points, Triad: 144 points, Quad: 108 points

• **Waveform Mapping**

• Auto

The waveforms that are turned ON (see section 6.1) are assigned to the divided windows in order by element numbers in the order voltage (U), current (I), Speed,<sup>\*1</sup> Torque,<sup>\*1</sup> Math1,<sup>\*2</sup> and Math2.<sup>\*2</sup>

\*1 Applicable only to products with the motor evaluation function (motor version).

\*2 Applicable only to products with the advanced computation (/G6 option). Math waveforms are displayed only in waveform computation mode.

• Fixed

The waveforms are assigned in order by element number in the order voltage (U) and current (I) to the divided windows regardless of whether or not the display is turned ON. Speed<sup>\*</sup> is displayed in the top frame; Torque<sup>\*</sup> is displayed in the 2nd frame from the top.

The following figure shows how the waveforms are displayed when all 4 elements are installed, with the motor evaluation function (motor version), the number of division is 4 (Quad), display of U1, I1, U2, I2, U3, I3, I4, and Torque is ON, and display of U4 and Speed is OFF.

**Auto**

U1, U3
I1, I3
U2, I4
I2, Torque

**Fixed**

U1, U3
I1, I3, Torque
U2
I2, I4

• User

The waveforms can be assigned arbitrarily to the divided windows regardless of whether or not the display is turned ON. You can select the display position from 0 to 3. The waveforms are assigned in order starting from number 0 from the top divided window.

**User (when the screen is divided into three windows with I1, Speed, and Torque set to 0, 1, and 3, respectively)**

I1, Torque	0,3	] Displayed in order according to the specified number.
Speed	1	
	2	

## 6.7 Selecting the Display Interpolation and Graticule

### Procedure

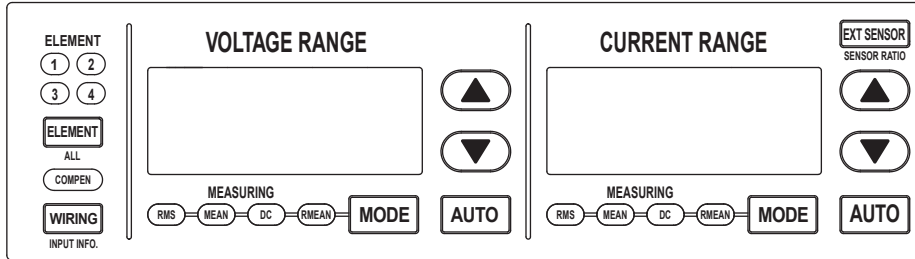

To exit the menu during operation, press **ESC** located above the soft keys.

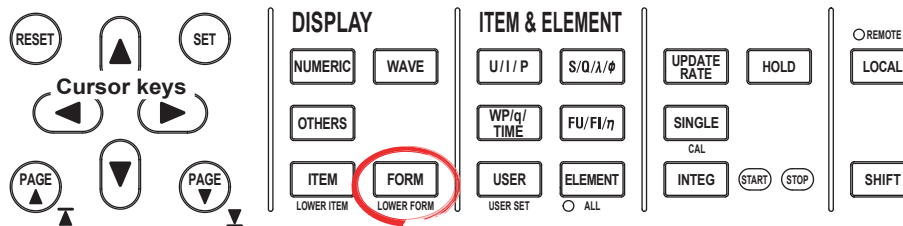

In the procedural explanation below, the phrase “press the **cursor keys**” may be used. This phrase refers to the procedures for selecting items and entering values and character strings. For details on the procedures, see section 3.14.

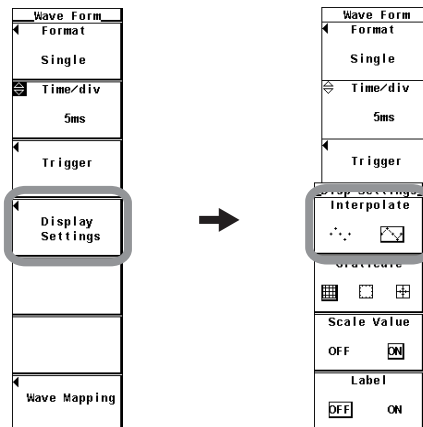

1. Press **FORM** to display the Wave Form menu.  
If the waveform display is at the lower section of the screen on the split display, press **SHIFT+FORM (LOWER FORM)**.
2. Press the **Display Setting** soft key to display the Disp Setting menu.
- **Selecting Whether to Interpolate the Display**
  3. Press the **Interpolate** soft key to select  $\cdot\cdot\cdot$  or  $\wedge\wedge\wedge$ .



• **Changing the Graticule**

3. Press the **Graticule** soft key to select , , or .

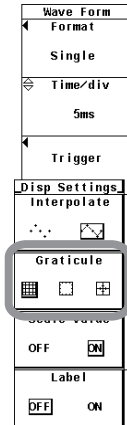

**Explanation**

For functional details, see section 2.7.

• **Selecting Whether to Interpolate the Display**

When there are less than 500 points of sampled data on the time axis, the area between the display points (rasters) is no longer continuous. This function interpolates between the points to display the waveforms. You can select the measurement range from the following:

- : No interpolation is performed.
  - When the area is not an interpolation area

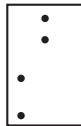

- When the area is an interpolation area

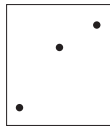

- : Linearly interpolates between two points.
  - When the area is not an interpolation area  
Connects the dots vertically.



- When the area is an interpolation area





## 6.7 Selecting the Display Interpolation and Graticule

---

- **Changing the Graticule**

Select the grid or cross scale to display on the screen from the choices below.

- : Grid display

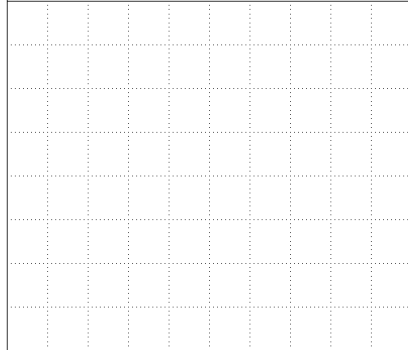

- : No grid or cross scale display

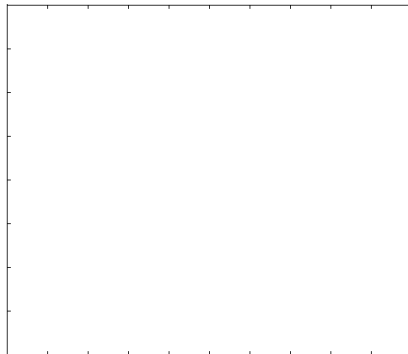

- : Cross scale display

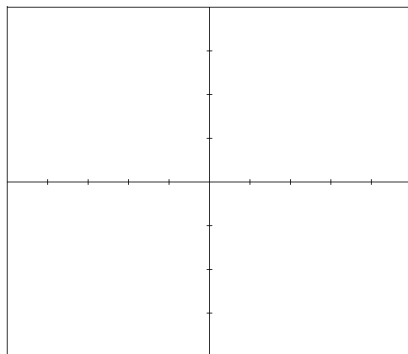

## 6.8 Turning ON/OFF the Scale Value and Waveform Label

### Procedure

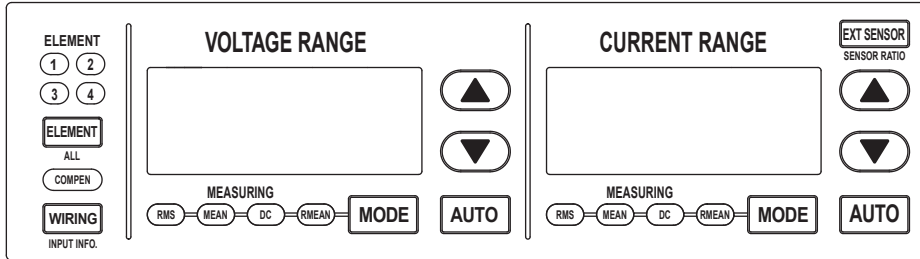

To exit the menu during operation, press **ESC** located above the soft keys.

In the procedural explanation below, the phrase “press the **cursor keys**” may be used. This phrase refers to the procedures for selecting items and entering values and character strings. For details on the procedures, see section 3.14.

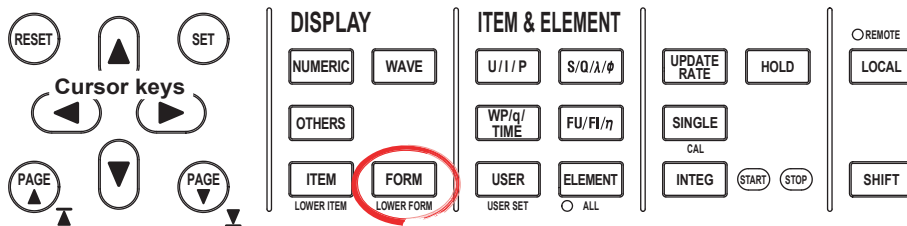

1. Press **FORM** to display the Wave Form menu.  
If the waveform display is at the lower section of the screen on the split display, press **SHIFT+FORM (LOWER FORM)**.
  2. Press the **Display Setting** soft key to display the Disp Setting menu.
- **Turning ON/OFF the Scale Value Display**
    3. Press the **Scale Value** soft key to select ON or OFF.
  - **Turning ON/OFF the Waveform Label**
    3. Press the **Label** soft key to select ON or OFF.

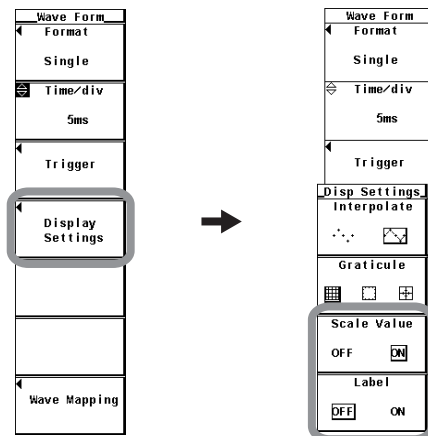

## 6.8 Turning ON/OFF the Scale Value and Waveform Label

### Explanation

- **Turning ON/OFF the Scale Value Display**

You can select whether or not to display (ON/OFF) the upper and lower limits of the vertical axis and the values at the left and right ends of the horizontal axis (time axis, see section 6.3) of each channel.

- ON  
Displays the scale values.
- OFF  
Does not display the scale values.

- **Turning ON/OFF the Label Display**

You can select whether to display waveform labels (input signal names).

- ON  
Displays the label name.
- OFF  
Does not display the label name.

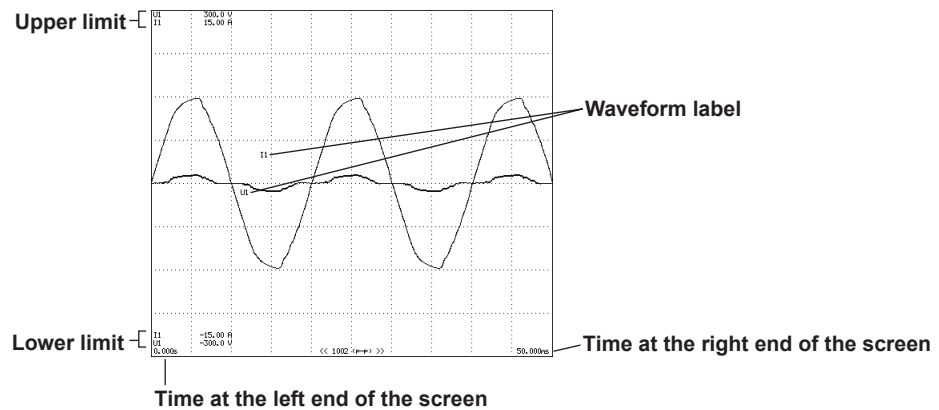

## 6.9 Cursor Measurement

### Procedure

**Cursor keys**

RESET    ▲    SET

◀    ▶

▼    ▲

PAGE    ▼    PAGE

▲    ▼

SCALING    LINE FILTER    AVG

MOTOR SET    FREQ. FILTER    SYNC SOURCE

HRM SET    **MEASURE** (CURSOR)    ○ NULL

FILE    IMAGE SAVE    STORE

MENU    STORE SET

PRINT    MISC    HELP

MENU

**DISPLAY**

NUMERIC    WAVE

OTHERS

ITEM    FORM

LOWER ITEM    LOWER FORM

**ITEM & ELEMENT**

U/I/P    S/Q/A/#

WP/q/TIME    FU/FI/η

USER    ELEMENT

USER SET    ○ ALL

UPDATE RATE    HOLD

SINGLE CAL

INTEG    START    STOP

○ REMOTE

LOCAL

SHIFT

To exit the menu during operation, press **ESC** located above the soft keys.

In the procedural explanation below, the phrase “press the **cursor keys**” may be used. This phrase refers to the procedures for selecting items and entering values and character strings. For details on the procedures, see section 3.14.

1. Press **SHIFT+MEASURE(CURSOR)** to display the Cursor menu.

#### • Turning ON/OFF Cursor Measurement

2. Press the **Wave Cursor** soft key to select ON or OFF.

If ON is selected, the result of the cursor measurement is displayed.

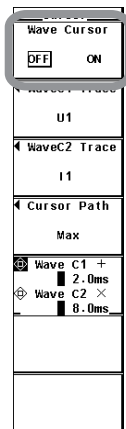

## 6.9 Cursor Measurement

- **Selecting the Target Waveform for Cursor Measurement**
  - **Selecting the Target Waveform for Cursor +**
    3. Press the **Wave C1 Trace** soft key. A box used to select the target waveform appears.
    4. Press the **cursor keys** to select any of the elements/wiring units starting with U1.
    5. Press **SET** to confirm the new target waveform.
  - **Selecting the Target Waveform for Cursor x**
    3. Press the **Wave C2 Trace** soft key. A box used to select the target waveform appears.
    4. Press the **cursor keys** to select any of the elements/wiring units starting with U1.
    5. Press **SET** to confirm the new target waveform.
- **Selecting the Movement Path of the Cursor**
  6. Press the **Cursor Path** soft key to display the Cursor Path menu.
  7. Press any of the soft keys from **Max** to **Mid** to select the movement path.
- **Moving the Cursor**
  8. Press the **Wave C1 +/Wave C2 x** soft key to set the cursor target to Wave C1 +, Wave C2 x, or both Wave C1 + and Wave C2 x.
    - If you select Wave C1 +, the position of cursor + can be moved.
    - If you select Wave C2 x, the position of cursor x can be moved.
    - If you select both Wave C1 + and Wave C2 x, the two cursors can be moved without changing the spacing between the two. The value of the digit being specified by Wave C1 + changes.
  9. Press the **cursor keys** to move the cursor.

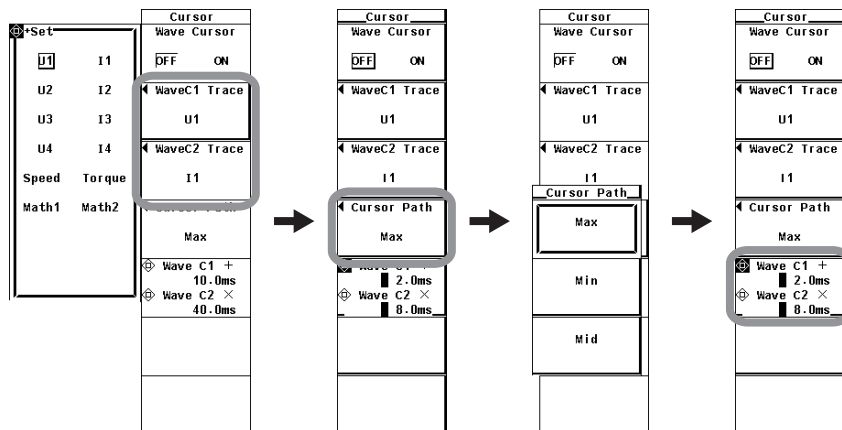

**Explanation**

For functional details, see section 2.6.

- **ON/OFF**

A cursor can be placed on the displayed waveform to measure and display the value at any point. It can be used to measure the voltage and current of various sections of the waveform and the data on the horizontal axis (X-axis).

- ON: Performs cursor measurement.
- OFF: Does not perform cursor measurement.

- **Item under Measurement**

Select the target waveform for the cursor measurement from below. The selectable items vary depending on the installed elements.

U1, I1, U2, I2, U3, I3, U4, I4, Speed,<sup>\*1</sup> Torque,<sup>\*1</sup> Math1,<sup>\*2</sup> and Math2<sup>\*2</sup>

<sup>\*1</sup> Applicable only to products with the motor evaluation function (motor version).

<sup>\*2</sup> Applicable only to products with the advanced computation (/G6 option). Math waveforms are displayed only in waveform computation mode.

- **Measured items**

- Y+: Vertical value of cursor + (Y-axis value)
- Yx: Vertical value of cursor x (Y-axis value)
- ΔY: The difference between the Y-axis values of cursor + and cursor x
- X+: X-axis value of cursor + from the left end of the screen
- Xx: X-axis value of cursor x from the left end of the screen
- ΔX: The difference between the X-axis values of cursor + and cursor x
- 1/ΔX: Reciprocal of the difference between the X-axis values of cursor + and cursor x

- **Movement Path of the Cursor**

Since the WT3000 P-P compresses the sampled data (see section 2.7), two data points, maximum and minimum values, are displayed at the same time axis position. Therefore, you can select the path on which the cursor moves and the data on which to perform cursor measurements from the following:

- Max  
Moves along the maximum values on the time axis and measures the value at each point.
- Min  
Moves along the minimum values on the time axis and measures the value at each point.
- Mid  
Moves along the middle of the maximum and minimum values on the time axis and measures the value at each point.

- **Moving the Cursor**

- Cursors move on the selected waveform.
- The range of movement of cursors is from the left end to the right end of the screen.
- The movement step of cursors is (the time corresponding to one screen) ÷ 500.

**Note**

- if immeasurable data exists, \*\*\* is displayed in the measured value display area.
- ΔY is measured even if the unit is different. The result has no unit in this case.
- If the crest factor is set to 3, the allowed range of cursor measurement vertically is ±300% of the range. If the crest factor is set to 6, it is ±600% of the range.

# 7.1 Trend Display

## Procedure

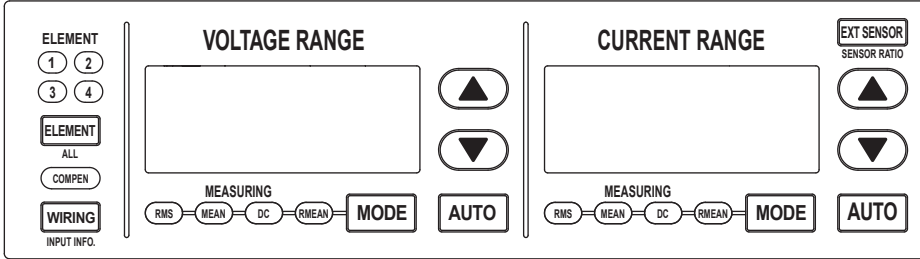

To exit the menu during operation, press **ESC** located above the soft keys.

In the procedural explanation below, the phrase “press the **cursor keys**” may be used. This phrase refers to the procedures for selecting items and entering values and character strings. For details on the procedures, see section 3.14.

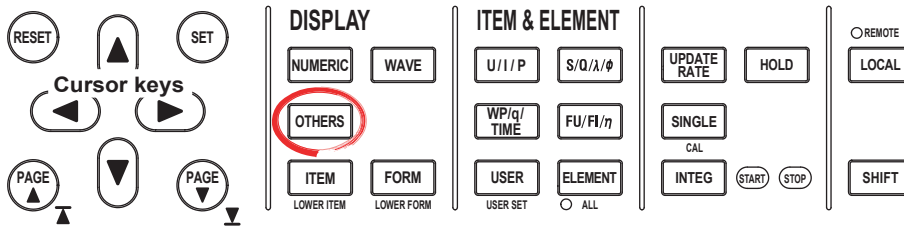

### • Displaying Trends

1. Press **OTHERS** to display the Others menu.
2. Press any of the soft keys from **Trend**, **Numeric+Trend**, **Wave+Trend**, and **Bar+Trend**\* to select the display mode.

\* Displayed only on models with the advanced computation (/G6) or harmonic measurement (/G5) option.

If wide bandwidth harmonic measurement mode is enabled on models with the advanced computation (/G6) option, switch to normal measurement mode. For the procedure, see section 3.16.

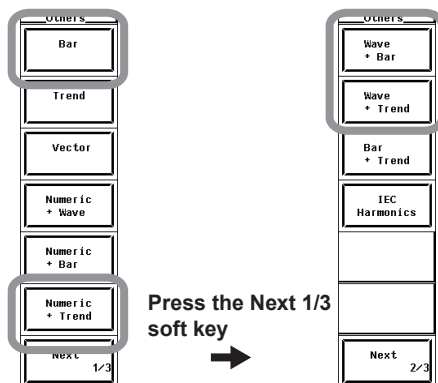

## 7.1 Trend Display

### Explanation

A display example is shown below. The horizontal axis is expressed in terms of time as shown below.

The trend value in the hold condition (see section 4.11) is the same as the numeric data when HOLD is pressed. When hold is released, the trend that was held is displayed.

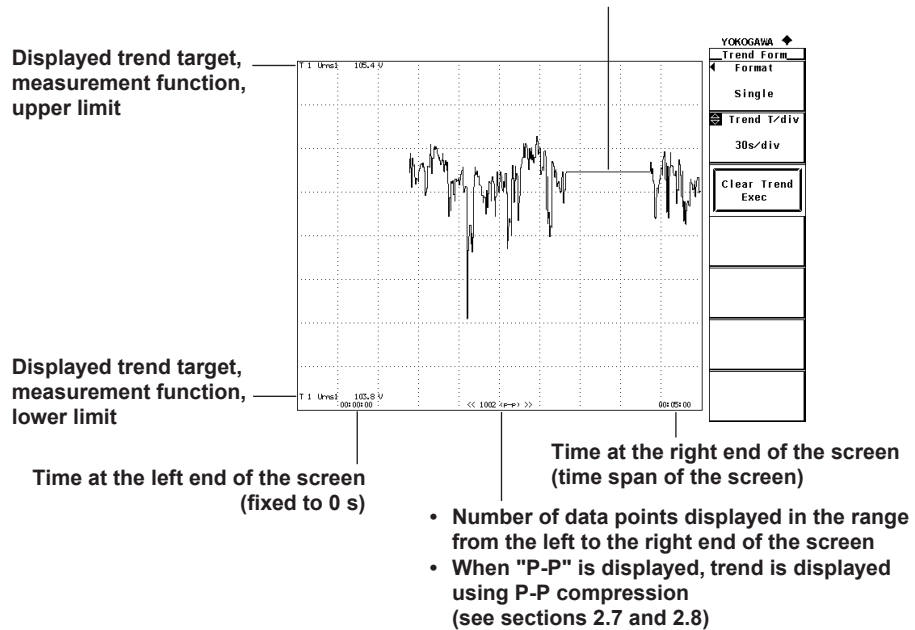

### • Selecting the Display Mode

Select the trend display format from the choices below.

- Displaying the trend on the entire screen  
Press the Trend soft key to display the trend on the entire screen.
- Displaying the trend by dividing the display into halves (split display)
  - Numeric+Trend  
The numeric data and trend are displayed separately in the top and bottom windows. For details on how to set the numeric data display, see section 3.15 and chapter 5.
  - Wave+Trend  
The waveform and trend are displayed separately in the top and bottom windows. For details on how to set the waveform display, see section 6.
  - Bar+Trend  
The bar graph and trend are displayed separately in the top and bottom windows. For details on how to set the bar graph display, see the *Expansion Function User's Manual IM760301-51E*.

### Note

Trends are not displayed if wide bandwidth harmonic measurement mode is enabled on models with the advanced computation (/G6) option.



## 7.2 Selecting the Trend Data to Be Displayed

### Procedure

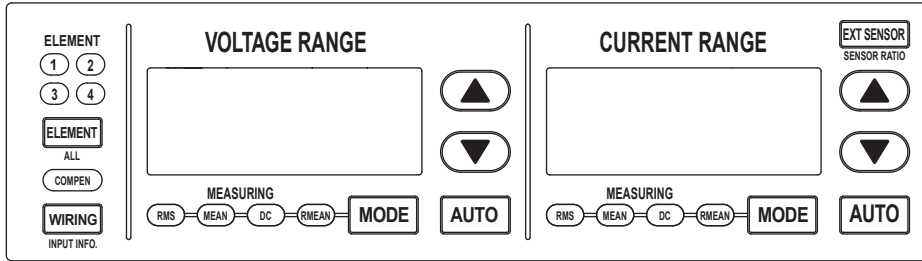

To exit the menu during operation, press **ESC** located above the soft keys.

In the procedural explanation below, the phrase “press the **cursor keys**” may be used. This phrase refers to the procedures for selecting items and entering values and character strings. For details on the procedures, see section 3.14.

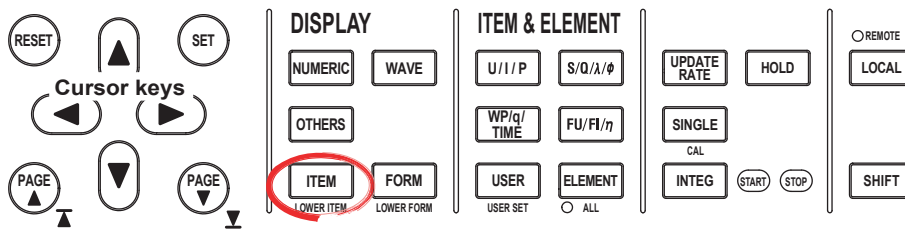

1. Press **ITEM** to display the Trend Items menu.  
If the trend display is at the lower section of the screen on the split display, press **SHIFT+ITEM (LOWER ITEM)**.
2. Press the **Trend Display** soft key to display the Trend Display dialog box.

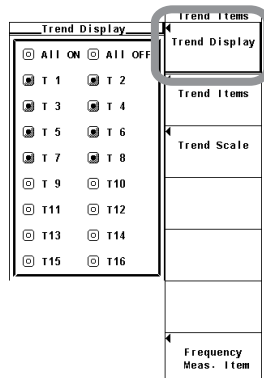

## 7.2 Selecting the Trend Data to Be Displayed

---

- **Turning ON/OFF the Trend Display Collectively**
  - **Displaying the Trends Collectively**
    3. Press the **cursor keys** to select All ON.
    4. Press **SET**. All the buttons to the left of the trend symbols are highlighted, and all the trends are displayed.
  - **Hiding the Trends Collectively**
    3. Press the **cursor keys** to select All OFF.
    4. Press **SET**. The highlighting of all the buttons to the left of the trend symbols is cleared and the trends are no longer displayed.
- **Turning ON/OFF the Trend One at a Time**
  3. Press the **cursor keys** to select the trend symbol you wish to set.
  4. Press **SET**. The button to the left of the selected trend symbol is highlighted, and the corresponding trend is displayed. If the highlighting of the button is cleared, the trend is no longer displayed.

### Explanation

You can turn ON/OFF the trend display from trend 1 (T1) through trend 16 (T16). You can assign measurement functions for which the trend is to be displayed to trend (T1) to trend (T16) by selecting the trend display target (see section 7.3).

## 7.3 Selecting the Trend Display Target

### Procedure

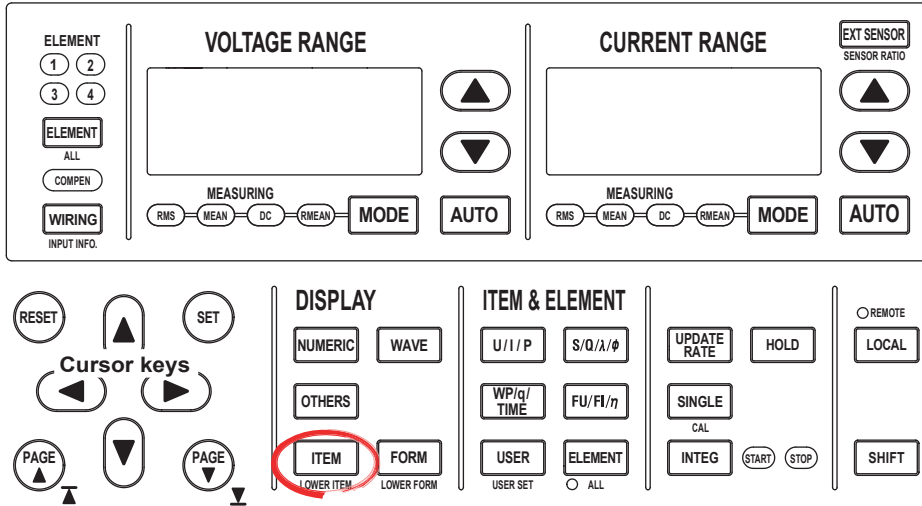

To exit the menu during operation, press **ESC** located above the soft keys.

In the procedural explanation below, the phrase “press the **cursor keys**” may be used. This phrase refers to the procedures for selecting items and entering values and character strings. For details on the procedures, see section 3.14.

1. Press **ITEM** to display the Trend Items menu.  
If the trend display is at the lower section of the screen on the split display, press **SHIFT+ITEM (LOWER ITEM)**.
2. Press the **Trend Items** soft key to display the Trend Items menu.

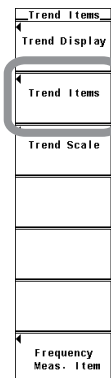

### 7.3 Selecting the Trend Display Target

- **Selecting the Item to Be Set**
  3. Press the **Trend Object** soft key.
  4. Press the **cursor keys** to select a value between T1 and T16.
- **Selecting the Measurement Function**
  5. Press the **Function** soft key. The measurement function selection box appears.
  6. Press the **cursor keys** to select any of the measurement functions starting with U.
  7. Press **SET** to confirm.
- **Selecting the Element/Wiring Unit**
  8. Press the **Element/Σ** soft key to display the element/wiring unit selection box.
  9. Press the **cursor keys** to select any of the elements/wiring units starting with Element1.
  10. Press **SET** to confirm.

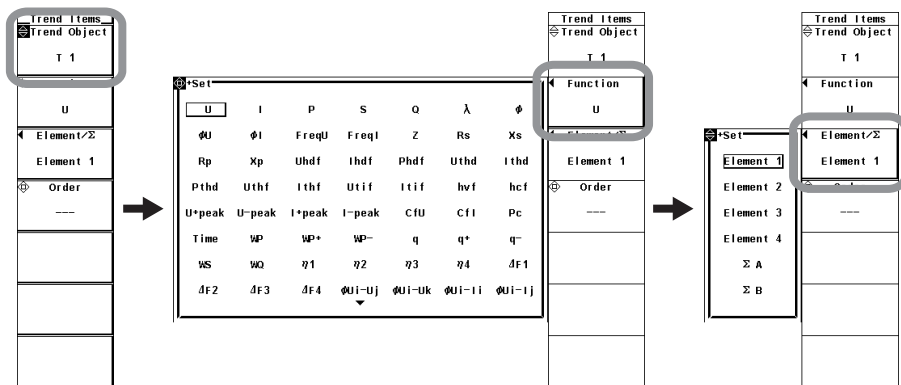

- **Selecting the Harmonic Order (Applicable Only on Models with the Advanced Computation Option or the Harmonic Measurement Option)**
  11. Press **Order** soft key.
  12. Press the **cursor keys** to select the order from --- (normal measured value) and 0 to the maximum measured order (see section 7.5 in the *Expansion Function User's Manual*).

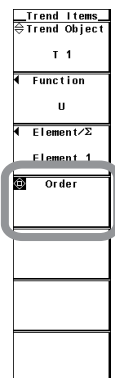

To check the trend display settings, use the setup parameter list function (see section 3.16).

**Explanation**

Set the item to be shown on the trend display. You can set 16 lines of trends, trend 1 (T1) through trend 16 (T16).

- **Selecting the Measurement Function**

- The measurement functions that can be selected are the items that are indicated in “Types of Measurement Functions during Normal Measurement” of section 2.2, “User-Defined Function” and Corrected Power of section 2.5, “Measurement Functions of Integration,” “Motor Evaluation Function (Motor Version),”<sup>\*1</sup> “Delta Computation (Option),”<sup>\*1</sup> and “Harmonic Measurement (Option)”<sup>\*1</sup> in section 2.6.

<sup>\*1</sup> For details, see the *Expansion Function User's Manual IM760301-51E*.

- **Selecting the Element/Wiring Unit**

- You can select the element/wiring unit from the choices below. The selectable items vary depending on the installed elements.

Element1, Element2, Element3, Element4,  
ΣA, and ΣB

- If there are no elements that are assigned to the selected wiring unit, there is no numeric data. Thus, the trend is not displayed. For example, if elements are assigned to ΣA and no elements are assigned to ΣB, then the trend of the measurement function for ΣB is not displayed.

- **Changing the Harmonic Order (Applicable Only on Models with the Harmonic Measurement Option)**

The measured order can be set to normal measured value (---) or from dc (0th order) up to 100th order.

---

**Note**

- For the meanings of the measurement function symbols that are displayed, see section 2.2, “Measurement Functions and Measurement Periods,” 2.5, “Computation,” 2.6, “Integration,” and appendix 1, “Symbols and Determination of Measurement Functions.”
  - For details on the wiring units expressed as ΣA and ΣB, see section 4.1, “Selecting the Wiring System.”
  - The trend is not displayed where the measurement function is not selected or where no numeric data is present.
  - The measured order can be set to normal measured value (---) or from dc (0th order) up to 100th order. However, the numeric data up to the upper limit of the measured order (see the *Expansion Function User's Manual IM760301-51E*) that is automatically determined from the minimum measured order (Min Order) to the PLL source frequency is the data determined by the harmonic measurement.
  - If the trend display target is changed, all past trend displays are cleared, and the trend display starts from the right end.
  - In wide bandwidth harmonic measurement mode on models with the advanced computation (/G6) option, the total value is displayed in place of the normal measured value (---) for the order setting. However, the trend of the total value cannot be displayed, because trends cannot be displayed in wide bandwidth harmonic measurement mode. If the mode is switched to normal measurement in this condition, the normal measured value (---) is displayed as the order.
-

## 7.4 Setting the Time Axis

### Procedure

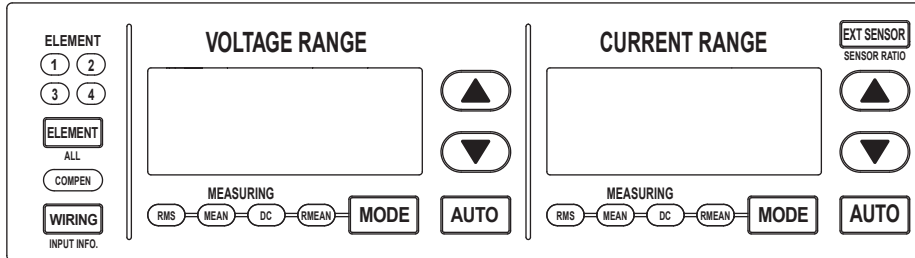

To exit the menu during operation, press **ESC** located above the soft keys.

In the procedural explanation below, the phrase “press the **cursor keys**” may be used. This phrase refers to the procedures for selecting items and entering values and character strings. For details on the procedures, see section 3.14.

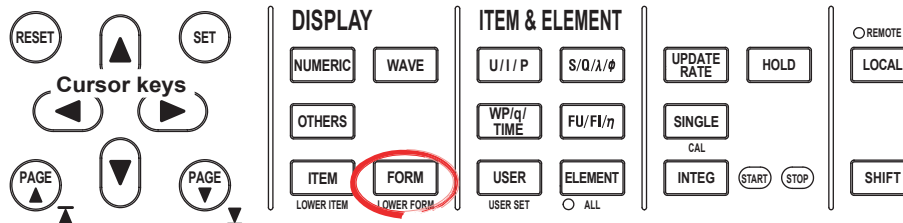

1. Press **FORM** to display the Trend Form menu.  
If the trend display is at the lower section of the screen on the split display, press **SHIFT+FORM (LOWER FORM)**.
2. Press the **cursor keys** to set the time axis. When the display of scale values is turned ON (see section 6.8), the times at the left end (fixed to 0 s) and the right end of the screen are displayed in the lower left corner and lower right corner of the screen, respectively.



**Explanation**

Set the time axis in terms of T/div (time per grid).

Set the time per division in the range of 3 s to 1 day.

The data update interval of the trend is determined by the data update rate and the time axis (T/div). For example, if the data update rate and T/div are set to 50 ms and 3 s/div, respectively, the trend display is updated every second. If the data update rate and T/div are set to 10 s and 3 s/div, respectively, the trend display is updated every 10 s and the trend data is shown as a line graph at 10-s intervals. If T/div is set to 1 day, the data update interval of the trend is 1728 s regardless of the data update rate setting.

**Note**

- If the time axis is changed, the retrieval of trend waveform data restarts. The trend display up to that point is cleared and the trend starts from the right end.
- One division on the trend display corresponds to 50 rasters. For example, if T/div is set to 1 day, 1 raster is equal to 1728 s (= 1 day/50). In this case, the data update interval of the trend is 1728 s, and the data is displayed P-P compressed. For a description of rasters and P-P compression, see section 2.7.

## 7.5 Setting the Scale

### Procedure

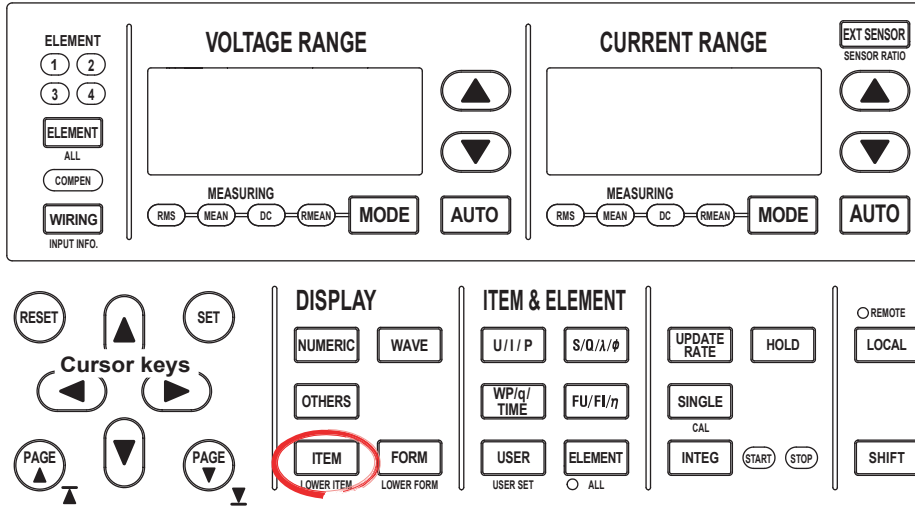

To exit the menu during operation, press **ESC** located above the soft keys.

In the procedural explanation below, the phrase “press the **cursor keys**” may be used. This phrase refers to the procedures for selecting items and entering values and character strings. For details on the procedures, see section 3.14.

1. Press **ITEM** to display the Trend Items menu.  
If the trend display is at the lower section of the screen on the split display, press **SHIFT+ITEM (LOWER ITEM)**.
2. Press the **Trend Scale** soft key to display the Trend Scale menu.

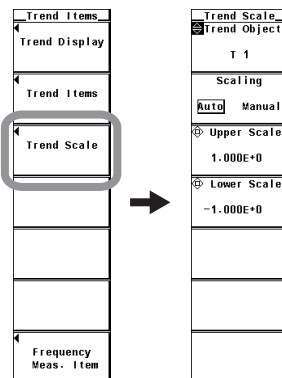



- **Selecting the Target Trend to Be Scaled**
  3. Press the **Trend Object** soft key.
  4. Press the **cursor keys** to select a value between T1 and T16.
- **Selecting Auto Scaling or Manual Scaling**
  5. Press the **Scaling** soft key to select Auto or Manual.
- **Setting the Upper Limit during Manual Scaling**
  6. Press the **Upper Scale** soft key.
  7. Press the **cursor keys** to set the upper limit.
- **Setting the Lower Limit during Manual Scaling**
  6. Press the **Lower Scale** soft key.
  7. Press the **cursor keys** to set the lower limit.

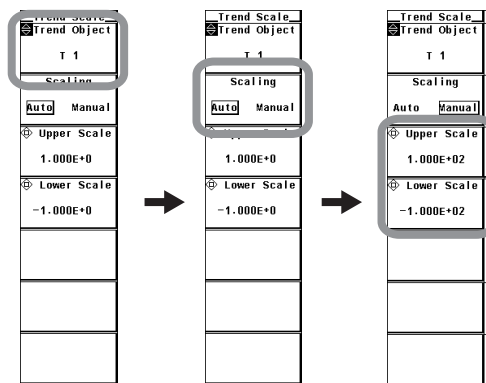

### Explanation

- **Setting the Scale**

Set the upper and lower limits of the display frame when displaying the trend. You can select the scaling mode from below.

  - **Auto**

Set to auto scaling. The upper and lower limits on the screen display are automatically determined from the maximum and minimum values of the trend display data.
  - **Manual**

Set to manual scaling. The upper and lower limits can be set arbitrary as necessary.
- **Setting the Upper and Lower Limits for Manual Scaling**

You can set the limits in the range of  $-9.999E+30$  to  $9.999E+30$ .

## 7.6 Displaying Trends on Divided Windows

### Procedure

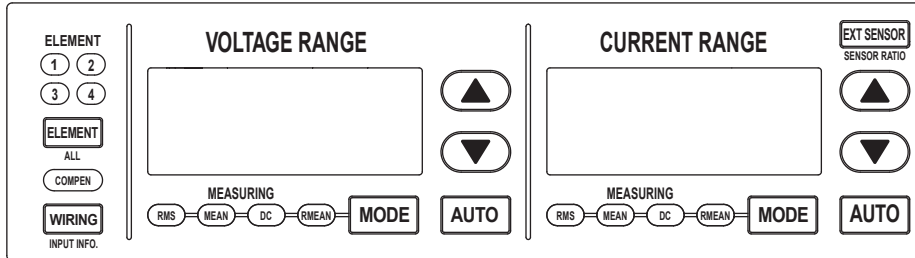

To exit the menu during operation, press **ESC** located above the soft keys.

In the procedural explanation below, the phrase “press the **cursor keys**” may be used. This phrase refers to the procedures for selecting items and entering values and character strings. For details on the procedures, see section 3.14.

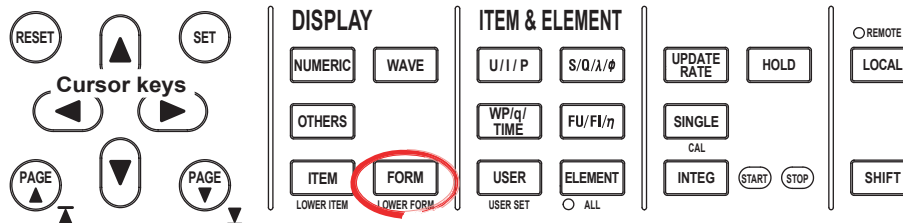

1. Press **FORM** to display the Trend Form menu.  
If the trend display is at the lower section of the screen on the split display, press **SHIFT+FORM (LOWER FORM)**.
2. Press the **Format** soft key to display the Format menu.
3. Press any of the keys from **Single** to **Quad** to select the number of windows.

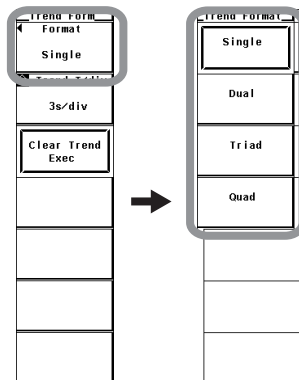

**Explanation**

The trends can be assigned to the divided windows.

- **Selecting the Number of Screen Divisions**

Select the number of divisions of the screen from the choices below. This is the same as with the waveform display (section 6.6).

- Single: No division
- Dual: 2 divisions
- Triad: 3 divisions
- Quad: 4 divisions

The number of displayed points in the vertical direction of one divided window varies depending on the number of divisions as follows:

Single: 432 points, Dual: 216 points, Triad: 144 points, Quad: 108 points

- **Waveform Mapping**

The trends that are turned ON (see section 7.2) are assigned in order according to the trend number (T1 to T16) to the divided windows. This corresponds to the “Auto” setting for the waveform display.

## 7.7 Selecting the Display Interpolation and Graticule and Turning ON/OFF the Scale Value and Waveform Label

### Procedure

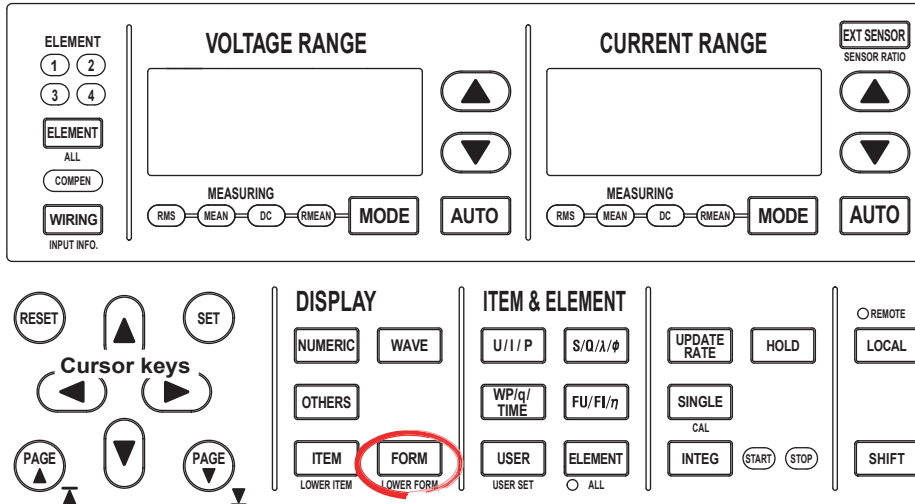

To exit the menu during operation, press **ESC** located above the soft keys.

In the procedural explanation below, the phrase “press the **cursor keys**” may be used. This phrase refers to the procedures for selecting items and entering values and character strings. For details on the procedures, see section 3.14.

1. Press **FORM** to display the Trend Form menu.  
If the trend display is at the lower section of the screen on the split display, press **SHIFT + FORM (LOWER FORM)**.
  2. Press the **Display Setting** soft key to display the Disp Setting menu.
- **Selecting Whether to Interpolate the Display**
    3. Same as the procedure given in “Selecting Whether to Interpolate the Display” in section 6.7.
  - **Changing the Graticule**
    3. Same as the procedure given in “Changing the Graticule” in section 6.7.
  - **Turning ON/OFF the Scale Value Display**
    3. Same as the procedure given in “Turning ON/OFF the Scale Value Display” in section 6.8.
  - **Turning ON/OFF the Waveform Label**
    3. Same as the procedure given in “Turning ON/OFF the Waveform Label” in section 6.8.

## 7.7 Selecting the Display Interpolation and Graticule and Turning ON/OFF the Scale Value and Waveform Label

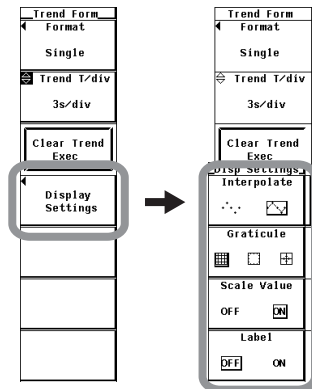

### Explanation

- **Selecting Whether to Interpolate the Display**  
Same as the explanation given in “Selecting Whether to Interpolate the Display” in section 6.7.
- **Changing the Graticule**  
Same as the explanation given in “Changing the Graticule” in section 6.7.
- **Turning ON/OFF the Scale Value Display**  
Same as the explanation given in “Turning ON/OFF the Scale Value Display” in section 6.8.
- **Turning ON/OFF the Label Display**  
Same as the explanation given in “Turning ON/OFF the Label Display” in section 6.8.

### Note

The settings in this section are common with the waveform display (see chapter 6). Changing these settings in the trend display also changes the waveform display settings. For example, if you turn the scale value display OFF in the trend display, the scale value display in the waveform display is also turned OFF.

## 7.8 Restarting the Trend

### Procedure

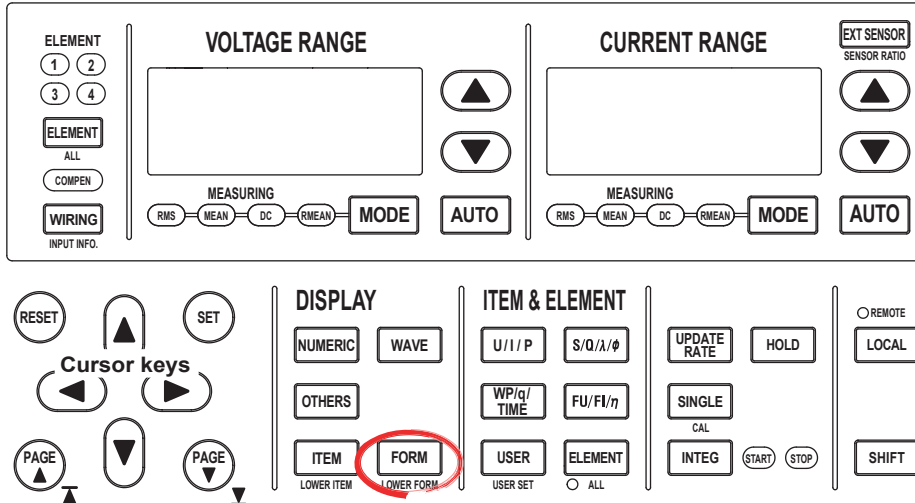

To exit the menu during operation, press **ESC** located above the soft keys.

In the procedural explanation below, the phrase “press the **cursor keys**” may be used. This phrase refers to the procedures for selecting items and entering values and character strings. For details on the procedures, see section 3.14.

1. Press **FORM** to display the Trend Form menu.  
If the trend display is at the lower section of the screen on the split display, press **SHIFT+FORM (LOWER FORM)**.
2. Press the **Clear Trend Exec** soft key to restart the trend.

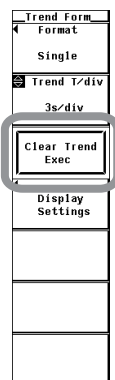

### Explanation

When the trend is restarted, the trend up to that point is cleared.

In addition to pressing the Clear Trend Exec soft key, the following operations cause the trend to be restarted.

- Changing the trend display target
- Changing the time axis (horizontal axis) setting of the trend.

# 7.9 Cursor Measurement

## Procedure

To exit the menu during operation, press **ESC** located above the soft keys.

In the procedural explanation below, the phrase “press the **cursor keys**” may be used. This phrase refers to the procedures for selecting items and entering values and character strings. For details on the procedures, see section 3.14.

1. Press **SHIFT+MEASURE (CURSOR)** to display the Cursor menu. For split display of Wave+Trend or Bar+Trend, proceed to step 3. For all other displays, proceed to step 3.
2. Press the **Trend Cursor Setting** soft key to display the Cursor menu for the trend display.

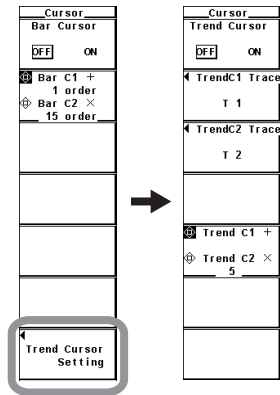

## 7.9 Cursor Measurement

- **Turning ON/OFF Cursor Measurement**

3. Press the **Trend Cursor** soft key to select ON or OFF.

If ON is selected, the result of the cursor measurement is displayed.

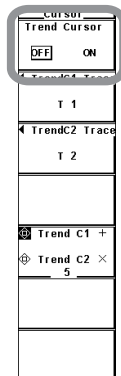

- **Selecting the Target Trend for Cursor Measurement**

- **Selecting the Target Trend for Cursor +**

4. Press the **TrendC1 Trace** soft key. A box used to select the target trend appears.
5. Press the **cursor keys** to select a value between T1 and T16.
6. Press **SET** to confirm the new target trend.

- **Selecting the Target Trend for Cursor x**

4. Press the **TrendC2 Trace** soft key. A box used to select the target trend appears.
5. Press the **cursor keys** to select a value between T1 and T16.
6. Press **SET** to confirm the new target trend.

- **Moving the Cursors**

7. Press the **Trend C1 +/Trend C2 x** soft key to set the cursor target to Trend C1 +, Trend C2 x, or both Trend C1 + and Trend C2 x.
  - If you select Trend C1 +, the position of cursor + can be moved.
  - If you select Trend C2 x, the position of cursor x can be moved.
  - If you select both Trend C1 + and Trend C2 x, the two cursors can be moved without changing the spacing between the two. The value of the digit being specified by Trend C1 + changes.
8. Press the **cursor keys** to move the cursor.

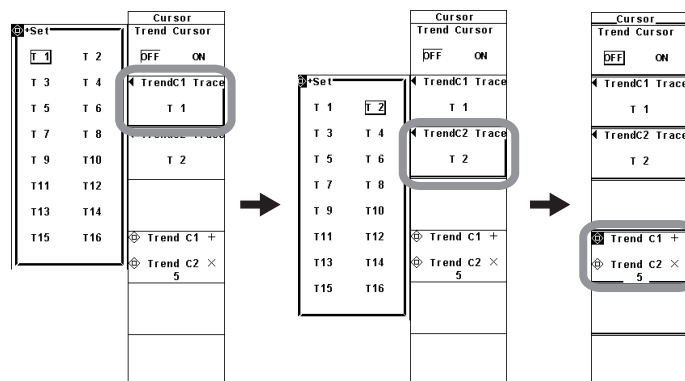



**Explanation**

- **ON/OFF**

A cursor can be placed on the displayed trend to measure and display the value at any point. It can be used to measure the data on the vertical axis (Y-axis) and horizontal axis (X-axis) of various sections of the trend.

- ON: Performs cursor measurement.
- OFF: Does not perform cursor measurement.

- **Item under Measurement**

Select the target trend for the cursor measurement from T1 to T16.

- **Moving the Cursor**

- Cursors move on the selected trend.
- Specify the number of points from the left end of the screen to move the cursor with the left and right ends of the screen assumed to be point 0 and 1001, respectively.
- The cursors moves along the data points displayed on the screen one point at a time.

- **Measurement Item**

- Y+: Vertical value of cursor + (Y-axis value)
- Yx: Vertical value of cursor x (Y-axis value)
- $\Delta Y$ : The difference between the Y-axis values of cursor + and cursor x
- X+: X-axis value of cursor + from the left end of the screen  
Indicates the relative time of cursor + from the left end of the screen with the left end of the screen taken to be 0 s.
- Xx: X-axis value of cursor x from the left end of the screen  
Indicates the relative time of cursor x from the left end of the screen with the left end taken to be 0 s.
- $\Delta X$ : The difference between the X-axis values of cursor + and cursor x
- D+: Date and time at the cursor + position  
Indicates the date and time (year/month/date hour:minute:second) of measurement.
- Dx: Date and time at the cursor x position  
Indicates the date and time (year/month/date hour:minute:second) of measurement.

---

**Note**

- if immeasurable data exists, \*\*\* is displayed in the measured value display area.
  - $\Delta Y$  is measured even if the unit is different. The result has no unit in this case.
-

# 8.1 Setting the Store Mode

**Procedure**

**Cursor keys**

RESET, SET, UP, DOWN, LEFT, RIGHT, PAGE UP, PAGE DOWN

**DISPLAY**

NUMERIC, WAVE, OTHERS, ITEM, FORM

**ITEM & ELEMENT**

U/I/P, S/O/A/#, WP/q/TIME, FU/Fl/η, USER, ELEMENT, USER SET, ALL

UPDATE RATE, HOLD, SINGLE, CAL, INTEG, START, STOP, SHIFT

REMOTE, LOCAL

SCALING, LINE FILTER, AVG, HRM SET, MEASURE, SYNC SOURCE, FILE, IMAGE SAVE, STORE, PRINT, MISC, HELP

To exit the menu during operation, press **ESC** located above the soft keys.

In the procedural explanation below, the phrase “press the **cursor keys**” may be used. This phrase refers to the procedures for selecting items and entering values and character strings. For details on the procedures, see section 3.14.

To set or execute the storage operation, set the measurement mode to normal measurement mode or wide bandwidth harmonic measurement mode.\* There are limitations on the setting and execution of the storage operation in measurement modes other than normal measurement mode.

\* Can be set on models with the advanced computation (/G6) option.

1. Press **SHIFT+STORE (STORE SET)** to display the Store Set menu.
2. Press the **Mode** soft key to select **Store**.
3. Press the **Store Setting** soft key to display the Store Setting menu.
4. Press the **Mode** soft key to display the Mode menu.
5. Press any soft key from **Manual** to **Integ Sync** to select the store mode.

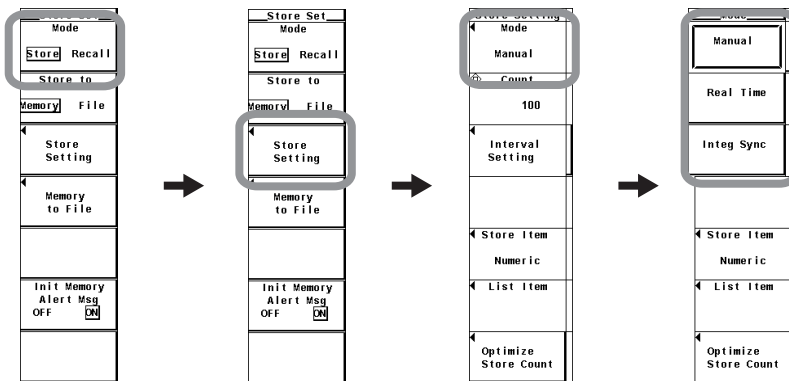

### Explanation

To store data, parameters such as the store mode, the store count, the store interval, and the store reservation time must be specified before executing the operation. This section explains the store mode. For the procedure on how to set the store count, the store interval, and the store reservation time, see section 8.2; for the procedure on how to start the storage operation, see section 8.4.

#### Limitations on the Storage Function by Measurement Modes

There are limitations on the setting and execution of the storage operation in measurement modes other than normal measurement mode.

- **Normal Measurement Mode**

There are no limitations on the storage function.

- **Wide Bandwidth Harmonic Measurement Mode\***

The store mode cannot be set to integration synchronization mode (Integ Sync), because the integration function is not available. If you switch from normal measurement mode to wide bandwidth harmonic measurement mode with the store mode set to integration synchronization mode, the store mode is set to manual.

If Store Item is set to Wave, "NAN" is stored for the waveform data. This is because the waveform display function is not available.

- **Measurement Modes in Which the Storage Function Cannot Be Used**

- IEC harmonic measurement mode
- Waveform computation mode
- FFT mode
- Voltage fluctuation and flicker measurement mode
- Cycle-by-cycle measurement mode

#### Store Mode

You can select the timing used to start or end the storage operation from the choices below.

- **Manual**

This is the manual mode. When you press STORE, the numeric data or waveform display data can be stored at the specified store interval for the specified store counts.

- **Real Time**

This is the real-time mode. When you press STORE, the numeric data or waveform display data can be stored from the specified reservation time for starting the storage operation at the specified store interval for the specified store counts (or until the reservation time for ending the storage operation).

- **Integ Sync**

- This is the integration synchronization mode. When you press STORE, the numeric data or waveform display data can be stored when the integration starts at the specified store interval for the specified store counts (or until the integration is stopped).
- By setting the time of the integration timer (see section 5.11 or 5.12) to an integer multiple of the store interval, the integrated values at integration start and integration stop that are repeated according to the time setting of the integration timer can be stored.

## 8.2 Setting the Numeric Data and Waveform Display Data to Be Stored

### Procedure

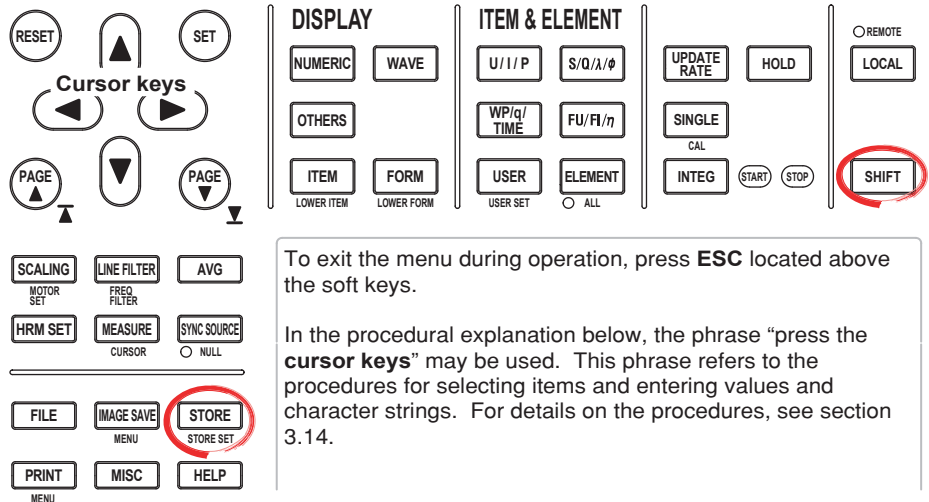

1. Press **SHIFT+STORE(STORE SET)** to display the Store Set menu.
  2. Press the **Mode** soft key to select Store.
  3. Press the **Store Setting** soft key to display the Store Setting menu.
- **Selecting the Item to Be Stored**
    4. Press the **Store Item** soft key to display the Store Item menu.
    5. Press any soft key from **Numeric to Numeric+Wave** to select the stored item.
      - If you select Numeric, the stored item is the numeric data. Proceed to “Selecting the Numeric Data to Be Stored” on the next page.
      - If you select Wave, the stored item is the waveform display data. Proceed to “Selecting the Waveform Data to Be Stored” on page 8-5.
      - If you select Numeric+Wave, the stored item is both the numeric data and the waveform display data. Proceed to “Selecting the Numeric Data and Waveform Data to Be Stored” on page 8-5.

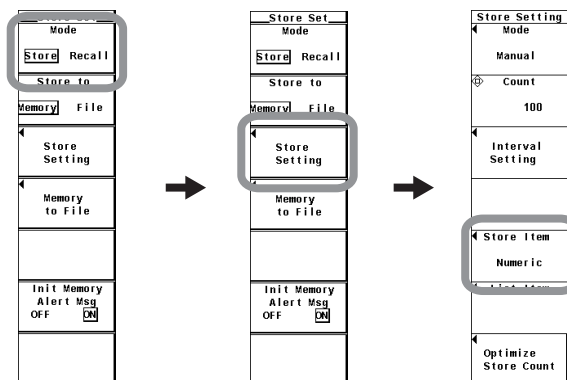

## 8.2 Setting the Numeric Data and Waveform Display Data to Be Stored

- **Selecting the Numeric Data to Be Stored**  
(This operation is valid if the stored item was set to Numeric or Numeric+Wave in step 5.)  
6. Press the **List Item** soft key to display the List Item dialog box.

- **Selecting the Items at Once**  
7. Press the **cursor keys** to select All ON.  
8. Press **SET**. The buttons to the left of all the elements and measurement functions are highlighted indicating that all items will be stored.

- **Deselecting All the Items at Once**  
7. Press the **cursor keys** to select All OFF.  
8. Press **SET**. The highlighting of the buttons to the left of all the elements and measurement functions are cleared indicating that all items will not be stored.

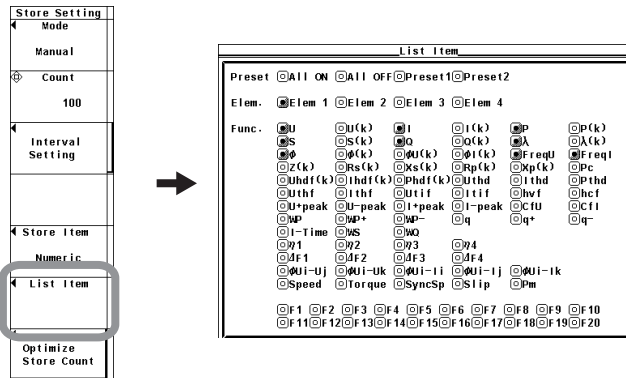

- **Selecting Only the Items That Are Preset**  
7. Press the **cursor keys** to select Preset1 or Preset2.  
8. Press **SET**. The buttons to the left of all the elements and measurement functions that are specified in Preset1 or Preset2 are highlighted indicating that the items will be stored.

Items set to Preset1

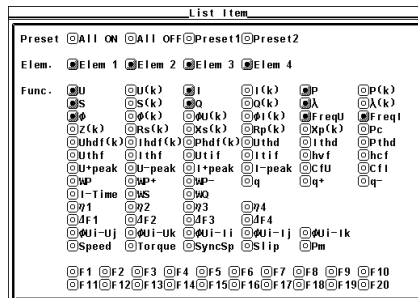

Items set to Preset2

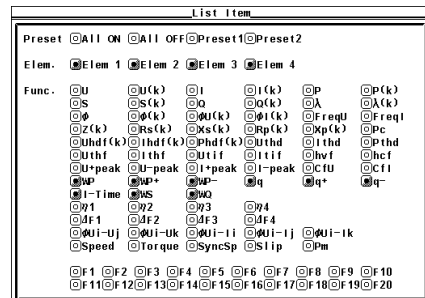

- **Setting the Items One at a Time**  
7. Press the **cursor keys** to select the element or measurement function that you wish to specify.  
8. Press **SET**. When the button to the left of the selected element or measurement function is highlighted, the numeric data of the measurement function of the element will be stored. When the highlighting of the button is cleared, the numeric data of the measurement function of the element will not be stored.

- **Selecting the Waveform Display Data to Be Stored**

(This operation is valid if the stored item was set to Wave or Numeric+Wave in step 5.)

6. Press the **Wave Trace** soft key to display the Wave Trace dialog box.

- **Selecting the Items at Once**

7. Press the **cursor keys** to select All ON.

8. Press **SET**. The buttons to the left of all the signals are highlighted indicating that all items will be stored.

- **Deselecting All the Items at Once**

7. Press the **cursor keys** to select All OFF.

8. Press **SET**. The highlighting of the buttons to the left of all the signals are cleared indicating that all items will not be stored.

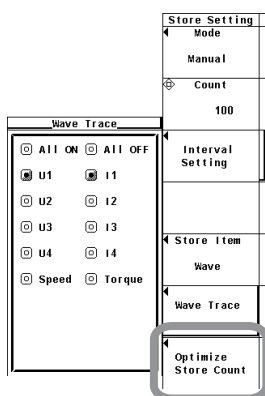

- **Setting the Items One at a Time**

7. Press the **cursor keys** to select the input signal you wish to set.

8. Press **SET**. When the button to the left of the selected input signal is highlighted, the input signal will be stored. If the highlighting of the button is cleared, the input signal will not be stored.

- **Selecting the Numeric Data and Waveform Data to Be Stored**

(This operation is valid if the stored item was set to Numeric+Wave in step 5.)

6. Press the **List Item & Wave Trace** soft key to display the List Item & Wave Trace dialog box.

7. Select the numeric data to be stored according to steps 7 and 8 in “Selecting the Numeric Data to Be Stored” on page 8-4.

8. Select the waveform data to be stored according to steps 7 and 8 in “Setting the Items One at a Time” under “Selecting the Waveform Data to Be Stored” described above.

## 8.2 Setting the Numeric Data and Waveform Display Data to Be Stored

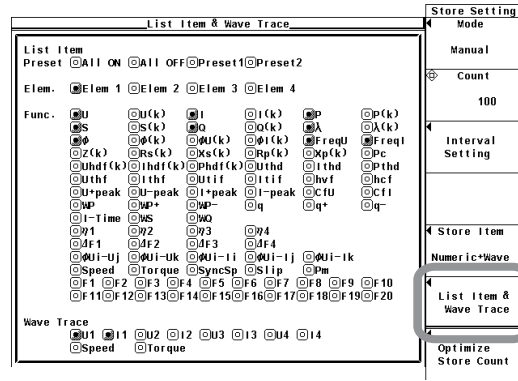

### Explanation

- **Selecting the Items to Be Stored**

Select the item to be stored from the following:

- **Numeric**  
Numerical data are stored.
- **Wave**  
Waveform display data are stored.
- **Numeric+Wave**  
Numeric data and waveform display data are stored.

- **Selecting the Numeric Data to Be Stored**

Select the items for storing the numeric data.

- Installed elements and wiring units are applicable for the selection.
- The items to be stored can be selected from the items that are indicated in “Measurement Function Types during Normal Measurement” (see section 2.2), “Measurement Function Types for Motor Evaluation Function (Motor Version)” (see the *Expansion Function User’s Manual IM760301-51E*), and “Measurement Function Types for Harmonic Measurement (Option)” (see the *Expansion Function User’s Manual IM760301-51E*).

- **Selecting the Waveform Display Data to Be Stored**

- Select the items for storing the waveform display data.
- Only the input signals of the installed elements are applicable for the selection.
- For models with the motor evaluation function (motor version), the input signals of Speed and Torque are also selectable items.

### Note

- There are limitations on the setting and execution of the storage operation in measurement modes other than normal measurement mode. For details, see section 8.1.
- For the meanings of the measurement function symbols that are displayed, see section 2.2, “Measurement Functions and Measurement Periods,” 2.5, “Computation,” 2.6, “Integration,” appendix 1, “Symbols and Determination of Measurement Functions,” and *Expansion Function User’s Manual IM760301-51E*
- For details on the wiring units expressed as  $\Sigma A$  and  $\Sigma B$ , see section 4.1, “Selecting the Wiring System.”
- [-----] (no data) is stored in places where there is no numeric data.
- If there are no integrated values because integration is not performed, [-----] (no data) is stored. [-----] (no data) is also stored in places where there is no integration time.
- The maximum order for which the harmonic data is saved is the maximum harmonic order to be measured that is specified in the harmonic measurement (option) menu. [-----] (no data) is stored for harmonic orders without data.
- To store waveform display data, set the display mode to Wave, Numeric+Wave, Wave+Bar, or Wave+Trend and display the waveform on the screen. If the display mode is not set to one of these modes, “NAN” is stored for the waveform data.

## 8.3 Setting the Store Count, Store Interval, Store Reservation Time, and Alert Indication of Internal Memory Initialization

### Procedure

To exit the menu during operation, press **ESC** located above the soft keys.

In the procedural explanation below, the phrase “press the **cursor keys**” may be used. This phrase refers to the procedures for selecting items and entering values and character strings. For details on the procedures, see section 3.14.

1. Press **SHIFT+STORE(STORE SET)** to display the Store Set menu.
2. Press the **Mode** soft key to select Store.
3. Press the **Store Setting** soft key to display the Store Setting menu.

#### • Setting the Store Count

4. Press the **cursor keys** to set the store count.

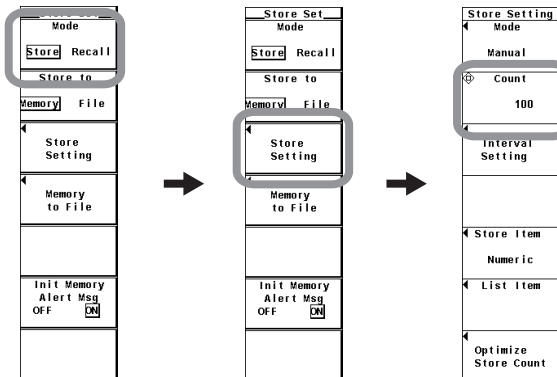



### 8.3 Setting the Store Count, Store Interval, Store Reservation Time, and Alert Indication of Internal Memory Initialization

- **Checking the Maximum Store Count and Optimizing the Store Count**
  5. Press the **Optimize Store Count** soft key. The Optimize Store Count dialog box appears, and the maximum store count is displayed.

If the store count specified in step 4 is greater than the maximum store count, proceed to step 6. Otherwise, proceed to step 12.
  6. Press the **cursor keys** to select Maximum Store Count.
  7. Press **SET** to display the entry box.
  8. Press the **cursor keys** to set the store count to a value less than or equal to the maximum store count.
  9. Press **SET** or **ESC** to close the box.
  10. Press the **cursor keys** to select SET.
  11. Press **SET**.
  12. Press **ESC** to close the entry box.

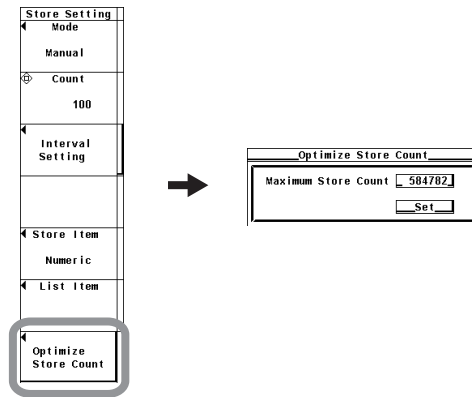

- **Setting the Store Interval**
  4. Press the **Interval Setting** soft key to display the Interval Setting dialog box.
  5. Press the **cursor keys** to select the hour, minute, or second box.
  6. Press **SET** to display the entry box.
  7. Press the **cursor keys** to set the hour, minute, or second that you selected in step 5.

For the procedures on how to enter values using the cursor keys, see section 3.14, "Entering Values and Strings."
  8. Press **SET** or **ESC** to close the box.
  9. Repeat steps 5 to 8 to set the hour, minute, and second.

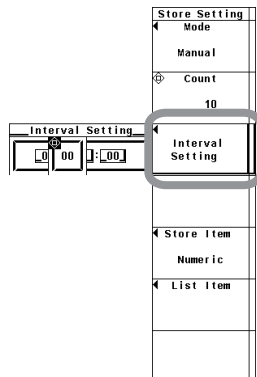

### 8.3 Setting the Store Count, Store Interval, Store Reservation Time, and Alert Indication of Internal Memory Initialization

- **Setting the Store Reservation Time**

(This operation is possible when the store mode is set to Real Time in section 8.1)

4. Press the **Mode** soft key to display the Mode menu.
5. Press the **Real Time** soft key to select the real-time mode. The store reservation time menu appears.
6. Press the **Real Time Control** soft key to display the Real Time Control dialog box.
7. Press the **cursor keys** to select one of the reservation year, month, date, hour, minute, and second boxes for specifying when the storage operation will start (Store Start).
8. Press **SET** to display the entry box.
9. Press the **cursor keys** to set the year, month, date, hour, minute, or second that you selected in step 7.
10. Press **SET** or **ESC** to close the box.
11. Repeat steps 7 to 10 to set the year, month, date, hour, minute, and second.
12. Press the **cursor keys** to select one of the reservation year, month, date, hour, minute, and second boxes for specifying when the storage operation will end (Store End).
13. Repeat steps 8 to 11 to set the year, month, date, hour, minute, and second.

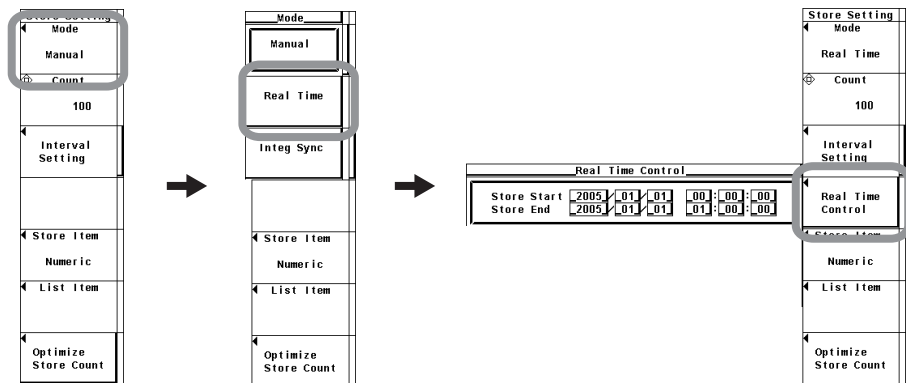

- **Turning ON/OFF the Alert Indication for Internal Memory Initialization**

1. Press **SHIFT+STORE(STORE SET)** to display the Store Set menu.
2. Press the **Init Memory Alert Msg** soft key to select ON or OFF.

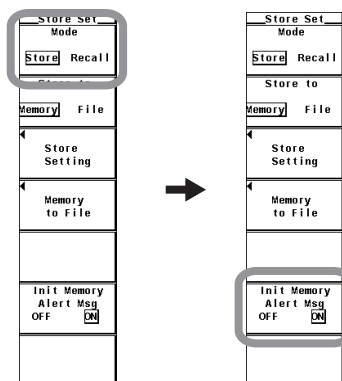

#### Explanation

To store data, parameters such as the store mode, the store count, the store interval, and the store reservation time must be specified before executing the operation. This section explains the store count, the store interval, and the store reservation time. For the procedure on how to set the store mode, see section 8.1; for the procedure on how to start the storage operation, see section 8.4.

- **Setting the Store Count**

- Set the value in the range of 1 to 999999.
- If the data being stored exceeds the internal memory size (approx. 30 MB) of the store destination, the storage operation stops before reaching the specified store count.

- **Checking the Maximum Store Count and Optimizing the Store Count**

From the numeric data and waveform display data that are to be stored as specified in section 8.2, the maximum count that can be stored in the internal memory is calculated and displayed. If you change the maximum store count that is displayed, the actual store count is also changed to that value.

- You can change the store count in the range of 1 to the maximum store count that is calculated.

- **Setting the Store Interval**

Set the interval at which the data is to be stored.

- The time in units of hour:minute:second can be set in the following range. If the interval is set to 00:00:00, the data is stored in sync with the updating of the numeric data or waveform display data.  
00:00:00 to 99:59:59
- By setting the time of the integration timer (see section 5.11 or 5.12) to an integer multiple of the store interval, the integrated values at integration start and integration stop that are repeated according to the time setting of the integration timer can be stored.

- **Setting the Store Reservation Time**

- The reservation time is set in units of year:month:date, hour:minute:second.
  - Set the year, month and day.
  - Set the hour:minute:second in the following range.  
00:00:00 to 23:59:59

- **Make sure the reservation time for stopping the storage operation is after the reservation time for starting the storage operation.**

- **Turning ON/OFF the Alert Indication for Internal Memory Initialization**

You can select whether to display a message when the internal memory is about to be initialized.

- ON: Displays the alert message.
- OFF: Initializes the memory without displaying the alert message.

#### Note

- The reservation time allows up to 31 days to be specified for February. If an erroneous date is specified, an error message is displayed at the time of execution of the storage operation (section 8.4). Reset the reservation time in this case.
  - Leap years are recognized at the time of execution of the storage operation.
-

## 8.4 Storing Data

### Procedure

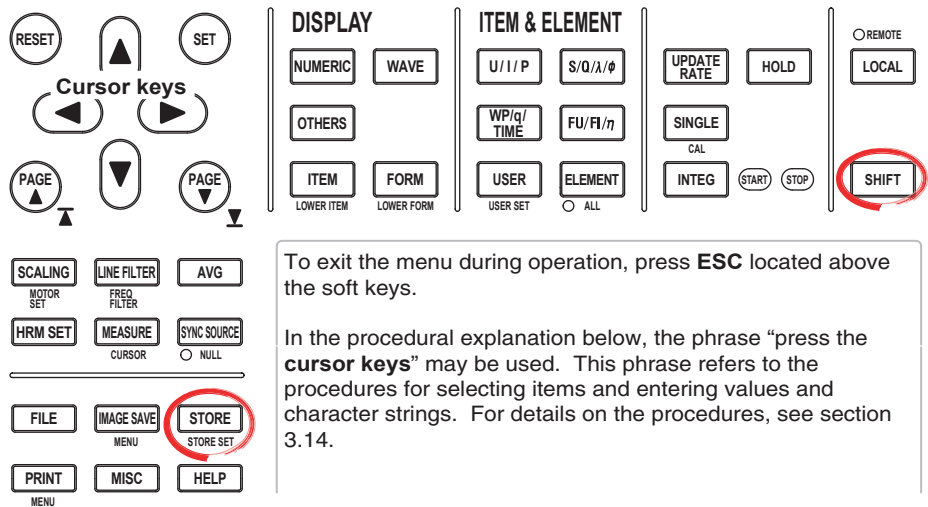

If you are storing data for the first time after turning the power switch ON, start from step 1. If you stored the data before and the data is stored in the internal memory, proceed to step 6 to clear the internal memory.

To set or execute the storage operation, set the measurement mode to normal measurement mode or wide bandwidth harmonic measurement mode.\*1 There are limitations on the setting and execution of the storage operation in measurement modes other than normal measurement mode.

To store waveform display data, set the display mode to Wave, Numeric+Wave, Wave+Trend, or Wave+Bar\*2 and display the waveform on the screen. For the setup procedure, see section 6.1.

\*1 Displayed only to products with the advanced computation (/G6) option.

\*2 Displayed only on models with the advanced computation (/G6) or harmonic measurement (/G5) option.

#### • Starting the Storage Operation

1. Press **SHIFT+STORE(STORE SET)** to display the Store Set menu.
2. Press the **Mode** soft key to select Store.
3. Press the **Store to** soft key to select Memory.
4. Press **STORE**. The storage operation starts according to the following conditions depending on the store mode (see section 8.1).
  - During manual mode
 

Starts the storage operation. When STORE is pressed, the first storage operation is executed. The STORE key illuminates, and “Store:Start” is displayed in the upper left corner of the screen.
  - During real-time mode
 

The WT3000 enters store ready state. The STORE key blinks, and “Store:Ready” is displayed in the upper left corner of the screen. When the reservation time for starting the storage operation is reached, the first storage operation starts. The STORE key illuminates, and “Store:Start” is displayed in the upper left corner of the screen.
  - During integration synchronization mode
 

The WT3000 enters store ready state. The STORE key blinks, and “Store:Ready” is displayed in the upper left corner of the screen. When integration starts, the first storage operation starts. The STORE key illuminates, and “Store:Start” is displayed in the upper left corner of the screen.

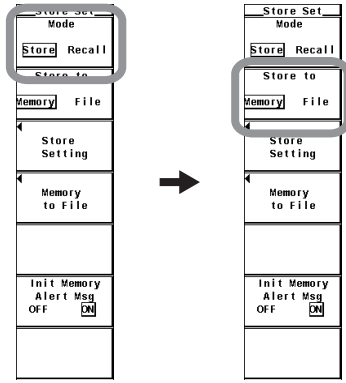

- **Stopping the Storage Operation**

5. If the storage operation is in progress, pressing **STORE** again stops the operation. The STORE key turns OFF.

- **Automatically Stopping the Storage Operation**

5. The storage operation stops automatically according to the following conditions depending on the store mode. The STORE key turns OFF.

- During manual mode

The storage operation stops when the specified store count of data is stored or when the data is stored up to the internal memory size (approx. 30 MB). "Store:Stop" is displayed in the upper left corner of the screen.

- During real-time mode

The storage operation stops when the specified store count of data is stored, when the reservation time for stopping the storage operation is reached, or when the data is stored up to the internal memory size. "Store:Stop" is displayed in the upper left corner of the screen.

- During integration synchronization mode

The storage operation stops when the specified store count of data is stored, when integration stops, or when the data is stored up to the internal memory size. "Store:Stop" is displayed in the upper left corner of the screen.

- **Initializing (Clearing) the Internal Memory**

The procedure to clear the internal memory varies depending on the store mode. This section describes the procedures when the store mode is store. For the procedures when the store mode is recall, see section 8.6.

6. While the storage operation is stopped, press **STORE** again.

If the alert indication for internal memory initialization (section 8.3) is ON, the Alert dialog box appears. Proceed to step 7. If the indication is OFF, the data in the internal memory is cleared without displaying the Alert dialog box.

7. Press the **cursor keys** to select OK or Cancel.

8. Select OK and press **SET** to clear the data in the internal memory. Select Cancel and press **SET** to not clear the data in the internal memory.

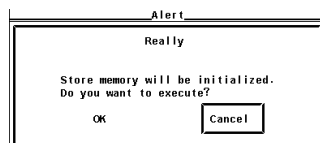

**Explanation**

To store data, parameters such as the store mode, the store count, the store interval, and the store reservation time must be specified before executing the operation. This section explains the start and stop operations of storage. For the procedure on how to set the store mode, see section 8.1; for the procedure on how to set the store count, the store interval, and the store reservation time, see section 8.2.

- **Display Related to Storage**

When the storage operation is in the start or stop state, the storage state and store count are displayed at the upper left of the screen.

```
Storage state  Store count
      |         |
Store:Stop    100
```

- **Starting the Storage Operation**

- The storage operation starts according to various conditions depending on the store mode (see section 8.1). For details, see the procedural explanation.
- The storage operation can be executed only when the internal memory is cleared.
- If you are performing the first storage operation after turning ON the power switch, there is no need to clear the internal memory.

- **Stopping the Storage Operation**

- The storage operation can be forcibly stopped using the STORE key.
- The storage operation stops automatically according to various conditions depending on the store mode. For details, see the procedural explanation.

- **Initializing (Clearing) the Internal Memory**

To start the storage operation again after stopping the operation, the internal memory must be cleared.

- **Retaining the Stored Data**

The data stored to the internal memory cannot be retained by the internal lithium battery. The data in the internal memory is lost when the power to the WT3000 is turned OFF. To retain the data, save the data to the storage medium before turning off the power.

---

**Note**

- [-----] (no data) is stored in places where there is no numeric data.
  - If there are no integrated values because integration is not performed, [-----] (no data) is stored. [-----] (no data) is also stored in places where there is no integration time.
  - The maximum order for which the harmonic data is saved is the maximum harmonic order to be measured that is specified in the harmonic measurement (option) menu. [-----] (no data) is stored for harmonic orders without data.
  - To store waveform display data, set the display mode to Wave, Numeric+Wave, Wave+Bar, or Wave+Trend and display the waveform on the screen. If the display mode is not set to one of these modes, "NAN" is stored for the waveform data.
  - While the storage operation is in progress, you cannot change the PLL source, the equation for distortion, scaling, averaging, filter, integration mode, integration timer, or the store interval. In addition, you cannot change the auto print settings or execute auto print.
  - If you hold the display by pressing HOLD while the storage operation is in progress, the value that is present when HOLD is pressed is stored.
  - If the store interval is 00:00:00 and you hold the display by pressing HOLD, the storage operation stops.
-

## 8.5 Saving the Stored Data

### CAUTION

Do not remove the PC card or USB memory or turn OFF the power when the access indicator or icon of the PC card or USB memory is blinking. This can damage the PC card or USB memory or destroy the data on it.

### Procedure

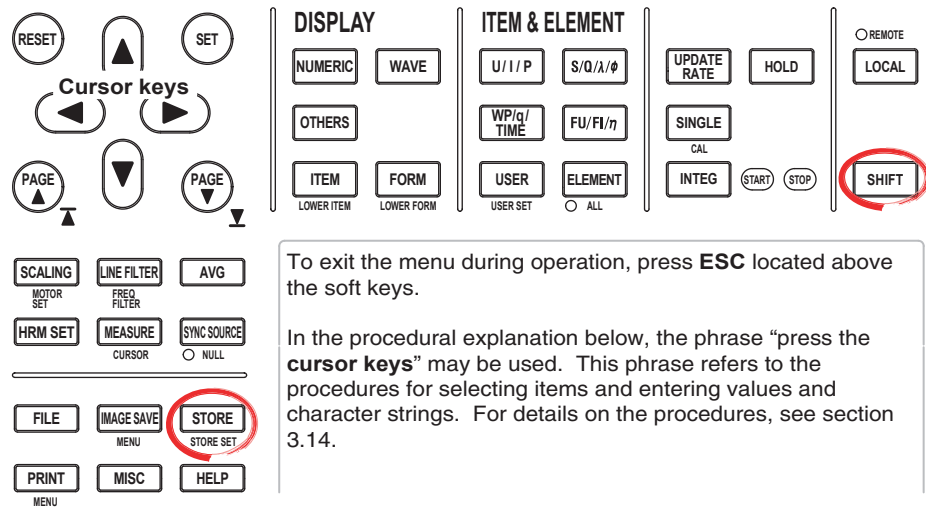

1. Press **SHIFT+STORE(STORE SET)** to display the Store Set menu.
2. Press the **Mode** soft key to select Store.
3. Press the **Store to** soft key to select Memory or File.

If you selected Memory, proceed to “When Saving Data That Has Already Been Stored” on the next page.

If you selected File, proceed to “When Saving Data through a Store-and-Save Operation Sequence” on page 8-16.

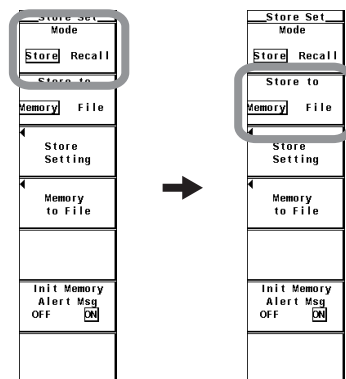

### When Saving Data That Has Already Been Stored

4. Press the **Memory to File** soft key to display the Memory to File dialog box.
- **Selecting the Data Type for Saving the Data**
  5. Press the **Data Type** soft key to select ASCII or Float.
- **Selecting the Storage Medium**
  6. Press the **File List** soft key to display the File List dialog box.
  7. Press the **cursor keys** to select the storage medium (indicated by [ ]).
  8. Press **SET** to confirm the storage medium.
- **Selecting the Save Destination Directory**

(Perform this operation when directories are present on the medium.)

  9. Press the **cursor keys** to select the save destination directory (indicated by < >).
  10. Press **SET** to confirm the directory.
    - The selected storage medium/directory is displayed in "Path=....." located above and to the left of the File List dialog box.
    - Select <.. > and press SET to return to a higher level directory.

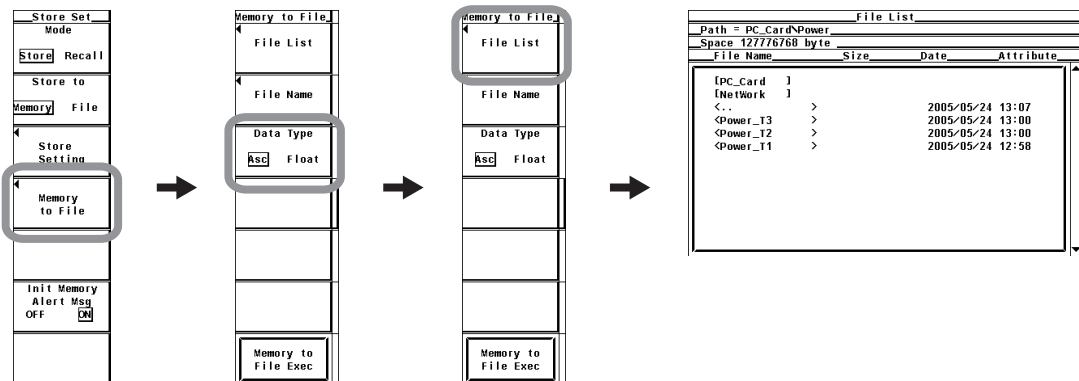

- **Setting the File Name and Comment**
  11. Press the **File Name** soft key to display the Save dialog box.
  12. Press the **cursor keys** to select Auto Naming.
  13. Press **SET** to select ON or OFF.
  14. Press the **cursor keys** to select File Name.
  15. Press **SET** to display the keyboard.
  16. Use the **keyboard** to set the file name.

For keyboard operations, see section 3.14, "Entering Values and Strings."
  17. Enter the **Comment** in a similar fashion.
  18. Press **ESC** to close the Save dialog box.

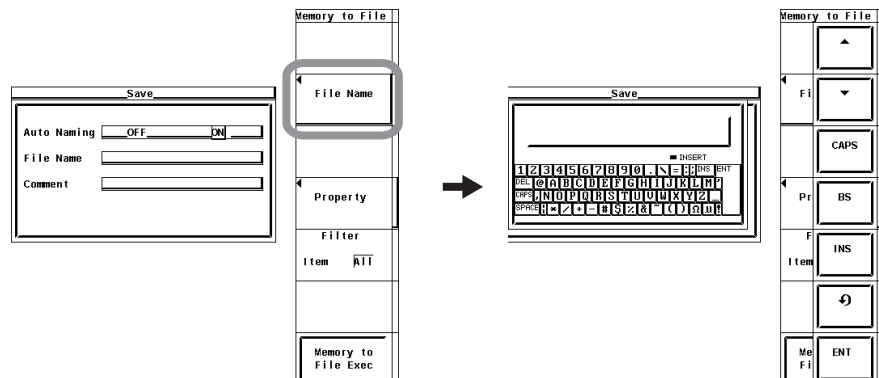



## 8.5 Saving the Stored Data

- **Executing the Save Operation**

19. Press the **Memory to File Exec** soft key. The stored data is saved to the directory indicated by Path=..... At the same time, the Memory to File Exec soft key changes to an Abort soft key.

- **Aborting the Save Operation**

20. Press the **Abort** soft key to abort the save operation. At the same time, the Abort soft key changes to a Memory to File Exec soft key.

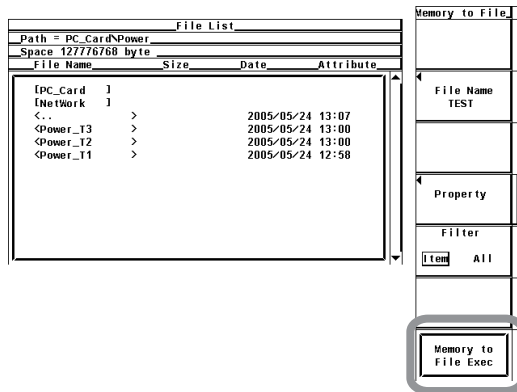

- **Specifying the File to Be Displayed in the File List Dialog Box**

11. Press the **Filter** soft key to select Item or **All**.

- **Viewing the Properties**

11. On the File List dialog box, press the **cursor keys** to select the file.
12. Press the **Property** soft key to display the file property window.
13. Press **ESC** to close the file property window.

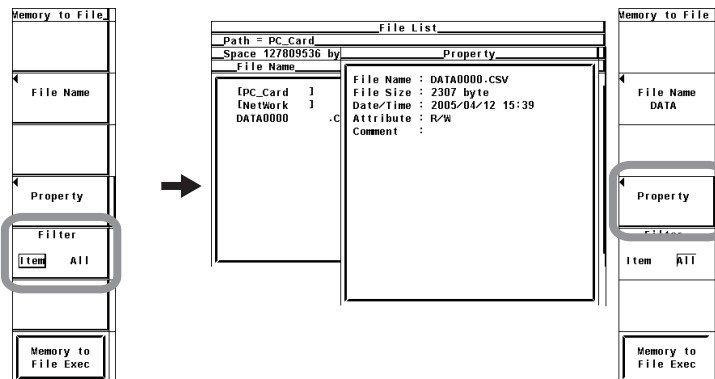

## When Saving Data through a Store-and-Save Operation Sequence

4. Press the **File setting** soft key to display the File setting menu.
  - **Selecting the Data Type for Saving the Data**
    5. The procedure is the same as step 5 under “Selecting the Data Type for Saving the Data” on page 8-15.
  - **Selecting the Storage Medium**
    6. The procedure is the same as steps 6 to 8 under “Selecting the Storage Medium” on page 8-15.
  - **Selecting the Save Destination Directory**
    7. The procedure is the same as steps 9 and 10 under “Selecting the Save Destination Directory” on page 8-15.
  - **Setting the File Name and Comment**
    8. The procedure is the same as steps 11 to 18 under “Setting the File Name and Comment” on page 8-15.
  - **Starting the Storage Operation**
    9. Press **STORE**. The storage operation starts (see section 8.4) according to various conditions depending on the store mode (see section 8.1).
  - **Stopping the Store Operation and Saving the Data**
    10. If the storage operation is in progress, pressing **STORE** again stops the operation. Then, the stored data is saved to the directory indicated by Path=.....
  - **Automatically Stopping the Store Operation and Saving the Data**
    11. The storage operation stops (see section 8.4) automatically according to various conditions depending on the store mode. Then, the stored data is saved to the directory indicated by Path=.....
  - **Specifying the File to Be Displayed in the File List Dialog Box**

The procedure is the same as step 11 under “Specifying the File to Be Displayed in the File List Dialog Box” on page 8-16.
  - **Viewing the Properties**

The procedure is the same as steps 11 to 13 under “Viewing Properties” on page 8-16.

### Note

- If the storage medium at the save destination does not exist when saving the stored data, an error message is displayed and the save operation is aborted. Since the data is stored in the internal memory in this case, you can save the data stored to the memory by selecting “Memory” according to step 3 on page 8-13 and then carrying out the steps on pages 8-14 and 8-15.
- Because file operation cannot be carried out when integration is in progress, do not execute the store and save operation sequence in integration synchronization mode. Saving of stored data is also not possible when integration is in progress.

## 8.5 Saving the Stored Data

### Explanation

- **Selecting the Data Type**

Select the data type from below. The extension is automatically added.

- ASCII
  - Numerical data or waveform display data is saved in ASCII format.
  - The file can be used on your PC for analysis.
  - The file cannot be loaded into the WT3000.
- Float
  - Numeric data or waveform display data is saved in 32-bit floating format.
  - The file cannot be loaded into the WT3000.

- **Extension and Data Size of the Numeric Data**

Data Type	Extension	Data Size (Bytes)
ASCII	.CSV	Approx. 5 K (condition: number of elements 1, store item Preset1, store count 10)
Float	.WTD	When integration is not performed Approx. (8 K + (4×D <sub>n</sub> + 16×number of storage operations)) When integration is performed Approx. (4K + (8×D <sub>n</sub> + 16 + 16×T <sub>i</sub> )×number of storage operations) D <sub>n</sub> : Number of numerical data to be stored (Number of measurement functions×(number of elements + number of wiring units)) T <sub>i</sub> : Number of integration time to be stored

- **Extension and Data Size of the Waveform Display Data File**

Data Type	Extension	Data Size (Bytes)
ASCII	.CSV	Approx. 115 K (condition: when there is one waveform to be stored, store count 10)
Float	.WTD	Approx. (4K + (8×1002×T <sub>w</sub> + 16)×number of storage operations) T <sub>w</sub> is the number of waveforms to be stored

- **Selecting the Medium and Directory**

The save destination medium and directory are displayed in the File List dialog box.

#### Currently selected medium and directory

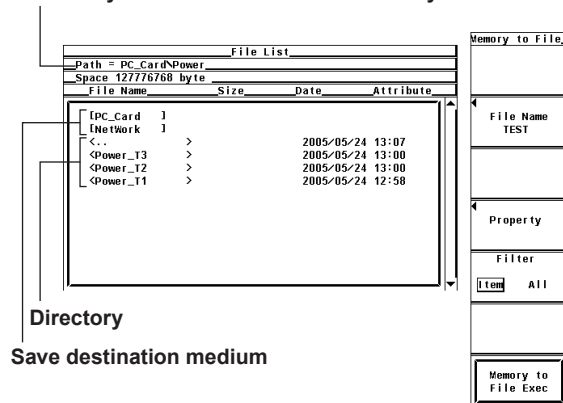

#### Display Example of Storage Media

[PC\_Card]: PC card

[USB2]: USB memory (option) with ID number 2

[NetWork]: Network drive (option. see *Expansion Function User's Manual IM760301-51E*)

- **File Name and Comment**

- A file name must be assigned. Comments are optional.
- You cannot save data to a file name that already exists in the same directory (overwriting not allowed).

**Number and Types of Characters That Can Be Used**

Item	Number of Characters	Characters That Can Be Used
File name	1 to 8 characters	0-9, A-Z, %, _, ( ) (parentheses), - (minus sign)
Comment	0 to 25 characters	Characters that are displayed on the keyboard and spaces

- **Auto Naming Function**

When Auto Naming is turned ON, files with a four digit number from 0000 to 2499 are automatically created when saving the data. You can specify a common name (up to 4 characters, specified through File Name) that is placed before the number.

- **Initializing (Clearing) the Internal Memory**

- The storage operation can be executed only when the internal memory is cleared.
- If you are performing the first storage operation after turning ON the power switch, there is no need to clear the internal memory.

- **Specifying the File to Be Displayed in the File List Dialog Box**

Specify the type of files to be displayed.

- Item  
Displays only the numerical data and waveform display data files in the selected directory.
- All  
Displays all the files in the selected directory.

## 8.5 Saving the Stored Data

---

- **Properties**

Displays the following information about the selected file: filename.extension, the file size, the date the file was saved, the attribute, the comment, etc.

**Note**

---

- The following data is stored in the places where numerical data does not exist when saving the stored numerical data.
    - For ASCII files: Characters NAN, +INF, -INF, ERROR, or blank\*<sup>1</sup>.
      - \*1 Measurement functions that are displayed as blank such as the 0th (dc) and 1st order values of  $\phi_U$  and  $\phi_I$ .
    - For Float files: 0x7FC00000, 0x7F800000, 0xFF800000, or 0xFFFFFFFFE.
  - The number of directories and files that can be displayed in the file list is 2500. If the number of directories and files in a directory exceeds 2500, the file list randomly displays 2500 of the directories and files.
  - Files that do not have an archive attribute are not displayed in the File List window. Do not remove the archive attribute of the files saved by the WT3000 using your PC.
  - Up to 41 characters can be displayed in the path. If the path exceeds 41 characters, "..." is displayed at the end of the character string.
  - File names are not case-sensitive. Comments are case-sensitive. In addition, the following names cannot be used due to limitations of MS-DOS.  
AUX, CON, PRN, NUL, CLOCK, COM1 to COM9, and LPT1 to LPT9
  - The maximum number of files that can fit in one directory is 2500. If you need to save more than 2500 files, change the directory or move the existing files to another directory.
  - You can view the stored data saved in Float format (\*.WTD) using the File Reader Software\*<sup>2</sup> on your PC and convert the data into a CSV file.
    - \*2 The software program can be downloaded by accessing the Download and Support page from the following URL.  
<http://www.yokogawa.com/tm/>
  - If you change the extension of the file such as on a PC, the file can no longer be loaded into the File Reader Software.
-

## 8.6 Recalling the Stored Data

### Procedure

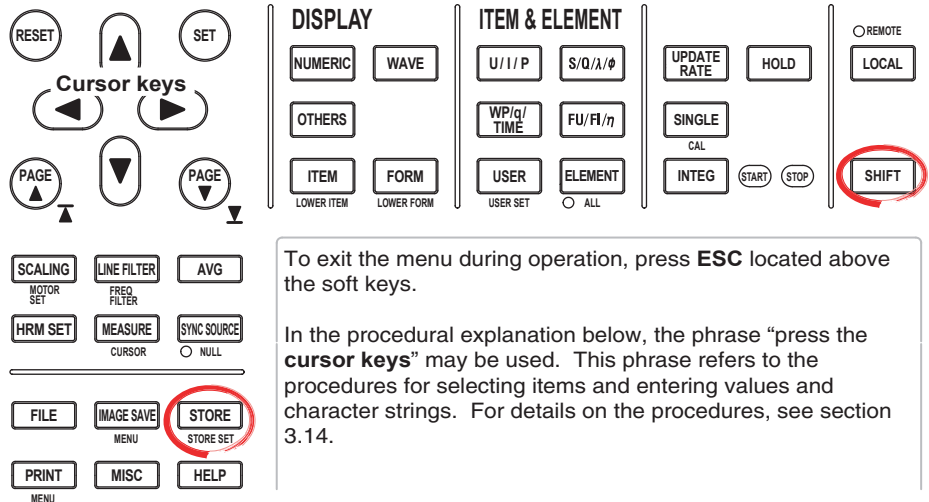

#### • Recalling the Data

1. Press **SHIFT+STORE(STORE SET)** to display the Store Set menu.
2. Press the **Mode** soft key to select Recall.
3. Press the **cursor keys** and set the Recall No. (number of the data to be recalled). The corresponding data is displayed.

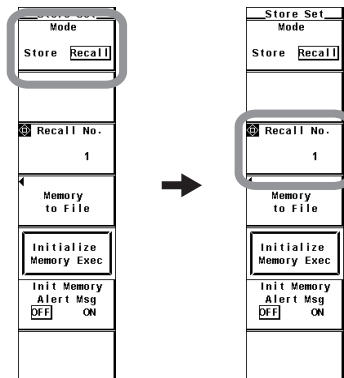

#### • Initializing (Clearing) the Internal Memory

The procedure to clear the internal memory varies depending on the store mode. This section describes the procedures when the store mode is recall. For the procedures when the store mode is store, see section 8.4.

4. Press the **Initialize Memory Exec** soft key.
 

If the alert indication for internal memory initialization (section 8.3) is ON, the Alert dialog box appears. Proceed to step 5. If the indication is OFF, the data in the internal memory is cleared without displaying the Alert dialog box.
5. Press the **cursor keys** to select OK or Cancel.
6. Select OK and press **SET** to clear the data in the internal memory. Select Cancel and press **SET** to not clear the data in the internal memory.

## 8.6 Recalling the Stored Data

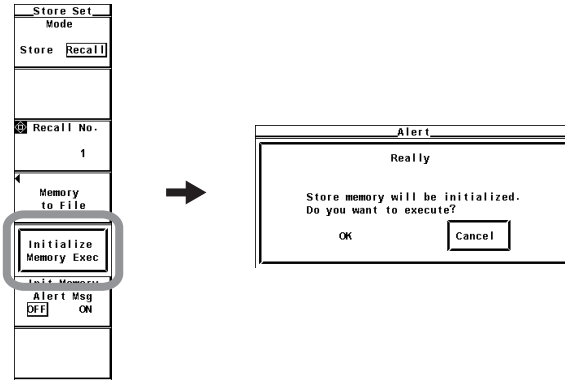

### Explanation

- **Recalling the Data**

You can recall and display the stored numeric data or waveform display data. There is a one-to-one relationship between the store count number (see section 8.2) and the Recall No. If you wish to recall the first stored data, for example, set Recall No. to 1. The Recall No. and store count are also displayed at the upper left corner of the screen. For example, the information is displayed as "Recall 3/100." In this example, the Recall No. is 3, and the store count is 100. If there is no stored data, the store count is 0.

### Note

Only the data stored in the internal memory can be recalled.

- **Display Related to Recall**

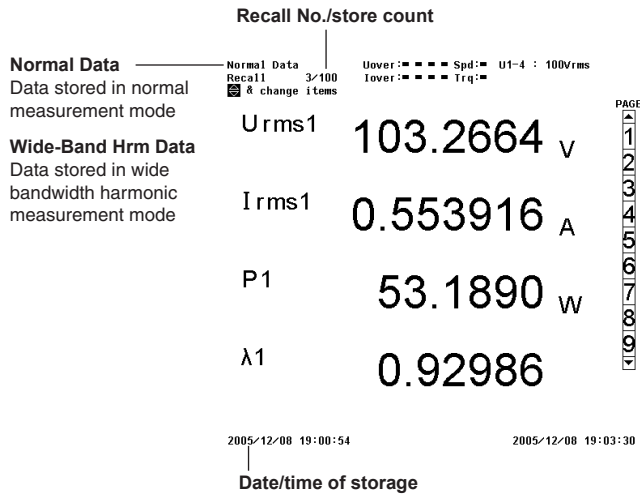

- **Initializing (Clearing) the Internal Memory**

To start the storage operation again, you must clear the internal memory.

## 9.1 PC Card and USB Memory

### PC Cards That Can Be Used

The WT3000 supports flash ATA cards (PC card TYPE II) and compact flash (using the PC card TYPE II adapter). For details, contact your nearest YOKOGAWA dealer.

#### Note

To use the PC card on the PC, use a PC that supports the PC card. Depending on the PC that you are using, the PC cards indicated above may not operate properly. Check it beforehand.

### Inserting the PC Card

Insert the PC card into the PC card drive with the front side of the card facing right.

#### Note

Be sure to insert the PC card all the way in. If it isn't, the WT3000 may not detect it correctly.

### Ejecting the PC Card

Check that the PC card is not being accessed and press the eject button below the PC card slot.

- \* Normally, the eject button is retracted. To eject the PC card, press the eject button once to pop the button out and press it again.

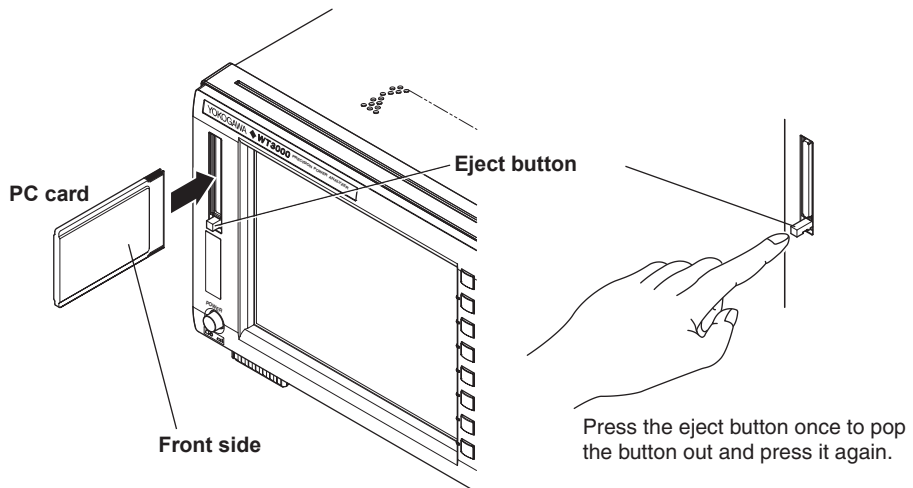

### CAUTION

- The WT3000 may malfunction if the PC card is inserted and ejected within 1-second time period.
- Do not remove the PC card or turn OFF the power while it is being accessed. If you do, the data on the PC card may be destroyed.
- An access icon is displayed at the upper left corner of the screen while the PC card is being accessed.

### General Handling Precautions of PC Cards

For the general handling precautions of the PC card, read the instruction manual that came with the PC card.



**USB PERIPHERAL Interface Specifications**

Item	Specifications
Connector type	USB type A connector (receptacle)
Electrical and mechanical specifications	Conforms to USB Rev.1.1
Data rate	12 Mbps maximum
Power supply	5 V, 500 mA* (per port)
Number of ports	2

\* Devices whose maximum current consumption exceeds 100 mA cannot be connected simultaneously to the two ports.

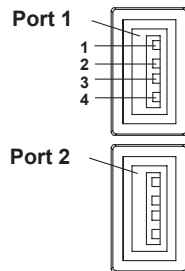

Pin No.	Signal Name
1	VBUS: +5 V
2	D-: -Data
3	D+: +Data
4	GND: Ground

**Compatible USB Storage Devices**

USB memories (USB Mass Storage Class) can be used on the WT3000.

**Connecting the USB Memory**

Connect the USB memory directly to the WT3000 without going through a USB hub. You can connect the USB memory regardless of whether the power switch on the WT3000 is ON or OFF (supports hot-plugging). When the power switch is ON, the USB memory is detected and enabled approximately six seconds after it is connected. An ID number (2 or greater) is automatically assigned to the detected USB memory.

**Note**

- Do not connect USB devices other than a USB keyboard or a USB memory to the USB PERIPHERAL connector.
- The WT3000 has two USB PERIPHERAL ports. However, USB devices whose maximum consumption current exceeds 100 mA cannot be connected simultaneously to the two ports.

**CAUTION**

- Do not remove the USB memory or turn OFF the power when the USB memory is being accessed. If you do, the data on the USB memory may be destroyed.
- An access icon is displayed at the upper left corner of the screen while the USB memory is being accessed.

**General Handling Precautions of USB Memories**

For the general handling precautions of the USB memory, read the instruction manual that comes with the memory.

## 9.2 Formatting the Storage Media

### CAUTION

- Do not remove the storage medium or turn OFF the power when the access indicator or icon is blinking. Such acts can damage the storage medium or destroy the data on it.
- If the WT3000 fails to detect a formatted storage medium, reformat the storage medium on the WT3000. Note that all the data on the storage medium are cleared when the storage medium is formatted. Be sure to back up important data beforehand.

### Procedure

The diagram shows the control panel with the following sections:

- Cursor keys:** RESET, SET, and four arrow keys (Up, Down, Left, Right).
- DISPLAY:** NUMERIC, WAVE, OTHERS, ITEM (LOWER ITEM), FORM (LOWER FORM).
- ITEM & ELEMENT:** U/I/P, S/O/λ/φ, WP/q/TIME, FU/FI/η, USER (USER SET), ELEMENT (ALL).
- UPDATE RATE:** UPDATE RATE, HOLD, LOCAL (with REMOTE indicator).
- Other keys:** SCALING (MOTOR SET), LINE FILTER (FREQ. FILTER), AVG, HRM SET, MEASURE (CURSOR), SYNC SOURCE (NULL), FILE (circled in red), IMAGE SAVE (MENU), STORE (STORE SET), PRINT (MENU), MISC, HELP.

To exit the menu during operation, press **ESC** located above the soft keys.

In the procedural explanation below, the phrase “press the **cursor keys**” may be used. This phrase refers to the procedures for selecting items and entering values and character strings. For details on the procedures, see section 3.14.

1. Press **FILE** to display the File menu.
2. Press the **Utility** soft key. The Utility menu and the File List dialog box appear.
3. Press the **Function** soft key to display the Function menu.

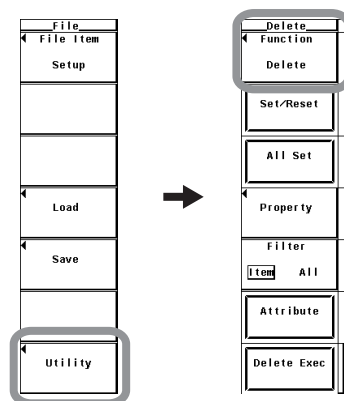

## 9.2 Formatting the Storage Media

- **Selecting the Storage Medium to Be Formatted**

4. Press the **Format** soft key. A storage media list is displayed in the File List dialog box.
5. Press the **cursor keys** to select the storage medium to be formatted.  
Net Work (drive) cannot be formatted.

- **Viewing the Storage Media Information**

6. Press the **Media Info** soft key. The information about the storage medium that was selected in step 5 is displayed.

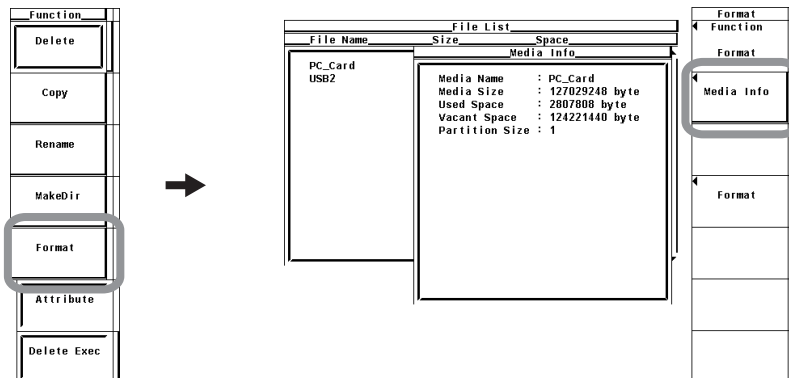

- **Selecting the Number of Partitions**

7. Press the **Format** soft key to display the Format menu.
8. Press the **cursor keys** to select 1 or 2.  
A storage medium that is already partitioned can be selected and formatted as a separate storage media, but the separate storage media cannot be partitioned further.

- **Executing (OK)/Aborting (Cancel) the Format Operation**

9. Press the **Format Exec** soft key. An Alert dialog box appears.
10. Press the **cursor keys** to select OK or Cancel.
11. Select OK and press **SET** to execute the format operation.  
Select Cancel and press **SET** to not carry out the format operation.

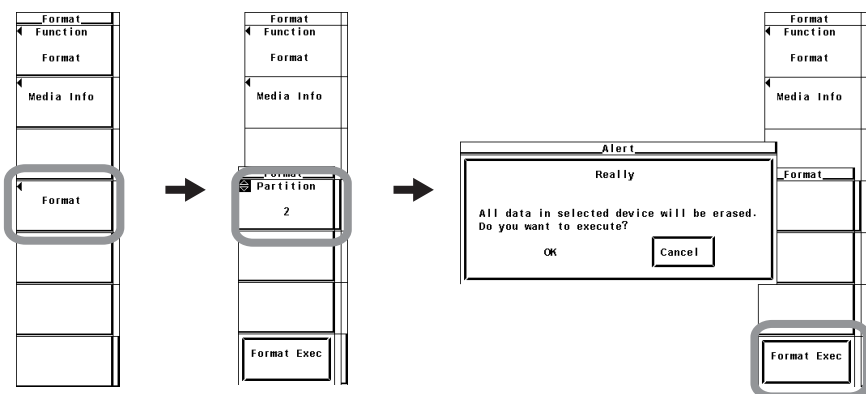

**Explanation**

- **Storage Medium Information**

Lists the information about the selected storage medium.

- Media Name: Storage medium name.
- Media Size: Total size.
- Used Space: Size of the used area.
- Vacant Space: Size of the free area.
- Partition Size: Number of partitions.

- **Formatting the PC Card/USB Memory**

The PC card or USB memory is formatted to FAT format.

- **Number of Partitions.**

You can set partitions on the PC card. However, PC cards that are handled as removable disks cannot be partitioned. You can select 1 or 2 for the number of partitions.

**Note**

- 
- Note that if you format a storage medium that has data stored on it, all of the stored data are cleared.
  - It takes a few seconds to format a PC card.
- 

- **Selecting the Storage Medium to be Formatted**

The explanation is the same as that given in “Selecting the Storage Medium and Directory” in section 9.3.

## 9.3 Saving Setup Parameters, Waveform Display Data, Numeric Data, Waveform Sampling Data

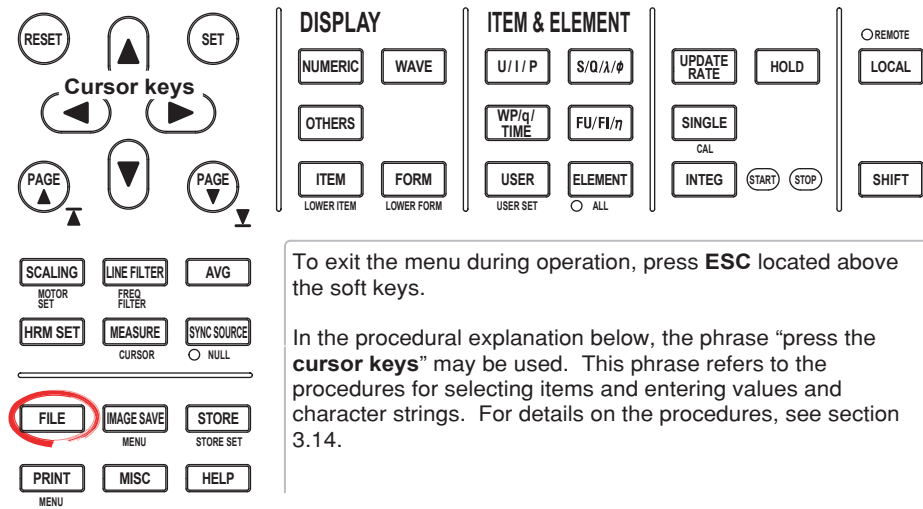

### Procedure

1. Press **FILE** to display the File menu.
- **Selecting the Item to Be Saved**
  2. Press the **File Item** soft key to display the File Item menu.
  3. Press one of the soft keys from **Setup** to **Numeric** or **Acquisition\*** to select the item to be saved.

Select Acquisition to save the power spectrum waveform data in FFT mode.  
 Select Numeric to save the measured data of cycle-by-cycle measurement mode.

If you selected Setup, proceed to step 11 under “Executing/Aborting the Save Operation” on page 9-10.

If you selected Wave, proceed to “Selecting the Waveform Display Data” on the next page.

If you selected Numeric, proceed to “Selecting the Numeric Data” on the 9-8.

If Acquisition is selected, proceed to “Selecting the Waveform Sampling Data” on page 9-9.

\* Displayed only to products with the advanced computation (/G6) option.

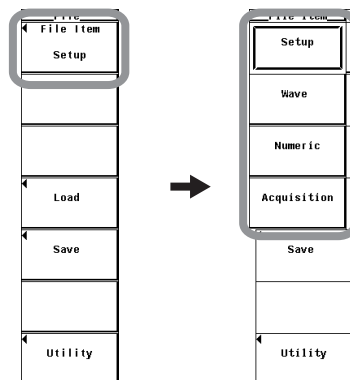

### Selecting the Waveform Display Data

- **Selecting the Type of Waveform Display Data to Be Saved**

4. Press the **Data Type** soft key to display the Data Type menu.
5. Press any of the soft keys from **Binary** to **Float** soft key to select the data type.

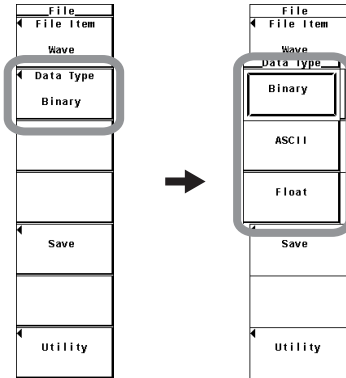

- **Selecting the Input Signals to Be Saved**

The input signal selection box appears only when you select Float in step 5. (When the data type is set to Binary or ASCII, the waveform that is displayed on the screen is saved.)

6. Press the **Save** soft key to display the Save Menu.
7. Press the **Trace** soft key to display the input signal selection box.
8. Press the **cursor keys** to select any of the elements/wiring units starting with U1.
9. Press **SET** to select the input signal to be saved.

Proceed to step 12 on page 9-10.

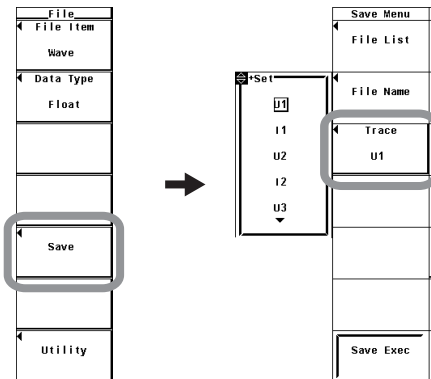

Selecting the Numeric Data

- **Selecting the Type of Numeric Data to Be Saved (for Measurement Modes Other Than Cycle-by-Cycle)**

4. Press the **Data Type** soft key to select ASCII or Float.

**Note**

The data type is fixed to ASCII for the cycle-by-cycle measurement.

- **Selecting the Numeric Data to Be Saved**

5. Press the **List Item** soft key to display the List Item dialog box.

- **Selecting All Items at Once**

6. Press the **cursor keys** to select All ON.  
 7. Press **SET**. The buttons to the left of all the elements and measurement functions are highlighted indicating that all items will be saved.

- **Deselecting All Items at Once**

6. Press the **cursor keys** to select All OFF.  
 7. Press **SET**. The highlighting of the buttons to the left of all the elements and measurement functions are cleared indicating that all items will not be saved.

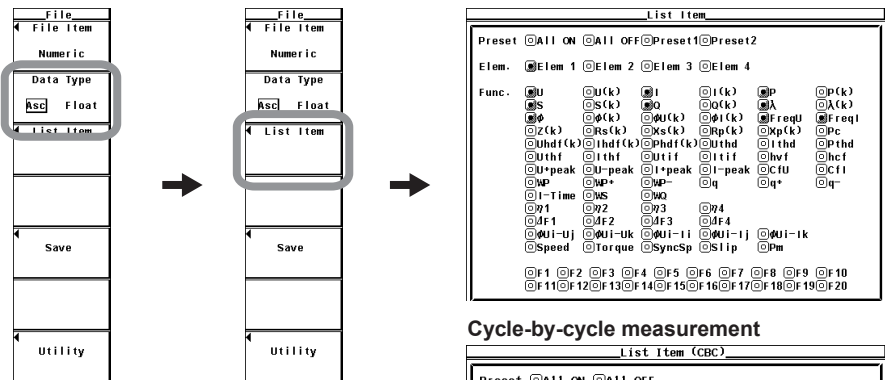

**Cycle-by-cycle measurement**

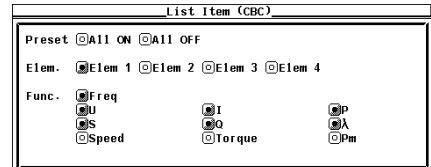

- **Selecting Only the Items That Are Preset (during Normal Measurement Only)**

6. Press the **cursor keys** to select Preset1 or Preset2.  
 7. Press **SET**. The buttons to the left of all the elements and measurement functions that are specified in Preset1 or Preset 2 are highlighted indicating that the items will be saved.

**Items specified in Preset1**

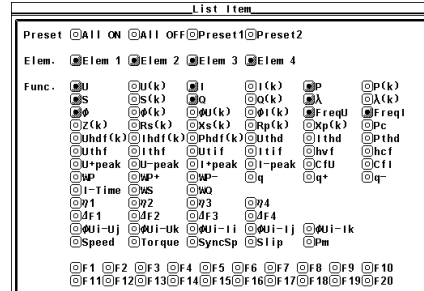

**Items specified in Preset2**

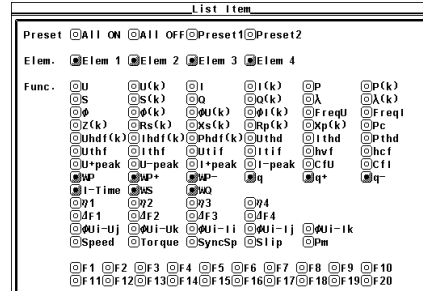

- **Setting the Items One at a Time**

6. Press the **cursor keys** to select the element or measurement function that you wish to specify.
7. Press **SET**. When the button to the left of the selected element or measurement function is highlighted, the numeric data of the measurement function of the element will be saved. When the highlighting of the button is cleared, the numeric data of the measurement function of the element will not be saved.

Proceed to step 10 on page 9-10.

### Selecting the Waveform Sampling Data

- **Selecting the Type of Waveform Sampling Data to Be Saved**

4. Press the **Data Type** soft key to display the Data Type menu.
5. Press one of the keys from **Binary** to **Float** to select the data type.

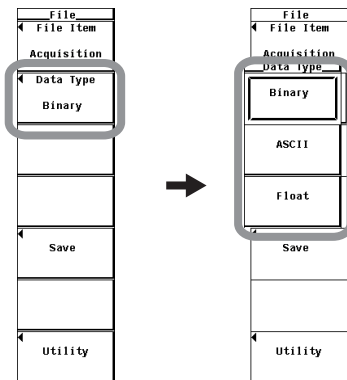

- **Selecting the Input Signals to Be Saved**

The input signal selection box appears only when you select Float in step 5. (When the data type is set to Binary or ASCII, the waveform that is displayed on the screen is saved.)

6. Press the **Save** soft key to display the Save Menu menu.
7. Press the **Trace** soft key to display the input signal selection box.
8. Press the **cursor keys** to select any of the elements/wiring units starting with U1.
9. Press **SET** to select the input signal to be saved.

Proceed to step 12 on page 9-10.

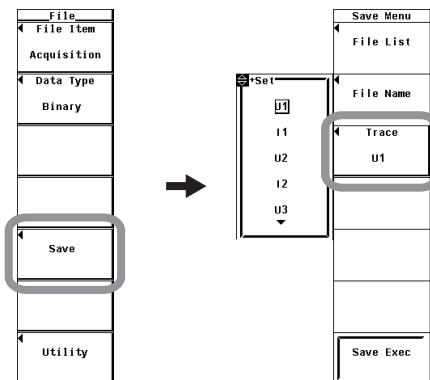



**Executing/Aborting the Save Operation**

10. Press **ESC** to close the List Item dialog box.
  11. Press the **Save** soft key to display the Save Menu.
  12. Press the **File List** soft key to display the File List dialog box.
- **Selecting the Save Destination Medium**
    13. Press the **cursor keys** to select the storage medium (indicated by [ ]).
    14. Press **SET** to confirm the storage medium.
  - **Selecting the Save Destination Directory**  
 (Perform this operation when directories are present on the medium.)
    15. Press the **cursor keys** to select the save destination directory (indicated by < >).
    16. Press **SET** to confirm the directory.

The selected medium/directory is displayed in “Path=.....” located above and to the left of the File List dialog box.

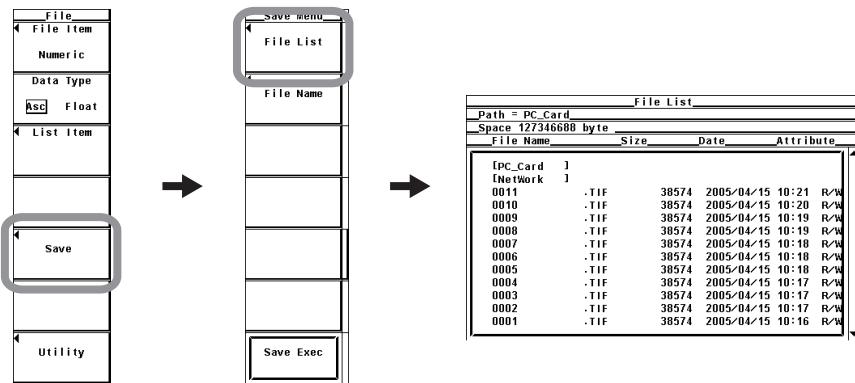

- **Setting the File Name and Comment**
  17. Press the **File Name** soft key to display the Save dialog box.
  18. Press the **cursor keys** to select Auto Naming.
  19. Press **SET** to select ON or OFF.
  20. Press the **cursor keys** to select File Name.
  21. Press **SET** to display the keyboard.
  22. Use the **keyboard** to set the file name.  
 For keyboard operations, see section 3.14, “Entering Values and Strings.”
  23. Enter the **Comment** in a similar fashion.
  24. Press **ESC** to close the Save dialog box.

### 9.3 Saving Setup Parameters, Waveform Display Data, Numeric Data, Waveform Sampling Data

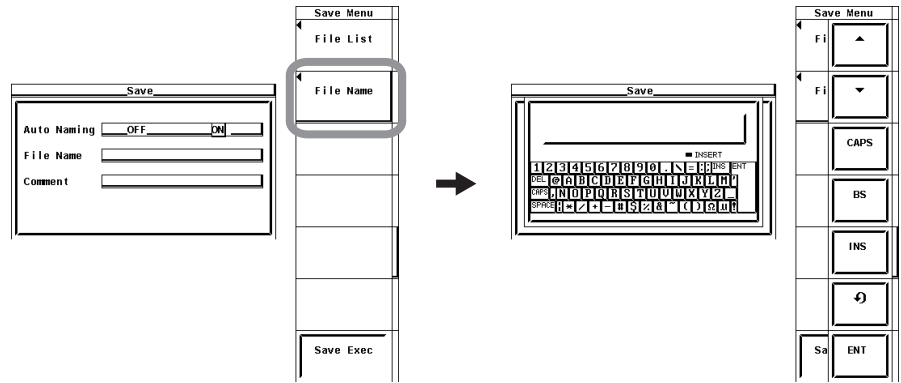

- **Executing the Save Operation**

25. Press the **Save Exec** soft key. The data is saved to the directory indicated by Path=..... At the same time, the Save Exec soft key changes to the Abort soft key.

- **Aborting the Save Operation**

26. Press the **Abort** soft key to abort the save operation. At the same time, the Abort soft key changes to the Save Exec soft key.

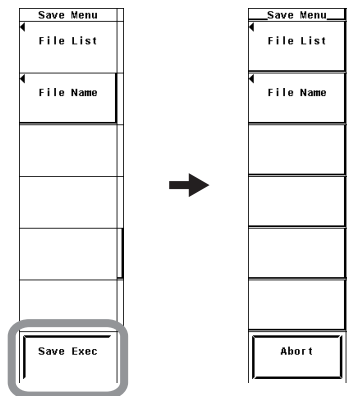

- **Specifying the File to Be Displayed in the File List Dialog Box**

The procedure is the same as that given in "Specifying the File to Be Displayed in the File List Dialog Box" in section 9.6.

- **Viewing the Properties**

The procedure is the same as that given in "Viewing the Properties" in section 9.6.

### 9.3 Saving Setup Parameters, Waveform Display Data, Numeric Data, Waveform Sampling Data

#### Explanation

#### **CAUTION**

Do not remove the storage medium (disk) or turn OFF the power when the access indicator or  is blinking. Doing so can damage the storage medium or destroy the data on the medium.

Setup parameters, waveform display data, numeric data, and waveform sampling data can be saved.

- **Limitation on the Data Save Function by Measurement Modes**

There are limitations on the data save function depending on the measurement mode as follows:

Saved Item	Measurement Mode and Options							
	Normal Measurement		Wide Bandwidth Harmonic	IEC Harmonic	Waveform Computation	FFT	Voltage Fluctuation and Flicker	Cycle by Cycle
	None	/G6,/G5 Harmonics	/G6	/G6	/G6	/G6	/FL	/CC
Setup parameters (Setup)	Yes	Yes	Yes	Yes	Yes	Yes	Yes	Yes
Waveform data (Wave)	Yes	Yes	No	No	Yes	Yes*1	No	No
Numeric data (Numeric) <sup>2</sup>	Yes	Yes	Yes	Yes	Yes	Yes	No	Yes
Waveform sampling data (Acquisition)	No	No	No	No	Yes	Yes	No	No

Yes: Can be saved.  
No: Cannot be saved.

\*1 FFT waveforms are saved as waveform sampling data (Acquisition).

\*2 If an item that is not measured or computed in the respective measurement mode is selected, NAN data is saved.

- **Saving Setup Parameters**

Select Setup from the File Item menu to save setup parameters.

- **Setup Parameters That Are Saved**

The setup parameters of each key existing at the time of the save operation can be saved. However, setup parameters such as the date, time and communications are not saved.

- **Data Size**

The data size of a single set of setup parameters is approximately 20 KB.

- **Extension**

The .SET extension is automatically added to the file name.

• **Saving the Waveform Display Data**

Select Wave from the File Item menu to save waveform display data.

• **Relationship between the Waveform Display Data That Can Be Saved and Measurement Modes**

There are limitations on waveform display data that can be saved depending on the measurement mode as indicated below: Set the item to be saved to waveform sampling data (Acquisition) for FFT waveforms.

Waveform Display Data	Measurement Mode		
	Normal Measurement	Waveform Computation	FFT <sup>*2</sup>
U1	Yes	Yes	Yes
I1	Yes	Yes	Yes
U2	Yes	Yes	Yes
I2	Yes	Yes	Yes
U3	Yes	Yes	Yes
I3	Yes	Yes	Yes
U4	Yes	Yes	Yes
I4	Yes	Yes	Yes
Speed <sup>*1</sup>	Yes	Yes	Yes
Torque <sup>*1</sup>	Yes	Yes	Yes
Math1 <sup>*2</sup>	No	Yes	No
Math2 <sup>*2</sup>	No	Yes	No

\*1 Applicable only to products with the motor evaluation function (motor version).

\*2 Applicable only to products with the advanced computation (/G6 option).

• **Selecting the Data Type**

Select the data type from below. The extension is automatically added.

- Binary
  - The following two files are created in the directory.
    - Waveform display data file (.wvf)
    - ASCII header file (.hdr)
  - Waveform display data is saved in binary format.
  - For details on the ASCII header file, see appendix 3.
  - Either file cannot be loaded into the WT3000.
- ASCII
  - Saved in ASCII format.
  - The file can be used on your PC for analysis.
  - The file cannot be loaded into the WT3000.
- Float
  - Saved in 32-bit floating format.
  - The file cannot be loaded into the WT3000.

**Note**

The waveform display data that is saved on the WT3000 is not the sampled data acquired at the sample rate (approximately 200 kS/s) of the WT3000. The waveform display data is waveform sampling data that has been P-P compressed (see the note in section 2.7) to a set of 1002 data points for displaying the waveform on the screen. Waveform sampling data can be saved in waveform computation mode or FFT mode on models with the advanced computation (/G6) option.

### 9.3 Saving Setup Parameters, Waveform Display Data, Numeric Data, Waveform Sampling Data

---

- **Extension and Data Size**

- During normal measurement

Data Type	Extension	Data Size (Bytes)
Binary	.WVF	Approx. $(8K + 4 \times 1002 \times Tw)$ where Tw is the number of displayed waveforms
	.HDR	Approx. 1 K (condition: when there is one displayed waveform)
ASCII	.CSV	Approx. 15 K (condition: when there is one displayed waveform)
Float	.FLD	$4 \times 1002$

- **Selecting the Waveform**

- When the data type is set to Binary or ASCII, the waveform that is displayed on the screen is saved.
- When the data type is Float, the waveform of the input signal selected from the following is saved.
  - Only the input signals of the installed elements are applicable for the selection.
  - For models with the motor evaluation function (motor version), the input signals of Speed and Torque are also selectable items.

- **Saving the Numeric Data**

Select Numeric from the File Item menu to save numerical data.

- **Selecting the Data Type**

Select the data type from below. The extension is automatically added. The data type is fixed to ASCII for the cycle-by-cycle measurement.

- ASCII
  - Saved in ASCII format.
  - The file can be used on your PC for analysis.
  - The file cannot be loaded into the WT3000.
- Float
  - Saved in 32-bit floating format.
  - The file cannot be loaded into the WT3000.

- **Extension and Data Size (Normal Measurement Example)**

Data Type	Extension	Data Size (Bytes)
ASCII	.CSV	Approx. 2 K (condition: number of elements 1, saved item Preset1)
Float	.WTD	When integration is not performed Approx. $(8 K + 4 \times Dn)$
		When integration is performed Approx. $(8K + (4 \times Dn + 16 \times Ti))$ Dn: Number of numerical data to be saved (Number of measurement functions $\times$ (number of elements + number of wiring units)) Ti: Number of integration time to be saved

- **Selecting the Numeric Data**

Select the numeric data items that are to be saved.

- Installed elements and wiring units are applicable for the selection.
- Measurement functions can be selected as follows:

For measurement modes other than cycle-by-cycle measurement

- Measurement functions of normal measurement (see section 2.2)
- Measurement functions of the motor evaluation function (motor version)\*
- Measurement functions of harmonic measurement (option)\*

For cycle-by-cycle measurement mode

- Measurement functions of cycle-by-cycle measurement\*

\* See the Expansion Function User's Manual IM760301-51E.

- The following data is saved in the places where numeric data does not exist when saving the numeric data.
  - For ASCII files: Characters NAN, +INF, -INF, ERROR, or blank\*1.
    - \*1 Measurement functions that are displayed as blank such as the 0th (dc) and 1st order values of  $\phi U$  and  $\phi I$ .
  - For Float files: 0x7FC00000, 0x7F800000, 0xFF800000, or 0xFFFFFFFFE.
- When saving the cycle-by-cycle measurement data, information indicating whether peak over-range occurred during the measurement is recorded to the right of the voltage (U), current (I), speed, and torque data values using a number between 0 and 7. There are two methods for detecting peak over-range: detection by data and detection by hardware. The peak over-range information that is recorded is a combination of these detection results. See below.

	Peak over-range detection by hardware	
	Did not occur	Occurred
Peak over-range data did not occur	0	4
Positive peak over-range data occurred	1	5
Negative peak over-range data occurred	2	6
Positive and negative peak over-range data occurred	3	7

**Note**

If any hardware peak over-range is detected during the measurement of all cycles, a number between 4 to 7 is recorded for the data of all cycles of that input signal.

- **Saving the Waveform Sampling Data**

Select Acquisition from the File Item menu to save waveform sampling data.\*

- \* Data acquired at the WT3000's sample rate (200 kS/s).

### 9.3 Saving Setup Parameters, Waveform Display Data, Numeric Data, Waveform Sampling Data

- **Relationship between the Waveform Sampling Data That Can Be Saved and Measurement Modes**

There are limitations on waveform sampling data that can be saved depending on the measurement mode as indicated below:

Waveform Display Data	Measurement Mode	
	Waveform Computation <sup>*2</sup>	FFT <sup>*2</sup>
U1	Yes	Yes
I1	Yes	Yes
U2	Yes	Yes
I2	Yes	Yes
U3	Yes	Yes
I3	Yes	Yes
U4	Yes	Yes
I4	Yes	Yes
Speed <sup>*1</sup>	Yes	Yes
Torque <sup>*1</sup>	Yes	Yes
Math1 <sup>*2</sup>	Yes	No
Math2 <sup>*2</sup>	Yes	No
FTT1 <sup>*2</sup>	No	Yes
FFT2 <sup>*2</sup>	No	Yes

\*1 Applicable only to products with the motor evaluation function (motor version).

\*2 Applicable only to products with the advanced computation (/G6 option).

- **Selecting the Data Type**

Select the data type from below. The extension is automatically added.

- Binary
  - The following two files are created in the directory.
    - Waveform display data file (.wvf)
    - ASCII header file (.hdr)
  - Waveform display data is saved in binary format.
  - For details on the ASCII header file, see appendix 3.
  - Neither file can be loaded into the WT3000.
- ASCII
  - Saved in ASCII format.
  - The file can be used on your PC for analysis.
  - The file cannot be loaded into the WT3000.
- Float
  - Saved in 32-bit floating format.
  - The file cannot be loaded into the WT3000.

### 9.3 Saving Setup Parameters, Waveform Display Data, Numeric Data, Waveform Sampling Data

- **Extension and Data Size**

Data Type	Extension	Data Size (Bytes)
Binary	.wvf	Approx. $(8K + 4 \times \text{the number of waveform sampling data points} \times T_w)$ where $T_w$ is the number of displayed waveforms
	.hdr	Approx. 1 K (condition: when there is one displayed waveform)
ASCII	.csv	Approx. 150 K (condition: when there is one displayed waveform) with the data update rate set to 50 ms
Float	.fld	$4 \times \text{the number of waveform sampling data points}$

- The number of waveform sampling data points of U1 to I4, Speed, Torque, Math1, Math2 in waveform computation mode

Data Update Rate	Number of Waveform Sampling Data Points
50 ms	10,000 points
100 ms	20,000 points
250 ms	50,000 points
500 ms	100,000 points
1 s	200,000 points
2 s	400,000 points
5 s	1,000,000 points
10 s	2,000,000 points
20 s	4,000,000 points

- The number of waveform sampling data points of U1 to I4, Speed, Torque, Math1, Math2 in FFT mode

FFT Points	Number of Waveform Sampling Data Points
200 k	200,000 points
20 k	20,000 points

\* The number of waveform sampling data points do not depend on the data update rate.

- The number of waveform sampling data points of FF1 and FF2 in FFT mode

FFT Points	Number of FFT Waveform Data Points
200 k	100,000 points + 1 (DC)
20 k	10,000 points + 1 (DC)

- **Selecting the Waveform**

- When the data type is set to Binary or ASCII, the waveform that is displayed on the screen is saved.
- When the data type is Float, the waveform of the input signal selected from the following is saved.
  - Only the input signals of the installed elements are applicable for the selection.
  - For models with the motor evaluation function (motor version), the input signals of Speed and Torque are also selectable items.



### 9.3 Saving Setup Parameters, Waveform Display Data, Numeric Data, Waveform Sampling Data

- **Executing the Save Operation**
  - The save operation may take several seconds to several hours depending on the number of waveforms to be saved, the data type, the number of waveform sampling data points determined by the data update rate, and the data transfer rate to the save destination medium. The save operation takes a long time when there are many waveforms to be saved, the data update rate is slow, and the number of waveform sampling data points is large.
  - The measurement stops while the data is being saved. The measurement resumes when the save operation completes or is aborted.
  - To execute the save operation when the data update rate is 20 s and the display is held, execute a single measurement once, and carry out the save operation after the data update due to the single measurement is complete.
  - If you carry out single measurement while the display is held, the waveform sampling data is overwritten. If you execute the save operation while the data update by the single measurement is in progress and the waveform sampling data is being overwritten, an error occurs, and the file is not created.
  - If the speed or torque signal type of the motor evaluation function is set to pulse, "ERROR" is saved for the waveform sampling data of that signal.
- **Selecting the Storage Medium and Directory**

Media on which saving and reading is possible are displayed in the File List dialog box.

#### Currently selected medium and directory

File Name	Size	Date	Attribute
[PC_Card ]			
[NetWork ]			
< .			
> Power_T3		2005/05/24 13:00	
> Power_T2		2005/05/24 13:00	
> Power_T1		2005/05/24 12:58	
WAVE_0003	48272	2005/05/24 13:18	R/W
WAVE_0002	48272	2005/05/24 13:18	R/W
WAVE_0001	48272	2005/05/24 13:18	R/W
WAVE_0000	48272	2005/05/24 13:18	R/W

Directory

Save destination medium

#### Display Example of Storage Media

[PC\_Card]: PC card

[USB2]: USB memory (option) with ID number 2

[NetWork]: Network drive (option. see *Expansion Function User's Manual IM760301-51E*)

## 9.3 Saving Setup Parameters, Waveform Display Data, Numeric Data, Waveform Sampling Data

- **File Name and Comment**

- A file name must be assigned. Comments are optional.
- You cannot save data to a file name that already exists in the same directory (overwriting not allowed).

### Number and Types of Characters That Can Be Used

Item	Number of Characters	Characters That Can Be Used
File Name	1 to 8 characters	0-9, A-Z, %, _ , ( ) (parentheses), - (minus sign)
Comment	0 to 25 characters	Characters that are displayed on the keyboard and spaces

- **Auto Naming Function**

When Auto Naming is turned ON, files with a four digit number from 0000 to 2499 are automatically created when saving the data. You can specify a common name (up to 4 characters, specified through Filename) that is placed before the number.

- **Specifying the File to Be Displayed in the File List Dialog Box**

The explanation is the same as that given in “Specifying the File to Be Displayed in the File List Dialog Box” in section 9.6.

- **Properties**

The explanation is the same as that given in “Properties” in section 9.6.

### Note

- For the meanings of the measurement function symbols that are displayed, see section 2.2, “Measurement Functions and Measurement Periods,” 2.5, “Computation,” 2.6, “Integration,” appendix 1, “Symbols and Determination of Measurement Functions,” and *Expansion Function User’s Manual IM760301-51E*.
  - For details on the wiring units expressed as  $\Sigma A$  and  $\Sigma B$ , see section 4.1, “Selecting the Wiring System.”
  - The maximum order for which the harmonic data is saved is the maximum harmonic order to be measured that is specified in the harmonic measurement (option) menu.
  - Up to 41 characters can be displayed in the path.
  - File names are not case-sensitive. Comments are case-sensitive. In addition, the following five file names cannot be used due to limitations of MS-DOS.  
AUX, CON, PRN, NUL, and CLOCK
  - The maximum number of files that can fit in one directory is 2500. If you need to save more than 2500 files, change the directory or move the existing files to another directory.
  - The header section of the saved file is in a common format used by YOKOGAWA’s measuring instruments. Therefore, data that is not used by the SL1400 is also included.
  - Setup parameters that have been saved on products with firmware version having incompatible data cannot be loaded.
  - You can use the File Reader Software<sup>\*2</sup> to view the following files and convert them into CSV files on your PC.
    - Waveform display data file saved in binary format (\*.wvf)
    - Numeric data file saved in float format (\*.WTD)
    - Setup parameter file (\*.SET)
- <sup>\*2</sup> The software program can be downloaded by accessing the Download and Support page from the following URL.  
<http://www.yokogawa.com/tm/>
- If you change the extension of the file such as on a PC, the file can no longer be loaded into the File Reader Software.

## 9.4 Saving the Screen Image Data

### CAUTION

Do not remove the PC card or USB memory or turn OFF the power when the access indicator or icon of the PC card or USB memory is blinking. This can damage the PC card or USB memory or destroy the data on the it.

### Procedure

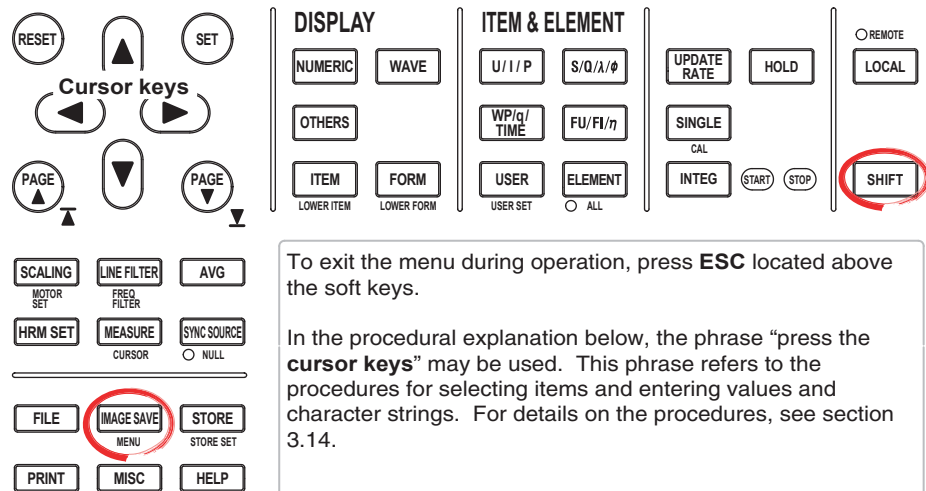

1. Press **SHIFT+IMAGE SAVE (MENU)** to display the Image Save menu.
- **Selecting the Data Format**
    2. Press the **Format** soft key to display the Format menu.
    3. Press any soft key from **TIFF**, **BMP**, **Post Script**, **PNG**, and **JPEG** to select the data format.
  - **Selecting the Color Mode**

(Selectable only when the data format is set to TIFF, BMP, PNG, or JPEG in step 3)

    4. Press the **cursor keys** to select Color, Reverse (white background), Gray (grayscale), or OFF.
  - **Turning ON/OFF the Data Compression**

(Selectable only when the data format is set to BMP in step 3 and the color mode is set to Color, Reverse, or Gray in step 4.)

    5. Press the **Compression(Color)** soft key to select ON or OFF.

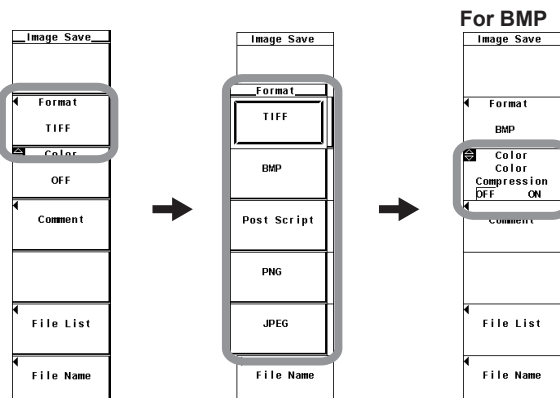

• **Setting Comments**

6. Press the **Comment** soft key. A keyboard appears.
7. Use the **keyboard** to enter the comment.

For keyboard operations, see section 3.14, "Entering Values and Strings."

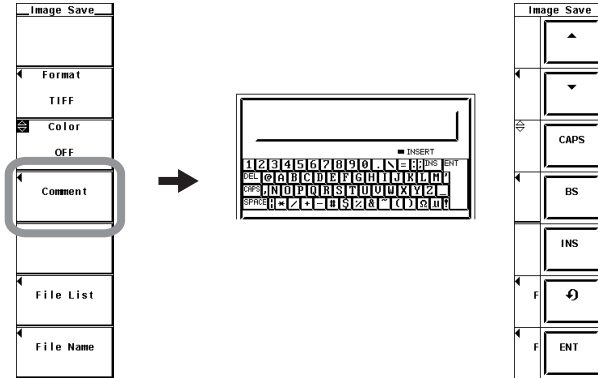

• **Selecting the Storage Medium and Directory**

8. Press the **File List** soft key to display the File List dialog box.
9. The procedure is the same as that given in "Selecting the Storage Medium" and "Selecting the Save Destination Directory" in section 9.3.
10. Press **ESC** to close the File List dialog box.

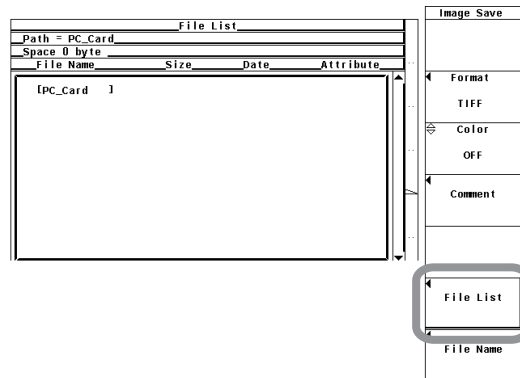

## 9.4 Saving the Screen Image Data

- **Setting the file name**

11. Press the **File Name** soft key to display the File Name dialog box.
12. Press the **cursor keys** to select Auto Naming.
13. Press **SET** to select ON or OFF.
14. Press the **cursor keys** to select File Name.
15. Press **SET**. A keyboard appears.
16. Use the **keyboard** to set the file name.  
For keyboard operations, see section 3.14, "Entering Values and Strings."
17. Press **ESC** to close the File Name dialog box.

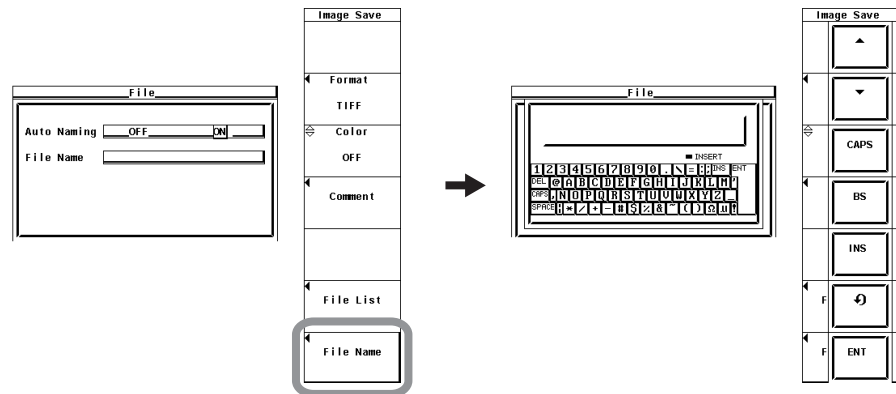

- **Executing or Aborting the Save Operation**

Display the desired screen and carry out the following procedure.

Press **IMAGE SAVE**. The screen image data is saved to the directory indicated by Path=..... If you press **IMAGE SAVE** again while the save operation is in progress, the operation is aborted. An icon appears at the upper left corner of the screen while the save operation is in progress.

**Explanation**

The screen image data can be saved.

- **Data Format and Extension**

The data in the following formats can be saved. The extension that is automatically added and the data size are indicated below.

Data Format	Extension	Data Size (Reference Value, Unit: Bytes)		
		OFF	Color	Color (data compression)
TIFF	.TIF	Approx. 40 K	Approx. 310 K	–
BMP	.BMP	Approx. 40 K	Approx. 310 K	Approx. 30 K
Post Script	.PS	Approx. 80 K	–	–
PNG	.PNG	Approx. 5 K	Approx. 10 K	–
JPEG	.JPG	Approx. 40 K	Approx. 50 K	–

- **Color Mode**

The color mode can be selected when the data format is TIFF, BMP, PNG, or JPEG.

- Color: Color (256 colors)
- Reverse: White background, black text, color waveforms
- Gray: 16 gray levels
- OFF: Black and white

- **Turning ON/OFF Data Compression**

The data compression can be turned ON/OFF when the data format is BMP and the color mode is Color, Reverse, or Gray.

- OFF: Do not compress the data.
- ON: Compress the data with RLE.

- **File Name and Comment**

The explanation is the same as that given in “File Name and Comment” in section 9.3. However, only the first 20 characters of the comment appears on the screen.

- **Selecting the Storage Medium and Directory**

The explanation is the same as that given in “Selecting the Storage Medium and Directory” in section 9.3.

- **Auto Naming Function**

Same as the explanation in “Auto Naming Function” in section 9.3.

**Note**

- The number of directories and files that can be displayed in the file list is 2500. If the number of directories and files in a directory exceeds 2500, the file list randomly displays 2500 of the directories and files.
- If you change the extension of the file such as on a PC, the file can no longer be loaded.
- Files that do not have an archive attribute are not displayed in the File List window. Do not remove the archive attribute of the files saved by the WT3000 using your PC.
- Up to 41 characters can be displayed in the path. If the path exceeds 41 characters, “...” is displayed at the end of the character string.
- File names are not case-sensitive. Comments are case-sensitive. In addition, the following names cannot be used due to limitations of MS-DOS.  
AUX, CON, PRN, NUL, CLOCK, COM1 to COM9, and LPT1 to LPT9

## 9.5 Loading Setup Parameters

### CAUTION

Do not remove the PC card or USB memory or turn OFF the power when the access indicator or icon of the PC card or USB memory is blinking. This can damage the PC card or USB memory or destroy the data on the it.n it.

### Procedure

The diagram shows the control panel with the following key labels:

- Cursor keys:** RESET, SET, and four arrow keys (Up, Down, Left, Right).
- Navigation:** PAGE (Left), PAGE (Right).
- DISPLAY:** NUMERIC, WAVE, OTHERS, ITEM (LOWER ITEM), FORM (LOWER FORM).
- ITEM & ELEMENT:** U/I/P, S/Q/A/φ, WPI/q/TIME, FU/FI/η, USER (USER SET), ELEMENT (ALL).
- Function Keys:** SCALING (MOTOR SET), LINE FILTER (FREQ FILTER), AVG, HRM SET, MEASURE (CURSOR), SYNC SOURCE (NULL), FILE (circled in red), IMAGE SAVE (MENU), STORE (STORE SET), PRINT (MENU), MISC, HELP.
- Other:** UPDATE RATE, HOLD, LOCAL (REMOTE), SINGLE (CAL), INTEG, START, STOP, SHIFT.

To exit the menu during operation, press **ESC** located above the soft keys.

In the procedural explanation below, the phrase “press the **cursor keys**” may be used. This phrase refers to the procedures for selecting items and entering values and character strings. For details on the procedures, see section 3.14.

1. Press **FILE** to display the File menu.

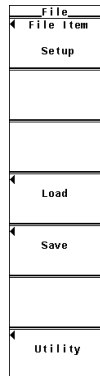

2. Press the **Load** soft key. The Load Menu and the File List dialog box appears

• **Selecting the Load Source Storage Medium**

3. Press the **cursor keys** to select the load source storage medium (indicated by [ ]).
4. Press **SET** to confirm the storage medium.

• **Selecting the Load Source Directory**

(Perform this operation when directories are present on the medium.)

5. Press the **cursor keys** to select the load source directory (indicated by < >).
6. Press **SET** to confirm the directory.
  - The selected storage medium/directory is displayed in "Path=....." located above and to the left of the File List dialog box.
  - Select <.. > and press **SET** to return to a higher level directory.

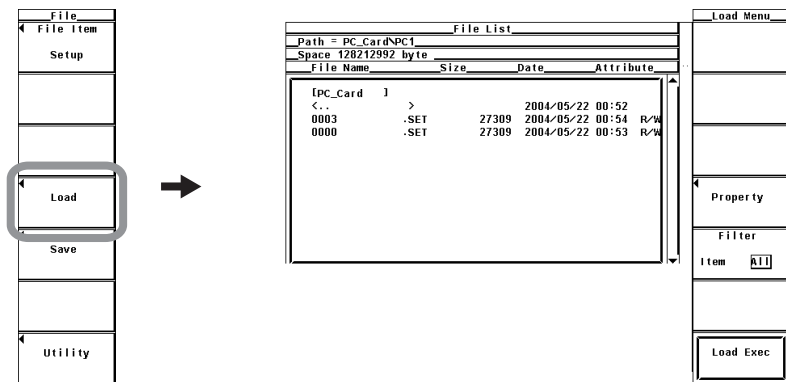

• **Selecting the File to Be Loaded**

7. Press the **cursor keys** to select the file.

• **Executing the Load Operation**

8. Press the **Load Exec** soft key. The selected file is read from the directory indicated in Path=..... At the same time, the Load Exec soft key changes to the Abort soft key.

• **Aborting the Load Operation**

9. Press the **Abort** soft key. The load operation is aborted. At the same time, the Abort soft key changes to the Load Exec soft key.

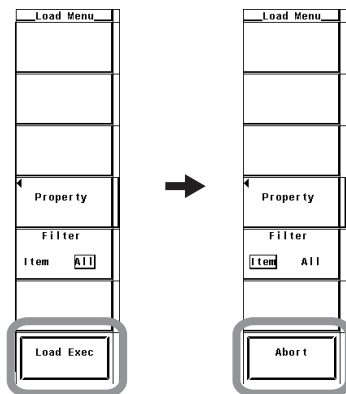



## 9.5 Loading Setup Parameters

---

- **Specifying the File to Be Displayed in the File List Dialog Box**

The procedure is the same as that given in “Specifying the File to Be Displayed in the File List Dialog Box” in section 9.6.

- **Viewing the Properties**

The procedure is the same as that given in “Viewing the Properties” in section 9.6.

### Explanation

**The setup parameters saved using the WT3000 can be loaded.**

- **Selecting the Storage Medium and Directory**

The explanation is the same as that given in “Selecting the Storage Medium and Directory” in section 9.3.

- **Specifying the File to Be Displayed in the File List Dialog Box**

The explanation is the same as that given in “Specifying the File to Be Displayed in the File List Dialog Box” in section 9.6.

- **Properties**

The explanation is the same as that given in “Properties” in section 9.6.

### Note

---

- An error occurs if a key other than the Abort key is pressed while saving or loading a file.
  - The number of directories and files that can be displayed in the file list is 2500. If the number of directories and files in a directory exceeds 2500, the file list randomly displays 2500 of the directories and files.
  - If you change the extension of the setup parameter file such as on a PC, the file can no longer be loaded into WT3000.
  - Files that do not have an archive attribute are not displayed in the File List window. Do not remove the archive attribute of the files saved by the WT3000 using your PC.
  - Up to 41 characters can be displayed in the path. If the path exceeds 41 characters, “...” is displayed at the end of the character string.
  - File names are not case-sensitive. Comments are case-sensitive. In addition, the following names cannot be used due to limitations of MS-DOS.  
AUX, CON, PRN, NUL, CLOCK, COM1 to COM9, and LPT1 to LPT9
  - If the setup parameters that are saved to a file are loaded, the key settings are changed to the loaded information and cannot be undone. It is recommended that you first save the current setup parameters and then load the setup parameters from a file.
  - Setup parameters such as the date and time, and communications are not saved. Therefore, loading setup parameters from a file will not change these settings.
  - Setup parameters that have been saved on products with firmware version having incompatible data cannot be loaded.
  - Setup parameters saved on models with a different product version, element configuration, or options as well as models with a different firmware (ROM) version of incompatible data cannot be loaded.
-

## 9.6 Specifying the File to Be Displayed, Displaying File Properties, and Selecting File Attributes

### CAUTION

Do not remove the PC card or USB memory or turn OFF the power when the access indicator or icon of the PC card or USB memory is blinking. This can damage the PC card or USB memory or destroy the data on the it.

### Procedure

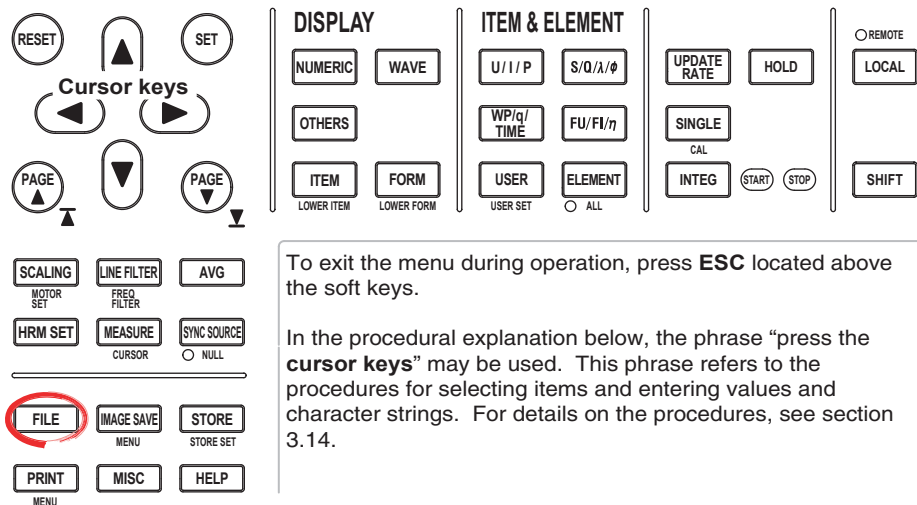

1. Press **FILE** to display the File menu.
2. Press the **Utility** soft key. The Utility menu and the File List dialog box appear.
3. Press the **Function** soft key to display the Function menu.
4. Press the **Delete** soft key to display the Delete menu.

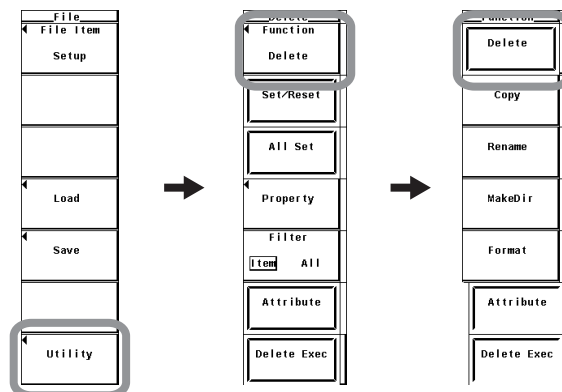

- **Selecting the Storage Medium and Directory**

5. The procedure is the same as that given in “Selecting the Storage Medium” and “Selecting the Save Destination Directory” in section 9.3.

## 9.6 Specifying the File to Be Displayed, Displaying File Properties, and Selecting File Attributes

- **Specifying the File to Be Displayed in the File List Dialog Box**

6. Press the **Filter** soft key to select Item or All.
  - If you select Item, the list of files corresponding to the file type (Setup, Wave, or Numeric) that is specified for File Item in the File menu, in the directory selected in step 5, is displayed.
  - If you select All, the list of all the files in the directory selected in step 5 is displayed.

- **Viewing the Properties**

7. On the File List dialog box, press the **cursor keys** to select the file.
8. Press the **Property** soft key to display the file property window.
9. Press **ESC** to close the file property window.

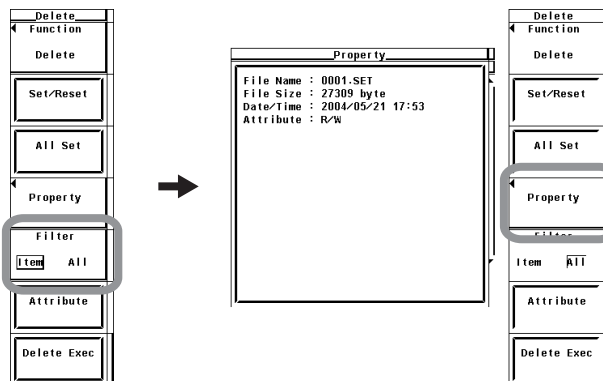

- **Selecting the File Attribute**

10. Press the **cursor keys** to select the file.
11. Press the **Attribute** soft key. The attribute of the selected file changes to R or R/W.

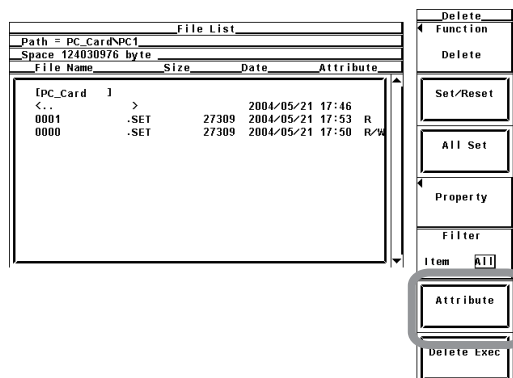

### Explanation

- **Selecting the Storage Medium and Directory**

The explanation is the same as that given in “Selecting the Storage Medium and Directory” in section 9.3.

- **Specifying the File to Be Displayed in the File List Dialog Box**

You can specify the file to be displayed in the File List dialog box.

- **Item**

The list of files corresponding to the file type (Setup, Wave, or Numeric) that is specified for File Item in the File menu, in the selected directory, is displayed.

- **All**

The list of all the files in the selected directory is displayed.

- **Properties**

Displays the following information about the selected file: filename.extension, the file size, the date the file was saved, the attribute, the comment, etc.

- **Selecting the File Attribute**

Select the file attribute of each file from the following.

- **R/W**

Read and write.

- **R**

Read only. Cannot write to the file or delete the file.

### Note

---

- You cannot change a directory attribute.
  - The number of directories and files that can be displayed in the file list is 2500. If the number of directories and files in a directory exceeds 2500, the file list randomly displays 2500 of the directories and files.
  - Files that do not have an archive attribute are not displayed in the File List window. Do not remove the archive attribute of the files saved by the WT3000 using your PC.
  - Up to 41 characters can be displayed in the path. If the path exceeds 41 characters, “...” is displayed at the end of the character string.
  - File names are not case-sensitive. Comments are case-sensitive. In addition, the following names cannot be used due to limitations of MS-DOS.  
AUX, CON, PRN, NUL, CLOCK, COM1 to COM9, and LPT1 to LPT9
-

## 9.7 Deleting Files

### CAUTION

Do not remove the PC card or USB memory or turn OFF the power when the access indicator or icon of the PC card or USB memory is blinking. This can damage the PC card or USB memory or destroy the data on the it.

### Procedure

To exit the menu during operation, press **ESC** located above the soft keys.

In the procedural explanation below, the phrase “press the **cursor keys**” may be used. This phrase refers to the procedures for selecting items and entering values and character strings. For details on the procedures, see section 3.14.

1. Press **FILE** to display the File menu.
2. Press the **Utility** soft key. The Utility menu and the File List dialog box appear.
3. Press the **Function** soft key to display the Function menu.
4. Press the **Delete** soft key to display the Delete menu.

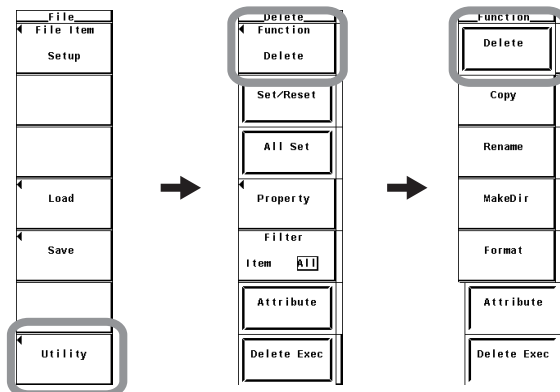

- **Selecting the Storage Medium and Directory**

5. The procedure is the same as that given in “Selecting the Storage Medium” and “Selecting the Save Destination Directory” in section 9.3.

- **Specifying the File to Be Displayed in the File List Dialog Box**

6. The procedure is the same as that given in “Specifying the File to Be Displayed in the File List Dialog Box” in section 9.6.

- **Viewing the Properties**

7. The procedure is the same as that given in “Viewing the Properties” in section 9.6.

- **Selecting the File Attribute**

8. The procedure is the same as that given in “Selecting the File Attribute” in section 9.6.

- **Selecting the File to Be Deleted One at a Time**

9. Press the **cursor keys** to select the file.
10. Press the **Set/Reset** soft key. If an asterisk is displayed to the left of the file name in the File List window, the file will be deleted. If the asterisk to the left of the file name disappears, the file will not be deleted.

Proceed to step 12.

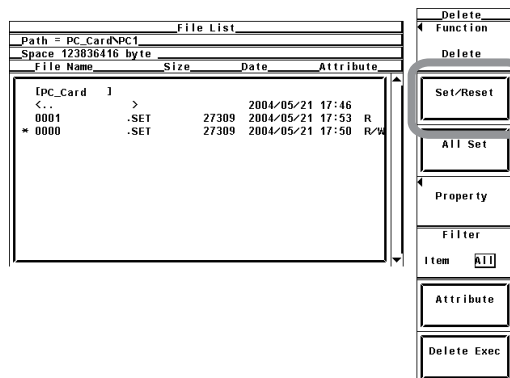

- **Selecting the Files to Be Deleted at Once**

9. Press the **cursor keys** to select a file, directory, or storage medium.
10. Press the **All Set** soft key. Asterisks appear to the left of the directory containing the selected file and all the files in the directory, the selected directory and all the files in the directory, or all the directories and files in the selected storage medium. The corresponding items will be deleted. At the same time, the All Set key changes to the All Reset soft key.
11. Press the **All Reset** soft key. Asterisks to the left of the directory containing the selected file and all the files in the directory, the selected directory and all the files in the directory, or all the directories and files in the selected storage medium disappear. The corresponding items will not be deleted. At the same time, the All Reset soft key changes to the All Set soft key.

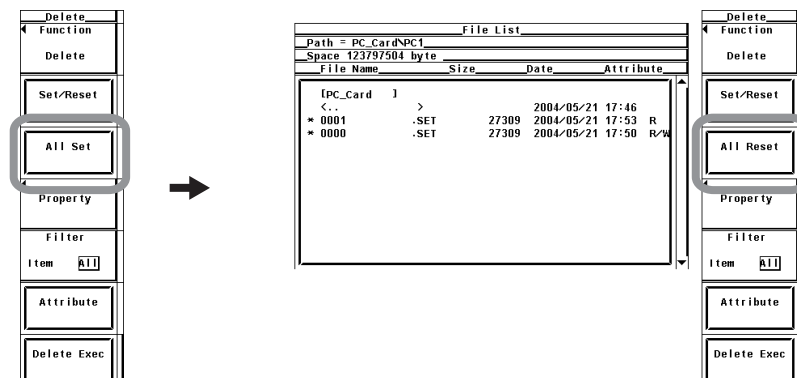

- **Executing the Delete Operation**

12. Press the **Delete Exec** soft key. All files with asterisk marks are deleted.

### Explanation

- **Selecting the Storage Medium and Directory**

The explanation is the same as that given in “Selecting the Storage Medium and Directory” in section 9.3.

- **Specifying the File to Be Displayed in the File List Dialog Box**

The explanation is the same as that given in “Specifying the File to Be Displayed in the File List Dialog Box” in section 9.6.

- **Properties**

The explanation is the same as that given in “Properties” in section 9.6.

- **Selecting the File Attribute**

The explanation is the same as that given in “Selecting the File Attribute” in section 9.6.

- **Selecting the Files to Be Deleted**

- By placing asterisk marks to the left of the file names, those files can be deleted.
- There are two ways to select the files to be deleted.
  - Selecting the files one at a time  
Press the Set/Reset soft key to place an asterisk mark to the left of the files one at a time.
  - Selecting the files at once  
Press the All Set soft key to place asterisk marks to the left of the selected file names at once. There are three methods in selecting the files at once.
    - If you select a file and press the All Set soft key, asterisk marks are placed by the directory containing the selected file and all the files in the directory.
    - If you select a directory and press the All Set soft key, asterisk marks are placed by the selected directory and all the files in the directory.
    - If you select a storage medium and press the All Set soft key, asterisk marks are placed by all the directories and files in the selected storage medium.

### Note

---

- Data that is deleted cannot be recovered. Be sure you erase the correct files.
  - You can delete directories if there are no files in them.
  - If the file attribute (see section 9.6) is “R,” you cannot delete the file.
  - If an error occurs while deleting multiple files, the files after the error occurrence are not deleted.
  - The number of directories and files that can be displayed in the file list is 2500. If the number of directories and files in a directory exceeds 2500, the file list randomly displays 2500 of the directories and files.
  - Files that do not have an archive attribute are not displayed in the File List window. Do not remove the archive attribute of the files saved by the WT3000 using your PC.
  - Up to 41 characters can be displayed in the path. If the path exceeds 41 characters, “...” is displayed at the end of the character string.
-

## 9.8 Copying Files

### CAUTION

Do not remove the PC card or USB memory or turn OFF the power when the access indicator or icon of the PC card or USB memory is blinking. This can damage the PC card or USB memory or destroy the data on the it.

### Procedure

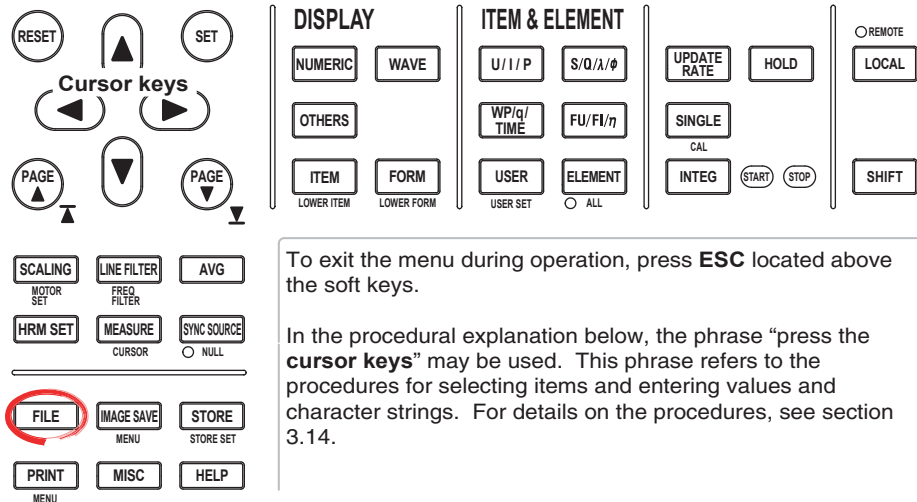

1. Press **FILE** to display the File menu.
2. Press the **Utility** soft key. The Utility menu and the File List dialog box appear.
3. Press the **Function** soft key to display the Function menu.
4. Press the **Copy** soft key to display the Copy menu.

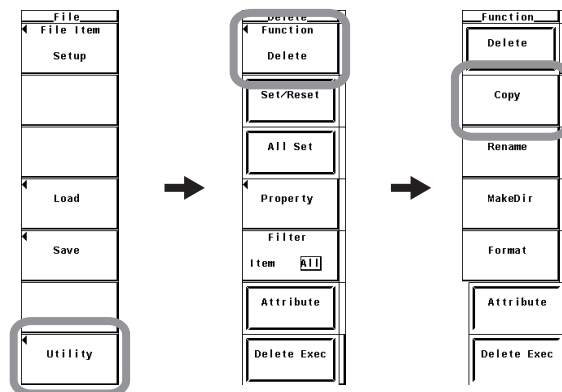

- **Selecting the Copy Source Storage Medium or Directory**

5. The procedure is the same as that given in “Selecting the Storage Medium” and “Selecting the Save Destination Directory” in section 9.3.



## 9.8 Copying Files

- **Specifying the File to Be Displayed in the File List Dialog Box**

6. The procedure is the same as that given in “Specifying the File to Be Displayed in the File List Dialog Box” in section 9.6.

- **Viewing the Properties**

7. The procedure is the same as that given in “Viewing the Properties” in section 9.6.

- **Selecting the File Attribute**

8. The procedure is the same as that given in “Selecting the File Attribute” in section 9.6.

- **Selecting the Copy Source Files One at a Time**

9. Press the **cursor keys** to select the file.

10. Press the **Set/Reset** soft key. If an asterisk is displayed to the left of the file name in the File List dialog box, the file will be copied. If the asterisk to the left of the file name disappears, the file will not be copied.

Proceed to step 12.

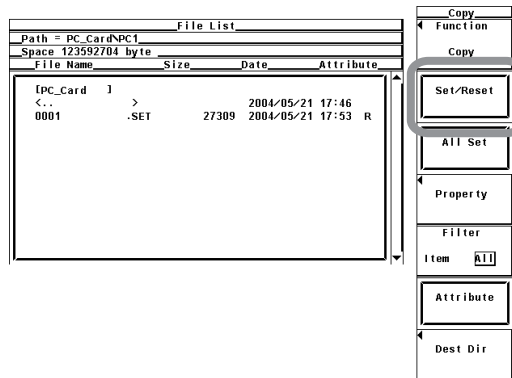

- **Selecting the Copy Source Files at Once**

9. Press the **cursor keys** to select a file, directory, or storage medium.

10. Press the **All Set** soft key. Asterisks appear to the left of the directory containing the selected file and all the files in the directory, the selected directory and all the files in the directory, or all the directories and files in the selected storage medium. The corresponding items will be copied. At the same time, the All Set soft key changes to the All Reset soft key.

11. Press the **All Reset** soft key. Asterisks to the left of the directory containing the selected file and all the files in the directory, the selected directory and all the files in the directory, or all the directories and files in the selected storage medium disappear. The corresponding items will not be copied. At the same time, the All Reset soft key changes to the All Set soft key.

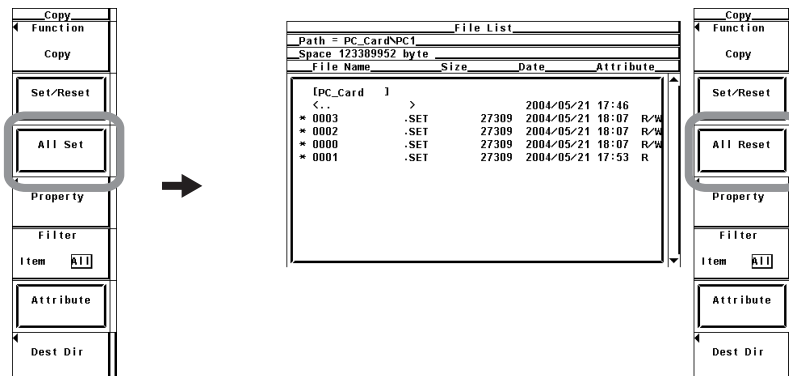

- **Selecting the Copy Destination**

12. Press the **Dest Dir** soft key. The copy execution menu and the copy destination File List dialog box appear.

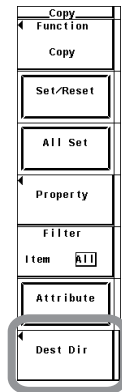

- **Selecting the Copy Destination Storage Medium or Directory**

13. The procedure is the same as that given in “Selecting the Storage Medium” and “Selecting the Save Destination Directory” in section 9.3.

- **Executing the Copy Operation**

14. Press the **Copy Exec** soft key. All the copy source files with asterisk marks are copied.

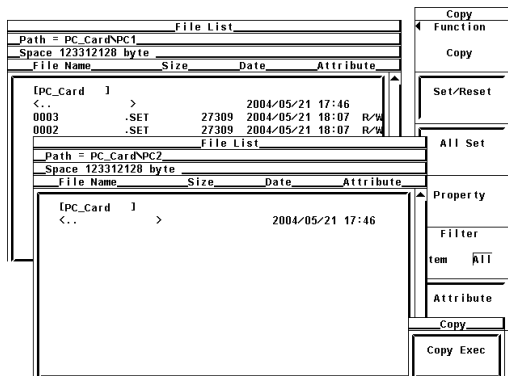

### Explanation

- **Selecting the Copy Source/Destination Storage Medium and Directory**  
The explanation is the same as that given in “Selecting the Storage Medium and Directory” in section 9.3.
- **Specifying the File to Be Displayed in the File List Dialog Box**  
The explanation is the same as that given in “Specifying the File to Be Displayed in the File List Dialog Box” in section 9.6.
- **Properties**  
The explanation is the same as that given in “Properties” in section 9.6.
- **Selecting the File Attribute**  
The explanation is the same as that given in “Selecting the File Attribute” in section 9.6.
- **Selecting the Copy Source Files**
  - By placing asterisk marks to the left of the file names, those files can be copied.
  - There are two methods in selecting the files to be copied.
    - Selecting the files one at a time  
Press the Set/Reset soft key to place an asterisk mark to the left of the files one at a time.
    - Selecting the files at once  
Press the All Set soft key to place asterisk marks to the left of the selected file names at once. There are three methods in selecting the files at once.
      - If you select a file and press the All Set soft key, asterisk marks are placed by the directory containing the selected file and all the files in the directory.
      - If you select a directory and press the All Set soft key, asterisk marks are placed by the selected directory and all the files in the directory.
      - If you select a storage medium and press the All Set soft key, asterisk marks are placed by all the directories and files in the selected storage medium.

### Note

---

- You cannot copy files if files with the same file name exist at the copy destination.
  - You cannot copy the same files to another directory after copying the files. Select the files to be copied again and copy them.
  - If an error occurs while copying multiple files, the files after the error occurrence are not copied.
  - The number of directories and files that can be displayed in the file list is 2500. If the number of directories and files in a directory exceeds 2500, the file list randomly displays 2500 of the directories and files.
  - Files that do not have an archive attribute are not displayed in the File List window. Do not remove the archive attribute of the files saved by the WT3000 using your PC.
  - Up to 41 characters can be displayed in the path. If the path exceeds 41 characters, “...” is displayed at the end of the character string.
-

## 9.9 Renaming Files or Directories and Creating Directories

### CAUTION

Do not remove the PC card or USB memory or turn OFF the power when the access indicator or icon of the PC card or USB memory is blinking. This can damage the PC card or USB memory or destroy the data on the it.

### Procedure

**Cursor keys**

**DISPLAY**

NUMERIC    WAVE

OTHERS

ITEM    FORM

LOWER ITEM    LOWER FORM

**ITEM & ELEMENT**

U/I/P    S/O/λ/φ

WP/q/TIME    FU/FI/η

USER    ELEMENT

USER SET    ○ ALL

UPDATE RATE    HOLD

SINGLE CAL

INTEG (START) (STOP)

○ REMOTE LOCAL

SHIFT

To exit the menu during operation, press **ESC** located above the soft keys.

In the procedural explanation below, the phrase “press the **cursor keys**” may be used. This phrase refers to the procedures for selecting items and entering values and character strings. For details on the procedures, see section 3.14.

1. Press **FILE** to display the File menu.
2. Press the **Utility** soft key. The Utility menu and the File List dialog box appear.
3. Press the **Function** soft key to display the Function menu.

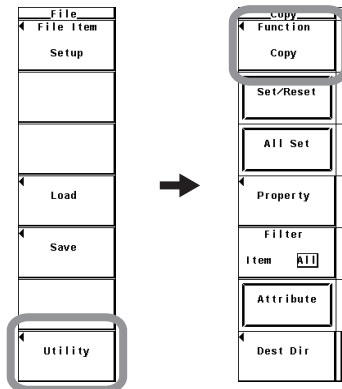

## 9.9 Renaming Files or Directories and Creating Directories

### Renaming a Directory or File

- Press the **Rename** soft key to display the Rename menu.

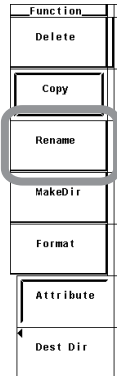

- Selecting the Storage Medium and Directory**

- The procedure is the same as that given in “Selecting the Storage Medium” and “Selecting the Save Destination Directory” in section 9.3.

- Specifying the File to Be Displayed in the File List Dialog Box**

- The procedure is the same as that given in “Specifying the File to Be Displayed in the File List Dialog Box” in section 9.6.

- Viewing the Properties**

- The procedure is the same as that given in “Viewing the Properties” in section 9.6.

- Selecting the File Attribute**

- The procedure is the same as that given in “Selecting the File Attribute” in section 9.6.

- Renaming a Directory or File**

- Press the **cursor keys** to select the directory or file.
- Press the **File Name** soft key. A keyboard appears. The name of the selected directory or file is displayed in the entry box of the keyboard.
- Use the **keyboard** to enter the directory or file name.

For keyboard operations, see section 3.14, “Entering Values and Strings.”

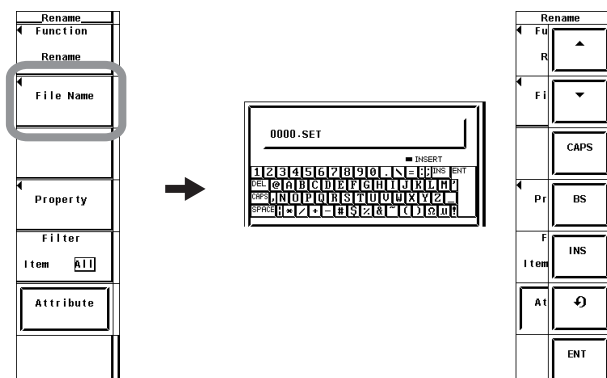

Creating a Directory

- Press the **MakeDir** soft key to display the MakeDir menu.

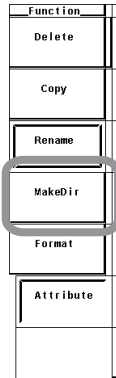

- Selecting the Storage Medium and Directory**

- The procedure is the same as that given in “Selecting the Storage Medium” and “Selecting the Save Destination Directory” in section 9.3.

- Specifying the File to Be Displayed in the File List Dialog Box**

- The procedure is the same as that given in “Specifying the File to Be Displayed in the File List Dialog Box” in section 9.6.

- Viewing the Properties**

- The procedure is the same as that given in “Viewing the Properties” in section 9.6.

- Selecting the File Attribute**

- The procedure is the same as that given in “Selecting the File Attribute” in section 9.6.

- Creating a Directory**

- Press the **cursor keys** to select the storage medium or a directory.
- Press the **Dir Name** soft key. A keyboard appears.
- Use the **keyboard** to enter the directory name.

For keyboard operations, see section 3.14, “Entering Values and Strings.”

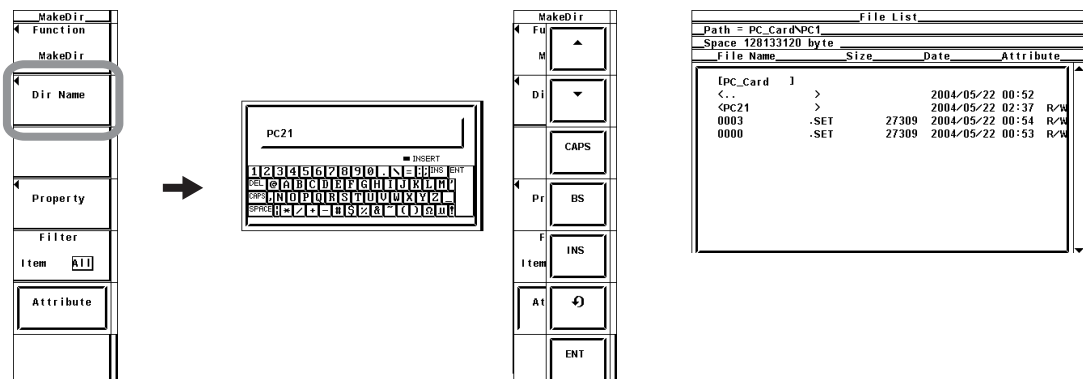

### Explanation

- **Selecting the Storage Medium and Directory**  
The explanation is the same as that given in “Selecting the Storage Medium and Directory” in section 9.3.
- **Specifying the File to Be Displayed in the File List Dialog Box**  
The explanation is the same as that given in “Specifying the File to Be Displayed in the File List Dialog Box” in section 9.6.
- **Properties**  
The explanation is the same as that given in “Properties” in section 9.6.
- **Selecting the File Attribute**  
The explanation is the same as that given in “Selecting the File Attribute” in section 9.6.
- **Renaming a Directory or File**  
The method for setting the name when renaming a directory or file is the same as the explanation given in “File Name and Comment” in section 9.3.
- **Creating Directories**  
You can create a new directory on the storage medium. The method for setting the name when creating a directory is the same as the explanation given in “File Name and Comment” in section 9.3.

### Note

---

- You cannot change a directory attribute.
  - If a file with the same name already exists in the same directory, the file cannot be renamed.
  - If a directory with the same name already exists in the same directory, the directory cannot be created.
  - The number of directories and files that can be displayed in the file list is 2500. If the number of directories and files in a directory exceeds 2500, the file list randomly displays 2500 of the directories and files.
  - Files that do not have an archive attribute are not displayed in the File List window. Do not remove the archive attribute of the files saved by the WT3000 using your PC.
  - Up to 41 characters can be displayed in the path. If the path exceeds 41 characters, “...” is displayed at the end of the character string.
  - Directory names are not case-sensitive. Comments are case-sensitive. In addition, the following names cannot be used due to limitations of MS-DOS.  
AUX, CON, PRN, NUL, CLOCK, COM1 to COM9, and LPT1 to LPT9
-

# 10.1 Zero-Level Compensation

## Procedure

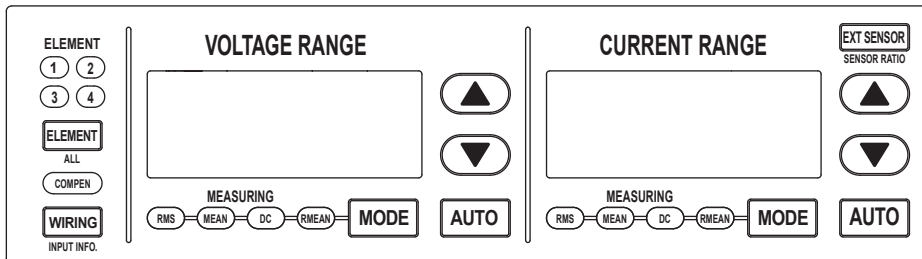

To exit the menu during operation, press **ESC** located above the soft keys.

In the procedural explanation below, the phrase “press the **cursor keys**” may be used. This phrase refers to the procedures for selecting items and entering values and character strings. For details on the procedures, see section 3.14.

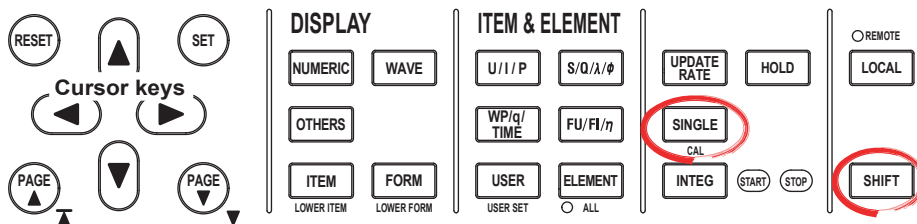

Press **SHIFT+SINGLE (CAL)**. Zero-level compensation is executed.

## Explanation

### Zero-Level Compensation

This function is used to create a zero input condition using the internal circuit of the instrument and setting the level at that point to zero level. Zero-level compensation must be performed to meet the specifications of this instrument (see chapter 12).

- Pressing CAL executes the zero-level compensation.
- Zero-level compensation is automatically performed after changing the measurement range or input filter.

### Note

- For making accurate measurements, it is recommended that zero-level compensation be performed after warming up the instrument for at least 30 minutes. In addition, the ambient temperature needs to be within the specifications (see chapter 12) and stable.
- If the measurement range and input filter are not changed over a long period of time, the zero level may change due to the changes in the environment surrounding the instrument. It is recommended that zero-level compensation be performed in this case.
- There are functions that automatically perform zero-level compensation during integration. See section 5.13.



## 10.2 NULL Function

### Procedure

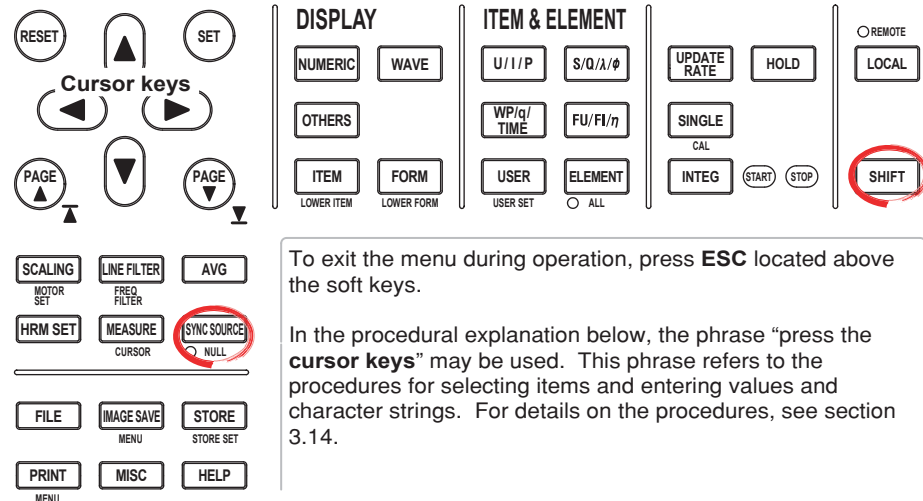

- **Activating the NULL Function**

1. Press **SHIFT+SYNC SOURCE(NULL)**. The NULL indicator to the lower left of the key illuminates when the NULL function operates and the measured values are updated.

- **Clearing the NULL Function**

2. Press **SHIFT+SYNC SOURCE (NULL)** when the NULL function is activated. The NULL indicator turns OFF and the NULL function is released.

### Explanation

The NULL function can be used to subtract the DC offset while the external sensor or measurement cable is connected. Execute the NULL function at no input condition (opened current input terminal and shorted voltage input terminal).

- **NULL Value**

The NULL values are set to the  $U_{dc}$  and  $I_{dc}$  values (numeric data of the simple average of voltage/current) as well as speed and torque (on models with the motor evaluation function when the input signal from the sensor is analog) that were measured the previous time when the voltage/current mode is set to DC and the NULL function is turned ON. If the previously measured  $U_{dc}$  and  $I_{dc}$  as well as Speed and Torque values do not exist, such as when the NULL function is turned ON without making a measurement after turning ON the power,  $U_{dc}$  and  $I_{dc}$  are set to zero. To subtract the DC offset using the NULL function when making measurements with the voltage/current mode set to RMS, MEAN, or RMEAN, activate the NULL function with the voltage/current mode set to DC and then change the voltage/current mode to RMS, MEAN, or RMEAN.

### Note

- The NULL function is automatically released when the range or filter setting is changed or integration is started.
- If you perform the procedure of releasing the NULL function while in the hold condition, the NULL function is actually released and the NULL indicator turns OFF when the hold is released or when a single measurement is made.
- If the crest factor is set to 3, a NULL value of approximately 50% is set for a signal that exceeds 50% of the range. If the crest factor is set to 6, a NULL value of approximately 100% is set for a signal that exceeds 100% of the range.

- **Measurement Functions Affected by the NULL Function**

The NULL value is subtracted from the sampled data. Hence, all measurement functions are affected by the NULL values.

- **Limitations on the NULL Function by Measurement Modes**

The NULL function cannot be used in the following measurement modes.

- Wide bandwidth harmonic measurement mode
- IEC harmonic measurement mode
- Voltage fluctuation and flicker measurement mode
- Cycle-by-cycle measurement mode

# 10.3 Selecting the Sampling Frequency

## Procedure

To exit the menu during operation, press **ESC** located above the soft keys.

In the procedural explanation below, the phrase “press the **cursor keys**” may be used. This phrase refers to the procedures for selecting items and entering values and character strings. For details on the procedures, see section 3.14.

1. Press **MEASURE** to display the Measure menu.
2. Press the **Sampling Frequency** soft key to display the Sampling Frequency menu.
3. Press any of the soft keys from **Auto**, **Clock A to C** to select the sampling frequency.

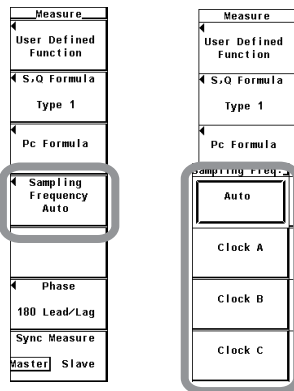

## Explanation

The frequency used to acquire the sampled data to compute the measurement functions can be selected.

- Auto: Automatically switches the following Clock A, B, and C.
- Clock A: Samples at 183.823 kHz.
- Clock B: Samples at 189.394 kHz.
- Clock C: Samples at 195.313 kHz.

### Note

- You can set the sampling frequency to Auto to prevent the measured data from becoming invalid due to aliasing (section 2.7).
- If you wish to fix the sampling frequency, select one of the frequency settings above.
- The sampling frequency is automatically set to 200 kHz in waveform computation, FFT, voltage fluctuation and flicker measurement, and cycle-by-cycle measurement modes.

# 10.4 Selecting the Display Font

## Procedure

**Cursor keys**

**DISPLAY**

NUMERIC    WAVE

OTHERS

ITEM    FORM  
LOWER ITEM    LOWER FORM

**ITEM & ELEMENT**

U/I/P    S/Q/A/φ

WP/q/TIME    FU/Fl/η

USER    ELEMENT  
USER SET    ○ ALL

UPDATE RATE    HOLD

SINGLE  
CAL

INTEG    START    STOP

○ REMOTE  
LOCAL

SHIFT

SCALING    LINE FILTER    AVG  
MOTOR SET    FREQ FILTER

HRM SET    MEASURE    SYNC SOURCE  
CURSOR    ○ NULL

FILE    IMAGE SAVE    STORE  
MENU    STORE SET

PRINT    MISC    HELP  
MENU

To exit the menu during operation, press **ESC** located above the soft keys.

In the procedural explanation below, the phrase “press the **cursor keys**” may be used. This phrase refers to the procedures for selecting items and entering values and character strings. For details on the procedures, see section 3.14.

1. Press **MISC** to display the Misc menu.
2. Press the **Config** soft key to display the Config menu.
3. Press the **Font** soft key to display the Font menu.
4. Press the **Gothic** or **Roman** soft key to select the display font.

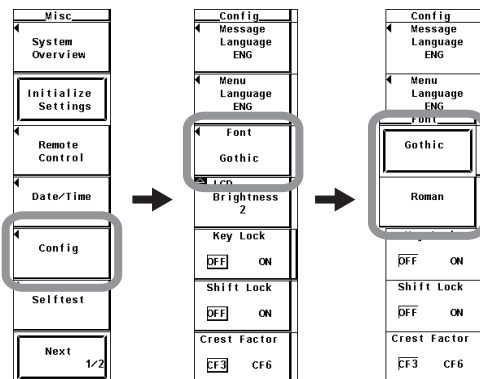

## 10.4 Selecting the Display Font

---

### Explanation

The font used to display characters and numbers can be selected.

- Gothic: A font with constant line width.
- Roman: A font in which the vertical lines are thicker than horizontal lines with emphasis at the beginning and end of the stroke.

### Note

---

Both the Gothic and Roman fonts used on the WT3000 are original fonts designed by YOKOGAWA. Therefore, the details of each font may differ from that of other devices.

---

# 10.5 Selecting the Screen Brightness

## Procedure

Cursor keys

DISPLAY: NUMERIC, WAVE, OTHERS, ITEM, FORM

ITEM & ELEMENT: U/I/P, S/Q/A/#, WP/q/TIME, FU/FI/η, USER, ELEMENT, LOWER ITEM, LOWER FORM, USER SET, ALL

UPDATE RATE, HOLD, SINGLE, CAL, INTEG, START, STOP, REMOTE, LOCAL, SHIFT

SCALING, LINE FILTER, AVG, HRM SET, MEASURE, SYNC SOURCE, CURSOR, NULL, FILE, IMAGE SAVE, STORE, MENU, STORE SET, PRINT, MISC, HELP, MENU

To exit the menu during operation, press **ESC** located above the soft keys.

In the procedural explanation below, the phrase “press the **cursor keys**” may be used. This phrase refers to the procedures for selecting items and entering values and character strings. For details on the procedures, see section 3.14.

1. Press **MISC** to display the Misc menu.
2. Press the **Config** soft key to display the Config menu.
3. Press the **cursor keys** to select a value between -1 and 3.

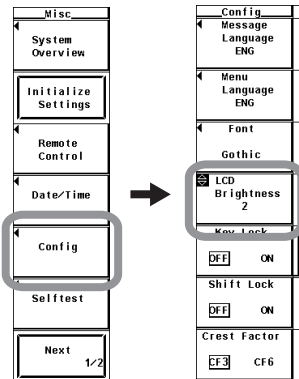

## Explanation

### Selecting the Screen Brightness

Select the screen brightness in the range of -1 to 3. The darkest setting is -1 and the brightest setting is 3.

# 10.6 Setting the Display Color

## Procedure

Cursor keys

DISPLAY: NUMERIC, WAVE, OTHERS, ITEM (LOWER ITEM), FORM (LOWER FORM)

ITEM & ELEMENT: U/I/P, S/Q/λ/φ, WP/q/TIME, FU/FI/η, USER (USER SET), ELEMENT (ALL)

UPDATE RATE, HOLD, LOCAL, SINGLE CAL, INTEG, START, STOP, SHIFT

SCALING (MOTOR SET), LINE FILTER (FREQ FILTER), AVG, HRM SET, MEASURE (CURSOR), SYNC SOURCE (NULL), FILE, IMAGE SAVE (MENU), STORE (STORE SET), PRINT (MENU), MISC, HELP

To exit the menu during operation, press **ESC** located above the soft keys.

In the procedural explanation below, the phrase “press the **cursor keys**” may be used. This phrase refers to the procedures for selecting items and entering values and character strings. For details on the procedures, see section 3.14.

1. Press **MISC** to display the Misc menu.
2. Press the **Next 1/2** soft key to display the Next 2/2 menu.

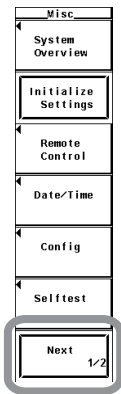

- **Setting the Graphic Color**

- **Selecting Default or User**

3. Press the **Graph Color** soft key to display the Graph Color menu.
4. Press the **cursor keys** to select Default or User.

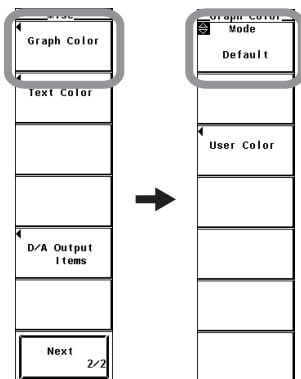

• **Setting User Colors**

3. Press the **User Color** soft key to display the Graph Color dialog box.
4. Press the **cursor keys** to select the item you wish to set.
5. Press **SET**. A box used to set the color level appears.
6. Press the **cursor keys** to set the color level.
7. Press **SET** or **ESC** to close the box.

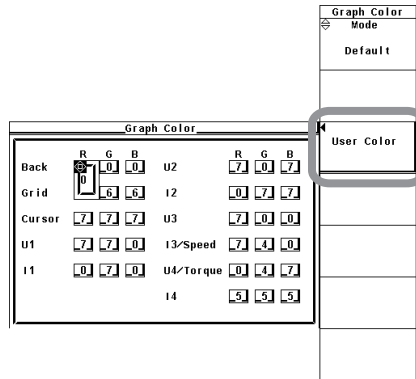

• **Setting the Text Color**

• **Selecting Preset or User**

3. Press the **Text Color** soft key to display the Text Color menu.
4. Press the **cursor keys** to select a value between Preset1 and User.

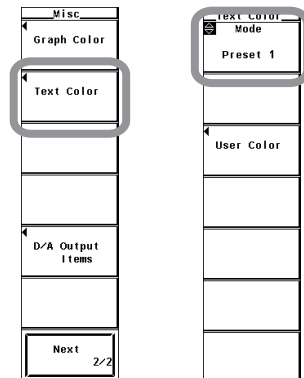

• **Setting User Colors**

3. Press the **User Color** soft key to display the Text Color dialog box.
4. Press the **cursor keys** to select the item you wish to set.
5. Press **SET**. A box used to set the color level appears.
6. Press the **cursor keys** to set the color level.
7. Press **SET** or **ESC** to close the box.



## 10.6 Setting the Display Color

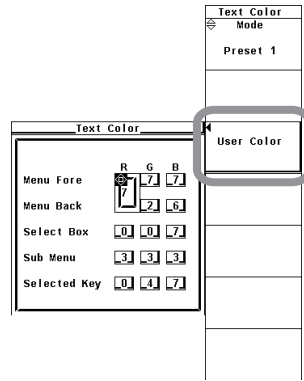

### Explanation

The display color for each item can be specified. Set the color using a ratio (0-7) of red (R), green (G), and blue (B).

#### • Setting the Graphic Color

Select default color or a user color.

For user color, the display color can be specified for each item.

- Back  
Set the background color within the waveform display frame.
- Grid  
Set the color of the grid within the waveform display frame and the waveform display frame.
- Cursor  
Set the display color of the cursor.
- U1 to I4, Speed\*, and Torque\*  
Set the display color of the waveform. I3 and Speed are set to the same display color. The same hold true for U4 and Torque.

\* Applicable only to products with the motor evaluation function (motor version).

#### • Setting the Text Color

Select from Preset1 to 3 and user setting.

For user color, the display color can be specified for each item.

- Menu Fore  
Set the color of the text on the menu, dialog box, window, and other screens.
- Menu Back  
Set the background color of the waveform display frame.
- Select Box  
Set the background color of the background within the selected menu frame and box.
- Sub Menu  
Set the display color of the selected dialog box or window.
- Selected Key  
Set the display color of the selected soft key or item.

# 10.7 Setting the Key Lock and Shift Lock Function

## Procedure

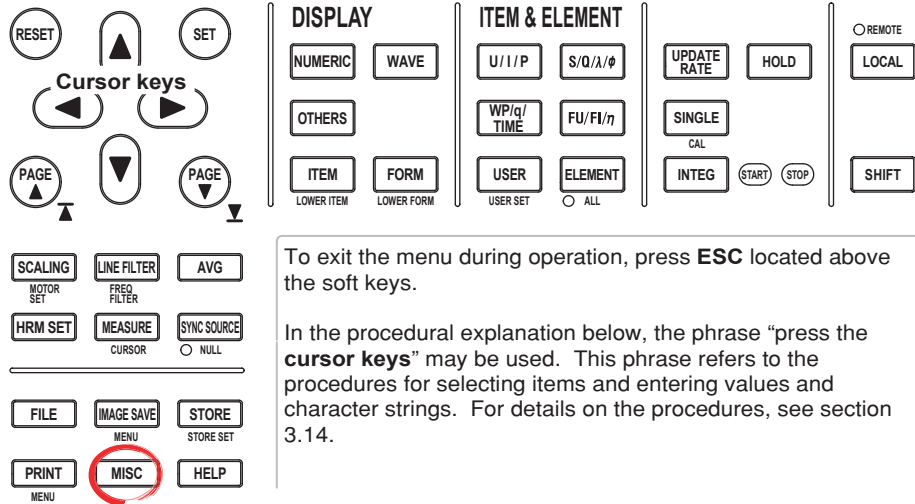

1. Press **MISC** to display the Misc menu.
2. Press the **Config** soft key to display the Config menu.

- **Setting Key Lock**

3. Press the **Key Lock** soft key to select ON or OFF.

- **Setting Shift Lock**

3. Press the **Shift Lock** soft key to select ON or OFF.

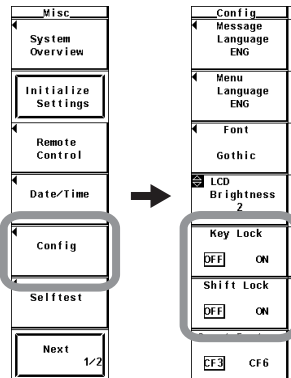

## 10.7 Setting the Key Lock and Shift Lock Function

---

### Explanation

- **Key Lock**

If key lock is turned ON, all keys except the power switch, MISC key, ESC key, and the 5th soft key from the top are disabled.

When key lock is ON, the word "Lock" is displayed at the upper right corner of the screen.

### Note

---

Key lock ON/OFF setting is held even when the power is turned OFF.

---

- **Turning the Shift Lock ON/OFF**

You can select whether the shifted condition is released after selecting a setup menu marked in purple below the key in the shifted condition (condition in which the Shift key is pressed).

- OFF

Releases the shifted condition.

- ON

Does not release the shifted condition. You can continue to select the setup menus marked in purple. To release the shifted condition, press the Shift key.

# 10.8 Help Function

## Procedure

To exit the menu during operation, press **ESC** located above the soft keys.

In the procedural explanation below, the phrase “press the **cursor keys**” may be used. This phrase refers to the procedures for selecting items and entering values and character strings. For details on the procedures, see section 3.14.

- **Displaying the Help Window**
  1. Press **HELP** to display the help window.
  2. Press the key or soft key that you wish to review.
- **Clearing the Help Window**
  3. Press **HELP** again. The help window disappears.

## Explanation

- **Displaying the Help Window**

When you press **HELP**, a help window containing information about the soft key menu that was displayed immediately before **HELP** was pressed appears.

If you press a key while the help window is displayed, a help window containing information about the key appears.
- **Clearing the Help Window**

If you press the **HELP** key again while a help window is displayed, the help window closes.

# 10.9 Master/Slave Synchronization Measurement

## Procedure

The diagram illustrates the instrument's soft key menu. At the top left are RESET, SET, and CURSOR keys (up, down, left, right). Below are PAGE keys. The main menu area includes: SCALING (MOTOR SET), LINE FILTER (FREQ FILTER), AVG, HRM SET, MEASURE (circled in red), SYNC SOURCE (CURSOR selected), FILE, IMAGE SAVE (MENU), STORE (STORE SET), PRINT (MENU), MISC, and HELP. To the right are columns for DISPLAY (NUMERIC, WAVE, OTHERS, ITEM, FORM), ITEM & ELEMENT (U/I/P, S/Q/λ/φ, WP/q/TIME, FU/FI/η, USER, ELEMENT), and other functions (UPDATE RATE, HOLD, LOCAL, SINGLE, CAL, INTEG, START, STOP, SHIFT). A text box on the right explains that pressing ESC exits the menu and that 'press the cursor keys' refers to the directional keys.

- **Selecting Master or Slave Mode**

1. Press **MEASURE** to display the Measure menu.
2. Press the **Sync Measure** soft key to select Master or Slave.

Only a single master and a single slave can be specified.

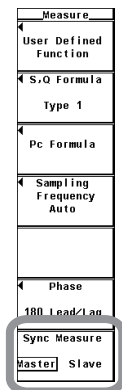

- **Performing Synchronized Measurements**

Connect the external start signal input/output connectors between the master and slave instruments using BNC cables (sold separately).

- The slave instrument starts its measurement at approximately the same time as the start of the measurement on the master instrument.
- The slave instrument stops its measurement at approximately the same time as the stop of the measurement on the master instrument.

**Explanation**

With the master instrument outputting measurement start signal and the slave instrument receiving the signal, synchronized measurement between two instruments is achieved.

• **External Start Signal Input/Output Connector**

Connect the external start signal input/output connectors on the rear panel between the master and slave instruments using BNC cables (sold separately).



Item	Specifications	Note
Connector type	BNC connector	Common to master and slave
I/O level	TTL	Common to master and slave
Output logic	⌋ (negative logic), falling edge	Applies to the master
Measurement start delay time	$1 \mu\text{s} + 1 \text{ sample interval}$	Applies to the master
Output hold time	Low level, 500 ns or more	Applies to the master
Input logic	⌋ (negative logic), falling edge	Applies to the slave
Minimum pulse width	Low level, 500 ns or more	Applies to the slave
Input delay time	During HOLD ON $1 \mu\text{s} + 1 \text{ sample interval}$ During HOLD OFF Within $63 \text{ ns} + 1 \text{ sample period}$	Applies to the slave

**Note**

The master and slave conditions in which synchronized measurement is not possible are as follows:

- The data update rate differs between the master and slave.
- During real-time integration mode or real-time store mode.

Carry out the hold operation according to the procedure below during synchronized measurement.

- Hold ON: Turn the hold function ON from the WT3000 set to master.
- Hold OFF: Turn the hold function OFF from the WT3000 set to slave.

• **Output Circuit for the External Start Signal and Time Chart**

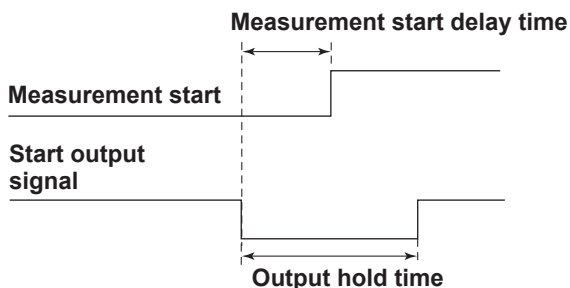
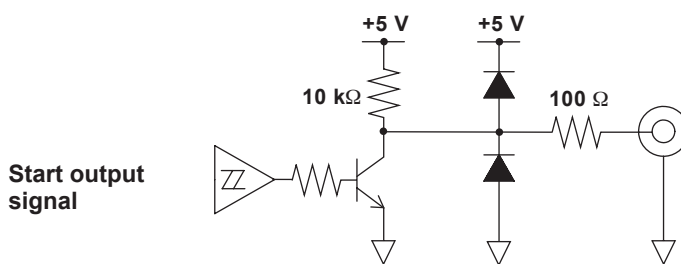

• **Input Circuit for the External Start Signal and Time Chart**

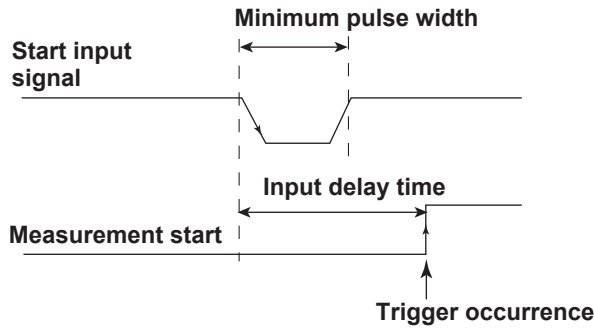
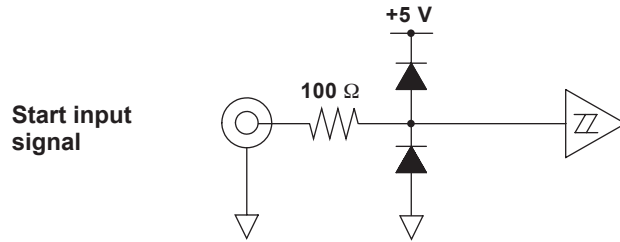

**CAUTION**

- When the instrument is set to master, do not apply external voltage to the external start signal input/output connector (START). If you do, the instrument may malfunction.
- Applying a voltage outside the 0 to 5 V range to the external start signal input/output connector when the instrument is set to slave may cause damage to the instrument.

- **Limitations on the Synchronized Measurement by Measurement Modes**  
Synchronized measurement cannot be used in the following measurement modes.
  - Wide bandwidth harmonic measurement mode
  - IEC harmonic measurement mode
  - Waveform computation mode
  - FFT mode
  - Voltage fluctuation and flicker measurement mode
  - Cycle-by-cycle measurement mode

# 11.1 Troubleshooting

## Troubleshooting

- If a message is displayed on the screen, read the following pages.
- If servicing is necessary, or if the instrument is not operating correctly after performing the corrective actions, contact your nearest YOKOGAWA dealer.

Problem and Corrective Action	Reference Section
Nothing shows up on the display when the power switch is turned ON.	
Securely connect the power cord to the power connector of the instrument and the power outlet.	3.3
Set supply voltage within the permitted range.	3.3
Check the display settings.	10.6
Check that the fuse is not blown.	11.5
The displayed data is not correct.	
Check that the ambient temperature and humidity are within the specifications.	3.2
Check that noise is not affecting the measurement.	3.1, 3.5
Check the wiring of the measurement cable.	3.8 to 3.11
Check the wiring system.	3.8 to 3.11, 4.1
Check that the line filter is turned OFF.	4.8
Check the measurement period settings.	4.7
Check the FAQ at the following URL. <a href="http://www.yokogawa.com/tm/">http://www.yokogawa.com/tm/</a>	–
Power cycle the instrument.	3.4
Keys do not work.	
Check the REMOTE indicator. If the REMOTE indicator is ON, press the LOCAL key to turn it OFF.	–
Check that key lock is OFF.	10.7
Perform a key test. If it fails, servicing is required.	11.3
Triggering does not work.	
Check the trigger conditions.	6.4
Check that the trigger source is being applied.	6.4
Unable to make harmonic measurements.	
Check the PLL source settings.	–*1
Check that the PLL source input signal is within the specifications.	–*1
Unable to print on the built-in printer.	
The printer head may be damaged or worn out. Servicing required.	–
Unable to recognize the medium.	
Check the format of the medium. If necessary, format the medium.	9.2
The medium may be damaged.	–
Unable to save data to the selected medium.	
If necessary, format the storage medium.	9.2
Check the free space on the medium. Remove unnecessary files as necessary or use a new medium.	9.2
Unable to set or control the instrument via the communication interface.	
Check that the GP-IB address or the parameter settings of the serial interface satisfy the specifications.	–*2
Check that the interface satisfies the electrical and mechanical specifications.	–*2

\*1 See the *Expansion Function User's Manual IM760301-51E*.

\*2 See the *Communication Interface User's Manual IM760301-17E*.



## 11.2 Error Messages and Corrective Actions

### Error Messages

There are cases in which error messages are displayed on the screen during operation. This section describes the meanings of the messages and their corrective actions. The messages can be displayed either in English or Japanese (see section 3.18). If the corrective action requires servicing, contact your nearest YOKOGAWA dealer for repairs.

In addition to the error messages listed below, there are communication error messages. These messages are described in the *Communication Interface User's Manual (IM760301-17E)*.

### Error in Execution

Code	Message	Corrective Action	Reference Section
11	Cannot measure PLL frequency.	Check input level.	*
601	Invalid file name.	Check the file name.	9.3, 9.4
602, 603	No USB device or no storage media inserted.	Check the USB device connection, and the existence of a storage medium in the device.	9.1
604	Media failure.	Check the storage medium.	–
605	File not found.	Check the file name and the storage medium.	–
606	Media is protected.	Set the disk's (medium's) write protect switch to OFF.	–
607	Media was removed while accessing.	Check the storage medium.	–
608, 609	File already exists.	–	9.3
610	Contains invalid characters.	–	9.3
611, 612	Media full.	Delete unnecessary file(s) or use another disk.	9.2 to 9.7
613	Cannot delete a directory if there are files in the directory.	Delete all the files in the directory to be deleted.	9.7
614	File is protected.	–	9.6
615	Physical format error.	Reformat the medium. If the same error occurs, the instrument is probably unable to execute a format on this medium.	9.2
616 to 620	File system failure.	Check using another disk. If the same message still appears, maintenance service is required.	–
621	File is damaged.	Check the file.	–
622 to 641	File system failure.	Check using another disk. If the same message still appears, maintenance service is required.	–
643 to 653	Media failure.	Check the medium.	–
655 to 664	File system failure.	Check using another disk. If the same message still appears, maintenance service is required.	–
665	Cannot load this file format. File was stored on other models or other versions.	–	–
666	File is now being accessed.	Execute after access is made.	–
671	Save data not found.	Check for presence of data.	9.3, 9.4
674	Initializing file system.	Please wait.	9.2
675	Cannot load this file. Model/options do not conform.	–	–
679	Printer error.	Maintenance service is required.	–
680	Close the cover of the printer unit.	–	*
681	Paper empty.	Load a roll chart.	*

\* See the *Communication Interface User's Manual IM760301-17E*.

Code	Message	Corrective Action	Reference Section
682, 683	Printer over heat.	Power off immediately.	–
684	No built-in printer on this model.	Check the specifications to see whether or not the optional printer is provided.	Page ii
685	Printer time out.	Maintenance service is required.	–
705	Can not operate while accessing medium.	Wait until access has completed.	–
706	Can not operate during hard copy.	Wait until output has completed.	–
710	File not found.	Check the file.	–
711	File operation not allowed during hard copy.	Wait until the hard copy completes.	–
712	Can not compress this hardcopy image.	Turn off compression switch.	9.4
750	Cannot connect to the ftp server.	Confirm the network settings and connection.	–*1
751	Has not connect with ftp server yet.	Confirm the network settings and connection.	–*1
752	This ftp function in not supported.	–	–*1
753	FTP Error: Pwd	Confirm the network settings and connection.	–*1
754	FTP Error: Cwd	Confirm the network settings and connection.	–*1
755	FTP Error: Rm	Confirm the network settings and connection.	–*1
756	FTP Error: List	Confirm the network settings and connection.	–*1
757	FTP Error: Mkdir	Confirm the network settings and connection.	–*1
758	FTP Error: Rmdir	Confirm the network settings and connection.	–*1
759	FTP Error: Get	Confirm the network settings and connection.	–*1
760	FTP Error: Put	Confirm the network settings and connection.	–*1
761	FTP Error: GetData	Confirm the network settings and connection.	–*1
762	FTP Error: PutData	Confirm the network settings, connection, and disk capacity.	–*1
763	FTP Error: AppendData	Confirm the network settings, connection, and disk capacity.	–*1
764	FTP Error: Client Handle	Confirm the network settings and connection.	–*1
765	FTP Error: Others	Confirm the network settings and connection.	–*1
770	Failed to acquire time from SNTP server.	Confirm the network settings and connection.	–*1
785	Cannot send data to a network printer.	Confirm the network settings and connection.	–*1
786	Cannot send a mail.	Confirm the network settings and connection.	–*1
797	Connecting to a NetDrive.	Wait until connection has been established.	–
798	Failed to initialize network.	Confirm the network settings.	–*2
799	The second time password input is different from the first time.	Please repeat the second time password input.	–*2

\*1 See the *Expansion Function User's Manual IM760301-51E*.

\*2 See the *Communication Interface User's Manual IM760301-17E*.

### Error in Setting

Code	Message	Corrective Action	Reference Section
800	Illegal date-time.	Set the correct date and time.	3.12
801	Illegal file name.	The file name contains characters which are not allowed or the file name is not a valid MS-DOS file name. Enter another file name.	9.3
802	Cannot be set or executed in the Normal measurement mode.	–	–
803	Cannot be set or executed in the IEC Harmonics measurement mode.	–	–
804	Cannot be set or executed in the Wide-Band Harmonics measurement mode.	–	–
805	Cannot be set or executed in the Math measurement mode.	–	–

## 11.2 Error Messages and Corrective Actions

Code	Message	Corrective Action	Reference Section
806	Cannot be set or executed in the FFT measurement mode.	–	–
807	Cannot be set or executed in the Cycle by Cycle measurement mode.	–	–*
808	Cannot change this parameter during numerical display.	–	–
809	Cannot change this parameter during vector display.	–	–
810	Cannot change this parameter during bar graph display.	–	–
812	Cannot be set while storing/recalling of data being performed.	–	–
813	Cannot be set while integration is running.	Reset Integration.	5.14
820	Cannot be set or executed in the Flicker measurement mode.	–	–*
821	Attempt made to start flicker measurement while flicker initialization is not finished.	Wait for the initialization to finish and the WT3000 to become ready. Then, start the measurement.	–*
822	Attempt made to start flicker measurement while flicker measurement is in progress or result of flicker judgement is displayed.	Reset the flicker measurement, wait for the initialization to finish, and start the measurement.	–*
823	Cannot change during CAL.	Wait until CAL is completed.	10.1
824	Attempt made to initialize flicker measurement while flicker measurement is in progress or result of flicker judgement is displayed.	Reset the flicker measurement and then execute initialization.	–*
825	Cannot change limit settings while flicker measurement is in progress.	Can be changed only when the measurement is reset or while the judgement result is being displayed.	–*
826	Cannot be set or executed when flicker measurement is not reset.	Reset the flicker measurement.	–*
827	Illegal math expression.	Input a correct computing equation.	5.4
828	Cannot start flicker measurement when all periods of dmax measurement are finished.	Perform judgement or move the observation period if necessary and measure again.	–*
829	Cannot judge flicker measurement until all periods of dmax measurement are finished.	Perform judgement after the dmax measurement of all observation periods is finished.	–*
830	Cannot move period while flicker measurement is not ready.	–	–*
831	Processing now.	Retry setting or execution again.	–*
836	Cannot be set or executed while Cycle by Cycle measurement is not reset.	Reset the cycle-by-cycle measurement.	–*
841	Attempted to start integration after integration time has reached its preset value.	Reset Integration.	5.14
842	Attempted to start integration while integration is in progress.	–	5.14
843	Measurement stopped due to overflow during integration or due to a power failure.	Reset Integration.	5.14
844	Attempted to stop integration even though integration was not in progress.	–	5.14
845	Attempted to start integration while integration was in progress or integration mode was not selected.	–	5.14
846	Attempted to start integration while measurement of peak overflow was in progress.	–	5.14
847	Attempted to start integration in continuous integration mode when integration preset time was set to "0".	–	5.11

## 11.2 Error Messages and Corrective Actions

Code	Message	Corrective Action	Reference Section
848	Attempted made to start integration in real time counting integration mode when the end time had already passed.	–	5.12
849	Attempted made to start storing in real time counting storing mode when the end time had already passed.	–	8.3
850	Stored file already exists. Initialize memory before storing.	–	8.4
851	Stored file and measurement mode are different. Set the appropriate measurement mode before recalling.	–	8.3
852	Stored file is illegal. Initialize memory before storing.	–	8.4
853	Cannot be executed/set during Recall mode. Set the Mode to Store.	–	8.1
854	Waveform display data not found.	–	–
855	Storing memory is full. Storing has been stopped.	–	8.4
856	An error has occurred while storing. Storing has been stopped.	–	–
857	Cannot be set while Master/Slave Synchronized Measurement is set to Slave.	–	10.9
858	Store/Recall process is in progress now.	Execute or set setting again.	8.4, 8.6
860	Cannot be set or executed while accessing Acquisition memory.	Wait until access has completed.	–
861	Acquisition data not found.	–	–
862	Numeric data not found.	–	–*
864	This wiring cannot be set as the first selected element.	–	4.1
865	Cannot be set while integration is running.	Stop or reset Integration.	–
866	Cannot be set or executed while Auto Print is operating.	Turn off Auto Print from the [PRINT MENU] (SHIFT+PRINT) menu.	–*
867	Auto Print is not in operation.	Start Auto Print from the [PRINT MENU] (SHIFT+PRINT).	–*
868	Print out destination must be set to Built-in Printer in order to start Auto Print.	Set [Print to] to Built-in from the [PRINT MENU] (SHIFT+PRINT) menu.	–*
869	Auto Print function is not supported in the current measurement mode or settings.	–	–*
870	Auto Print [Interval] setting is invalid.	Set [Interval] time to an appropriate amount from the [PRINT MENU](SHIFT+PRINT) -> [Auto Print Settings] menu.	–*
871	Attempted made to start Auto Print when the end time had already passed.	Set [End Time] to a future date & time from the [PRINT MENU](SHIFT+PRINT) -> [Auto Print Settings] menu.	–*
872	Auto print's print-out has been canceled. The printer or file system is in action.	–	–*

\* See the *Communication Interface User's Manual IM760301-17E*.

## 11.2 Error Messages and Corrective Actions

---

### Error in System Operation

Code	Message	Corrective Action	Reference Section
901	Failed to backup setup data.	The system has been initialized. Maintenance service is required.	3.4
902	System RAM failure.	Maintenance service is required.	–
903	System ROM failure.	Maintenance service is required.	–
904	System RAM failure.	Maintenance service is required.	–
906	Fan stopped.	Power off immediately. Maintenance service is required.	–
909	Illegal SUM value.	Maintenance service is required.	–
910	RAM read/write error.	Maintenance service is required.	–
911	Memory bus error.	Maintenance service is required.	–
912	Fatal error in Communication-driver.	Maintenance service is required.	–
914	Time out occurs in Communications.	–	–
915	EEPROM SUM error.	EEPROM may be damaged. Maintenance service is required.	–
919	Module installation condition and setup parameters do not match.	The system has been initialized. Maintenance service is required.	–
921	System Failed to Draw Display.	Maintenance service is required.	–
922	Failed in communication with DSP.	Maintenance service is required.	–
923	Transmit data abnormality from DSP.	Maintenance service is required.	–
926	The USB device's power consumption exceeded the capacity of the USB hub.	–	12.9

---

#### **Note**

If the system is not operating correctly or if servicing is necessary, try initializing the WT3000. The WT3000 may recover.

---

# 11.3 Self-Test

## Procedure

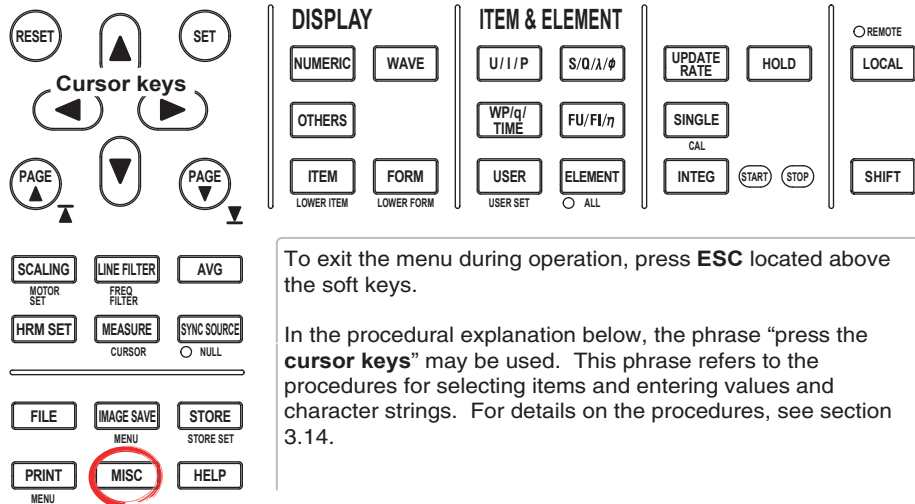

1. Press **MISC** to display the Misc menu.
2. Press the **Selftest** soft key to display the Selftest menu.
3. Press the **Test Item** soft key to display the Test Item menu.
4. Press the **Memory** or **Key Board** soft key to select the test item.  
 If you select Memory, proceed to “Testing the Memory” on the next page.  
 If you select Key Board, proceed to “Testing the Keys and the Keyboard” on the next page.

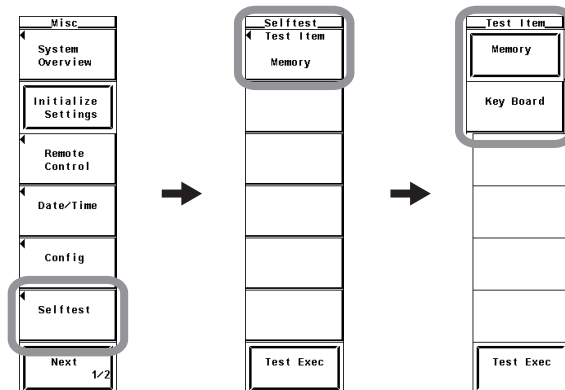

### Note

The time display at the lower right corner of the screen may not be updated during the self-test.

### • Testing the Memory

5. Press the **Memory Test** soft key to display the Memory Test menu.
6. Press the **System** or **ACQ RAM** soft key to select the memory to be tested.
7. Press the **Test Exec** soft key to execute the memory test.

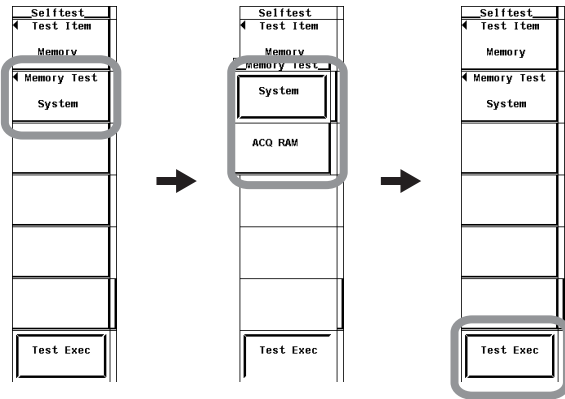

- **Testing the Keys and the Keyboard**

- **Testing the Keys**

5. Press the **Test Exec** soft key.
6. Press a **key** on the front panel. The test for the pressed key is executed.
7. Press the **◀** or **▶** **cursor key**. The indicator lights one by one each time an arrow key is pressed.
8. Press **ESC** twice to exit from the key test.

- **Testing the Keyboard**

9. Press the **Soft Key** soft key. A keyboard appears.
10. Operate the **keyboard**. Check that the characters entered on the keyboard are correctly displayed in the entry box of the keyboard.

For keyboard operations, see section 3.14, "Entering Values and Strings."

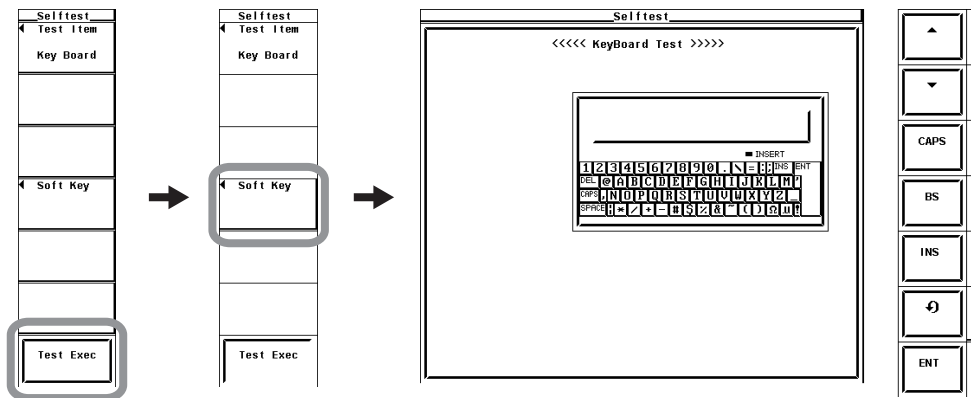

**Explanation**

- **Memory Test**

Tests whether the internal ROM and RAM are operating correctly. If "Pass" is displayed, it is operating correctly. If "Failed" is displayed, contact your nearest YOKOGAWA dealer.

- **System:** Tests the RAM in the CPU.
- **ACQ RAM:** Tests the RAM that stores the waveform sampling data (acquisition data).

- **Testing the Keys and Keyboard**

- Tests whether the front panel keys are operating properly. If the name of the key being pressed appears on the screen, it is operating correctly.
- If the indicator turns ON/OFF when the **◀** or **▶** cursor is pressed, the keys are operating correctly.
- To exit from the key test, press ESC twice.
- If the display is not correct, contact your nearest YOKOGAWA dealer.

# 11.4 Checking the System Condition

## Procedure

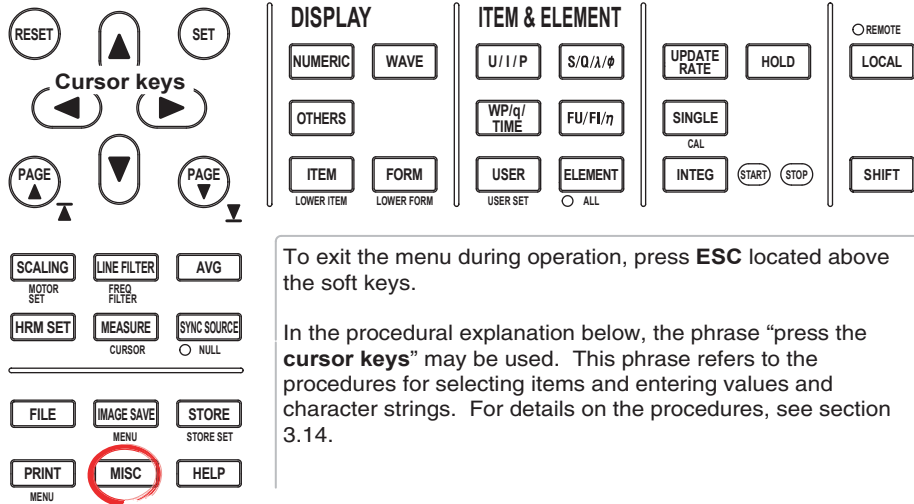

1. Press **MISC** to display the Misc menu.
2. Press the **System Overview** soft key to display the System Overview window.

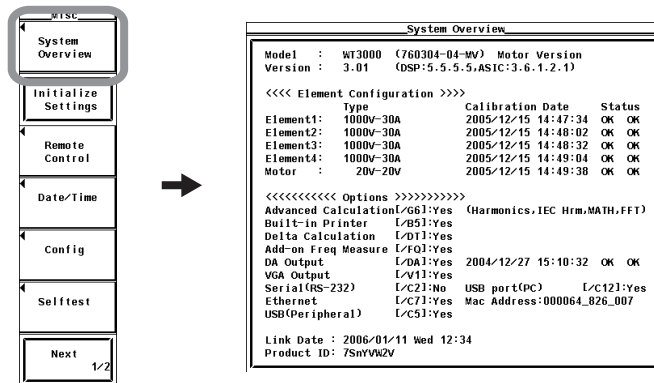

## Explanation

### Displaying the System Conditions

You can check the model, firmware version, element configuration, and installed options.



---

## 11.5 Replacing the Power Fuse



---

### WARNING

- To prevent the possibility of fire, only use a fuse with the specified rating (voltage, current, and type).
  - Be sure to turn OFF the instrument and unplug the power cord before replacing the fuse.
  - Never short the fuse holder.
- 

### Fuse Rating

The power fuse used on this instrument is specified as follows:

- Maximum rated voltage: 250 V
- Maximum rated current: 6.3 A
- Type: Time lag
- Standard: UL/VDE certified
- Part number: A1463EF

### Replacement Procedure

Replace the power fuse according to the procedure below.

1. Turn OFF the power switch.
2. Remove the power cord from the power connector.
3. Insert the tip of a flat-blade screw driver in the dented section of the fuse holder on the power connector side, turn it in the direction of the arrow, and pull out the fuse holder.
4. Remove the blown fuse that is attached to the tip of the fuse holder.
5. Attach a new fuse to the fuse holder and push the fuse holder back in the original place.

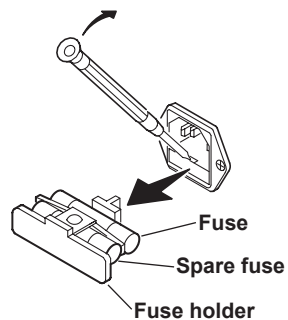

---

## 11.6 Recommended Replacement Parts

The three-year warranty applies only to the main unit of the instrument (starting from the day of delivery) and does not cover any other items or expendable items (items which wear out). The replacement period for expendable items varies depending on the conditions of use. Refer to the table below as a general guideline. Contact your nearest YOKOGAWA dealer to have parts replaced.

<b>Parts Name</b>	<b>Recommended Replacement Period</b>
Built-in printer	Under normal usage, 200 rolls of printer paper (part No. : B9316FX)
LCD backlight	3 years
Cooling fan	3 years
Backup battery (Lithium battery)	3 years

## 12.1 Input Section

Item	Specifications
Input terminal type	Voltage Plug-in terminal (safety terminal) Current <ul style="list-style-type: none"> <li>• Direct input: Large binding post</li> <li>• Current sensor input: Isolated BNC connector</li> </ul>
Input format	Voltage Floating input, resistive voltage divider Current Floating input, shunt input
Measurement range (rated value)	Voltage <ul style="list-style-type: none"> <li>• When the crest factor is set to 3: 15 V, 30 V, 60 V, 100 V, 150 V, 300 V, 600 V, and 1000 V</li> <li>• When the crest factor is set to 6: 7.5 V, 15 V, 30 V, 50 V, 75 V, 150 V, 300 V, and 500 V</li> </ul> Current (2-A input element) <ul style="list-style-type: none"> <li>• Direct input:               <ul style="list-style-type: none"> <li>• 5 mA, 10 mA, 20 mA, 50 mA, 100 mA, 200 mA, 500 mA, 1 A, or 2 A when the crest factor is set to 3.</li> <li>• 2.5 mA, 5 mA, 10 mA, 25 mA, 50 mA, 100 mA, 250 mA, 500 mA, 1 A when the crest factor is set to 6.</li> </ul> </li> <li>• External sensor input:               <ul style="list-style-type: none"> <li>• When the crest factor is set to 3: 50 mV, 100 mV, 200 mV, 500 mV, 1 V, 2 V, 5 V, and 10 V</li> <li>• When the crest factor is set to 6: 25 mV, 50 mV, 100 mV, 250 mV, 500 mV, 1 V, 2.5 V, and 5 V</li> </ul> </li> </ul> Current (30-A input element) <ul style="list-style-type: none"> <li>• Direct input:               <ul style="list-style-type: none"> <li>• When the crest factor is set to 3: 500 mA, 1 A, 2 A, 5 A, 10 A, 20 A, and 30 A</li> <li>• When the crest factor is set to 6: 250 mA, 500 mA 1 A, 2.5 A 5 A, 10 A, and 15 A</li> </ul> </li> <li>• External sensor input:               <ul style="list-style-type: none"> <li>• When the crest factor is set to 3: 50 mV, 100 mV, 200 mV, 500 mV, 1 V, 2 V, 5 V, and 10 V</li> <li>• When the crest factor is set to 6: 25 mV, 50 mV, 100 mV, 250 mV, 500 mV, 1 V, 2.5 V, and 5 V</li> </ul> </li> </ul>
Input impedance	Voltage Input resistance: Approx. 10 M $\Omega$ , input capacitance: Approx. 5 pF Current (2-A input element) <ul style="list-style-type: none"> <li>• Direct input: Approx. 500 m<math>\Omega</math> + approx. 0.07 <math>\mu</math> H</li> <li>• External sensor input: Input resistance: Approx. 1 M<math>\Omega</math>, input capacitance: Approx. 40 pF</li> </ul> Current (30-A input element) <ul style="list-style-type: none"> <li>• Direct input: Approx. 5.5 m<math>\Omega</math> + approx. 0.03 <math>\mu</math> H</li> <li>• External sensor input: Input resistance: Approx. 1 M<math>\Omega</math>, input capacitance: Approx. 40 pF</li> </ul>
Instantaneous maximum allowable input (1s or less)	Voltage Peak value of 2500 V or RMS value of 1500 V, whichever is less. Current (2-A input element) <ul style="list-style-type: none"> <li>• Direct input: Peak value of 9 A or RMS value of 3 A, whichever is less.</li> <li>• External sensor input: Peak value less than or equal to 10 times the measurement range.</li> </ul> Current (30-A input element) <ul style="list-style-type: none"> <li>• Direct input: Peak value of 150 A or RMS value of 50 A, whichever is less.</li> <li>• External sensor input: Peak value less than or equal to 10 times the measurement range.</li> </ul>
Continuous maximum allowable input	Voltage Peak value of 1600 V or RMS value of 1100 V, whichever is less. Current (2-A input element) <ul style="list-style-type: none"> <li>• Direct input: Peak value of 6 A or RMS value of 2.2 A, whichever is less.</li> <li>• External sensor input: Peak value less than or equal to 5 times the measurement range.</li> </ul> Current (30-A input element) <ul style="list-style-type: none"> <li>• Direct input: Peak value of 90 A or RMS value of 33 A, whichever is less.</li> <li>• External sensor input: Peak value less than or equal to 5 times the measurement range.</li> </ul>

## 12.1 Input Section/12.2 Display

Item	Specifications
Continuous maximum common mode voltage (50/60 Hz)	Voltage input terminals: 1000Vrms Current input terminals*: 1000 Vrms (maximum allowable voltage that can be measured) 600 Vrms (rating voltage of EN61010-2-030) External current sensor input connector: 600 Vrms
Influence from common	When 1000 Vrms is applied with the voltage input terminals shorted and current input terminals open. <ul style="list-style-type: none"> <li>• 50/60Hz: <math>\pm 0.01\%</math> of range or less.</li> <li>• Up to 200 kHz (reference value)</li> </ul> Voltage: $\pm 3/\text{range} \times f\%$ of range or 3%, whichever is less, or less Direct current input and external current sensor input: $\pm(\text{maximum range}/\text{range}) \times 0.001 \times f\%$ of range or less Except, 0.01% or greater. The unit of frequency f is kHz. The maximum range in an equation is 30 A or 10 V.
Line filter	Select OFF, 500 Hz, 5.5 kHz, or 50 kHz.
Frequency filter	Select On or Off.
A/D converter	Simultaneous conversion of voltage and current inputs. Resolution: 16 bits. Conversion rate (sampling interval): Approx. 5 $\mu$ s. For the measurement functions of harmonic measurement, see chapter 7 in the <i>Expansion Function User's Manual IM760301-51E</i> .
Range switching	Can be set for each element.
Auto range function	Range Increase <ul style="list-style-type: none"> <li>• When U or I exceeds 110% of the rated range</li> <li>• When the peak value of the input signal exceeds approximately 330% of the rated range (approximately 660% when the crest factor is set to 6)</li> </ul> Range decrease When U or I is less than or equal to 30% of the rated range and Upk or Ipk is less than or equal to 300% of the lower range (approximately 600% when the crest factor is set to 6)
Rated voltage to ground	Voltage input terminals: 1000V Current input terminals*: 1000 V (maximum allowable voltage that can be measured) 600 V (rating voltage of EN61010-2-030) External current sensor input connector: 600 V

\* Do not touch the inside of the external current sensor input BNC connector.

## 12.2 Display

Item	Specifications
Display	8.4" color TFT LCD monitor
Display resolution of the entire screen*	640 (H) $\times$ 480 (V) dots
Display resolution of the waveform display	501 (H) $\times$ 432 (V) dots
Display update interval	See section 12.5.

\* The LCD screen may contain 0.02% defects with respect to the total number of pixels.

## 12.3 Measurement Functions (Measurement Items) Related to Normal Measurement

### Measurement Functions Determined for Each Input Element

For details on the determination and equations of measurement functions, see appendix 1.

Item	Symbol and Meaning
Voltage (V)	Urms: true rms value, Umn: rectified mean value calibrated to the rms value, Udc: simple average, Urmn: rectified mean value
Current (A)	Irms: true rms value, Imn: rectified mean value calibrated to the rms value, Idc: simple average, Irmn: rectified mean value
Active power (W)	P
Apparent power (VA)	S
Reactive power (var)	Q
Power factor	$\lambda$
Phase difference (°)	$\phi$
Frequency (Hz)	fU (FreqU): voltage frequency, fI (FreqI): current frequency Two frequencies from the fU and fI of all installed elements can be measured simultaneously. On the model with the frequency measurement add-on option, the fU and fI of all elements can be measured simultaneously. The display of signals that are not selected shows [-----] (no data).
Voltage max. and min. (V)	U+pk: Voltage maximum, U-pk : Voltage minimum
Current max. and min. (A)	I+pk: Current maximum, I-pk : Current minimum
Crest factor	CfU: Voltage crest factor, CfI : Current crest factor
Corrected Power (W)	Pc (Applicable standard IEC76-1(1976), IEEE C57.12.90-1993, IEC76-1(1993))
Integration	Time: Integration time WP: Sum of positive and negative watt hours WP+: Sum of positive P (consumed watt hour) WP-: Sum of negative P (watt hour returned to the power supply) q: Sum of positive and negative ampere hours q+: Sum of positive I (ampere hour) q-: Sum of negative I (ampere hour) WS: Volt-ampere-hour WQ: Var-hour  However, the ampere hour is integrated by selecting Irms, Imn, Idc, or Irmn through the current mode setting.

### 12.3 Measurement Functions (Measurement Items) Related to Normal Measurement

#### Measurement Functions ( $\Sigma$ Functions) Determined for Each Wiring Unit ( $\Sigma A$ and $\Sigma B$ )

For details on the determination and equations of  $\Sigma$  functions, see appendix 1.

Item	Symbol and Meaning
Voltage (V)	Urms $\Sigma$ : true rms value, Umn $\Sigma$ : rectified mean value calibrated to the rms value, Udc $\Sigma$ : simple average, Urmn $\Sigma$ : rectified mean value
Current (A)	Irms $\Sigma$ : true rms value, Imn $\Sigma$ : rectified mean value calibrated to the rms value, Idc $\Sigma$ : simple average, Irmn $\Sigma$ : rectified mean value
Active power (W)	P $\Sigma$
Apparent power (VA)	S $\Sigma$
Reactive power (var)	Q $\Sigma$
Power factor	$\lambda S$
Phase difference (°)	$\phi S$
Corrected Power (W)	Pc $\Sigma$ (Applicable standard IEC76-1(1976), IEEE C57.12.90-1993, IEC76-1(1993))
Integration	Time: Integration time WP $\Sigma$ : Sum of positive and negative watt hours WP+ $\Sigma$ : Sum of positive P (consumed watt hour) WP- $\Sigma$ : Sum of negative P (watt hour returned to the power supply) q $\Sigma$ : Sum of positive and negative ampere hours q+ $\Sigma$ : Sum of positive I (ampere hour) q- $\Sigma$ : Sum of negative I (ampere hour) WS $\Sigma$ : Integration of S $\Sigma$ WQ $\Sigma$ : Integration of Q $\Sigma$

For details on the measurement functions of motor evaluation, see section 1.10 in the *Expansion Function User's Manual IM760301-51E*.

For details on the measurement functions of harmonic measurement, see section 7.11 in the *Expansion Function User's Manual IM760301-51E*.

# 12.4 Accuracy

## Voltage and Current Accuracy

Item	Specifications																													
Accuracy (accuracy at 6 months)	<p>Conditions Temperature: 23±5°C. Humidity: 30 to 75% RH. Input waveform: Sine wave. Common-mode voltage: 0 V. Line filter: OFF. <math>\lambda</math> (power factor): 1. Crest factor: 3. After warm-up time has passed. Wired condition after zero-level compensation or measurement range change. <math>f</math> is the frequency.</p>																													
	<table border="1"> <thead> <tr> <th>Frequency</th> <th>Accuracy <math>\pm</math>(reading error + measurement range error)</th> </tr> </thead> <tbody> <tr> <td colspan="2">DC</td> </tr> <tr> <td> <ul style="list-style-type: none"> <li>Voltage input</li> <li>Current sensor input</li> <li>Current of a 30-A input element from direct input</li> </ul> </td> <td>0.05% of reading + 0.05% of range</td> </tr> <tr> <td> <ul style="list-style-type: none"> <li>Current of a 2-A input element from direct input</li> </ul> </td> <td>0.05% of reading + 0.05% of range + 2 <math>\mu</math> A</td> </tr> <tr> <td>0.1 Hz <math>\leq f &lt;</math> 30 Hz</td> <td>0.1% of reading + 0.2% of range</td> </tr> <tr> <td>30 Hz <math>\leq f &lt;</math> 45 Hz</td> <td>0.03% of reading + 0.05% of range</td> </tr> <tr> <td>45 Hz <math>\leq f \leq</math> 66 Hz</td> <td> <ul style="list-style-type: none"> <li>Voltage input</li> <li>Current sensor input</li> <li>Current of a 30-A input element from direct input</li> <li>Current of a 2-A input element from direct input at the 500 mA to 2 A range</li> </ul> </td> <td>0.01% of reading + 0.03% of range</td> </tr> <tr> <td> <ul style="list-style-type: none"> <li>Current of a 2-A input element from direct input at the 5 mA to 200 mA range</li> </ul> </td> <td>0.03% of reading + 0.05% of range</td> </tr> <tr> <td>66 Hz <math>&lt; f \leq</math> 1 kHz</td> <td>0.03% of reading + 0.05% of range</td> </tr> <tr> <td>1 kHz <math>&lt; f \leq</math> 10 kHz</td> <td>0.1% of reading + 0.05% of range</td> </tr> <tr> <td>10 kHz <math>&lt; f \leq</math> 50 kHz</td> <td>0.3% of reading + 0.1% of range</td> </tr> <tr> <td>50 kHz <math>&lt; f \leq</math> 100 kHz</td> <td>0.012 <math>\times f\%</math> of reading + 0.2% of range</td> </tr> <tr> <td>100 kHz <math>&lt; f \leq</math> 500 kHz</td> <td>0.009 <math>\times f\%</math> of reading + 0.5% of range</td> </tr> <tr> <td>500 kHz <math>&lt; f \leq</math> 1 MHz</td> <td>(0.022 <math>\times f - 7</math>)% of reading + 1% of range</td> </tr> </tbody> </table>	Frequency	Accuracy $\pm$ (reading error + measurement range error)	DC		<ul style="list-style-type: none"> <li>Voltage input</li> <li>Current sensor input</li> <li>Current of a 30-A input element from direct input</li> </ul>	0.05% of reading + 0.05% of range	<ul style="list-style-type: none"> <li>Current of a 2-A input element from direct input</li> </ul>	0.05% of reading + 0.05% of range + 2 $\mu$ A	0.1 Hz $\leq f <$ 30 Hz	0.1% of reading + 0.2% of range	30 Hz $\leq f <$ 45 Hz	0.03% of reading + 0.05% of range	45 Hz $\leq f \leq$ 66 Hz	<ul style="list-style-type: none"> <li>Voltage input</li> <li>Current sensor input</li> <li>Current of a 30-A input element from direct input</li> <li>Current of a 2-A input element from direct input at the 500 mA to 2 A range</li> </ul>	0.01% of reading + 0.03% of range	<ul style="list-style-type: none"> <li>Current of a 2-A input element from direct input at the 5 mA to 200 mA range</li> </ul>	0.03% of reading + 0.05% of range	66 Hz $< f \leq$ 1 kHz	0.03% of reading + 0.05% of range	1 kHz $< f \leq$ 10 kHz	0.1% of reading + 0.05% of range	10 kHz $< f \leq$ 50 kHz	0.3% of reading + 0.1% of range	50 kHz $< f \leq$ 100 kHz	0.012 $\times f\%$ of reading + 0.2% of range	100 kHz $< f \leq$ 500 kHz	0.009 $\times f\%$ of reading + 0.5% of range	500 kHz $< f \leq$ 1 MHz	(0.022 $\times f - 7$ )% of reading + 1% of range
Frequency	Accuracy $\pm$ (reading error + measurement range error)																													
DC																														
<ul style="list-style-type: none"> <li>Voltage input</li> <li>Current sensor input</li> <li>Current of a 30-A input element from direct input</li> </ul>	0.05% of reading + 0.05% of range																													
<ul style="list-style-type: none"> <li>Current of a 2-A input element from direct input</li> </ul>	0.05% of reading + 0.05% of range + 2 $\mu$ A																													
0.1 Hz $\leq f <$ 30 Hz	0.1% of reading + 0.2% of range																													
30 Hz $\leq f <$ 45 Hz	0.03% of reading + 0.05% of range																													
45 Hz $\leq f \leq$ 66 Hz	<ul style="list-style-type: none"> <li>Voltage input</li> <li>Current sensor input</li> <li>Current of a 30-A input element from direct input</li> <li>Current of a 2-A input element from direct input at the 500 mA to 2 A range</li> </ul>	0.01% of reading + 0.03% of range																												
<ul style="list-style-type: none"> <li>Current of a 2-A input element from direct input at the 5 mA to 200 mA range</li> </ul>	0.03% of reading + 0.05% of range																													
66 Hz $< f \leq$ 1 kHz	0.03% of reading + 0.05% of range																													
1 kHz $< f \leq$ 10 kHz	0.1% of reading + 0.05% of range																													
10 kHz $< f \leq$ 50 kHz	0.3% of reading + 0.1% of range																													
50 kHz $< f \leq$ 100 kHz	0.012 $\times f\%$ of reading + 0.2% of range																													
100 kHz $< f \leq$ 500 kHz	0.009 $\times f\%$ of reading + 0.5% of range																													
500 kHz $< f \leq$ 1 MHz	(0.022 $\times f - 7$ )% of reading + 1% of range																													

\* The unit of  $f$  in the read error equation is kHz.

- Add 3% of range (reference value) to the above accuracy figure for the accuracy of the waveform display data, Upk, and lpk. However, for external sensor input, add 3% of range + 5 mV (reference value). The effective input range is within  $\pm 300\%$  of the range (within  $\pm 600\%$  of the range if the crest factor is set to 6).
- For temperature changes after zero level compensation or range change, add 50 ppm of range/ $^{\circ}$ C to the DC accuracy of the voltage.
- For temperature changes after zero level compensation or range change, add the following values to the DC accuracy of the direct current input.
  - 2-A input element: 3  $\mu$ A/ $^{\circ}$ C
  - 30-A input element: 0.2 mA/ $^{\circ}$ C
- For temperature changes after zero-level compensation or range change on the external current sensor input, add 0.02 mV/ $^{\circ}$ C to the DC accuracy of the external current sensor input.
- For self-generated heat caused by current input on an AC input signal, add the following values to the current accuracy.
  - 2-A input element: 0.004  $\times I^2\%$  of reading
  - 30-A input element: 0.00002  $\times I^2\%$  of reading
- For self-generated heat caused by current input on a DC input signal, add the following values to the current accuracy.
  - 2-A input element: 0.004  $\times I^2\%$  of reading + 6  $\times I^2 \mu$ A
  - 30-A input element: 0.00002  $\times I^2\%$  of reading + 3  $\times I^2 \mu$ A

$I$  is the current reading (A). The influence from self-generated heat continues until the temperature of the shunt resistor inside the WT3000 lowers even if the current input changes to a small value.
- When the data update interval is 50 ms, add 0.1% of reading to all accuracy figures.
- When the data update interval is 100 ms, add 0.05% of reading to all accuracy figures.

## 12.4 Accuracy

Item	Specifications																				
	<ul style="list-style-type: none"> <li>All accuracy figures for 0.1 to 10 Hz are reference values.</li> <li>The voltage accuracy figures for 30 kHz to 100 kHz when the voltage exceeds 750 V are reference values.</li> <li>The voltage accuracy figures for 100 kHz to 1 MHz when the voltage (V) exceeds <math>2.2 \times 10^4 / f</math> (kHz) are reference values.</li> <li>The current accuracy figures for DC, 10 Hz to 45 Hz, and 400 Hz to 200 kHz when the current exceeds 20 A are reference values.</li> <li>The current accuracy figures for 200 kHz to 500 kHz when the current exceeds 10 A are reference values.</li> <li>The current accuracy figures for 500 kHz to 1 MHz when the current exceeds 5 A are reference values.</li> </ul>																				
Effective input range	<p>0 to <math>\pm 130\%^*</math> of the measurement range for Udc and Idc.            1 to <math>130\%^*</math> of the measurement range for Urms and Irms. (2% to <math>130\%^*</math> if the crest factor is set to 6)            10 to <math>\pm 130\%^*</math> of the measurement range for Umn and Imn.            10 to <math>\pm 130\%^*</math> of the measurement range for Urmn and Irmn.            However, if the data update interval is 50 ms, 100 ms, 5 s, 10 s, or 20 s, the signal level of the synchronization source must satisfy the input signal level of frequency measurement (see section 12.5).            * 110% for the maximum range of direct voltage and current inputs. The accuracy for 110% to 130% of the measurement range is reading error <math>\times 1.5</math>.</p>																				
Maximum display	140% of the rated voltage or current range																				
Minimum display	<p>Down to 0.3% of the measurement range for Urms and Irms (0.6% if the crest factor is set to 6).            Down to 1% of the measurement range for Umn, Urmn, Imn, and Irmn (2% if the crest factor is set to 6).            Values less than or equal to these figures are fixed to zero (suppressed to zero). The integrated current q is dependent on the current value.</p>																				
Lower limit of measurement frequency	<table border="1"> <thead> <tr> <th>Data update interval</th> <th>50 ms</th> <th>100 ms</th> <th>250 ms</th> <th>500 ms</th> <th>1 s</th> <th>2 s</th> <th>5 s</th> <th>10 s</th> <th>20 s</th> </tr> </thead> <tbody> <tr> <td>Lower limit of measurement frequency</td> <td>45 Hz</td> <td>25 Hz</td> <td>20 Hz</td> <td>10 Hz</td> <td>5 Hz</td> <td>2 Hz</td> <td>0.5 Hz</td> <td>0.2 Hz</td> <td>0.1 Hz</td> </tr> </tbody> </table>	Data update interval	50 ms	100 ms	250 ms	500 ms	1 s	2 s	5 s	10 s	20 s	Lower limit of measurement frequency	45 Hz	25 Hz	20 Hz	10 Hz	5 Hz	2 Hz	0.5 Hz	0.2 Hz	0.1 Hz
Data update interval	50 ms	100 ms	250 ms	500 ms	1 s	2 s	5 s	10 s	20 s												
Lower limit of measurement frequency	45 Hz	25 Hz	20 Hz	10 Hz	5 Hz	2 Hz	0.5 Hz	0.2 Hz	0.1 Hz												
Line filter influence	<p>When the cut-off frequency is 500 Hz  <math>45 \text{ Hz} \leq f \leq 66 \text{ Hz}</math>: Add 0.2% of reading. <math>f &lt; 45 \text{ Hz}</math>: Add 0.5% of reading.            When the cut-off frequency is 5.5 kHz  <math>f \leq 66 \text{ Hz}</math>: Add 0.2% of reading. <math>66 \text{ Hz} &lt; f \leq 500 \text{ Hz}</math>: Add 0.5% of reading.            When the cut-off frequency is 50 kHz  <math>f \leq 500 \text{ Hz}</math>: Add 0.2% of reading. <math>500 \text{ Hz} &lt; f \leq 5 \text{ kHz}</math>: Add 0.5% of reading.</p>																				
Conditions for detecting lead and lag	Lead and lag are detected correctly when the voltage and current signals are both sine waves, the amplitude is greater than or equal to 50% (greater than or equal to 100% if the crest factor is set to 6) of the measurement range, the frequency is between 20 Hz and 10 kHz, and the phase difference is between $\pm 5^\circ$ and $175^\circ$ .																				
Temperature coefficient	Add $\pm 0.02\%$ of reading/ $^\circ \text{C}$ in the range 5 to $18^\circ \text{C}$ or 28 to $40^\circ \text{C}$ .																				
One year accuracy	Add (reading error of accuracy at 6 months $\times 0.5$ ) to the accuracy at 6 months.																				
Accuracy when the crest factor is set to 6	Same as the accuracy when the crest factor is 3 after doubling the measurement range.																				



## Power Accuracy

Item	Specifications
Accuracy (accuracy at 6 months)	Conditions Same as the conditions for voltage and current.
	Frequency
	Accuracy $\pm(\text{reading error} + \text{measurement range error})$
	DC
	<ul style="list-style-type: none"> <li>Voltage input</li> <li>Current of a 30-A input element from direct input</li> </ul>
	0.05% of reading + 0.1% of range
	<ul style="list-style-type: none"> <li>Current of a 2-A input element from direct input</li> </ul>
	0.05% of reading + 0.1% of range + $2 \mu\text{A} \times \text{voltage reading}$
	$0.1 \text{ Hz} \leq f < 30 \text{ Hz}$
	0.2% of reading + 0.3% of range
	$30 \text{ Hz} \leq f < 45 \text{ Hz}$
	0.05% of reading + 0.05% of range
	$45 \text{ Hz} \leq f \leq 66 \text{ Hz}$
	<ul style="list-style-type: none"> <li>Current sensor input</li> <li>Current of a 30-A input element from direct input</li> <li>Current of a 2-A input element from direct input at the 500 mA to 2 A range</li> </ul>
	0.02% of reading + 0.04% of range
	<ul style="list-style-type: none"> <li>Current of a 2-A input element from direct input at the 5 mA to 200 mA range</li> </ul>
	0.05% of reading + 0.05% of range
	$66 \text{ Hz} < f \leq 1 \text{ kHz}$
	0.05% of reading + 0.05% of range
	$1 \text{ kHz} < f \leq 10 \text{ kHz}$
	0.15% of reading + 0.1% of range
	$10 \text{ kHz} < f \leq 50 \text{ kHz}$
	0.3% of reading + 0.2% of range
	$50 \text{ kHz} < f \leq 100 \text{ kHz}$
	$0.014 \times f\%$ of reading + 0.3% of range
	$100 \text{ kHz} < f \leq 500 \text{ kHz}$
	$0.012 \times f\%$ of reading + 1% of range
	$500 \text{ kHz} < f \leq 1 \text{ MHz}$
	$(0.048 \times f - 19)\%$ of reading + 2% of range

\* The unit of f in the read error equation is kHz.

- For temperature changes after zero level compensation or range change, add (voltage influence)  $\times$  (current influence) to the DC accuracy. For details on voltage and current influence, see page 12-5.
- For self-generated heat caused by current input on an AC input signal, add the following values to the power accuracy.
  - 2-A input element:  $0.004 \times I^2\%$  of reading
  - 30-A input element:  $0.00002 \times I^2\%$  of reading
- For self-generated heat caused by current input on a DC input signal, add the following values to the power accuracy.
  - 2-A input element:  $0.004 \times I^2\%$  of reading +  $6 \times I^2 \mu\text{A}$
  - 30-A input element:  $0.00002 \times I^2\%$  of reading +  $3 \times I^2 \mu\text{A}$

I is the current reading (A). The influence from self-generated heat continues until the temperature of the shunt resistor inside the WT3000 lowers even if the current input changes to a small value.
- When the data update interval is 50 ms, add 0.1% of reading to all accuracy figures.
- When the data update interval is 100 ms, add 0.05% of reading to all accuracy figures.
- All accuracy figures for 0.1 to 10 Hz are reference values.
- The power accuracy figures for 30 kHz to 100 kHz when the voltage exceeds 750 V are reference values.
- The power accuracy figures for 100 kHz to 1 MHz when the voltage (V) exceeds  $2.2 \times 10^4 / f$  (kHz) are reference values.
- The power accuracy figures for DC, 10 Hz to 45 Hz, and 400 Hz to 200 kHz when the current exceeds 20 A are reference values.
- The power accuracy figures for 200 kHz to 500 kHz when the current exceeds 10 A are reference values.
- The power accuracy figures for 500 kHz to 1 MHz when the current exceeds 5 A are reference values.

## 12.4 Accuracy

Item	Specifications
Effective input range	<ul style="list-style-type: none"> <li>0 to <math>\pm 130\%</math> of the power range (see section 5.2) for DC measurement.</li> <li><math>\pm 130\%</math> of the power range for current measurement when the voltage and current are in the range of 1 to 130% of the measurement range. However, if the data update interval is 50 ms, 100 ms, 5 s, 10 s, or 20 s, the signal level of the synchronization source must satisfy the input signal level of frequency measurement (see section 12.5).</li> <li>* 110% for the maximum range of direct voltage and current inputs. The accuracy for 110% to 130% of the measurement range is reading error <math>\times 1.5</math>.</li> </ul>
Lower limit of measurement frequency	Same as the lower limit of measurement frequency for voltage and current.
Power factor ( $\lambda$ ) influence	<ul style="list-style-type: none"> <li>When <math>\lambda = 0</math> <ul style="list-style-type: none"> <li>5 mA to 200 mA range of a 2-A input element <ul style="list-style-type: none"> <li>Apparent power reading <math>\times 0.1\%</math> in the range of 45 to 66 Hz.</li> <li>For other frequency ranges, see below. However, the figures are reference values. Add apparent power reading <math>\times (0.1 + 0.05 \times f \text{ (kHz)})\%</math></li> </ul> </li> <li>500 mA to 2 A range of a 2-A input element or 30-A input element <ul style="list-style-type: none"> <li>Apparent power reading <math>\times 0.03\%</math> in the range of 45 to 66 Hz.</li> <li>For other frequency ranges, see below. However, the figures are reference values. Add apparent power reading <math>\times (0.03 + 0.05 \times f \text{ (kHz)})\%</math></li> </ul> </li> </ul> </li> <li>When <math>0 &lt; \lambda &lt; 1</math>  (Power reading) <math>\times</math> [(power reading error %) + (power range error %) <math>\times</math> (power range/apparent power indication value) + <math>\{\tan \phi \times</math> (influence when <math>\lambda = 0\})</math>] where <math>\phi</math> is the phase angle between the voltage and current.</li> </ul>
Line filter influence	<p>When the cut-off frequency is 500 Hz  <math>45 \text{ Hz} \leq f \leq 66 \text{ Hz}</math>: Add 0.3% of reading. <math>f &lt; 45 \text{ Hz}</math>: Add 1% of reading.</p> <p>When the cut-off frequency is 5.5 kHz  <math>f \leq 66 \text{ Hz}</math>: Add 0.3% of reading. <math>66 \text{ Hz} &lt; f \leq 500 \text{ Hz}</math>: Add 1% of reading.</p> <p>When the cut-off frequency is 50 kHz  <math>f \leq 500 \text{ Hz}</math>: Add 0.3% of reading. <math>500 &lt; f \leq 5 \text{ kHz}</math>: Add 1% of reading.</p>
Temperature coefficient	Same as the temperature coefficient for voltage and current.
One year accuracy	Add (reading error of accuracy at 6 months $\times 0.5$ ) to the accuracy at 6 months.
Accuracy when the crest factor is set to 6	Accuracy obtained by doubling the measurement range error for the accuracy when the crest factor is set to 3

### Accuracy of Other Parameters and Computation Accuracy

- Accuracy of apparent power S Voltage accuracy + current accuracy
- Accuracy of reactive power Q Accuracy of apparent power +  $\frac{(\sqrt{(1.0004 - \lambda^2)} - \sqrt{(1 - \lambda^2)}) \times 100\%}{\text{of range}}$
- Accuracy of power factor  $\lambda$   $\pm [(\lambda - \lambda/1.0002) + |\cos \phi - \cos\{\phi + \sin^{-1}(\text{influence from the power factor when } \lambda = 0\%/100)\}|] \pm 1$  digit when voltage and current is at rated input of the measurement range
- Accuracy of phase difference  $\phi$   $\pm [|\phi - \cos^{-1}(\lambda/1.0002)| + \sin^{-1}\{(\text{influence from the power factor when } \lambda = 0\%/100)\}] \text{ deg} \pm 1$  digit when voltage and current is at rated input of the measurement range
- For the accuracy of frequency fU and fI, see "Frequency Measurement" in section 12.5, "Functions."
- For the accuracy of measured values WP, WP+, WP-, q, q+, and q- and the integration time, see "Integration" in section 12.5, "Functions."
- For the accuracies of voltage, current, and power during harmonic measurement; the accuracies of rotating speed and torque; and the accuracy of D/A output; see the respective sections in the *Expansion Function User's Manual IM760301-51E*.

## 12.5 Functions

### Measurement Function and Measurement Conditions

Item	Specifications
Measurement method	Digital multiplier method
Crest factor	Select 3 or 6 (when rated value of the measurement range is input) 300 for the minimum effective input.
Measurement period	<p>Period used to determine and compute the measurement function.</p> <ul style="list-style-type: none"> <li>The measurement period is set by the zero crossing of the reference signal (synchronization source) when the data update interval is 50 ms, 100 ms, 5 s, 10 s, or 20 s (excluding watt hour WP as well as ampere hour q during DC mode).</li> <li>Measured through exponential averaging on the sampled data within the data update interval when the data update interval is 250 ms, 500 ms, 1 s, or 2 s.</li> <li>For harmonic measurement (/G6 or /G5 option), the measurement period is from the beginning of the data update interval to 9000 points at the harmonic sampling frequency.</li> </ul>
Wiring system	<p>Select the wiring system from the following: 1P2W: single-phase, two-wire, 1P3W: single-phase, three-wire, 3P4W: three-phase, four-wire, and 3P3W (3V3A) three-voltage, three-current However, the selectable wiring systems vary depending on the number of input elements that are installed.</p>
Measurement range	See section 12.1.
Compensation function	<p>Efficiency compensation: Compensates for the instrumental loss during efficiency computation Wiring compensation: Compensates for the instrumental loss due to wiring Tow-Wattmeter Method Compensation*</p> <p>* Selectable on models with the delta computation option.</p>
Scaling	Set the current sensor transformation ratio, VT ratio, CT ratio, and power factor in the range of 0.0001 to 99999.9999 when inputting the external current sensor, VT, or CT output to the instrument.
Input filter	Specify a line filter or a frequency filter. See section 12.1.
Averaging	<ul style="list-style-type: none"> <li>Measurement Functions of Normal Measurement <ul style="list-style-type: none"> <li>Select exponential average or moving average. <ul style="list-style-type: none"> <li>Exponential average <ul style="list-style-type: none"> <li>Select the attenuation constant from 2, 4, 8, 16, 32, and 64.</li> </ul> </li> <li>Moving average <ul style="list-style-type: none"> <li>Select the average count from 8, 16, 32, 64, 128, and 256.</li> </ul> </li> </ul> </li> </ul> </li> <li>Measurement Functions of Harmonic Measurement <ul style="list-style-type: none"> <li>Exponential average <ul style="list-style-type: none"> <li>Select the attenuation constant from 2, 4, 8, 16, 32, and 64.</li> </ul> </li> </ul> </li> </ul>
Data update rate	Select from 50 ms, 100 ms, 250 ms, 500 ms, 1 s, 2 s, 5 s, 10 s, and 20 s.
Display update rate	<p>Same as the data update rate. Exceptions are listed below.</p> <ul style="list-style-type: none"> <li>The display update interval of numeric display (4, 8, and 16 items) is 250 ms when the data update rate is 50 ms or 100 ms.</li> <li>The display update interval of numeric display (ALL, Single List, and Dual List) is 500 ms when the data update rate is 50 ms to 250 ms.</li> <li>The display update rate of the trend display, bar graph display, and vector display is 1 s when the data update rate is 50 ms to 500 ms.</li> <li>The display update interval of the waveform display is approximately 1 s when the data update rate is 50 ms to 1 s. However, it may be longer depending on the trigger setting.</li> </ul>
Response time	Data update rate × 2 at the maximum. Only when displaying numeric values.
Hold	Holds the data display.
Single measurement	Executes one measurement during the hold condition.
Zero-level compensation/Null	Performs zero-level compensation.

## 12.5 Functions

Item	Specifications
Measurement mode	<p>Select from the following measurement modes.</p> <ul style="list-style-type: none"> <li>• Normal measurement mode</li> <li>• Wide bandwidth harmonic measurement mode*<sup>1</sup></li> <li>• IEC harmonic measurement mode*<sup>1</sup></li> <li>• Waveform computation mode*<sup>1</sup></li> <li>• FFT mode*<sup>1</sup></li> <li>• Voltage fluctuation and flicker measurement mode*<sup>2</sup></li> <li>• Cycle-by-cycle measurement mode*<sup>3</sup></li> </ul> <p>*<sup>1</sup> Selectable on models with the advanced computation option.  *<sup>2</sup> Selectable on models with the voltage fluctuation and flicker measurement option.  *<sup>3</sup> Selectable on models with the cycle-by-cycle measurement option.</p>

### Frequency Measurement

Item	Specifications																				
Measured item	Select up to two of the frequencies of the voltage or current that is input to the input element. For models with the frequency measurement add-on option, the frequencies of all voltages and currents applied to the input element are measured.																				
Measurement method	Reciprocal method																				
Measurement range	<table border="1"> <thead> <tr> <th>Data update rate</th> <th>Measurement range</th> </tr> </thead> <tbody> <tr> <td>50 ms</td> <td>45 Hz ≤ f ≤ 1 MHz</td> </tr> <tr> <td>100 ms</td> <td>25 Hz ≤ f ≤ 1 MHz</td> </tr> <tr> <td>250 ms</td> <td>10 Hz ≤ f ≤ 500 kHz</td> </tr> <tr> <td>500 ms</td> <td>5 Hz ≤ f ≤ 200 kHz</td> </tr> <tr> <td>1 s</td> <td>2.5 Hz ≤ f ≤ 100 kHz</td> </tr> <tr> <td>2 s</td> <td>1.5 Hz ≤ f ≤ 50 kHz</td> </tr> <tr> <td>5 s</td> <td>0.5 Hz ≤ f ≤ 20 kHz</td> </tr> <tr> <td>10 s</td> <td>0.25 Hz ≤ f ≤ 10 kHz</td> </tr> <tr> <td>20 s</td> <td>0.15 Hz ≤ f ≤ 5 kHz</td> </tr> </tbody> </table>	Data update rate	Measurement range	50 ms	45 Hz ≤ f ≤ 1 MHz	100 ms	25 Hz ≤ f ≤ 1 MHz	250 ms	10 Hz ≤ f ≤ 500 kHz	500 ms	5 Hz ≤ f ≤ 200 kHz	1 s	2.5 Hz ≤ f ≤ 100 kHz	2 s	1.5 Hz ≤ f ≤ 50 kHz	5 s	0.5 Hz ≤ f ≤ 20 kHz	10 s	0.25 Hz ≤ f ≤ 10 kHz	20 s	0.15 Hz ≤ f ≤ 5 kHz
Data update rate	Measurement range																				
50 ms	45 Hz ≤ f ≤ 1 MHz																				
100 ms	25 Hz ≤ f ≤ 1 MHz																				
250 ms	10 Hz ≤ f ≤ 500 kHz																				
500 ms	5 Hz ≤ f ≤ 200 kHz																				
1 s	2.5 Hz ≤ f ≤ 100 kHz																				
2 s	1.5 Hz ≤ f ≤ 50 kHz																				
5 s	0.5 Hz ≤ f ≤ 20 kHz																				
10 s	0.25 Hz ≤ f ≤ 10 kHz																				
20 s	0.15 Hz ≤ f ≤ 5 kHz																				
Accuracy	<p>±0.05% of reading</p> <p>When the input signal level is greater than or equal to 25 mV (current sensor input), 150 mA (direct current input to the 30-A input element), or 1.5 mA (direct current input to the 2-A input element) and the signal is greater than or equal to 30% (0.1 Hz to 440 Hz, with frequency filter ON), 10% (440 Hz to 500 kHz), or 30% (500 kHz to 1 MHz) of the measurement range. Except, input greater than or equal to 50% of the measurement range when the frequency is less than or equal twice the lower limit of frequency described above. Add 0.05% of reading when the external current sensor input is 50 mV or less. Twice these values for the input signal level when the crest factor is set to 6</p>																				
Display resolution	99999																				
Frequency measurement filter	Frequency filter (see section 12.1)																				

### Integration

Item	Specifications
Mode	Select from manual, normal, repetitive, real-time normal, and real-time repetitive.
Measurement function	See section 12.3.
Integration timer	Automatic stop of integration by setting a timer. 0000h00m00s to 10000h00m00s
Count overflow	<p>When the integration time reaches its maximum (10000 hours) or the integration value reaches its maximum or minimum,*<sup>1</sup> the integration time and integration value at that point are held and the integration is stopped.</p> <p>*<sup>1</sup> WP: ±999999 MWh  q: ±999999 MAh  WS: ±999999 MVAh  WQ: ±999999 Mvarh</p>

Item	Specifications
Accuracy	$\pm$ (Power accuracy (or current accuracy) + timer accuracy)
Timer accuracy	$\pm$ 0.02% of reading

## Computation

Item	Specifications
User-defined function	Computes numeric data of equations (up to 20 equations) that are created by combining the measurement function symbols and operators.
Average active power setting	Set with the user-defined function.
Efficiency equation setting	Computes numeric data of equations (up to four equations) that are created by combining the measurement function symbols.
Compensation setting	Computes wiring compensation, efficiency compensation, and two-wattmeter compensation.
Equation for apparent power and reactive power	Select TYPE1, TYPE2, or TYPE3. TYPE3 is selectable only in normal measurement mode on models with the advanced computation (/G6) or harmonic measurement (/G5) option.
Corrected Power	Correction of active power as defined by the applicable standard IEC76-1(1976), IEEE C57.12.90-1993, and IEC76-1(1993).
Phase difference display	Select whether to display the phase difference using 180° lead and lag format or 360° format.
Delta computation	Computes other numeric data of the measured circuit from the computed results of the difference of the instantaneous values. Applicable only on models with the delta computation option.
Equation for distortion	Set the denominator of factor the equation to the total waveform or fundamental waveform. Applicable only to models with the advanced computation (/G6) or harmonic measurement (/G5) option.

## Numeric Display

Item	Specifications
Displayed items	Displays the measurement functions of section 12.3 and those of the motor evaluation function, delta computation, and harmonic measurement options as described in the <i>Expansion Function User's Manual IM760301-51E</i> .
Display resolution	600000
Number of displayed items	Select from 4, 8, 16, ALL, single list*, dual list*. * Applicable only to models with the advanced computation (/G6) or harmonic measurement (/G5) option.
Scrolling of displayed items	Displays up to nine pages of the numeric data of the measurement functions by page scrolling.
Display reset	Resets the display order of the numeric data to default.

## Waveform Display

Item	Specifications
Number of display rasters	501
Display format	Peak-Peak compressed data
Sample rate	Approx. 200 kS/s Waveforms can be reproduced accurately up to approximately 10 kHz.
Time axis	In the range of 0.5 ms/div to 2 s/div. However, less than or equal to 1/10 of the data update rate.
Trigger	<ul style="list-style-type: none"> <li>• Trigger type: Edge type</li> <li>• Trigger mode: Select auto or normal. Trigger automatically turns OFF when integration is in progress.</li> <li>• Trigger source: Select from the voltage or current applied to the input element and external clock.</li> <li>• Trigger slope: Select from <math>f</math> (rising), <math>\bar{f}</math> (falling), or <math>f\bar{f}</math> (rising and falling).</li> <li>• Trigger level <ul style="list-style-type: none"> <li>• When the trigger source is a voltage or current applied to the input element Set in the range of <math>\pm</math>100% (to the top or bottom edge of the screen) from the screen center. Resolution: 0.1%.</li> <li>• When the trigger source is Ext Clk (external clock) TTL level. For the specifications of the external clock, see section 6.3.</li> </ul> </li> </ul>
Vertical zoom on the waveform	Zoom in/out vertically for each voltage or current applied to the input element. Set the zoom rate in the range from 0.1 to 100 times.
Waveform display ON/OFF	Select ON/OFF for each voltage or current applied to the input element.
Waveform display format	1, 2, 3, and 4 split window displays are possible.

## 12.5 Functions

---

Item	Specifications
Display interpolation of the waveform	Select dot or linear display.
Graticule	Select the grid and cross scale display.
Auxiliary display ON/OFF	Turn ON/OFF the upper and lower limits (scale value) and the waveform label.
Cursor measurement	Measure the value at the point where the cursor is placed on the waveform.

### Vector Display and Bar Graph Display

Item	Specifications
Vector display	Displays vectors of the phase difference of the fundamental waveforms. Applicable on models with the advanced computation (/G6) or harmonic measurement (/G5) option.
Bar graph display	Displays the bar graph of the amplitude of each harmonic. Applicable on models with the the advanced computation (/G6) or harmonic measurement (/G5) option.

### Trend Display

Displays the trend of the numeric data of the measurement function on a graph.  
The maximum number of displayed items is 16.

---

### Simultaneous Display

Displays a combination of two displays from numeric, waveform, bar graph, and trend in the top and bottom halves of the divided screen.

---

### Data Store and Recall

Store	Store the numerical data and waveform display data in the internal memory. Save the stored data to a storage medium.*1
Internal memory	Approx. 30 MB
Storage interval	50 ms (when waveform is OFF) to 99 hours 59 minutes 59 seconds.
Recall	Recall the stored data from the internal memory.*2

\*1 PC card, USB storage, and network drive. The USB port (for peripheral devices) and Ethernet interface are options.

\*2 Cannot recall the data from a saved file.

### Saving and Loading of Data

Save setup parameters, numeric data, waveform display data, waveform sampling data,\*1 and screen image data to a storage medium\*2.

Loads the saved setup parameters from the storage medium.\*2

\*1 Selectable on models with the advanced computation (/G6) option.

\*2 PC card, USB storage, and network drive. The USB port (for peripheral devices) and Ethernet interface are options.

### Printing of the Screen Image and Numeric Data List

Print the screen image and numeric data list on the built-in printer.

\*1 The built-in printer is an option.

## 12.6 Input/Output of the Master/Slave Synchronization Signal

Item	Specifications
Connector type	BNC connector: Common to the master and slave
I/O level	TTL: Common to the master and slave
Output logic	$\overline{\text{L}}$ Negative logic, falling edge: Applicable to the master
Measurement start delay time	Within (1 $\mu$ s + 1 sample period): Applicable to the master
Output hold time	Low level, 500 ns or more: Applicable to the master
Input logic	$\overline{\text{L}}$ Negative logic, falling edge: Applicable to the slave
Minimum pulse width	Low level, 500 ns or more: Applicable to the slave
Input delay time	During HOLD ON Within (1 $\mu$ s + 1 sample period): Applicable to the slave During HOLD OFF Within (63 $\mu$ s + 1 sample period): Applicable to the slave

## 12.7 External Clock Input

### Common

Item	Specifications
Connector type	BNC connector
Input level	TTL

### When Used as a Synchronization Source (Ext Clk) during Normal Measurement

Item	Specifications
Frequency range	Same as the measurement range of "Frequency Measurement" in section 12.5.
Input waveform	50% duty ratio rectangular wave

### When Used as a PLL Source (Ext Clk) during Harmonic Measurement

Item	Specifications
Frequency range	Harmonic measurement (/G5) option: 10 Hz to 440 Hz Advanced computation (/G6) option: 10 Hz to 2600 Hz
Input waveform	50% duty ratio rectangular wave

### When Used as an External Sampling Clock (Smp Clk) during Wide Bandwidth Harmonic Measurement Mode

Item	Specifications
Frequency range	Frequencies that are 3000 times 0.1 Hz to 66 Hz
Input waveform	50% duty ratio rectangular wave

### When Used as a Trigger

Item	Specifications
Minimum pulse width	1 $\mu$ s
Trigger delay time	Within (1 $\mu$ s + 1 sample interval)

---

## 12.8 Storage

### PC Card Interface

Item	Specifications
Number of slots	1
Type	TYPE II flash ATA card

### USB Storage Device

Item	Specifications
Supported USB mass storage devices	USB memory (USB Mass Storage Class)

For specification details, see the next section, "USB PERIPHERAL Interface."

---

## 12.9 USB PERIPHERAL Interface

Item	Specifications
Connector type	USB type A connector (receptacle)
Electrical and mechanical specifications	Conforms to USB Rev.1.1
Data rate	12 Mbps maximum
Supported keyboards <sup>*1</sup>	104 keyboard (US) and 109 keyboard (Japanese) conforming to USB HID Class Ver.1.1
Supported USB mass storage devices	USB memory (USB Mass Storage Class)
Power supply	5 V, 500 mA <sup>*2</sup> (per port)
Number of ports	2

\*1 For details on the compatible USB devices, contact your nearest YOKOGAWA dealer.

\*2 Devices whose maximum current consumption exceeds 100 mA cannot be connected simultaneously to the two ports.



## 12.10 GP-IB Interface

Item	Specifications
Devices That Can Be Used	NATIONAL INSTRUMENTS <ul style="list-style-type: none"><li>• AT-GPIB</li><li>• PCI-GPIB and PCI-GPIB+</li><li>• PCMCIA-GPIB and PCMCIA-GPIB+</li></ul> Driver: NI-488.2M Ver. 1.60 or later
Electrical and mechanical specifications	Conforms to IEEE St'd 488-1978 (JIS C 1901-1992).
Functional specifications	SH1, AH1, T6, L4, SR1, RL1, PP0, DC1, DT1, and C0
Protocol	Conforms to IEEE St'd 488.2-1992
Code used	ISO (ASCII) code
Address	0 to 30
Clear remote mode	Remote mode can be cleared by pressing LOCAL (except during Local Lockout).

For details on the specifications of the GP-IB interface, see the *Communication Interface User's Manual (IM760301-17E)*.

## 12.11 Safety Terminal Adapter

Item	Specifications
Maximum allowable current	36 A
Withstand voltage	1000 V CAT III
Contact resistance	10 mΩ or less
Contact section	Nickel plating on brass or bronze
Insulator	Polyamide
Core wire	Maximum diameter 1.8 mm
Insulation thickness	Maximum diameter 3.9 mm

## 12.12 General Specifications

Item	Specifications										
Warm-up time	Approx. 30 minutes										
Operating conditions	Temperature: 5 to 40° C Humidity : 20 to 80% RH when not using the printer, 35 to 80% RH when using the printer. (No condensation)										
Operating altitude	2000 m or less										
Installation location	Indoors										
Storage environment	Temperature: -25 to 60° C Humidity: 20 to 80% RH. (No condensation)										
Rated supply voltage	100 to 240 VAC										
Permitted supply voltage range	90 to 264 VAC										
Rated supply voltage frequency	50/60 Hz										
Permitted supply voltage frequency range	48 to 63 Hz										
Maximum power consumption	150 VA (when using the built-in printer)										
External dimensions (See section 12.13.)	Approx. 426 mm (W) × 177 mm (H) × 459 mm (D) (Excludes the handle and other projections.)										
Weight	Approx. 14 kg (main unit, 4 input elements, and option installed)										
Installation position	Horizontal (however, the stand can be used). Vertical position and stacking not allowed.										
Battery backup	Setup parameters and the internal time clock are backed up with lithium batteries.										
Fuse	<table border="1"> <thead> <tr> <th>Location</th> <th>Maximum Rated Voltage</th> <th>Maximum Rated Current</th> <th>Type</th> <th>Standard</th> </tr> </thead> <tbody> <tr> <td>Power supply</td> <td>250 V</td> <td>6.3 A</td> <td>Time lag</td> <td>UL/VDEcertified</td> </tr> </tbody> </table>	Location	Maximum Rated Voltage	Maximum Rated Current	Type	Standard	Power supply	250 V	6.3 A	Time lag	UL/VDEcertified
Location	Maximum Rated Voltage	Maximum Rated Current	Type	Standard							
Power supply	250 V	6.3 A	Time lag	UL/VDEcertified							
Safety standard <sup>*1</sup>	Complying standard EN61010-1, EN61010-2-030 Overvoltage category (Installation category) CAT II <sup>*2</sup> Measurement category CAT II <sup>*3</sup> Pollution degree 2 <sup>*4</sup>										

Item	Specifications
Emission <sup>*1</sup>	<p>Complying standard EN61326-1 Class A EN55011 Class A, Group 1 EN61000-3-2 EN61000-3-3 EMC Regulatory Arrangement in Australia and New Zealand EN 55011 Class A, Group 1 Korea Electromagnetic Conformity Standard ( 한국 전자파적합성기준 ) This product is a Class A (for industrial environment) product. Operation of this product in a residential area may cause radio interference in which case the user is required to correct the interference.</p> <p>Cable condition</p> <ul style="list-style-type: none"> <li>• External sensor input terminal Use the B9284LK External Sensor Cable.</li> <li>• EXT CLK/MEAS. START/TORQUE (motor version)/SPEED (motor version) terminal Use a BNC cable<sup>*5</sup>.</li> <li>• GP-IB interface connector Use a shielded GP-IB cable<sup>*5</sup>.</li> <li>• RS-232 interface (option) connector Use a shielded RS-232 cable<sup>*5</sup>.</li> <li>• D/A OUTPUT (option) connector Use a shielded cable<sup>*5</sup>.</li> <li>• RGB VIDEO OUT (option) connector Use a 15-pin D-sub shielded VGA cable<sup>*5</sup>.</li> <li>• Devices that are easily affected by noise may be affected by the conducted interference generated from the cables used for measurements that are connected to the WT3000. In such case, the user is required to correct the interference.</li> <li>• USB port (PC) (option) Use shielded USB cables<sup>*5</sup>.</li> <li>• USB port (peripheral devices) (option) Use a USB keyboard with a shielded cable.</li> <li>• Ethernet (option) connector Use category 5 Ethernet cables or better cables.</li> </ul>
Immunity <sup>*1</sup>	<p>Complying standard EN61326-1 Table 2 (for use in industrial locations)</p> <p>Influence in the immunity environment</p> <p>Signal input: Within ±20 of range (within ±40% of range if the crest factor is set to 6)</p> <p>D/A output: Within ±20 of FS when FS = 5 V</p> <p>Cable condition Same as the cable condition for emission above.</p>

\*1 Applies to products with CE marks. For all other products, contact your nearest YOKOGAWA dealer.

\*2 The Overvoltage Category is a value used to define the transient overvoltage condition and includes the impulse withstand voltage regulation. CAT II applies to electrical equipment that is powered through a fixed installation such as a wall outlet wired to a distribution board.

\*3 This instrument is measurement category II product. Do not use for Measurement Categories III and IV.  
Measurement category O applies to measurement of other circuits that are not directly connected to a main power source.  
Measurement Category II applies to electrical equipment that is powered through a fixed installation, such as a wall outlet wired to a distribution board, and to measurement performed on such wiring.  
Measurement category III applies to measurement of facility circuits, such as distribution boards and circuit breakers.  
Measurement category IV applies to measurement of power source circuits, such as entrance cables to buildings and cable systems, for low-voltage installations.

\*4 Pollution Degree applies to the degree of adhesion of a solid, liquid, or gas which deteriorates withstand voltage or surface resistivity. Pollution Degree 1 applies to closed atmospheres (with no, or only dry, non-conductive pollution). Pollution Degree 2 applies to normal indoor atmospheres (with only non-conductive pollution).

\*5 Use cables of length 3 m or less.

## 12.13 External Dimensions

Unit: mm

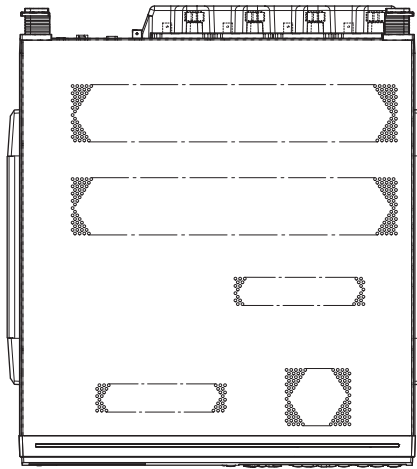

Rear View

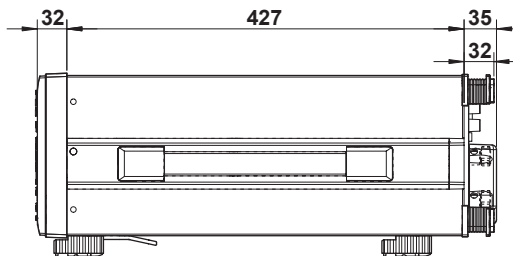
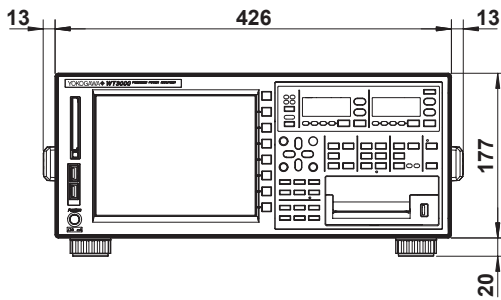
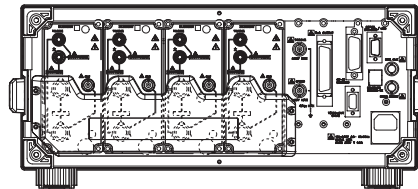

Dimensions with the JIS rack mount kit

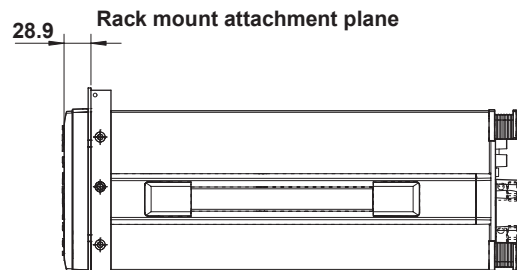
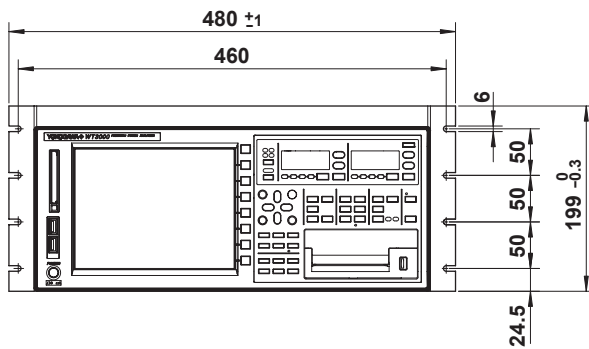

Dimensions with the EIA rack mount kit

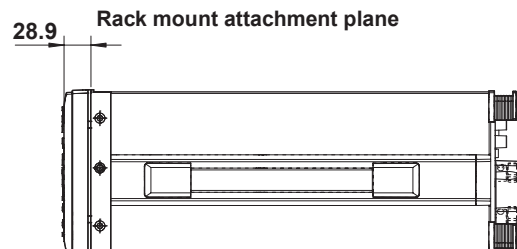
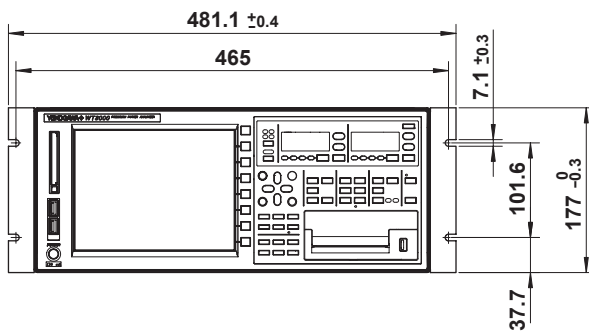

Unless otherwise specified, tolerance is  $\pm 3\%$  (however, tolerance is  $\pm 0.3$  mm when below 10 mm).

# Appendix 1 Symbols and Determination of Measurement Functions

## Measurement Functions during Normal Measurement

(Table 1/3)

Measurement Functions during Normal Measurement	Method of Determination, Equation For details on the symbols in the equation, see the Note on page App-3.			
<b>Voltage</b> <b>U [V]</b> True rms value <b>Urms</b> Rectified mean value calibrated to the rms value <b>Umn</b> Simple average <b>Udc</b> Rectified mean value <b>Urmn</b>	<b>Urms</b>	<b>Umn</b>	<b>Udc</b>	<b>Urmn</b>
	$\sqrt{\text{AVG}[u(n)^2]}$	$\frac{\pi}{2\sqrt{2}} \text{AVG}[ u(n) ]$	<b>AVG</b> [ <b>u</b> ( <b>n</b> )]	<b>AVG</b> [  <b>u</b> ( <b>n</b> ) ]
<b>Current</b> <b>I [A]</b> True rms value <b>Irms</b> Rectified mean value calibrated to the rms value <b>Irn</b> Simple average <b>Idc</b> Rectified mean value <b>Irmn</b>	<b>Irms</b>	<b>Irn</b>	<b>Idc</b>	<b>Irmn</b>
	$\sqrt{\text{AVG}[i(n)^2]}$	$\frac{\pi}{2\sqrt{2}} \text{AVG}[ i(n) ]$	<b>AVG</b> [ <b>i</b> ( <b>n</b> )]	<b>AVG</b> [  <b>i</b> ( <b>n</b> ) ]
<b>Active power P [W]</b>	<b>AVG</b> [ <b>u</b> ( <b>n</b> ) · <b>i</b> ( <b>n</b> ) ]			
<b>Apparent power S [VA]</b> TYPE1, TYPE2 TYPE3	<b>U</b> · <b>I</b>			
	$\sqrt{P^2 + Q^2}$			
<b>Reactive power Q [var]</b> TYPE1, TYPE2 TYPE3	$s \cdot \sqrt{S^2 - P^2}$ s is -1 or 1 for lead phase or lag phase, respectively.			
	$\sum_{k=\min}^{\max} Q(k)$ Q(k) = <b>Ur</b> (k) · <b>Ij</b> (k) – <b>Uj</b> (k) · <b>Ir</b> (k) <b>Ur</b> (k) and <b>Ir</b> (k) are the real part components of <b>U</b> (k) and <b>I</b> (k) <b>Uj</b> (k) and <b>Ij</b> (k) are the imaginary part components of <b>U</b> (k) and <b>I</b> (k) Valid only when harmonics are being measured correctly.			
<b>Power factor λ</b>	$\frac{P}{S}$			
<b>Phase difference φ [°]</b>	$\cos^{-1}\left(\frac{P}{S}\right)$ The phase angle can be switched between lead ( <b>D</b> )/lag ( <b>G</b> ) display and <b>360°</b> display. See section 5.10.			
<b>Voltage frequency fU (FreqU) [Hz]</b> <b>Current frequency fI (FreqI) [Hz]</b>	The voltage frequency ( <b>fU</b> ) and current frequency ( <b>fI</b> ) are measured using zero crossing detection. Two frequencies from the <b>fU</b> and <b>fI</b> of all installed elements (including the PLL source frequency) can be measured simultaneously. On the model with the frequency measurement add-on option, the <b>fU</b> and <b>fI</b> of all elements can be measured simultaneously.			
<b>Maximum voltage U+pk [V]</b>	The maximum <b>u</b> ( <b>n</b> ) for every data update interval			
<b>Minimum voltage U-pk [V]</b>	The minimum <b>u</b> ( <b>n</b> ) for every data update interval			
<b>Maximum current I+pk [A]</b>	The maximum <b>i</b> ( <b>n</b> ) for every data update interval			
<b>Minimum current I-pk [A]</b>	The minimum <b>i</b> ( <b>n</b> ) for every data update interval			
<b>Voltage crest factor CfU</b> <b>Current crest factor CfI</b>	Voltage crest factor $CfU = \frac{Upk}{Urms}$ <b>Upk</b> =   <b>U+pk</b>   or   <b>U-pk</b>  , whichever is greater Displays "-----" when the voltage mode is not <b>RMS</b>		Current crest factor $CfI = \frac{Ipk}{Irms}$ <b>Ipk</b> =   <b>I+pk</b>   or   <b>I-pk</b>  , whichever is greater Displays "-----" when the current mode is not <b>RMS</b>	
<b>Corrected Power Pc [W]</b>	<b>IEC76-1(1976), IEEE C57.12.90-1993</b>		<b>IEC76-1(1993)</b>	
	$\frac{P}{P1 + P2 \left(\frac{Urms}{Umn}\right)^2}$ Coefficients defined in the applicable standard		$P \left(1 + \frac{Umn - Urms}{Umn}\right)$	
Displays "-----" when the voltage mode is not <b>RMS</b> or <b>MEAN</b> .				

(Continues to the next page)

Appendix 1 Symbols and Determination of Measurement Functions

(Table 2/3)

Measurement Functions during Normal Measurement		Method of Determination, Equation For details on the symbols in the equation, see the Note on page App-3.				
Integration	Integration time [h:m:s]	Time from integration start to integration stop.				
	Watt hour [Wh] WP WP+ WP-	$\frac{1}{N} \sum_{n=1}^N u(n) \cdot i(n) \cdot \text{Time}$ <p><b>N</b> is the number of samples over the integration time. The time unit is h.  <b>WP</b> is the sum of positive and negative watt hours.  <b>WP+</b> is the sum of positive <b>P</b> (consumed watt hours).  <b>WP-</b> is the sum of negative <b>P</b> (watt hours returned to the power supply).</p>				
	Ampere hour [Ah] RMS, MEAN, RMEAN	$\frac{1}{N} \sum_{n=1}^N I(n) \cdot \text{Time}$ <p><b>I(n)</b> is the <math>n^{\text{th}}</math> measured current value.  <b>N</b> is the number of data updates.                      The time unit is h.</p>				
	q q+ q-	DC	$\frac{1}{N} \sum_{n=1}^N i(n) \cdot \text{Time}$ <p><b>i(n)</b> is the <math>n^{\text{th}}</math> sampled data of the current signal.  <b>N</b> is the number of data samples.  <b>q</b> is the sum of positive and negative ampere hours.  <b>q+</b> is the sum of positive <b>i(n)</b> (ampere hours).  <b>q-</b> is the sum of negative <b>i(n)</b> (ampere hours).                      The time unit is h.</p>			
	Volt-ampere-hour WS [VAh]	$\frac{1}{N} \sum_{n=1}^N S(n) \cdot \text{Time}$ <p><b>S(n)</b> is the <math>n^{\text{th}}</math> measured apparent power value, and <b>N</b> is the number of data updates.</p>				
	Var-hour WQ [varh]	$\frac{1}{N} \sum_{n=1}^N  Q(n)  \cdot \text{Time}$ <p><b>Q(n)</b> is the <math>n^{\text{th}}</math> measured reactive power value, and <b>N</b> is the number of data updates.</p>				
Σ function	Wiring system	Single-phase, two-wire 1P3W	Three-phase, three-wire 3P3W	Three-phase, three-wire (three-voltage, three-current) 3P3W (3V3A)	Three-phase, four-wire 3P4W	
	UΣ [V]	(U1 + U2) / 2		(U1 + U2 + U3) / 3		
	IΣ [A]	(I1 + I2) / 2		(I1 + I2 + I3) / 3		
	PΣ [W]	P1 + P2			P1 + P2 + P3	
	SΣ [VA]	TYPE1, TYPE2	S1 + S2	$\frac{\sqrt{3}}{2} (S1 + S2)$	$\frac{\sqrt{3}}{3} (S1 + S2 + S3)$	S1 + S2 + S3
		TYPE3	$\sqrt{P\Sigma^2 + Q\Sigma^2}$			
	QΣ [var]	TYPE1	Q1 + Q2			Q1 + Q2 + Q3
		TYPE2	$\sqrt{S\Sigma^2 - P\Sigma^2}$			
TYPE3		Q1 + Q2			Q1 + Q2 + Q3	
PcΣ [W]	Pc1 + Pc2			Pc1 + Pc2 + Pc3		

(Continues to the next page)

(Table 3/3)

Measurement Functions during Normal Measurement		Method of Determination, Equation For details on the symbols in the equation, see the Note on page App-3.				
Σ function	Wiring system	Single-phase, two-wire 1P3W	Three-phase, three-wire 3P3W	Three-phase, three-wire (three-voltage, three-current) 3P3W (3V3A)	Three-phase, four-wire 3P4W	
	WPΣ [Wh]	WPΣ	WP1 + WP2			WP1 + WP2 + WP3
		WP+Σ	WP+1 + WP+2			WP+1 + WP+2 + WP+3
		WP-Σ	WP-1 + WP-2			WP-1 + WP-2 + WP-3
	qΣ [Ah]	qΣ	q1 + q2			q1 + q2 + q3
		q+Σ	q+1 + q+2			q+1 + q+2 + q+3
		q-Σ	q-1 + q-2			q-1 + q-2 + q-3
	WSΣ [VAh]	$\frac{1}{N} \sum_{n=1}^N S_{\Sigma}(n) \cdot \text{Time}$ SΣ(n) is the nth apparent power Σ function. N is the number of data updates.				
	WQΣ [varh]	$\frac{1}{N} \sum_{n=1}^N  Q_{\Sigma}(n)  \cdot \text{Time}$ QΣ(n) is the nth reactive power Σ function. N is the number of data updates.				
	λΣ	$\frac{P_{\Sigma}}{S_{\Sigma}}$				
φΣ [°]	$\cos^{-1}\left(\frac{P_{\Sigma}}{S_{\Sigma}}\right)$					

**Note**

- u(n) denotes the instantaneous voltage (sampled data of the voltage signal).
- i(n) denotes the instantaneous current (sampled data of the current signal).
- AVG[ ] computes the average on the sampled data in the brackets over the measurement period. There are two ways of computing the average, and either one is selected depending on the data update interval. For details on the measurement period and the averaging method, see appendix 7, “Data Update Rate and Computing Equation.”
- PΣA and PΣB denote the active power of the wiring units ΣA and ΣB, respectively. The assignment of input elements to wiring units ΣA and ΣB is determined by the number of input elements that are installed in the WT3000 and the selected wiring system pattern. For details, see section 2.3.
- The numbers 1, 2, and 3 in the equations UΣ, IΣ, PΣ, SΣ, QΣ, PΣC, WPΣ, and qΣ indicate the case when input elements 1, 2, and 3 are set to the wiring system shown in the table. If elements 2, 3, and 4 are set to the wiring system shown in the table, replace the numbers 1, 2, and 3 with 2, 3, and 4, respectively.
- Equation TYPE 3 for SΣ and QΣ can be selected only on models with the advanced computation (/G6) or the harmonic measurement (/G5) option.
- S, Q, λ, and φ on the WT3000 are derived through the computation of the measured values of voltage, current, and active power (except Q is calculated directly from the sampled data when TYPE3 is selected). If distorted signal is input, the value obtained on this instrument may differ from that obtained on other instruments using a different measurement principle.
- For Q [var] computation, when the current leads the voltage, the Q value is displayed as a negative value; when the current lags the voltage, the Q value is displayed as a positive value. The value of QΣ may be negative, because it is calculated from Q of each element including the sign.

For details on the measurement functions of the motor evaluation function, see section 1.10 in the *Expansion Function User’s Manual IM760301-51E*.

For details on the measurement functions of harmonic measurement, see section 7.11 in the *Expansion Function User’s Manual IM760301-51E*.

## Appendix 2 List of Initial Settings and Display Order of Numeric Data

### Initial Settings (Factory Default, Example for a Model with Four Input Elements Installed)

The default settings vary depending on the number of installed input elements and the presence/absence of options.

Item	Setting		
RANGE	2-A input element	30-A input element	
U Range	1000 V	1000 V	
I input Terminal	Direct	Direct	
I Direct input Range	2 A	30 A	
External Sensor Range	10 V	10 V	
SENSOR RATIO	10.0000 mV/A		
WIRING			
Wiring Setting	1P2W		
$\eta$ Formula			
$\eta$ 1	$P_{\Sigma B}/P_{\Sigma A}$		
$\eta$ 2	$P_{\Sigma A}/P_{\Sigma B}$		
$\eta$ 3	Off/1		
$\eta$ 4	Off/1		
Udef1	P1+None+None+None		
Udef2	P1+None+None+None		
Compensation			
Wiring Compensation	Off		
Efficiency Compensation	Off		
Element Independent	Off		
$\Delta$ Measure	-		
SCALING			
Scaling	Off		
Scaling Item	VT		
VT	1.0000		
CT	1.0000		
Scaling Factor	1.0000		
LINE FILTER	Off		
FREQ FILTER	Off		
AVG			
Averaging	Off		
Averaging Type	Exp.		
Exp. Count	2		
Lin. Count	8		
MEASURE			
User Defined	On/Off	Unit	Expression
Function1	Off	V	UMN(E1)
Function2	Off	V	UMN(E2)
Function3	Off	V	UMN(E3)
Function4	Off	V	UMN(E4)
Function5	Off	V	U(E1,ORT)
Function6	Off	A	I(E1,ORT)
Function7	Off	V	U(E1,ORT)
Function8	Off	A	I(E1,ORT)
Function9	Off	V	U(E1,ORT)
Function10	Off	A	I(E1,ORT)
Function11	Off	V	U(E1,ORT)
Function12	Off	A	I(E1,ORT)
Function13	Off	V	U(E1,ORT)
Function14	Off	A	I(E1,ORT)
Function15	Off	V	U(E1,ORT)
Function16	Off	A	I(E1,ORT)
Function17	Off	V	U(E1,ORT)
Function18	Off	A	I(E1,ORT)
Function19	Off	V	U(E1,ORT)
Function20	Off	A	I(E1,ORT)
Max Hold	Off		



## Appendix 2 List of Initial Settings and Display Order of Numeric Data

Item	Setting			
S,Q Formula	Type1			
Pc Formula	IEC76-1 (1976)			
P1 and P2 of IEC76-1 (1993)	P1 = 0.5000, P2 = 0.5000			
Sampling Frequency	Auto			
Phase	180 Lead/Lag			
Sync Measure	Master			
<b>SYNC SOURCE</b>				
Element Object	Element1	Element2	Element3	Element4
Sync Source	I1	I2	I3	I4
<b>UPDATE RATE</b>				
Update Rate	500 ms (EAMP)			
<b>HOLD</b>				
Hold	Off			
<b>INTEGRATOR</b>				
Integrator Status	Reset status			
Integ Set				
Mode	Normal			
Timer Setting	00000:00:00			
Integ Start	2006/01/01 00:00:00			
Integ End	2006/01/01 01:00:00			
Auto Cal	Off			
D/A Rated Time	00001:00:00 (displayed when the optional D/A output is installed)			
<b>ITEM (for Numeric)</b>				
Item No.	1			
Function	U			
Element/ $\Sigma$	Element1			
Order	-			
Frequency Meas. Item	U1, I1			
<b>FORM (for Numeric)</b>				
Numeric Form	4 Items			
<b>ITEM (for Wave)</b>				
Wave Display				
On	U1 to I4, Speed, Torque			
V Zoom & Position				
Element Object	Element1			
(U) V Zoom	x1			
(U) Position	0.000%			
(I) V Zoom	x1			
(I) Position	0.000%			
<b>FORM (for Wave)</b>				
Format	Single			
Time/div	5 ms			
Trigger				
Mode	Auto			
Source	U1			
Slope	Rise			
Level	0.0%			
Display Setting				
Interpolate	Line			
Graticule	Grid(■)			
Scale Value	On			
Label	Off			
Wave Mapping				
Mode	Auto			
User Setting	U1:0, I1:0, U2:1, I2:1, U3:2, I3:2, U4:3, I4:3, Speed:0, Torque:0, Math1:1, Math2:1			
<b>ITEM (for Bar, displayed on models with the advanced computation (/G6) or harmonic measurement (/G5) option.)</b>				
Bar Item No.	1	2	3	
Function	U	I	P	
Element	Element1	Element1	Element1	

## Appendix 2 List of Initial Settings and Display Order of Numeric Data

Item	Setting
FORM (for Bar, displayed on models with the advanced computation (/G6) or harmonic measurement (/G5) option)	
Format	Single
Start Order	1
End Order	100
ITEM (for Trend)	
Trend Display	
On	T1 to T8
Trend Items	
Trend Object	T1
Function	U
Element	Element1
Order	-
Trend Scale	
Trend Object	T1
Scaling	Auto
Upper Scale	1.000E+02
Lower Scale	-1.000E+02
FORM (for Trend)	
Trend Format	Single
Trend T/div	3 s/div
Display Setting	Common to Form (for Wave)
FORM (for Vector, displayed on models with the advanced computation (/G6) or harmonic measurement (/G5) option)	
Object	$\Sigma A$
Numeric	On
U Mag	1.000
I Mag	1.000
ITEM (for MATH, displayed on models with the advanced computation (/G6) option)	
Wave/Math Display	
On	Common to ITEM (for Wave)
V Zoom & Position	Common to ITEM (for Wave)
Math Setup	
Math1 Expression	U1*11
Scale	Auto
Center	0.0000E+00
Scale/div	2.5000E+01
Unit	W
Label	Math1
Math2 Expression	ABS(U1)
Scale	Auto
Center	0.0000E+00
Scale/div	2.5000E+01
Unit	V
Label	Math2
Constant	
K1	1.0000E+00
K2	2.0000E+00
K3	3.0000E+00
K4	4.0000E+00
K5	5.0000E+00
K6	6.0000E+00
K7	7.0000E+00
K8	8.0000E+00
FORM (for MATH, displayed on models with the advanced computation (/G6) option)	
Common to FORM (for Wave)	
ITEM (for FFT, displayed on models with the advanced computation (/G6) option)	
FFT1 Display	On
FFT1 Object	FFT(U1)
FFT1 Label	FFT1
FFT2 Display	On
FFT2 Object	FFT(I1)
FFT2 Label	FFT2

## Appendix 2 List of Initial Settings and Display Order of Numeric Data

Item	Setting
FORM (for FFT, displayed on models with the advanced computation (/G6) option)	
Format	Single
FFT Points	20k
Trigger	Common to FORM (for Wave)
Display Setting	
Interpolate	Common to FORM (for Wave)
Graticule	Common to FORM (for Wave)
Scale Value	Common to FORM (for Wave)
Spectrum Type	Line
FFT Window	Rect
Disp Start	0
Disp End	10000
Vertical Scale	Log
ITEM (for flicker, displayed on models with the voltage fluctuation and flicker measurement (/FL) option)	
Display Elem.	Element1
Limit Settings	
Judgement	
dc	ON
dmax	ON
d(t)	ON
Pst	ON
Plt	ON
Limit	
dc	3.30%
dmax	4.00%
d(t)	500 ms, 3.30%
Pst	1.00
Plt	0.65
Plt N value	12
FORM (for flicker, displayed on models with the voltage fluctuation and flicker measurement (/FL) option)	
Measurement	Flicker
Flicker Settings	
Object	Element1
Un mode	Auto
Un Set	230.00 V
Frequency	50 Hz
Interval	10 min 00 sec
Count	12
dmin	0.10%
ITEM (for cycle by cycle, displayed on models with the cycle-by-cycle measurement (/CC) option)	
List Item No.	1            2            3            4            5
Function	Freq    U            I            P            S
Element/ $\Sigma$	Element1   Element1   Element1   Element1   Element1
Cursor No.	1
FORM (for cycle by cycle, displayed on models with the cycle-by-cycle measurement (/CC) option)	
Sync Source	U1
Sync Slope	Rise
Trigger	Common with FORM (for Wave)
Cycle Count	100
Time out	10
USER SET	
Function1	U+peak
Function2	U-pea
Function3	I+peak
Function4	I-peak

## Appendix 2 List of Initial Settings and Display Order of Numeric Data

Item	Setting
CURSOR (for Wave)	
Wave Cursor	Off
Wave C1 Trace	U1
Wave C2 Trace	I1
Cursor Path	Max
Wave C1 +	10.0 ms
Wave C2 ×	40.0 ms
CURSOR (for Bar, displayed on models with the advanced computation (/G6) or harmonic measurement (/G5) option)	
Bar Cursor	Off
Bar C1 +	1 order
Bar C2 ×	15 order
CURSOR (for Trend)	
Trend Cursor	Off
Trend C1 Trace	T1
Trend C2 Trace	T2
Trend C1 +	100
Trend C2 ×	900
Cursor (for MATH, displayed on models with the advanced computation (/G6) option) Common to Cursor (for Wave)	
Cursor (for FFT, displayed on models with the advanced computation (/G6) option)	
Trend Cursor	Off
Trend C1 Trace	T1
Trend C2 Trace	T2
Trend C1 +	100
Trend C2 ×	900
HRM SET	
Freq Band	Normal
PLL Source	U1
Min Order	1
Max Order	100
Thd Formula	1/Total
STORE	
Store Status	Off
STORE SET	
Mode	Store
Store To	Memory
Store Settin	
Mode	Manual
Count	100
Store Interval	00:00:00
Store Item	Numeric
List Item	Element1
	U, I, P, S, Q, λ, φ FreqU, FreqI
FILE	
File Item	Setup
IMAGE SAVE	
Format	TIFF
Color	Off
AUTO Naming	ON
NULL	
Null	Off

## Appendix 2 List of Initial Settings and Display Order of Numeric Data

Item	Setting			
MOTOR SET (displayed on models with the motor evaluation function on the motor version)				
Scaling (Speed)	1.0000			
Scaling (Torque)	1.0000			
Scaling (Pm)	1.0000			
Unit (Speed)	rpm			
Unit (Torque)	Nm			
Unit (Pm)	W			
Analog				
Auto Range (Speed)	Off			
Auto Range (Torque)	Off			
Range (Speed)	20V			
Range (Torque)	20V			
Line Filter	Off			
Sync Source	None			
Pulse				
Range Upper (Speed)	10000.0000			
Range Upper (Torque)	50.0000			
Range Lower (Speed)	0.0000			
Range Lower (Torque)	-50.0000			
Rated Upper (Torque)	50.0000			
Rated Upper (Rated Freq)	15000 Hz			
Rated Lower (Torque)	-50.0000			
Rated Lower (Rated Freq)	5000 Hz			
Pulse N (Speed)	60			
Sync Speed				
Pole	2			
Source	I1			
PRINT MENU (applies to models with the built-in printer option)				
Print to	Built-in			
Print Format	Hard Copy			
D/A Output (applies to models with the D/A output option)				
Item No.	Function	Element/S	Order	Range Mode
1	U	Element 1	–	Fixed
2	I	Element 1	–	Fixed
3	P	Element 1	–	Fixed
4	S	Element 1	–	Fixed
5	Q	Element 1	–	Fixed
6	I	Element 1	–	Fixed
7	f	Element 1	–	Fixed
8	fU	Element 1	–	Fixed
9	fl	Element 1	–	Fixed
10 to 20	–	–	–	Fixed

## Appendix 2 List of Initial Settings and Display Order of Numeric Data

---

### Settings That Are Not Initialized through Initialization (MISC-Initialize Settings)

---

Item	Setting
MISC	
Remote Control	
Device <sup>*1</sup>	GP-IB
GP-IB	
Address <sup>*1</sup>	1
RS232 (displayed on models with the RS232 communication option)	
Baud Rate <sup>*1</sup>	19200
Format <sup>*1</sup>	8-No-1
Rx-Tx <sup>*1</sup>	No-No
Terminator <sup>*1</sup>	Cr+Lf
Date/Time	
Display <sup>*1</sup>	On
Type <sup>*1</sup>	Manual
Config	
Message Language <sup>*1</sup>	ENG
Menu Language <sup>*1</sup>	ENG
Alphabet Font <sup>*1</sup>	Gothic
LCD Brightness	2
Key Lock <sup>*2</sup>	Off
Shift Lock	Off
Crest Factor	CF3
Graph Color	
Mode	Default
Text Color	
Mode	Preset 1

\*1 Settings that are not initialized through initialization (MISC-Initialize Settings)

\*2 Initialized when the \*RST command is sent from the communication interface.

**Example of the Display Order of Numeric Data (Example for a Model with Four Input Elements Installed)**

- When the order of the numeric data is reset, the measurement function data are displayed in the order given in the next table.
- For details on each display, see section 5.1 as well as sections 1.1 and 7.1 in the *Expansion Function User's Manual IM760301-51E*.

**4 Item Display**

Display Page								
1	2	3	4	5	6	7	8	9
U1	U2	U3	U4	UΣA	UΣB	WP1	WPΣA	η1
I1	I2	I3	I4	IΣA	IΣB	WP2	WPΣB	Speed*1
P1	P2	P3	P4	PΣA	PΣB	WP3	F1	Torque*1
λ1	λ2	λ3	λ4	λΣA	λΣB	WP4	F2	Pm*1

**8 Item Display**

Display Page								
1	2	3	4	5	6	7	8	9
U1	U2	U3	U4	UΣA	UΣB	WP1	WPΣA	η1
I1	I2	I3	I4	IΣA	IΣB	q1	qΣA	η2
P1	P2	P3	P4	PΣA	PΣB	WP2	WPΣB	η3
S1	S2	S3	S4	SΣA	SΣB	q2	qΣB	η4
Q1	Q2	Q3	Q4	QΣA	QΣB	WP3	F1	Speed*1
λ1	λ2	λ3	λ4	λΣA	λΣB	q3	F2	Torque*1
φ1	φ2	φ3	φ4	φΣA	φΣB	WP4	F3	SyncSp*1
fU(FreqU)1	fU(FreqU)2	fU(FreqU)3	fU(FreqU)4	–	–	q4	F4	Pm*1

**16 Item Display**

Display Page								
1	2	3	4	5	6	7	8	9
U1	U2	U3	U4	UΣA	WP1	WP3	WPΣA	F1
I1	I2	I3	I4	IΣA	WP+1	WP+3	WP+ΣA	F2
P1	P2	P3	P4	PΣA	WP-1	WP-3	WP-ΣA	F3
S1	S2	S3	S4	SΣA	q1	q3	qΣA	F4
Q1	Q2	Q3	Q4	QΣA	q+1	q+3	q+ΣA	η1
λ1	λ2	λ3	λ4	λΣA	q-1	q-3	q-ΣA	η2
φ1	φ2	φ3	φ4	φΣA	WS1	WS3	WSΣA	η3
Pc1	Pc2	Pc3	Pc4	PcΣA	WQ1	WQ3	WQΣA	η4
fU(FreqU)1	fU(FreqU)2	fU(FreqU)3	fU(FreqU)4	UΣB	WP2	WP4	WPΣB	Speed*1
fl(Freql)1	fl(Freql)2	fl(Freql)3	fl(Freql)4	IΣB	WP+2	WP+4	WP+ΣB	Torque*1
U+pk1	U+pk2	U+pk3	U+pk4	PΣB	WP-2	WP-4	WP-ΣB	SyncSp*1
U-pk1	U-pk2	U-pk3	U-pk4	SΣB	q2	q4	qΣB	Slip*1
I+pk1	I+pk2	I+pk3	I+pk4	QΣB	q+2	q+4	q+ΣB	Pm*1
I-pk1	I-pk2	I-pk3	I-pk4	λΣB	q-2	q-4	q-ΣB	–
CfU1	CfU2	CfU3	CfU4	φΣB	WS2	WS4	WSΣB	–
Cfl1	Cfl2	Cfl3	Cfl4	PcΣB	WQ2	WQ4	WQΣB	–

## Appendix 2 List of Initial Settings and Display Order of Numeric Data

### ALL Item Display

Display Page								
1	2	3	4	5	6*2	7*2	8*2	9*2
U	U+pk	Time	$\eta_1$	F1	U(k)	U(k)	Uthd	$\phi U1-U2$
I	U-pk	Wp	$\eta_2$	F2	I(k)	I(k)	lthd	$\phi U1-U3$
P	I+pk	WP+	$\eta_3$	F3	P(k)	P(k)	Pthd	$\phi U1-I1$
S	I-pk	WP-	$\eta_4$	F4	S(k)	Q(k)	Uthf	$\phi U1-I2$
Q	CfU	q	$\Delta F1$	F5	Q(k)	Z(k)	lthf	$\phi U1-I3$
$\lambda$	Cfl	q+	$\Delta F2$	F6	$\lambda(k)$	Rs(k)	Utif	
$\phi$	Pc	q-	$\Delta F3$	F7	$\phi(k)$	Xs(k)	Itif	
fU(FreqU)		WS	$\Delta F4$	F8	$\phi U(k)$	Rp(k)	hvf	
fI(FreqI)		WQ	Speed*1	F9	$\phi I(k)$	Xp(k)	hcf	
			Torque*1	F10				
			SyncSp*1	F11				
			Slip*1	F12				
			Pm*1	F13				
				F14				
				F15				
				F16				
				F17				
				F18				
				F19				
				F20				

### Left Side of the SingleList\*2 or DualList\*2 Display

Display Page						
1	2	3	4	5	6	7
U1	U2	U3	U4	U $\Sigma$ A	U $\Sigma$ B	F1
I1	I2	I3	I4	I $\Sigma$ A	I $\Sigma$ B	F2
P1	P2	P3	P4	P $\Sigma$ A	P $\Sigma$ B	F3
S1	S2	S3	S4	S $\Sigma$ A	S $\Sigma$ B	F4
Q1	Q2	Q3	Q4	Q $\Sigma$ A	Q $\Sigma$ B	F5
$\lambda_1$	$\lambda_2$	$\lambda_3$	$\lambda_4$	$\lambda\Sigma A$	$\lambda\Sigma B$	F6
$\phi_1$	$\phi_2$	$\phi_3$	$\phi_4$	$\phi U1-U2$	$\phi U1-U2$	F7
Uthd1	Uthd2	Uthd3	Uthd4	$\phi U1-U3$	$\phi U1-U3$	F8
lthd1	lthd2	lthd3	lthd4	$\phi U1-I1$	$\phi U1-I1$	F9
Pthd1	Pthd2	Pthd3	Pthd4	$\phi U1-I2$	$\phi U1-I2$	F10
Uthf1	Uthf2	Uthf3	Uthf4	$\phi U1-I3$	$\phi U1-I3$	F11
lthf1	lthf2	lthf3	lthf4			F12
Utif1	Utif2	Utif3	Utif4			F13
Itif1	Itif2	Itif3	Itif4			F14
						F15
						F16
						F17
						F18
						F19
						F20

\*1 Displayed only on models with the motor evaluation function (motor version).

\*2 Displayed only on models with the advanced computation (/G6) or harmonic measurement (/G5) option.



## Appendix 3 ASCII Header File Format

When waveform display data (Wave) is saved, the following two files are automatically created in the directory.

- Waveform display data file (.wvf)
- ASCII header file (.hdr)

The ASCII header files explained here cannot be viewed on the WT3000. Use the data in such cases as when analyzing the waveforms on your PC.

//YOKOGAWA ASCII FILE FORMAT

\$PublicInfo

FormatVersion 1.11  
Model WT3000  
Endian Big  
DataFormat Trace  
GroupNumber 3  
TraceTotalNumber 10  
DataOffset 8192

\$Group1

TraceNumber	4			
BlockNumber	1			
TraceName	U1	I1	U2	I2
BlockSize	1002	1002	1002	1002
VResolution	1.000000E+00	1.000000E+00	1.000000E+00	1.000000E+00
VOffset	0.000000E+00	0.000000E+00	0.000000E+00	0.000000E+00
VDataType	FS4	FS4	FS4	FS4
VUnit	V	A	V	A
VPlusOverData	?	?	?	?
VMinusOverData	?	?	?	?
VIllegalData	?	?	?	?
VMaxData	9.000000e+02	3.000000e+03	3.000000e+03	1.500000e+02
VMinData	-9.000000e+02	-3.000000e+03	-3.000000e+03	-1.500000e+02
HResolution	2.000000E-05	2.000000E-05	2.000000E-05	2.000000E-05
HOffset	0.000000E+00	0.000000E+00	0.000000E+00	0.000000E+00
HUnit	sec	sec	sec	sec
Date	2001/06/30	2001/06/30	2001/06/30	2001/06/30
Time	07:03:03	07:03:03	07:03:03	07:03:03

\$Group2

TraceNumber	4			
BlockNumber	1			
TraceName	U3	I3	U4	I4
BlockSize	1002	1002	1002	1002
VResolution	1.000000E+00	1.000000E+00	1.000000E+00	1.000000E+00

### Appendix 3 ASCII Header File Format

---

VOffset	0.000000E+00	0.000000E+00	0.000000E+00	0.000000E+00
VDataType	FS4	FS4	FS4	FS4
VUnit	V	A	V	A
VPlusOverData	?	?	?	?
VMinusOverData	?	?	?	?
VIllegalData	?	?	?	?
VMaxData	3.000000e+03	1.500000e+01	3.000000e+03	1.500000e+01
VMinData	-3.000000e+03	-1.500000e+01	-3.000000e+03	-1.500000e+01
HResolution	2.000000E-05	2.000000E-05	2.000000E-05	2.000000E-05
HOffset	0.000000E+00	0.000000E+00	0.000000E+00	0.000000E+00
HUnit	sec	sec	sec	sec
Date	2001/06/30	2001/06/30	2001/06/30	2001/06/30
Time	07:03:03	07:03:03	07:03:03	07:03:03

#### \$Group3

TraceNumber	2	
BlockNumber	1	
TraceName	Speed	Torque
BlockSize	1002	1002
VResolution	1.000000E+00	1.000000E+00
VOffset	0.000000E+00	0.000000E+00
VDataType	FS4	FS4
VUnit	rpm	Nm
VPlusOverData	?	?
VMinusOverData	?	?
VIllegalData	?	?
VMaxData	2.000000e+01	2.000000e+01
VMinData	-2.000000e+01	-2.000000e+01
HResolution	2.000000E-05	2.000000E-05
HOffset	0.000000E+00	0.000000E+00
HUnit	sec	sec
Date	2001/08/30	2001/08/30
Time	07:03:03	07:03:03

#### \$PrivateInfo

ModelVersion	1.01
--------------	------

(Note) The header file is a common file used by YOKOGAWA's measuring instruments. Therefore, data that is not required by the WT3000 (0s) is also included.

- **\$PublicInfo (Common Information)**

FormatVersion: Header file version No. (common to YOKOGAWA's header files)  
 Model: Model name  
 Endian: Endian mode when saving data (Big)<sup>\*1</sup>  
 DataFormat: Storage format of the binary waveform display data (Trace)<sup>\*2</sup>  
 GroupNumber: The number of "\$Group"s indicated below  
 TraceTotalNumber: Total number of target waveforms  
 DataOffset: Start position of the binary waveform display data<sup>\*3</sup>

- **\$Group1 (Group Information)**

TraceNumber: Number of waveforms in this group  
 BlockNumber: Number of blocks in this group<sup>\*4</sup>  
 TraceName: Name of each waveform  
 BlockSize: Number of data points in a single block of each waveform  
 VResolution: Value of coefficient VResolution of the Y-axis conversion equation of each waveform<sup>\*5</sup>  
 VOffset: Value of coefficient VOffset of the Y-axis conversion equation of each waveform<sup>\*5</sup>  
 VDataType: Type of binary waveform display data of each waveform<sup>\*6</sup>  
 VUnit: Unit used on the Y-axis of each waveform (no effect on the data)  
 VPlusOverData: Error data when the binary data of each waveform is greater than or equal to this value  
 VMinusOverData: Error data when the binary data of each waveform is less than or equal to this value  
 VMaxData: Maximum value of the binary data of each waveform  
 VMinData: Minimum value of the binary data of each waveform  
 HResolution: Value of coefficient HResolution of the X-axis conversion equation of each waveform  
 HOffset: Value of coefficient HOffset of the X-axis conversion equation of each waveform  
 HUnit: Unit used on the X-axis of each waveform (no effect on the data)  
 Date: Date when the trigger occurred  
 Time: Time when the trigger occurred

- **\$PrivateInfo (Model-Specific Information)**

ModelVersion: Version No. of the instrument

\*1 Endian mode when saving data  
 Big: Motorola 68000-family data

\*2 Storage format of the binary waveform display data  
 Trace: Format in which each block contains a waveform

\*3 Start position of the binary waveform display data  
 Offset from the beginning of the file. Always 8192 on the WT3000

\*4 Maximum number of blocks in the group  
 Maximum number of blocks when the number of blocks varies for each waveform. Always 1 on the WT3000.

\*5 Y axis conversion equation for each waveform  
 $Y\text{-axis value} = V\text{Resolution} \times \text{raw data} + V\text{Offset}$

\*6 Data type  
 ISn: n-byte signed integer  
 IUn: n-byte unsigned integer  
 FSn: n-byte signed real number  
 FUn: n-byte unsigned real number  
 Bm: m-bit data

# Appendix 4 Power Basics (Power, Harmonics, and RLC of AC Circuits)

This chapter describes the basics of power, harmonic, and RLC of AC circuits.

## Power

Electrical energy is converted into other types of energy for use such as in the form of heat for electrical heaters and furnaces, turning force for motors, and light for fluorescent lamps or mercury lamps. Electric power refers to the work that electricity performs on these types of loads expressed in terms of the quantity per unit time. The unit is watts (W), and electric energy that performs 1 joule of work in 1 second equals 1 W.

- **DC Power**

DC power  $P$  [W] is determined by the product of the applied voltage  $U$  [V] and the current  $I$  [A] that flows.

$$P = UI \text{ [W]}$$

In the example below, this amount of electric energy is retrieved from the power supply and consumed by resistance  $R$  [ $\Omega$ ] every second.



- **Alternating Current (AC)**

Normally, the power supplied by the power company is alternating current, and the waveform is sinusoidal. The size of alternating current can be expressed in terms of the instantaneous value, maximum value, rms value, and mean value. Normally, it is expressed in terms of the rms value.

The instantaneous value  $i$  of the sinusoidal alternating current is expressed by  $I_m \sin \omega t$  (where  $I_m$  is the maximum value of current,  $\omega$  is the angular velocity defined as  $\omega = 2\pi f$ , and  $f$  is the frequency of the sinusoidal alternating current). The thermal action of this alternating current\* is proportional to  $i^2$ , and varies as shown in the figure below.

\* The phenomenon in which electric energy is converted to heat energy due to the current flowing through the resistor.

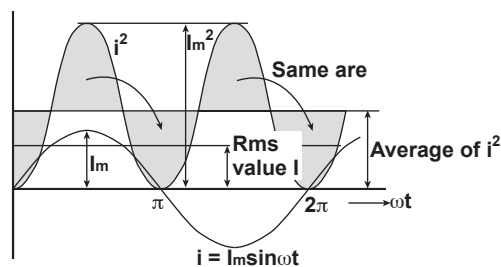

The rms value (effective value) is the DC value that generates the same thermal action as the alternating current. If we denote the DC value of the same thermal action as  $I$ , we get

$$I = \sqrt{\text{The average of } i^2 \text{ over one cycle}} = \sqrt{\frac{1}{2\pi} \int_0^{2\pi} i^2 d\omega t} = \frac{I_m}{\sqrt{2}}$$

Because this value corresponds to the root mean square of the instantaneous values over 1 period, normally the effective value is denoted using the abbreviation *rms*.

In the case of the mean value, simply taking the average over 1 period of the sine wave results in zero. Therefore, the average is taken over 1 period of absolute values. As with the rms value, if we denote the average value of the current of instantaneous values  $i = I_m \sin \omega t$  as  $I_{mn}$ , we obtain

$$I_{mn} = |i| \text{ The average of } i \text{ over one cycle} = \frac{1}{2\pi} \int_0^{2\pi} |i| d\omega t = \frac{2}{\pi} I_m$$

These relationships also apply to a sinusoidal voltage.

The maximum value, rms value, and average value of a sinusoidal alternating current are related as shown below. Crest factor and form factor are used to define the tendency of the AC waveform.

$$\text{Crest factor (crest factor)} = \frac{\text{Maximum value}}{\text{Rms value}}$$

$$\text{Form factor (form factor)} = \frac{\text{Rms value}}{\text{Average value}}$$

• **Vector Display of Alternating Current**

In general, the instantaneous value of voltage and current is expressed with the following equations.

Voltage:  $u = U_m \sin \omega t$

Current:  $i = I_m \sin(\omega t - \phi)$

The time offset between the voltage and current is called a phase difference, and  $\phi$  is called a phase angle. This time difference is mainly caused by the load to which the power is supplied. In general, the phase difference is zero when the load consists of only resistance. If the load consists of inductance (coiled object), the current lags the voltage. If the load consists of capacitance, the current leads the voltage.

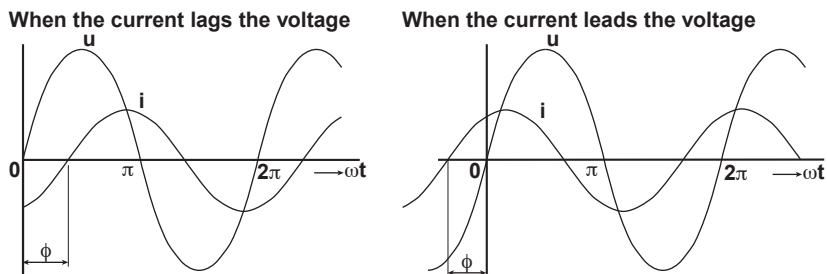

Vector display is used to easily convey the size and phase relationships between the voltage and current. The upward direction on the vertical axis is the reference, and a positive phase angle is represented by an angle in the counterclockwise direction. Normally, a dot is placed above the symbol representing the quantity when explicitly indicating that it is a vector. The size of the vector represents the rms value.

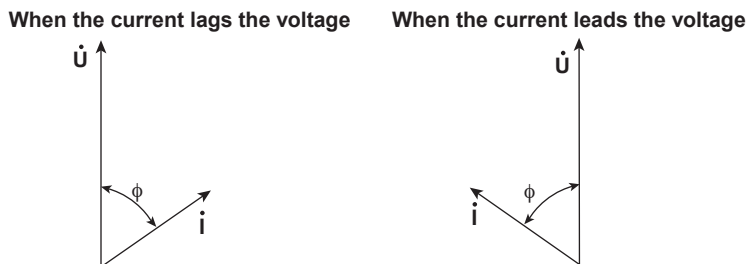

• **Wiring Three-Phase AC Power and Load**

Generally, the power lines are connected using star wiring or delta wiring on three-phase power supplies and loads.



• **Vector Display of Three-Phase AC Power or Load**

Generally the voltage of each phase of a three-phase AC power or load is offset by  $120^\circ$ . Below is an illustration of a three-phase AC power using vectors. The voltage of each phase is called the phase voltage, and the voltage between each phase is called the line voltage.

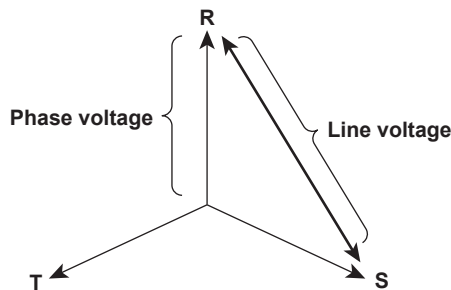

If the power or load is connected in a delta wiring configuration and no neutral line is present, the phase voltage cannot be measured. In this case, the line voltage is measured. In addition, the line voltage is sometimes measured when measuring a three-phase AC power using two single-phase wattmeters (called the two-wattmeter method). If the magnitude of the phase voltage of each phase is equal and each phase is offset by  $120^\circ$ , the line voltage is  $\sqrt{3}$  times the phase voltage, and the phase is offset by  $30^\circ$ .

Below is a vector representation of the relationship between the phase voltage and line current of a three-phase AC voltage or load whose current phase is lagging the voltage phase by  $\phi^\circ$ .

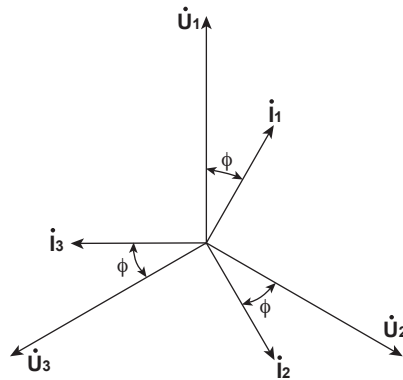

• **AC Power**

Because there is phase difference between the voltage and current due to the load, AC power cannot be determined as easily as DC power.

If we denote the instantaneous voltage as  $u = U_m \sin \omega t$  and the instantaneous current as  $i = I_m \sin(\omega t - \phi)$ , the instantaneous power of AC power  $p$  is as follows:

$$p = u \times i = U_m \sin \omega t \times I_m \sin(\omega t - \phi) = UI \cos \phi - UI \cos(2\omega t - \phi)$$

$U$  and  $I$  represent the rms voltage and current, respectively.

$p$  is the sum of the time-independent term " $UI \cos \phi$ " and the AC component term of the voltage or current at twice the frequency " $-UI \cos(2\omega t - \phi)$ ."

AC power refers to the average power over 1 period. By taking the average over 1 period, AC power  $P$  becomes

$$P = UI \cos \phi \text{ [W]}$$

The power varies even with the same voltage and current depending on the phase difference  $\phi$ . The section above the horizontal axis in the figure below represents positive power (power supplied to the load), and the section below the axis represents negative power (power fed back from the load). The difference between the positive and negative powers is the power consumed by the load. As the phase difference between the voltage and current increases, the negative power increases. At  $\phi = \pi/2$ , the positive and negative powers are equal, and the load consumes no power.

When the phase difference between voltage and current is 0

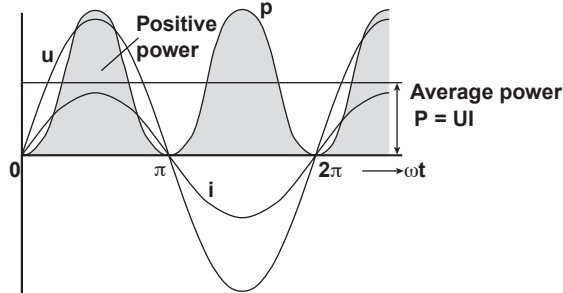

When the phase difference between voltage and current is  $\phi$

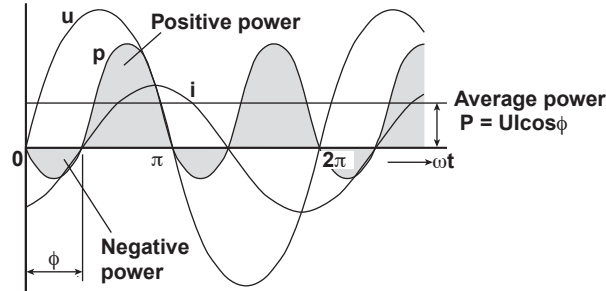

When the phase difference between voltage and current is  $\frac{\pi}{2}$

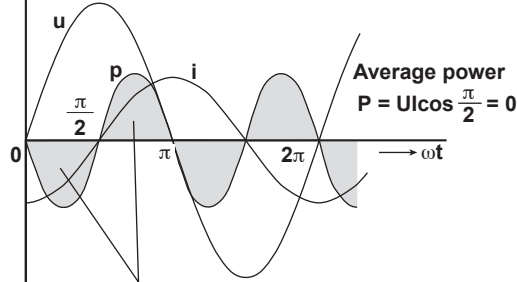

The positive and negative powers are the same.

- **Active Power and Power Factor**

In alternating electrical current, not all of the power calculated by the product of voltage and current  $UI$  is consumed. The product  $UI$  is called apparent power  $S$ . The unit is VA (volt-ampere). The apparent power is used to express the electrical capacity of a device that runs on AC electricity.

The true power that a device consumes is called active power  $P$  (or effective power), and this corresponds to the aforementioned AC power.

$$S = UI \text{ [VA]}$$

$$P = UI\cos\phi \text{ [W]}$$

$\cos\phi$  indicates the ratio of the apparent power that becomes the true power, and this is called power factor  $\lambda$ .

- **Reactive Power**

If current  $I$  lags voltage  $U$  by  $\phi$ , current  $I$  can be broken down into a component in the same direction as voltage  $U$ ,  $I\cos\phi$ , and a perpendicular component,  $I\sin\phi$ . Active power  $P = UI\cos\phi$  is the product of voltage  $U$  and current component  $I\cos\phi$ . On the contrary, the product of voltage  $U$  and current component  $I\sin\phi$  is called the reactive power  $Q$ , and the unit is var.

$$Q = UI\sin\phi \text{ [var]}$$

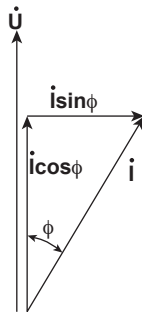

Below is the relationship between the apparent power  $S$ , active power  $P$ , and reactive power  $Q$ .

$$S^2 = P^2 + Q^2$$



## Harmonics

Harmonics refer to sine waves whose frequency is an integer multiple of the fundamental wave (normally sine waves of commercial frequency 50-Hz or 60-Hz) excluding the fundamental frequency. The input current that flows through the power rectification circuit, phase control circuit, and other circuits used in various electric and electronic equipment generate harmonic current or voltage on the power line. When the fundamental and harmonic waves are combined, distortion occurs in the waveform, and interference sometimes occur in equipment connected to the power line.

- **Terminology**

Terminology related to harmonics is described below.

- **Fundamental wave (fundamental component)**  
The sine wave with the longest period among the different sine waves derived from the periodic complex wave. Or the sine wave that has the fundamental frequency within the components of the complex wave.
- **Fundamental frequency**  
The frequency corresponding to the longest period in the periodic complex wave. The frequency of the fundamental wave.
- **Distorted wave**  
A wave that differs from the fundamental wave.
- **Higher harmonic**  
A sine wave with frequency that is an integer multiple (twice or greater) of the fundamental frequency.
- **Harmonic component**  
A waveform component with frequency that is an integer multiple (twice or greater) of the fundamental frequency.
- **Harmonic distortion factor**  
The ratio of the rms value of the specified  $n^{\text{th}}$  order harmonic contained in the distorted wave to the rms value of the fundamental wave (or all waves).
- **Harmonic order**  
Integer ratio of the harmonic frequency with respect to the fundamental frequency.
- **Total harmonic distortion**  
The ratio of the rms value of all harmonics to the rms value of the fundamental wave (or all waves).

- **Interference Caused by Harmonics**

Below are some of the effects on electric devices and equipment caused by harmonics.

- **Condenser and series reactor**  
Harmonic current reduces the circuit impedance causing excessive current to flow. This results in vibration, beat, overheat, or burnout.
- **Cable**  
Harmonic current flows through the neutral line of a three-phase, four-wire system causing the neutral line to overheat.
- **Transformer**  
Causes magnetostrictive noise of the iron core and increases iron loss and copper loss.
- **Breaker and fuse**  
Excessive harmonic current causes erroneous operation and fuse to blow.
- **Communication line**  
Electromagnetic induction causes noise voltage.
- **Controller**  
Distorted control signal causes erroneous operation.
- **Audio visual equipment**  
Causes degradation of performance and service life, flickering of video caused by noise, and malfunction of parts.

**RLC of AC Circuits**

• **Resistance**

Current  $i$  when AC voltage of instantaneous value  $u = U_m \sin \omega t$  is applied to load resistance  $R [\Omega]$  is expressed by the equation below.  $I_m$  denotes the maximum current.

$$i = \frac{U_m}{R} \sin \omega t = I_m \sin \omega t$$

If expressed using rms values, the equation is  $I = U/R$ .

There is no phase difference between a current flowing through a resistive circuit and the voltage.

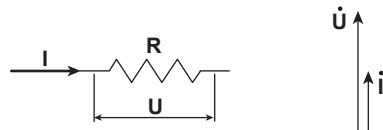

• **Inductance**

Current  $i$  when AC voltage of instantaneous value  $u = U_m \sin \omega t$  is applied to a coil load of inductance  $L [H]$  is expressed by the equation below.

$$i = \frac{U_m}{X_L} \sin \left( \omega t - \frac{\pi}{2} \right) = I_m \sin \left( \omega t - \frac{\pi}{2} \right)$$

If expressed using rms values, the equation is  $I = U/X_L$ .  $X_L$  is called inductive reactance and is defined as  $X_L = \omega L$ . The unit is  $\Omega$ .

Inductance works to counter current changes (increase or decrease), and causes the current phase to lag the voltage.

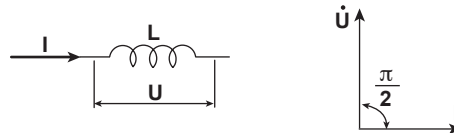

• **Capacity**

Current  $i$  when AC voltage of instantaneous value  $u = U_m \sin \omega t$  is applied to a capacitive load  $C [F]$  is expressed by the equation below.

$$i = \frac{U_m}{X_C} \sin \left( \omega t + \frac{\pi}{2} \right) = I_m \sin \left( \omega t + \frac{\pi}{2} \right)$$

If expressed using rms values, the equation is  $I = U/X_C$ .  $X_C$  is called capacitive reactance and is defined as  $X_C = 1/\omega C$ . The unit is  $\Omega$ .

When the polarity of the voltage changes, the largest charging current of the same polarity as the voltage flows through the capacitor. When the voltage decreases, discharge current of opposite polarity as the voltage flows. Thus, the current phase leads the voltage.

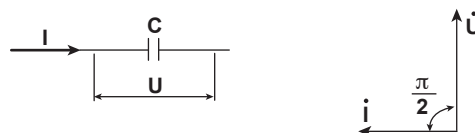

• **Series RLC Circuit**

The equation below expresses the voltage relationship when resistance  $R_s$  [ $\Omega$ ], inductance  $L$  [H], and capacitance  $C$  [F] are connected in series.

$$U = \sqrt{(U_{R_s})^2 + (U_L - U_C)^2} = \sqrt{(IR_s)^2 + (IX_L - IX_C)^2}$$

$$= I\sqrt{(R_s)^2 + (X_L - X_C)^2} = I\sqrt{R_s^2 + X_s^2}$$

$$I = \frac{U}{\sqrt{R_s^2 + X_s^2}}, \quad \phi = \tan^{-1} \frac{X_s}{R_s}$$

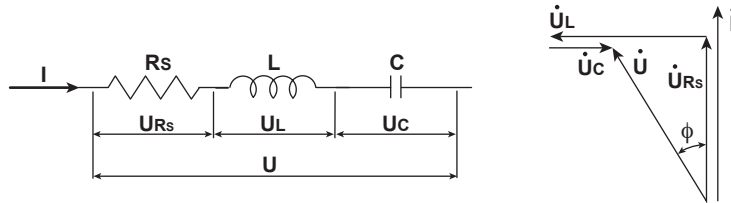

The relationship between resistance  $R_s$ , reactance  $X_s$ , and impedance  $Z$  is expressed as follows:

$$X_s = X_L - X_C$$

$$Z = \sqrt{R_s^2 + X_s^2}$$

• **Parallel RLC Circuit**

The equation below expresses the current relationship when resistance  $R_p$  [ $\Omega$ ], inductance  $L$  [H], and capacitance  $C$  [F] are connected in parallel.

$$I = \sqrt{(I_{R_p})^2 + (I_L - I_C)^2} = \sqrt{\left(\frac{U}{R_p}\right)^2 + \left(\frac{U}{X_L} - \frac{U}{X_C}\right)^2}$$

$$= U\sqrt{\left(\frac{1}{R_p}\right)^2 + \left(\frac{1}{X_L} - \frac{1}{X_C}\right)^2} = U\sqrt{\left(\frac{1}{R_p}\right)^2 + \left(\frac{1}{X_p}\right)^2}$$

$$U = \frac{I R_p X_p}{\sqrt{R_p^2 + X_p^2}}, \quad \phi = \tan^{-1} \frac{R_p}{X_p}$$

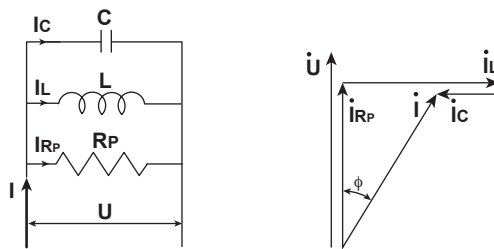

The relationship between resistance  $R_p$ , reactance  $X_p$ , and impedance  $Z$  is expressed as follows:

$$X_p = \frac{X_L X_C}{X_C - X_L}$$

$$Z = \frac{R_p X_p}{\sqrt{R_p^2 + X_p^2}}$$

# Appendix 5 For Making Accurate Measurements

## Effects of Power Loss

By wiring the circuit to match the load, you can minimize the effect of the power loss on the measurement accuracy. We will consider the current source (SOURCE) and load resistance (LOAD) below.

- **When the Measurement Current Is Relatively Large**

Wire so that the voltage measurement circuit is connected to the load side. The current measurement circuit measures the sum of current  $i_L$  flowing through the load of the circuit under measurement and the current  $i_V$  flowing through the voltage measurement circuit. Because the current flowing through the circuit under measurement is  $i_L$ ,  $i_V$  is the amount of error. The input resistance of the voltage measurement circuit of the instrument is approximately  $10\text{ M}\Omega$ . If the input is  $1000\text{ V}$ ,  $i_V$  is approximately  $0.1\text{ mA}$  ( $1000\text{ V}/10\text{ M}\Omega$ ). If the load current,  $i_L$ , is  $1\text{ A}$  or more (load resistance is  $1\text{ k}\Omega$  or less), then the effect of  $i_V$  on the measurement is  $0.01\%$  or less. If the input is  $100\text{ V}$  and  $1\text{ A}$ ,  $i_V = 0.01\text{ mA}$  ( $100\text{ V}/10\text{ M}\Omega$ ) then the effect of  $i_V$  on the measurement accuracy is  $0.001\%$  ( $0.01\text{ mA}/1\text{ A}$ ).

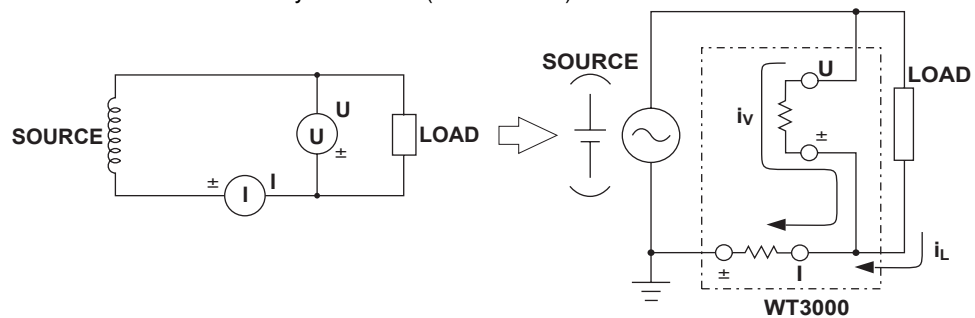

As a reference, the relationship of the voltages and currents that produce effects of  $0.01\%$ ,  $0.001\%$ , and  $0.0001\%$  are shown in the figure below.

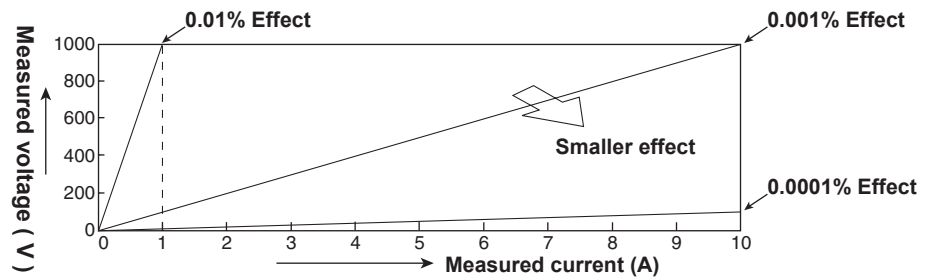

- **When the Measurement Current Is Relatively Small**

Wire so that the current measurement circuit is connected to the load side. In this case, the voltage measurement circuit measures the sum of the load voltage  $e_L$  and voltage drop  $e_I$  across the current measurement circuit.  $e_I$  is the amount of error in this case. The input resistance of the current measurement circuit of the instrument is  $500\text{ m}\Omega$  and  $5.5\text{ m}\Omega$  for the  $2\text{-A}$  and  $30\text{-A}$  input terminals, respectively. For example, if the load resistance is  $1\text{ k}\Omega$ , then the effects on the measurement accuracy is  $0.05\%$  for the  $2\text{-A}$  input terminal ( $500\text{ m}\Omega/1\text{ k}\Omega$ ) and  $0.00055\%$  for the  $30\text{-A}$  input terminal ( $5.5\text{ m}\Omega/1\text{ k}\Omega$ ).

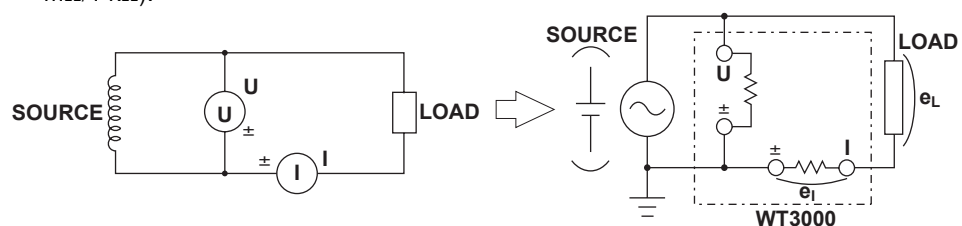

### Effects of Stray Capacitance

The effects of stray capacitance on the measurement accuracy can be minimized by connecting the current input terminal of the instrument to the side that is close to the earth potential of the power source (SOURCE).

The internal structure of the instrument is as follows:

The voltage and current measurement circuits are each enclosed in shielded cases. These shielded cases are placed inside the outer case. The shielded case of the voltage measurement circuit is connected to the ± terminal of the voltage input terminal and the shielded case of the current measurement circuit is connected to the ± terminal of the current input terminal. Because the outer case is insulated from the shield case, stray capacitance  $C_s$  exists.  $C_s$  is approximately 100 pF. The current generated by this stray capacitance,  $C_s$ , will cause errors.

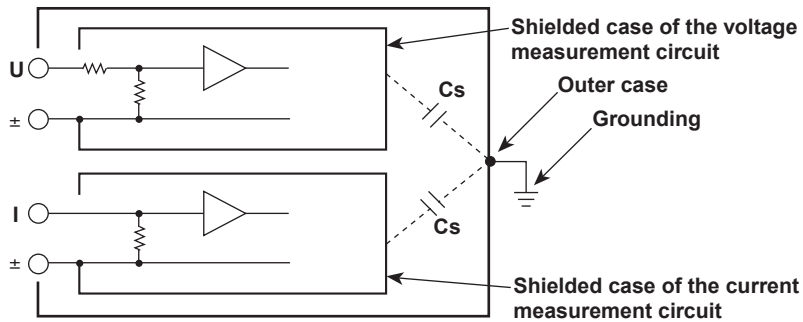

For example, we will consider the case when one side of the power source and the outer case are grounded.

In this case, two current flows can be considered, load current  $i_L$  and the current that flows through the stray capacitance  $i_{C_s}$ .  $i_L$  flows through the current measurement circuit, then through the load, and returns to the power source (shown with a dotted line).  $i_{C_s}$  flows through the current measurement source, through the stray capacitance, and then through the earth ground of the outer case, and returns to the power source (shown with a dot-dash line).

Therefore, the current measurement circuit ends up measuring the sum of  $i_L$  and  $i_{C_s}$  even though it wants to measure only  $i_L$ .  $i_{C_s}$  is the amount of error in this case. If the voltage applied to  $C_s$  is  $V_{C_s}$  (common mode voltage), then  $i_{C_s}$  can be found using the following equation. Because the phase of  $i_{C_s}$  is ahead of the voltage by  $90^\circ$  the effects of  $i_{C_s}$  on the measurement accuracy increases as the power factor gets smaller.

$$i_{C_s} = V_{C_s} \times 2\pi f \times C_s$$

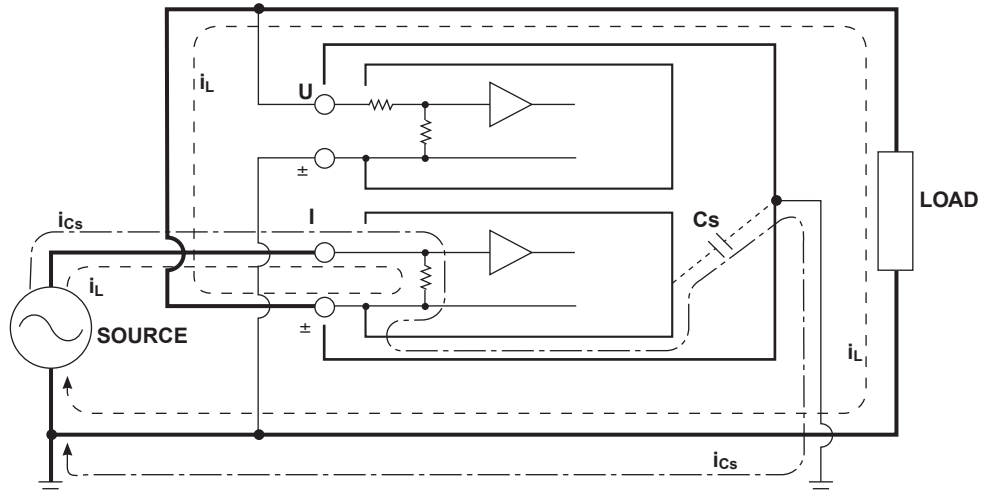

When measuring high frequencies as in this instrument, this error,  $i_{C_s}$ , cannot be ignored. By connecting the current input terminal of the instrument to the side that is close to the earth potential of the power source (SOURCE),  $V_{C_s}$  becomes approximately zero and very little  $i_{C_s}$  flows.

## Appendix 6 Setting the Measurement Period

The measurement period must be set properly to make correct measurements on this instrument. There are two cases for setting of the measurement period depending on the data update rate.

- When the data update rate is set to 50 ms, 100 ms, 5 s, 10 s, or 20 s  
The measurement period must be set.
- When the data update rate is set to 250 ms, 500 ms, 1 s, or 2 s  
The measurement period does not have to be set.

Details of each case are given below.

### When the Data Update Rate Is Set to 50 ms, 100 ms, 5 s, 10 s, or 20 s

The WT3000 detects the period of the selected input signal using the frequency measurement circuit (see section 2.1). The measurement period is the integer multiple of this period. The WT3000 determines the measured values by taking the average of the sampled data in the measurement period. The selected input signal for defining the measurement period is called synchronization source.

Thus, the measurement period is automatically set inside the WT3000 by specifying the synchronization source. This computation method is referred to as Average for the Synchronous Source Period (ASSP). This method is effective for short data update rates and for efficient measurement of low-frequency signals.

Select the signal to be the synchronization source from the choices below.

U1, I1, U2, I2, U3, I3, U4, I4, Ext Clk (external clock), or None

- \* The selectable items vary depending on the installed elements. For the specifications of the Ext Clk (external clock), see section 12.7.

For example, if the synchronization source for input element 1 is set to I1, an integer multiple of the period of I1 becomes the measurement period. By averaging the sampled data in this measurement period, the WT3000 computes the measured values for input element 1 such as U1, I1, and P1.

- **Deciding on Which Input, Voltage or Current, to Use for the Synchronization Source**  
Select an input signal with stable input level and frequency (with little distortion) for the synchronization source. Correct measured values can be obtained only if the period of the synchronization source signal is detected accurately. To see whether the frequency of the synchronization source signal is being measured correctly, display the frequency of the selected input signal on the WT3000 according to section 5.3, "Selecting the Frequency Measurement Source." The input signal whose measurement result is accurate and more stable is suitable for the synchronization source.

For example, if a switching power supply is being measured and the distortion of voltage waveforms is smaller than current waveforms, set the synchronization source to the voltage signal.

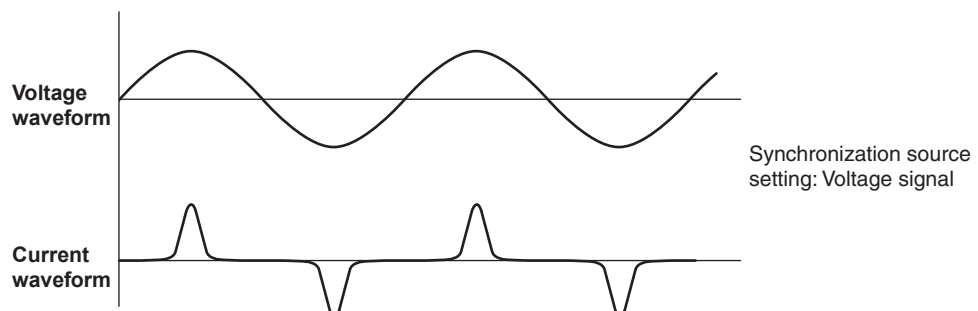

As another example, if an inverter is being measured and the distortion of current waveforms is smaller than voltage waveforms, set the synchronization source to the current signal.

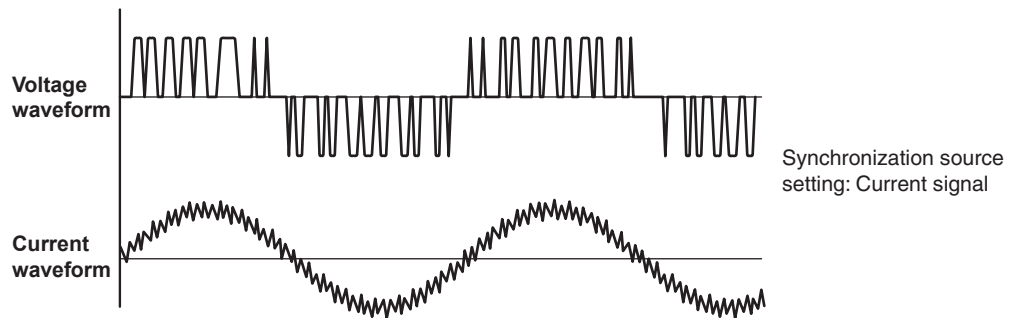

• **Zero Crossing**

- Rising (or falling) zero crossing refers to the time when the synchronization source passes through level zero (center of the amplitude) on the rising (or falling) slope. The measurement period on the WT3000 is between the first rising (or falling) zero crossing and the last rising (or falling) zero crossing in the data update interval.
- The rising or falling zero crossing is automatically selected for the one that allows the interval to be longer.

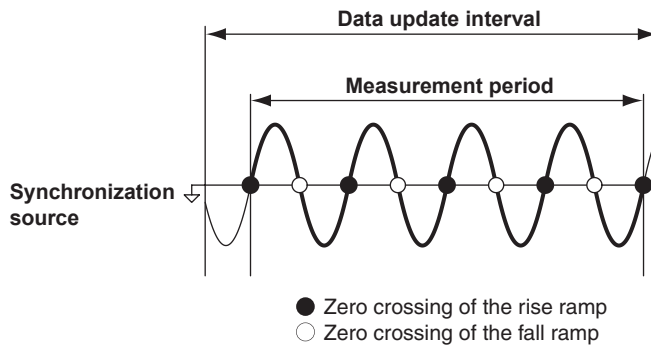

• **When the Period of the Synchronization Source Cannot Be Detected**

If there are less than two rising or falling zero crossings of the input signal set as the synchronization source in the data update interval, the period cannot be detected. In addition, the frequency cannot be detected if the AC amplitude is small. (For details on the detection level for frequency measurement circuit, see section 12.5.) If this happens, the entire data update interval becomes the measurement period, and the sampled data of the entire period are averaged.

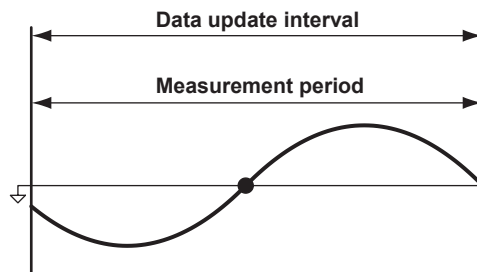

The measured values of voltage and current may be unstable due to causes described above. In such case, lower the data update rate so that more periods of the input signal fit within the data update interval.

- **When the Waveform of the Synchronization Source Is Distorted**

Change the synchronization source to a signal that allows more stable detection of the period (change from voltage to current or from current to voltage). Also turn ON the frequency filter. For the setup procedure of the frequency filter, see section 4.8. The WT3000 applies hysteresis to the zero crossing detection to reduce the effects of noise. If the synchronization source is distorted or harmonic or noise is superposed on the signal to a level exceeding this hysteresis, zero crossing detection due to high frequency components occur frequently, and the zero crossing of the fundamental frequency cannot be detected stably. Consequently, this may cause the measured values of voltage and current to be unstable. Also, when high frequency components are superposed on the current waveform such as in the aforementioned inverter example, turn the frequency filter ON to stably detect the zero crossing. The validity of setting the filter can be verified by a more accurate and stable frequency measurement result. In this way, the frequency filter also functions as a filter for detecting the zero crossing of the synchronization source. Therefore, the frequency filter is sometimes called the synchronization source filter or zero-crossing filter.

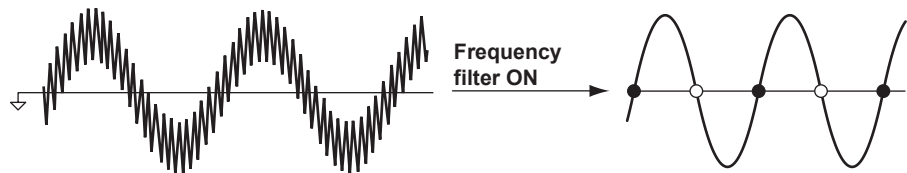

- **When Measuring a Signal with No Zero Crossing due to DC Offset Superposed on the AC Signal**

The measured values may be unstable if the period of the AC signal cannot be detected accurately. Change the synchronization source to a signal that allows more stable detection of the period (change from voltage to current or from current to voltage). The frequency detection circuit is AC coupled. The period of AC signals with no zero crossing due to an offset can be detected if the AC amplitude is greater than or equal to the detection level of the frequency measurement circuit (see section 12.5). With this feature, the measurement period is set to an integer multiple of the period of the AC signal.

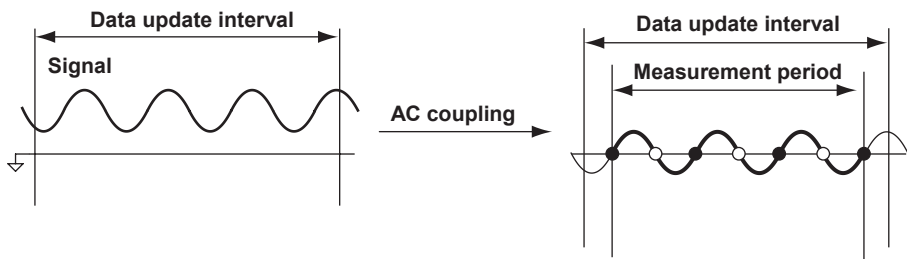

- **When Measuring a DC Signal**

If ripple exists on the DC signal and its level is greater than or equal to the detection level of the frequency measurement circuit (see section 12.5) and the period can be detected accurately and stably, a more accurate DC measurement becomes possible. If a large AC signal is superposed on the DC signal, a more stable measurement can be achieved by detecting its period and taking the average. In addition, if a small fluctuating pulse noise riding on the DC signal crosses level zero, that point is detected as a zero crossing. As a result, sampled data is averaged over an unintended period, and the measured values such as voltage and current may be unstable. If the synchronization source is set to None, these types of erroneous detection can be prevented. All of the sampled data in the data update interval is used to determine the measured values. Set the synchronization source according to the measurement signal and the measurement objective.



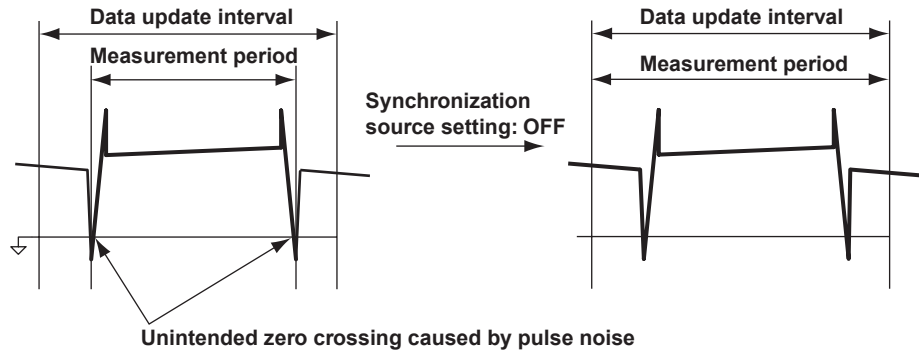

• **Setting the Synchronization Period When Measuring a Three-Phase Device**

If a three-phase device is measured with input elements 1 and 2 using three-phase, three-wire system, set the synchronization source of input elements 1 and 2 to the same signal. For example, set the synchronization source of input element 1 and 2 to U1 (or I1, the same synchronization source). In effect, the measurement periods of input elements 1 and 2 match, and the  $\Sigma$  voltage,  $\Sigma$  current, and  $\Sigma$  power of the three-phase device can be measured with high accuracy.

Likewise, if a three-phase device is measured with input elements 1, 2, and 3 using three-phase, four-wire system, set the synchronization source of input elements 1, 2, and 3 to the same signal.

To facilitate this sort of configuration, the synchronization source setting on the WT3000 is linked to the  $\Sigma$  wiring unit of the wiring system (when the independent setting of input elements is OFF). If the independent setting of input elements (see section 4.2) is turned ON, the synchronization source of each input element in the  $\Sigma$  wiring unit can be set independently.

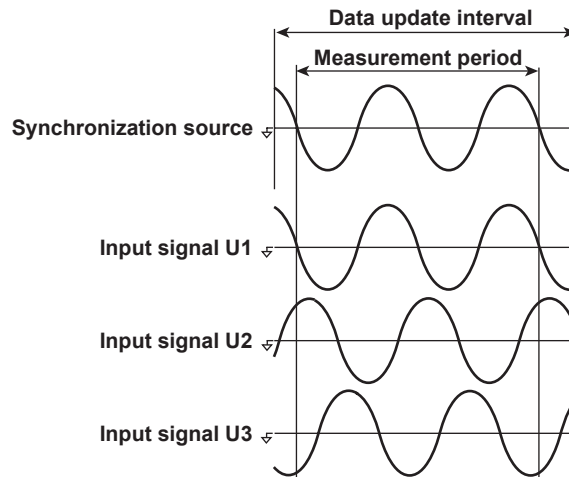

Synchronization source setup example	
Input element 1	U1 (or I1)
Input element 2	
Input element 3	

- **Setting the Synchronization Period When Measuring the Efficiency of a Power Conversion Device**

**Power Transformer with Single-Phase Input and Single-Phase Output**

If a device that converts single-phase AC power to single-phase DC power is measured with input elements 1 and 2, set the synchronization source of input elements 1 and 2 to the voltage (or current) on the AC power end. In the example shown in the figure below, set the synchronization source of input element 1 and 2 to U1 (or I1).

In effect, the measurement periods of input element 1 (input end) and input element 2 (output end) match, and the power conversion efficiency of the device can be measured more accurately.



Synchronization source setup example	
Input element 1	U1 (or I1)
Input element 2	

Likewise, if a device that converts single-phase DC power to single-phase AC power is measured with input elements 1 (DC end) and 2 (AC end), set the synchronization source of input elements 1 and 2 to the voltage (or current) on the AC power end (input element 2). In the example shown in the figure below, set the synchronization source of input element 1 and 2 to U2 (or I2).



Synchronization source setup example	
Input element 1	U2 (or I2)
Input element 2	

**Power Transformer with Single-Phase DC Input and Three-Phase AC Output**

If the device that converts single-phase DC power to three-phase AC power is connected and measured as shown on the next page, set the synchronization source of all input elements to the same voltage and current of element 2 and 3 on the AC power end.

In this example, set the synchronization source of input elements 1, 2, and 3 to U2 (or I2, U3, or I3). In effect, the measurement periods of the input signal and all output signals match, and the power conversion efficiency of the power conversion device can be measured more accurately.

- Single-phase DC power: Connect to input element 1.
- Three-phase AC power: Connect to input elements 2 and 3 using three-phase, three-wire system.

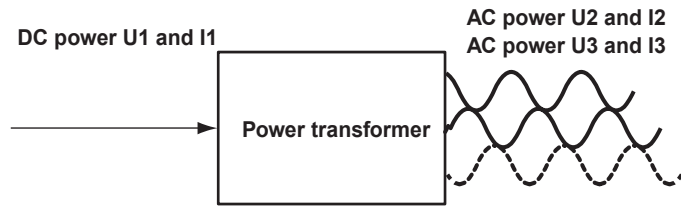

Synchronization source setup example	
Input element 1	U2 (or I2, U3, or I3)
Input element 2	
Input element 3	

**Power Transformer with Single-Phase AC Input and Three-Phase AC Output**

If the device that converts single-phase AC power to three-phase AC power is connected and measured as shown in the figure below, set the synchronization source of input elements on the input end to the same signal and do the same for the input elements on the output end.

In this example, set the synchronization source of input element 1 to U1 (or I1), and set the synchronization source of input elements 2 and 3 to U2 (or I1, U3, or I3). In this case, AC signals of different frequencies are measured. If the synchronization source of all input elements is set to the same signal, the measurement period of either the input signal or the output signal will not be an integer multiple of the signal which is undesirable.

- Single-phase AC power: Connect to input element 1.
- Three-phase AC power: Connect to input elements 2 and 3 using three-phase, three-wire system.



Synchronization source setup example	
Input element 1	U1 (or I1)
Input element 2	U2 (or I2, U3, or I3)
Input element 3	

To measure the input/output efficiency with high accuracy without being affected by the synchronization source setting such as in this case or in the power measurement or efficiency measurement of aforementioned devices, set the data update rate of the WT3000 to 250 ms, 500 ms, 1 s, or 2 s. Because the measured value is computed from the Exponential Average for Measuring Period method described on the next page, the period of the input signal does not need to be detected.

**Note**

- The measurement period for the numeric data of the maximum value (Peak) for voltage and current is the entire span within the data update period regardless of the measurement period specified above. Therefore, the measurement period for the measurement functions U+pk, U-pk, I+pk, I-pk, CfU, and Cfl that are determined from the maximum value of the voltage and current is also the entire span within the data update period.
- The measurement period of measurement functions of harmonic measurement is from the beginning of the data update interval to 9000 points at the harmonic sampling frequency regardless of the measurement period specified above.

**When the Data Update Rate Is Set to 250 ms, 500 ms, 1 s, or 2 s**

The measurement period is set equal to the data update interval. The measured values are determined by computing the average of all the sampled data in the data update interval through digital filtering. This computing method is called Exponential Average for Measuring Period (EAMP). In this method, the measurement period is not affected by the input signal period or the synchronization source setting. Therefore, the input signal period does not have to be detected. In addition, the measurement period always matches between all input elements. It is recommended that this method be used when it is difficult to match the measurement period between the input and output signals such as in the aforementioned example of “(3) Power Transformer with Single-Phase AC Input and Three-Phase AC Output.” In principle, this method is superior in obtaining highly stable measured values, because factors such as errors in period detection do not exist.

**Exponential Average for Measuring Period**

$$Y_n = Y_{n-1} + \frac{(X_n - Y_{n-1})}{A}$$

- X<sub>n</sub>: n<sup>th</sup> sampled data in the measurement period.
- Y<sub>n</sub>: Output value of the n<sup>th</sup> exponential average in the measurement period.
- Y<sub>n-1</sub>: Output value of the n-1<sup>th</sup> exponential average in the measurement period.
- A: Constant

This equation is stacked several stages to derive the measured value. The last value in the measurement period, Y<sub>n</sub>, is displayed as the measured value.

**Data Update Rate and Averaging Method**

Data update rate	Computing method	Setting the Measurement Period
50 ms 100 ms	ASSP	Required
250 ms 500 ms 1 s 2 s	EAMP	Not required
5 s 10 s 20 s	ASSP	Required

ASSP: Average for the Synchronous Source Period  
 EAMP: Exponential Average for Measuring Period

---

## Appendix 7 Data Update Rate and Computing Equation

AC signals fluctuate repetitively when viewed instantaneously. The power of AC signals can be measured by taking the average of the repeating periods or computing the average by filtering the data of several periods. The WT3000 automatically selects the computing method from the two averaging computations above according to the data update interval.

- **When the Data Update Rate Is 50 ms, 100 ms, 5 s, 10 s, or 20 s**

Computation is performed using ASSP (Average for the Synchronous Source Period) on the sampled data within the data update interval to calculate the measured value. (However, integrated power  $W_p$  as well as integrated current  $q$  during DC mode are excluded.)

This method detects the period of the input signal assigned to be the synchronous source\* using the frequency measurement circuit and sets the measurement period to be an integer multiple of the input signal period. Computation including simple average is performed based on the sampled data in this measurement period. This method requires that the period of the assigned synchronous source signal be detected accurately. The synchronization source must be set when using this method. The period of the assigned synchronization source signal must also be detected accurately.

Check to see that the frequency of the synchronous source signal is being measured correctly according to the procedures given in sections 5.1 and 5.3.

\* For a description of the synchronous source, see appendix 6, "Setting the Measurement Period."

- **When the Data Update Rate Is 250 ms, 500 ms, 1 s, or 2 s**

Computation is performed using EAMP (Exponential Average for Measuring Period) on the sampled data within the data update interval to calculate the measured value. The EAMP method sets the measurement period to be the entire data update interval. Computation including exponential average is performed by applying digital filtering on the sampled data in this measurement period. This method does not require the input signal period to be detected accurately. Therefore, you do not have to set the synchronization source.

## Appendix 8 Compensation Function

This function compensates for the loss caused by the wiring of each element. The WT3000 has the following three types of correction functions to measure the power and efficiency with high accuracy.

- Wiring Compensation
- Efficiency Compensation
- Compensation for the Two-Wattmeter Method

### Wiring Compensation

This function compensates for the loss caused by the wiring of each element.

- **U – I**

This is used when the voltage measurement circuit is connected to the load side. The measured voltage is determined by subtracting “the voltage applied to the current terminal” from the voltage value of each element. The voltage applied to the current terminal is derived by the equation: the measured current  $\times$  the input resistance of the current terminal.

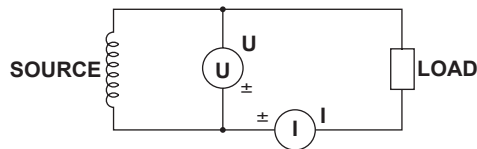

- **I – U**

This is used when the current measurement circuit is connected to the load side. The measured current is determined by subtracting “the current that flows through the voltage terminal” from the current value of each element. The current that flows through the voltage terminal is derived by the equation: the measured voltage/the input resistance of the voltage terminal.

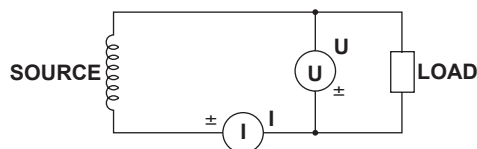

- **Compensation Details**

The measured value is determined by substituting the compensated instantaneous values  $u'(n)$  and  $i'(n)$  below into the respective equation in appendix 1.

**For U-I Wiring**

Compensated instantaneous voltage:  $u'(n) = u(n) - R_i i(n)$

The instantaneous current is  $i(n)$ .

**For I-U Wiring**

Compensated instantaneous current:  $i'(n) = i(n) - u(n)/R_u$

The instantaneous voltage is  $u(n)$ .

In the equations above,

$u(n)$ : Measured instantaneous voltage (sampled data of the voltage signal)

$i(n)$ : Measured instantaneous current (sampled data of the current signal)

$R_u$ : Compensation value for the input resistance (10 M $\Omega$ ) of the voltage input terminal

$R_i$ : Compensation value for the input resistance (5.5 m $\Omega$ ) of the direct current input terminal

### Efficiency Compensation

In the efficiency equation  $\eta = A/B$ , the compensation value Err# in the table below is subtracted from denominator B according to the element or wiring unit included in numerator A.

Element or Wiring Unit	Compensation Err#
Element#	Err# = $U\# \times U\# / R_U \times sf\# + I\# \times I\# \times R_I \times sf\#$
$\Sigma A, B$	Err# = $\Sigma Err\#$ (total of Err# of all elements included in $\Sigma$ )

U#: Measured voltage (rms, mean, r-mean, or dc) depending on the voltage mode. # is the element number.

I#: Measured current (rms, mean, r-mean, or dc) depending on the current mode. # is the element number.

R<sub>U</sub>: Input resistance (10 MΩ) of the voltage input terminal

R<sub>I</sub>: Input resistance (5.5 mΩ) of the current input terminal

sf#: Scaling factor for power. # is the element number.

Example

$$\eta = \frac{P_{\Sigma A}}{P_{\Sigma B}} \quad \text{where } \Sigma A: \text{Element 1 and 2, } \Sigma B: \text{Element 3 and 4}$$

The efficiency compensation for above

$$\eta = \frac{P_{\Sigma A}}{\{P_{\Sigma B} - ((U_1 \times U_1 / R_U \times sf_1 + I_1 \times I_1 \times R_I \times sf_1) + (U_2 \times U_2 / R_U \times sf_2 + I_2 \times I_2 \times R_I \times sf_2))\}}$$

### Compensation for the Two-Wattmeter Method

The computation below is performed on the element or wiring unit wired to 3P3W (3V3A).

Example: When elements 1, 2, and 3 are set to 3P3W (3V3A)

Computation step 1: Calculation of compensation values

- Power: Compensation SP' = {The average of  $((-u(n)_1 + u(n)_2)/3) \times (i(n)_1 + i(n)_2 + i(n)_3)$ }
- Watt hour (total): Compensation SWP' = {WP of  $((-u(n)_1 + u(n)_2)/3) \times (i(n)_1 + i(n)_2 + i(n)_3)$ }
- Watt hour (+): Compensation SWP(+)' = {WP(+) of  $((-u(n)_1 + u(n)_2)/3) \times (i(n)_1 + i(n)_2 + i(n)_3)$ }
- Watt hour (-): Compensation SWP(-)' = {WP(-) of  $((-u(n)_1 + u(n)_2)/3) \times (i(n)_1 + i(n)_2 + i(n)_3)$ }

u(n) and i(n) are instantaneous voltage and current (sampled data of voltage and current signals), respectively.

Computation step 2: Add the compensation value to the measured value

- SP'' = SP + SP' × sf#
- SWP'' = SWP + SWP' × sf#
- SWP(+)' = SWP(+) + SWP(+)' × sf#
- SWP(-)' = SWP(-) + SWP(-)' × sf#

sf#: Scaling factor of the first element in the wiring unit (element 1 in this example)

#### Note

This function can be set only when the wiring system is set to 3P3W (3V3A) on models with the delta computation option.

# Appendix 9 Key Assignments of the USB Keyboard

## 104 Keyboard (US)

Key	Ctrl Key Held Down on the USB Keyboard		Soft Keyboard Displayed on the WT3000		Other	
		Shift ON on the WT3000		+Shift on the USB Keyboard		Shift ON on the WT3000
a	AVG menu		a	A		
b	Execute STORE	STORE SET menu	b	B		
c	SCALING menu	MOTOR SET menu	c	C		
d	Execute HOLD	Same as left	d	D		
e	Execute ELEMENT	Execute ELEMENTALL	e	E		
f	FILE menu	Same as left	f	F		
g	INTEG menu	Same as left	g	G		
h	HRM SET menu	Same as left	h	H		
i	Execute IMAGE SAVE	IMAGE SAVE menu	i	I		
j			j	J		
k			k	K		
l	LINE FILTER menu	FREQ FILTER menu	l	L		
m	MEASURE menu	CURSOR	m	M		
n	Execute NUMERIC	Same as left	n	N		
o	OTHERS menu	Same as left	o	O		
p	Execute PRINT	PRINT menu	p	P		
q	FORM menu	LOWER FORM menu	q	Q		
r	Execute RESET	Same as left	r	R		
s	SHIFT ON	SHIFT OFF	s	S		
t	ITEM menu	LOWER ITEM menu	t	T		
u	UPDATE RATE menu	Same as left	u	U		
v	WIRING menu	Execute INPUT INFO.	v	V		
w	Execute WAVE	Same as left	w	W		
x	Execute EXT-SENSOR	SENSOR RATIO menu	x	X		
y	SYNC SOURCE menu	Execute NULL	y	Y		
z	Execute SINGLE	Execute CAL	z	Z		
1			1	!		
2			2	"		
3			3	#		
4			4	\$		
5			5	%		
6			6	&		
7			7	'		
8			8	(		
9			9	)		
0			0			
Enter	Execute Set	Same as left	Enter	Same as left	Execute Set	Same as left
Esc	Execute Esc	Same as left	Escape	Same as left	Execute Esc	Same as left
Back Space			Back Space	Same as left		
Tab						
Space Bar			Space	Same as left		
-			-	_		
=			=	+		
[			[	{		
]			]	}		
\			\			
;			;	:		
'			'	"		
,			,	<		
.	MISC menu	Same as left	.	>		
/	Execute HELP		/	?		
Caps Lock			Caps Lock	Same as left		



Appendix 9 Key Assignments of the USB Keyboard

Key	Ctrl Key Held Down on the USB Keyboard		Soft Keyboard Displayed on the WT3		Other	
		Shift ON on the WT3000		+Shift on the USB Keyboard		Shift ON on the WT3000
F1	U RANGE up	Same as left	Select Soft key1	Same as left	Select Soft key1	Same as left
F2	U RANGE down	Same as left	Select Soft key2	Same as left	Select Soft key2	Same as left
F3	Execute U MODE	Same as left	Select Soft key3	Same as left	Select Soft key3	Same as left
F4	Execute U AUTO	Same as left	Select Soft key4	Same as left	Select Soft key4	Same as left
F5	I RANGE up	Same as left	Select Soft key5	Same as left	Select Soft key5	Same as left
F6	I RANGE down	Same as left	Select Soft key6	Same as left	Select Soft key6	Same as left
F7	Execute I MODE	Same as left	Select Soft key7	Same as left	Select Soft key7	Same as left
F8	Execute I AUTO	Same as left				
F9	Execute U, I, P	Same as left				
F10	Execute S, Q, λ, φ	Same as left				
F11	Execute WP, q, TIME	Same as left	μ	Same as left		
F12	Execute FU, FI, η	Same as left	Ω	Same as left		
Print Screen	Execute PRINT	PRINT menu				
Scroll Lock	Execute IMAGE SAVE	IMAGE SAVE menu				
Pause						
Insert			Insert ON	Same as left		
Home	Execute USER	USER SET menu				
Page Up	Execute PAGE PREVIOUS	Execute PAGE FIRST			Execute PAGE PREVIOUS	Execute PAGE FIRST
Delete			Delete	Same as left		
End	ELEMENT	ALL				
Page Down	Execute PAGE NEXT	Execute PAGE LAST			Execute PAGE NEXT	Execute PAGE LAST
→	Cursor to the right	Same as left	Cursor to the right	Same as left	Cursor to the right	Same as left
←	Cursor to the left	Same as left	Cursor to the left	Same as left	Cursor to the left	Same as left
↓	Cursor down	Same as left	Move soft keyboard Cursor in reverse	Same as left	Cursor down	Same as left
↑	Cursor up	Same as left	Move soft keyboard Cursor forward	Same as left	Cursor up	Same as left

Numeric Keypad	Ctrl Key Held Down on the USB Keyboard		Soft Keyboard Displayed on the WT3000		Other	
		Shift ON on the WT3000		+Shift on the USB Keyboard		+Shift on the USB Keyboard
Num Lock						
/			/	Same as left		
*			*	Same as left		
-			-	Same as left		
+			+	Same as left		
Enter			Enter	Same as left		
1			1			
2	Cursor down	Same as left	2	Move soft keyboard Cursor in reverse		Cursor down
3	Execute PAGE NEXT	Execute PAGE LAST	3			Execute PAGE NEXT
4	Cursor to the left	Same as left	4	Cursor to the left		Cursor to the left
5			5			
6	Cursor to the right	Same as left	6	Cursor to the right		Cursor to the right
7			7			
8	Cursor up	Same as left	8	Move soft keyboard Cursor forward		Cursor up
9	Execute PAGE PREVIOUS	Same as left	9			Execute PAGE PREVIOUS
0			0	Insert ON		
.			.	DELETE		

Appendix 9 Key Assignments of the USB Keyboard

109 Keyboard (Japanese)

Key	Ctrl Key Held Down on the USB Keyboard		Soft Keyboard Displayed on the WT3000		Other	
		Shift ON on the WT3000		+Shift on the USB Keyboard		Shift ON on the WT3000
a	AVG menu		a	A		
b	Execute STORE	STORE SET menu	b	B		
c	SCALING menu	MOTOR SET menu	c	C		
d	Execute HOLD	Same as left	d	D		
e	Execute ELEMENT	Execute ELEMENTALL	e	E		
f	FILE menu	Same as left	f	F		
g	INTEG menu	Same as left	g	G		
h	HRM SET menu	Same as left	h	H		
i	Execute IMAGE SAVE	IMAGE SAVE menu	i	I		
j			j	J		
k			k	K		
l	LINE FILTER menu	FREQ FILTER menu	l	L		
m	MEASURE menu	CURSOR	m	M		
n	Execute NUMERIC	Same as left	n	N		
o	OTHERS menu	Same as left	o	O		
p	Execute PRINT	PRINT menu	p	P		
q	FORM menu	LOWER FORM menu	q	Q		
r	Execute RESET	Same as left	r	R		
s	SHIFT ON	SHIFT OFF	s	S		
t	ITEM menu	LOWER ITEM menu	t	T		
u	UPDATE RATE menu	Same as left	u	U		
v	WIRING menu	Execute INPUT INFO.	v	V		
w	Execute WAVE	Same as left	w	W		
x	Execute EXT-SENSOR	SENSOR RATIO menu	x	X		
y	SYNC SOURCE menu	Execute NULL	y	Y		
z	Execute SINGLE	Execute CAL	z	Z		
1			1	!		
2			2	"		
3			3	#		
4			4	\$		
5			5	%		
6			6	&		
7			7	'		
8			8	(		
9			9	)		
0			0			
Enter	Set	Same as left	Ent	Same as left	Set	Same as left
Esc	Esc	Same as left	Esc	Same as left	Esc	Same as left
BS			BS	Same as left		
Tab						
Space			Space	Same as left		
-			-	=		
^			^	~		
@			@	·		
[			[	{		
;			;	+		
:			:	*		
]			]	}		
,			,	<		
.	MISC	Same as left	.	>		
/	Execute HELP		/	?		
Caps Lock			Caps Lock	Same as left		

**Appendix 9 Key Assignments of the USB Keyboard**

Key	Ctrl Key Held Down on the USB Keyboard		Soft Keyboard Displayed on the WT3000		Other	
		Shift ON on the WT3000		+Shift on the USB Keyboard		Shift ON on the WT3000
F1	U RANGE up	Same as left	Select Soft key1	Same as left	Select Soft key1	Same as left
F2	U RANGE down	Same as left	Select Soft key2	Same as left	Select Soft key2	Same as left
F3	Execute U MODE	Same as left	Select Soft key3	Same as left	Select Soft key3	Same as left
F4	Execute U AUTO	Same as left	Select Soft key4	Same as left	Select Soft key4	Same as left
F5	I RANGE up	Same as left	Select Soft key5	Same as left	Select Soft key5	Same as left
F6	I RANGE down	Same as left	Select Soft key6	Same as left	Select Soft key6	Same as left
F7	Execute I MODE	Same as left	Select Soft key7	Same as left	Select Soft key7	Same as left
F8	Execute I AUTO	Same as left				
F9	Execute U, I, P	Same as left				
F10	Execute S, Q, λ, φ	Same as left				
F11	Execute WR, q, TIME	Same as left	μ	Same as left		
F12	Execute FU, Fl, η	Same as left	Ω	Same as left		
Print Screen	Execute PRINT	PRINT menu				
Scroll Lock	Execute IMAGE SAVE	IMAGE SAVE menu				
Pause						
Insert			Insert ON	Same as left		
Home	Execute USER	USER SET menu				
Page Up	Execute PAGE PREVIOUS	Execute PAGE FIRST			Execute PAGE PREVIOUS	Execute PAGE FIRST
Delete			Delete	Same as left		
End	ELEMENT	ALL				
Page Down	Execute PAGE NEXT	Execute PAGE LAST			Execute PAGE NEXT	Execute PAGE LAST
→	Cursor to the right	Same as left	Cursor to the right	Same as left	Cursor to the right	Same as left
←	Cursor to the left	Same as left	Cursor to the left	Same as left	Cursor to the left	Same as left
↓	Cursor down	Same as left	Move soft keyboard Cursor in reverse	Same as left	Cursor down	Same as left
↑	Cursor up	Same as left	Move soft keyboard Cursor forward	Same as left	Cursor up	Same as left

Numeric Keypad	Ctrl Key Held Down on the USB Keyboard		Soft Keyboard Displayed on the WT3000		Other	
		Shift ON on the WT3000		+Shift on the USB Keyboard		+Shift on the USB Keyboard
Num Lock						
/			/	Same as left		
*			*	Same as left		
-			-	Same as left		
+			+	Same as left		
Enter			Enter	Same as left		
1			1			
2	Cursor down	Same as left	2	Move soft keyboard Cursor in reverse		Cursor down
3	Execute PAGE NEXT	Execute PAGE LAST	3			Execute PAGE NEXT
4	Cursor to the left	Same as left	4	Cursor to the left		Cursor to the left
5			5			
6	Cursor to the right	Same as left	6	Cursor to the right		Cursor to the right
7			7			
8	Cursor up	Same as left	8	Move soft keyboard Cursor forward		Cursor up
9	Execute PAGE PREVIOUS	Execute PAGE FIRST	9			Execute PAGE PREVIOUS
0			0	Insert ON		
.			.	Delete		

# Appendix 10 Measurement Modes and Functional Limitations

The following measurement modes can be used on models with the advanced computation (/G6), voltage fluctuation and flicker measurement (/FL), or cycle-by-cycle measurement (/CC) option. The functions that can be used in each measurement mode are as follows:

Measurement Mode		Normal Measurement		Wide Bandwidth Harmonic	IEC Harmonic	Waveform Computation	FFT	Voltage Fluctuation and Flicker	Cycle by Cycle
		None	/G6, /G5 Harmonics						
Display	Numeric	Yes	Yes	Yes <sup>*1</sup>	Yes <sup>*1</sup>	Yes	Yes	No	No
	Waveform	Yes	Yes	No	No <sup>*2</sup>	No	Yes	No	No
	Trend	Yes	Yes	No	No	No	No	No	No
	Bar graph	No	Yes	Yes	No <sup>*2</sup>	No	No	No	No
	Vector	No	Yes	Yes	No	No	No	No	No
	Waveform computation	No	No	No	No	Yes	No	No	No
	FFT	No	No	No	No	No	Yes	No	No
	Flicker	No	No	No	No	No	No	Yes	No
Cycle by Cycle		No	No	No	No	No	No	No	Yes
Auto range		Yes	Yes	Yes	No	Yes	Yes	No	No
Averaging	Exponential average	Yes	Yes	Yes	Limit <sup>*3</sup>	Yes	Yes	No	No
	Moving average	Yes	No	No	No	Yes	Yes	No	No
Data update rate		Yes	Yes	No	No	Yes	Yes	No <sup>*4</sup>	No
Voltage/Current mode		Yes	Yes	No	No	Yes	Yes	No	Yes
Peak measurement		Yes	Yes	No	No	Yes	Yes	No	No
User-defined function		Yes	Yes	Yes	No	Yes	Yes	No	No
MAX hold		Yes	Yes	Yes	No	Yes	Yes	No	No
Efficiency computation		Yes	Yes	No	No	Yes	Yes	No	No
Compensation		Yes	Yes	Limit <sup>*5</sup>	Limit <sup>*5</sup>	Yes	Yes	No	No
Integration		Yes	Yes	No	No	No	No	No	No
Store		Yes	Yes	Limit <sup>*6</sup>	No	No	No	No	No
File save	Setup	Yes	Yes	Yes	Yes	Yes	Yes	Yes	Yes
	Wave	Yes	Yes	No	No	Yes	Yes <sup>*7</sup>	No	No
	Numeric <sup>*8</sup>	Yes	Yes	Yes	Yes	Yes	Yes	No	Yes
	Acquisition	No	No	No	No	Yes	Yes	No	No
Zero-level compensation		Yes	Yes	Yes	Yes	Yes	Yes	Limit <sup>*9</sup>	Limit <sup>*9</sup>
NULL		Yes	Yes	No	No	Yes	Yes	No	No
Synchronized measurement		Yes	Yes	No	No	No	No	No	No
Motor <sup>*10</sup>		Yes	Yes	No	No	Yes	Yes	No	Yes
Print <sup>*11</sup>	Print	Yes	Yes	Yes	Yes	Yes	Yes	Limit <sup>*12</sup>	Limit <sup>*12</sup>
	Auto	Yes	Yes	Limit <sup>*13</sup>	No	Limit <sup>*13</sup>	Limit <sup>*13</sup>	No	No
D/A output <sup>**14</sup>		Yes	Yes	Yes	No	Yes	Yes	No	No
Delta computation <sup>**15</sup>		Yes	Yes	No	No	Yes	Yes	No	No
Mail transmission <sup>*16</sup>		Yes	Yes	Yes	No	Yes	Yes	No	No

Yes: Can be used.

Limit: Limitation on some functions.

No: Cannot be used.

\*1 The rms values of voltage and current are total values, not the normal measurement values.

\*2 Can be monitored using the IEC harmonic measurement software.

\*3 The attenuation constant cannot be selected.

\*4 Fixed to 2 s.

\*5 The efficiency compensation and the compensation for the two-wattmeter method are invalid.

\*6 "Integ Sync" cannot be selected, because there is no integration function. Waveform data is set to NAN (no data) if Wave Trace is selected, because there is no waveform data.

\*7 Save FFT waveforms using "Acquisition," not "Wave."

\*8 If an item that is not measured or computed in the respective measurement mode, NAN data is saved.

\*9 The settings can be changed and the function can be executed only when the measurement status is reset.

\*10 Requires the motor version (-MV).

\*11 Requires the built-in printer option. If an item that is not measured or computed in the respective measurement mode, NAN data is printed.

\*12 Only the screen image can be printed. The list cannot be printed.

\*13 Integration synchronization (Synchronize) cannot be set. It is fixed to timer.

\*14 Requires the D/A output option.

\*15 Requires the delta computation option.

\*16 Requires the Ethernet communication option.

# Appendix 11 Measurement Functions That Can Be Measured in Each Measurement Mode

The measurement functions that can be measured in each measurement mode that is selectable on models with the advanced computation (/G6) option are as follows:

(Table 1/2)

Measurement Item <sup>11</sup>		Measurement Mode				
		Normal Measurement	Wide Bandwidth Harmonic	IEC Harmonic	Waveform Computation	FFT
All rms values and each harmonic component	U	Yes	No	No	Yes	Yes
	U(k)	Yes <sup>2</sup>	Yes	Yes	No	No
	I	Yes	No	No	Yes	Yes
	I(k)	Yes <sup>2</sup>	Yes	Yes	No	No
	P	Yes	No	No	Yes	Yes
	P(k)	Yes <sup>2</sup>	Yes	Yes	No	No
	S	Yes	No	No	Yes	Yes
	S(k)	Yes <sup>2</sup>	Yes	Yes	No	No
	Q	Yes	No	No	Yes	Yes
	Q(k)	Yes <sup>2</sup>	Yes	Yes	No	No
	λ	Yes	No	No	Yes	Yes
	λ(k)	Yes <sup>2</sup>	Yes	Yes	No	No
φ	Yes	No	No	Yes	Yes	
φ(k)	Yes	Yes	Yes	No	No	
Harmonic phase angle	φU(k)	Yes	Yes	Yes	No	No
	φI(k)	Yes	Yes	Yes	No	No
Frequency <sup>13</sup>	FreqU	Yes	Yes	Yes	Yes	Yes
	FreqI	Yes	Yes	Yes	Yes	Yes
Impedance	Z(k)	Yes	Yes	No	No	No
	Rs(k)	Yes	Yes	No	No	No
	Xs(k)	Yes	Yes	No	No	No
	Rp(k)	Yes	Yes	No	No	No
	Xp(k)	Yes	Yes	No	No	No
Pc	Pc	Yes	No	No	Yes	Yes
Harmonics	Uhd(f(k)	Yes	Yes	Yes	No	No
	Ihd(f(k)	Yes	Yes	Yes	No	No
	Phd(f(k)	Yes	Yes	Yes	No	No
	Uthd	Yes	Yes	Yes	No	No
	Ithd	Yes	Yes	Yes	No	No
	Pthd	Yes	Yes	Yes	No	No
	Uthf	Yes	Yes	No	No	No
	Ithf	Yes	Yes	No	No	No
	Uthf	Yes	Yes	No	No	No
	Ithf	Yes	Yes	No	No	No
	hvf	Yes	Yes	No	No	No
hcf	Yes	Yes	No	No	No	
Peak <sup>14</sup>	U+pk	Yes	No	No	Yes	Yes
	U-pk	Yes	No	No	Yes	Yes
	I+pk	Yes	No	No	Yes	Yes
	I-pk	Yes	No	No	Yes	Yes
	CfU	Yes	No	No	Yes	Yes
	CfI	Yes	No	No	Yes	Yes
Integration <sup>15</sup>	Wp	Yes	No	No	No	No
	Wp+	Yes	No	No	No	No
	Wp-	Yes	No	No	No	No
	q	Yes	No	No	No	No
	q+	Yes	No	No	No	No
	q-	Yes	No	No	No	No
	I-Time	Yes	No	No	No	No
	WS	Yes	No	No	No	No
WQ	Yes	No	No	No	No	

**Appendix 11 Measurement Functions That Can Be Measured in Each Measurement Mode**

(Table 2/2)

Measurement Item <sup>*1</sup>		Measurement Mode				
		Normal Measurement	Wide Bandwidth Harmonic	IEC Harmonic	Waveform Computation	FFT
Efficiency	η1	Yes	No	No	Yes	Yes
	η2	Yes	No	No	Yes	Yes
	η3	Yes	No	No	Yes	Yes
	η4	Yes	No	No	Yes	Yes
Delta computation <sup>*6</sup>	ΔF1	Yes	No	No	Yes	Yes
	ΔF2	Yes	No	No	Yes	Yes
	ΔF3	Yes	No	No	Yes	Yes
	ΔF4	Yes	No	No	Yes	Yes
Phase angle of the fundamental component between phases	φUi-Uj	Yes	Yes	Yes	No	No
	φUi-UK	Yes	Yes	Yes	No	No
	φUi-li	Yes	Yes	Yes	No	No
	φUi-lj	Yes	Yes	Yes	No	No
	φUi-lk	Yes	Yes	Yes	No	No
Motor <sup>*7</sup>	Speed	Yes	No	No	Yes	Yes
	Torque	Yes	No	No	Yes	Yes
	SyncSp	Yes	No	No	Yes	Yes
	Slip	Yes	No	No	Yes	Yes
	Pm	Yes	No	No	Yes	Yes
User-defined function	F1	Yes	Yes	No	Yes	Yes
	F2	Yes	Yes	No	Yes	Yes
	F3	Yes	Yes	No	Yes	Yes
	F4	Yes	Yes	No	Yes	Yes
	F5	Yes	Yes	No	Yes	Yes
	F6	Yes	Yes	No	Yes	Yes
	F7	Yes	Yes	No	Yes	Yes
	F8	Yes	Yes	No	Yes	Yes
	F9	Yes	Yes	No	Yes	Yes
	F10	Yes	Yes	No	Yes	Yes
	F11	Yes	Yes	No	Yes	Yes
	F12	Yes	Yes	No	Yes	Yes
	F13	Yes	Yes	No	Yes	Yes
	F14	Yes	Yes	No	Yes	Yes
	F15	Yes	Yes	No	Yes	Yes
	F16	Yes	Yes	No	Yes	Yes
F17	Yes	Yes	No	Yes	Yes	
F18	Yes	Yes	No	Yes	Yes	
F19	Yes	Yes	No	Yes	Yes	
F20	Yes	Yes	No	Yes	Yes	

Yes: Can be measured.

No: Cannot be measured.

\*1 Variable k is the harmonic order and total value. The maximum order for which the harmonic data is measured is the maximum harmonic order to be measured that is specified in the harmonic measurement (option) menu. The data is set to [-----] (no data) for harmonic orders without data.

\*2 The total value is not measured in normal measurement mode.

\*3 The measured data for the frequencies of input signals that are not specified for the frequency measurement are set to [-----] (no data).

\*4 If the voltage or current mode is not RMS, the data of CfU or CfI is set to [-----] (no data).

\*5 If there are no integrated values because integration is not performed, the data is set to [-----] (no data). The data is set to [-----] (no data) also for integration time.

\*6 The delta computation option (/DT) is required.

\*7 The motor version (-MV) is required.

\*8 The advanced computation option (/G6) or the harmonic measurement option (/G5) is required to measure the items related to harmonics and impedance.

Only the specialized measurement functions can be measured in voltage fluctuation and flicker measurement and cycle-by-cycle measurement modes. For the measurement functions that can be measured, see sections 12.1 and 13.1 in the *Expansion Function User's Manual IM760301-51E*.

# Appendix 12 Operands of User-Defined Functions That Can Be Used in Each Measurement Mode

The operands of user-defined functions that can be used in each measurement mode that is selectable on models with the advanced computation (/G6) option are as follows: The user-defined function cannot be used in voltage fluctuation and flicker measurement and cycle-by-cycle measurement modes.

(Table 1/2)

Measurement Item <sup>1</sup>		Measurement Mode					
		Normal Measurement <sup>2</sup>	Wide Bandwidth Harmonic <sup>3</sup>	IEC Harmonic	Waveform Computation <sup>2</sup>	FFT <sup>2</sup>	
All rms values and each harmonic component	U( , )	Yes	Yes	No	Limit	Limit	
	URMS( )	Yes	No	No	Yes	Yes	
	UMN( )	Yes	No	No	Yes	Yes	
	I( , )	Yes	Yes	No	Limit	Limit	
	P( , )	Yes	Yes	No	Limit	Limit	
	S( , )	Yes	Yes	No	Limit	Limit	
	Q( , )	Yes	Yes	No	Limit	Limit	
	LAMBDA( , )	Yes	Yes	No	Limit	Limit	
Frequency <sup>4</sup>	PHI( , )	Yes	Yes	No	Limit	Limit	
	FU( )	Yes	Yes	No	Yes	Yes	
Peak <sup>5</sup>	FI( )	Yes	Yes	No	Yes	Yes	
	UPPK( )	Yes	No	No	Yes	Yes	
	UMPK( )	Yes	No	No	Yes	Yes	
	IPPK( )	Yes	No	No	Yes	Yes	
	IMPK( )	Yes	No	No	Yes	Yes	
	CFU( )	Yes	No	No	Yes	Yes	
Pc	CFI( )	Yes	No	No	Yes	Yes	
	PC( )	Yes	No	No	Yes	Yes	
	Efficiency	ETA1( )	Yes	No	No	Yes	Yes
		ETA2( )	Yes	No	No	Yes	Yes
ETA3( )		Yes	No	No	Yes	Yes	
ETA4( )		Yes	No	No	Yes	Yes	
Integration <sup>6</sup>	WH( )	Yes	No	No	No	No	
	WHP( )	Yes	No	No	No	No	
	WHP( )	Yes	No	No	No	No	
	AH( )	Yes	No	No	No	No	
	AHP( )	Yes	No	No	No	No	
	AHM( )	Yes	No	No	No	No	
	WS( )	Yes	No	No	No	No	
	WQ( )	Yes	No	No	No	No	
Motor <sup>7</sup>	TI( )	Yes	No	No	No	No	
	SPEED( )	Yes	No	No	Yes	Yes	
	TORQUE( )	Yes	No	No	Yes	Yes	
	PM( )	Yes	No	No	Yes	Yes	
	SLIP( )	Yes	No	No	Yes	Yes	
Delta computation <sup>8</sup>	SYNC( )	Yes	No	No	Yes	Yes	
	DELTA1( )	Yes	No	No	Yes	Yes	
	DELTA2( )	Yes	No	No	Yes	Yes	
	DELTA3( )	Yes	No	No	Yes	Yes	
Harmonic phase angle	DELTA4( )	Yes	No	No	Yes	Yes	
	UPHI( , )	Yes	Yes	No	No	No	
Impedance	IPHI( , )	Yes	Yes	No	No	No	
	Z( , )	Yes	Yes	No	No	No	
	RS( , )	Yes	Yes	No	No	No	
	XS( , )	Yes	Yes	No	No	No	
	RP( , )	Yes	Yes	No	No	No	
	XP( , )	Yes	Yes	No	No	No	

**Appendix 12 Operands of User-Defined Functions That Can Be Used in Each Measurement Mode**

(Table 2/2)

Measurement Item <sup>1</sup>		Measurement Mode				
		Normal Measurement <sup>2</sup>	Wide Bandwidth Harmonic <sup>3</sup>	IEC Harmonic	Waveform Computation <sup>2</sup>	FFT <sup>3</sup>
Harmonics	UHDF( , )	Yes	Yes	No	No	No
	IHDF( , )	Yes	Yes	No	No	No
	PHDF( , )	Yes	Yes	No	No	No
	UTHD( )	Yes	Yes	No	No	No
	ITHD( )	Yes	Yes	No	No	No
	PTHDF( )	Yes	Yes	No	No	No
	UTHF( )	Yes	Yes	No	No	No
	ITHF( )	Yes	Yes	No	No	No
	UTIF( )	Yes	Yes	No	No	No
	ITIF( )	Yes	Yes	No	No	No
Phase angle of the fundamental component between phases	HVF( )	Yes	Yes	No	No	No
	HCF( )	Yes	Yes	No	No	No
	PHIU1U2( )	Yes	Yes	No	No	No
	PHIU1U3( )	Yes	Yes	No	No	No
	PHIU1I1( )	Yes	Yes	No	No	No
User-defined function <sup>11</sup>	PHIU1I2( )	Yes	Yes	No	No	No
	PHIU1I3( )	Yes	Yes	No	No	No
	F1( )	Yes	Yes	No	Limit	Limit
	F2( )	Yes	Yes	No	Limit	Limit
	F3( )	Yes	Yes	No	Limit	Limit
	F4( )	Yes	Yes	No	Limit	Limit
	F5( )	Yes	Yes	No	Limit	Limit
	F6( )	Yes	Yes	No	Limit	Limit
	F7( )	Yes	Yes	No	Limit	Limit
	F8( )	Yes	Yes	No	Limit	Limit
	F9( )	Yes	Yes	No	Limit	Limit
	F10( )	Yes	Yes	No	Limit	Limit
	F11( )	Yes	Yes	No	Limit	Limit
	F12( )	Yes	Yes	No	Limit	Limit
	F13( )	Yes	Yes	No	Limit	Limit
	F14( )	Yes	Yes	No	Limit	Limit
	F15( )	Yes	Yes	No	Limit	Limit
	F16( )	Yes	Yes	No	Limit	Limit
	F17( )	Yes	Yes	No	Limit	Limit
F18( )	Yes	Yes	No	Limit	Limit	
F19( )	Yes	Yes	No	Limit	Limit	
MAX hold	UMAX( )	Yes	Yes	No	Yes	Yes
	URMSMAX( )	Yes	No	No	Yes	Yes
	UMEANMAX( )	Yes	No	No	Yes	Yes
	IMAX( )	Yes	Yes	No	Yes	Yes
	PMAX( )	Yes	Yes	No	Yes	Yes
	SMAX( )	Yes	Yes	No	Yes	Yes
	QMAX( )	Yes	Yes	No	Yes	Yes
	UPPEAKMAX( )	Yes	No	No	Yes	Yes
	UMPEAKMAX( )	Yes	No	No	Yes	Yes
	IPPEAKMAX( )	Yes	No	No	Yes	Yes
IMPEAKMAX( )	Yes	No	No	Yes	Yes	

Yes: Can be measured or computed.

Limit: The data is set to NAN (no data) if the harmonic order section of the equation is not set to "ORT."

No: Cannot be measured or computed.

\*1 The maximum order for which the harmonic data is measured is the maximum harmonic order to be measured that is specified in the harmonic measurement (option) menu. The data is set to NAN (no data) for harmonic orders without data.

\*2 If the harmonic order section of the equation is set to ORT, the normal measurement value (the value that includes all frequency components) is substituted.

\*3 If the harmonic order section of the equation is set to ORT, the total value (the total value of each harmonic component) is substituted.

\*4 The measured data for the frequencies of input signals that are not specified for the frequency measurement are set to NAN (no data).

\*5 If the voltage or current mode is not RMS, the data of CfU or CfI is set to NAN (no data).

\*6 If there are no integrated values because integration is not performed, the data is set to NAN (no data). The data is set to NAN (no data) also for integration time.

\*7 The motor version (-MV) is required.

\*8 The delta computation option (/DT) is required.

\*9 The advanced computation option (/G6) or the harmonic measurement option (/G5) is required to measure the items related to harmonics and impedance.

\*10 For other items that do not have numeric data, the data is set to NAN (no data).

\*11 Can be used on WT3000s with firmware version 3.01 or later. For details, see section 5.4.



# Appendix 13 Parameters in the Operands of User-Defined Functions

The parameters that can be specified in the operands of user-defined functions are as follows:

Measurement Function	User-Defined Function		Left Parameter in ( , ) or Parameter in ( )		Right Parameter in ( , )			
			Element	Wiring Unit	Order			
					Normal Value or Total Value <sup>1</sup>	DC <sup>2</sup>	Fundamental Wave <sup>2</sup>	Harmonics <sup>2</sup>
Example	E1 to E4	E5 or E6	ORT	OR0	OR1	OR2 to OR100		
U	U( , )	U(E1,OR3)	Yes	Yes	Yes	Yes	Yes	Yes
Urms	URMS( )	URMS(E1)	Yes	No				
Umn	UMN( )	UMN(E1)	Yes	No				
I	I( , )	I(E1,OR3)	Yes	Yes				
P	P( , )	P(E1,OR3)	Yes	Yes	Yes	Yes	Yes	Yes
S	S( , )	S(E1,OR3)	Yes	Yes	Yes	Yes	Yes	Yes
Q	Q( , )	Q(E1,OR3)	Yes	Yes	Yes	Yes	Yes	Yes
$\lambda$	LAMBDA( , )	LAMBDA(E1,OR3)	Yes	Yes	Yes	Yes	Yes	Yes
$\phi$	PHI( , )	PHI(E1,OR3)	Yes	Yes	Yes	Yes	Yes	Yes
fU	FU( )	FU(E1)	Yes	No				
fl	FI( )	FI(E1)	Yes	No				
U+pk	UPPK( )	UPPK(E1)	Yes	No				
U-pk	UMPK( )	UMPK(E1)	Yes	No				
I+pk	IPPK( )	IPPK(E1)	Yes	No				
I-pk	IMPK( )	IMPK(E1)	Yes	No				
P+pk <sup>-4</sup>	PPPK( ) <sup>-4</sup>	PPPK(E1) <sup>-4</sup>	Yes <sup>-4</sup>	No <sup>-4</sup>				
P-pk <sup>-4</sup>	PMPK( ) <sup>-4</sup>	PMPK(E1) <sup>-4</sup>	Yes <sup>-4</sup>	No <sup>-4</sup>				
CfU	CFU( )	CFU(E1)	Yes	No				
Cfl	CFI( )	CFI(E1)	Yes	No				
Pc	PC( )	PC(E1)	Yes	Yes				
$\eta_1$	ETA1( )	ETA1( )	None or space <sup>3</sup>					
$\eta_2$	ETA2( )	ETA2( )	None or space <sup>3</sup>					
$\eta_3$	ETA3( )	ETA3( )	None or space <sup>3</sup>					
$\eta_4$	ETA4( )	ETA4( )	None or space <sup>3</sup>					
Wp	WH( )	WH(E1)	Yes	Yes				
Wp+	WHP( )	WHP(E1)	Yes	Yes				
Wp-	WHM( )	WHM(E1)	Yes	Yes				
q	AH( )	AH(E1)	Yes	Yes				
q+	AHP( )	AHP(E1)	Yes	Yes				
q-	AHM( )	AHM(E1)	Yes	Yes				
WS	SH( )	SH(E1)	Yes	Yes				
WQ	QH( )	QH(E1)	Yes	Yes				
Time	TI( )	TI(E1)	Yes	No				

• The following measurement functions can also be specified on models with the motor evaluation function (motor version).

Speed	SPEED( )	SPEED( )	None or space <sup>3</sup>	
Torque	TORQUE( )	TORQUE( )	None or space <sup>3</sup>	
Pm	PM( )	PM( )	None or space <sup>3</sup>	
Slip	SLIP( )	SLIP( )	None or space <sup>3</sup>	
SyncSp	SYNC( )	SYNC( )	None or space <sup>3</sup>	

## Appendix 13 Parameters in the Operands of User-Defined Functions

- The following measurement functions can also be specified on models with delta computation (option).

Measurement Function	User-Defined Function		Left Parameter in ( , ) or Parameter in ( )		Right Parameter in ( , )			
			Element	Wiring Unit	Order			
					Normal Value or Total Value <sup>1</sup>	DC <sup>2</sup>	Fundamental Wave <sup>2</sup>	Harmonics <sup>2</sup>
Example	E1 to E4	E5 or E6	ORT	OR0	OR1	OR2 to OR100		
ΔF1	DELTA1( )	DELTA1( )	None or space <sup>3</sup>					
ΔF2	DELTA2( )	DELTA2( )	None or space <sup>3</sup>					
ΔF3	DELTA3( )	DELTA3( )	None or space <sup>3</sup>					
ΔF4	DELTA4( )	DELTA4( )	None or space <sup>3</sup>					
ΔF1rms( ) <sup>5</sup>	DELTA1RMS( ) <sup>5</sup>	DELTA1RMS( ) <sup>5</sup>	None or space <sup>3,5</sup>					
ΔF2rms( ) <sup>5</sup>	DELTA2RMS( ) <sup>5</sup>	DELTA2RMS( ) <sup>5</sup>	None or space <sup>3,5</sup>					
ΔF3rms( ) <sup>5</sup>	DELTA3RMS( ) <sup>5</sup>	DELTA3RMS( ) <sup>5</sup>	None or space <sup>3,5</sup>					
ΔF4rms( ) <sup>5</sup>	DELTA4RMS( ) <sup>5</sup>	DELTA4RMS( ) <sup>5</sup>	None or space <sup>3,5</sup>					
ΔF1mn( ) <sup>5</sup>	DELTA1MN( ) <sup>5</sup>	DELTA1MN( ) <sup>5</sup>	None or space <sup>3,5</sup>					
ΔF2mn( ) <sup>5</sup>	DELTA2MN( ) <sup>5</sup>	DELTA2MN( ) <sup>5</sup>	None or space <sup>3,5</sup>					
ΔF3mn( ) <sup>5</sup>	DELTA3MN( ) <sup>5</sup>	DELTA3MN( ) <sup>5</sup>	None or space <sup>3,5</sup>					
ΔF4mn( ) <sup>5</sup>	DELTA4MN( ) <sup>5</sup>	DELTA4MN( ) <sup>5</sup>	None or space <sup>3,5</sup>					
ΔF1rnn( ) <sup>5</sup>	DELTA1RMN( ) <sup>5</sup>	DELTA1RMN( ) <sup>5</sup>	None or space <sup>3,5</sup>					
ΔF2rnn( ) <sup>5</sup>	DELTA2RMN( ) <sup>5</sup>	DELTA2RMN( ) <sup>5</sup>	None or space <sup>3,5</sup>					
ΔF3rnn( ) <sup>5</sup>	DELTA3RMN( ) <sup>5</sup>	DELTA3RMN( ) <sup>5</sup>	None or space <sup>3,5</sup>					
ΔF4rnn( ) <sup>5</sup>	DELTA4RMN( ) <sup>5</sup>	DELTA4RMN( ) <sup>5</sup>	None or space <sup>3,5</sup>					
ΔF1dc( ) <sup>5</sup>	DELTA1DC( ) <sup>5</sup>	DELTA1DC( ) <sup>5</sup>	None or space <sup>3,5</sup>					
ΔF21dc( ) <sup>5</sup>	DELTA2DC( ) <sup>5</sup>	DELTA2DC( ) <sup>5</sup>	None or space <sup>3,5</sup>					
ΔF31dc( ) <sup>5</sup>	DELTA3DC( ) <sup>5</sup>	DELTA3DC( ) <sup>5</sup>	None or space <sup>3,5</sup>					
ΔF41dc( ) <sup>5</sup>	DELTA4DC( ) <sup>5</sup>	DELTA4DC( ) <sup>5</sup>	None or space <sup>3,5</sup>					

- The measurement functions below can be computed on models with the advanced computation or harmonic measurement option.

φU	UPHI( , )	UPHI(E1,OR3)	Yes	No	No	No	No	Yes
φI	IPHI( , )	IPHI(E1,OR3)	Yes	No	No	No	No	Yes
Z	Z( , )	Z(E1,OR3)	Yes	No	No	No	Yes	Yes
Rs	RS( , )	RS(E1,OR3)	Yes	No	No	No	Yes	Yes
Xs	XS( , )	XS(E1,OR3)	Yes	No	No	No	Yes	Yes
Rp	RP( , )	RP(E1,OR3)	Yes	No	No	No	Yes	Yes
Xp	XP( , )	XP(E1,OR3)	Yes	No	No	No	Yes	Yes
Uhdf	UHDF( , )	UHDF(E1,OR3)	Yes	No	No	No	Yes	Yes
Ihdf	IHDF( , )	IHDF(E1,OR3)	Yes	No	No	No	Yes	Yes
Phdf	PHDF( , )	PHDF(E1,OR3)	Yes	No	No	No	Yes	Yes
Uthd	UTHD( )	UTHD(E1)	Yes	No				
Ithd	ITHD( )	ITHD(E1)	Yes	No				
Pthd	PTHD( )	PTHD(E1)	Yes	No				
Uthf	UTHF( )	UTHF(E1)	Yes	No				
Ithf	ITHF( )	ITHF(E1)	Yes	No				
Utif	UTIF( )	UTIF(E1)	Yes	No				
Itif	ITIF( )	ITIF(E1)	Yes	No				
hvf	HVF( )	HVF(E1)	Yes	No				
hcf	HCF( )	HCF(E1)	Yes	No				
φU1-U2	PHIU1U2( )	PHIU1U2(E5)	No	Yes				
φU1-U3	PHIU1U3( )	PHIU1U3(E5)	No	Yes				
φU1-I1	PHIU1I1( )	PHIU1I1(E5)	No	Yes				
φU1-I2	PHIU1I2( )	PHIU1I2(E5)	No	Yes				
φU1-I3	PHIU1I3( )	PHIU1I3(E5)	No	Yes				

## Appendix 13 Parameters in the Operands of User-Defined Functions

### User-Defined Function

Measurement Function	User-Defined Function		Left Parameter in ( , ) or Parameter in ( )		Right Parameter in ( , )			
			Element	Wiring Unit	Order			
					Normal Value or Total Value <sup>*1</sup>	DC <sup>*2</sup>	Fundamental wave <sup>*2</sup>	Harmonics <sup>*2</sup>
Example	E1 to E4	E5 or E6	ORT	OR0	OR1	OR2 to OR100		
F1	F1( )	F1( )	None or space <sup>*3</sup>					
F2	F2( )	F2( )	None or space <sup>*3</sup>					
F3	F3( )	F3( )	None or space <sup>*3</sup>					
F4	F4( )	F4( )	None or space <sup>*3</sup>					
F5	F5( )	F5( )	None or space <sup>*3</sup>					
F6	F6( )	F6( )	None or space <sup>*3</sup>					
F7	F7( )	F7( )	None or space <sup>*3</sup>					
F8	F8( )	F8( )	None or space <sup>*3</sup>					
F9	F9( )	F9( )	None or space <sup>*3</sup>					
F10	F10( )	F10( )	None or space <sup>*3</sup>					
F11	F11( )	F11( )	None or space <sup>*3</sup>					
F12	F12( )	F12( )	None or space <sup>*3</sup>					
F13	F13( )	F13( )	None or space <sup>*3</sup>					
F14	F14( )	F14( )	None or space <sup>*3</sup>					
F15	F15( )	F15( )	None or space <sup>*3</sup>					
F16	F16( )	F16( )	None or space <sup>*3</sup>					
F17	F17( )	F17( )	None or space <sup>*3</sup>					
F18	F18( )	F18( )	None or space <sup>*3</sup>					
F19	F19( )	F19( )	None or space <sup>*3</sup>					

### MAX hold

	UMAX( )	UMAX(E1)	Yes	Yes
Voltage	UMAX( )	UMAX(E1)	Yes	Yes
Rms voltage	URMSMAX( )	URMSMAX(E1)	Yes	No
Voltage mean	UMEANMAX( )	UMEANMAX(E1)	Yes	No
Current	IMAX( )	IMAX(E1)	Yes	Yes
Active power	PMAX( )	PMAX(E1)	Yes	Yes
Apparent power	SMAX( )	SMAX(E1)	Yes	Yes
Reactive power	QMAX( )	QMAX(E1)	Yes	Yes
Positive peak voltage	UPPEAKMAX( )	UPPEAKMAX(E1)	Yes	No
Negative peak voltage	UMPEAKMAX( )	UMPEAKMAX(E1)	Yes	No
Positive peak current	IPPEAKMAX( )	IPPEAKMAX(E1)	Yes	No
Negative peak current	IMPEAKMAX( )	IMPEAKMAX(E1)	Yes	No
Positive peak power <sup>*4</sup>	PPPEAKMAX( ) <sup>*4</sup>	PPPEAKMAX(E1) <sup>*4</sup>	Yes <sup>*4</sup>	No <sup>*4</sup>
Negative peak power <sup>*4</sup>	PMPEAKMAX( ) <sup>*4</sup>	PMPEAKMAX(E1) <sup>*4</sup>	Yes <sup>*4</sup>	No <sup>*4</sup>

\*1 If ORT is specified for the parameter, a normal value or total value (requires /G6) is substituted depending on the measurement mode.

\*2 Requires /G5 or /G6.

\*3 The parentheses cannot be omitted.

\*4 Can be used on WT3000s with firmware version 5.01 or later.

\*5 Can be used on WT3000s with firmware version 4.07 or later.

# Index

## Symbols

	Page
$\phi$ .....	5-6
$\eta$ Formula .....	5-20
$\lambda$ .....	5-6
$\Sigma$ functions (of normal measurement) .....	2-6
(I) Position .....	6-13
(I) V Zoom .....	6-13
(U) Position .....	6-13
(U) V Zoom .....	6-13
180 Lead/Lag .....	5-28
360 degrees .....	5-28
3P3W(3V3A): $\Sigma$ A Compensation .....	5-23
758931 .....	3-10

## A

	Page
Abort .....	8-16, 9-11, 9-25
AC power .....	App-19
accessories, optional .....	v
accessories, standard .....	iv
accuracy .....	12-5
active power .....	5-6, App-20
adapter .....	3-10
aliasing .....	2-26
All Items .....	5-2
All Reset .....	9-31, 9-34
All Set .....	9-31, 9-34
alternating current, vector display of .....	App-17
ambient humidity .....	3-2
ambient temperature .....	3-2
angular velocity .....	App-16
apparent power .....	5-6, App-20
apparent power, equation for .....	5-25
ASCII .....	8-15, 8-18, 9-13, 9-14
ASSP .....	App-33
attenuation constant .....	4-24
Attribute .....	9-28
Auto Cal .....	5-45
auto calibration .....	5-45
Auto Naming .....	9-10
auto naming function .....	8-19, 9-19, 9-23
auto range .....	2-10, 4-8
auto scaling .....	7-11
average active power .....	5-19
average count .....	4-24
Average for the Synchronous Source Period .....	App-33
averaging .....	2-13, 4-24
averaging type, selection of .....	4-24
AVG .....	4-24
Avg Type .....	4-24

## B

	Page
bar graph .....	2-32
Binary .....	9-7, 9-13
block diagram .....	2-2
BMP .....	9-23
built-in printer .....	2-36

## C

	Page
CAL .....	10-1
capacity .....	App-22
Cfl .....	5-6
CfU .....	5-6
character strings, entry of .....	3-28
Clear Trend Exec .....	7-16
clearing the internal memory .....	8-12
color .....	9-20, 9-23
comment .....	8-15, 9-10, 9-19, 9-21
Config .....	10-5, 10-7, 10-11
Continuous .....	5-41
continuous integration .....	5-40, 5-44
Copy .....	9-33
copy destination .....	9-35
Copy Exec .....	9-35
copy source .....	9-33
corrected power .....	2-19, 5-6
corrected power, equation for .....	5-26
crest factor .....	2-11, 4-18, 5-6, App-17
CT ratio .....	4-16
current .....	5-6
current hour .....	5-6
current input terminal .....	3-14
current mode .....	5-9
current range, setting of .....	4-6
CURSOR .....	6-23, 7-17
cursor measurement .....	6-23
Cursor Path .....	6-24
cycle-by-cycle measurement .....	2-34
cycle-by-cycle measurement mode .....	3-34

## D

	Page
D/A output .....	2-37
data compression .....	9-23
data format .....	9-23
data size .....	8-18, 9-12, 9-14
data type .....	8-15, 8-18, 9-7, 9-8, 9-13, 9-14
data update rate .....	4-27
Date/Time .....	3-24
DC .....	5-9
dc .....	App-1
Delete .....	9-30
Delete Exec .....	9-32
delta computation .....	2-6, 2-20
directories .....	9-37
directories, creation of .....	9-37
directory .....	8-15
display color .....	2-38, 10-8
display interpolation .....	6-18
display resolution .....	2-15
displayed items, number of .....	5-2, 5-7
displayed items, resetting the order of .....	5-5
distorted wave .....	App-21
distortion factor .....	2-20
Dual .....	6-17, 7-13
Dual List .....	5-7

## Index

<b>E</b>	<b>Page</b>
EAMP .....	App-33
efficiency .....	5-20
Efficiency Compensation .....	5-23
efficiency, equation for .....	5-20
Element Independent .....	4-4
elements, independent setting of .....	4-4
error messages .....	11-2
Ethernet .....	2-36
expendable items .....	11-11
Exponential Average for Measuring Period .....	App-33
Ext Clk .....	4-20
EXT SENSOR .....	4-12
extension .....	8-18, 9-12, 9-14
external current sensor range .....	4-12
external current sensor transformation ratio .....	4-13
external dimensions .....	12-16, 12-18
external trigger signal .....	6-10

<b>F</b>	<b>Page</b>
falling zero crossing .....	App-27
FFT .....	2-33
fl .....	5-6
FILE .....	9-3, 9-6, 9-27, 9-30, 9-33, 9-37
file attributes .....	9-27
file, deletion of .....	9-30
File Item .....	9-6
File List .....	8-15, 9-21
file name .....	8-15, 9-10, 9-19, 9-22, 9-23
file properties .....	9-27
file, specifying of .....	9-27
files, copying of .....	9-33
files, renaming of .....	9-37
Filter .....	8-16, 9-28
filter .....	2-12, 4-23
Float .....	8-15, 8-18, 9-7, 9-13, 9-14
Font .....	10-5
form factor .....	App-17
Format .....	9-4
format .....	9-3
Format Exec .....	9-4
FREQ FILTER .....	4-22
frequency .....	5-6
frequency filter .....	4-23
Frequency Meas Item .....	5-10
frequency measurement .....	5-10
front panel .....	1-1
FTP client function .....	2-36
fU .....	5-6
Function .....	9-3
function select keys .....	5-3
fundamental component .....	App-21
fundamental frequency .....	App-21
fundamental wave .....	App-21
fuse .....	v, 11-10, 12-16
fuse rating .....	11-10

<b>G</b>	<b>Page</b>
Gothic .....	10-5
GP-IB .....	2-37
Graph Color .....	10-8
graphic color .....	10-8, 10-10
graticule .....	6-18, 6-19

<b>H</b>	<b>Page</b>
handling precautions .....	3-1
harmonic component .....	App-21
harmonic distortion factor .....	App-21
harmonic measurement .....	2-6
harmonic order .....	App-21
harmonics .....	App-21
HELP .....	10-13
higher harmonic .....	App-21
hold .....	2-14, 4-29
horizontal axis .....	2-24

<b>I</b>	<b>Page</b>
I .....	5-6
I+pk .....	5-6
I-pk .....	5-6
IMAGE SAVE .....	9-20
inductance .....	App-22
initial settings .....	App-4
initialization .....	2-37, 3-26
Initialize Settings .....	3-26
inlet holes .....	3-2
input filter .....	4-22
INPUT INFO .....	3-39
input signal flow and process .....	2-2
input terminal, connecting to .....	3-14
installation condition .....	3-2
installation position .....	3-3
instantaneous value .....	App-16
instrument number .....	iii
INTEG .....	5-35, 5-38, 5-41, 5-45
Integ Set .....	5-35, 5-38, 5-41, 5-45
Integ Sync .....	8-1
integration auto calibration .....	5-45
integration hold .....	5-36
integration mode .....	2-21
integration reset .....	5-36
integration, starting of .....	5-36
integration stop .....	5-36
integration timer .....	5-36, 5-39, 5-42
internal memory, initialization of .....	8-13
Interpolate .....	6-18
Interval Setting .....	8-8
item to be saved .....	9-6

<b>J</b>	<b>Page</b>
JPEG .....	9-23

<b>K</b>	<b>Page</b>
Key Board .....	11-7
Key Lock .....	10-11
key test .....	11-8
keyboard test .....	11-8

<b>L</b>	<b>Page</b>
label .....	6-21
line filter .....	4-22, 4-23
List Item .....	8-4, 9-8
Load .....	9-25
Load Exec .....	9-25
Lower Scale .....	7-11
LPR client function .....	2-36

<b>M</b>	<b>Page</b>
Manual	8-1
manual integration	5-35
manual integration mode	5-30
manual scaling	7-11
master	10-14
master/slave synchronization measurement	10-14
master/slave synchronized measurement	2-38
Max	6-24
MAX hold	2-17, 5-17
maximum display	12-6
MEAN	5-9
MEASURE	1-7
measurement function symbols, meaning of	5-6
measurement functions, determination of	App-1
measurement method	12-9
measurement mode	2-3, 3-34
measurement period	4-19, App-26
measurement range	2-10, 4-6
media	9-4
Media Info	9-4
Memory	11-7
memory test	11-7
Memory to File Exec	8-16
message language	3-41
Mid	6-24
minimum display	12-6
MISC	1-9
mn	App-1
MODEL	ii
motor evaluation function	2-7

<b>N</b>	<b>Page</b>
normal integration mode	5-30, 5-38
normal measurement value	2-6
Normal Mode (Trg)	6-2
NULL	10-2
NULL function	2-38, 10-2
NUMERIC	5-1
numeric data, display order of	App-4
numeric data, saving of	9-14

<b>O</b>	<b>Page</b>
OF	5-7
OL	5-7
one year accuracy	12-6, 12-8
operating altitude	12-16
operating conditions	12-16
operators	5-16
options	ii
overflow	5-7
overrange	5-7

<b>P</b>	<b>Page</b>
P	5-6
package, contents of	ii
page, jumping of	5-4
page scroll	5-4
Pc	5-6
PC card	9-1
PC card, formatting of	9-3
phase angle	App-17
phase difference	2-20, 5-6, 5-28, App-17
phase difference, display format of	5-28

PNG	9-23
position	2-28, 6-13
Post Script	9-23
power	App-16
power coefficient, setting of	4-16
power consumption, maximum	12-16
power cord	ii
power factor	5-6, App-20
power fuse	11-10
power loss	App-24
power range	4-9, 4-10
power supply	3-4
power switch, turning ON/OFF of	3-5
Preset1	8-4, 9-8
Preset2	8-4, 9-8
print	2-36
properties	8-16, 9-28
Property	8-16, 9-28
protective grounding	3-4

<b>Q</b>	<b>Page</b>
Q	5-6
q	5-6
q+	5-6
q-	5-6
Quad	6-17, 7-13

<b>R</b>	<b>Page</b>
R	9-29
R-Continuous	5-41
R-Normal	5-41
R/W	9-29
rack mount	3-3
rated supply voltage	12-16
rated supply voltage frequency	12-16
reactive power	5-6, App-20
reactive power, equation for	5-25
Real Time	8-2, 8-9
Real Time Control	5-42, 8-9
real-time normal integration mode	5-30, 5-41
real-time repetitive integration mode	5-30, 5-41
rear panel	1-1
recall	2-35, 8-21
rectified mean value	5-9, App-1
rectified mean value calibrated to the rms value	5-9, App-1
Rename	9-38
repetitive integration mode	5-30, 5-38
reservation time	5-42
Reset Items Exec	5-5
resistance	App-22
response time	12-9
RGB video signal	2-37
rising zero crossing	App-27
RMEAN	5-9
rmn	App-1
RMS	5-9
roll paper	v
Roman	10-5

<b>S</b>	<b>Page</b>
S	5-6
safety terminal adapter	3-10
sample rate	12-11
sampled data	2-6
Sampling Frequency	10-4

## Index

save .....	9-7, 9-22
Save Exec .....	9-11
scale .....	7-10
scale value .....	6-21
scaling .....	2-11, 4-15, 7-11
scaling factor .....	4-16
screen brightness .....	10-7
screen, brightness of .....	2-38
screen divisions, number of .....	6-15, 7-13
screen image data, saving of .....	9-20
scroll .....	5-4
self-test .....	2-38, 11-7
Selftest .....	11-7
SENSOR RATIO .....	4-13
serial .....	2-37
Set/Reset .....	9-31, 9-34
settings that cannot be initialized .....	3-27
setup parameter list .....	3-39
setup parameters, loading of .....	9-24
setup parameters, saving of .....	9-12
SF .....	2-11, 4-16
SHIFT + key .....	viii
Shift Lock .....	10-11
simple average .....	5-9, App-1
single .....	4-29
Single List .....	5-7
single measurement .....	2-14
slave .....	10-14
SMTP client function .....	2-36
SNTP server .....	3-25
Soft Key .....	11-8
spare fuse .....	11-10
spare parts .....	v
split display .....	5-1, 6-1
storage environment .....	12-16
storage location .....	3-3
storage medium .....	9-4
storage medium and directory, selection of .....	9-18
storage medium information .....	9-5
storage operation, stopping of .....	8-13
storage, starting of .....	8-13
store .....	2-35, 8-1, 8-11
store count .....	8-7
store interval .....	8-8
Store Item .....	8-3
store mode .....	8-1
store reservation time .....	8-9
STORE SET .....	8-1, 8-3, 8-7, 8-11, 8-14, 8-21
Store Setting .....	8-1, 8-3, 8-7
Store to .....	8-11, 8-14
stored data, saving of .....	8-14
stored item .....	8-3
stray capacitance .....	App-25
SUFFIX .....	ii
symbols .....	vi
Sync Measure .....	10-14
SYNC SOURCE .....	4-19
synchronization source .....	4-19, App-26
synchronization source filter .....	App-28
synchronized measurement .....	2-38, 10-14
system condition .....	11-9
system conditions .....	2-37
system configuration .....	2-1
system errors .....	11-6
System Overview .....	11-9

<b>T</b>	<b>Page</b>
T/div .....	7-9
temperature coefficient .....	12-6, 12-8
Test Exec .....	11-7
Test Item .....	11-7
text color .....	10-9, 10-10
TIFF .....	9-23
time .....	3-24
time axis .....	2-24, 6-5, 7-8
time lag .....	11-10
Time/div .....	6-6
timer accuracy .....	12-11
Timer Setting .....	5-36, 5-39, 5-42
top panel .....	1-2
total harmonic distortion .....	App-21
total value .....	2-6
Trace .....	9-7
trademarks .....	i
Trend .....	7-1
Trend C1 + .....	7-18
Trend C2 x .....	7-18
Trend Cursor .....	7-18
Trend Cursor Setting .....	7-17
Trend Disp Items .....	7-5
Trend Display .....	7-3
trend display .....	7-1
Trend Scale .....	7-10
TrendC1 Trace .....	7-18
TrendC2 Trace .....	7-18
Triad .....	6-17, 7-13
Trigger .....	6-7
trigger level .....	2-27, 6-10
trigger mode .....	2-27, 6-9
trigger point .....	2-27
trigger slope .....	2-27, 6-10
trigger source .....	2-27, 6-9
true rms value .....	5-9
two-wattmeter method .....	5-23
TYPE 1 .....	5-27
TYPE 2 .....	5-27
TYPE 3 .....	5-27

<b>U</b>	<b>Page</b>
U .....	5-6
U+pk .....	5-6
U-pk .....	5-6
UPDATE RATE .....	4-27
Upper Scale .....	7-11
USB keyboard .....	3-32, 3-43
USB memory .....	9-1
User Defined Function .....	5-12
USER key .....	5-3
Utility .....	9-3, 9-27, 9-30, 9-33, 9-37

<b>V</b>	<b>Page</b>
V Zoom & Position .....	6-12
value, entry of .....	3-28
var-hour .....	5-6
vectors .....	2-32
vent holes .....	3-2
version .....	ii
vertical axis .....	2-24
VGA .....	2-37
volt-ampere-hour .....	5-6

voltage .....	5-6
voltage and current, determination of .....	2-7
voltage fluctuation and flicker measurement mode .....	3-34
voltage function and flicker measurement .....	2-34
voltage input terminal .....	3-14
voltage mode .....	5-9
voltage range, setting of .....	4-6
VT ratio .....	4-15

**W****Page**

warm-up time .....	12-16
warranty, items not covered by .....	11-11
warranty, scope of .....	11-11
watt hour .....	5-6
WAVE .....	6-1
Wave C1 + .....	6-24
Wave C1 Trace .....	6-24
Wave C2 Trace .....	6-24
Wave C2 x .....	6-24
Wave Cursor .....	6-23
Wave Display .....	6-3
Wave Mapping .....	6-16
Wave Trace .....	8-5
waveform .....	6-1
Waveform Computation .....	2-33
waveform display data, saving of .....	9-13
waveform mapping .....	7-13
Waveform Sampling Data .....	9-9, 9-15
waveform, zooming of .....	2-28
weight .....	12-16
WIRING .....	4-1
wiring compensation .....	5-22
wiring precautions .....	3-7
Wiring Setting .....	4-1
wiring system .....	2-9, 4-1
wiring unit .....	4-2
Wp .....	5-6
Wp+ .....	5-6
Wp- .....	5-6
WQ .....	5-6
WS .....	5-6

**Z****Page**

zero crossing .....	App-27
zero suppression .....	12-6
zero-crossing filter .....	App-28
zero-level compensation .....	10-1
zoom .....	2-28, 6-13