

# Instruction Manual

FX1□-VC (Voltage Input·Soft Variable Type)  
 FX2□-VC (Voltage Input·Soft Fixed Type)  
 FX3□-VC (mV Input·Soft Variable Type)  
 FX4□-VC (mV input·Soft Fixed Type)  
**Velocity Unit**

JUXTA

## 1. INSPECTION

This instrument has been thoroughly tested at the factory before shipment. When you receive it, visually inspect it for damage and check the accessories.

### 1.1 Model number and specification check

Check to see the model number and specifications on the nameplate attached to the front cover of the unit are as ordered.

### 1.2 Contents of the instruction manual

This instruction manual provides instructions on mounting, external wiring and maintenance.

## 2. GENERAL

### 2.1 Soft variable type (FX1□, FX3□)

This unit receives voltage or mV signal from transmitter and outputs isolated current or voltage signal after making velocity calculation through velocity time set by Handy Terminal.

### 2.2 Soft fixed type (FX2□, FX4□)

This unit receives voltage or mV signal from transmitter and outputs isolated current or voltage signal after making velocity calculation through velocity time set by Trimmer.

#### Accessories:

Mounting block	2
Tag number and range label	1 each
Mounting screw M4	2

## 3. MOUNTING METHOD

JUXTA signal conditioners can be mounted on rack, wall or DIN rail.

### 3.1 Rack mounting

Use panel (FRK-16) and install it on an angle as shown in Fig. 1. This is a convenient method for high density mounting of the unit on 19-inch rack panel. (See Fig. 6)

### 3.2 Wall mounting

Use panel (FRK-16) to mount the unit as shown in Fig. 2 or directly mount it on the wall (See Figs. 6 and 7 for mounting dimensions)

### 3.3 DIN rail mounting

Insert DIN rail into the upper of DIN rail groove on the rear of the unit and fix the rail with the slidlock at the lower of the unit as shown in Fig. 3.

### 3.4 Angle mounting

In case of single unit mounting, refer to Fig. 5 for its mounting.

### 3.5 Mounting block installation and removal

Insert mounting block into the groove of the unit as shown in Fig. 4 and slide it until it is locked with the stopper. To remove it, lift up the mounting block stopper with screwdriver (-) and slide it along the groove.

## 4. EXTERNAL WIRING

Open the terminal cover of the unit.

Wire should connect to M4 screw terminal. Flexible twisted wires and durable round crimp-on terminals (JIS C2805) are recommended to be used.

- Signal cable having more than 0.5mm<sup>2</sup> and power cable having more than 1.25mm<sup>2</sup> of nominal cross-sectional area of conductor are recommended.

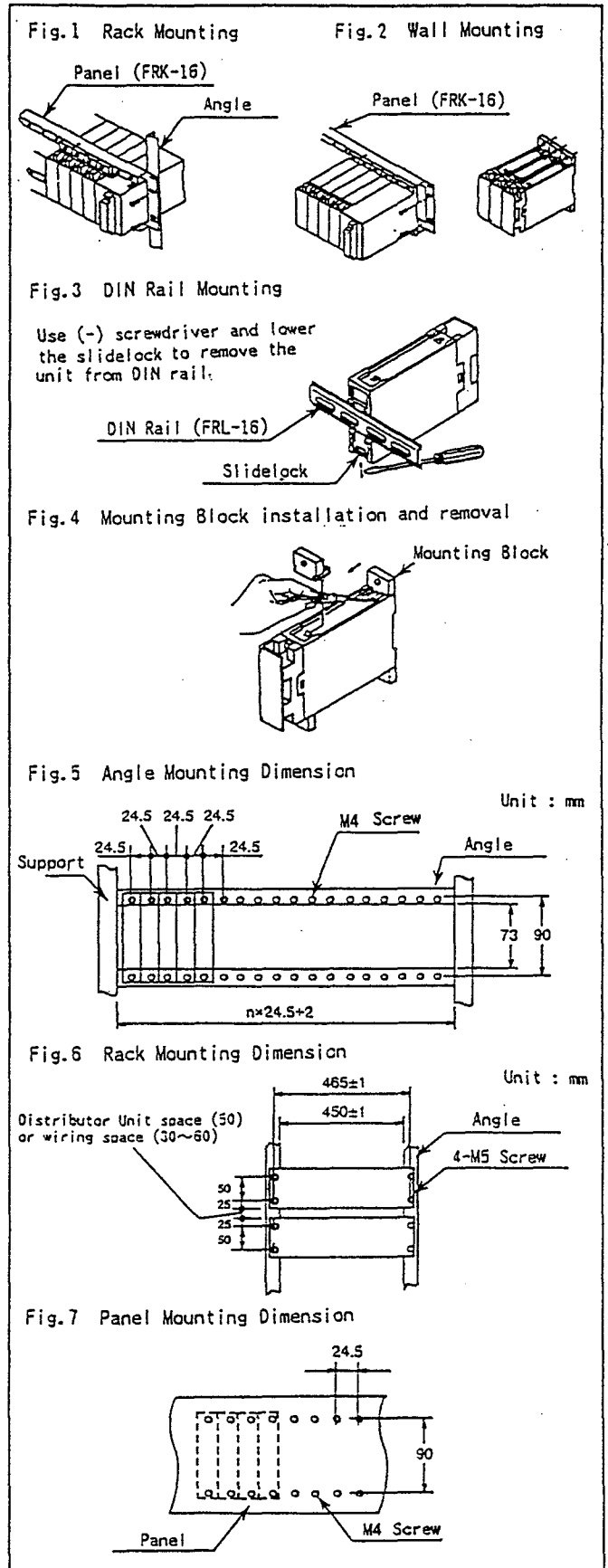

#### 4.1 Wiring

- ① See Fig. 8 for terminal arrangement.
- ② Connect input voltage signal cable of the unit to its terminals 2(+) and 3(-).
- ③ Connect output signal cable of the unit to its terminals 4(+) and 5(-).
- ④ Connect 24V DC power cable to terminals 6(+) and 7(-). (See Fig. 9)

#### 5. ITEMS TO BE CHECKED BEFORE TURNING THE POWER SWITCH ON

- ① Make sure that 24V DC power cable of the unit is connected to the correct polarities (+), (-).
  - ② Confirm that the external wiring to the terminal board is correct.
  - ③ Check that the mounting, ambient temperature, humidity, dust and vibration are normal.
- Confirm the above items before turning the power on. The unit needs 5 minutes warmup to meet its specified accuracy level.

#### 6. OPERATION CHECK

(Caution)

Carry out the following calibration after warming up the instruments for more than 5 minutes.

##### 6.1 Calibration equipment

- Voltage/Current Generator (Yokogawa Model 7651 or equivalent) 1
- Voltmeter (Yokogawa Model 7551A or equivalent) 1

##### 6.2 Check method

- ① Connect each equipment as shown in Figs. 10 and 11.
- ② Input/output characteristic check  
When input is fixed without changing input signal through Voltage/Current Generator, check that output is 50% of span and within specified accuracy rating range.  
If increase of input signal is made, check that output becomes more than 50% of span whereas if decrease of input signal is made, output becomes less than 50% of span at time of input change and the output is within specified accuracy rating range.
- ③ Velocity check  
Apply 0→100% step input to input terminal and check Time L (See Fig. 12) until output returns from 100% to 50% of span. The output should be within the tolerance of velocity time setup accuracy.  
As for soft fixed type, setup velocity time through trimmer. (Monitor setup value through CHECK terminal).  
Trimmer setup=0~1.000V corresponds to 0~1000 seconds of velocity time.  
Setup range of velocity time is 0~1000 seconds. (0.000~1.000V).

- If output signal is out of tolerance in case of ②, adjust it with Handy Terminal (JHT-100 or JHT200). For adjustment, refer Instruction Manuals of Handy Terminal.  
(JHT200 : IM JF81-02E, JHT-100 : IM JF81-01E)

#### 7. SET VALUE INPUT THROUGH HANDY TERMINAL

As for soft variable type, input range, velocity time, 1st lag constant can be changed through Handy Terminal. Velocity time is set by fixed constant C12. C12=0~100% corresponds to 0~1000 seconds of velocity time. Setup range of velocity time is 0~799.0 seconds (C12=0.0~799.0%)  
In case to put 1st lag filter into input, setup 1st lag time constant. Time constant is set by fixed constant C11. Setup range of time constant is 0.0~799.0 seconds (C11=0.0~799.0%)  
Input range is set by ZERO, SPAN (B10, B11).  
Set voltage corresponding 0% input on B10 and span voltage on B11.

Fig.8 Terminal Arrangement

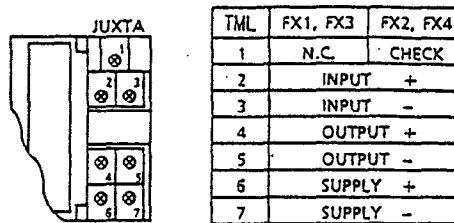

Fig.9 Wiring Diagram

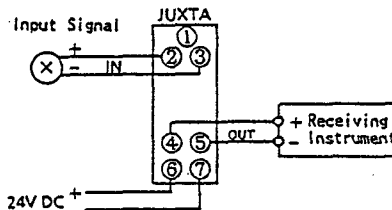

Fig.10. Wiring of Calibration Equipment (Soft Variable Type)

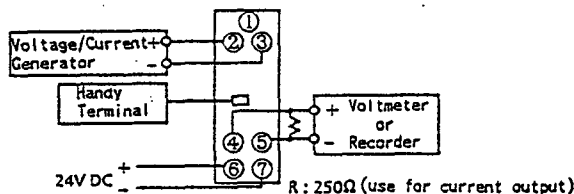

Fig.11 Wiring of Calibration Equipment (Soft Fixed Type)

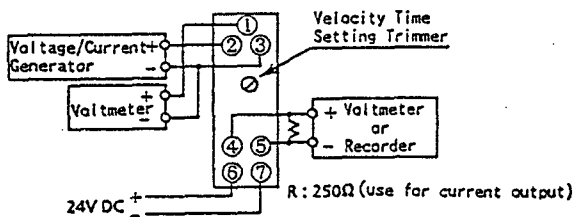

Fig.12

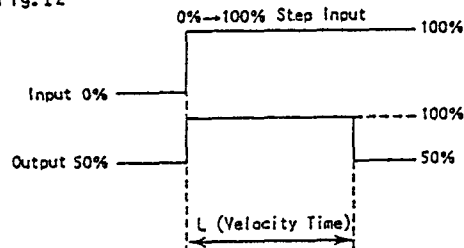
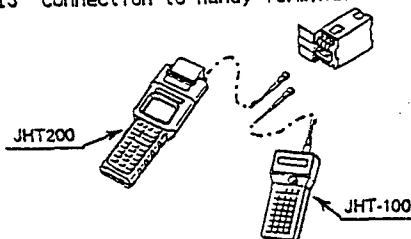

Fig.13 Connection to Handy Terminal



PARAMETER LIST

NO.	ITEM	TITLE DISPLAY	DATA DISPLAY
01	Model	MODEL	□□□□*□
02	Tag No.	TAG NO	16 Alphanumerics
03	Self Check	SELF CHK	Good or Error
A00	Display Item	DISPLAY	
A01	Input 1	INPUT 1	□□□□.□V/mV
A02	Output	OUTPUT	□□□.□%
A03	Status	STATUS	FF (Hexagonal 2 digits)
A04	Rev No.	REV NO	n.nnn (n : Rev No.)
A05	Load	LOAD	□□□.□%
A06	Input 2	INPUT 2	□□□□.□V/mV
A07	Buffer 1	BUFFER 1	□□□.□%
A08	Buffer 2	BUFFER 2	□□□.□%
A09	Buffer 3	BUFFER 3	□□□.□%
B00	Set Item	SET	
B01	Tag No.1	TAG NO.1	8 Alphanumerics (1st half 8 characters of Tag No.)
B02	Tag No.2	TAG NO.2	8 Alphanumerics (2nd half 8 characters of Tag No.)
B03	Comment 1	COMMENT 1	8 Alphanumerics
B04	Comment 2	COMMENT 2	8 Alphanumerics
B07	Input type *1	INP TYPE	Select from LL/L/H/HH
B10	Zero Point	ZERO	Numeric Data
B11	Span	SPAN	Numeric Data
B12	Burnout *1	BURN	Select from OFF/ON
B13	Setup Error	SET ERR	GOOD/ERROR
B20	Program *2	PROGRAM	Inter-company Setup [Item]
B21	Program *2	PROGRAM	Inter-company Setup [Item]
≡	≡	≡	≡
B48	Program *2	PROGRAM	Inter-company Setup [Item]
B49	Program *2	PROGRAM	Inter-company Setup [Item]
C00	Adjust Item	ADJUST	
C01	0% Output Adjust	OUT 0%	Numeric Data (±10.00)
C02	100% Output Adjust	OUT 100%	Numeric Data (±10.00)
C03	Wiring Resistance Adjust *1	WIRING R	RESET/EXECUTE
C04	0% input Adjust *2	IN 0%	
C05	100% input Adjust *2	IN 100%	
C11	Fixed Constant	CONST	Numeric Data
C12	Fixed Constant	CONST	Numeric Data
≡	≡	≡	≡
C40	Fixed Constant	CONST	Numeric Data
C41	Fixed Constant	CONST	Numeric Data

\*1 Display only FX3□-VC

\*2 Display only. Don't use

(Note) C17~C19 are display only

Subject to change without notice for grade up quality and performance.

---

**YOKOGAWA**   
Yokogawa Electric Corporation

Network Solutions Business Division  
2-9-32, Nakacho Musashino-shi, Tokyo, 180-8750 Japan  
Phone: (81)-422-52-7179 Fax: (81)-422-52-6793