

Model GX10/GX20/GP10/GP20/GM10

**Communication Command
User's Manual**

Introduction

Thank you for purchasing the SMARTDAC+ GX10/GX20/GP10/GP20/GM10 Series (hereafter referred to as the recorder, GX, GP, or GM).

This manual explains the dedicated commands for the recorder. To ensure correct use, please read this manual thoroughly before beginning operation.

For details on the functions related to SMARTDAC+ series options, see also the manual for the options.

Notes

- The contents of this manual are subject to change without prior notice as a result of continuing improvements to the instrument's performance and functions.
- Every effort has been made in the preparation of this manual to ensure the accuracy of its contents. However, should you have any questions or find any errors, please contact your nearest YOKOGAWA dealer.
- Copying or reproducing all or any part of the contents of this manual without the permission of YOKOGAWA is strictly prohibited.
- The TCP/IP software of this product and the documents concerning it have been developed/created by YOKOGAWA based on the BSD Networking Software, Release 1 that has been licensed from the Regents of the University of California.

QR Code

The product has a QR Code pasted for efficient plant maintenance work and asset information management.

It enables confirming the specifications of purchased products and user's manuals. For more details, please refer to the following URL.

<https://www.yokogawa.com/qr-code>

QR Code is a registered trademark of DENSO WAVE INCORPORATED.

Trademarks

- SMARTDAC+ is registered trademarks or trademarks of Yokogawa Electric Corporation.
- Microsoft and Windows are registered trademarks or trademarks of Microsoft Corporation in the United States and/or other countries.
- Adobe and Acrobat are registered trademarks or trademarks of Adobe Systems Incorporated.
- Kerberos is a trademark of Massachusetts Institute of Technology (MIT).
- Bluetooth is a trademark or registered trademark of Bluetooth SIG Inc.
- Company and product names that appear in this manual are registered trademarks or trademarks of their respective holders.
- The company and product names used in this manual are not accompanied by the registered trademark or trademark symbols (® and ™).

Revisions

December 2012	1st Edition
February 2013	2nd Edition
May 2013	3rd Edition
May 2014	4th Edition
December 2014	5th Edition
August 2015	6th Edition
December 2015	7th Edition
March 2016	8th Edition
June 2017	9th Edition
June 2018	10th Edition
July 2018	11th Edition
March 2019	12th Edition
December 2019	13th Edition

Recorder Version and Functions Described in This Manual

Edition	Product	Explanation
1	GX/GP: Version 1.01 and later	—
2	GX/GP: Version 1.02 and later	Feature additions.
3	GX/GP: Version 1.03 and later	Electromagnetic relay type analog input modules have been added. Feature additions.
4	GX/GP: Version 2.01 and later	Support for GX20/GP20 large memory type and expandable I/O has been added. Support for new modules (current (mA) input, low withstand voltage relay, and DI/DO) has been added. Feature additions. Advanced security function (/AS option) Custom display function (/CG option) EtherNet/IP communication (/E1 option) WT communication (/E2 option) Log scale function (/LG option) Etc.
5	GX/GP: Version 2.02 and later GM: Version 2.02 and later	Describes the GM. Feature additions. Bluetooth communication (/C8 option) [GM] USB communication [GM] Pulse input (DI module)
6	GX/GP: Version 2.02 and later GM: Version 2.03 and later	Advanced security function (/AS option) is added to the GM.
7	GX/GP: Version 3.01 and later GM: Version 3.01 and later	Support for new modules (pulse input). Feature additions. Aerospace Heat Treatment (/AH option) Multi batch function (/BT option) OPC-UA server function (/E3 option) SLMP communication (/E4 option) Others Etc.
8	GX/GP: Version 3.02 and later GM: Version 3.02 and later	Port limitation setting of DARWIN compatible communication has been added.
9	GX/GP: Version 4.01 and later GM: Version 4.01 and later	Support for new modules (analog output, high-speed AI, 4-wire RTD, PID control) Feature additions. Program control (/PG option) Logic math function (/MT option) Support for new measurement modes (high-speed AI, dual interval)
10	GX/GP: Version 4.02 and later GM: Version 4.02 and later	Calibration correction of communication channel has been added.
11	GX/GP: Version 4.03 and later GM: Version 4.03 and later	Support for new modules (High withstand voltage AI).
12	GX/GP: Version 4.06 and later GM: Version 4.06 and later	Additions and improvements to explanations.
13	GX/GP: Version 4.07 and later GM: Version 4.07 and later	Enhancements to the advanced security function (/AS option).

How to Use This Manual

This manual explains the dedicated communication commands for the recorder and how to use them. For details on the features of the recorder and how to use it, see the following manuals.

- Model GX10/GX20/GP10/GP20 Paperless Recorder First Step Guide (IM 04L51B01-02EN)
- Model GX10/GX20/GP10/GP20 Paperless Recorder User's Manual (IM 04L51B01-01EN)
- Data Acquisition System GM First Step Guide (IM 04L55B01-02EN)
- Data Acquisition System GM User's Manual (IM 04L55B01-01EN)

Conventions Used in This Manual

Unit

K	Denotes 1024. Example: 768K (file size)
k	Denotes 1000.

Markings



WARNING	Improper handling or use can lead to injury to the user or damage to the instrument. This symbol appears on the instrument to indicate that the user must refer to the user's manual for special instructions. The same symbol appears in the corresponding place in the user's manual to identify those instructions. In the manual, the symbol is used in conjunction with the word "WARNING" or "CAUTION."
CAUTION	Calls attention to actions or conditions that could cause serious or fatal injury to the user, and precautions that can be taken to prevent such occurrences.
Note	Calls attention to actions or conditions that could cause light injury to the user or cause damage to the instrument or user's data, and precautions that can be taken to prevent such occurrences.
	Calls attention to information that is important for the proper operation of the instrument.

Blank

Contents

1

2

App

Introduction.....	i
Recorder Version and Functions Described in This Manual.....	ii
How to Use This Manual.....	iii
Conventions Used in This Manual.....	iii

Chapter 1 Using Dedicated Commands (General)

1.1 Operations over an Ethernet Network.....	1-1
1.1.1 Preparing the Instrument.....	1-1
1.1.2 Sending Commands and Receiving Responses.....	1-1
1.2 Operations over the Serial Interface (RS-232, RS-422/485, USB, Bluetooth).....	1-2
1.2.1 Preparing the Instrument.....	1-2
1.2.2 Sending Commands and Receiving Responses.....	1-2
1.2.3 RS-232 Connection Procedure (GX/GP).....	1-3
1.2.4 RS-422/485 Connection Procedure.....	1-6
1.2.5 USB Connection Procedure (GM).....	1-9
1.2.6 Bluetooth Connection Procedure (GM, /C8 option).....	1-10

Chapter 2 Commands and Responses

2.1 Command Transmission and Recorder Responses.....	2-1
2.1.1 General Communication.....	2-1
2.1.2 Command Types and Functions.....	2-1
2.1.3 Command Syntax.....	2-1
2.1.4 Recorder Responses.....	2-4
2.2 List of Commands.....	2-5
2.2.1 Setting Commands.....	2-5
2.2.2 Output Commands.....	2-8
2.2.3 Operation Commands.....	2-9
2.2.4 Communication Control Commands.....	2-9
2.2.5 Instrument Information Commands.....	2-10
2.2.6 Conditions for Executing Commands.....	2-10
2.2.7 How to Use Commands.....	2-11
2.2.8 Device Nomenclature in Command Descriptions.....	2-11
2.3 Parameters.....	2-12
2.3.1 Measuring Range Parameters.....	2-12
2.3.2 Parameter Notation and Range.....	2-12
2.3.3 Specifying a Range.....	2-13
2.4 Setting Commands.....	2-14
2.5 Output Commands.....	2-95
2.6 Operation Commands.....	2-102
2.7 Communication Control Commands.....	2-114
2.8 Instrument Information Output Commands.....	2-116
2.9 Responses to Commands.....	2-117
2.9.1 Affirmative Response (For commands other than output request commands).....	2-117
2.9.2 Negative Response.....	2-117
2.9.3 Data Output Response.....	2-118
2.9.4 Output in Response to RS-422/485 Commands.....	2-120
2.10 ASCII Output Format.....	2-121
2.10.1 Most Recent Channel Data (FData).....	2-121
2.10.2 Most Recent (DO Channel) Status (FRelay).....	2-122
2.10.3 Internal Switch Status (FRelay).....	2-124
2.10.4 Latest re-transmission output (AO channel) state (FTransStatAO).....	2-124
2.10.5 Users Who Are Currently Logged In (FUser).....	2-126
2.10.6 All Users Who Are Currently Logged In (FUser).....	2-129
2.10.7 Instrument Address (FAddr).....	2-132
2.10.8 Recorder status (FStat).....	2-133
2.10.9 Alarm Summary (FLog).....	2-136
2.10.10 Message Summary (FLog).....	2-137
2.10.11 Event log (FLog).....	2-138
2.10.12 Error Log (FLog).....	2-138
2.10.13 Address Setting Log (FLog).....	2-139
2.10.14 General Communication Log (FLog).....	2-140

2.10.15	Modbus Communication Log (FLog).....	2-141
2.10.16	FTP Client Log (FLog).....	2-142
2.10.17	SNTP (Time Adjustment) Client Log (FLog).....	2-143
2.10.18	E-Mail Client Log (FLog).....	2-144
2.10.19	Web Log (FLog).....	2-145
2.10.20	SLMP Log (FLog).....	2-146
2.10.21	Control Alarm Summary (FLog).....	2-147
2.10.22	Control Summary (FLog).....	2-148
2.10.23	Detail Event Log Output (FEventLog) (/AS).....	2-150
2.10.24	External Storage Medium and Internal Memory File List (FMedia).....	2-160
2.10.25	External Storage Medium Free Space (FMedia).....	2-160
2.10.26	Setting Data (FCnf).....	2-161
2.10.27	Decimal Place and Unit Information (FChInfo).....	2-161
2.10.28	System Configuration (FSysConf).....	2-162
2.10.29	Bluetooth Device Information (FBTDevInfo).....	2-164
2.10.30	Reminder Information Output (FReminder).....	2-165
2.10.31	Outputs the Most Recent Control Data (FCtrlData).....	2-166
2.10.32	SP Number and PID Number Output (FCtrlNo.).....	2-167
2.10.33	Control Mode Output (FCtrlMode).....	2-168
2.10.34	Program Operation Mode Output (FPrgMode).....	2-169
2.10.35	Program Pattern Information Output (FPrgPtnInfo).....	2-170
2.10.36	PV event and time event information output (FPrgEvent).....	2-171
2.10.37	Program control end signal status output (FPrgEnd).....	2-172
2.10.38	Currently Running Program Pattern Number and Status Output (FPrgPtnCur).....	2-172
2.10.39	Instrument Manufacturer (_MFG).....	2-173
2.10.40	Instrument's Product Name (_INF).....	2-173
2.10.41	Instrument's Basic Specifications (_COD).....	2-174
2.10.42	Instrument's Firmware Version Information (_VER).....	2-174
2.10.43	Instrument's Option Installation Information (_OPT).....	2-175
2.10.44	Instrument's Temperature Unit and Daylight Saving Time Installation Information (_TYP).....	2-176
2.10.45	Instrument's Error Number Information (_ERR).....	2-176
2.10.46	Instrument's Unit Configuration Information (_UNS or _UNR).....	2-177
2.10.47	Instrument's Module Configuration Information (_MDS or MDR).....	2-178
2.11	Format of the Data Block of Binary Output.....	2-180
2.11.1	Most Recent Channel Data (FData).....	2-180
2.11.2	Channel FIFO Data (FFifoCur).....	2-183
2.11.3	FIFO Data Read Range (FFifoCur).....	2-183
2.11.4	The Most Recent Control Data (FCtrlData).....	2-184

Appendix

Appendix 1	ASCII Character Codes.....	App-1
Appendix 2	Login Procedure.....	App-2
	When Using the Login Function.....	App-2
	When Not Using the Login Function.....	App-3
Appendix 3	Output Flow Chart of External Storage Medium Files and File Lists.....	App-4
	Example for Outputting File aaaa.dtd.....	App-4
	Example for Outputting a File List.....	App-5
Appendix 4	FIFO Data Output Flow Chart.....	App-6
	Overview of the FIFO Buffer.....	App-6
	Example of FIFO Buffer Operation.....	App-6
Appendix 5	Check Sum Calculation Method.....	App-7
Appendix 6	Data Group Name and Data Name for WT Communication.....	App-8
	Parameters p5 (Data Group Name) and p6 (Data Name) for SWattData Command.....	App-8
Appendix 7	Bluetooth Communication Connection Flow Chart.....	App-14

1.1 Operations over an Ethernet Network

You can control the recorder by sending commands from a PC over an Ethernet network. There are various types of commands: setting commands, output commands, operation commands, communication control commands, and instrument information output commands.

1.1.1 Preparing the Instrument

Recorder Configuration

Configure the recorder to connect to the Ethernet network that you want to use. For instructions on how to configure the recorder, see section 1.17, “Configuring the Ethernet Communication Function” in the *Model GX10/GX20/GP10/GP20 Paperless Recorder User’s Manual* (IM 04L51B01-01EN) or section 2.18, “Configuring the Ethernet Communication Function,” in the *Data Acquisition System GM User’s Manual* (IM 04L55B01-01EN).

PC

The PC that you will use must meet the following requirements.

- The PC is connected to the Ethernet network that you want to use.
- The PC can run programs that you have created (see section 1.1.2, “Sending Commands and Receiving Responses,” below).

1.1.2 Sending Commands and Receiving Responses

Programs

When you send a command to the recorder, it will return a response. You can control the recorder by writing a program that sends commands and processes responses and then executing the program. You need to create the programs.

Example: If you send the command “FData,0,0001,0020” from your PC to the recorder, the recorder will return the most recent data of channels 0001 to 0020 in ASCII code. For details on commands and responses, see chapter 2, “Commands and Responses.”

Notes on Creating Programs

- **When Not Using the Login Function**

You can start using commands immediately after communication is established with the recorder.

- **When Using the Login Function**

Log in to the recorder using a system administrator account, a second administrator account or a normal user account that is registered in the recorder. Log in by connecting to the recorder and then sending the “CLogin” command.

- **Port Number**

The default port number is “34434.” You can change the port number using the **SServer** command.

1.2 Operations over the Serial Interface (RS-232, RS-422/485, USB, Bluetooth)

You can control the recorder by sending commands from a PC through the serial interface. There are various types of commands: setting commands, output commands, operation commands, communication control commands, and instrument information output commands. Except for a few special commands, the commands are the same as those used over an Ethernet network.

1.2.1 Preparing the Instrument

Connection

See section 1.2.3, “RS-232 Connection Procedure,” section 1.2.4, “RS-422/485 Connection Procedure,” section 1.2.5, “USB Connection Procedure,” or section 1.2.6, “Bluetooth Connection Procedure.”

Recorder Configuration

Configure the recorder to use serial communication. For instructions on how to configure the recorder, see section 1.18, “Configuring the Serial Communication Function (/C2 and /C3 options)” in the *Model GX10/GX20/GP10/GP20 Paperless Recorder User’s Manual* (IM 04L51B01-01EN) or section 2.19, “Configuring the Serial Communication Function (/C3 option),” section 2.20, “Configuring the USB Communication Function,” or section 2.21, “Configuring the Bluetooth Communication Functions,” in the *Data Acquisition System GM User’s Manual* (IM 04L55B01-01EN).

PC

The PC that you will use must meet the following requirements.

- The PC is connected to the recorder through the serial interface.
- The PC can run programs that you have created (see section 1.2.2, “Sending Commands and Receiving Responses,” below).

1.2.2 Sending Commands and Receiving Responses

Programs

When you send a command to the recorder, it will return a response. You can control the recorder by writing a program that sends commands and processes responses and then executing the program. You need to create the programs.

Example: If you send the command “FData,0,0001,0020” from your PC to the recorder, the recorder will return the most recent data of channels 0001 to 0020 in ASCII code.

For details on commands and responses, see chapter 2, “Commands and Responses.”

Notes on Creating Programs

- **For RS-232 (GX/GP), USB communication (GM), Bluetooth (GM, /C8 option)**
When you connect a PC to the recorder through the serial interface, the recorder will be ready to receive commands.

- **For RS-422/485**

The device that receives an open command (ESC O) from a PC will be ready to receive commands. The connection will close in the following situations.

- When the recorder receives a connection-close command (ESC C).

1.2.3 RS-232 Connection Procedure (GX/GP)

Connect a cable to the 9-pin D-sub RS-232 connector.

Connection

- Connector pin arrangement and signal names

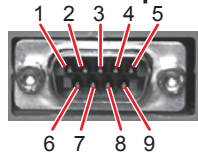

Each pin corresponds to the signal indicated below. The following table shows the signal name, RS-232 standard, JIS, and ITU-T standard signals.

Pin ¹	Signal Name			Name	Meaning
	JIS	ITU-T	RS-232		
2	RD	104	BB(RXD)	Received data	Input signal to the GX/GP.
3	SD	103	BA(TXD)	Transmitted data	Output signal from the GX/GP.
5	SG	102	AB(GND)	Signal ground	Signal ground.
7	RS	105	CA(RTS)	Request to send	Handshaking signal when receiving data from the PC. Output signal from the GX/GP.
8	CS	106	CB(CTS)	Clear to send	Handshaking signal when receiving data from the PC. Input signal to the GX/GP.

¹ Pins 1, 4, 6, and 9 are not used.

- Signal direction

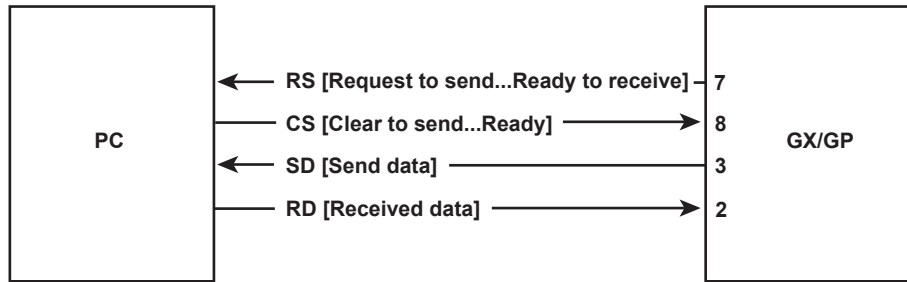

- Connection example

• OFF-OFF/XON-XON

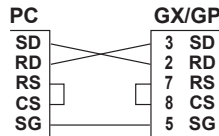

• CS-RS(CTS-RTS)

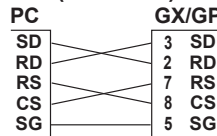

• XON-RS(XON-RTS)

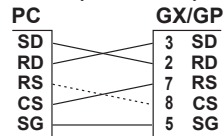

The connection of RS on the PC and CS on the GX/GP is not necessary. However, we recommend that you wire them so that the cable can be used in either direction.

Handshaking

When using the RS-232 interface for transferring data, it is necessary for equipment on both sides to agree on a set of rules to ensure the proper transfer of data. The set of rules is called handshaking. Because there are various handshaking methods that can be used between the GX/GP and the PC, you must make sure that the same method is chosen by both the GX/GP and the PC.

You can choose any of the four methods on the GX/GP in the table below.

Hand-shaking	Data transmission control (Control used when sending data to a PC)			Data Reception Control (Control used when receiving data from a PC)		
	Software Handshaking	Hardware Handshaking	No handshaking	Software Handshaking	Hardware Handshaking	No handshaking
OFF-OFF			Yes			Yes
XON-XON	Yes ¹			Yes ³		
XON-RS	Yes ¹				Yes ⁴	
CS-RS		Yes ²			Yes ⁴	

Yes Supported.

- 1 Stops transmission when X-OFF is received. Resume when X-ON is received.
- 2 Stops sending when CS (CTS) is false. Resumes when it is true.
- 3 Sends X-OFF when the receive data buffer is 3/4 full. Sends X-ON when the receive data buffer is 1/4th full.
- 4 Sets RS (RTS) to False when the receive data buffer is 3/4 full. Sets RS (RTS) to True when the receive data buffer becomes 1/4 full.

- **OFF-OFF**

Data transmission control

There is no handshaking between the GX/GP and the PC. The “X-OFF” and “X-ON” signals received from the PC are treated as data, and the CS signal is ignored.

Data reception control

There is no handshaking between the GX/GP and the PC. When the received buffer becomes full, all of the data that overflows are discarded.

RS = True (fixed).

- **XON-XON**

Data transmission control

Software handshaking is performed between the GX/GP and the PC. When an “X-OFF” code is received while sending data to the PC, the GX/GP stops the data transmission. When the GX/GP receives the next “X-ON” code, the GX/GP resumes the data transmission. The CS signal received from the PC is ignored.

Data reception control

Software handshaking is performed between the GX/GP and the PC. When the amount of used area in the received buffer reaches to 3/4 full (192 bytes for R2.01 and earlier; 6144 bytes for R2.02 and later), the GX/GP sends an “X-OFF” code. Then, when the amount of used area decreases to 1/4 bytes (64 bytes for R2.01 and earlier; 2048 bytes for R2.02 and later), the GX/GP sends an “X-ON” code.

RS = True (fixed).

- **XON-RS**

Data transmission control

The operation is the same as with XON-XON.

Data reception control

Hardware handshaking is performed between the GX/GP and the PC. When the amount of used area in the received buffer reaches to 3/4 full (192 bytes for R2.01 and earlier; 6144 bytes for R2.02 and later), the GX/GP sets “RS=False.” Then, when the amount of used area decreases to 1/4 bytes (64 bytes for R2.01 and earlier; 2048 bytes for R2.02 and later), the GX/GP sets “RS=True.”

- **CS-RS**

- **Data transmission control**

- Hardware handshaking is performed between the GX/GP and the PC. When the CS signal becomes False while sending data to the PC, the GX/GP stops the data transmission. When the CS signal becomes True, the GX/GP resumes the data transmission. The "X-OFF" and "X-ON" signals are treated as data.

- **Data reception control**

- The operation is the same as with XON-RS.

- **Note**

- - The PC program must be designed so that the received buffers of both the GX/GP and the PC do not become full.
 - If you select XON-XON, send the data in ASCII format.

1.2.4 RS-422/485 Connection Procedure

Connect a cable to the terminal.

Connection

- **Connecting the Cable**

As shown in the figure below, remove approximately 6 mm of the covering from the end of the cable to expose the conductor. Keep the exposed section from the end of the shield within 5 cm.

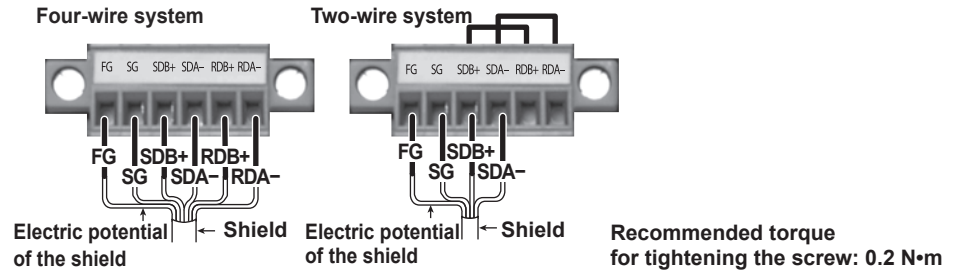

- **Signal names**

Each terminal corresponds to the signal indicated below.

Signal Name	Meaning
FG	Frame ground of the recorder.
SG	Signal ground.
SDB+	Send data B (+).
SDA-	Send data A (-).
RDB+	Receive data B (+).
RDA-	Receive data A (-).

Connecting to the host device

The figure below illustrates the connection of the recorder to a host device. If the port on the host device is an RS-232 interface, connect a converter.

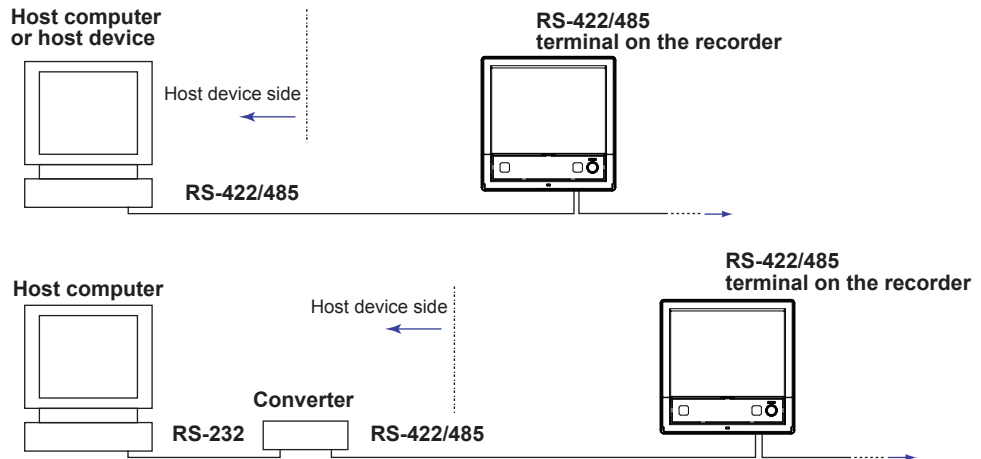

Connection example to the host device

A connection can be made with a host device having a RS-232, RS422, or RS-485 port. In the case of RS-232, a converter is used. See the connection examples below for a typical converter terminal. For details, see the manual that comes with the converter.

RS-422/485 Port	Converter
SDA(-)	TD(-)
SDB(+)	TD(+)
RDA(-)	RD(-)
RDB(+)	RD(+)
SG	SHIELD
FG	EARTH

There is no problem of connecting a 220-Ω terminator at either end if YOKOGAWA's PLCs or temperature controllers are also connected to the communication line.

• **Four-wire system**

Generally, a four-wire system is used to connect to a host device. In the case of a four-wire system, the transmission and reception lines need to be crossed over.

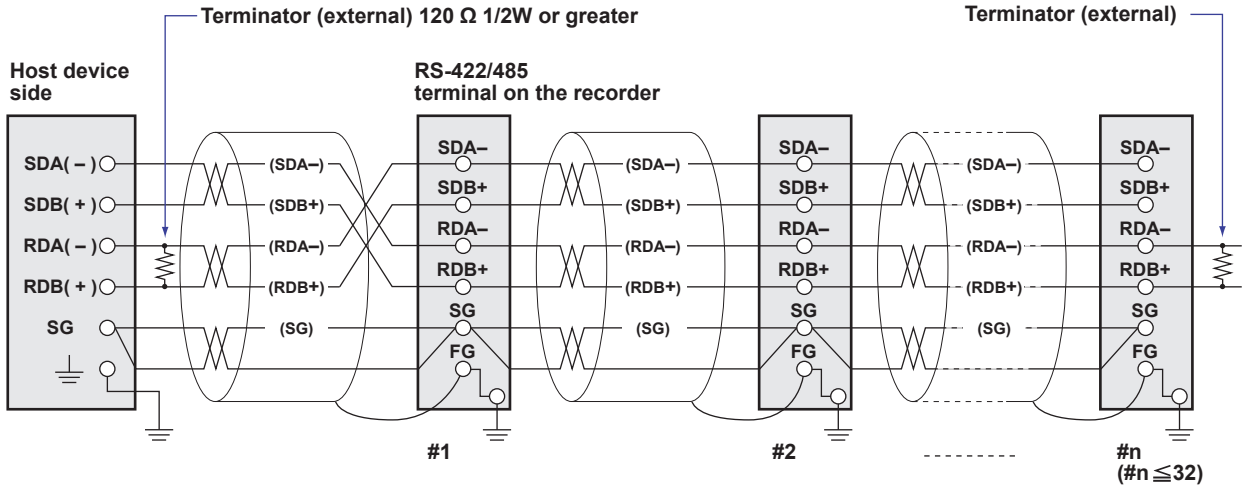

Do not connect terminators to #1 through #n-1.

• **Two-wire system**

Connect the transmission and reception signals with the same polarity on the RS-422/485 terminal block. Only two wires are used to connect to the external device.

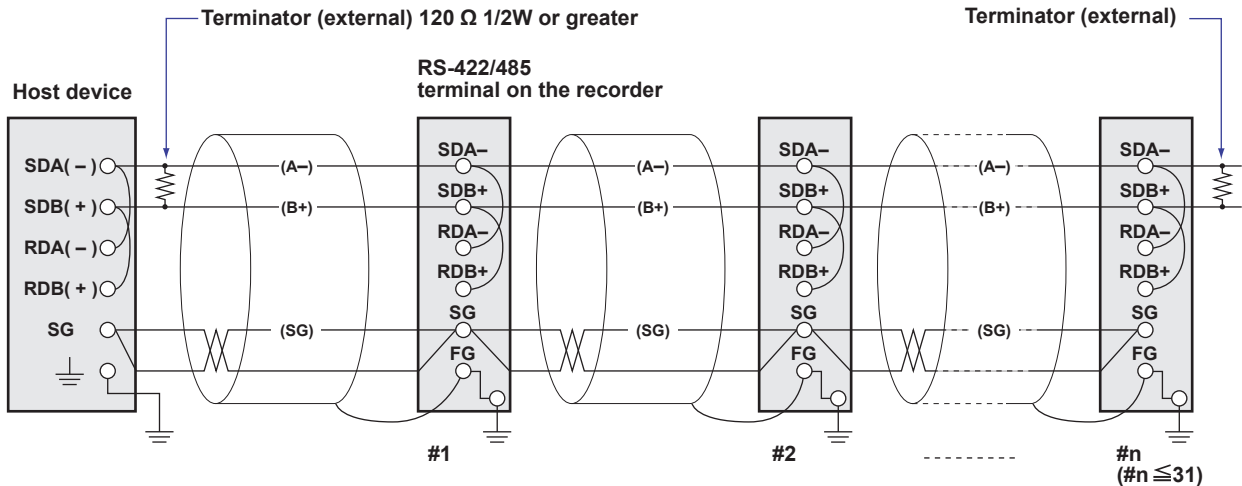

Do not connect terminators to #1 through #n-1.

Note

- The method used to eliminate noise varies depending on the situation. In the connection example, the shield of the cable is connected only to the recorder's ground (one-sided grounding). This is effective when there is a difference in the electric potential between the computer's ground and the recorder's ground. This may be the case for long distance communications. If there is no difference in the electric potential between the computer's ground and the recorder's ground, the method of connecting the shield also to the computer's ground may be effective (two-sided grounding). In addition, in some cases, using two-sided grounding with a capacitor connected in series on one side is effective. Consider these possibilities to eliminate noise.
- When using the two-wire interface (Modbus protocol), the 485 driver must be set to high impedance within 3.5 characters after the last data byte is sent by the host computer.

Serial interface converter

The recommended converter is given below.
SYSMEX RA CO.,LTD./MODEL RC-770X, LINE EYE/SI-30FA, YOKOGAWA/ML2



Some converters not recommended by Yokogawa have FG and SG pins that are not isolated. In this case, do not follow the diagram on the previous page (do not connect anything to the FG and SG pins). Especially in the case of long distance communications, the potential difference that appears may damage the recorder or cause communication errors. For converters that do not have the SG pin, they can be used without using the signal ground. For details, see the manual that comes with the converter.

On some non-recommended converters, the signal polarity may be reversed (A/B or +/- indication). In this case, reverse the connection.

For a two-wire system, the host device must control the transmission driver of the converter in order to prevent collisions of transmit and received data. When using the recommended converter, the driver is controlled using the RS (RTS) signal on the RS-232.

When instruments that support only the RS-422 interface exist in the system

When using the four-wire system, up to 32 recorders can be connected to a single host device. However, this may not be true if instruments that support only the RS-422 interface exist in the system.

When YOKOGAWA's recorders that support only the RS-422 interface exist in the system

The maximum number of connection is 16. Some of YOKOGAWA's conventional recorders (HR2400 and μ R, for example) only support the RS-422 driver. In this case, only up to 16 units can be connected.

Note

In the RS-422 standard, 10 is the maximum number of connections that are allowed on one port (for a four-wire system).

Terminator

When using a multidrop connection (including a point-to-point connection), connect a terminator to the recorder if the recorder is connected to the end of the chain. Do not connect a terminator to a recorder in the middle of the chain. In addition, turn ON the terminator on the host device (see the manual of the host device). If a converter is being used, turn ON its terminator. The recommended converter is a type that has a built-in terminator.

Select the appropriate terminator (120 Ω), indicated in the figure, according to the characteristic impedance of the line, the installation conditions of the instruments, and so on.

1.2.5 USB Connection Procedure (GM)

The procedure to connect a GM to the PC via USB is shown below. For instructions on how to use the PC, see the user's manual for your PC.

Configuring the GM

Turn the USB communication function on (default value is on). For the procedure, see section 2.19, "Configuring the USB Communication Function," in the *Data Acquisition System GM User's Manual* (IM 04L55B01-01EN).

Connecting the GM to the PC

Connect a USB cable to the USB port.

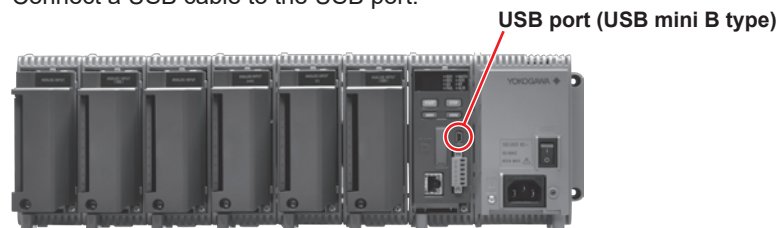

If the PC is connected to a network environment, a USB driver will be automatically installed. If it does not, check the download link for the driver at our website below, and install the driver.

<http://www.smartdacplus.com/en/support/software/index.html>

When the USB driver installation is complete, a COM port will be assigned.

Connect using the following communication conditions.

- Baud rate: 115200
- Parity: None
- Data length: 8 bits
- Stop bits: 1 bit
- Handshake: Off:Off

1.2.6 Bluetooth Connection Procedure (GM, /C8 option)

The procedure to connect a GM to the PC via Bluetooth is shown below. For instructions on how to use the PC, see the user's manual for your PC.

Configuring the GM

Turn the Bluetooth function on (default value is on). For the procedure, see section 2.20, "Configuring the Bluetooth Communication Function," in the *Data Acquisition System GM User's Manual* (IM 04L55B01-01EN).

Connecting the GM to the PC

- 1 Check whether the BT LED in the GM status display area is on. If the LED is off, hold down the GM USER1 key for at least 3 seconds. The BT LED in the GM status display area is turns on, the GM enters the connection standby state.

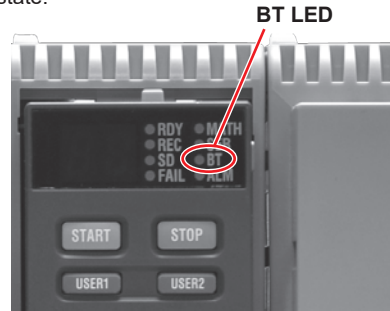

- 2 Perform a pairing operation from the PC.

A 6-digit authentication code appears on the GM's 7 segment LED. Check that this authentication code matches that shown on the PC, and pair the devices. When pairing is complete, a COM port will be assigned.

Note

The GM stores up to eight entries of pairing information. This information is retained even when the power is turned off.
The pairing operation is not necessary in subsequent connections.

- 3 Perform the operation for connecting from the PC to the GM. See "Appendix 7 Bluetooth Communication Connection Flow Chart" and section "2.2.7 How to Use Commands".

2.1 Command Transmission and Recorder Responses

2.1.1 General Communication

The recorder can work with various applications through the use of commands. The communication that is achieved through commands is referred to as “general communication.”

2.1.2 Command Types and Functions

The following types of commands are available. The first character of command names represents the command type. For example, in the command “SRangeAI,” “S” represents the command type. The second and subsequent characters represent the contents of commands.

Type	Description
Operation commands Example: OSetTime	Commands that start with “O.” These commands are used to operate the recorder.
Setting commands Example: SRangeAI	Commands that start with “S.” These commands change the recorder settings.
Output commands Example: FData	Commands that start with “F.” These commands cause the recorder to output measured data and other types of data.
Communication Control commands Example: CChecksum	Commands that start with “C.” These commands control the communication with the recorder.
Instrument information output commands Example: _MFG	Commands that start with an underscore. These commands cause the recorder to output its instrument information.

2.1.3 Command Syntax

A Single Command

A single command consists of a command name, parameters, delimiters, and terminator. The command name is written in the beginning, and parameters follow. Delimiters are used to separate the command name from parameters and between each parameter. A delimiter is a symbol that indicates a separation. A terminator is attached to the end of a command.

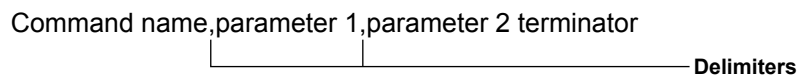

Example of a Command

SRangeAI,0001,VOLT,2V,OFF,-15000,18000,0

Commands in a Series (Setting commands only)

You can send multiple setting commands in a series. When writing a series of commands, separate each command with a sub delimiter. A sub delimiter is a symbol that indicates a separation. A terminator is attached to the end of the series. The maximum number of bytes that can be sent at once is 8000 bytes (8000 characters).

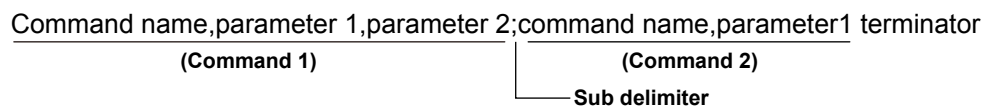

Notes on Writing Commands in a Series

- Only setting commands can be written in a series.
- Queries (see the next section) cannot be written in a series.
- If there is an error in one of the commands in a series, the commands before it are canceled, and those after it are not executed.

Example of a Command

SRangeAI,0001,VOLT,2V,OFF,-15000,18000,0;SRangeAI,0002,SKIP

Queries

Queries are used to inquire the recorder settings. To send a query, append a question mark to the command name or parameter. When the recorder receives a query, it returns the relevant setting as a character string in an appropriate syntax. Queries can be used on some of the available setting and operation commands.

Command name? terminator

Command name,parameter1? terminator

Examples of Queries and Responses

Query	Example of Responses
SRangeAI?	SRangeAI,0001,VOLT,2V,OFF,-20000,20000,0 SRangeAI,0002,.....
SRangeAI,0001?	SRangeAI,0001,VOLT,2V,OFF,-20000,20000,0

Command Names

A command name is a character string consisting of up to 16 alphanumeric characters. The first character represents the command type.

Notes on Writing Commands Names

- Command names are not case sensitive.
- Spaces before the character string are ignored.

Parameters

Parameters are characteristic values that are attached to commands.

Notes on Writing Parameters

- Write parameters in their appropriate order.
- Spaces around and in the middle of parameters are ignored. Exception is the character strings that users specify.
- You can omit the setting command parameters that do not need to be changed from their current settings. If you omit parameters, write only the delimiters.
Example: `SRangeAI,0001,,,,,1800,0 terminator`
- If parameters are omitted and there are multiple delimiters at the end of the command, those delimiters can be omitted.
Example: `SRangeAI,0001,VOLT,2V,,,, terminator -> SRangeAI,0001,VOLT,2Vterminator`

There are two types of parameters: predefined expressions and user-defined character strings.

How to Write User-Defined Character Strings (Parameters)

- Enclose user-defined character strings in single quotation marks.
Example The command for setting the channel 0001 tag to "SYSTEM1" is shown below.
`STagIO,0001,'SYSTEM1'`
- There are two types of user-defined character strings depending on the type of characters that can be used.

Character Strings Consisting Only of Characters in the ASCII Code Range (0x00 to 0x7f)

In this manual, applicable parameters are indicated with "ASCII."

Example p3 Tag number (up to 16 characters, ASCII)

You can use alphanumeric characters and some of the symbols. For the ASCII characters that you can use, see appendix 1.

Character Strings Consisting of Characters in the UTF-8 Code Range

In this manual, applicable parameters are indicated with "UTF-8."

Example p2 Tag (up to 32 characters, UTF-8)

UTF-8 codes include ASCII codes. You can use UTF-8 characters, including the ASCII characters above. For the ASCII characters that you can use, see appendix 1.

Delimiters

Commas are used as delimiters.

Sub delimiters

Semicolons are used as sub delimiters.

Terminators

"CR+LF" is used as a terminator, meaning "CR" followed by "LF." Expressed in ASCII code, it is 0x0d0x0a.

2.1.4 Recorder Responses

The recorder returns the following responses to commands.

- If the recorder successfully completes the processing of a received output request command, it outputs the requested data.
- If the recorder successfully completes the processing of a received command that is not an output request command, it outputs an affirmative response.
- If a command syntax error, setting error, or other error occurs, the recorder outputs a negative response.

For each command the recorder receives, it returns a single response. The controller (PC) side must process commands and responses in accordance with this command-response rule. If the command-response rule is not followed, the operation of the recorder is not guaranteed. For details on the response syntax, see [2.9 Responses to Commands](#).

2.2 List of Commands

Unless specified otherwise, AI, AO, DI, DO, PI, and PID represent I/O channel types.

- AI Analog input
- AO Analog output
- DI Digital input
- DO Digital output
- PI Pulse input
- PID PID control

2.2.1 Setting Commands

Command	Description (Required Options) [Applicable Models]	Page
Measurement Operation Setting Commands		
SScan	Scan interval	2-14
SScanGroup	Scan group (module scan interval)	2-14
SModeAI	AI module	2-15
SModeAICurrent	Current input type AI module	2-15
SBOLmtAI	Upper and lower burnout limits of AI module	2-16
SBOLmtAICurrent	Upper and lower burnout limits of current input type AI module	2-16
SModeDI	DI module	2-16
SModePID	PID control module	2-16
SScaleOver	Detection of values that exceed the scale	2-17
Recording Basic Setting Commands		
SMemory	Recording mode	2-17
SMemKeyConfirm	Record confirmation action [GX/GP]	2-17
SDispData	Display data recording	2-17
SEventData	Event data recording	2-18
Recording Channel Setting Commands		
SRecDisp	Channel for recording display data	2-19
SRecEvent	Channel for recording event data	2-19
SRecManual	Channel for recording manual sampled data	2-20
Batch Setting Commands		
SBatch	Batch function	2-20
STextField	Batch text	2-20
Data Save Setting Commands		
SDirectory	Name of directory to save data	2-20
SFileHead	File header	2-20
SFileName	File naming rule	2-21
SMediaSave	Automatic data file saving	2-21
SFileFormat	Display/event data file format	2-21
I/O Channel (AI/AO/DI/DO/PI/PID) Setting Commands		
SRangeAI	Measurement range of AI channel	2-22

SRangeAICurrent	Measurement range of current input type AI channel	2-23
SRangePulse	Measurement range of pulse input channel	2-24
SRangeDI	Measurement range of DI channel	2-25
SRangeDO	DO channel operation	2-25
SRangeAO	AO channel operation	2-26
SMoveAve	Moving average	2-26
SFilter	First-order lag filter	2-27
SBurnOut	Behavior when a sensor burns out	2-27
SRjc	Reference junction compensation method	2-27
SAlarmIO	Alarm	2-28
SAlmHysIO	Alarm hysteresis	2-28
SAlmDlyIO	Alarm delay time	2-29
STagIO	Tag	2-29
SColorIO	Channel color	2-29
SZoneIO	Waveform display zone	2-30
SScaleIO	Scale display [GX/GP]	2-30
SBarIO	Bar graph display	2-30
SPartialIO	Partial expanded display [GX/GP]	2-30
SBandIO	Color scale band	2-30
SAlmMarkIO	Alarm mark	2-31
SValueIO	Upper/lower limit display characters	2-31
SCalibIO	Calibration correction	2-32
SPresetAO	AO channel preset action	2-33
Math Channel Setting Commands		
SMathBasic	Math action (/MT)	2-33
SKConst	Constant (/MT)	2-34
SRangeMath	Computation expression (/MT)	2-34
STlogMath	TLOG (/MT)	2-34
SRolAveMath	Rolling average (/MT)	2-34
SAlarmMath	Alarm (/MT)	2-35
SAlmHysMath	Alarm hysteresis (/MT)	2-35
SAlmDlyMath	Alarm delay time (/MT)	2-35
STagMath	Tag (/MT)	2-36
SColorMath	Channel color (/MT)	2-36
SZoneMath	Waveform display zone (/MT)	2-36
SScaleMath	Scale display (/MT) [GX/GP]	2-36
SBarMath	Bar graph display (/MT)	2-36
SPartialMath	Partial expanded display (/MT)[GX/GP]	2-36
SBandMath	Color scale band (/MT)	2-37
SAlmMarkMath	Alarm mark (/MT)	2-37
Communication Channel Setting Commands		
SRangeCom	Measurement range (/MC)	2-38
SValueCom	Preset operation (/MC)	2-38
SWDCom	Watchdog timer (/MC)	2-38
SAlarmCom	Alarm (/MC)	2-38
SAlmHysCom	Alarm hysteresis (/MC)	2-39
SAlmDlyCom	Alarm delay time (/MC)	2-39
STagCom	Tag (/MC)	2-39
SColorCom	Channel color (/MC)	2-39

2.2 List of Commands

SZoneCom	Waveform display zone (/MC)	2-39	SSclBmp	Scale bitmap image usage [GX/GP]	2-50
SScaleCom	Scale display (/MC) [GX/GP]	2-39	SMessage	Message	2-50
SBarCom	Bar graph display (/MC)	2-40	System Setting Commands		
SPartialCom	Partial expanded display (/MC)[GX/GP]	2-40	Page		
SBandCom	Color scale band (/MC)	2-40	STimeZone	Time zone	2-50
SAlmMarkCom	Alarm mark (/MC)	2-40	SDateBasic	Gradual time adjustment	2-50
SCalibUseCom	Calibration correction use On/Off	2-41	SDateFormat	Date format	2-50
SCalibCom	Calibration correction	2-41	SDst	Daylight saving time	2-51
Alarm Setting Commands			Page		
SAlmLimit	Rate-of-change alarm interval	2-42	SLang	Language	2-51
SIndivAlmACK	Individual alarm ACK	2-42	STemp	Temperature unit	2-51
SAlmSts	Alarm display hold/nonhold	2-42	SDPoint	Decimal point type	2-51
SAlmACKCmt	Alarm ACK Comment Input (/AS)		SFailAct	Fail relay operation (/FL) [GX/GP]	2-51
SFixedAlmACKCmt	Fixed ACK Comment (/AS)		SFailSts	Instrument status to output (/FL) [GX/GP]	2-52
ACK			SPrinter	Printer	2-52
Time Setting Commands			Page		
STimer	Timer	2-42	SLed	LED indicator operation [GX/GP]	2-52
SMatchTimer	Match time timer	2-43	SSound	Sound [GX/GP]	2-52
Event Action Setting Commands			Page		
SEventAct	Event action	2-43	SInstruTag	Instruments tag	2-52
Report Setting Commands			Page		
SReport	Report type (/MT)	2-45	SConfCmt	Setting file comment	2-52
SRepData	Report data (/MT)	2-46	SFixedConfCmt		
SRepTemp	Report output (/MT)	2-46	SUsbInput	USB input device [GX/GP]	2-53
SDigitalSign	Electronic signature inclusion (/MT)	2-46	SSetComment	Configuration changes comment (/AS)	2-53
SRepCh	Report channel (/MT)	2-46	Internal Switch Setting Commands		
SRepBatchInfo	Batch information output (/MT)	2-47	Page		
Display Setting Commands			Page		
SLcd	LCD [GX/GP]	2-47	SSwitch	Internal switch operation	2-53
SViewAngle	View angle [GX/GP]	2-47	Serial Communication Setting Commands		
SBackColor	Screen background color [GX/GP]	2-47	Page		
SGrpChange	Automatic group switching time [GX/GP]	2-47	SSerialBasic	Serial communication basics (/C2 or /C3)	2-53
SAutoJump	Jump default display operation [GX/GP]	2-47	SModMaster	Modbus master (/C2/MC or /C3/MC)	2-54
SCalFormat	Calendar display format [GX/GP]	2-48	SModMcmd	Modbus master transmission command (/C2/MC or /C3/MC)	2-54
SBarDirect	Bar graph display direction [GX/GP]	2-48	SSerialAutoLOut	Auto logout for serial communication (/C2 or /C3)	2-54
SChgMonitor	Value modification from the monitor	2-48	Ethernet Communication Setting Commands		
STrdWave	Trend waveform display [GX/GP]	2-48	Page		
STrdScale	Scale [GX/GP]	2-48	SIPAddress	IP address information	2-55
STrdLine	Trend line width, grid [GX/GP]	2-48	SClient	Client function	2-55
STrdRate	Trend interval switching [GX/GP]	2-49	SClientEncrypt	Client Communication Encryption	2-55
STrdKind	Trend type [GX/GP]	2-49	SDns	DNS information	2-55
STrdPartial	Partial expanded trend display [GX/GP]	2-49	SDhcp	DHCP client	2-55
SMsgBasic	Message writing	2-49	SftpKind	File to transfer via FTP	2-56
SGroup	Display group	2-49	SftpTime	FTP transfer time shift	2-56
STripLine	Display group trip line	2-50	SftpCnct	FTP client connection destination server	2-56
			SSmtpLogin	SMTP user authentication	2-56
			SSmtpCnct	SMTP client connection destination server	2-56
			SmailHead	Mail header	2-57
			SmailBasic	Common section of the mail body	2-57
			Smail	Destination and behavior for each mail type	2-57
			SmailAlarm	Alarm notification mail target channels	2-57

SMailAlarmLevel	Alarm notification mail target alarm levels	2-58	SMonitor	Monitor screen display information [GX/GP]	2-68
SMailAlarmDetect	Alarm notification mail target alarm detection method	2-58	SMultiPattern	Multi panel division [GX/GP]	2-69
SMailTime	Scheduled transmission times	2-58	SMultiKind	Multi panel [GX/GP]	2-69
SSntpCnct	SNTP client	2-58	SHomeMonitor	Standard display information [GX/GP]	2-70
SModClient	Modbus client operation (/MC)	2-58	SHomeKind	Standard display [GX/GP]	2-70
SModCList	Modbus client connection destination server (/MC)	2-58	SFavoriteMonitor	Favorite screen display information [GX/GP]	2-71
SModCCmd	Modbus client transmission command (/MC)	2-59	SFavoriteKind	Favorite screen [GX/GP]	2-71
SServer	Server function	2-59	Multi Batch Setting Commands (/BT)		Page
SServerEncrypt	Server communication encryption	2-60	SMLtTextField	Batch text	2-71
SKeepAlive	Keepalive	2-60	SMLtFileHead	File header	2-71
STimeout	Communication timeout	2-60	SMLtFileName	File naming rule	2-72
SftpFormat	FTP server directory output format	2-60	SMLtGroup	Display group	2-72
SModDelay	Modbus server delay response	2-60	SMLtTripLine	Display group trip line	2-72
SModLimit	Modbus server connection limit	2-60	SMLtSc1Bmp	Scale bitmap	2-72
SModList	IP address to allow connection to Modbus server	2-60	SMLtMulti	Multi panel pattern	2-73
SWattList	WT communication connection server (/E2)	2-60	Pattern		
SWattClient	WT communication operation (/E2)	2-60	SMLtMultiKind	Multi panel type	2-73
SWattData	WT data allocation to communication channel (/E2)	2-61	Bluetooth Communication Setting Commands		Page
SKdcCnct	KDC connection destination (/AS)	2-61	SBluetooth	Bluetooth communication function (/C8) [GM]	2-73
SAuthKey	Certification key (/AS)	2-61	SBTID	Bluetooth communication ID (/C8) [GM]	2-73
SDarwinCnvCh	Darwin channel conversion (Darwin compatible communication)	2-61	SBTTimeout	Bluetooth communication timeout (/C8) [GM]	2-74
SDarwinPortLimit	Port limitation of DARWIN compatible communication	2-62	USB Setting Commands		Page
SSLMPClient	SLMP client operation (/E4)	2-62	SUsbFunction	USB function [GM]	2-73
SSLMPCList	SLMP connection destination server (/E4)	2-62	SUsbAutoLOut	USB auto logout [GM]	2-74
SSLMPCCmd	SLMP client transmission command (/E4)	2-62	Schedule Management Setting Commands		Page
Security Setting Commands			Page		
SSecurity	Security function	2-63	SSchedule	Schedule management	2-74
SKdc	Password management (/AS)	2-63	SScheduleText	Schedule management text	2-74
SOpPePass	Password to unlock operation [GX/GP]	2-64	Dual Interval Function Setting Commands		
SOpLimit	Operation lock details [GX/GP]	2-64	SDualGroup	Scan group number of the display group	2-75
SUser	User settings	2-65	SMasterScanGrp	Scan group (master scan interval)	2-75
SUserLimit	Authority of user	2-66	Control Setup Parameter Setting Commands		
SSignIn	Sign In (/AS)	2-66	SCtrlMode	Control mode	2-75
SSignInTitle	Sign in title (/AS)	2-66	SCtrlScan	Control period	2-75
SSignInLimit	Sign in property (/AS)	2-66	SCtrlAction	Control	2-75
SBTPassword	Bluetooth password (/C8) [GM]	2-67	SCtrlType	Control type	2-75
SWebCustomMenu	Web monitor screen	2-67	SCtrlLoopAction	Loop control	2-76
SSessionSecurity	Web session security function (/AS) [GM]	2-67	SCtrlSPPID	Number of SP groups, number of PID groups	2-76
SWebTimeout	Web auto logout (/AS) [GM]	2-67	SCtrlALNo	Number of alarms	2-76
Local Setting Commands			Page		
			SCtrlAlmMode	Alarm mode	2-76
			SCtrlDIRegist	Contact registration	2-77
			SCtrlRelay	Relay action	2-79
			SCtrlRangeAI	Measurement input range	2-80
			SCtrlBurnOut	Burnout mode	2-81
			SCtrlRjc	RJC temperature	2-81
			SCtrlFilter	First-order lag filter of the AI terminal of the PID control module	2-82
			SCtrlCalibAI	Calibration correction of the AI terminal of the PID control module	2-82

2.2 List of Commands

SCTrlRangeAO	Range of the AO terminal of the PID control module	2-83
SCTrlSpritAO	Split computation of the AO terminal of the PID control module	2-84
SCTrlOutput	Output process	2-84
SCTrlRangePV	Control PV input range	2-84
SCTrlPVSwitch	Input switching PV value for PV switching	2-84
SCTrlCalc	Reference source of EXPV and RSP	2-85
SCTrlFilterSP	Remote SP filter	2-85
SCTrlRatioSP	Remote SP ratio	2-85
SCTrlBiasSP	Remote SP bias	2-85
SCTrlErrPreOut	Preset output value for input errors	2-85
SCTrlOutLimit	Releasing of the output limiter function in manual mode	2-86
Control Operation Parameter Setting Commands		
SCTrlAlarm	Control alarm	2-86
SCTrlAlarmVal	Control alarm value	2-86
SCTrlSP	Target setpoint	2-87
SCTrlSPGradient	Target setpoint ramp-rate	2-87
SCTrlPIDNo	Target setpoint PID group number	2-87
SCTrlRefPoint	Zone PID setting 1 reference point	2-87
SCTrlRHys	Zone PID setting 2 switching hysteresis	2-87
SCTrlRefDEV	Zone PID setting 3 reference deviation	2-88
SCTrlPIDPb	PID parameter setting 1 Proportional band	2-88
SCTrlPIDTI	PID parameter setting 2 Integration time	2-88
SCTrlPIDTD	PID parameter setting 3 Derivative time	2-88
SCTrlPIDPara	PID parameter setting 4 Control parameters	2-88
SCTrlRefPb	Reference PID setting 1 Proportional band	2-89
SCTrlRefTI	Reference PID setting 2 Integration time	2-89
SCTrlRefTD	Reference PID setting 3 Derivative time	2-89
SCTrlRefPara	Reference PID setting 4 Control parameters	2-89
SCTrlDetail	Control detail setting 1 Tracking, setpoint limit, ramp-rate time unit	2-90
SCTrlOutRatio	Control detail setting 2 Output velocity limiter	2-90
SCTrlAtDetail	Control detail setting 3 Auto-tuning details	2-90
SCTrlAntiReset	Control detail setting 4 Over-integration suppressing function	2-90
SCTrlOvershoot	Control detail setting 5 Control output suppressing function (overshoot-suppressing function)	2-91
Control Display Setting Commands		
SCTrlGroupSW	Control group use On/Off	2-91
SCTrlGroupName	Control group name	2-91
SCTrlGroupSplit	Control group divisions [GX/GP]	2-91
SCTrlGroup	Loop to assign to control group	2-91

SCTrlTag	Loop tag, tag comment	2-92
SCTrlDispDV	Deviation display band	2-92
SCTrlBackColor	Background color [GX/GP]	2-92
SCTrlOutOperate	OUT value manual output operation type	2-92
SCTrlTagIO	PID control module channel display (tag, tag No.)	2-29
SCTrlColorIO	PID control module channel display (color)	2-29
SCTrlZoneIO	PID control module channel display (zone high limit, zone low limit)	2-30
SCTrlScaleIO	PID control module channel display (scale display position, number of scale divisions)	2-30
SCTrlBarIO	PID control module channel display (bar display position, number of bar divisions)	2-30
SCTrlPartialIO	PID control module channel display (partial)	2-31
SCTrlValueIO	PID control module channel display (upper and lower limit string)	2-31

Program Control Setting Commands

SCTrlPrgColor	Loop color	2-93
SCTrlPrgDispDetail	Auto message printing, screen switching	2-93

Control Event Action Setting Commands

SCTrlEventAct	Control event action	2-93
---------------	----------------------	----------------------

Logic Math Setting Commands

SCTrlLogicMath	Logic math expression	2-95
SCTrlSWConst	Variable constant	2-95

2.2.2 Output Commands

Command	Description (Required Options) [Applicable Models]	Page
FData	Outputs the most recent channel data	2-95
FRelay	Outputs the most recent relay and internal switch status	2-95
FTransStatAO	Outputs the most recent re-transmission (AO channel) status	2-96
FFifoCur	Outputs channel FIFO data	2-96
FSnap	Takes a snapshot [GX/GP]	2-96
FUser	Outputs the user level	2-96
FAddr	Outputs the IP address	2-96
FStat	Outputs the GX/GP status	2-97
FLog	Outputs the log	2-97
FEventLog	Outputs a detail event log (/AS)	2-97
FMedia	Outputs external storage medium and internal memory information	2-97
FCnf	Outputs setting data	2-98
FChInfo	Outputs decimal place and unit information	2-99
FSysConf	Queries the system configuration and reconfigures modules	2-99
FBTDevInfo	Bluetooth device information output (/C8) [GM]	2-100
FReminder	Outputs reminder information (/AH)	2-100
FCtrlData	Control data output	2-100

FCtrlNo	SP number and PID number output	2-100	OBTClearList	Clears the Bluetooth connection list (/C8) [GM]	2-108
FCtrlMode	Control mode output	2-100	OLoginAssist	Assists login [GX/GP]	2-108
FPrgMode	Program operation mode output (/PG)	2-100	OSendValue	Assists touch panel operation Input [GX/GP]	2-108
FPrgPtnInfo	Program pattern information output (/PG)	2-101	OUserLockACK	User locked ACK (/AS)	2-108
FPrgEvent	PV event and time event information output (/PG)	2-101	OKeyLock	Key lock on/off [GM]	2-108
FPrgEnd	Program control end signal status output (/PG)	2-101	OErrorClear	Clears the error display [GM]	2-109
FPrgPtnCur	Running program pattern number and status output (/PG)	2-101	OSLMPRestore	Manually restores SLMP (/E4)	2-109
			OtransChAO	Individual re-transmission output (AO channel) control	2-109
			OtransAllAO	Collective re-transmission output (AO channel) control	2-109
			OCmdAO	Manual output setting	2-109
			OinitPara	Individual setting parameter initialization	2-109
			OCtrlAM	Auto/manual/cascade operation switching	2-110
			OCtrlSR	Operation start/stop switching	2-110
			OCtrlRL	Remote/local switching	2-110
			OCtrlAT	Auto-tuning request	2-110
			OCtrlSPN	Selects the target setpoint number	2-110
			OCtrlMO	Sets the manual output setpoint	2-111
			OCtrlPAT	Pattern number switching	2-111
			OCtrlMode	Program operation start or stop	2-111
			OCtrlHOLD	Hold operation	2-111
			OCtrlADV	Advance operation	2-111
			OCtrlSP	Sets the target setpoint	2-111
			OCtrlTSP	Sets the final target setpoint	2-112
			OCtrlRTIME	Sets the segment remaining time	2-112
			OCtrlStSeg	Sets the start segment number	2-112
			OCtrlDlyTime	Sets the starting time of program operation	2-112
			OCtrlLoadPAT	Loads a program pattern file	2-113
			OCtrlSavePAT	Saves a program pattern file	2-113
			OCtrlLoadPATAll	Collectively Loads program pattern files	2-113
			OCtrlSavePATAll	Collectively saves program pattern files	2-113
			OCtrlDelPAT	Deletes a pattern file	2-113

2.2.3 Operation Commands

Command	Description (Required Options) [Applicable Models]	Page
OSetTime	Sets the time	2-102
ORec	Starts or stops recording	2-102
OAlarmAck	Clears alarm output (alarm acknowledgement)	2-102
OExecRec	Generates a manual trigger, executes manual sample, takes a snapshot, or causes a timeout	2-102
OExecSNTP	Queries the time using SNTP	2-103
OMessage	Writes a message	2-103
OPassword	Changes the password	2-103
OMath	Starts, stops, or resets computation or clears the computation dropout status display	2-103
OSaveConf	Saves setting data	2-104
OSaveConfAll	Saves setting data at once	2-104
OCommCh	Sets a communication channel to a value	2-104
OEMail	Starts or stops the e-mail transmission function	2-105
OMBRestore	Recovers Modbus manually	2-105
ORTReset	Resets a relative timer	2-105
OMTReset	Resets the match time timer	2-105
OCmdRelay	Outputs the DO channel and internal switch status	2-105
OBatName	Sets a batch name	2-105
OBatComment	Sets a batch comment	2-106
OBatText	Sets a batch text	2-106
ODispRate	Switches the trend interval [GX/GP]	2-106
OLoadConf	Loads setting data	2-106
OLoadConfAll	Loads setting data at once	2-107
OSeriApply	Applies serial communication settings	2-107
OIPApply	Applies the IP address	2-107
OInit	Clears measured data and initializes setting data	2-107
OUsbFApply	Applies USB communication settings [GM]	2-108
OBTApply	Applies Bluetooth communication settings (/C8) [GM]	2-108

2.2.4 Communication Control Commands

Command	Description (Required Options) [Applicable Models]	Page
CCheckSum	Sets the checksum	2-114
CSFilter	Sets the status filter	2-114
CSFilterDB	Sets the status filter (expanded)	2-114
CLogin	Log in via communication	2-115
CLogout	Log out via communication	2-115
CBTConnect	Starts Bluetooth communication (/C8) [GM]	2-115
ESC O	Opens an instrument : RS-422/485 command	2-115
ESC C	Closes an instrument : RS-422/485 command	2-115

2.2.5 Instrument Information Commands

Command	Description	Page
_MFG	Outputs the instrument manufacturer	2-116
_INF	Outputs the instrument's product name	2-116
_COD	Outputs the instrument's basic specifications	2-116
_VER	Outputs the instrument's firmware version information	2-116
_OPT	Outputs the instrument's option installation information	2-116
_TYP	Outputs the instrument's temperature unit, and daylight saving time installation information	2-116
_ERR	Outputs the instrument's error number information	2-116
_UNS	Outputs the instrument's unit configuration information	2-116
_UNR	Outputs the instrument's unit configuration information	2-116
_MDS	Outputs the instrument's module configuration information	2-116
_MDR	Outputs the instrument's module configuration information	2-116

2.2.6 Conditions for Executing Commands

A command can be executed only when the recorder can execute the setting change or operation that the command specifies. Commands are invalid in the following circumstances.

- The recorder is not in a condition to accept the operation.
For example, if the recorder is not recording, you cannot write a message.
- If the recorder does not have the function or is not using the function.
The "Description" column in section 2.2.1, "Setting Commands" contains the recorder suffix codes that are required for using the commands.
- If the login function is in use, the command cannot be used at the user level that the user is logged in at.
- User restriction is placed on the operation.
The following table lists the commands that are invalid according to the limitation types (p1 of the SOpelimit command or p2 of the SUserLimit command).

Limitation Type	Invalid Command
Memory	ORec
Math	OMath
DataSave	OExecRec, OMTReset
Message	OMessage
Batch	OBatName, OBatComment, OBatText
AlarmACK	OAlarmAck
Comm	OEMail, OIPApply, OMBRestore, OSLMPRestore

DispOpe	SHomeKind, SHomeMonitor, SFavoriteKind, SFavoriteMonitor, Smonitor, SMultiPattern, SMultiKind, ODispRate
DateSet	OExecSNTP, OSetTime
ChangeSet	Sxxxx ^{*1} , OLoadConf, OLoadConfAll, Olnit ^{*3} , OCtrlLoadPAT, OCtrlLoadPATAll
File	OLoadConf, OLoadConfAll, OSaveConf, OSaveConfAll, OCtrlLoadPAT, OCtrlSavePAT, OCtrlLoadPATAll, OCtrlSavePATAll, Fmedia
System	OInit, FSysConf (when p1 is specified)
Out	OCmdRelay, OCommCh
CalibSet ^{*2}	SCalibIO, SSchedule, SScheduleText, OLoadConfAll, OLoadConf ^{*4} , OInit ^{*5} , SCalibUseCom, SCalibCom
ControlIN	OCtrlRL
ControlOUT	OCtrlSR, OCtrlAM, OCtrlMO
Tuning	OCtrlAT
Program	OCtrlMODE, OCtrlHOLD, OCtrlADV

- *1 Setting commands except for SHomeKind, SHomeMonitor, SFavoriteKind, SFavoriteMonitor, Smonitor, SMultiPattern, SMultiKind, and SCalibIO^(Note), SCalibUseCom, SCalibCom (Note) Only when the advanced security function (/AS option) is in use on instruments whose version is 2.02 or later.
- *2 Can be specified with the SUserLimit command when the advanced security function (/AS option) is in use on instruments whose version is 2.02 or later.
- *3 Cannot be executed if initialization items include SECURITY or OTHERS items.
- *4 Cannot be executed if load items include CALIB items.
- *5 Cannot be executed if initialization items include CALIB items.

- Restriction is placed on the operation with an admin property.
The following table lists the commands that are invalid according to the limitation types (p2 of the SAdminLimit command).

Limitation Type	Invalid Command
SecurityBasic	SChgComm, SKdc, SOpeLimit, SOpePass, SPasswdNotice, SPasswdPolicy, SSecurity, SSessionSecurity, SWebTimeOut, OUserLockACK
User	SUserUser SUser
AdminLimit	SAdminLimit
UserLimit	SUserLimit, SWebCustomMenu
SigninLimit	SSignInLimit
Signin	SSignIn, SSignInTitle
Initialize	OInit, OinitPara
Reconf	FSysConf, FWUnitConf

- The command is not applicable to the model.
For commands that can be used only on certain models, the models are listed in the "Description" column in section 2.2.1, "Setting Commands," to section 2.2.4, "Communication Control Commands." (Examples: [GX/GP], [GM])
The applicable models for the following commands are further reduced.

Command	Applicable Models
SViewAngle	GX10, GP10
SMultiPattern	GX20, GP20
SMultiKind	GX20, GP20

2.2.7 How to Use Commands

When Using Ethernet

- When not using the login function
When you connect a PC to the recorder, the recorder will be ready to receive commands.
- When using the login function
Establish communication with the recorder, and log in using a registered user account (CLogin command). After you finish the operation, log out (CLogout command).

When Using RS-232 (GX/GP)

- When you wire and connect a PC to the GX/GP, the GX/GP will be ready to receive commands.
- When using the login function, log in using a registered user account (CLogin command). After you finish the operation, log out (CLogout command).

When Using RS-422/485

- The device that is opened with an open command (ESC o) will be ready to receive commands.
- When using the login function, log in using a registered user account (CLogin command). After you finish the operation, log out (CLogout command).
- To close the connection, send the close command (ESC c).

When Using USB Communication (GM)

- When not using the login function
When you connect a PC to the GM, the GM will be ready to receive commands.
- When using the login function
Log in using a registered user account (CLogin command) to establish a connection. After you finish the operation, log out (CLogout command). You can also use the auto logout function (SUsbAutoLOut command).
- To remove a GM, perform a device removal procedure on the PC to disconnect, and then remove the cable.

When Using Bluetooth (GM, /C8 option)

- When not using the login function
When the Bluetooth password function is enabled, use a command to start communication (CBTConnect) to send the password. When a connection is established, the GM will be ready to receive commands.
- When using the login function
In addition to the procedure above, log in using a registered user account (CLogin command). After you finish the operation, log out (CLogout command). You can also use the auto logout function (SBTTimeOut command).
- To disconnect, perform a device removal procedure on the PC.

Note

- For the login operation, see appendix 2, "Login Procedure."
- For details on Bluetooth connection, see appendix 7, "Bluetooth Communication Connection Flow Chart."

2.2.8 Device Nomenclature in Command Descriptions

The following nomenclature is used in the command descriptions in section 2.4 to distinguish the devices.

Nomenclature	Device
Recorder	Both GX/GP and GM
Main unit	Both GX/GP and GM main units
GX/GP main unit	GX/GP main unit
GM main unit	GM main unit
GX20-1/GP20-1	GX20/GP20 standard type
GX20-2/GP20-2	GX20/GP20 large memory type
GM10-1	GM10 standard type
GM10-2	GM10 large memory type
Expandable I/O	GX/GP Expandable I/O
Sub unit	GM sub unit

2.3 Parameters

This section describes parameters.

2.3.1 Measuring Range Parameters

AI Channel Span

Specify the span using an integer.

Example If the range is -2.0000 V to 2.0000 V and you want to set the span lower limit to 0.5000 V and the span upper limit to 1.8000 V, set the parameters to 5000 and 18000, respectively.

SRangeAI, 0001, VOLT, 2V, FF, 5000, 18000, 0

Scaling

Scaling is possible on AI and DI channels. Scaling is specified by a mantissa and decimal place.

Example To set the scaling to -10.00 to 20.00, set the scaling lower limit to -1000, scaling upper limit to 2000, and the decimal place to 2. The decimal place value represents the number of digits to the right of the decimal point.

Math Channel and Communication Channel Span

Set the span of math channels and communication channels using a mantissa and decimal place.

Example To set the span to 1.000 to 2.000, set the scaling lower limit to 1000, scaling upper limit to 2000, and the decimal place to 3.

2.3.2 Parameter Notation and Range

The table below shows the principle parameter notations and ranges of values.

Type	Notation and Range of Values	
[GX/GP]	No expandable I/O	0
Unit number	Expandable I/O installed	0 to 6
[GX/GP]	When the unit is GX10/GP10	0 to 2
Module number	When the unit is GX20/GP20	0 to 9
	When the unit is an expandable I/O	0 to 6
[GM]	No sub unit	0
Unit number	Sub unit installed	0 to 6
[GM]	Main unit	0 to 9
Module number	Sub unit	0 to 6
AI channel	Specify as "unit number+module number+channel."	
DI channel		
DO channel	Example The AI channel whose unit number is 0, module number is 1, and channel number is 02 is 0102.	
PI channel		

Type	Notation and Range of Values	
PID channel	Specify as "unit number+slot number+channel." Example The PID channel whose unit number is 0, slot number is 1, and channel number is 02 is 0102. Note that the PID channel number changes depending on the channel type. The following table shows the association.	
	Channel type	Channel number (4 digits) ** is unit number+slot number
	PV	**01, **04
	SP	**02, **05
	OUT	**03, **06
	AI	**07, **08
	AO	**09, **10
	DI	**11 to **18
	DO	**19 to **26
Math channel	GX20-2/GP20-2: 001 to 200 GX10/GP10: 001 to 050 GM10: 001 to 100 For SGroup and SMailAlarm commands, insert "A" in front. Example A001 If the measurement mode is dual interval, the number of channels is halved.	
Communication channel	GX10/GP10:001 to 050 GX20-1/GP20-1: 001 to 300 GX20-2/GP20-2: 001 to 500 GM10-1: 001 to 300 GM10-2: 001 to 500 For SGroup and SMailAlarm commands, insert "C" in front. Example C001 If the measurement mode is dual interval, the number of channels is halved.	
Number of channels for recording display data	GX10/GP10: 001 to 100 GX20-1/GP20-1: 001 to 500 GX20-2/GP20-2: 001 to 1000 GM10-1: 1 to 500 GM10-2: 1 to 1000	
Number of channels for recording event data	GX10/GP10: 001 to 100 GX20-1/GP20-1: 001 to 500 GX20-2/GP20-2: 001 to 1000 GM10-1: 1 to 500 GM10-2: 1 to 1000	
Number of channels for recording manual sampled data	GX10/GP10/GX20-1/GP20-1: 1 to 50 GX20-2/GP20-2: 1 to 100 GM10-1: 1 to 50 GM10-2: 1 to 100	
Number of report channels	GX10/GP10: 1 to 50 GX20/GP20: 1 to 60 GM10: 1 to 60	
Number of display groups	GX10/GP10: 1 to 30 GX20-1/GP20-1: 1 to 50 GX20-2/GP20-2: 1 to 60 GM10-1: 1 to 50 GM10-2: 1 to 60	

Type	Notation and Range of Values
Number of channels that can be registered to display groups	GX10/GP10: 10 GX20/GP20: 20
Modbus server setting number	GM10: 20
Modbus command number (Ethernet)	GX10/GP10/GX20-1/GP20-1: 1 to 16 GX20-2/GP20-2: 1 to 32 GM10-1: 1 to 16 GM10-2: 1 to 32
Modbus command number (serial communication)	GX10/GP10: 1 to 50 GX20-1/GP20-1: 1 to 100 GX20-2/GP20-2: 1 to 200 GM10-1: 1 to 100 GM10-2: 1 to 200
Server setting number for WT communication	GX10/GP10: 1 to 50 GX20-1/GP20-1: 1 to 100 GX20-2/GP20-2: 1 to 200 GM10-1: 1 to 100 GM10-2: 1 to 200
Communication channel allocation number for WT communication	GX10/GP10: 1 to 8 GX20/GP20: 1 to 16 GM10: 1 to 16
Number of users that can be registered (user number)	Advanced security function (/AS) not installed or disabled: 1 to 50 Advanced security function (/AS) enabled: GX10/GP10: 1 to 100 GX20-1/GP20-1: 1 to 100 GX20-2/GP20-2: 1 to 200 GM10-1: 1 to 100 GM10-2: 1 to 200
Number of batch groups in use for the multi batch function (/BT)	GX10/GP10: 2 to 6 GX20-1/GP20-1: 2 to 6 GX20-2/GP20-2: 2 to 12 GM10-1: 2 to 6 GM10-2: 2 to 12
Batch group number when the multi batch function is enabled	1 to (number of batch groups in use)
Number of display groups when the multi batch function (/BT) is enabled	GX10/GP10: 1 to 6 GX20-1/GP20-1: 1 to 6 GX20-2/GP20-2: 1 to 12 GM10-1: 1 to 6 GM10-2: 1 to 12
Schedule registration number	GX10/GP10: 1 to 6 GX20-1/GX20-1: 1 to 6 GX20-2/GP20-2: 1 to 12 GM10-1: 1 to 6 GM10-2: 1 to 12
Number of control groups	GX10-1/GX20-1/GM10-1: 1 to 5 GX20-2/GM10-2: 1 to 10

Type	Notation and Range of Values
Loop number	L001 to L652 To specify the loop number, add an "L" in front, and specify as "unit number+module number+loop number." The loop number is 1 or 2. Example The loop whose unit number is 0, module number is 0, and loop number is 1 is L001.
PID module terminal number	The terminal numbers in a PID module consists of AI, AO, DI, and DO. AI: 1 or 2, AO: 1 or 2, DI: 1 to 8, DO: 1 to 8
Logic math number	GX10: 1 to 20 GX20-1/GX20-2, GM10-1/GM10-2: 1 to 50

2.3.3 Specifying a Range

When specifying consecutive channel numbers or group numbers in a setting command, you can specify them using a range instead of specifying each number one by one.

- Use a hyphen to separate the first number and the last number. For I/O channels, you can specify a range that spans over multiple slots that modules are installed in.
- You can specify the minimum number by omitting the number before the hyphen and the maximum number by omitting the number after the hyphen. If you want to specify all numbers from the first number to the last number, specify only the hyphen.

Example 1

To specify 3 to 10: "3-10"

To specify 3 to the maximum number: "3-"

To specify the first number to 10: "-10"

To specify all numbers: "-"

Example 2

A command that sets the channel ranges of AI modules installed in slots 0 to 2 to Skip.

```
SRangeAI,0001-0210,Skip or
```

```
SRangeAI,-0210,Skip
```

If a different module is installed in slot 1, queries will work, but setting commands will result in error.

2.4 Setting Commands

SScan

Scan Interval

Sets the scan interval.

Syntax `SScan,p1,p2`
p1 Scan group (1 or 2)
 When the measurement mode is Normal or High speed, this is fixed to 1. When the measurement mode is Dual interval, you can select 1 or 2.
p2 Scan interval (see "Description")

Query `SScan[,p1]?`

Example Set the scan interval of scan group 1 to 1 second.

`SScan,1,1s`

Description

- You cannot use this command to configure settings while recording is in progress.
- You cannot use this command to configure settings while computation is in progress.
- The scan interval (p2) can be set in the following range.

Measurement mode	Options (p2)
Normal	100ms, 200ms, 500ms, 1s, 2s, 5s (Notes *1, *2, *3)
High speed	1ms, 2ms, 5ms, 10ms 20ms, 50ms, 100ms, 200ms, 500ms, 1s, 2s, 5s
Dual interval	1ms, 2ms, 5ms, 10ms (Notes *4, *5, *6, *7) 20ms, 50ms, 100ms, 200ms, 500ms, 1s, 2s, 5s

- *1 If an electro-magnetic relay type analog input module is installed, scan interval less than or equal to 500 ms cannot be specified.
- *2 If a low withstand voltage relay type analog input module is installed, scan interval less than or equal to 200 ms cannot be specified.
- *3 When the multi-batch function (/BT) is enabled, you cannot set the scan interval to 200 ms or less.
- *4 If high-speed AI type analog input module is installed, scan interval less than or equal to 50 ms cannot be specified.
- *5 If an electro-magnetic relay type analog input module is assigned to a scan group, scan interval less than or equal to 500 ms cannot be specified.
- *6 If a low withstand voltage relay type analog input module is assigned to a scan group, scan interval less than or equal to 200 ms cannot be specified.
- *7 For dual interval measurement, scan interval cannot be set less than 50 ms on scan group 2.

- The following three conditions must be met for an option to be a valid scan interval.

- When specifying a scan interval of 50 ms or less, the modules installed in the main unit must be assigned to scan groups.

- When specifying a scan interval of 50 ms or less, the number of channels must be within the limits. (For the limits to the number of channels for each scan interval, see the main unit's User's Manual (IM 04L51B01-01EN, or IM 04L55B01-01EN).)
- The shortest scan interval of the modules assigned to a scan group is shorter than the scan interval of the scan group.
The following table shows the shortest scan interval of each module.

Module type (type, suffix code)	Shortest scan interval (when installed in the main unit)	Shortest scan interval (when installed in an expandable I/O)
Analog input module		
(high-speed AI, -H0)	1ms	100ms
(Universal, -U2)	100ms	100ms
(Electromagnetic relay, -T1)	1s	1s
(Low withstand voltage relay, 500ms -L1)	500ms	500ms
(Current input, -C1)	100ms	100ms
(4-wire RTD, -R1)	100ms	100ms
(High withstand voltage, -V1)	100ms	100ms
Digital input module	100ms	100ms
Digital output module	100ms	100ms
Analog output module	100ms	100ms
Digital input/output module	100ms	100ms
Pulse input module	100ms	100ms
Expansion module	100ms	100ms
PID control module	100ms	100ms

SScanGroup

Scan Group

Sets the scan group of the module.

Syntax `SScanGroup,p1,p2,p3`
p1 Unit number
p2 Module number
p3 Scan group (1)
 1 Scan group 1

Query `SScanGroup[,p1[,p2]]?`

Example Set the module installed in the main unit, whose module number is 2 in scan group 1.
`SScanGroup,0,2,1`

Description

- You cannot use this command to configure settings while recording is in progress.
- You cannot use this command to configure settings while computation is in progress.
- The scan group (p3) can be set in the following range.

Measurement mode	Options (p3)
Normal, High speed	Fixed to 1
Dual interval	1 or 2

- The following three conditions must be met for an option to be a valid scan group.

- For a module installed in the main unit, assign the module to a scan group with a scan interval of 50 ms or less.

- 2 If the scan interval is 50 ms or less, the number of installed modules and the number of channels must be within their limits.
- 3 The shortest scan interval of the module must be shorter than the scan interval of the scan group.

SModeAI

AI Module

Sets the mode and A/D integration time or noise rejection mode of an AI module (excluding current input type AI modules).

Syntax `SModeAI, p1, p2, p3, p4`
 p1 Unit number
 p2 Module number
 p3 Mode (see "Description.")
 p4 A/D integration time or noise rejection mode
 A/D integration time: Auto, 50Hz, 60Hz, Common
 Noise rejection mode (high-speed AI type): Off, 50Hz, 60Hz, Common

Query `SModeAI[, p1[, p2]]?`

Example For the module installed in the main unit, whose module number is 2, set the mode to 10CH and the AD integration time to Auto.
`SModeAI, 0, 2, 10CH, Auto`

Description

- You cannot use this command to configure settings while recording is in progress.
- You cannot use this command to configure settings while computation is in progress.
- Scan intervals shorter than 1 s cannot be specified if an electro-magnetic relay type (Type suffix code: -T1) analog input module is in use (set up).
- Channel mode (p3) options vary depending on the module.

Module type	Mode (p3)
Universal type (-U2)	2CH, 10CH
Current input type (-C1) High withstand voltage (-V1)	
Electromagnetic relay type (-T1) Low withstand voltage relay type (-L1)	10CH
4-wire RTD type (-R1)	2CH, 6CH
High-speed AI type (-H0)	4CH

- Scan interval, p3, and p4 can be set in the following combinations.

Universal, current input, electromagnetic relay, low withstand voltage relay or high withstand voltage type

Scan interval	Mode (p3)	Integration time (p4)			
		Auto	50Hz	60Hz	Common
100ms	2CH	Yes	Yes	Yes	No
	10CH	Yes	No	No	No
200ms	2CH	Yes	Yes	Yes	No
	10CH	Yes	No	No	No
500ms	—	Yes	Yes	Yes	No
1s	—	Yes	Yes	Yes	Yes*
2s	—	Yes	Yes	Yes	Yes
5s	—	Yes	Yes	Yes	Yes

* "No" for low withstand voltage relay type analog input modules.

4-wire RTD type

Scan interval	Mode (p3)	Integration time (p4)			
		Auto	50Hz	60Hz	Common
100ms	2CH	Yes	Yes	Yes	No
	6CH	Yes	No	No	No
200ms	2CH	Yes	Yes	Yes	No
	6CH	Yes	No	No	No
500ms	—	Yes	Yes	Yes	No
1s	—	Yes	Yes	Yes	Yes
2s	—	Yes	Yes	Yes	Yes
5s	—	Yes	Yes	Yes	Yes

High-speed AI type (noise rejection mode)

Scan interval	Noise rejection mode (p4)			
	Auto	50Hz	60Hz	Common
1ms, 2ms, 5ms, 10ms	Yes	No	No	No
20ms	Yes	Yes	Yes	No
50ms	Yes	Yes	Yes	No
100ms	No	No	No	Yes
200ms	No	No	No	Yes
500ms	No	No	No	Yes
1s	No	No	No	Yes
2s	No	No	No	Yes
5s	No	No	No	Yes

SModeAICurrent

Current Input Type AI Module

Sets the mode and A/D integration time of an current input type AI module.

Syntax `SModeAICurrent, p1, p2, p3, p4`

p1 Unit number
 p2 Module number
 p3 Mode
 2CH 2 channel mode
 10CH 10 channel mode
 p4 AD integration time (Auto, 50Hz, 60Hz, Common)

Query `SModeAICurrent[, p1[, p2]]?`

Example For the module installed in the main unit, whose module number is 2, set the mode to 10CH and the AD integration time to Auto.
`SModeAICurrent, 0, 2, 10CH, Auto`

Description

- You cannot use this command to configure settings while recording is in progress.
- You cannot use this command to configure settings while computation is in progress.
- There are limitations on the allowable combinations of scan interval and p3 and p4. See the explanation for the SModeAI command.

SBOLmtAI

Upper and Lower Burnout Limits of AI Module

Sets the burnout limits for the general signal range of an AI module (excluding current input type AI modules).

Syntax SBOLmtAI, p1, p2, p3, p4
p1 Unit number
p2 Module number
p3 Lower burnout limit for the general signal range. Percentage of the specified span -20.0 to -5.0% (-200 to -50)
p4 Upper burnout limit for the general signal range. Percentage of the specified span 105.0 to 120.0% (1050 to 1200)

Query SBOLmtAI[, p1[, p2]]?

Example For the module installed in the main unit, whose module number is 2, set the lower burnout limit for the general signal range to -10% and the upper burnout limit for the general signal range to 110%.
SBOLmtAI, 0, 2, -100, 1100

Description

- This command is invalid for 4-wire RTD modules.
- You cannot use this command to configure settings while recording is in progress.
- You cannot use this command to configure settings while computation is in progress.

SBOLmtAICurrent

Upper and Lower Burnout Limits of Current Input Type AI Module

Sets the burnout limits for the general signal range of a current input type AI module.

Syntax SBOLmtAICurrent, p1, p2, p3, p4
p1 Unit number
p2 Module number
p3 Lower burnout limit for the general signal range. Percentage of the specified span -20.0 to -5.0% (-200 to -50)
p4 Upper burnout limit for the general signal range. Percentage of the specified span 105.0 to 120.0% (1050 to 1200)

Query SBOLmtAICurrent[, p1[, p2]]?

Example For the module installed in the main unit, whose module number is 2, set the lower burnout limit for the general signal range to -10% and the upper burnout limit for the general signal range to 110%.
SBOLmtAICurrent, 0, 2, -100, 1100

Description

- You cannot use this command to configure settings while recording is in progress.
- You cannot use this command to configure settings while computation is in progress.

SModeDI

DI Module

Sets the mode of a DI module.

Syntax

/MT SModeDI, p1, p2, p3
No /MT SModeDI, p1, p2, p3, p4
p1 Unit number
p2 Module number
p3 Mode (Normal, Remote)
Normal DI input
Remote Remote control input
p4 Filter for pulse input (On, Off)

Query SModeDI[, p1[, p2]]?

Example Set the module whose module number is 2 as a remote control input module.
SModeDI, 0, 2, Remote

Description

- You cannot use this command to configure settings while recording is in progress.
- You cannot use this command to configure settings while computation is in progress.
- Only one module can be set to remote. If different modules are set to remote numerous times, the last module will be the remote module.
- For modules installed in an expandable I/O or sub unit, p3 is fixed to Normal.
- Pulse input is valid on products with the math function (/MT option).
- When the measurement mode is set to high speed, p3 is fixed to Remote.

SModePID

PID Control Module

Sets the integration time and burnout criteria of the PID control module.

Syntax SModePID, p1, p2, p3, p4, p5
p1 Unit number
p2 Module number
p3 Noise rejection mode (fixed to Common)
p4 Lower limit of burnout set for the general signal range. Percentage of the specified span (-200 to -50)
p5 Upper limit of burnout set for the general signal range. Percentage of the specified span (1050 to 1200)

Query SModePID[, p1[, p2]]?

Example For the module with a module number of 2, set the lower limit of burnout set for the general signal range to -20% and the upper limit of burnout set for the general signal range to 105%.
SModePID, 0, 2, common, -200, 1050

Description

- You cannot use this command to configure settings while recording is in progress.
- You cannot use this command to configure settings while computation is in progress.

SScaleOver

Detection of Values That Exceed the Scale

Sets how to detect measurement over-range.

Syntax `SScaleOver, p1`
 /P1 How to detect values that exceed the scale
 FREE Assume scale over-range when the measurement range is exceeded.
 OVER Assume scale over-range when $\pm 105\%$ of the scale is exceeded.

Query `SScaleOver?`

Example Assume scale over-range when the measurement range is exceeded.
`SScaleOver, FREE`

Description

- You cannot use this command to configure settings while recording is in progress.
- You cannot use this command to configure settings while computation is in progress.
- The setting specified with this command is valid if at least one module is installed.

SMemory

Recording Mode

Sets the type of data to record.

Syntax `SMemory, p1`
 p1 Recording mode
 D Display data
 D+E1 Display data and event data
 E1 Event data
 E1+E2 Event data 1+2

Query `SMemory?`

Example Record display data.
`SMemory, D`

Description

- You cannot use this command to configure settings while recording is in progress.
- You cannot use this command to configure settings while computation is in progress.
- When the advanced security function (/AS) is enabled, D+E1 and E1+E2 cannot be specified.
- When the multi batch function (/BT) is enabled, D+E1 and E1+E2 cannot be specified.
- When the measurement mode is set to high speed, p1 is fixed to E1.
- When the measurement mode is set to dual interval, p1 is fixed to E1+E2.

SMemKeyConfirm

Record Confirmation Action [GX/GP]

Sets the record confirmation action.

Syntax `SMemKeyConfirm, p1`
 p1 Enable or disable confirmation screen (Off, On)

Query `SMemKeyConfirm?`

Example Show the confirmation screen.
`SMemKeyConfirm, On`

Description

- When the multi batch function (/BT) is enabled, this is fixed to On.

SDispData

Display Data Recording

Sets the display data recording mode.

Syntax `SDispData, p1, p2`
 p1 Recording interval (5s, 10s, 15s, 30s, 1min, 2min, 5min, 10min, 15min, 20min, 30min, 1h, 2h, 4h, 10h)/div.
 p2 File save interval (10min, 20min, 30min, 1h, 2h, 3h, 4h, 6h, 8h, 12h, 1day, 2day, 3day, 5day, 7day, 14day, 31day)

Query `SDispData?`

Example Set the recording interval to 1 minute and file save interval to 12 hours.
`SDispData, 1min, 12h`

Description

- You cannot use this command to configure settings while recording is in progress.
- You cannot use this command to configure settings while computation is in progress.
- You cannot choose a recording interval that is shorter than the scan interval.
- You cannot choose a recording interval that is not an integer multiple of the scan interval.
- File save interval is valid when display data recording is enabled (recording mode of the [SMemory](#) command).
- This command is invalid when the measurement mode is set to high speed or dual interval.

SEventData

Event Data Recording

Sets the event data recording mode.

Syntax `SEventData, p1, p2, p3, p4, p5, p6`
 p1 Scan group (1 or 2)
 p2 Recording interval (see "Description.")
 p3 Operation mode
 Free Starts recording at recording start and stops recording at recording stop.
 SingleTrigger After a trigger event occurs, the recorder will record for the specified time and stop.
 RepeatTrigger After a trigger event occurs, the recorder will record for the specified time and stop. Then, the recorder will enter the trigger-wait state.
 p4 Data length (2min, 5min, 10min, 20min, 30min, 1h, 2h, 3h, 4h, 6h, 8h, 12h, 1day, 2day, 3day, 5day, 7day, 14day, 31day)
 p5 Pre-trigger (0, 5, 25, 50, 75, 95, 100) [%]
 p6 Trigger source key (Off, On)

Query `SEventData[, p1]?`

Example Record event data in Free mode at a recording interval of 1 second. Separate the data into different files every 2 hours.
`SEventData, 1, 1s, Free, 2h`

Description

- You cannot use this command to configure settings while recording is in progress.
- You cannot use this command to configure settings while computation is in progress.
- You cannot choose a recording interval that is shorter than the scan interval.
- You cannot choose a recording interval that is not an integer multiple of the scan interval.
- p1 = 2 is valid when the measurement mode is set to dual interval.
- The recording interval (p2) can be set in the following range.

Measurement mode	Options (p2)
Normal	100ms, 200ms, 500ms, 1s, 2s, 5s, 10s, 15s, 20s, 30s, 1min, 2min, 5min, 10min, 15min, 20min, 30min
High speed (Note 1)	1ms, 2ms, 5ms, 10ms, 20ms, 50ms, 100ms, 200ms, 500ms, 1s, 2s, 5s, 10s, 15s, 20s, 30s, 1min, 2min, 5min, 10min, 15min, 20min, 30min
Dual interval (Note 1)	1ms, 2ms, 5ms, 10ms, 20ms, 50ms, 100ms, 200ms, 500ms, 1s, 2s, 5s, 10s, 15s, 20s, 30s, 1min, 2min, 5min, 10min, 15min, 20min, 30min

1 | There are limits to the recording intervals less than or equal to 50 ms depending the scan interval.

The recording intervals (p2) less than or equal to 50 ms can be set in the following range.

Scan interval	Recording intervals less than or equal to 50 ms
1ms	1ms, 2ms, 5ms, 10ms, 20ms, 50ms
2ms	2ms, 10ms, 20ms, 50ms
5ms	5ms, 10ms, 20ms, 50ms
10ms	10ms, 20ms, 50ms
20ms	20ms
50ms	50ms

- There are limits to the recording interval (p2) depending on the model, scan interval, and number of recording channels (see SRecEvent).
- Data length (p4) can be set to 2min or 5min when the measurement mode is set to high speed. Data length (p4) can be set to 5min when the measurement mode is set to dual interval.
- This setting is valid when event data recording is enabled (recording mode of the SMemory command).
- When the advanced security function (/AS) is enabled, p3 is fixed to Free.
- When the multi batch function (/BT) is enabled, p3 is fixed to Free.

SRecDisp

Channel for Recording Display Data

Sets the channel for recording display data.

Syntax `SRecDisp,p1,p2,p3`
 p1 Number (see "Description")
 p2 Channel type
 Off Do not record display data.
 IO I/O channel
 Math Math channel
 Com Communication channel
 p3 Channel number

Query `SRecDisp[,p1]?`

Example Assign the display data of I/O channel 0005 to number 10 and record.

`SRecDisp,10,IO,0005`

Description

- You cannot use this command to configure settings while recording is in progress.
- You cannot use this command to configure settings while computation is in progress.
- You cannot use this command to configure settings when the measurement mode is set to dual interval.
- If p2=Off, you cannot set p3.
- There is a limit to the number of recording channels depending on the recording interval (**SDispData** command).

Recording Interval	Number of Recording Channels
5 s/div	100
10 s/div	200
15 s/div or higher	500

For the large memory type (GX20-2/GP20-2/GM10-2), the following table applies.

Recording Interval	Number of Recording Channels	
	When recording only display data	When recording display data and event data
5s/div	200	100
10s/div	500	200
15s/div	1000	500
30s/div or more	1000	1000

- You cannot set a channel more than once.

SRecEvent

Channel for Recording Event Data

Sets the channel for recording event data.

Syntax `SRecEvent,p1,p2,p3,p4`
 p1 Scan group (1 or 2)
 p2 Number (see "Description")
 p3 Channel type
 Off Do not record event data.
 IO I/O channel
 Math Math channel
 Com Communication channel
 p4 Channel number

Query `SRecEvent[,p1[,p2]]?`

Example Assign the event data of I/O channel 0006 to number 11 and record.

`SEventData,1,11,IO,0006`

Description

- You cannot use this command to configure settings while recording is in progress.
- You cannot use this command to configure settings while computation is in progress.
- If p3=Off, you cannot set p4.
- This setting is valid when event data recording is enabled (recording mode of the **SMemory** command).
- There is a limit to the number of recording channels depending on the recording interval (**SEventData** command).

Recording Interval	Number of Recording Channels
100 ms	100
200 ms	200
500 ms or more	500

For the large memory type (GX20-2/GP20-2/GM10-2), the following table applies.

Recording Interval	Number of Recording Channels	
	When recording only event data	When recording display data and event data
100ms	500	100
200ms	500	200
500ms	1000	500
1s or more	1000	1000

- If the recording interval is 50 ms or less, there are limits to the number of recording channels depending on the model and measurement mode.

High speed0

Model	Recording interval					
	1ms	2ms	5ms	10ms	20ms	50ms
GX/GP10	2ch	4ch	10ch	20ch	40ch	100ch
GX/GP20-1	2ch	4ch	10ch	20ch	40ch	100ch
GX/GP20-2	10ch	20ch	50ch	100ch	150ch	150ch
GM10-1	2ch	4ch	10ch	20ch	40ch	100ch
GM10-2	10ch	20ch	50ch	100ch	150ch	150ch

Dual interval

Model	Recording interval					
	1ms	2ms	5ms	10ms	20ms	50ms
GX/GP10	-	-	5ch	10ch	20ch	50ch
GX/GP20-1	-	-	5ch	10ch	20ch	50ch
GX/GP20-2	5ch	10ch	25ch	40ch	50ch	50ch
GM10-1	-	-	5ch	10ch	20ch	50ch
GM10-2	5ch	10ch	25ch	40ch	50ch	50ch

- You cannot set a channel more than once.
- When the measurement mode is set to dual interval and p3 = IO, you can set the channels of only the applicable scan groups.
- If the measurement mode is set to dual interval, p3 = Math and p3 = Com can be specified only on scan groups operating at the master scan interval.

SRecManual

Channel for Recording Manual Sampled Data

Sets the channel for recording manual sampled data.

Syntax `SRecManual, p1, p2, p3`
 p1 Number (1 to 50)
 p2 Channel type
 Off Do not record manual sampled data.
 IO I/O channel
 Math Math channel (/MT)
 Com Communication channel (/MC)
 p3 Channel number

Query `SRecManual[, p1]?`

Example Assign the manual sampled data of I/O channel 0003 to number 2 and record.

```
SRecManual, 2, IO, 0003
```

Description

- You cannot use this command to configure settings while recording is in progress.
- You cannot use this command to configure settings while computation is in progress.
- If p2=Off, you cannot set p3.
- You cannot set a channel more than once.

SBatch

Batch Function

Configures the batch function's basic settings.

Syntax `SBatch, p1, p2, p3, p4`
 p1 Enable or disable (Off, On)
 p2 Number of lot number digits (Off, 4, 6, 8)
 Off Do not use lot numbers.
 4 4-digit lot number
 6 6-digit lot number
 8 8-digit lot number
 p3 Auto increment (Off, On)
 p4 Recording start screen (Comment, TextField)
 Comment Batch comment
 TextField Text field

Query `SBatch?`

Example Enable the batch function. Use 4-digit lot numbers. Automatically increment the lot number in the next operation.

```
SBatch, On, 4, On, TextField
```

Description

- You cannot use this command to configure settings while recording is in progress.
- When the multi batch function (/BT) is enabled, p1 is fixed to On.

STextField

Batch Text

Sets a batch text.

Syntax `STextField, p1, p2, p3`
 p1 Field number (1 to 24)
 p2 Title (up to 20 characters, UTF-8)
 p3 Character string (up to 30 characters, UTF-8)

Query `STextField[, p1]?`

Example For field number 3, set the field title to "OPERATOR" and the character string to "RECORDER1."

```
STextField, 3, 'OPERATOR', 'RECORD  
ER1'
```

Description

- You cannot use this command to configure settings while recording is in progress.
- This command is valid only when the multi batch function (/BT) is disabled.

SDirectory

Name of Directory to Save Data

Sets the name of the directory to save data.

Syntax `SDirectory, p1`
 p1 Directory name (up to 20 characters, ASCII)

Query `SDirectory?`

Example Set the directory name to "DATA0."

```
SDirectory, 'DATA0'
```

Description

- For the characters that you can use in the directory name (p1), see [Appendix 1](#).
- The following character strings cannot be used for directory names.

Character String
AUX
CON
PRN
NUL
CLOCK
CLOCK\$
COM0 to COM9
LPT0 to LPT9

- You cannot use a character string that starts or ends with a period or space for directory names.

SFileHead

File Header

Sets the file header character string.

Syntax `SFileHead, p1`
 p1 File header (up to 50 characters, UTF-8)

Query `SFileHead?`

Example Set the file header to "GX_DATA."

```
SFileHead, 'GX_DATA'
```

Description

- This command is valid only when the multi batch function (/BT) is disabled.

SFileName

File Naming Rule

Sets the file naming rule for data files.

Syntax SFileName,p1,p2
 p1 File naming rule
 Date Date
 Serial Serial number
 Batch Batch name
 p2 Specified file name (up to 16 characters, ASCII)

Query SFileName?

Example Set the file naming rule to "Date." Set the specified file name to "Recorder1_data."
 SFileName,Date,'Recorder1_data'

Description

- If the batch setting is disabled (SBatch: p1=Off), you cannot specify p1=Batch.
- For the characters that you can use in the specified file name (p2), see [Appendix 1](#).
- This command is valid only when the multi batch function (/BT) is disabled.

SMediaSave

Automatic Data File Saving

Sets the auto saving of data files to an external storage medium.

Syntax SMediaSave,p1,p2
 p1 Auto saving to an external storage medium
 (GX/GP: Off, On)
 (GM: Off, On, Fixed to On when the advanced security function (/AS) is enabled and the log in via communication is enabled.)
 p2 Media FIFO (Off, On)

Query SMediaSave?

Example Enable the auto saving to the external storage medium and media FIFO.
 SMediaSave,On,On

SFileFormat

Display/Event Data File Format

Sets the file format of display data files and event data files.

Syntax SFileFormat,p1
 p1 File format (Binary, Text)

Query SFileFormat?

Example Create files in text format.
 SFileFormat,Text

Description

- The types of data that you can set file formats for are display data and event data.
- The file saving methods that the specified file format is applied to are auto saving, saving of unsaved data, manual saving, and FTP data transfer.
- When the advanced security function (/AS) is enabled, p1 is fixed to Binary.

SRangeAI**Measurement Range of AI Channel**

Sets the measurement range of an AI channel.

Unused Channels

Syntax `SRangeAI, p1, p2`
 p1 Channel number
 p2 Input type (Skip)

Channels Whose Input Type Is DI and No Math

Syntax `SRangeAI, p1, p2, p3, p4, p5, p6`
 p1 Channel number
 p2 Input type (DI)
 p3 Range (see "Description.")
 P4 Calculation type (Off)
 p5 Span lower limit
 p6 Span upper limit

Channels Whose Input Type Is Volt, TC, RTD, or OHM and No Calculation

Syntax `SRangeAI, p1, p2, p3, p4, p5, p6, p7`
 p1 Channel number
 p2 Input type (Volt, TC, RTD)
 p3 Range (see "Description.")
 P4 Calculation type (Off)
 p5 Span lower limit
 p6 Span upper limit
 p7 Bias (–999999 to 999999)

Delta Channels

Syntax `SRangeAI, p1, p2, p3, p4, p5, p6, p7, p8`
 p1 Channel number
 p2 Input type (Volt, TC, RTD, DI, OHM)
 p3 Range (see "Description.")
 P4 Calculation type (Delta)
 p5 Span lower limit
 p6 Span upper limit
 p7 Bias (–999999 to 999999) (can be set when p2 is not set to DI)
 p8 Reference channel number

Scaling Channels

Syntax `SRangeAI, p1, p2, p3, p4, p5, p6, p7, p8, p9, p10, p11`
 p1 Channel number
 p2 Input type (Volt, TC, RTD, DI, OHM)
 p3 Range (see "Description.")
 P4 Calculation type (Scale)
 p5 Span lower limit
 p6 Span upper limit
 p7 Bias (–999999 to 999999) (can be set when p2 is not set to DI)
 p8 Decimal Place (0 to 5)
 p9 Scaling lower limit
 p10 Scaling upper limit
 p11 Unit (up to 6 characters, UTF-8)

Unified Signal Input Channels (Input Type Is GS)

Syntax `SRangeAI, p1, p2, p3, p4, p5, p6, p7, p8, p9, p10, p11, p12, p13`
 p1 Channel number

p2 Input type (GS)
 p3 Range (see "Description.")
 P4 Calculation type (Scale)
 p5 Span lower limit
 p6 Span upper limit
 p7 Bias (–999999 to 999999)
 p8 Decimal Place (0 to 5)
 p9 Scaling lower limit
 p10 Scaling upper limit
 p11 Unit (up to 6 characters, UTF-8)
 p12 Low-cut function (Off, On)
 p13 Low-cut point (0 to 50)

Square Root Channels

Syntax `SRangeAI, p1, p2, p3, p4, p5, p6, p7, p8, p9, p10, p11, p12, p13, p14`
 p1 Channel number
 p2 Input type (Volt, GS)
 p3 Range (see "Description.")
 P4 Calculation type (Sqrt)
 p5 Span lower limit
 p6 Span upper limit
 p7 Bias (–999999 to 999999)
 p8 Decimal Place (0 to 5)
 p9 Scaling lower limit
 p10 Scaling upper limit
 p11 Unit (up to 6 characters, UTF-8)
 p12 Low-cut function (Off, On)
 p13 Low-cut point (0 to 50)
 p14 Low-cut output (Zero, Linear)

Log Scale (LG) Channels

Syntax `SRangeAI, p1, p2, p3, p4, p5, p6, p7, p8, p9, p10, p11`
 p1 Channel number
 p2 Input type (Volt)
 p3 Range (see "Description.")
 P4 Calculation type (LogT1, LogT2, LogT3)
 LogT1 Log input
 LogT2 Pseudo Log Input
 LogT3 Linear-log input
 p5 Span lower limit (see "Description.")
 p6 Span upper limit (see "Description.")
 p7 Bias (–999999 to 999999)
 p8 Decimal place of mantissa (1, 2)
 p9 Scaling lower limit (exponential notation, 1.00E-15 to 1.00E15) (see "Description.")
 p10 Scaling upper limit (exponential notation, 1.00E-15 to 1.00E15) (see "Description.")
 p11 Unit (up to 6 characters, UTF-8)

Query `SRangeAI [, p1] ?`

Example Measure -0.5000 to 1.0000 V on channel 0002. No scaling. No bias.
`SRangeAI, 0002, Volt, 2V, Off, -5000, 10000, 0`

Description

- You cannot use this command to configure settings while recording is in progress.

- You cannot use this command to configure settings while computation is in progress.
- If p2=TC/RTD/DI/OHM, you cannot specify p4=.Sqrt.
- If p2=GS, you cannot specify p4=Off/Delta.
- If p2=DI, you cannot set p7.
- If an electro-magnetic relay type, low withstand voltage relay type or high withstand voltage type analog input module is in use, you cannot specify p2=RTD.
- For 4-wire RTD modules, p2 cannot be set to Volt, TC, GS, or DI. (Only SKIP, RTD, and OHM are selectable.)
- p2 = OHM is valid only for 4-wire RTD modules.
- The settable items for p3 are shown below.

p2=Volt	p2=TC	p2=RTD	p2=GS	p2=DI
20mV	R	Pt100	1-5V	Level
60mV	S	Pt100-H	0.4-2V	DI
200mV	B	JPt100		
1V	K	JPt100-H		
2V	K-H	Cu10GE		
6V	E	Cu10LN		
20V	J	Cu10WEED		
50V	T	Cu10BAILEY		
100V ¹	N	Cu10a392		
	W	Cu10a393		
	L	Cu25		
	U	Cu53		
	PLATINEL	Cu100		
	PR20-40	J263B		
	WRe3-25	Ni100SAMA		
	KpvsAu7Fe	Ni100DIN		
	NiNiMo	Ni120		
	WRe26	Pt25		
	N14	Pt50		
	XK	Pt200WEED		
		Cu10G		
		Cu50G		
		Cu100G		
		Pt46G		
		Pt100G		
		Pt500 ²		
		Pt1000 ²		

1 Valid only for high-speed AI modules

2 Valid only for 4-wire RTD modules

- If p4=LogT1 on a Log scale channel, set the value in the following range.
 - p5<p6
 - p9, p10
p9<p10. The maximum span is 15 decades. If the mantissa of p9 is 1.00, the minimum span is 1 decade. If the mantissa of p9 is not 1.00, the minimum span is 2 decades.
- If p4=LogT2 or LogT3 on a Log scale channel, set the value in the following range.
 - p5<p6
 - p9, p10
The maximum span is 15 decades; the minimum is 1 decade. If the mantissa of p9 is not 1.00, the exponent is +14 or less, and the maximum span is 14 decades.

SRangeAICurrent

Measurement Range of Current Input Type AI Channel

Sets the measurement range of an current input type AI channel.

Unused Channels

Syntax SRangeAICurrent, p1, p2
 p1 Channel number
 p2 Input type (Skip)

Channels Whose Input Type is Current and No Math

Syntax SRangeAICurrent, p1, p2, p3, p4, p5, p6, p7
 p1 Channel number
 p2 Input type (Current)
 p3 Range (0-20mA)
 p4 Math type (Off)
 p5 Span lower limit
 p6 Span upper limit
 p7 Bias (-999999 to 999999)

Delta Channels

Syntax SRangeAICurrent, p1, p2, p3, p4, p5, p6, p7, p8
 p1 Channel number
 p2 Input type (Current)
 p3 Range (0-20mA)
 p4 Math type (Delta)
 p5 Span lower limit
 p6 Span upper limit
 p7 Bias (-999999 to 999999)
 p8 Reference channel number

Scaling Channels

Syntax SRangeAICurrent, p1, p2, p3, p4, p5, p6, p7, p8, p9, p10, p11
 p1 Channel number
 p2 Input type (Current)
 p3 Range (0-20mA)
 p4 Math type (Scale)
 p5 Span lower limit
 p6 Span upper limit
 p7 Bias (-999999 to 999999)
 p8 Decimal place (0 to 5)
 p9 Scaling lower limit
 p10 Scaling upper limit
 p11 Unit (up to 6 characters, UTF-8)

Scaling Channels (General Signal 4-20 mA Input)

Syntax SRangeAICurrent, p1, p2, p3, p4, p5, p6, p7, p8, p9, p10, p11, p12, p13
 p1 Channel number
 p2 Input type (GS)
 p3 Range (4-20mA)
 p4 Math type (Scale)

2.4 Setting Commands

- p5 Span lower limit
- p6 Span upper limit
- p7 Bias (-999999 to 999999)
- p8 Decimal place (0 to 5)
- p9 Scaling lower limit
- p10 Scaling upper limit
- p11 Unit (up to 6 characters, UTF-8)
- p12 Low-cut function (Off, On)
- p13 Low-cut point (0 to 50)

Square Root Channels

Syntax `SRangeAICurrent, p1, p2, p3, p4, p5, p6, p7, p8, p9, p10, p11, p12, p13, p14`

- p1 Channel number
- p2 Input type (Current, GS)
- p3 Range
 - 0-20mA When p2 = Current
 - 4-20mA When p2 = GS
- p4 Math type (Sqrt)
- p5 Span lower limit
- p6 Span upper limit
- p7 Bias (-999999 to 999999)
- p8 Decimal place (0 to 5)
- p9 Scaling lower limit
- p10 Scaling upper limit
- p11 Unit (up to 6 characters, UTF-8)
- p12 Low-cut function (Off, On)
- p13 Low-cut point (0 to 50)
- p14 Low-cut output (Zero, Linear)

Query `SRangeAICurrent[, p1]?`

Example Measure 0.000 to 10.000 mA on channel 0002. No scaling. No bias.
`SRangeAICurrent, 0002, Current, 0-20mA, Off, 0, 10000, 0`

Description

- You cannot use this command to configure settings while recording is in progress.
- You cannot use this command to configure settings while computation is in progress.
- If p2=GS, you cannot specify p4=Off/Delta.
- Specify p5 and p6 within the range shown in the following table.

Range (p3)	Value (p5, p6)
0-20mA	0.000 to 20.000
4-20mA	3.200 to 20.800

SRangePulse

Measurement Range of Pulse Input Channel

Sets the measurement range of a pulse input channel.

Unused Channels

Syntax `SRangePulse, p1, p2`
 p1 Channel number
 p2 Input type (Skip)

Channels Whose Input Type is PulseInput and No Math

Syntax `SRangePulse, p1, p2, p3, p4, p5, p6, p7`

- p1 Channel number
- p2 Input type (PulseInput)
- p3 Range (LevelRange, ContactRange)
 - LevelRange Level
 - ContactRange Contact
- p4 Chattering filter (On, Off)
- p5 Math type (Off)
- p6 Span lower limit
- p7 Span upper limit

Channels Whose Input Type is PulseInput and Delta

Syntax `SRangePulse, p1, p2, p3, p4, p5, p6, p7, p8`

- p1 Channel number
- p2 Input type (PulseInput)
- p3 Range (LevelRange, ContactRange)
 - LevelRange Level
 - ContactRange Contact
- p4 Chattering filter (On, Off)
- p5 Math type (Delta)
- p6 Span lower limit
- p7 Span upper limit
- p8 Reference channel number

Channels Whose Input Type is PulseInput and Linear Scaling

Syntax `SRangePulse, p1, p2, p3, p4, p5, p6, p7, p8, p9, p10, p11`

- p1 Channel number
- p2 Input type (PulseInput)
- p3 Range (LevelRange, ContactRange)
 - LevelRange Level
 - ContactRange Contact
- p4 Chattering filter (On, Off)
- p5 Math type (Scale)
- p6 Span lower limit
- p7 Span upper limit
- p8 Decimal place (0, 1, 2, 3, 4, 5)
- p9 Scaling lower limit
- p10 Scaling upper limit
- p11 Unit

Query `SRangePulse[, p1]?`

Example Measure the pulse (level) on channel 0002. Chattering filter is on. Math is on.
`SRangePulse, 0002, PulseInput, LevelRange, On, Off, 0, 1000, 0, 200, "m3/min"`

Description

- You cannot use this command to configure settings while recording is in progress.
- You cannot use this command to configure settings while computation is in progress.

SRangeDI

Measurement Range of DI Channel

Sets the measurement range of a DI channel.

Unused Channels

Syntax `SRangeDI, p1, p2`
p1 Channel number
p2 Input type (Skip)

Channels That Are Not Delta, Scaling, Pulse Input

Syntax `SRangeDI, p1, p2, p3, p4, p5, p6`
p1 Channel number
p2 Input type (DI)
p3 Fixed at “-.”
P4 Calculation type (Off)
p5 Span lower limit (0 to 1)
p6 Span upper limit (0 to 1)

Delta Channels

Syntax `SRangeDI, p1, p2, p3, p4, p5, p6, p7`
p1 Channel number
p2 Input type (DI)
p3 Fixed at “-.”
P4 Calculation type (Delta)
p5 Span lower limit (0 to 1)
p6 Span upper limit (0 to 1)
p7 Reference channel number

Scaling Channels

Syntax `SRangeDI, p1, p2, p3, p4, p5, p6, p7, p8, p9, p10`
p1 Channel number
p2 Input type (DI)
p3 Fixed at “-.”
P4 Calculation type (Scale)
p5 Span lower limit (0 to 1)
p6 Span upper limit (0 to 1)
p7 Decimal Place (0 to 5)
p8 Scaling lower limit
p9 Scaling upper limit
p10 Unit (up to 6 characters, UTF-8)

Pulse Input Channels

Syntax `SRangeDI, p1, p2, p3, p4, p5, p6`
p1 Channel number
p2 Input type (Pulse)
p3 Fixed at “-.”
P4 Math type (Off)
p5 Span lower limit (0 to 999999)
p6 Span upper limit (0 to 999999)

Query `SRangeDI[, p1]?`

Example Measure 0 to 1 on channel 0103. No scaling.
`SRangeDI, 0103, DI, -, Off, 0, 1`

Description

- You cannot use this command to configure settings while recording is in progress.
- You cannot use this command to configure settings while computation is in progress.

- p2=Pulse can be specified when the math function (/ MT) is installed.
- If p2=Pulse, p4=Delta or Scale cannot be specified.
- p2=Pulse cannot be specified when the operation mode of the DI module is set to Remote.
- You cannot use this command to configure settings when the measurement mode is set to high speed.

SRangeDO

DO Channel Operation

Sets the DO channel operation.

Alarm Output

Syntax `SRangeDO, p1, p2, p3, p4, p5, p6, p7, p8, p9`
p1 Channel number
p2 Output type (Alarm)
p3 Span lower limit (0 to 1)
P4 Span upper limit (0 to 1)
p5 Unit (up to 6 characters, UTF-8)
p6 Energize or de-energize

Energize	Energize the relay (DO channel) during output.
De_Energize	De-energize the relay (DO channel) during output.

p7 Operation

And	Operate when all set alarms are in the alarm state.
Or	Operate when any of the set alarms are in the alarm state.

p8 Hold or nonhold

Hold	Hold output until an alarm ACK operation.
Nonhold	Clear output when the alarm is cleared.

p9 Relay (DO channel) action on acknowledge (Normal, Reset)

Alarm Output (Reflash)

Syntax `SRangeDO, p1, p2, p3, p4, p5, p6, p7, p8, p9`
p1 Channel number
p2 Output type (Alarm)
p3 Span lower limit (0 to 1)
P4 Span upper limit (0 to 1)
p5 Unit (up to 6 characters, UTF-8)
p6 Energize or de-energize

Energize	Energize the relay (DO channel) during output.
De_Energize	De-energize the relay (DO channel) during output.

p7 Action (Reflash)
p8 Reflash time (500ms, 1s, 2s)
p9 Relay (DO channel) action on acknowledge

Manual Output

Specifies the output value.

2.4 Setting Commands

Syntax `SRangeDO, p1, p2, p3, p4, p5, p6`
p1 Channel number
p2 Output type (Manual)
p3 Span lower limit (0 to 1)
p4 Span upper limit (0 to 1)
p5 Unit (up to 6 characters, UTF-8)
p6 Energize or de-energize
Energize Energize the relay (DO channel) during output.
De_Energize De-energize the relay (DO channel) during output.

Fail Output (GM10 only)

Syntax `SRangeDO, p1, p2, p3, p4, p5, p6`
p1 Channel number
p2 Output type (Fail)
p3 Span lower limit (0 to 1)
p4 Span upper limit (0 to 1)
p5 Unit (up to 6 characters, UTF-8)
p6 Fixed to De_energize
De_Energize De-energize the relay (DO channel) during output.

Query `SRangeDO[, p1]?`

Example Output an alarm on channel 0203. Set the span lower limit to 0 and span upper limit to 1. Specify energize operation, logic or operation, and hold operation. Set the action on ACK to Normal. Set the unit to "Unit."
`SRangeDO, 0203, Alarm, 0, 1, Unit, Energize, Or, Hold, Normal`

Description

- You cannot use this command to configure settings while recording is in progress.
- You cannot use this command to configure settings while computation is in progress.
- If p2=Manual, you cannot set p7 or subsequent parameters.
- If p7=And or Or, you cannot set the reflash time.
- If individual alarm ACK is enabled (SIndivAlmACK command), p9 is fixed to Reset.

SRangeAO

AO channel operation

Sets the AO channel operation.

Skip

Syntax `SRangeAO, p1, p2`
p1 Channel number
p2 Output type (Skip)

Re-transmission

Syntax `SRangeAO, p1, p2, p3, p4, p5, p6, p7, p8`
p1 Channel number
p2 Output type (Trans)
p3 Range (AO_0-20mA, AO_4-20mA)
p4 Span low limit
p3= AO_0-20mA: 0 to 20000
p3= AO_4-20mA: 4000 to 20000

p5 Span high limit
p3= AO_0-20mA 0 to 20000
p3= AO_4-20mA 4000 to 20000
p6 Preset value (0 to 22000)
p7 Reference channel type (Input, Math, Com)
Input Input channel
Math Math channel (/MT)
Com Communication channel (/MC)
p8 Reference channel number

Manual output

Syntax `SRangeAO, p1, p2, p3, p4, p5, p6`
p1 Channel number
p2 Output type (ManualAO)
p3 Range (AO_0-20mA, AO_4-20mA)
p4 Span low limit
p3= AO_0-20mA: 0 to 20000
p3= AO_4-20mA: 4000 to 20000
p5 Span high limit
p3= AO_0-20mA: 0 to 20000
p3= AO_4-20mA: 4000 to 20000
p6 Preset value (0 to 22000)

Query `SRangeAO[, p1]?`

Description

- You cannot use this command to configure settings while recording is in progress.
- You cannot use this command to configure settings while computation is in progress.
- If there is no input channel, math channel (/MT option), or communication channel (/MC option), re-transmission (p2 = Trans) cannot be specified.
- If p2 = Trans, the reference channel cannot be set to an output channel (AO, DO).

SMoveAve

Moving Average

Sets the moving average of an AI or PI channel.

Syntax `SMoveAve, p1, p2, p3`
p1 Channel number
p2 Enable or disable (Off, On)
p3 Number of samples
Modules other than high speed AI: 2 to 100 (times)
High speed AI: 2 to 500 (times)

Query `SMoveAve[, p1]?`

Example Set the number of moving average samples for channel 0002 to 12.
`SMoveAve, 0002, On, 12`

SFilter

Sets the First-Order Lag Filter

Sets the first-order lag filter of a high-speed AI channel when a high-speed AI module is installed.

Syntax `SFilter,p1,p2,p3`
p1 Channel number
p2 Enable or disable (Off, On)
p3 First-order lag coefficient (3 to 300)

Query `SFilter[,p1]?`

Example Set the first-order lag of channel 0002 to 100.
`SFilter,0002,On,100`

Description

- This command is valid only for channels on high-speed AI type analog input modules.

SBurnOut

Behavior When a Sensor Burns Out

Sets the behavior for when a burnout occurs on an AI channel.

Syntax `SBurnOut,p1,p2`
p1 Channel number
p2 Burnout processing (Off, Up, Down)

Query `SBurnOut[,p1]?`

Example Set the measured result to positive overflow (Up) when a burnout is detected on channel 0001.
`SBurnOut,0001,Up`

Description

- You cannot use this command to configure settings while recording is in progress.
- You cannot use this command to configure settings while computation is in progress.
- This command is invalid for 4-wire RTD modules.

SRjc

Reference Junction Compensation Method

Sets the reference junction compensation method of an AI channel.

Syntax `SRjc,p1,p2,p3`
p1 Channel number
p2 Mode
 Internal Use the internal compensation function.
 External Use an external compensation device.
p3 Compensation temperature
 -200 to 800 -20.0 to 80.0°C
 -40 to 1760 -40 to 1760°F
 2531 to 3532 253.1 to 353.2K

Query `SRjc[,p1]?`

Example Perform reference junction compensation of channel 0003 using the internal compensation circuit.

```
SRjc,0003,Internal
```

Perform reference junction compensation of channel 0004 using an external compensation device. Set the compensation temperature to -2.3°C.

```
SRjc,0004,External,-23
```

Description

- You cannot use this command to configure settings while recording is in progress.
- You cannot use this command to configure settings while computation is in progress.
- If p2=Internal, p3 is invalid.
- This command is invalid for 4-wire RTD modules.

SAlarmIO

Alarm

Sets the alarm for an AI, DI, or PI channel.

Do Not Set Alarms

Syntax SAlarmIO, p1, p2, p3
 p1 Channel number
 p2 Alarm number (1 to 4)
 p3 Alarm on or off (Off)

Do Not Output Alarms

Syntax SAlarmIO, p1, p2, p3, p4, p5, p6, p7
 p1 Channel number
 p2 Alarm number (1 to 4)
 p3 Alarm on or off (On)
 p4 Alarm type (H, L, DH, DL, RH, RL, TH, TL)
 For a channel set to Log scale (/LG) (if p4 of SRangeAI is LogT1, LogT2, or LogT3), p4 is H, L, TH, or TL.
 p5 Value
 For a channel set to Log scale (/LG) (if p4 of SRangeAI is LogT1, LogT2, or LogT3), specify p5 using exponential notation (e.g. 1.23E10, where the number of digits of the mantissa is as specified by p8 of the SRangeAI command).
 p6 Detection (Off, On)
 p7 Output (Off)

Output Alarms

Syntax SAlarmIO, p1, p2, p3, p4, p5, p6, p7, p8
 p1 Channel number
 p2 Alarm number (1 to 4)
 p3 Alarm on or off (On)
 p4 Alarm type (H, L, DH, DL, RH, RL, TH, TL)
 For a channel set to Log scale (/LG) (if p4 of SRangeAI is LogT1, LogT2, or LogT3), p4 is H, L, TH, or TL.
 p5 Value
 For a channel set to Log scale (/LG) (if p4 of SRangeAI is LogT1, LogT2, or LogT3), specify p5 using exponential notation (e.g. 1.23E10, where the number of digits of the mantissa is as specified by p8 of the SRangeAI command).
 p6 Detection (Off, On)
 p7 Output
 DO Output to a relay (DO channel)
 SW Output to an internal switch
 p8 Number
 If p7=DO Relay (DO channel) number
 If p7=SW Internal switch number (001 to 100)

Query SAlarmIO[, p1[, p2]]?

Example Set a high limit alarm (H) on alarm number 2 of channel 0001. Set the alarm value to 1.8000V. Use the alarm detection function. When an alarm occurs, output to the relay (DO channel) at number 0205.

SAlarmIO, 0001, 2, On, H, 18000, On, DO, 0205

Description

- You cannot set this on a "Skip" channel.
- If p3=Off, you cannot set p4 or subsequent parameters.
- If p7=Off, you cannot set p8.
- For the alarm values of p5, use the values in the following table.

Channel Type	Input Type	Calculation Type	Alarm Type		
			H, L, TH, TL	RH, RL	DH, DL
AI channel	Volt, GS, TC, RTD	Off	(1)	(3)	/
		Delta	(1)	(3)	(5)
		Scale	(2)	(4)	/
		Sqrt	(2)	(4)	/
	LogT1 LogT2 LogT3	(6)	/	/	
	DI	Off	0, 1	1	/
DI channel	Pulse	Delta	(1)	(3)	(5)
		Scale	(2)	(4)	/
		Same as the DI input of AI channels			
PI channel	Pulse	Off	(1)	(3)	/
		Delta	(1)	(3)	(5)
		Scale	(2)	(4)	/

- Within the measurement range
- 5% to 105% of the scale but within -999999 to 999999 excluding the decimal point
- 1 digit to (measurement upper limit - measurement lower limit)
- 1 digit to (scale upper limit - scale lower limit) but within 1 to 999999 excluding the decimal point
- Within the difference measurement range
- Log scale range that corresponds to -5% to 105% of the span

- You cannot set DO channels or internal switches whose output type is set to Manual as output destination numbers.
- You cannot set DI channels when the measurement mode is set to high speed.

SAlmHysIO

Alarm Hysteresis

Sets the alarm hysteresis for an AI, DI, or PI channel.

Syntax SAlmHysIO, p1, p2, p3
 p1 Channel number
 p2 Alarm number (1 to 4)
 p3 Hysteresis

Alarm Type	Hysteresis Range
H, L, DH, DL	0.0% to 5.0% of the span or scale width However, this is fixed to 0 for DI channels.
Delta	0 to 5.0% of the measurement range
Linear scaling, Square root	0 to 100000
Log scale (/LG)	Fixed to 0.

Query `SAlmHysIO[,p1[,p2]]?`

Example Set a 0.5% hysteresis on alarm 3 of channel 0002.
`SAlmHysIO,0002,3,5`

Description

- Hysteresis specified for delay high and low limit alarms (TH and TL) and high and low limits on rate-of-change alarms (RH and RL) do not apply.
- When the input type of a DI channel is Pulse, hysteresis is fixed at 0.
- You cannot set DI channels when the measurement mode is set to high speed.

SAlmDlyIO

Alarm Delay Time

Sets the delay alarm time for an AI, DI, or PI channel.

Syntax `SAlmDlyIO,p1,p2,p3,p4`
 p1 Channel number
 p2 Hour (0 to 24)
 p3 Minute (0 to 59)
 p4 Second (0 to 59)

Query `SAlmDlyIO[,p1]?`

Example Set the channel 0001 alarm delay time to 2 minutes 30 seconds.
`SAlmDlyIO,0001,0,2,30`

Description

- Set the delay time so that it is an integer multiple of the scan interval (**SScan** command).
- You cannot set DI channels when the measurement mode is set to high speed.

STagIO

Tag

Sets a tag to an AI, DI, PI, AO, DO, or PID channel.

Syntax `STagIO,p1,p2,p3`
 p1 Channel number
 p2 Tag (up to 32 characters, UTF-8)
 p3 Tag number (up to 16 characters, ASCII)

Query `STagIO[,p1]?`

Example Set the channel 0001 tag to "SYSTEM1" and the tag number to "TI002."
`STagIO,0001,'SYSTEM1','TI002'`

Description

- You cannot set DI channels when the measurement mode is set to high speed.

SColorIO

Channel Color

Sets the color of an AI, DI, PI, AO, DO, or PID channel.

Syntax `SColorIO,p1,p2,p3,p4`
 p1 Channel number
 p2 R value of RGB display colors (0 to 255, see "Description.")
 p3 G value of RGB display colors (0 to 255, see "Description.")
 p4 B value of RGB display colors (0 to 255, see "Description.")

Query `SColorIO[,p1]?`

Example Set the channel 0001 display color to red.
`SColorIO,0001,255,0,0`

Description

- The RGB values for different colors are indicated in the following table.

Color	R	G	B	Note
Red	255	0	0	
Green	0	153	51	
Blue	0	51	255	
Blue violet	119	51	204	GX10/GP10
	102	51	204	GX20/GP20 GM10
Brown	153	51	0	
Orange	255	153	51	
Yellow green	153	204	51	GX10/GP10
	170	221	51	GX20/GP20 GM10
Light blue	119	170	221	GX10/GP10
	153	204	255	GX20/GP20 GM10
Violet	204	102	204	GX10/GP10
	221	153	221	GX20/GP20 GM10
Gray	153	153	153	
Lime	102	255	0	
Cyan	0	255	255	
Dark blue	0	0	153	
Yellow	255	255	0	
Light gray	204	204	204	
Purple	153	0	153	GX10/GP10
	136	0	136	GX20/GP20 GM10
Black	0	0	0	
Pink	255	17	153	
Rosy brown	204	153	153	
Pale green	153	255	153	GX10/GP10
	187	255	153	GX20/GP20 GM10
Dark gray	102	102	102	
Olive	153	153	0	
Dark cyan	0	153	153	
Spring green	0	204	153	GX10/GP10
	0	221	119	GX20/GP20 GM10

- You cannot set DI channels when the measurement mode is set to high speed.

SZoneIO

Waveform Display Zone

Sets the waveform display zone of an AI, DI, PI, AO, DO, or PID channel.

Syntax `SZoneIO, p1, p2, p3`
 p1 Channel number
 p2 Zone lower limit [%] (0 to 95)
 p3 Zone upper limit [%] (5 to 100)

Query `SZoneIO[, p1]?`

Example Set the waveform zone of channel 0001 waveform to 0% to 30%.
`SZoneIO, 0001, 0, 30`

Description

- You cannot set DI channels when the measurement mode is set to high speed.

SScaleIO

Scale Display [GX/GP]

Sets the scale display of an AI, DI, PI, AO, DO, or PID channel.

Syntax `SScaleIO, p1, p2, p3`
 p1 Channel number
 p2 Scale display position (Off, 1 to 10)
 p3 Number of scale divisions (4 to 12, C10)

Query `SScaleIO[, p1]?`

Example Display the channel 0001 scale at display position 1. Display four equally spaced main scale marks.
`SScaleIO, 0001, 1, 4`

Description

- You cannot set DI channels when the measurement mode is set to high speed.

SBarIO

Bar Graph Display

Sets the bar graph display of an AI, DI, PI, AO, DO, or PID channel.

Syntax `SBarIO, p1, p2, p3`
 p1 Channel number
 p2 Bar display base position
 Lower Lower
 Center Center
 Upper Upper
 p3 Number of scale divisions (4 to 12)

Query `SBarIO[, p1]?`

Example Display the measured values of channel 0001 on a bar graph with the center set as the base position (Center). Display four equally spaced main scale marks.
`SBarIO, 0001, Center, 4`

Description

- You cannot set DI channels when the measurement mode is set to high speed.

SPartialIO

Partial Expanded Display [GX/GP]

Sets the partial-expansion display of an AI, PI, or PID channel waveform.

Syntax `SPartialIO, p1, p2, p3, p4`
 p1 Channel number
 p2 Partial expanded On/Off (On, Off)
 p3 Partial expanded boundary position [%] (1 to 99)
 p4 Partial expanded boundary value (span lower limit + 1 digit to span upper limit - 1 digit)

Query `SPartialIO[, p1]?`

Example For channel 0001 whose measurement range is 0 to 1.0000 V, display the measured value of 0.7500 V at the 50% position.
`SPartialIO, 0001, On, 50, 7500`

Description

- You cannot set this on a "Skip" channel. p2 is fixed to Off.
- You cannot set this on a channel set to Log scale (/LG) (if p4 of SRangeAI is LogT1, LogT2, or LogT3). p2 is fixed to Off.
- If p2=Off, you cannot set p3 or subsequent parameters.
- P2=On can be specified when the difference between the span upper and lower limits is 2 digits or greater.

SBandIO

Color Scale Band

Sets the color scale band of an AI or PI channel.

Syntax `SBandIO, p1, p2, p3, p4, p5, p6, p7`
 p1 Channel number
 p2 Color scale band (Off, In, Out)
 p3 R value of the color scale band RGB colors (0 to 255)
 p4 G value of the color scale band RGB colors (0 to 255)
 p5 B value of the color scale band RGB colors (0 to 255)
 p6 Upper limit of the color scale band display (Span or scale lower limit to span or scale upper limit)
 For a channel set to Log scale (/LG) (if p4 of SRangeAI is LogT1, LogT2, or LogT3), specify p6 using exponential notation (e.g. 1.23E10, where the number of digits of the mantissa is as specified by p8 of the SRangeAI command).
 p7 Lower limit of the color scale band display (Span or scale lower limit to span or scale upper limit)
 For a channel set to Log scale (/LG) (if p4 of SRangeAI is LogT1, LogT2, or LogT3), specify p7 using exponential notation (e.g. 1.23E10, where the number of digits of the mantissa is as specified by p8 of the SRangeAI command).

Query `SBandIO[,p1]?`

Example For channel 0001, set a blue band in the range of -0.5000 to 1.0000.

```
SBandIO,0001,In,0,0,255,5000,10000
```

Description

- You cannot set this on a “Skip” channel. p2 is fixed to Off.
- If p2=Off, you cannot set p3 or subsequent parameters.
- For details on RGB values, see “Description” of the **SColorIO** command.

SAlmMarkIO

Alarm Mark

Sets the display of the marker that indicates the specified alarm position of an AI, DI, or PI channel.

Syntax `SAlmMarkIO,p1,p2,p3,p4,p5,p6,p7,p8,p9,p10,p11,p12,p13,p14,p15`

p1 Channel number

p2 Whether to display the alarm mark on the scale (Off, On)

p3 Alarm mark type

Alarm Display the default alarm mark

Fixed Display the mark with the specified color

p4 R value of the RGB mark colors for alarm 1 (0 to 255)

p5 G value of the RGB mark colors for alarm 1 (0 to 255)

p6 B value of the RGB mark colors for alarm 1 (0 to 255)

p7 R value of the RGB mark colors for alarm 2 (0 to 255)

p8 G value of the RGB mark colors for alarm 2 (0 to 255)

p9 B value of the RGB mark colors for alarm 2 (0 to 255)

p10 R value of the RGB mark colors for alarm 3 (0 to 255)

p11 G value of the RGB mark colors for alarm 3 (0 to 255)

p12 B value of the RGB mark colors for alarm 3 (0 to 255)

p13 R value of the RGB mark colors for alarm 4 (0 to 255)

p14 G value of the RGB mark colors for alarm 4 (0 to 255)

p15 B value of the RGB mark colors for alarm 4 (0 to 255)

Query `SAlmMarkIO[,p1]?`

Example Display the alarm marks for alarms 1 to 4 of channel 0001 in fixed colors red, brown, orange, and yellow, respectively.

```
SAlmMarkIO,0001,On,Fixed,255,0,0,165,42,42,255,165,0,255,255,0
```

Description

- For details on RGB values, see “Description” of the **SColorIO** command.
- You cannot set DI channels when the measurement mode is set to high speed.

SValueIO

Upper/Lower Limit Display Characters

Sets the upper/lower limit display characters of AI, DI, DO, or PID channel.

Syntax `SValueIO,p1,p2,p3`

p1 Channel number

p2 Lower limit display string (up to 8 characters, UTF-8)

p3 Upper limit display string (up to 8 characters, UTF-8)

Query `SValueIO[,p1]?`

Example For channel 0001, set the lower limit to “OFF” and the upper limit to “ON.”

```
SValueIO,0001,'OFF','ON'
```

SCalibIO

Calibration Correction

Sets the calibration correction for AI channels.

Disable Calibration Correction

Syntax `SCalibIO,p1,p2`
 p1 Channel number
 p2 Linearizer mode (Off)

Use Calibration Correction (Linearizer approximation, linearizer bias)

Syntax `SCalibIO,p1`
 p1 Channel number
 p2 Linearizer mode
 Appro Linearizer approximation
 Bias Linearizer bias
 p3 Number of set points (2 to 12)
 p4 Input value of set point 1
 p5 Output value of set point 1
 p6 Input value of set point 2
 p7 Output value of set point 2
 p8 Input value of set point 3
 p9 Output value of set point 3
 p10 Input value of set point 4
 p11 Output value of set point 4
 p12 Input value of set point 5
 p13 Output value of set point 5
 p14 Input value of set point 6
 p15 Output value of set point 6
 p16 Input value of set point 7
 p17 Output value of set point 7
 p18 Input value of set point 8
 p19 Output value of set point 8
 p20 Input value of set point 9
 p21 Output value of set point 9
 p22 Input value of set point 10
 p23 Output value of set point 10
 p24 Input value of set point 11
 p25 Output value of set point 11
 p26 Input value of set point 12
 p27 Output value of set point 12

Use Calibration Correction (Correction coefficient) (/AH)

Syntax `SCalibIO,p1,p2,p3,p4,p5,p6,p7,p8,p9,p10,p11,p12,p13,p14,p15,p16,p17,p18,p19p,20p,p21,p22,p23,p24,p25,p26,p27,p28,p29,p30,p31,p32,p33,p34,p35,p36,p37,p38,p39`
 p1 Channel number
 p2 Mode
 Correct Correction coefficient
 p3 Number of correction points (2 to 12)
 p4 Input value of uncorrected value 1
 p5 Instrument correction coefficient 1
 p6 Sensor correction coefficient 1
 p7 Input value of uncorrected value 2
 p8 Instrument correction coefficient 2
 p9 Sensor correction coefficient 2
 p10 Input value of uncorrected value 3
 p11 Instrument correction coefficient 3
 p12 Sensor correction coefficient 3
 p13 Input value of uncorrected value 4
 p14 Instrument correction coefficient 4
 p15 Sensor correction coefficient 4

p16 Input value of uncorrected value 5
 p17 Instrument correction coefficient 5
 p18 Sensor correction coefficient 5
 p19 Input value of uncorrected value 6
 p20 Instrument correction coefficient 6
 p21 Sensor correction coefficient 6
 p22 Input value of uncorrected value 7
 p23 Instrument correction coefficient 7
 p24 Sensor correction coefficient 7
 p25 Input value of uncorrected value 8
 p26 Instrument correction coefficient 8
 p27 Sensor correction coefficient 8
 p28 Input value of uncorrected value 9
 p29 Instrument correction coefficient 9
 p30 Sensor correction coefficient 9
 p31 Input value of uncorrected value 10
 p32 Instrument correction coefficient 10
 p33 Sensor correction coefficient 10
 p34 Input value of uncorrected value 11
 p35 Instrument correction coefficient 11
 p36 Sensor correction coefficient 11
 p37 Input value of uncorrected value 12
 p38 Instrument correction coefficient 12
 p39 Sensor correction coefficient 12

Query `SCalibIO[,p1]?`

Example Set three set points on channel 0001 (measurement range: 0 to 1.0000 V). Set the set points as follows: when the input value is 0 V, the output value is 0.0010 V; when the input value is 0.5000 V, the output value is 0.5020 V; when the input value is 1.0000 V, the output value is 0.9970 V.
`SCalibIO,0001,Appro,3,0,10,5000,5020,10000,9970`

Description

- If p2=Off, you cannot set p3 or subsequent parameters.
- You cannot specify set points beyond the number of points specified by p3.
- If the AI channel input type (p2 of [SRangeAI](#)) is set to Skip or DI, you cannot specify anything other than p2=Off.

SPresetAO

Sets the Preset Action

Sets the preset action of an AO channel.

Syntax `SPresetAO, p1, p2, p3, p4`
 p1 Channel number
 p2 Action at power-on (Last, Preset)
 Last Hold previous value
 Preset Output preset value
 p3 Action on error (Last, Preset)
 Last Hold previous value
 Preset Output preset value
 p4 Action on stop (Last, Preset)
 Last Hold previous value
 Preset Output preset value

Query `SPresetAO[, p1]?`

Example At power-on, replace the channel 0001 value with the preset value of 0.5.

`SPresetAO, 0001, Preset, 0.5`

Description

- You cannot use this command to configure settings while recording is in progress.
- You cannot use this command to configure settings while computation is in progress.
- “Action on stop” indicates a scanning stopped, math stopped, or re-transmission off condition.

SMathBasic

Math Action (/MT)

Sets the basic operation of math channels.

Syntax
GX/GP `SMathBasic, p1, p2, p3, p4, p5`
GM `SMathBasic, p1, p2, p3, p4, p5, p6, p7`
 p1 Indication on computation error
 +Over Display the computed value as +Over.
 -Over Display the computed value as -Over.
 p2 SUM and AVE computation when overflow data is detected
 Error Sets the computation result to computation error.
 Skip Discards the data that overflowed and continues the computation.
 Limit Computes by substituting upper or lower limit values in the data that overflowed.

- For channels that do not have linear scaling specified, the upper or lower limit of the measuring range
- For channels that have linear scaling specified, the scaling upper or lower limit

- For math channels, the specified span upper or lower limit.

p3 MAX, MIN, and P-P computation when overflow data is detected
 Over Computes using data that overflowed.
 Skip Discards the data that overflowed and continues the computation.

P4 START/STOP key action (GX/GP: Off, Start/Stop, Reset+Start/Stop) (GM: Off)
 Off Computation does not start even when recording starts.
 Start/Stop Computation starts when recording starts.
 Reset+Start/Stop Computation resets and starts when recording starts.

p5 PSUM over operation (GX/GP)
 Rotate Rotate
 Over Over

P5 START key action (Off, Start, Reset+Start) (GM)
 Off Recording starts but not computation.
 Start Computation starts when recording starts.
 Reset+Start Computation resets and starts when recording starts.

P6 STOP key action (Off, Stop)
 Off Recording stops but not computation.
 Stop Computation stops when recording stops.

p7 PSUM over operation (GM)
 Rotate Rotate
 Over Over

Query `SMathBasic?`

Example Set the indication on computation error to “+Over,” computation when overflow data is detected to “Skip,” and start computation when recording starts.
`SMathBasic, +Over, Skip, Skip, Start/Stop`

Description

- You cannot use this command to configure settings while recording is in progress.
- You cannot use this command to configure settings while computation is in progress.
- p5 and p6 are invalid parameters for the GX/GP.
- When the multi batch function (/BT) is enabled, p4 is fixed to Off.

SKConst**Constant (/MT)**

Sets a constant for use in computations.

Syntax SKConst, p1, p2
 p1 Constant number (1 to 100)
 p2 Value (–9.9999999E+29 to –1E–30,
 0, 1E–30 to 9.9999999E+29, eight
 significant digits)

Query SKConst[, p1]?

Example Set constant number 12 to 1.0000E–10.
 SKConst, 12, 1.0000E–10

Description

- You cannot use this command to configure settings while recording is in progress.
- You cannot use this command to configure settings while computation is in progress.

SRangeMath**Computation Expression (/MT)**

Sets the computation expression of a math channel.

Unused Channels

Syntax SRangeMath, p1, p2
 p1 Channel number
 p2 Computation expression on/off (Off)

Used Channels

Syntax SRangeMath, p1, p2, p3, p4, p5, p6, p7, p8
 p1 Channel number
 p2 Computation expression on/off (On)
 p3 Math channel type (Normal)
 P4 Expression (up to 120 characters, ASCII)
 p5 Decimal Place (0 to 5)
 p6 Span lower limit (–9999999 to 99999999)
 p7 Span upper limit (–9999999 to 99999999)
 p8 Unit (up to 6 characters, UTF-8)

Query SRangeMath[, p1]?

Example Set expression 0001+0002 in math channel 015. Set the measurement range is 0.0 to 100.0%.
 SRangeMath, 015, On, Normal, 0001+
 0002, 1, 0, 1000, '%'

Description

- You cannot use this command to configure settings while recording is in progress.
- You cannot use this command to configure settings while computation is in progress.
- A blank character string cannot be used in expressions.
- You cannot set the span upper and lower limits to the same value.

STlogMath**TLOG (/MT)**

Sets the TLOG of a math channel.

Syntax STlogMath, p1, p2, p3, p4, p5
 p1 Channel number
 p2 Timer Type
 Timer Timer
 MatchTimeTimer Match time timer
 p3 Timer number (1 to 12)
 P4 Sum scale (Off, /sec, /min, /hour)
 p5 Reset (On, Off)

Query STlogMath[, p1]?

Example Assign timer 2 to math channel 015. Set the sum scale to Off and disable reset.
 STlogMath, 015, Timer, 2, Off, Off

Description

- You cannot use this command to configure settings while computation is in progress.

SRolAveMath**Rolling Average (/MT)**

Sets rolling average on a math channel.

Syntax SRolAveMath, p1, p2, p3, p4
 p1 Channel number
 p2 Enable or disable (Off, On)
 p3 Sample interval (1 to 6s, 10s, 12s, 15s,
 20s, 30s, 1 to 6min, 10min, 12min, 15min,
 20min, 30min, 1h)
 P4 Number of samples (1 to 1500)

Query SRolAveMath[, p1]?

Example On math channel 015, take the rolling average of 30 data values over 1 minute intervals and use the results as the computed values.
 SRolAveMath, 015, On, 1min, 30

SAlarmMath

Alarm (/MT)

Sets the alarm of a math channel.

Do Not Set Alarms

Syntax SAlarmMath,p1,p2,p3
 p1 Channel number
 p2 Alarm number (1 to 4)
 p3 Alarm on or off (Off)

Do Not Output Alarms

Syntax SAlarmMath,p1,p2,p3,p4,p5,p6,p7
 p1 Channel number
 p2 Alarm number (1 to 4)
 p3 Alarm on or off (On)
 P4 Alarm type (H, L, TH, TL)
 p5 Alarm value (within the span range)
 p6 Detection (Off, On)
 p7 Output (Off)

Output Alarms

Syntax SAlarmMath,p1,p2,p3,p4,p5,p6,p7,p8
 p1 Channel number
 p2 Alarm number (1 to 4)
 p3 Alarm on or off (On)
 P4 Alarm type (H, L, TH, TL)
 p5 Alarm value (within the span range)
 p6 Detection (Off, On)
 p7 Output
 DO Output to a relay (DO channel)
 SW Output to an internal switch
 p8 Number
 If p7=DO Relay (DO channel) number
 If p7=SW Internal switch number (001 to 100)

Channel Using Logarithmic Math

Syntax SAlarmMath,p1,p2,p3,p4,p5,p6,p7,p8,p9
 p1 Channel number
 p2 Alarm number (1 to 4)
 p3 Alarm on or off (Off, On)
 p4 Alarm type (Off, H, L, TH, TL)
 p5 Alarm value exponent (100 to 999)
 p6 Alarm value mantissa (-16 to 16)
 p7 Detection (Off, On)
 p8 Output (Off, DO, SW)
 Off Do Not Output Alarms
 DO Output to a relay (DO channel)
 SW Output to an internal switch
 p9 Number
 If p8=DO Relay (DO channel) number
 If p8=SW Internal switch number (001 to 100)

Query SAlarmMath[,p1[,p2]]?

Example Set a high limit alarm (H) on alarm number 2 of math channel 015. Set the alarm value to 85.0. When an alarm occurs, output to the relay (DO channel) at number 0105.
 SAlarmMath,015,2,On,H,85.0,On,DO,0105

Description

- You cannot set this on a "Off" channel.
- If p3=Off, you cannot set p4 or subsequent parameters.
- If p7 (p8 for logarithmic math) = Off, you cannot set p8 (p9 for logarithmic math).
- You cannot set DO channels or internal switches whose output type is set to Manual as output destination numbers.

SAlmHysMath

Alarm Hysteresis (/MT)

Sets the alarm hysteresis for a math channel.

Syntax SAlmHysMath,p1,p2,p3
 p1 Channel number
 p2 Alarm number (1 to 4)
 p3 Hysteresis

Alarm Type	Hysteresis Range
H, L	0 to 100000

Channel Using Logarithmic Math

Syntax SAlmHysMath,p1,p2,p3,p4
 p1 Channel number
 p2 Alarm number (1 to 4)
 p3 Hysteresis exponent (100 to 999)
 p4 Hysteresis mantissa (-16 to 16)

Query SAlmHysMath[,p1[,p2]]?

Example Set a hysteresis on alarm 3 of math channel 015.
 SAlmHysMath,015,3,10

Description

- Hysteresis specified for delay high and low limit alarms (TH and TL) does not apply.

SAlmDlyMath

Alarm Delay Time (/MT)

Sets the alarm delay time for a math channel.

Syntax SAlmDlyMath,p1,p2,p3,p4
 p1 Channel number
 p2 Hour (0 to 24)
 p3 Minute (0 to 59)
 P4 Second (0 to 59)

Query SAlmDlyMath[,p1]?

Example Set the math channel 015 alarm delay time to 2 minutes 30 seconds.
 SAlmDlyMath,015,0,2,30

Description

- Set the delay time so that it is an integer multiple of the scan interval (**SScan** command).

S`TagMath`

Tag (/MT)

Sets the tag of a math channel.

Syntax `STagMath,p1,p2,p3`
p1 Channel number
p2 Tag (up to 32 characters, UTF-8)
p3 Tag number (up to 16 characters, UTF-8)

Query `STagMath[,p1]?`

Example Set the math channel 015 tag to "SYSTEM1" and the tag number to "TI002."
`STagMath,015,'SYSTEM1','TI002'`

S`ColorMath`

Channel Color (/MT)

Sets the color of a math channel.

Syntax `SColorMath,p1,p2,p3,p4`
p1 Channel number
p2 R value of RGB display colors (0 to 255)
p3 G value of RGB display colors (0 to 255)
p4 B value of RGB display colors (0 to 255)

Query `SColorMath[,p1]?`

Example Set the math channel 015 display color to red.
`SColorMath,015,255,0,0`

Description

- For details on RGB values, see "Description" of the [S`ColorIO`](#) command.

S`ZoneMath`

Waveform Display Zone (/MT)

Sets the waveform display zone of a math channel.

Syntax `SZoneMath,p1,p2,p3`
p1 Channel number
p2 Zone lower limit [%] (0 to 95)
p3 Zone upper limit [%] (5 to 100)

Query `SZoneMath[,p1]?`

Example Set the waveform zone of math channel 015 waveform to 0% to 30%.
`SZoneMath,015,0,30`

S`ScaleMath`

Scale Display (/MT) [GX/GP]

Sets the scale display of a math channel.

Syntax `SScaleMath,p1,p2,p3`
p1 Channel number
p2 Scale display position (Off, 1 to 10)
p3 Number of scale divisions (4 to 12, C10)

Query `SScaleMath[,p1]?`

Example Display the math channel 015 scale at display position 1. Display four equally spaced main scale marks.
`SScaleMath,015,1,4`

S`BarMath`

Bar Graph Display (/MT)

Sets the bar graph display of a math channel.

Syntax `SBarMath,p1,p2,p3`
p1 Channel number
p2 Bar display base position
Lower Lower
Center Center
Upper Upper
p3 Number of scale divisions (4 to 12)

Query `SBarMath[,p1]?`

Example Display the computed values of math channel 015 on a bar graph with the center set as the base position (Center). Display four equally spaced main scale marks.
`SBarMath,015,Center,4`

S`PartialMath`

Partial Expanded Display (/MT) [GX/GP]

Sets the partial expanded display of a math channel waveform.

Syntax `SPartialMath,p1,p2,p3,p4`
p1 Channel number
p2 Partial expanded On/Off (On, Off)
p3 Partial expanded boundary position [%] (1 to 99)
p4 Partial expanded boundary value

Query `SPartialMath[,p1]?`

Example For channel 015 whose measurement range is 0 to 1.0000 V, display the measured value of 0.7500 V at the 50% position.
`SPartialMath,015,On,50,7500`

Description

- You cannot set this on a "Off" channel. p2 is fixed to Off.
- If p2=Off, you cannot set p3 or subsequent parameters.
- P2=On can be specified when the difference between the span upper and lower limits is 2 digits or greater.
- You cannot use this command to configure settings on channels using logarithmic math.

SBandMath

Color Scale Band (/MT)

Sets the color scale band of a math channel.

Syntax `SBandMath, p1, p2, p3, p4, p5, p6, p7`
 p1 Channel number
 p2 Color scale band (Off, In, Out)
 p3 R value of the color scale band RGB colors (0 to 255)
 p4 G value of the color scale band RGB colors (0 to 255)
 p5 B value of the color scale band RGB colors (0 to 255)
 p6 Upper limit of the color scale band display (span lower limit to span upper limit)
 p7 Lower limit of the color scale band display (span lower limit to span upper limit)

Channel Using Logarithmic Math

Syntax `SBandMath, p1, p2, p3, p4, p5, p6, p7, p8, p9`
 p1 Channel number
 p2 Color scale band (Off, In, Out)
 p3 R value of the color scale band RGB colors (0 to 255)
 p4 G value of the color scale band RGB colors (0 to 255)
 p5 B value of the color scale band RGB colors (0 to 255)
 p6 Exponent of the lower limit of the color scale band display (span low limit to span high limit)
 p7 Mantissa of the lower limit of the color scale band display (span low limit to span high limit)
 p8 Exponent of the upper limit of the color scale band display (span low limit to span high limit)
 p9 Mantissa of the upper limit of the color scale band display (span low limit to span high limit)

Query `SBandMath[, p1]?`

Example For math channel 015, set a blue band in the range of -0.5000 to 1.0000.
`SBandMath, 015, In, 0, 0, 255, 5000, 10000`

Description

- You cannot set this on a "Off" channel. p2 is fixed to Off.
- If p2=Off, you cannot set p3 or subsequent parameters.
- For details on RGB values, see "Description" of the [SColorIO](#) command.

SAlmMarkMath

Alarm Mark (/MT)

Sets the display of the marker that indicates the specified alarm position of a math channel.

Syntax `SAlmMarkMath, p1, p2, p3, p4, p5, p6, p7, p8, p9, p10, p11, p12, p13, p14, p15`
 p1 Channel number
 p2 Whether to display the alarm mark on the scale (Off, On)
 p3 Alarm mark type
 Alarm Display the default alarm mark
 Fixed Display the mark with the specified color
 p4 R value of the RGB mark colors for alarm 1 (0 to 255)
 p5 G value of the RGB mark colors for alarm 1 (0 to 255)
 p6 B value of the RGB mark colors for alarm 1 (0 to 255)
 p7 R value of the RGB mark colors for alarm 2 (0 to 255)
 p8 G value of the RGB mark colors for alarm 2 (0 to 255)
 p9 B value of the RGB mark colors for alarm 2 (0 to 255)
 p10 R value of the RGB mark colors for alarm 3 (0 to 255)
 p11 G value of the RGB mark colors for alarm 3 (0 to 255)
 p12 B value of the RGB mark colors for alarm 3 (0 to 255)
 p13 R value of the RGB mark colors for alarm 4 (0 to 255)
 p14 G value of the RGB mark colors for alarm 4 (0 to 255)
 p15 B value of the RGB mark colors for alarm 4 (0 to 255)

Query `SAlmMarkMath[, p1]?`

Example Display the alarm marks for alarms 1 to 4 of math channel 015 in fixed colors red, brown, orange, and yellow, respectively.
`SAlmMarkMath, 015, On, Fixed, 255, 0, 0, 165, 42, 42, 255, 165, 0, 255, 255, 0`

Description

- For details on RGB values, see "Description" of the [SColorIO](#) command.

SRangeCom

Measurement Range (/MC)

Sets the measurement range of a communication channel.

Unused Channels

Syntax `SRangeCom, p1, p2`
 p1 Channel number
 p2 Enable or disable (Off)

Used Channels

Syntax `SRangeCom, p1, p2, p3, p4, p5, p6`
 p1 Channel number
 p2 Enable or disable (On)
 p3 Decimal Place (0 to 5)
 p4 Span lower limit (-9999999 to 9999999)
 p5 Span upper limit (-9999999 to 9999999)
 p6 Unit (up to 6 characters, UTF-8)

Query `SRangeCom[, p1]?`

Example Measure 0.00 to 100.00% on communication channel 025.
`SRangeCom, 025, On, 2, 0, 10000, ' %'`

Description

- You cannot use this command to configure settings while recording is in progress.
- You cannot use this command to configure settings while computation is in progress.
- If p2=Off, you cannot set p3 or subsequent parameters.
- You cannot set the span upper and lower limits to the same value.

SValueCom

Preset Operation (/MC)

Sets the preset operation of a communication channel.

Syntax `SValueCom, p1, p2, p3`
 p1 Channel number
 p2 Value at power-on (Preset, Last)
 p3 Preset value (-9.999999E+29 to -1E-30, 0, 1E-30 to 9.999999E+29)

Query `SValueCom[, p1]?`

Example At power-on, replace the communication channel 025 value with the preset value of 0.5.
`SValueCom, 025, Preset, 0.5`

SWDCom

Watchdog Timer (/MC)

Sets the watchdog timer of a communication channel.

Channels That Do Not Use Watchdog Timers

Syntax `SWDCom, p1, p2`
 p1 Channel number
 p2 Watchdog timer usage (Off)

Channels That Use Watchdog Timers

Syntax `SWDCom, p1, p2, p3, p4`
 p1 Channel number
 p2 Watchdog timer usage (On)
 p3 Watchdog timer (1 to 120) [s]
 p4 Value at timer expired (Preset, Last)

Query `SWDCom[, p1]?`

Example Set the watchdog timer of communication channel 025 to 60 seconds. Replace the communication channel 025 value with its preset value at watchdog timer expiration.
`SWDCom, 025, On, 60, Preset`

Description

- If p2=Off, you cannot set p3 or subsequent parameters.

SAlarmCom

Alarm (/MC)

Sets the alarm of a communication channel.

No Alarm Setting

Syntax `SAlarmCom, p1, p2, p3`
 p1 Channel number
 p2 Alarm number (1 to 4)
 p3 Alarm on or off (Off)

Do Not Output Alarms

Syntax `SAlarmCom, p1, p2, p3, p4, p5, p6, p7`
 p1 Channel number
 p2 Alarm number (1 to 4)
 p3 Alarm on or off (On)
 p4 Alarm type (H, L, TH, TL)
 p5 Alarm value (within the span range)
 p6 Detection (Off, On)
 p7 Output (Off)

Output Alarms

Syntax `SAlarmCom, p1, p2, p3, p4, p5, p6, p7, p8`
 p1 Channel number
 p2 Alarm number (1 to 4)
 p3 Alarm on or off (On)
 p4 Alarm type (H, L, TH, TL)
 p5 Alarm value (within the span range)
 p6 Detection (Off, On)
 p7 Output (Off)

DO	Output to a relay (DO channel)
SW	Output to an internal switch

p8	Number	
	If p7=DO	Relay (DO channel) number
	If p7=SW	Internal switch number (001 to 100)

Query SAlarmCom[,p1[,p2]]?

Example Set a high limit alarm (H) on alarm number 2 of communication channel 025. Set the alarm value to 85.0%. When an alarm occurs, output to the relay (DO channel) at number 0105.
SAlarmCom,025,2,On,H,850,On,DO,0105

Description

- You cannot set this on a “Off” communication channel.
- If p3=Off, you cannot set p4 or subsequent parameters.
- If p7=Off, you cannot set p8.
- You cannot set DO channels or internal switches whose output type is set to Manual as output destination numbers.

SAlmHysCom

Alarm Hysteresis (/MC)

Sets the alarm hysteresis for a communication channel.

Syntax SAlmHysCom,p1,p2,p3

p1	Channel number
p2	Alarm number (1 to 4)
p3	Hysteresis

Alarm Type	Hysteresis Range
H, L	0 to 100000

Query SAlmHysCom[,p1[,p2]]?

Example Set a hysteresis on alarm 3 of communication channel 025.
SAlmHysCom,025,3,10

Description

- Hysteresis specified for delay high and low limit alarms (TH and TL) does not apply.

SAlmDlyCom

Alarm Delay Time (/MC)

Sets the alarm delay time for a communication channel.

Syntax SAlmDlyCom,p1,p2,p3,p4

p1	Channel number
p2	Hour (0 to 24)
p3	Minute (0 to 59)
p4	Second (0 to 59)

Query SAlmDlyCom[,p1]?

Example Set the communication channel 025 alarm delay time to 2 minutes 30 seconds.
SAlmDlyCom,025,0,2,30

Description

- Set the delay time so that it is an integer multiple of the scan interval (**SScan** command).

STagCom

Tag (/MC)

Sets the tag of a communication channel.

Syntax STagCom,p1,p2,p3

p1	Channel number
p2	Tag (up to 32 characters, UTF-8)
p3	Tag number (up to 16 characters, ASCII)

Query STagCom[,p1]?

Example Set the communication channel 025 tag to “SYSTEM1” and the tag number to “TI002.”
STagCom,025,'SYSTEM1','TI002'

SColorCom

Channel Color (/MC)

Sets the color of a communication channel.

Syntax SColorCom,p1,p2,p3,p4

p1	Channel number
p2	R value of RGB display colors (0 to 255)
p3	G value of RGB display colors (0 to 255)
p4	B value of RGB display colors (0 to 255)

Query SColorCom[,p1]?

Example Set the communication channel 025 display color to red.
SColorCom,025,255,0,0

Description

- For details on RGB values, see “Description” of the **SColorIO** command.

SZoneCom

Waveform Display Zone (/MC)

Sets the waveform display zone of a communication channel.

Syntax SZoneCom,p1,p2,p3

p1	Channel number
p2	Zone lower limit [%] (0 to 95)
p3	Zone upper limit [%] (5 to 100)

Query SZoneCom[,p1]?

Example Set the waveform zone of communication channel 025 waveform to 0% to 30%.
SZoneCom,025,0,30

SScaleCom

Scale Display (/MC) [GX/GP]

Sets the scale display of a communication channel.

Syntax SScaleCom,p1,p2,p3

p1	Channel number
p2	Scale display position (Off, 1 to 10)
p3	Number of scale divisions (4 to 12, C10)

Query SScaleCom[,p1]?

Example Display the communication channel 025 scale at display position 1. Display four equally spaced main scale marks.
SScaleCom,025,1,4

SBarCom

Bar Graph Display (/MC)

Sets the bar graph display of a communication channel.

Syntax SBarCom, p1, p2, p3
 p1 Channel number
 p2 Bar display base position
 Lower Lower
 Center Center
 Upper Upper
 p3 Number of scale divisions (4 to 12)

Query SBarCom[, p1]?

Example Display the values of communication channel 025 on a bar graph with the center set as the base position (Center). Display four equally spaced main scale marks.
 SBarCom, 025, Center, 4

SPartialCom

Partial Expanded Display (/MC) [GX/GP]

Sets the partial expanded display of a communication channel waveform.

Syntax SPartialCom, p1, p2, p3, p4
 p1 Channel number
 p2 Partial expanded On/Off (On, Off)
 p3 Partial expanded boundary position [%] (1 to 99)
 p4 Partial expanded boundary value

Query SPartialCom[, p1]?

Example For channel 025 whose measurement range is 0 to 1.0000 V, display the measured value of 0.7500 V at the 50% position.
 SPartialCom, 025, On, 50, 7500

Description

- You cannot set this on a "Off" channel. p2 is fixed to Off.
- If p2=Off, you cannot set p3 or subsequent parameters.
- P2=On can be specified when the difference between the span upper and lower limits is 2 digits or greater.

SBandCom

Color Scale Band (/MC)

Sets the color scale band of a communication channel.

Syntax SBandCom, p1, p2, p3, p4, p5, p6, p7
 p1 Channel number
 p2 Color scale band (Off, In, Out)
 p3 R value of the color scale band RGB colors (0 to 255)
 p4 G value of the color scale band RGB colors (0 to 255)
 p5 B value of the color scale band RGB colors (0 to 255)
 p6 Upper limit of the color scale band display (span lower limit to span upper limit)
 p7 Lower limit of the color scale band display (span lower limit to span upper limit)

Query SBandCom[, p1]?

Example For communication channel 025, set a blue band in the range of -0.5000 to 1.0000.
 SBandCom, 025, In, 0, 0, 255, 5000, 10000

Description

- You cannot set this on a "Off" channel. p2 is fixed to Off.
- If p2=Off, you cannot set p3 or subsequent parameters.
- For details on RGB values, see "Description" of the [SColorIO](#) command.

SAlmMarkCom

Alarm Mark (/MC)

Sets the display of the marker that indicates the specified alarm position of a communication channel.

Syntax SAlmMarkCom, p1, p2, p3, p4, p5, p6, p7, p8, p9, p10, p11, p12, p13, p14, p15
 p1 Channel number
 p2 Whether to display the alarm mark on the scale (Off, On)
 p3 Alarm mark type
 Alarm Display the default alarm mark
 Fixed Display the mark with the specified color
 p4 R value of the RGB mark colors for alarm 1 (0 to 255)
 p5 G value of the RGB mark colors for alarm 1 (0 to 255)
 p6 B value of the RGB mark colors for alarm 1 (0 to 255)
 p7 R value of the RGB mark colors for alarm 2 (0 to 255)
 p8 G value of the RGB mark colors for alarm 2 (0 to 255)
 p9 B value of the RGB mark colors for alarm 2 (0 to 255)
 p10 R value of the RGB mark colors for alarm 3 (0 to 255)
 p11 G value of the RGB mark colors for alarm 3 (0 to 255)
 p12 B value of the RGB mark colors for alarm 3 (0 to 255)
 p13 R value of the RGB mark colors for alarm 4 (0 to 255)
 p14 G value of the RGB mark colors for alarm 4 (0 to 255)
 p15 B value of the RGB mark colors for alarm 4 (0 to 255)

Query SAlmMarkCom[, p1]?

Example Display the alarm marks for alarms 1 to 4 of communication channel 025 in fixed colors red, brown, orange, and yellow, respectively.
 SAlmMarkCom, 025, On, Fixed, 255, 0, 0, 165, 42, 42, 255, 165, 0, 255, 255, 0

Description

- For details on RGB values, see "Description" of the [SColorIO](#) command.

S-CalibUseCom

Calibration Correction Use/Not

Sets whether to use Calibration Correction of communication channels

Syntax S-CalibUseCom,p1,p2

p1 Channel number
p2 Use/Not
Off Not Use
On Use

Query S-CalibUseCom[,p1]?

Example Set the Calibration Correction of channel number 001 to use.

S-CalibUseCom,001,On

Description

- There is a limitation on the number of channels that p2 can be set to On.

Model	GX10 GP10	GX20-1 GP20-1 GM10-1	GX20-2 GP20-2 GM10-2
Number of channels that can be set to On	50	150	300

- If p2=Off in the communication channel on/off setting (SRangeCom), p2 is fixed to Off.
- For communication channels, refer to 2.3.2 Parameter Notation and Range on page 2-12.
- You cannot use this command to configure settings while recording is in progress..

S-CalibCom

Calibration Correction

Sets the calibration correction for communication channels.

Disable Calibration Correction

Syntax S-CalibCom,p1,p2

p1 Channel number
p2 Linearizer mode (Off)

Use Calibration Correction (Linearizer approximation, linearizer bias)

Syntax S-CalibCom,p1p1,p2,p3,p4,p5,p6,p7,p8,p9,p10,p11,p12,p13,p14,p15,p16,p17,p18,p19p,20p,p21,p22,p23,p24,p25,p26,p27

p1 Channel number
p2 Linearizer mode
Appro Linearizer approximation
Bias Linearizer bias

p3 Number of set points (2 to 12)
p4 Input value of set point 1
p5 Output value of set point 1
p6 Input value of set point 2
p7 Output value of set point 2
p8 Input value of set point 3
p9 Output value of set point 3
p10 Input value of set point 4
p11 Output value of set point 4
p12 Input value of set point 5
p13 Output value of set point 5
p14 Input value of set point 6
p15 Output value of set point 6

p16 Input value of set point 7
p17 Output value of set point 7
p18 Input value of set point 8
p19 Output value of set point 8
p20 Input value of set point 9
p21 Output value of set point 9
p22 Input value of set point 10
p23 Output value of set point 10
p24 Input value of set point 11
p25 Output value of set point 11
p26 Input value of set point 12
p27 Output value of set point 12

Use Calibration Correction (Correction coefficient) (/AH)

Syntax S-CalibCom,p1,p2,p3,p4,p5,p6,p7,p8,p9,p10,p11,p12,p13,p14,p15,p16,p17,p18,p19p,20p,p21,p22,p23,p24,p25,p26,p27,p28,p29,p30,p31,p32,p33,p34,p35,p36,p37,p38,p39

p1 Channel number
p2 Mode
Correct Correction coefficient
p3 Number of correction points (2 to 12)
p4 Input value of uncorrected value 1
p5 Instrument correction coefficient 1
p6 Sensor correction coefficient 1
p7 Input value of uncorrected value 2
p8 Instrument correction coefficient 2
p9 Sensor correction coefficient 2
p10 Input value of uncorrected value 3
p11 Instrument correction coefficient 3
p12 Sensor correction coefficient 3
p13 Input value of uncorrected value 4
p14 Instrument correction coefficient 4
p15 Sensor correction coefficient 4
p16 Input value of uncorrected value 5
p17 Instrument correction coefficient 5
p18 Sensor correction coefficient 5
p19 Input value of uncorrected value 6
p20 Instrument correction coefficient 6
p21 Sensor correction coefficient 6
p22 Input value of uncorrected value 7
p23 Instrument correction coefficient 7
p24 Sensor correction coefficient 7
p25 Input value of uncorrected value 8
p26 Instrument correction coefficient 8
p27 Sensor correction coefficient 8
p28 Input value of uncorrected value 9
p29 Instrument correction coefficient 9
p30 Sensor correction coefficient 9
p31 Input value of uncorrected value 10
p32 Instrument correction coefficient 10
p33 Sensor correction coefficient 10
p34 Input value of uncorrected value 11
p35 Instrument correction coefficient 11
p36 Sensor correction coefficient 11
p37 Input value of uncorrected value 12
p38 Instrument correction coefficient 12
p39 Sensor correction coefficient 12

Query S-CalibIO[,p1]?

2.4 Setting Commands

Example Set three set points on communication channel 001 (measurement range: 0 to 100.0). Set the set points as follows: when the input value is 0.0, the output value is 0.1; when the input value is 50.0, the output value is 50.2; when the input value is 100.0, the output value is 99.7.

```
SAlibCom,001,Appro,3,0,1,50,502,1000,997
```

Description

- If p2=Off, you cannot set p3 or subsequent parameters.
- If calibration correction use on/off (p2 of the SAlibUseCom command) is set to Off, p2 is fixed to Off.
- You cannot specify set points beyond the number of points specified by p3.
- The correction value is not affected by the range span.
It is valid in the range of -9999999 to 99999999.

SAlmLimit

Rate-of-Change Alarm Interval

Sets the rate-of-change interval of the rate-of-change alarm.

Syntax SAlmLimit,p1,p2
p1 Interval for the low limit on rate-of-change alarm
1 to 32 Integer multiple of the scan interval
p2 Interval for the high limit on rate-of-change alarm
1 to 32 Integer multiple of the scan interval

Query SAlmLimit?

Example Set the intervals for the low limit on rate-of-change alarm and high limit on rate-of-change alarm to 10 times and 20 times the scan interval, respectively.
SAlmLimit,10,20

Description

- You cannot use this command to configure settings while recording is in progress.
- You cannot use this command to configure settings while computation is in progress.

SIndivAlmACK

Individual Alarm ACK

Enables or disables the individual alarm ACK function.

Syntax SIndivAlmACK,p1
p1 Enable or disable (Off, On)

Query SIndivAlmACK?

Example Enable the individual alarm ACK function.
SIndivAlmACK,On

SAlmSts

Alarm Display Hold/Nonhold

Sets the alarm display hold/nonhold operation.

Syntax SAlmSts,p1
p1 Operation
Hold
NonHold

Query SAlmSts?

Example Hold the alarm display until an alarm ACK operation.
SAlmSts,Hold

Description

- You cannot use this command to configure settings while recording is in progress.
- You cannot use this command to configure settings while computation is in progress.
- If the individual alarm ACK is enabled (SIndivAlmACK command), p1 is fixed to Hold.

SAlmACKCmt

Alarm ACK Comment Input (/AS)

Enables or disables alarm ACK comment input.

Syntax SAlmACKCmt,p1
p1 Enable or disable
On Enable (displays a comment input dialog box when acknowledging an alarm)
Off Disable

Query SAlmACKCmt?

Example Enable the comment input function when acknowledging alarms.
SAlmACKCmt,On

SFixedAlmACKCmt

Fixed ACK Comment (/AS)

Sets a fixed comment that is input when an alarm is acknowledged.

Syntax SFixedAlmACKCmt,p1
p1 Fixed ACK comment number (1 to 10)
p2 Comment string (up to 50 characters, UTF-8)

Query SFixedAlmACKCmt?

Example Assign "FIXED ACK COMMENT" to fixed comment number 5.
SFixedAlmACKCmt,5,'FIXED ACK COMMENT'

STimer

Timer

Sets a timer.

Do Not Use Timers

Syntax STimer,p1,p2
p1 Timer number (1 to 12)
p2 Timer type (Off)

Relative Timer

Syntax `STimer, p1, p2, p3, p4, p5, p6`
 p1 Timer number (1 to 12)
 p2 Timer type (Relative)
 p3 Interval: Days (0 to 31)
 P4 Interval: Hours (HH) (00 to 23)
 p5 Interval: Minutes (MM) (00 to 59)
 p6 Reset on Math start (Off, On)

Absolute Timer

Syntax `STimer, p1, p2, p3, p4, p5`
 p1 Timer number (1 to 12)
 p2 Timer type (Absolute)
 p3 Interval (1min, 2min, 3min, 4min, 5min, 6min, 10min, 12min, 15min, 20min, 30min, 1h, 2h, 3h, 4h, 6h, 8h, 12h, 24h)
 P4 Reference time: Hours (HH) (00 to 23)
 p5 Reference time: Minutes (MM) (00 to 59)

Query `STimer[, p1]?`

Example Set timer number 2 to relative timer at 6 hours 30 minutes. Reset the timer when computation starts.

`STimer, 2, Relative, 0, 6, 30, On`

Description

- You cannot use this command to configure settings while recording is in progress.
- You cannot use this command to configure settings while computation is in progress.
- If p2=Off, you cannot set p3 or subsequent parameters.
- If p2=Relative and p3=0, you cannot set "00:00" (for p4 and p5).

SMatchTimer**Match Time Timer**

Sets a match time timer.

Do Not Use Match Time Timers

Syntax `SMatchTimer, p1, p2`
 p1 Match time timer number (1 to 12)
 p2 Type (Off)

Match Time Timer That Synchronizes Once a Year

Syntax `SMatchTimer, p1, p2, p3, p4, p5, p6, p7`
 p1 Match time timer number (1 to 12)
 p2 Type (Year)
 p3 Start time: Month (Jan, Feb, Mar, Apr, May, Jun, Jul, Aug, Sep, Oct, Nov, Dec)
 P4 Start time: Day (1 to 31, depends on the month)
 p5 Interval: Hours (HH) (00 to 23)
 p6 Interval: Minutes (MM) (00 to 59)
 p7 Timer action
 Single Single shot
 Repeat Repeat

Match Time Timer That Synchronizes Once a Month

Syntax `SMatchTimer, p1, p2, p3, p4, p5, p6`
 p1 Match time timer number (1 to 12)
 p2 Type (Month)

p3 Start time: Day (1 to 28)
 P4 Interval: Hours (HH) (00 to 23)
 p5 Interval: Minutes (MM) (00 to 59)
 p6 Timer action
 Single Single shot
 Repeat Repeat

Match Time Timer That Synchronizes Once a Week

Syntax `SMatchTimer, p1, p2, p3, p4, p5, p6`
 p1 Match time timer number (1 to 12)
 p2 Type (Week)
 p3 Start time: Day of week
 Sun
 Mon
 Tue
 Wed
 Thu
 Fri
 Sat
 P4 Interval: Hours (HH) (00 to 23)
 p5 Interval: Minutes (MM) (00 to 59)
 p6 Timer action
 Single Single shot
 Repeat Repeat

Match Time Timer That Synchronizes Once a Day

Syntax `SMatchTimer, p1, p2, p3, p4, p5`
 p1 Match time timer number (1 to 12)
 p2 Type (Day)
 p3 Interval: Hours (HH) (00 to 23)
 P4 Interval: Minutes (MM) (00 to 59)
 p5 Timer action
 Single Single shot
 Repeat Repeat

Query `SMatchTimer[, p1]?`

Example Sets match time timer number 2 to a timer that operates on 21 hours 30 minutes on April 17 every year.
`SMatchTimer, 2, Year, Apr, 17, 21, 30, Repeat`

Description

- You cannot use this command to configure settings while recording is in progress.
- You cannot use this command to configure settings while computation is in progress.
- If p2=Off, you cannot set p3 or subsequent parameters.

SEventAct**Event Action**

Sets an event action.

Syntax `SEventAct, p1, p2, p3, p4, p5, p6, p7`
`SEventAct, p1, p2, p3, p4, p5, p6, p7, p8`
`SEventAct, p1, p2, p3, p4, p5, p6, p7, p8, p9`
`SEventAct, p1, p2, p3, p4, p5, p6, p7, p8, p9, p10`
`SEventAct, p1, p2, p3, p4, p5, p6, p7, p8, p9, p10, p11`

2.4 Setting Commands

- p1 Event action number (1 to 50)
- p2 Type (Off, On)
- p3 Event type (see the table below)
- p4 Source element number (see the table below)
- p5 Event details (see the table below)
- p6 Operation mode (see the table below)
- p7 Action type (see the table below)
- p8 Source element number (see the table below)
- p9 Action detail 1 (see the table below)
- p10 Action detail 2 (see the table below)
- p11 Action detail 3 (see the table below)

p3 Event Type	Value	P4 Source Element Number	p5 Event details	p6 Operation mode
Internal Switch	SW	1 to 100	-	Rising, Falling, Both
Remote control input	DI	Channel number	-	Rising, Falling, Both
Relay (DO channel)	DO	Channel number	-	Rising, Falling, Both
Alarm (I/O channel)	AlarmIO	Channel number	1 to 4	Rising, Falling, Both
Alarm (math channel)	AlarmMath	Channel number	1 to 4	Rising, Falling, Both
Alarm (communication channel)	AlarmCom	Channel number	1 to 4	Rising, Falling, Both
Alarm	AlarmAll	-	-	Rising, Falling, Both
Device status	Status	-	Memory (Record) Math (Math)	Rising, Falling, Both
Device status ¹	Status	-	UserLock (User lock out)	
Device status [GX/GP] ¹	Status	-	Login (When logged in)	
Device status	Status	-	MemMediaErr (Memory/Media error) MeasureErr (Measurement error) CommErr (Communication error)	
Timer	Timer	1 to 12	-	Edge
Match time timer	MatchTimeTimer	1 to 12	-	Edge
User function	User function	1 or 2	-	Edge

1 Valid when the advanced security function (/AS) is enabled.

Conditions p6	p7 Action Type	Value	p8 Source Element Number	p9 Action Detail 1	p10 Action Detail 2	p11 Action Detail 3
Rising, Falling, Edge	Recording	Memory	-	Start, Stop	-	ALL, batch group number ⁴
	Math (math channel)	Math	-	Start, Stop, Reset	-	-
	Display rate switch [GX/GP]	RateChange	1, 2	Reset	-	ALL, batch group number ⁴
	Flag	Flag	1 to 20	-	-	-
	Manual sample	ManualSample	-	-	-	-
	DO output ¹	DO	Channel number	Off, On	-	-
	Output to an internal switch ²	SW	Channel number	Off, On	-	-
	Alarm ACK [GX/GP]	AlarmACK	-	-	-	-
	Snapshot [GX/GP]	Snapshot	-	-	-	-
	Time adjustment	TimeAdjust	-	-	-	-
	Display data save	SaveDisplay	-	-	-	ALL, batch group number ⁴
	Event data save	SaveEvent	1	-	-	ALL, batch group number ⁴
	Event trigger ³	Trigger	1, 2	-	-	-
	Message	Message	1 to 100	All, Select	Display group number ⁴	Batch group number ⁴
	Display group change [GX/GP]	GroupChange	Display group number ⁴	-	-	Batch group number ⁴
Relative timer reset	TimerReset	1 to 12	-	-	-	
Settings load	ConfigLoad	1 to 10	-	-	-	
Settings save [GM]	ConfigSave	1 to 10	-	-	-	
Favorite screen display [GX/GP]	PlayList	1 to 20	-	-	-	
Pattern file load ⁵	ProgPatLoad	1 to 10	-	-	-	
Both	Recording start/stop	MemoryStartStop	-	-	-	ALL, batch group number ⁴
	Math start/stop	MathStartStop	-	-	-	-
	Display rate switch 1/2 [GX/GP]	RateChange1_2	-	-	-	-
	Flag On/Off	FlagOn_Off	1 to 20	-	-	-
	DO On/Off ¹	DOOn_Off	Channel number	-	-	-
	Internal switch on/off ²	SWOn_Off	Channel number	-	-	-

- 1 Can be output only to DO whose type is set to Manual.
- 2 Can be output only to SW whose type is set to Manual.
- 3 Valid when the advanced security function (/AS) is disabled.
- 4 For the setting range, see section 2.3.2, "Parameter Notation and Range."
- 5 This is valid only for the program control function (/PG).

Query SEventAct[,p1]?

Invalid parameters are returned as blanks in queries.

Example Execute memory start on the rising edge of the remote control input (channel 0101). Use event action number 2.

```
SEventAct,2,On,DI,0101,,Rising,Memory,,Start
```

Description

- There are limitations to event and action combinations. For details, see section 1.14 in the *Model GX10/GX20/GP10/GP20 Paperless Recorder User's Manual* (IM 04L51B01-01EN) or section 2.15, "Configuring the Event Action Function," in the *Data Acquisition System GM User's Manual* (IM 04L55B01-01EN).
- Write only delimiters (commas) for irrelevant parameters (invalid even if a value is specified).
- Event type "DI" is the channel of the DI module that has been set to remote module (**SModeDI** command).
- You can specify p3 = Status and p6 = Both when an item that can be specified as an action (flag, DO channel, or internal switch) is valid.
- Math channel and flag are an option (/MT).
- Communication channels are an option (/MC).

SReport**Report Type (/MT)**

Sets the type of report to create.

No Reports

Syntax SReport,p1
p1 Type (Off)

Hourly and Daily Reports

Syntax SReport,p1,p2
p1 Type (Hour+Day)
p2 Time to create reports: Hour (HH) (00 to 23)

Daily and Weekly Reports

Syntax SReport,p1,p2,p3
p1 Type (Day+Week)
p2 Day to create reports (Mon, Tue, Wed, Thu, Fri, Sat, Sun)
p3 Time to create reports: Hour (HH) (00 to 23)

Daily and Monthly Reports

Syntax SReport,p1,p2,p3
p1 Type (Day+Month)
p2 Day to create reports (1 to 28)
p3 Time to create reports: Hour (HH) (00 to 23)

Batch Reports

Syntax SReport,p1,p2
p1 Type (Batch)
p2 Recording interval (2min, 3min, 4min, 5min, 10min, 15min, 30min, 1h)

Day Custom Reports

Syntax SReport,p1,p2,p3,p4,p5
p1 Type (Custom)
p2 Recording interval (2min, 3min, 4min, 5min, 10min, 15min, 30min, 1h)
p3 File creation interval (4h, 6h, 8h, 12h, 24h)
p4 Time to create reports: Hour (HH) (00 to 23)
p5 Time to create reports: Minute (MM) (00 to 59)

Query SReport[,p1]?

Example Create daily reports at 09:00 every day and monthly reports at 09:00 on the first day of each month.

SReport,Day+Month,1,09

Description

- You cannot use this command to configure settings while recording is in progress.
- You cannot use this command to configure settings while computation is in progress.
- If p1=Off, you cannot set p2 or subsequent parameters.

SRepData

Report Data (/MT)

Sets the data type and file type of reports.

Syntax `SRepData, p1, p2, p3, p4, p5, p6`
 p1 Data type 1 (Max, Min, Ave, Sum, Inst)
 p2 Data type 2 (Off, Max, Min, Ave, Sum, Inst)
 p3 Data type 3 (Off, Max, Min, Ave, Sum, Inst)
 p4 Data type 4 (Off, Max, Min, Ave, Sum, Inst)
 p5 Data type 5 (Off, Max, Min, Ave, Sum, Inst)
 Off No
 Max Maximum value
 Min Minimum value
 Ave Average value
 Sum Integrated value
 Inst Instantaneous value
 p6 File type
 Combine 1 file
 Separate Separate

Query `SRepData?`

Example Record the maximum, minimum, and average values in daily and monthly reports. Generate the daily and monthly reports in a single file.
`SRepData, Max, Min, Ave, Off, Combine`

Description

- You cannot use this command to configure settings while recording is in progress.
- You cannot use this command to configure settings while computation is in progress.

SRepTemp

Report Output (/MT)

Sets the report output mode.

Syntax `SRepTemp, p1, p2, p3`
 p1 EXCEL template
 Off Disabled
 On Enabled
 p2 PDF output (Off, On)
 p3 Printer output (Off, On)

Query `SRepTemp?`

Example Generate reports that use the Excel template.
`SRepTemp, On, Off, Off`

Description

- You cannot use this command to configure settings while recording is in progress.
- You cannot use this command to configure settings while computation is in progress.

SDigitalSign

Electronic Signature Inclusion (/MT)

Sets whether to include an electronic signature in report template output PDF files.

Syntax `SDigitalSign, p1, p2`
 p1 Signature target (PDF)
 p2 Electronic signature inclusion (Off, On)

Query `SDigitalSign[p1]?`

Example Include an electronic signature in report template output PDF files.
`SDigitalSign, PDF, On`

Description

- You cannot use this command to configure settings while recording is in progress.
- You cannot use this command to configure settings while computation is in progress.

SRepCh

Report Channel (/MT)

Assigns a channel to a report channel.

Not Assign a Channel

Syntax `SRepCh, p1, p2`
 p1 Report Channel Number
 p2 Usage (Off)

Assign a Channel

Syntax `SRepCh, p1, p2, p3, p4`
 p1 Report Channel Number
 p2 Usage
 IO I/O channel
 Math Math channel
 Com Communication channel
 p3 Channel number
 p4 Sum scale (Off, /sec, /min, /hour, /day)

Query `SRepCh[, p1]?`

Example Assign I/O channel 0002 to report channel 1. Set the sum scale to Off.
`SRepCh, 001, IO, 0002, Off`

Description

- You cannot use this command to configure settings while recording is in progress.
- You cannot use this command to configure settings while computation is in progress.
- If p2=Off, you cannot set p3 or subsequent parameters.
- Communication channels are an option (/MC).
- If the measurement mode is dual interval, the number of channels is halved.
- If the measurement mode is set to high speed or dual interval, and the scan interval is 50 ms or less, the number of channels must be within their limits.

SRepBatchInfo

Batch information output (/MT)

Sets the batch information output.

Syntax `SRepBatchInfo, p1`
 p1 Batch information output (Off, On)
 Off Disabled
 On Enabled

Query `SRepBatchInfo?`

Example Output batch information.
`SRepBatchInfo, On`

Description

- You cannot use this command to configure settings while recording is in progress.
- You cannot use this command to configure settings while computation is in progress.

SLcd

LCD [GX/GP]

Sets the brightness and backlight saver of the LCD.

Syntax `SLcd, p1, p2, p3, p4`
 p1 Brightness (1 to 6)
 p2 Backlight saver mode
 Off Not used
 Dimmer Dimmer
 TimeOff Off
 p3 Backlight saver saver time (1min, 2min, 5min, 10min, 30min, 1h)
 p4 Backlight saver restore
 Key+Touch Key or touchscreen
 Key+Touch+Alarm Key, touchscreen, or alarm

Query `SLcd?`

Example Set the LCD brightness to 3 and the screen backlight saver type to DIMMER. Set the amount time of until the GX/GP switches to saver mode to 5 minutes and the event that causes the GX/GP to return from saver mode to the pressing of a key and tapping of the touchscreen.
`SLcd, 3, Dimmer, 5min, Key+Touch`

Description

- p3 and subsequent parameters are valid when p2=Off.

SViewAngle

View Angle [GX/GP]

Set the view angle.

Syntax `SViewAngle, p1`
 p1 View Angle
 Upper Easy to view from above
 Lower Easy to view from below

Query `SViewAngle?`

Example Set the view angle so that it is easy to view from above.
`SViewAngle, Upper`

Description

- This command is valid for the GX10/GP10.

SBackColor

Screen Background Color [GX/GP]

Sets the screen background color.

Syntax `SBackColor, p1, p2, p3`
 p1 R value of RGB background colors (0 to 255)
 p2 G value of RGB background colors (0 to 255)
 p3 B value of RGB background colors (0 to 255)

Query `SBackColor?`

Example Set the background color to black.
`SBackColor, 0, 0, 0`

Description

- For details on RGB values, see "Description" of the [SColorIO](#) command.

SGrpChange

Automatic Group Switching Time [GX/GP]

Sets the time for automatically switching between display groups.

Syntax `SGrpChange, p1`
 p1 Automatic group switching time (5s, 10s, 20s, 30s, 1min)

Query `SGrpChange?`

Example Set the switching time to 1 minute.
`SGrpChange, 1min`

SAutoJump

Jump Default Display Operation [GX/GP]

Sets the amount of time that must elapse until the GX/GP returns to the specified screen (standard screen) when there is no user interaction.

Syntax `SAutoJump, p1`
 p1 Jump default display operation (Off, 1min, 2min, 5min, 10min, 20min, 30min, 1h)

Query `SAutoJump?`

Example Set the automatic return time to 5 minutes.
`SAutoJump, 5min`

S`CalFormat`

Calendar Display Format [GX/GP]

Sets the calendar display format.

Syntax `SCalFormat,p1`
p1 1st weekday (Sun, Mon)

Query `SCalFormat?`

Example Set the first weekday to Monday.
`SCalFormat,Mon`

S`BarDirect`

Bar Graph Display Direction [GX/GP]

Sets the bar graph display direction.

Syntax `SBarDirect,p1`
p1 Direction
Horizontal Horizontal
Vertical Vertical

Query `SBarDirect?`

Example Display bar graphs horizontally.
`SBarDirect,Horizontal`

S`ChgMonitor`

Value Modification from the Monitor

Enables or disables the feature that allows values to be changed from the monitor.

Syntax `SChgMonitor,p1`
p1 Disable or enable (Off, On)

Query `SChgMonitor?`

Example Enable the feature that allows values to be changed from the monitor.
`SChgMonitor,On`

S`TrdWave`

Trend Waveform Display [GX/GP]

Sets the trend waveform display mode.

Syntax `STrdWave,p1,p2`
p1 Waveform display direction
Horizontal Horizontal
Vertical Vertical
p2 Trend clear
Off Do not clear
On Clear

Query `STrdWave?`

Example Set the trend waveform to horizontal display and clear the waveform when recording is started.
`STrdWave,Vertical,On`

Description

- When the multi batch function (/BT) is enabled, p2 is fixed to On.

S`TrdScale`

Scale [GX/GP]

Set the scale.

Syntax `STrdScale,p1,p2,p3`
p1 Number of digits to display for scale values.
Normal Normal
Fine Fine
p2 Current value display
Mark Mark
Bar Bar graph
p3 Number of digits to display for channels that are added to the current value mark
0-digit 0 digits (not show channel numbers)
3-digit 3 digits
4-digit 4 digits

Query `STrdScale?`

Example Set the number of digits to display for scale values to "Fine," display the value indicators on a bar graph, and set the number of digits to display for channels that are added to the current value mark to 4 digits.
`STrdScale,Fine,Bar,4-digit`

S`TrdLine`

Trend Line Width, Grid [GX/GP]

Sets the trend waveform line width and the grid in the display area.

Syntax `STrdLine,p1,p2`
p1 Line width
Thick Thick
Normal Normal
Thin Thin
p2 Grid
Auto Auto
4 to 12 Number of grid lines

Query `STrdLine?`

Example Set the trend waveform line width to "Thin" and the number of grid lines to 10.
`STrdLine,Thin,10`

STrdRate

Trend Interval Switching [GX/GP]

Sets the trend interval switching.

Syntax `STrdRate,p1,p2`
 p1 Trend interval switching
 Off Not switch
 On Switch
 p2 Second trend interval (5s, 10s, 15s, 30s,
 1min, 2min, 5min, 10min, 15min, 20min,
 30min, 1h, 2h, 4h, 10h).

Query `STrdRate?`

Example Set the second trend interval to 30 seconds.
`STrdRate,On,30s`

Description

- You cannot set parameter p1 while recording is in progress.
- You cannot set parameter p1 while computation is in progress.
- p2 is valid only when p1=On.
- You cannot choose a second trend interval that is shorter than the scan interval.
- Trend intervals shorter than 30 s cannot be specified if an electro-magnetic relay type analog input module is in use (set up).
- When the multi batch function (/BT) is enabled, p1 is fixed to On.
- You cannot use this command to configure settings when the measurement mode is set to high speed or dual interval.

STrdKind

Trend Type [GX/GP]

Sets the type of trend waveform to display.

Syntax `STrdKind,p1`
 p1 Type
 Fixed to "T-Y"

Query `STrdKind?`

Example Display using rectangular coordinates.
`STrdKind,T-Y`

STrdPartial

Partial Expanded Trend Display [GX/GP]

Enable or disable the partial expanded trend display.

Syntax `STrdPartial,p1`
 p1 Disable or enable (Off, On)

Query `STrdPartial?`

Example Enable the partial expanded trend display.
`STrdPartial,On`

SMsgBasic

Message Writing

Sets the message writing operation.

Syntax `SMsgBasic,p1,p2,p3`
 p1 Message writing method
 (GX/GP: Common, Separate)
 (GM: Common)
 Common Write messages to all display groups.
 Separate Write messages to only the groups that are displayed.
 p2 Power failure message (Off, On)
 p3 Change message (Off, On)
 (GX/GP: On, Off)
 (GM: On, Off, Fixed to Off when the advanced security function (/AS) is disabled)

Query `SMsgBasic?`

Example Write messages to only the groups that are displayed. Enable the power failure message and change message.
`SMsgBasic,Separate,On,On`

SGroup

Display Group

Sets the display group.

Syntax `SGroup,p1,p2,p3,p4`
 p1 Group number
 p2 Enable or disable (Off, On)
 p3 Group name (up to 16 characters, UTF-8)
 p4 Channel string
 • Specify using channel numbers. 4-digit numbers for I/O channels. Numbers that start with "A" for math channels (A015). Numbers that start with "C" for communication channels (C020). The maximum number of characters per channel is 4.
 • Use periods to separate channel numbers (see example).

Query `SGroup[,p1]?`
The channel string is output exactly as it is specified.

Example Assign channels 0001, 0003, 0005, A001, and C023 to group 2 and name it "GROUP A."
`SGroup,2,On,'GROUP A','1.3.5.A1.C23'`

Description

- This command is valid only when the multi batch function (/BT) is disabled.
- For IO channels in dual interval measurement, only the channels in the scan group specified with the `SDualGroup` command can be selected for p4.

STripLine

Display Group Trip Line

Sets a trip line for a display group.

Syntax `STripLine, p1, p2, p3, p4, p5, p6, p7, p8`
 p1 Group number
 p2 Trip line number (1 to 4)
 p3 Enable or disable (Off, On)
 p4 Display position [%] (1 to 100)
 p5 R value of RGB display colors (0 to 255)
 p6 G value of RGB display colors (0 to 255)
 p7 B value of RGB display colors (0 to 255)
 p8 Line width
 (GX/GP: Thin, Normal, Thick)
 (GM: Normal)

Thin	Thin
Normal	Normal
Thick	Thick

Query `STripLine[, p1[, p2]]?`

Example Display trip line 2 using a thick line in red at the 80% position of group 2.
`STripLine, 2, 2, On, 80, 255, 0, 0, Thick`

Description

- For details on RGB values, see “Description” of the [SColorIO](#) command.
- This command is valid only when the multi batch function (/BT) is disabled.

SSclBmp

Scale Bitmap Image Usage [GX/GP]

Sets whether to display a bitmap scale image in the trend display of a display group.

Syntax `SSclBmp, p1, p2`
 p1 Group number
 p2 Enable or disable (Off, On)

Query `SSclBmp[, p1]?`

Example Use a bitmap scale image on display group 3.
`SSclBmp, 3, On`

Description

- Specify the bitmap file to use from the front panel of the GX/GP.
- This command is valid only when the multi batch function (/BT) is disabled.

SMessage

Message

Sets messages.

Syntax `SMessage, p1, p2`
 p1 Message number (1 to 100)
 p2 Message string (up to 32 characters, UTF-8)

Query `SMessage[, p1]?`

Example Assign character string “MESSAGE77” to message number 77.
`SMessage, 77, 'MESSAGE77'`

STimeZone

Time Zone

Sets the time zone.

Syntax `STimeZone, p1, p2`
 p1 Time zone: Hour (-13 to 13)
 p2 Time zone: Minute (0 to 59)

Query `STimeZone?`

Example Set the time offset to 9 hours ahead of GMT.
`STimeZone, 9, 0`

Description

- You cannot use this command to configure settings while recording is in progress.
- You cannot use this command to configure settings while computation is in progress.

SDateBasic

Gradual Time Adjustment

Sets the gradual time adjustment feature.

Syntax `SDateBasic, p1, p2`
 p1 Boundary value for gradually adjusting the time (Off, 5s, 10s, 15s)
 p2 Action to take when the boundary value for gradually adjusting the time is exceeded.

NotChange	Do not change
Change	Change

Query `SDateBasic?`

Example Set the boundary value to 15 seconds. When the offset exceeds the boundary value, do not change the time.
`SDateBasic, 15s, NotChange`

Description

- You cannot use this command to configure settings while recording is in progress.
- You cannot use this command to configure settings while computation is in progress.

SDateFormat

Date Format

Sets the date format.

Syntax `SDateFormat, p1, p2, p3`
 p1 Date format

YYMMDD	Year, month, day
MMDDYY	Month, day, year
DDMMYY	Date, month, year

p2 Delimiter

/	Slash
.	Dot (period)
-	Hyphen

p3 Month display

Digit	Display the month using numerals (1 to 12)
-------	--

Letter Display the month using characters (Jan, Feb, Mar, Apr, May, Jun, Jul, Aug, Sep, Oct, Nov, Dec)

Query SDateFormat?

Example Set the date format to "year, month, day," and display the month using numerals.
SDaeFormat,YYMMDD,/,Digit

Description

- You cannot use this command to configure settings while recording is in progress.
- You cannot use this command to configure settings while computation is in progress.

SDst

Daylight Saving Time

Set the daylight saving time.

Syntax SDst,p1,p2,p3,p4,p5,p6,p7,p8,p9
 p1 Enable or disable (Use, Not)
 p2 Start time: Month (Jan, Feb, Mar, Apr, May, Jun, Jul, Aug, Sep, Oct, Nov, Dec)
 p3 Start time: Week (1st, 2nd, 3rd, 4th, Last)
 p4 Start time: Weekday (Sun, Mon, Tue, Wed, Thu, Fri, Sat)
 p5 Start time: Hour (0 to 23)
 p6 End time: Month (Jan, Feb, Mar, Apr, May, Jun, Jul, Aug, Sep, Oct, Nov, Dec)
 p7 End time: Week (1st, 2nd, 3rd, 4th, Last)
 p8 End time: Weekday (Sun, Mon, Tue, Wed, Thu, Fri, Sat)
 p9 End time: Hour (0 to 23)

Query SDst?

Example Switch to daylight saving time at hour 0 on the first Sunday of June and switch back at hour 0 on the first Sunday of December.
SDst,On,Jun,1st,Sun,0,Dec,1st,Sun,0

SLang

Language

Sets the language to use.

Syntax SLang,p1
 p1 Language (Japanese, English, German, French, Chinese, Russian, Korean, Italian)

Query SLang?

Example Set the language to Japanese.
SLang,Japanese

Description

- You cannot use this command to configure settings while recording is in progress.
- You cannot use this command to configure settings while computation is in progress.
- If you change the language with this command, the recorder may restart.

STemp

Temperature Unit

Sets the temperature unit.

Syntax STemp,p1
 p1 Temperature unit
 C Celsius
 F Fahrenheit

Query STemp?

Example Set the temperature unit to Celsius.
STemp,C

Description

- You cannot use this command to configure settings while recording is in progress.
- You cannot use this command to configure settings while computation is in progress.

SDPoint

Decimal Point Type

Sets the decimal point type.

Syntax SDPoint,p1
 p1 Decimal point type
 Point Use points.
 Comma Use commas.

Query SDPoint?

Example Use a comma for the decimal point.
SDPoint,Comma

Description

- You cannot use this command to configure settings while recording is in progress.
- You cannot use this command to configure settings while computation is in progress.

SFailAct

Fail Relay Operation (/FL) [GX/GP]

Sets the fail relay (DO channel) operation.

Syntax SFailAct,p1
 p1 Operation
 Fail Output fail information.
 Status Output instrument information.

Query SFailAct?

Example Output fail signals from the fail relay (DO channel).
SFailAct,Fail

Description

- You cannot use this command to configure settings while recording is in progress.
- You cannot use this command to configure settings while computation is in progress.

SFailSts**Instrument Status to Output (/FL) [GX/GP]**

Sets the instrument status to output from the fail relay (DO channel).

Syntax `SFailSts, p1, p2, p3, p4, p5`
 p1 Memory/media status (Off, On)
 p2 Measurement error (Off, On)
 p3 Communication error (Off, On)
 p4 Recording stop (Off, On)
 p5 Alarm (Off, On)

Query `SFailSts?`

Example Output all information.
`SFailSts, On, On, On, On, On`

Description

- You cannot use this command to configure settings while recording is in progress.
- You cannot use this command to configure settings while computation is in progress.

SPrinter**Printer**

Sets the printer.

Syntax `SPrinter, p1, p2, p3, p4, p5, p6, p7`
 p1 IP address (0. 0. 0. 0 to 255. 255. 255. 255)
 p2 Paper size (A4, A3, Letter)
 p3 Paper orientation (Horizontal, Vertical)
 p4 Resolution [dpi] (300, 600)
 p5 Number of copies (1 to 10)
 p6 Snapshot (Off, On)
 (GX/GP: Off, On)
 (GM: Off)
 p7 Fit to page during snapshot printing (Off, On)
 (GX/GP: Off, On)
 (GM: Off)

Query `SPrinter?`

Example Set the IP address to "192.168.111.24," the paper size to A3, the paper orientation to horizontal, the resolution to 600, the number of copies to 2, and snapshot to On. Print by fitting to page.
`SPrinter, 192.168.111.24, A3, Horizontal, 600, 2, On, On`

SLed**LED Indicator Operation [GX/GP]**

Sets the operation of the LED indicators on the front panel.

Syntax `SLed, p, p2`
 p1 Type (Function)
 p2 Operation
 Off Power state
 AlarmAll Alarm

Query `SLed?`

Example Set the LED indicator operation to "Alarm."
`SLed, Function, AlarmAll`

SSound**Sound [GX/GP]**

Sets touch and warning sounds.

Syntax `SSound, p1, p2`
 p1 Touch sound (Off, On)
 p2 Warning sound (Off, On)

Query `SSound?`

Example Enable touch and warning sounds.
`SSound, On, On`

SInstruTag**Instruments Tag**

Sets tags.

Syntax `SInstruTag, p1, p2`
 p1 Tag (up to 32 characters, UTF-8)
 p2 Tag number (up to 16 characters, ASCII)

Query `SInstruTag?`

Example Set the tag to assign to the GX/GP to "GX" and the tag number to "12345."
`SInstruTag, 'GX', '12345'`

SConfCmt**Setting File Comment**

Sets the setting file comment.

Syntax `SConfCmt, p1`
 p1 Setting file comment (up to 50 characters, UTF-8)

Query `SConfCmt?`

Example Set "SETTING FILE COMMENT."
`SConfCmt, 'SETTING FILE COMMENT'`

SFixedConfCmt

Fixed Comment (/AS)

Sets the fixed comment of the setting file comment.

Syntax SFixedConfCmt,p1,p2
p1 Fixed comment number (1 to 10)
p2 Fixed comment (up to 50 characters, UTF-8)

Query SFixedConfCmt?

Example Assign "FIXED COMMENT" to fixed comment number 5.
SFixedConfCmt,5,'FIXED COMMENT'

SUsbInput

USB Input Device [GX/GP]

Specifies the USB input device.

Syntax SUsbInput,p1
p1 USB input device type
Japanese_109 Japanese keyboard
English_104 English keyboard
Barcode Bar-code reader

Query SUsbInput?

Example Specify the English keyboard.
SUsbInput,English_104

Description

- This command is valid on models with the /UH USB interface option.
- For the communication commands that you can execute using a bar-code reader, see section 1.18.11, "Setting USB Input Devices (/UH option)" in the *Model GX10/GX20/GP10/GP20 Paperless Recorder User's Manual* (IM 04L51B01-01EN).

SSetComment

Configuration Changes Comment (/AS)

Sets whether to enter comments when settings are changed.

Syntax SSetComment,p1
p1 Enable/disable configuration changes comment
On Enter comments when settings are changed.
Off Do not enter comments when settings are changed.

Query SSetComment?

Example Enter comments when settings are changed.
SSetComment,On

SSwitch

Internal Switch Operation

Sets the internal switch operation.

Syntax SSwitch,p1,p2,p3,p4
p1 Internal switch number (1 to 100)
p2 Output type

Alarm Output alarms
Manual Specify the output value

p3 **Operation**
And Operate when all set alarms are in the alarm state.
Or Operate when any of the set alarms are in the alarm state.

p4 **Power supply**
Last Output the previous value
On Output 1
Off Output 0

Query SSwitch[,p1]?

Example Output an alarm on internal switch 3. Use "OR" logic.
SSwitch,3,Alarm,Or

Description

- p3 is valid when p2=Alarm.
- p4 is valid when p2 is set to Manual.

SSerialBasic

Serial Communication Basics (/C2 or /C3)

Sets basic serial communication parameters.

Not Use

Syntax SSerialBasic,p1
p1 Function (Off)

Normal/Bar-code

Syntax SSerialBasic,p1,p2,p3,p4,p5,p6,p7
p1 Function (Normal)
(GX/GP: Normal, Barcode, Darwin)
(GM: Normal, Darwin)
p2 Address (1 to 99)
p3 Baud rate [bps] (1200, 2400, 4800, 9600, 19200, 38400, 57600, 115200)
P4 Parity (Odd, Even, None)
p5 Stop bits (1, 2)
p6 Data length [bit] (7, 8)
p7 Handshaking (Off:Off, XON:XON, XON:RS, CS:RS)

Modbus Master and Modbus Slave

Syntax SSerialBasic,p1,p2,p3,p4,p5
p1 Function (Master, Slave)
p2 Address (1 to 247)
p3 Baud rate [bps] (1200, 2400, 4800, 9600, 19200, 38400, 57600, 115200)
P4 Parity (Odd, Even, None)
p5 Stop bits (1, 2)

Query SSerialBasic?

Example Set the baud rate to 9600, the data length to 8, the parity check to ODD, the stop bits to 1, the handshaking to OFF:OFF, the address to 02, and the protocol to NORMAL.
SSerialBasic,Normal,2,9600,Odd,1,8,Off:Off

Description

- You can set p1=Master only on recorders that have the /MC option.

2.4 Setting Commands

- The settings specified with this command takes effect with the **OSeriApply** command. The recorder serial settings do not change until you send the OSeriApply command.
- For the communication commands that you can execute using a bar-code reader, see section 1.18.11, “Setting USB Input Devices (/UH option)” in the *Model GX10/GX20/GP10/GP20 Paperless Recorder User’s Manual* (IM 04L51B01-01EN).

SModMaster

Modbus Master (/C2/MC or /C3/MC)

Sets the Modbus master operation.

- Syntax** SModMaster, p1, p2, p3, p4, p5, p6
- p1 Master function (Off, On)
 - p2 Read cycle (100ms, 200ms, 500ms, 1s, 2s, 5s, 10s, 20s, 30s, 1min)
 - p3 Communication timeout (100ms, 200ms, 250ms, 500ms, 1s, 2s, 5s, 10s, 1min)
 - P4 Gap between messages (Off, 5ms, 10ms, 20ms, 50ms, 100ms)
 - p5 Recovery action: retransmission (Off, 1, 2, 3, 4, 5, 10, 20)
 - p6 Recovery action: wait time (Off, 5s, 10s, 30s, 1min, 2min, 5min)

Query SModMaster?

Example Set the read cycle to 500ms, the communication timeout to 250ms, the gap between messages to 10ms, the retransmission to 2, and the recovery wait time to 5min.
SModMaster, On, 500ms, 250ms, 2, 5min

SModMCmd

Modbus Master Transmission Command (/C2/MC or /C3/MC)

Sets a transmit command of the Modbus master.

- Syntax** SModMCmd, p1, p2, p3, p4, p5, p6, p7, p8
- p1 Command number (1 to 100)
 - p2 Command type
 - Off Disable command
 - Write Write a value to a Modbus register of another device
 - Read Read a value from a Modbus register of another device
 - p3 Slave number (1 to 247)
 - P4 Data type
 - BIT Bit String data
 - INT16 16-bit signed integer
 - UINT16 16-bit unsigned integer
 - INT32_B 32-bit signed integer (big endian)
 - INT32_L 32-bit signed integer (little endian)
 - UINT32_B 32-bit unsigned integer (big endian)

- UINT32_L 32-bit unsigned integer (little endian)
- FLOAT_B 32-bit floating point (big endian)
- FLOAT_L 32-bit floating point (little endian)
- p5 Register (1 to 465535)
- p6 Channel type
 - IO I/O channel
 - Math Math channel
 - Com Communication channel
- p7 First channel
- p8 Last channel

Query SModMCmd [p1] ?

Example Register the following command in command number 2: read the 32-bit signed integer data that is assigned to registers 30003 (upper 16 bits) and 30004 (lower 16 bits) in the slave device assigned to address 5 into channel C002.
SModMCmd, 2, Read, 5, INT32_B, 30003, Com, 002, 002

Description

- If p2=Read, set the communication channel in p6, p7, and p8.
- Set the same type of channel in p7 and p8.
- Math channels are an option (MT).
- For details on data types, registers, and channel types, see section 4.5.1, “Modbus Client and Master Function” in the *Model GX10/GX20/GP10/GP20 Paperless Recorder User’s Manual* (IM 04L51B01-01EN) or section 4.5.1, “Modbus Client/Master Function,” in the *Data Acquisition System GM User’s Manual* (IM 04L55B01-01EN).

SSerialAutoLOut

Auto Logout for Serial Communication (/C2 or /C3)

Sets the auto logout function for serial communication.

- Syntax** SSerialAutoLOut, p1
- p1 Auto logout function (Off, 1min, 2min, 5min, 10min)

Query SSerialAutoLOut?

Example Set the auto logout time for users logged in through serial communication to 1 minute.
SSerialAutoLOut, 1min

Description

- Auto logout is applied to users logged in through serial communication when the communication security function is set to Login (p2 of the **SSecurity** command) and the receiver function setting in the basic serial settings (p1 of the **SSerialBasic** command) is set to Normal.

SIpAddress

IP Address Information

Sets the IP address information.

Syntax `SIpAddress, p1, p2, p3`
 p1 IP address (0.0.0.0 to 255.255.255.255)
 p2 Subnet mask (0.0.0.0 to 255.255.255.255)
 p3 Default gateway (0.0.0.0 to 255.255.255.255)

Query `SIpAddress?`

Example Set the IP address to 192.168.111.24, the subnet mask to 255.255.255.0, and the default gateway to 192.168.111.20.
`SIpAddress, 192.168.111.24, 255.255.255.0, 192.168.111.20`

Description

- The settings specified with this command takes effect with the **OIPApply** command. The recorder IP address does not change until you send the OIPApply command.
- Set an appropriate combination of the IP address (p1) and subnet mask (p2) according to your network.

SClient

Client Function

Sets the client function.

Syntax `SClient, p1, p2`
 p1 Client type (FTP, SMTP, SNTP, MODBUS, WATT, SLMP)
 p2 Client Function (Off, On)

Query `SClient[p1]?`

Example Use the FTP client function.
`SClient, FTP, On`

Description

- Modbus client is valid on models with the /MC communication channel option.
- WATT connection client is valid on models with the WT communication (/E2) option.
- SLMP client is valid on models with the SLMP client (/E4) option.

SClientEncrypt

Client Communication Encryption

Sets whether to encrypt FTP client communication and SMTP client communication.

Syntax `SClientEncrypt, p1, p2, p3`
 p1 Client type (FTP, SMTP)
 p2 Encryption (Off, On)
 p3 Verification of certificate (Off, On)

Query `SClientEncrypt[p1]?`

Example Encrypt FTP client communication. Check that the certificate in the recorder matches the certificate received from the server.
`SClientEncrypt, FTP, On, On`

SDns

DNS Information

Sets the DNS information.

Host (GX)

Syntax `SDns, p1, p2, p3`
 p1 Setting type (Host)
 p2 Host name (up to 64 characters, ASCII)
 p3 Domain name (up to 64 characters, ASCII)

DNS Server

Syntax `SDns, p1, p2, p3`
 p1 Setting type (Server)
 p2 Primary DNS server (0.0.0.0 to 255.255.255.255)
 p3 Secondary DNS server (0.0.0.0 to 255.255.255.255)

Suffix Setup

Syntax `SDns, p1, p2, p3`
 p1 Setting type (Suffix)
 p2 Primary domain suffix (up to 64 characters, ASCII)
 p3 Secondary domain suffix (up to 64 characters, ASCII)

Query `SDns[p1]?`

Example Set the IP address of the primary DNS server to 192.168.111.1 and the IP address of the secondary DNS server to 192.168.111.10
`SDns, Server, 192.168.111.1, 192.168.111.10`

Description

- The settings specified with this command takes effect with the **OIPApply** command. The recorder IP address does not change until you send the OIPApply command.

SDhcp

DHCP Client

Sets the DHCP client.

Do Not Obtain the IP Address Automatically

Syntax `SDhcp, p1`
 p1 Automatic IP address assignment (Off)

Obtain the IP Address Automatically

Syntax `SDhcp, p1, p2, p3`
 p1 Automatic IP address acquisition (On)
 p2 DNS information acquisition (Off, On)
 p3 Automatic host name registration (Off, On)

Query `SDhcp?`

Example Automatically obtain the IP address and DNS information and automatically register the host name.
`SDhcp, On, On, On`

Description

- The settings specified with this command takes effect with the **OIPApply** command. The recorder IP address does not change until you send the OIPApply command.

SFtpKind

File to Transfer via FTP

Sets the file to transfer via FTP.

Syntax SFtpKind, p1, p2
 p1 Setting type
 (GX/GP: Data, Report, Snapshot, AlarmSummary, ManualSample, Setting)
 (GM: Data, Report, AlarmSummary, ManualSample, Setting)
 Data Automatically transfer display and event data files when files are generated.
 Report Automatically transfer report data files when files are generated.
 Snapshot Automatically transfer snapshot data files when files are generated.
 AlarmSummary Transfer alarm summaries
 ManualSample Automatically transfer manual sampled data files when manual sampling is executed.
 Setting Automatically transfer the setting file when settings are changed.
 p2 Enable or disable transfer (Off, On)

Query SFtpKind[p1]?

Example Automatically transfer display and event data files.
 SFtpKind, Data, On

Description

- The report function is an option (/MT).
- p1 can be set to Setting when the advanced security function (/AS) is enabled.

SFtpTime

FTP Transfer Time Shift

Sets the amount of time to shift file transfers that are carried out by the FTP client function.

Syntax SFtpTime, p1, p2
 p1 Setting type
 Data Display and event data files
 Report Report files
 p2 Transfer shift time [minutes] (0 to 120)

Query SFtpTime[p1]?

Example Shift (delay) FTP transfers of report data files by 30 minutes.
 SFtpTime, Report, 30

Description

- The report function is an option (/MT).

SFtpCnct

FTP Client Connection Destination Server

Sets the FTP client connection destination server

Syntax SFtpCnct, p1, p2, p3, p4, p5, p6, p7
 p1 Server
 Primary Primary
 Secondary Secondary
 p2 Server name (up to 64 characters, ASCII)
 p3 Port number (1 to 65535)
 P4 User name (up to 32 characters, ASCII)
 p5 Password (up to 32 characters, ASCII)
 p6 Directory name (up to 64 characters, ASCII)
 p7 PASV mode (Off, On)

Query SFtpCnct [p1]?

The password is displayed using asterisks.

Example For the primary server, assign the name "server1" and port number 21. Set the user name to "Administrator1," the password to "password1," and the directory to "directory1." Set PASV mode to Off.
 SFtpCnct, Primary, 'server1', 21, 'Administrator1', 'password1', 'directory1', Off

SSmtpLogin

SMTP User Authentication

Sets the SMTP user authentication method.

Syntax SSmtpLogin, p1
 p1 User authentication type
 Off Not use authentication.
 Auth-Smtp Use Authentication SMTP.
 POP3 Use POP Before SMTP (unencrypted).
 APOP Use POP Before SMTP (encrypted).

Query SSmtpLogin?

Example Do not use authentication.
 SSmtpLogin, Off

SSmtpCnct

SMTP Client Connection Destination Server

Sets the SMTP client connection destination server

Syntax SSmtpCnct, p1, p2, p3, p4, p5
 p1 Destination server type (SMTP, POP)
 p2 Server name (up to 64 characters, ASCII)
 p3 Port number (1 to 65535)
 P4 User name (up to 32 characters, ASCII)
 p5 Password (up to 32 characters, ASCII)

Query SSmtpCnct [p1]?

The password is displayed using asterisks.

Example Connect to SMTP server "SMTPserver1."
Set the port number to 25, the user name to "administrator1," and the password to "password1."
`SSmtpLogin,SMTP,'SMTPserver1',25,'administrator1','password1'`

SMailHead

Mail Header

Sets the mail header including the recipient address.

Syntax `SMailHead,p1,p2,p3,p4`
 p1 Sender address (up to 64 characters, ASCII)
 p2 Recipient address 1 (up to 150 characters, ASCII)
 p3 Recipient address 2 (up to 150 characters, ASCII)
 P4 Character string to add to the subject (up to 32 characters, ASCII)

Query `SMailHead?`

Example Set the sender address to "recorder1@data.com" and the recipient address to "pc1@data.com." Add "part1" to the subject.
`SMailHead,'recorder1@data.com','pc1@data.com',,'part1'`

SMailBasic

Common Section of the Mail Body

Sets the items that are common to the body of all mails.

Syntax `SMailBasic,p1,p2`
 p1 Header string (up to 128 characters, UTF-8)
 p2 Include source URL (Off, On)

Query `SMailBasic?`

Example Set the header to "recorder1," and include the source URL.
`SMailBasic,'recorder1',On`

SMail

Destination and Behavior for Each Mail Type

Sets the destination and behavior for each mail type.

Alarm Notification

Syntax `SMail,p1,p2,p3,p4,p5,p6`
 p1 Setting type (Alarm)
 p2 Recipient (Off, 1, 2, 1+2)
 Off Not send
 1 Send to recipient 1
 2 Send to recipient 1
 1+2 Send to recipient 1 and 2
 p3 Inclusion of instantaneous data (Off, On)
 P4 Alarm action
 On Send mails when alarms occur
 On+Off Send mails when alarms occur and when they are cleared

p5 Inclusion of tag number or channel number in subject (Off, On)

Scheduled Transmission

Syntax `SMail,p1,p2,p3`
 p1 Setting type (Time)
 p2 Recipient (Off, 1, 2, 1+2)
 p3 Inclusion of instantaneous data (Off, On)

Report Notification (/MT)

Syntax `SMail,p1,p2`
 p1 Setting type (Report)
 p2 Recipient (Off, 1, 2, 1+2)

Media Alarm Notification

Syntax `SMail,p1,p2`
 p1 Setting type (Media)
 p2 Recipient (Off, 1, 2, 1+2)

Power failure notification

Syntax `SMail,p1,p2`
 p1 Setting type (Power)
 p2 Recipient (Off, 1, 2, 1+2)

System Error Notification

Syntax `SMail,p1,p2`
 p1 Setting type (System)
 p2 Recipient (Off, 1, 2, 1+2)

User Lockout Notification (/AS)

Syntax `SMail,p1,p2`
 p1 Setting type (UserLock)
 p2 Recipient (Off, 1, 2, 1+2)

Query `SMail[p1]?`

Example Send alarm notifications to recipient 1 when alarms occur and when they are cleared. Include instantaneous data at the time of transmission, and include the tag number or channel number in the subject.
`SMail,Alarm,1,On,On+Off,On`

Description

- The report function is an option (/MT).

SMailAlarm

Alarm Notification Mail Target Channels

Detects the alarm status of the specified channels and sends alarm notifications.

Syntax `SMailAlarm,p1`
 p1 Channel string (up to 249 characters, up to 50 channels)
 • Use channel number to specify the channels. 4-digit numbers for I/O channels. Numbers that start with "A" for math channels (A015). Numbers that start with "C" for communication channels (C020). The maximum number of characters per channel is 4.
 • Use periods to separate channel numbers (see example).
 • To specify all channels from the first channel to the last channel, delimit the channels with a hyphen. An error will occur if there are no valid channels in the hyphen designated channels.

Query `SMailAlarm?`

The channel string is output exactly as it is specified.

Example Set the target channels to channels 0001 to 0021, 0101, A025, and C003.
`SMailAlarm, '1-21.101.A25.C3'`

SMailAlarmLevel

Alarm Notification Mail Target Alarm levels

Detects the alarm status of the specified alarm levels and sends alarm notification mails.

Syntax `SMailAlarmLevel, p1, p2, p3, p4`
 p1 Alarm level 1 (On, Off)
 p2 Alarm level 2 (On, Off)
 p3 Alarm level 3 (On, Off)
 P4 Alarm level 4 (On, Off)

Query `SMailAlarmLevel?`

Example Set the target alarm levels 1 and 2 to On, 3 and 4 to Off.
`SMailAlarmLevel, On, On, Off, Off`

SMailAlarmDetect

Alarm Notification Mail Target Alarm Detection Method

Sets the alarm detection method for the alarm notification mail.

Syntax `SMailAlarmDetect, p1`
 p1 Detection method (Ch, Level)

Query `SMailAlarmDetect?`

Example Use alarm levels to specify the target alarms.
`SMailAlarmDetect, Level`

Description

- When p1=Ch, use SMailAlarm command to set the target channels. When p1=Level, use SMailAlarmLevel command to set the target levels.

SMailTime

Scheduled Transmission Times

Sets the scheduled transmission times.

Syntax `SMailTime, p1, p2, p3, p4`
 p1 Recipient (1 or 2)
 p2 Reference time: Hours (HH) (00 to 23)
 p3 Reference time: Minutes (MM) (00 to 59)
 P4 Interval (1h, 2h, 3h, 4h, 6h, 8h, 12h, 24h)

Query `SMailTime[, p1]?`

Example Send mail to recipient 1 every day at 08:30.
`SMailTime, 1, 08, 30, 24`

SSntpCnct

SNTP Client

Sets the SNTP client operation and the connection destination server.

Syntax `SSntpCnct, p1, p2, p3, p4, p5, p6, p7`
 p1 Server name (up to 64 characters, ASCII)
 p2 Port number (1 to 65535)
 p3 Reference time: Hours (HH) (00 to 23)
 P4 Reference time: Minutes (MM) (00 to 59)
 p5 Access interval (6h, 12h, 24h)
 p6 Timeout (10s, 30s, 90s)
 p7 Time adjust on start action (Off, On)

Query `SSntpCnct?`

Example Set the server name to "sntpserver1," the port number to "123," the timeout to 30s. Query the time every day at 12:00 and at memory start.
`SSntpCnct, 'sntpserver1', 123, 12, 00, 24, 30s, On`

SModClient

Modbus Client Operation (/MC)

Sets the Modbus client operation.

Syntax `SModClient, p1, p2, p3, p4`
 p1 Read cycle (100ms, 200ms, 500ms, 1s, 2s, 5s, 10s, 20s, 30s, 1min)
 p2 Recovery wait time (Off, 5s, 10s, 30s, 1min, 2min, 5min)
 p3 Keep connection (Off, On)
 P4 Connection timeout [s] (1 to 10)

Query `SModClient?`

Example Set the read cycle to 100ms, the recovery wait time to Off, and the connection timeout to 1 second.
`SModClient, 100ms, off, on, 1`

Description

- This command is valid on models with the /MC communication channel option.

SModCList

Modbus Client Connection Destination Server (/MC)

Sets the Modbus client connection destination server.

Syntax `SModCList, p1, p2, p3`
 p1 Registration number
 p2 Server name (up to 64 characters, ASCII)
 p3 Port number (1 to 65535)

Query `SModCList[, p1]?`

Example Assign server name "recorder1" and port number "502" to registration number 1.
`SModClient, 1, 'recorder1', 502`

SModCCmd

Modbus Client Transmission Command (/MC)

Sets the Modbus client transmission command.

Syntax SModCCmd, p1, p2, p3, p4, p5, p6, p7, p8, p9

p1 Command number

p2 Command type

Off Disable command

Write Write a value to a Modbus register of another device.

Read Read a value from a Modbus register of another device.

p3 Server number (1 to 16)

p4 Unit number (1 to 255)

p5 Data type

BIT Bit String data

INT16 16-bit signed integer

UINT16 16-bit unsigned integer

INT32_B 32-bit signed integer (big endian)

INT32_L 32-bit signed integer (little endian)

UINT32_B 32-bit unsigned integer (big endian)

UINT32_L 32-bit unsigned integer (little endian)

FLOAT_B 32-bit floating point (big endian)

FLOAT_L 32-bit floating point (little endian)

p6 Register (1 to 465535)

p7 Channel type

IO I/O channel

Math Math channel

Com Communication channel

p8 First channel

p9 Last channel

Query SModCCmd[p1]?

Example Register the following command in command number 2: read the 32-bit signed integer data that is assigned to registers 30003 (upper 16 bits) and 30004 (lower 16 bits) in the server device assigned to address 5 and unit number 1 into channel C002.

```
SModCCmd, 2, Read, 5, 1, INT32_B, 30003, Com, C002, C002
```

Description

- If p2=Read, set the communication channel in p7, p8, and p9.
- Set the same type of channel in p8 and p9.
- Math channels are an option (/MT).
- For details on data types, registers, and channel types, see section 4.5.1, "Modbus Client and Master Function" in the *Model GX10/GX20/GP10/GP20 Paperless Recorder User's Manual (IM 04L51B01-01EN)* or section 4.5.1, "Modbus Client/Master Function," in the *Data Acquisition System GM User's Manual (IM 04L55B01-01EN)*.

SServer

Server Function

Enables or disables the server function.

Syntax SServer, p1, p2, p3

p1 Server type (FTP, HTTP, SNTP, MODBUS, GENE, EtherNetIP, DARWIN, OPC-UA)

GENE General communication

p2 Operation (Off, On)

p3 Port number (1 to 65535)

Query SServer[, p1]?

Example Use the FTP server function.

```
SServer, FTP, On, 21
```

Description

- You cannot specify a port number that is used by another function.
- p3 cannot be set to 44818, 2222, 34150, or 34151.
- p3 is invalid when p1 = DARWIN (Darwin compatible communication) or when p1 = EtherNetIP.
- The default port numbers are listed below.

Server type (p1)	Default port number
FTP	21
HTTP	80
SNTP	123
MODBUS	502
GENE	34434

- p1 = EtherNetIP is an option (/E1).
- p1=OPC-UA is valid on models with the OPC-UA server (/E3) option.
- The settings specified with this command takes effect with the **OIPApply** command.

SServerEncrypt

Server Communication Encryption

Sets server communication encryption.

Syntax SServerEncrypt,p1,p2
p1 Server type (FTP, HTTP)
p2 Encryption (Off, On)

Query SServerEncrypt[p1]?

Example Encrypt FTP server communication.
SServerEncrypt,FTP,On

SKeepAlive

Keepalive

Sets the keepalive function.

Syntax SKeepAlive,p1
p1 Operation (Off, On)

Query SKeepAlive?

Example Use keepalive.
SKeepAlive,On

STimeout

Communication Timeout

Sets the communication timeout function.

Syntax STimeout,p1,p2
p1 Timeout function (Off, On)
p2 Timeout value [minutes] (1 to 120)

Query STimeout?

Example Enable the communication timeout, and set the timeout value to 3 minutes.
STimeout,On,3

SFtpFormat

FTP Server Directory Output Format

Sets the FTP server directory output format.

Syntax SFtpFormat,p1
p1 FTP server directory output format (MS-DOS, UNIX)

Query SFtpFormat?

Example Specify MS-DOS.
SFtpFormat,MS-DOS

SModDelay

Modbus Server Delay Response

Sets the Modbus server delay response.

Syntax SModDelay,p1
p1 Delay response (Off, 10ms, 20ms, 50ms)

Query SModDelay?

Example Specify no delay response.
SModDelay,Off

SModLimit

Modbus Server Connection Limit

Enables or disables the Modbus server connection limit function.

Syntax SModLimit,p1
p1 Connection limit (Off, On)

Query SModLimit?

Example Enable connection limit.
SModLimit,On

SModList

IP Address to Allow Connection to Modbus Server

Sets the IP address to allow connection to Modbus server.

Syntax SModList,p1,p2,p3
p1 Registration number (1 to 10)
p2 Enable or disable registration (Off, On)
p3 IP address (0.0.0.0 to 255.255.255.255)

Query SModList[,p1]?

Example Register IP address "192.168.111.24" to registration number 1.
SModList,1,On,192.168.111.24

SWattList

WT Communication Connection Server (/E2)

Sets the WT communication connection server.

Syntax SWattList,p1,p2,p3,p4
p1 Registration number
p2 Enable or disable (On, Off)
p3 Server name (up to 64 characters, ASCII)
p4 Model (WT300, WT500, WT1800)

Query SWattList[,p1]?

Example Register model WT1800 and server name "Watt01" in registration number 1.
SWattList,1,On,Watt01,WT1800

SWattClient

WT Communication Operation (/E2)

Sets the WT communication operation.

Syntax SWattClient,p1,p2
p1 Read cycle (500ms, 1s, 2s, 5s, 10s, 20s, 30s)
p2 Recovery wait time (5s, 10s, 30s, 1min, 2min, 5min)

Query SWattClient?

Example Set the read cycle to 10 seconds and recovery wait time to 2 minutes.
SWattClient,10,2min

SWattData

WT Data Allocation to Communication Channel (/E2)

Allocates WT data to a communication channel.

Syntax `SWattData, p1, p2, p3, p4, p5, p6, p7`
 p1 Allocation No
 p2 Enable or disable specification (On, Off)
 p3 Communication channel
 p4 Server registration number
 p5 Data group name (see “Description” and Appendix 6.)
 p6 Data name (see Appendix 6.)
 p7 Exponential scaling (-9 to 18), default value 0

Query `SWattData[, p1]?`

Example In allocation number 1, allocate the RMS voltage of element 1 of the WT1800 assigned to server registration number 2 to communication channel 003.
`SWattData, 1, On, 003, 2, Element1, URMS`

Description

- The available data groups (p5) vary depending on the model.

p5	Description	Supported Item		
		WT1800	WT500	WT300
Off	Unspecified	Yes	Yes	Yes
Element1	Element 1 data	Yes	Yes	Yes
Element2	Element 2 data	Yes	Yes	Yes
Element3	Element 3 data	Yes	Yes	Yes
Element4	Element 4 data	Yes	—	—
Element5	Element 5 data	Yes	—	—
Element6	Element 6 data	Yes	—	—
ElemHrm1	Element 1 harmonic data	Yes	Yes	Yes
ElemHrm2	Element 2 harmonic data	Yes	Yes	Yes
ElemHrm3	Element 3 harmonic data	Yes	Yes	Yes
ElemHrm4	Element 4 harmonic data	Yes	—	—
ElemHrm5	Element 5 harmonic data	Yes	—	—
ElemHrm6	Element 6 harmonic data	Yes	—	—
SigmaA	First wiring unit data	Yes	Yes	Yes
SigmaB	Second wiring unit data	Yes	—	—
SigmaC	Third wiring unit data	Yes	—	—
Other	Other types of data	Yes	Yes	Yes
DeltaA	First wiring unit delta math data	Yes	—	—
DeltaB	Second wiring unit delta math data	Yes	—	—
DeltaC	Third wiring unit delta math data	Yes	—	—
Delta	Delta math data	—	Yes	—
Motor	Motor option data	Yes	—	—
Aux	Auxiliary input option data	Yes	—	—
Phase	Phase difference data	—	Yes	—

SKdcCnct

KDC Connection Destination (/AS)

Sets the KDC server for the password management.

Syntax `SKdcCnct, p1, p2, p3`
 p1 Connection destination (Primary, Secondary)
 Primary Primary server
 Secondary Secondary server
 p2 KDC server name (up to 64 characters, ASCII)
 p3 Port number (1 to 65535)

Query `SKdcCnct[, p1]?`

Example For the primary KDC server, assign the server name “KdcControl1” and port number 88.
`SKdcCnct, Primary, KdcControl1, 88`

SAuthKey

Certification Key (/AS)

Sets the certification key that is used during password management authentication.

Syntax `SAuthKey, p1, p2, p3, p4`
 p1 Host principal (up to 20 characters, ASCII)
 p2 Realm name (up to 64 characters, ASCII)
 p3 Password (up to 20 characters, ASCII)
 p4 Encryption (ARC4, AES128, AES256)

Query `SAuthKey?`

Example Set the password of host principal “GX10_001” realm “REALM01” to “gDcbwT5,” and the encryption (the same as the server) to AES128.
`SAuthKey, GX10_001, REALM01, gDcbwT5, AES128`

Description

- Slashes and ampersands cannot be used in p1 or p2.

SDarwinCnvCh

Darwin Channel Conversion (Darwin compatible communication)

Replace Darwin channels with recorder channels.

Syntax `SDarwinCnvCh, p1`
 p1 Darwin model
 Standalone Stand-alone type
 Extension Extended type

Query `SDarwinCnvCh?`

Example Replace DA100 stand-alone type channels to recorder channels.
`SDarwinCnvCh, Standalone`

SDarwinPortLimit

Port limitation of DARWIN compatible communication

If port limitation is on, port number 34151 only allows reading of instantaneous data.

Syntax `SDarwinPortLimit, p1`
 p1 Port limitation on/off (On/Off)
 On Instantaneous data reading only on 34151.
 Off No limitations on 34150 or 34151.

Query `SDarwinPortLimit?`

Example Set port number 34151 to instantaneous data reading only.

`SDarwinPortLimit, On`

Description

- **The following applies when port limitation is set to On.**
 - When connected via Ethernet
Only instantaneous data reading is possible on port number 34151. Configuration, control, and operation are not possible.
 - When connected via serial communication
Only the commands that can be used on a Ethernet connection through port 34150 are valid.

SSLMPClient

SLMP client operation (/E4)

Sets the SLMP client operation.

Syntax `SSLMPClient, p1, p2, p3, p4`
 p1 Data code (Binary, ASCII)
 p2 Read cycle (100ms, 200ms, 500ms, 1s, 2s, 5s, 10s, 20s, 30s, 1min)
 p3 Timeout value (250ms, 500ms, 1s, 2s, 3s, 4s, 5s, 10s, 20s, 30s, 1min)
 p4 Recovery time (Off, 5s, 10s, 30s, 1min, 2min, 5min)

Query `SSLMPClient?`

Example Set the data code to binary, read cycle to 500 ms, timeout value to 1 s, and recovery time to 2 min.

`SSLMPClient, Binary, 500ms, 1s, 2min`

SSLMPCList

SLMP connection destination server (/E4)

Sets the SLMP client connection destination server.

Syntax `SSLMPCList, p1, p2, p3`
 p1 Connection destination number (1 to 16)
 p2 Server name (up to 64 characters, ASCII)
 p3 Port number (1 to 65535)

Query `SSLMPCList[, p1]?`

Example Connect to the server at connection destination number 1. Set the server name to "SMARTDAC" and the port number to 2020.

`SSLMPCList, 1, "SMARTDAC", 2020`

SSLMPCCmd

SLMP client transmission command (/E4)

Sets the SLMP client transmission command.

Syntax `SSLMPCCmd, p1, p2, p3, p4, p5, p6, p7, p8, p9, p10, p11, p12, p13`
 p1 Command number (GX10/GP10: 1 to 50, GX20-1/GP20-1: 1 to 100, GX20-2/GP20-2/GM10-2: 1 to 200)
 p2 Type
 Off Disable command
 Write Write a value to a Modbus register of another device.
 Read Read a value from a Modbus register of another device.
 p3 Connection destination number (1 to 16)
 p4 See the device code table.
 p5 Request destination network number (0 to 255)
 p6 Request destination station number (0 to 255)
 p7 Request destination module I/O number (0 to 65535)
 p8 Request destination multidrop station number (0 to 31)
 p9 Data type
 BIT Bit String data
 INT16 16-bit signed integer
 UINT16 16-bit unsigned integer
 INT32 32-bit signed integer
 UINT32 32-bit unsigned integer
 FLOAT 32-bit floating point
 p10 Head device number (0 to 16777215)
 p11 Channel type
 IO I/O channel
 Math Math I/O channel (/MT)
 Com Communication I/O channel (/MC)
 p12 First channel
 p13 Last channel

Query `SSLMPCCmd[, p1]?`

Example Register "read the bit data assigned to head device number 1234 of the internal relay of the device at connection destination server number 1" to command number 1.

`SSLMPCCmd, 1, Read, 1, M, 1234, 0, 255, 1023, 0, BIT, Com, 0001, 0001`

Device Code Table

Device	Device Code (p4)	p5 to p8 , p10 Notation	Data Type
Special relay	SM	Hexadecimal	BIT
Special register	SD	Hexadecimal	INT16/UINT16/ INT32/UINT32/ FLOAT
Input	X	Hexadecimal	BIT
Output	Y	Hexadecimal	BIT

Continued on next page

Device	Device Code (p4)	p5 to p8 , p10 Notation	Data Type	
Internal relay	M	Hexadecimal	BIT	
Latch relay	L	Hexadecimal	BIT	
Annunciator	F	Hexadecimal	BIT	
Edge relay	V	Hexadecimal	BIT	
Link relay	B	Hexadecimal	BIT	
Data register	D	Hexadecimal	INT16/UIN16/ INT32/UIN32/ FLOAT	
Link register	W	Hexadecimal	INT16/UIN16/ INT32/UIN32/ FLOAT	
Timer	Contact	TS	Hexadecimal	BIT
	Coil	TC	Hexadecimal	BIT
	Current value	TN	Hexadecimal	INT16/UIN16/ INT32/UIN32/ FLOAT
Integration timer	Contact	SS	Hexadecimal	BIT
	Coil	SC	Hexadecimal	BIT
	Current value	SN	Hexadecimal	INT16/UIN16/ INT32/UIN32/ FLOAT
Counter	Contact	CS	Hexadecimal	BIT
	Coil	CC	Hexadecimal	BIT
	Current value	CN	Hexadecimal	INT16/UIN16/ INT32/UIN32/ FLOAT
Special link relay	SB	Hexadecimal	BIT	
Special link register	SW	Hexadecimal	INT16/UIN16/ INT32/UIN32/ FLOAT	
Direct access input	DX	Hexadecimal	BIT	
Direct access output	DY	Hexadecimal	BIT	
Index register	Z	Hexadecimal	INT16/UIN16/ INT32/UIN32/ FLOAT	
Filter register	R	Decimal	INT16/UIN16/ INT32/UIN32/ FLOAT	
	ZR	Hexadecimal	INT16/UIN16/ INT32/UIN32/ FLOAT	

SSecurity

Security Function

Sets the security function.

Syntax `SSecurity, p1, p2, p3, p4, p5, p6`

p1 Operations on the recorder (GX/GP: Off, Login, Operate) (GM: Off)

- Off Disables the security function
- Login Enables the login function
- Operate Enables the function that prohibits touch screen operation

p2 Operations via communication (Off, Login)

p3 Auto logout (GX/GP: Off, 1min, 2min, 5min, 10min) (GM: Off)

p4 Operation without login (GX/GP: Off, On) (GM: Off)

p5 Password retry (Off, 3, 5)

p6 Enable or disable user ID (On, Off)

p7 Admin/User/Sign in propaty (OnOff, OnOnly)

Query `SSecurity?`

Example Use the login function when operating the recorder directly or via communication. When logged in, automatically log out if there is no user activity for 5 minutes. The screen can be changed even when logged out.
`SSecurity, Login, Login, 5min, On`

Description

- You cannot use this command to configure settings while recording is in progress.
- You cannot use this command to configure settings while computation is in progress.
- You cannot use this command to configure settings when logged in as a user (when the user level is User).
- p1 cannot be set to Operate when the advanced security function (/AS) is enabled.
- p5, p6 and p7 are valid when the advanced security function (/AS) is enabled.
- Second administrators (SecondAdmin user level) whose basic settings are set to Lock cannot use this command to configure settings.

SKdc

Password Management (/AS)

Sets the password management.

Syntax `SKdc, p1, p2`

p1 Enable disable password management (On, Off)

p2 Root user password (between 6 and 20 characters, ASCII)

Query `SKdc?`

Example Enable password management. Set the root user password to "root3210."
`SKdc, On, root3210`

Description

- You cannot use this command to configure settings when logged in as a user (when the user level is User).
- Second administrators (SecondAdmin user level) whose basic settings are set to Lock cannot use this command to configure settings.

SPasswdPolicy

Password policy (/AS)

Set the password policy.

Syntax `SPasswdPolicy, p1, p2, p3, p4, p5`

p1 Minimum character luntgh (6 to 20)

p2 Upper case (On, Off)

p3 Lower case (On, Off)

p4 Numeric character (On, Off)

p5 Symbol (On, Off)

Query `SPasswdPolicy?`

2.4 Setting Commands

Example Set the minimum number of characters to 10 and force the password to include numbers and symbols.
`SpasswdPolicy,10,Off,Off,On,On`

Description

- You cannot use this command to configure settings when logged in as a user (when the user level is User).
- Second administrators (SecondAdmin user level) whose basic settings are set to Lock cannot use this command to configure settings.

SpasswdNotice

Password Expiration Advance Notification (/AS)

Sets the function that sends a notification during login when the password expiration is approaching.

Syntax `SpassNotice,p1`
`p1` Notification (Off, 5Day, 10Day)

Query `SpassNotice?`

Example Set the password expiration advance notification to 10 days.
`SpassPolicy,10Day`

Description

- You cannot use this command to configure settings when logged in as a user (when the user level is User).
- Second administrators (SecondAdmin user level) whose basic settings are set to Lock cannot use this command to configure settings.

SOpePass

Password to Unlock Operation [GX/GP]

Sets the password that is used to release the operation lock.

Syntax `SOpePass,p1`
`p1` Password (up to 20 characters, UTF-8)

Query `SOpePass?`
The password is displayed using asterisks.

Example Set the password to "password1."
`SOpePass,'password1'`

Description

- You cannot use this command to configure settings when logged in as a user (when the user level is User).
- Second administrators (SecondAdmin user level) whose basic settings are set to Lock cannot use this command to configure settings.

SOpeLimit

Operation Lock Details [GX/GP]

Sets which operations to lock.

Syntax `SOpeLimit,p1,p2`
`p1` Authority of user

Memory	Memory
Math	Computations
DataSave	Data save
Message	Message
Batch	Batch
AlarmACK	Alarm ACK
Comm	Communication
DispOpe	Touch operation
ChangeSet	Setting operation
DateSet	Date/time settings
File	File operation
System	System operation
Out	Output operation
CalibSet	Calibration correction setting (valid only when the advanced security function (/AS option) is in use on instruments whose version is 2.02 or later.)
CtrlIn	Remote/Local operation (This is valid when a PID Control Module is installed.)
CtrlOut	Control operation (same as above)
Tuning	Tuning operation (same as above)
LocalSP	SP operation (same as above)
Program	Program operation (This is valid when a PID Control Module is installed and the program control function (/PG option) is in use.)

`p2` Free/Lock
Free Not lock
Lock Lock

Query `SOpeLimit[,p1]?`

Example Prohibit operations for changing settings.
`SOpeLimit,ChangeSet,Lock`

Description

- You cannot use this command to configure settings when logged in as a user (when the user level is User).
- Second administrators (SecondAdmin user level) whose basic settings are set to Lock cannot use this command to configure settings.

SUser

User Settings

Register users.

Syntax `SUser, p1, p2, p3, p4, p5, p6, p7`

p1 **User number**

p2 **User level**

Off	Not Use
Admin	Administrator level
User	User level

p3 **Login mode**
(GX/GP: Key, Comm, Key+Comm)
(GM: Comm)

Key	Log in using touch operation
Comm	Log in via communication (including Web)
Key+Comm	Log in using touch operation and via communication.

P4 **User name** (up to 20 characters, ASCII)

p5 **Password** (up to 20 characters, ASCII)

p6 **Enable or disable user limitation** (Off, On)

p7 **User limitation number** (1 to 10)

Query `SUser[, p1]?`
The password of p5 are displayed using asterisks.

Example Register a user-level user to user number 3. Set the user name to "user10" and the password to "pass012." Allow login only using touch operation, and specify user limitation number 5.
`SUser, 3, User, Key, 'user10', 'pass012', On, 5`

Description

- If p1=1, p2 is fixed to Admin. In addition, you cannot set p3 to Comm on the GX/GP.
- If p2=Admin, p6 is fixed to Off.
- You cannot enter NULL or spaces in p4 or p5.
- For the characters that you can use in the specified password (p5), see [Appendix 1](#).
- You cannot use this command to configure settings when logged in as a user (when the user level is User).

When Using the Advanced Security Function (/AS)

Syntax `SUser, p1, p2, p3, p4, p5, p6, p7, p8, p9, p10, p11, p12, p13`

p1 **User number**

p2 **User level**

Off	Not use
Admin	Administrator level
SecondAdmin	Second Administrator level
User	User level
Monitor	Monitor level

p3 **Login method**

Key	Log in using touch operation
Comm	Log in via communication commands (including Web)

	Key+Comm	Log in using touch operation and via communication.
P4	User name	(up to 20 characters, ASCII)
p5	Password	(between 6 and 20 characters, ASCII)
p6	Enable or disable user limitation	(Off, On)
p7	User limitation number	(1 to 10)
p8	User ID	(up to 20 characters, ASCII) Specify a user ID and password combination that have not been registered in the past.
p9	Password expiration	(Off, 1Month, 3Month, 6Month, 1Year)
p10	Enable or disable sign in property	(Off, On)
p11	Sign in property number	(1 to 8)
p12	Enable or disable admin authority	(Off, On)
p13	Admin authority number	(1 to 10)
Query	<code>SUser[, p1]?</code>	The password of p5 and user ID of p8 are displayed using asterisks.
Example	Register a user-level user to user number 3. Set the user name to "user10." Allow login only using touch operation, and specify user limitation number 5. <code>SUser, 3, User, Key, 'user10', , On, 5</code>	

Description

- If p1=1, p2 is fixed to Admin. In addition, you cannot set p3 to Comm.
- If p2=Admin, p6, p10, and p12 are fixed to Off.
- If p2=Monitor, p6, p9, p10, and p12 are fixed to Off.
- If p2 = User, p12 is fixed Off.
- You cannot enter NULL or spaces in p4 or p5.
- Setting to enable password management (SKdc command)
 - If p2=Off, Admin, SecondAdmin or User, p5 is invalid. The response to a query will be blank.
 - p9 is fixed to Off.
- You can specify p5 only when p2=Monitor. When p2=Admin, SecondAdmin or User, you cannot specify p5 and the default password is enabled. If a password policy error is displayed, the error will not be displayed unless a string is set in p5. For the default password, see section 2.3.1, "Logging In" in the Model GX10/GX20/GP10/GP20 Advanced Security Function (/AS) User's Manual (IM 04L51B01-05EN) or section 2.2.1, "Logging In" in the Data Acquisition System GM Advanced Security Function (/AS) User's Manual (IM 04L55B01-05EN).
- For the characters that you can use in the specified password (p5), see [Appendix 1](#).
- You cannot use this command to configure settings when logged in as a user (when the user level is User).
- When the Admin / User / Sign in property of security function is set to "OnOnly". When p2 = SecondAdmin, p6, p10, and p12 are fixed to On. When p2 = User, p6 and p10 are fixed to On.

2.4 Setting Commands

- Second administrators (SecondAdmin user level) whose basic settings are set to Lock cannot use this command to configure settings.

SUserLimit

Authority of User

Sets user operation limitations.

Syntax `SUserLimit, p1, p2, p3`
p1 User limitation number (1 to 10)
p2 Authority of user

Memory	Memory
Math	Computations
DataSave	Data save
Message	Message
Batch	Batch
AlarmACK	Alarm ACK
Comm	Communication
DispOpe	Touch operation (cannot be specified on the GM.)
ChangeSet	Setting operation
DateSet	Date/time settings
File	File operation
System	System operation
Out	Output operation
CalibSet	Calibration correction settings (valid only when the advanced security function (/AS option) is in use on instruments whose version is 2.02 or later.)
CtrlIn	Remote/Local operation (This is valid when a PID Control Module is installed.)
CtrlOut	Control operation (same as above)
Tuning	Tuning operation (same as above)
LocalSP	SP operation (same as above)
Program	Program operation (This is valid when a PID Control Module is installed and the program control function (/PG option) is in use.)

p3 Free/Lock

Free	Not lock
Lock	Lock

Query `SUserLimit[, p1]?`

Example Set user limitation number 1 so that changing settings is prohibited.

`SUserLimit, 1, ChangeSet, Lock`

Description

- You cannot use this command to configure settings when logged in as a user (when the user level is User).
- Second administrators (SecondAdmin user level) whose user property are set to Lock cannot use this command to configure the setting.

SSignIn

Sign In (/AS)

Sets the sign in record for the measured data file.

Syntax `SSignIn, p1, p2, p3`
p1 Sign in type (Batch, File)
p2 Sign in at record stop (GX/GP: On, Off) (GM: Fixed to Off)
p3 FTP transfer timing (GX/GP: DataSave, SignIn) (GM: Fixed to DataSave)

Query `SSignIn?`

Example When the recording of measured data of a batch process is stopped, switch to the screen for signing in.

`SSignIn, Batch, On, Signin`

Description

- You cannot use this command to configure settings when logged in as a user (when the user level is User).
- Second administrators (SecondAdmin user level) whose sign in settings are set to Lock cannot use this command to configure the setting.

SSignInTitle

Sign In Title (/AS)

Sets the sign in title.

Syntax `SSignInTitle, p1, p2, p3`
p1 Sign in 1 title (up to 16 alphanumeric and symbol characters)
p2 Sign in 2 title (same as above)
p3 Sign in 3 title (same as above)

Query `SSignInTitle?`

Example Set the sign in 1, 2, and 3 titles to "Operator 1," "Supervisor 1," and "Manager 1," respectively.
`SSignInTitle, 'Operator 1', 'Supervisor 1', 'Manager 1'`

Description

- You cannot use this command to configure settings when logged in as a user (when the user level is User).
- Second administrators (SecondAdmin user level) whose sign in settings are set to Lock cannot use this command to configure the setting.

SSignInLimit

Sign In Property (/AS)

Sets the sign in property.

Syntax `SSignInLimit, p1, p2, p3, p4`
p1 Sign in property number (1 to 8)
p2 Sign in 1 free/lock (Free, Lock)
p3 Sign in 2 free/lock (Free, Lock)
p4 Sign in 3 free/lock (Free, Lock)

Query `SSignInLimit[, p1]?`

Example Set a sign in property number 2 to allow the execution of only sign in 1.

`SSignInLimit, 1, Free, Lock, Lock`

Description

- You cannot use this command to configure settings when logged in as a user (when the user level is User).
- Second administrators (SecondAdmin user level) whose sign in property are set to Lock cannot use this command to configure the setting.

SAdminLimit**Authority of Admin (/AS)**

Sets authority of the second administrator.

Syntax `SAdminLimit,p1,p2,p3`
 p1 Admin authority number (1 to 10)
 p2 Authority type

<code>SecurityBasic</code>	Basic settings
<code>User</code>	User settings
<code>AdminLimit</code>	Admin property
<code>UserLimit</code>	User property
<code>Signin</code>	Sign in settings
<code>SignLimit</code>	Sign in property
<code>Initialize</code>	Initialize
<code>Reconf</code>	Reconfiguration
<code>SetCert</code>	Certificate
<code>Update</code>	Update

p3 Free/lock (Free, Lock)

Query `SAdminLimit[,p1[,p2]]?`

Example Set admin property number 7 to prohibit user registration.
`SAdminLimit,7,User,Lock`

Description

- You cannot use this command to configure settings when logged in as a user (when the user level is User).
- Second administrators (SecondAdmin user level) whose admin property are set to Lock cannot use this command to configure the setting.

SBTPassword**Bluetooth Password (/C8) [GM]**

Sets the Bluetooth password.

Syntax `SBTPassword,p1,p2`
 p1 Password usage (On, Off)
 p2 Password (up to 20 characters, ASCII)

Query `SBTPassword?`
 The password is displayed using asterisks.

Example Set the password to "PaSswORD2."
`SBTPPassword,On,'PaSswORD2'`

Description

- This command can be executed only when the user is logged in as an administrator.

SWebCustomMenu**Web Monitor Screen**

Shows or hides the categories displayed in the contents tree.

Syntax `SWebCustomMenu,p1,p2,p3,p4,p5`

p1 User level (User, Monitor)
 p2 Status display category
 Show: On, hide: Off
 p3 Log category
 Show/hide (On, Off)
 p4 System/Network information category
 Show/hide (On, Off)
 p5 File category
 Show/hide (On, Off)

Query `SWebCustomMenu?`

Example Show the log category and file category for the user level.
`SWebCustomMenu,User,Off,On,Off,On`

Description

- You cannot use this command to configure settings when logged in as a user (when the user level is User).
- When the advanced security function (/AS) is disabled, p1 monitor is disabled.
- Second administrators (SecondAdmin user level) whose user property are set to Lock cannot use this command to configure the setting.

SSessionSecurity**Web Session Security Function (/AS) [GM]**

Sets the web session security function.

Syntax `SSessionSecurity,p1`
 p1 Session security (On, Off)

Query `SSessionSecurity?`

Example Use the session security function.
`SSessionSecurity,On`

Description

- You cannot use this command to configure settings when logged in as a user (when the user level is User).
- Second administrators (SecondAdmin user level) whose basic settings are set to Lock cannot use this command to configure settings.

SWebTimeOut**Web Auto Logout (/AS) [GM]**

Sets the auto logout time for web screen.

Syntax `SWebTimeOut,p1`
 p1 Auto logout time (Off, 10 min, 20 min, 30 min)

Query `SWebTimeOut?`

Example Set the auto logout time to 10 minutes.
`SWebTimeOut,10min`

Description

- You cannot use this command to configure settings when logged in as a user (when the user level is User).
- Second administrators (SecondAdmin user level) whose basic settings are set to Lock cannot use this command to configure settings.

SChgComm

Writing through Communication Commands (/AS)

Enables or disables communication channel writing.

Syntax SChgComm, p1, p2
 p1 Type (CommCh)
 p2 Valid/Invalid
 Valid Enabled
 Invalid Disabled

Query SChgComm[, p1]?

Example Enable writing through communication commands.
 SChgComm, CommCh, Valid

Description

- You cannot use this command to configure settings when logged in as a user (when the user level is User).
- Second administrators (SecondAdmin user level) whose basic settings are set to Lock cannot use this command to configure settings.
- This command functions only when Security function > Touch operation is set to "Login" and communication is set to "Off." Note that setting is possible even when the function is not set to operate. By setting p2 to "Valid (Enabled)," you can write values to communication channels using the OcommCh command even when communication is set to "Off."

SMonitor

Monitor Screen Display Information [GX/GP]

Sets the monitor screen display information.

Syntax SMonitor, p1, p2
 p1 Information type (see the table below)
 p2 Status (see the table below)

Information Type		Status
p1	Description	p2
Digital	Digital value display	Off, On
Scroll	Auto scroll	Off, On
Message	Message display	Stream, List
Trend	All channel/group display	Group, All
Grid	Auxiliary grid	Off, On
Axis	Time axis on historical trend	1, 2, 3, 4, 5, 6, 7, 8
Value	Digital value display on historical trend	4Value, Max, Min
Data	Historical data type	Disp, Event1
DigitalWave	Digital waveform display	Off, On
Alarm	Alarm display	Watch, List
Alarm_Sort	Alarm sort item	Time, Channel, Level, Type
Alarm_Order	Alarm sort order	Ascending, Descending
Alarm_Time	Detailed alarm time	Off, On
Message_Sort	Message sort item	Datetime, WriteTime, Message, Group, User
Message_Order	Message sort order	Ascending, Descending
Memory_Data	Memory data type	Disp, Event1, Event2
Overview	Overview display	Grouping, All
Multi_No	Multi panel number	1 to 20
Custom_No	Customized display screen number (/CG)	1 to 30
DigitalPos	Digital display position	Default, Top, Bottom, Left, Right
DigitalLabel	Display string display	Off, On
Modbus_M	Modbus master status display type (/MC)	Overview, List
Modbus_C	Modbus client status display type (/MC)	Overview, List
Watt	WT communication status display type (/E2)	Overview, List
Switch	Internal switch/DO status display	All, 1, 2, 3, 4
SLMP_C	SLMP client status display type (/E4)	Overview, List
ControlGroup	Control group	Controller, Faceplate
ControlAlarm_Sort	Control alarm sort item	Time, Loop, Level, Type
ControlAlarm_Order	Control alarm sort order	Ascending, Descending
ControlAlarm_Time	Control alarm summary millisecond display	Off, On

Query SMonitor[, p1]?

Example Set the trend display to all-channel display.
 SMonitor, Trend, All

Description

- Custom_No is an option (/CG).
- Modbus_M and Modbus_C are an option (/MC).
- Watt is an option (/E2).
- When p1 = Switch, p2 = 3 or 4 is valid only for the GX10/GP10.

SMultiPattern

Multi Panel Division [GX/GP]

Sets the multi panel multi panel pattern.

Syntax `SMultiPattern,p1,p2,p3`
 p1 Registration number (1 to 20)
 p2 Multi panel pattern
 Wide2 Split 2 Wide
 Tall2 Split 2 Tall
 Wide3 Split 3 Wide
 Tall3 Split 3 Tall
 Split4 Split 4 Even
 Even5 Split 5 Even
 Odd5 Split 5 Odd
 Even6 Split 6 Even
 Odd6 Split 6 Odd
 p3 Multi panel name (up to 16 characters, UTF-8)

Query `SMultiPattern[,p1]?`

Example Set the panel of registration number 1 to "Split 2 Wide." Set the multi panel name to "Monitor1."
`SMultiPattern,1,Wide2,'Monitor1'`

Description

- This command is only valid for the GX20/GP20.
- This command can be used only when the multi batch function (/BT) is disabled.

SMultiKind

Multi Panel [GX/GP]

Set the screens to display on the multi panel.

Syntax `SMultiKind,p1,p2,p3,p4`
 p1 Registration number (1 to 20)
 p2 Screen position (1 to 6)
 p3 Screen type
 Trend Trend
 Digital Digital
 Bar Bar graph
 Overview OVERVIEW
 Alarm Alarm summary
 Message Message summary
 Memory Memory summary
 Report Report summary
 Modbus-M Modbus master status
 Mosbus-C Modbus client status
 Watt WT communication status
 Switch Internal switch status
 Action-Log Event log
 Error-Log Error log
 Commu-Log Communication log
 Ftp-Log FTP log
 Web-Log Web log
 Mail-Log Mail log
 Modbus-Log Modbus log
 Sntp-Log SNTP log
 Dhcp-Log DHCP log
 Network Network information
 SLMP-C SLMP client status (/E4)
 SLMP-Log SLMP log (/E4)
 Reminder Reminder (/AH)
 ControlGroup Control group
 ControlSummary Control summary
 ControlAlarmSummary Control alarm summary
 ControlOverview Control overview
 p4 Group number
 If p3=Trend, Digital, or Bar
 Display group number
 If p3=ControlGroup
 Control group number

Query `SMultiKind[,p1[,p2]]?`

Example Display the bar graph of display group 8 in screen position 3 of the registration number 1 panel.
`SMultiKind,1,3,Bar,8`

Description

- This command is only valid for the GX20/GP20.
- Report is an option (/MT).
- Modbus-M and Modbus-C are an option (/MC).
- Watt is an option (/E2).

2.4 Setting Commands

- Custom display screen (/CG) cannot be shown in a multi panel.
- This command can be used only when the multi batch function (/BT) is disabled.
- ControlGroup, ControlSummary, ControlAlarmSummary, and ControlOverview are valid when the PID control module is installed.

SHomeMonitor

Standard Screen Information [GX/GP]

Sets the standard screen display information.

- Syntax** SHomeMonitor, p1, p2
 p1 Information type (see the table of the **SMonitor** command)
 p2 Status (see the table of the **SMonitor** command)
- Query** SHomeMonitor[, p1]?
- Example** Set the trend display to all-channel display.
 SHomeMonitor, Trend, All

SHomeKind

Standard Screen [GX/GP]

Set the standard screen.

For Multi Panel

- Syntax** SHomeKind, p1, p2, p3
 p1 Screen type (Multi)
 p2 Multi panel number (1 to 20)
 p3 Batch group number (1 to the number used)
 p3 is valid when the multi batch function (/BT) is enabled.

For Screens other than Multi Panel

- Syntax** SHomeKind, p1, p2, p3
 p1 Screen type
- | | |
|------------|------------------------------|
| Trend | Trend |
| Digital | Digital |
| Bar | Bar graph |
| Overview | OVERVIEW |
| Alarm | Alarm summary |
| Message | Message summary |
| Memory | Memory summary |
| Report | Report summary |
| Modbus-M | Modbus master status |
| Mosbus-C | Modbus client status |
| Watt | WT communication status |
| Switch | Internal switch/relay status |
| Action-Log | Event log |
| Error-Log | Error log |
| Commu-Log | Communication log |
| Ftp-Log | FTP log |
| Web-Log | Web log |
| Mail-Log | Mail log |

- | | |
|----------------------|---------------------------|
| Modbus-Log | Modbus log |
| Sntp-Log | SNTP log |
| Dhcp-Log | DHCP log |
| SLMP-Log | SLMP log (/E4) |
| Network | Network information |
| SLMP-C | SLMP client status (/E4) |
| Reminder | Reminder (/AH) |
| Setting | Settings |
| ControlGroup | Control group |
| ControlSummary | Control summary |
| ControlAlarm Summary | Control alarm summary |
| ControlOverview | Control overview |
| SaveLoad | Save load |
| SystemInfo | System information |
| Custom | Customized display screen |

- Display
- Batch Overview Tuning
- ProgramSelect Program selection (/PG)
- ProgramRun Program operation (/PG)
- p2 Display group number (when p1 is not CustomDisplay) Customized display screen number (1 to 30) (when p1 is CustomDisplay) Control group number (1 to 10) (If p1=ControlGroup) Program pattern number (1 to 99) (If p1=ProgramSelect)
- p3 Batch group number (All, 1 to the number used) p3 is valid when the multi batch function (/BT) is enabled.

Query SHomeKind?

Example Set the standard screen to trend of display group 1.
 SHomeKind, Trend, 1

Description

- Report is an option (/MT).
- Modbus-M and Modbus-C are an option (/MC).
- Watt is an option (/E2).
- CustomDisplay is an option (/CG).
- Multi is a GX20/GP20 display.
- p3 is valid when the multi batch function (/BT) is enabled.
- When the multi batch function (/BT) is not available, p3 is fixed to 1.
- p1 cannot be set to BatchOverview when p3 is 1 to 12.
 P1 cannot be set to Trend, Digital, Bar, Alarm, Message, Memory, or Multi when p3 = All.
- p3 cannot be set to All when p1 is set to Trend, Digital, Bar, Alarm, Message, Memory, or Multi.
 p3 cannot be set to 1 to 12 when p1 is set to BatchOverview.

- ControlGroup, ControlSummary, ControlAlarmSummary, ControlOverview, and Tuning are valid when the PID control module is installed.
- ProgramSelect and ProgramRun are options (/PG).

SFavoriteMonitor

Favorite Screen Display Information [GX/GP]

Sets the favorite screen display information.

Syntax `SFavoriteMonitor,p1,p2,p3`
 p1 Favorites number (1 to 20)
 p2 Information type (see the table of the [SMonitor](#) command)
 p3 Status (see the table of the [SMonitor](#) command)

Query `SFavoriteMonitor[,p1[,p2]]?`

Example Set the trend display to all-channel display.
`SFavoriteMonitor,1,Trend,All`

SFavoriteKind

Favorite Screen [GX/GP]

Set the favorite screen.

For Multi Panel

Syntax `SFavoriteKind,p1,p2,p3,p4,p5,p6`
 p1 Favorites number (1 to 20)
 p2 Enable or disable (Off, On)
 p3 Screen type (Multi)
 p4 Multi panel number (1 to 20)
 p5 Panel name (up to 16 characters, UTF-8)
 p6 Batch group number (1 to the number used)
 p6 is valid when the multi batch function (/BT) is enabled.

For Screens other than Multi Panel

Syntax `SFavoriteKind,p1,p2,p3,p4,p5,p6`
 p1 Favorites number (1 to 20)
 p2 Enable or disable (Off, On)
 p3 Screen type (see p1 of the [SHomeKind](#) command)
 p4 Display group number (when p3 is not CustomDisplay)
 Customized display screen number (1 to 30)
 (when p3 is CustomDisplay)
 Control group number (1 to 10)
 (when p3 is ControlGroup)
 Program pattern number (1 to 99)
 (when p3 is ProgramSelect)
 p5 Favorite screen name (up to 16 characters, UTF-8)
 p6 Multi batch number (All, 1 to the number used)

Query `SFavoriteKind[,p1]`

Example Register the trend display of display group 2 to favorites screen number 1. Set the screen name to "Favorite01."

```
SFavoriteKind,1,On,Trend,2,'Favorite01'
```

Description

- When the multi batch function (/BT) is not available, p6 is fixed to 1.
- p1 cannot be set to BatchOverview when p3 is 1 to 12.
P1 cannot be set to Trend, Digital, Bar, Alarm, Message, Memory, or Multi when p3 = All.
- ControlGroup, ControlSummary, ControlAlarmSummary, ControlOverview, and Tuning are valid when the PID control module is installed.
- ProgramSelect and ProgramRun are options (/PG).

SMltTextField

Batch Text

Sets the batch text field for multi batch.

Syntax `SMltTextField,p1,p2,p3,p4`
 p1 Batch group number (1 to the number used)
 p2 Field number (1 to 24)
 p3 Title (up to 20 characters, UTF-8)
 p4 Character string (up to 30 characters, UTF-8)

Query `SMltTextField[,p1[,p2]]?`

Example For field number 3 of batch group 2, set the field title to "OPERATOR" and the character string to "RECORDER1."
`SMltTextField,2,3,'OPERATOR','RECORDER1'`

Description

- This command cannot be used if the batch setting is disabled (SBatch: p1=Off).
- This command is the same as STextField when p1=1.

SMltFileHead

File Header

Sets the file header for multi batch.

Syntax `SMltFileHead,p1,p2`
 p1 Batch group number (1 to the number used)
 p2 File header (up to 50 characters, UTF-8)

Query `SMltFileHead[,p1]?`

Example Set the batch group number to 1 and the file header to "GX_DATA."
`SMltFileHead,1,'GX_DATA'`

Description

- This command is the same as SFileHead when p1=1.

SMltFileName

File Naming Rule

Sets the file naming rule for saving multi batch data.

Syntax SMltFileName,p1,p2,p3

p1 Batch group number (1 to the number used)

p2 File naming rule

Date	Date
Serial	Serial number
Batch	Batch name

p3 Specified file name (up to 16 characters, ASCII)

Query SMltFileName[,p1]?

Example Set the file naming rule of batch group 2 to "Date."
Set the specified file name to "Recorder1_data."
SMltFileName,2,Date,'Recorder1_data'

Description

- This command is the same as SFileName when p1=1.
- If the batch setting is disabled (SBatch: p1=Off), p2 cannot be set to Batch.

SMltGroup

Display Group

Sets the display group for multi batch.

Syntax SMltGroup,p1,p2,p3,p4,p5

p1 Batch group number (1 to the number used)

p2 Display group number

p3 Enable or disable (Off, On)

p4 Group name (up to 16 characters, UTF-8)

p5 Channel character string

- Specify using channel numbers. 4-digit numbers for I/O channels. Numbers that start with "A" for math channels (A015). Numbers that start with "C" for communication channels (C020). The maximum number of characters per channel is 4.
- Use periods to separate channel numbers (see example).

Query SMltGroup[,p1[,p2]]?
The channel string is output exactly as it is specified.

Example Assign channels 0001, 0003, 0005, A001, and C023 to display group 1 of batch group 3 and name it "GROUP A."
SMltGroup,3,1,On,'GROUP A'1.3.5.A1.C23'

Description

- This command is the same as SGroup when p1=1.

SMltTripLine

Display Group Trip Line

Sets the display group trip line for multi batch.

Syntax SMltTripLine,p1,p2,p3,p4,p5,p6,p7,p8,p9

p1 Batch group number (1 to the number used)

p2 Display group number

p3 Trip line number (1 to 4)

p4 Enable or disable (Off, On)

p5 Display position [%] (1 to 100)

p6 R value of RGB display colors (0 to 255)

p7 G value of RGB display colors (0 to 255)

p8 B value of RGB display colors (0 to 255)

p9 Line width

(GX/GP: Thin, Normal, Thick)
(GM: Normal)
Thin Thin
Normal Normal
Thick Thick

Query SMltTripLine[,p1[,p2[,p3]]]?

Example Display trip line 1 using a thick line in red at the 80% position of display group 2 of batch group 3.
SMltTripLine,3,2,1,80,255,0,0,Thick

SMltScIbMp [GX/GP]

Scale Bitmap

Sets the display group's scale bitmap file for multi batch.

Syntax SMltScIbMp,p1,p2,p3

p1 Batch group number (1 to the number used)

p2 Display group number

p3 Enable or disable (Off, On)

Query SMltScIbMp[,p1[,p2]]?

Example Use a bitmap scale image on display group 3 of batch group 2.
SMltScIbMp,2,3,On

Description

- This command is valid for the GX20/GP20.
- This command is the same as SScIbMp when p1=1.

SMltMultiPattern

Multi Panel Pattern

Sets the multi panel pattern for multi batch.

Syntax SMltMultiPattern,p1,p2,p3,p4
 p1 Batch group number (1 to the number used)
 p2 Registration number (1 to 20)
 p3 Division pattern
 Wide2 Split 2 Wide
 Tall2 Split 2 Tall
 Wide3 Split 3 Wide
 Tall3 Split 3 Tall
 Split4 Split 4 Even
 Even5 Split 5 Even
 Odd5 Split 5 Odd
 Even6 Split 6 Even
 Odd6 Split 6 Odd
 p4 Panel name (up to 16 characters, UTF-8)

Query SMltMultiPattern[,p1[,p2]]?

Example Set batch group 2. Set the panel of registration number 1 to "Split 2 Wide." Set the panel name to "Monitor1."
 SMltMultiPattern,2,1,Wide2'Monit
 or1'

Description

- This command is valid for the GX20/GP20.
- This command is valid when the multi batch function (/BT) is enabled.

SMltMultiKind

Multi Panel Type

Sets the multi panel pattern for multi batch.

Syntax SMltMultiKind,p1,p2,p3,p4,p5
 p1 Batch group number (1 to the number used)
 p2 Registration number (1 to 20)
 p3 Screen position (1 to 6)
 p4 Screen type (see p1 of the SMultiKind command)
 p5 Display group number

Query SMltMultiKind[,p1[,p2[,p3]]]?

Example Set the panel of registration number 1 to "Split 2 Wide." Set the panel name to "Monitor1."
 SMultiPattern,1,Wide2,'Monitor1'

Description

- This command is valid for the GX20/GP20.
- This command is valid when the multi batch function (/BT) is enabled.

SBluetooth

Bluetooth Communication Function (/C8) [GM]

Sets the Bluetooth communication function.

Syntax SBluetooth,p1
 p1 Bluetooth function On/Off (On, Off)
 On Use
 Off Not Use

Query SBluetooth?

Example Use the Bluetooth communication function.
 SBluetooth,On

Description

- The settings specified with this command take effect with the **OBTAApply** command. The settings do not change until you send the OBTAApply command.

SBTID

Bluetooth Communication ID (/C8) [GM]

Sets the Bluetooth communication ID.

Syntax SBTID,p1
 p1 Local device name (GM's Bluetooth device name)
 Up to 30 characters, ASCII

Query SBTID?

Example Set the local device name to "SMARTDAC+ GM."
 SBTID,'SMARTDAC+ GM'

SBTTimeOut

Bluetooth Communication Timeout (/C8) [GM]

Sets the Bluetooth communication timeout.

Syntax SBTTimeOut,p1
 p1 Timeout function (Off, 1min, 2min, 5min, 10min)

Query SBTTimeOut?

Example Set the Bluetooth communication timeout value to 5 minutes.
 SBTTimeOut,5min

Description

- If the login function is in use, users that are logged in are automatically logged out when a timeout occurs.

SUsbFunction

USB Communication Function [GM]

Configures USB communication function settings.

Syntax SUsbFunction,p1
 p1 USB communication function On/Off (On, Off)
 On Use
 Off Not Use

Query SUsbFunction?

Example Use the USB communication function.

2.4 Setting Commands

SUsbFunction,On

Description

- The settings specified with this command take effect with the **OUsbFApply** command. The settings do not change until you send the OUsbFApply command.

SUsbAutoLOut

USB Communication Auto Logout [GM]

Sets the auto logout for USB communication.

Syntax SUsbAutoLOut,p1
p1 Auto logout function (Off, 1 min, 2 min, 5 min, 10 min)

Query SUsbAutoLOut?

Example Set the USB communication's auto logout time to 2 minutes.

SUsbAutoLOut,2min

Description

- Users logged in via USB communication can be automatically logged out.

SWebCustomMenu

Web Monitor Screen

Sets the contents displayed on the monitor screens.

Syntax SWebCustomMenu,p1,p2,p3,p4,p5
p1 User level (User, Monitor)
p2 Status display category (On, Off)
p3 Log category (On, Off)
p4 System category (On, Off)
p5 File category (On, Off)

Query SWebCustomMenu?

Example Display the log category and file category contents on the monitor screen when a user whose user level is User accessed.

SWebCustomMenu,User,Off,On,Off,On

Description

- This command can be executed only when the user is logged in as an administrator.
- p1=Monitor is valid when the advanced security function (/AS) is enabled.

SSchedule

Schedule Management

Configures the schedule management function.

Syntax SSchedule,p1,p2,p3,p4,p5,p6,p7,p8,p9
p1 Schedule number
p2 Schedule management function On/Off
On Use
Off Not Use
p3 Date Year (2001 to 2035)
p4 Date Month (1 to 12)
p5 Date Day (1 to 31)
p6 Notification date

1day 1 day before
2day 2 days before
3day 3 days before
4day 4 days before
5day 5 days before
6day 6 days before
7day 7 days before
8day 8 days before
9day 9 days before
10day 10 days before

p7 Renotification interval (10min, 30min, 1h, 8h, 24h)

p8 Notification buzzer (On, Off)

p9 Calibration correction settings (GX/GP: Off, On) (GM: Off)

On The calibration correction settings is shown in the date setting screen.

Off The calibration correction settings is not shown in the date setting screen.

Query SSchedule[,p1]?

Example Set schedule number 1 with the date set to December 24, 2015, the notification set to 5 days before, and the renotification interval to 1 hour. Enable the notification buzzer. Show the calibration correction settings in the date setting screen.

SSchedule,1,On,2015,12,24,5day,1h,On,On

Description

- This command can be used on a product with the aerospace heat treatment (/AH) option.
- Operation lock ChangeSet and user privileges CalibSet limitations apply to this command.

SScheduleText

Schedule Management Text

Sets the schedule management title and notification content.

Syntax SScheduleText,p1,p2,p3,p4
p1 Schedule number (1 to 12)
p2 Title (32 characters)
p3 Notification content 1 (32 characters)
p4 Notification content 2 (32 characters)

Query SScheduleText[,p1]?

Example For schedule number 1, set the title to "Calibration correction" and notification content 1 to "Sensor correction coefficient."
SScheduleText,1,"Calibration correction","Sensor coefficient"

Description

- This command can be used on a product with the aerospace heat treatment (/AH) option.
- Operation lock ChangeSet and user privileges CalibSet limitations apply to this command.

SDualGroup

Scan group number of the display group

If the measurement mode is set to dual interval, set the scan group of the display group.

Syntax `SDualGroup,p1,p2`
 p1 Group number
 p2 Scan group number (1 or 2)

Query `SDualGroup[,p1]?`

Example Set master scan interval to scan group 2.
`SDualGroup,5,2`

Description

- You can set this command when the dual interval function is enabled.

SMasterScanGrp

Master Scan Interval

Sets the master scan interval when the measurement mode is set to dual interval.

Syntax `SMasterScanGrp,p1`
 p1 Scan group number (1 or 2)

Query `SMasterScanGrp?`

Example Set display group 5 to scan group 2.
`SMasterScanGrp,2`

Description

- You can set this command when the dual interval function is enabled.

SCtrlMode

Control Mode

Sets the control mode.

Syntax `SCtrlMode,p1,p2,p3,p4`
 p1 Unit number
 p2 Module number
 p3 Mode (Single, Cascade, PVSwitching)
 Single Single loop control
 Cascade Cascade control
 PVSwitching PV switching
 p4 PV switching condition (when p3 is PVSwitching)
 LowRange Switch within range (Low side)
 HighRange Switch within range (High side)
 PVHigh Switch at PV high limit
 Signal Switch using DI

Query `SCtrlMode[,p1,p2]?`

Example Set the control mode of the PID module with module number 2, connected to the main unit, to PV switching and the switching condition to switch using DI.
`SCtrlMode,0,2,PVSwitching,Signal`

Description

- This command is valid when a PID Control Module is installed.

SCtrlScan

Control Period

Sets the control period.

Syntax `SCtrlScan,p1,p2,p3`
 p1 Unit number
 Fixed to “-”.
 p2 Module number
 Fixed to “-”.
 p3 Control period (100ms, 200ms)

Query `SCtrlScan?`

Example Set the control period to 100ms.
`SCtrlScan,-,-,100ms`

Description

- This command is valid when a PID Control Module is installed.

SCtrlAction

Control

Sets the control.

Syntax `SCtrlAction,p1,p2,p3`
 p1 Unit number
 p2 Module number
 p3 Power recovery action
 RESTART_CONT Continue
 RESTART_MAN Manual
 RESTART_AUTO Auto
 RESTART_RESET Reset

Query `SCtrlAction[,p1,p2]`

Example Set the power recovery action of module number 2 connected to the main unit to manual.
`SCtrlAction,0,2,RESTART_MAN`

Description

- This command is valid when a PID Control Module is installed.
- You can set p3 to RESTART_RESET when the program control function (/PG option) is enabled.

SCtrlType

Control Type

Sets the control type.

Syntax `SCtrlType,p1,p2`
 p1 Loop number
 p2 Control Type
 PID PID Control
 ONOFF ON/OFF control

Query `SCtrlType[,p1]?`

Example Set the control type of loop number L022 to ON/OFF control.
`SCtrlType,L022,ONOFF`

Description

- This command is valid when a PID Control Module is installed.

SCTrlLoopAction

Loop Control

Sets the loop control.

Syntax	SCTrlLoopAction, p1, p2, p3, p4, p5, p6	
p1	Loop number	
p2	PID initial value	
	PIDDef_TEMP	Temperature
	PIDDef_PRESS	Pressure flow rate
p3	PID selection	
	SP_SLCT	Target setpoint selection (when the /PG option is not installed)
	SP_SEG_SLCT	Target setpoint selection/segment PID method (when the /PG option is not installed)
	ZON_PV	Zone PID method (PV input)
	ZON_TSP	Zone PID method (final target setpoint)
	ZON_SP	Zone PID method (target setpoint)
	FIX_PID	Fixed local PID selection (PID number switching with event action)
p4	EXPV function	
	Off	EXPV (RPV) is used.
	On	EXPV (RPV) is not used.
p5	RSP function	
	Off	RSP is not used.
	On	RSP is used.
p6	PID control mode	
	FollowUp	Standard PID control mode
	Fixed-point	Fixed-point control mode

Query SCTrlLoopAction[, p1]?

Example Set the loop number L022 control as follows:

PID initial value: Temperature
 PID selection: Zone PID method (PV input)
 EXPV (RPV) function: Off
 RSP function: On
 PID control mode: Standard PID control mode

```
SCTrlLoopAction, L022, PIDDef_TEMP, ZON_PV, Off, On, FollowUp
```

Description

- This command is valid when a PID Control Module is installed.
- The RSP function of the secondary side cannot be set to On (p5=On) in cascade mode.
- The available options for p3 (PID selection) varies depending on whether the program control function (/PG option) is available.

SCTrlSPPID

Number of SP Groups, Number of PID Groups

Sets the number of SP groups, number of PID groups

Syntax SCTrlSPPID, p1, p2, p3

p1 Loop number

p2 SP group number (1 to 8)

p3 PID group number (1 to 8)

Query SCTrlSPPID[, p1]

Example For loop number L022, set the number of SP groups to 6 and the number of PID groups to 3.

```
SCTrlSPPID, L022, 6, 3
```

Description

- This command is valid when a PID Control Module is installed.

SCTrlALNo

Number of Control Alarms

Sets the number of control alarms

Syntax SCTrlALNo, p1, p2

p1 Loop number

p2 Number of control alarms (1 to 4)

Query SCTrlALNo[, p1]

Example For loop number L022, set the number of control alarms to 3.

```
SCTrlALNo, L022, 3
```

Description

- This command is valid when a PID Control Module is installed.

SCTrlAlmMode

Alarm Mode

Sets the alarm mode.

Syntax SCTrlAlmMode, p1, p2

p1 Loop number

p2 Alarm mode

ALM_MODE_ALWAYS	Always active
ALM_MODE_STOP	Not active in STOP mode
ALM_MODE_STOP_MAN	Not active in STOP or MAN mode

Query SCTrlAlmMode[, p1]

Example For loop number L022, set the alarm mode to always active.

```
SCTrlAlmMode, L022, ALM_MODE_ALWAYS
```

Description

- This command is valid when a PID Control Module is installed.

SCtrlDIRegist

Contact Registration

Registers a contact

Syntax SCtrlDIRegist, p1, p2, p3, p4

p1 Unit number

p2 Module number

p3 Action

A-M_LP1	AUTO/MAN Switch (A/M) LP1
A-M_LP2	AUTO/MAN Switch (A/M) LP2
R-L_LP1	REMOTE/LOCAL Switch (R/L) LP1
R-L_LP2	REMOTE/LOCAL Switch (R/L) LP2
S-R_LP1	STOP/RUN Switch (S/R) LP1
S-R_LP2	STOP/RUN Switch (S/R) LP2
CAS	Switch to Cascade (CAS)
AUTO_LP1	Switch to AUTO (AUTO) LP1
AUTO_LP2	Switch to AUTO (AUTO) LP2
MAN_LP1	Switch to MAN (MAN) LP1
MAN_LP2	Switch to MAN (MAN) LP2
REM_LP1	Switch to REMOTE (REM) LP1
REM_LP2	Switch to REMOTE (REM) LP2
LCL_LP1	Switch to LOCAL (LCL) LP1
LCL_LP2	Switch to LOCAL (LCL) LP2
AT_LP1	Auto-tuning START/STOP Switch (AT) LP1
AT_LP2	Auto-tuning START/STOP Switch (AT) LP2
SW	PV switching (SW)
ACK_LP1	Alarm ACK (ACK) LP1
ACK_LP2	Alarm ACK (ACK) LP2
SPBit0_LP1	Bit-0 of SP Number LP1
SPBit1_LP1	Bit-1 of SP Number LP1
SPBit2_LP1	Bit-2 of SP Number LP1
SPBit3_LP1	Bit-3 of SP Number LP1
SPBit0_LP2	Bit-0 of SP Number LP2
SPBit1_LP2	Bit-1 of SP Number LP2
SPBit2_LP2	Bit-2 of SP Number LP2
SPBit3_LP2	Bit-3 of SP Number LP2
PIDBit0_LP1	Bit-0 of PID Number LP1
PIDBit1_LP1	Bit-1 of PID Number LP1
PIDBit2_LP1	Bit-2 of PID Number LP1
PIDBit3_LP1	Bit-3 of PID Number LP1
PIDBit0_LP2	Bit-0 of PID Number LP2
PIDBit1_LP2	Bit-1 of PID Number LP2
PIDBit2_LP2	Bit-2 of PID Number LP2
PIDBit3_LP2	Bit-3 of PID Number LP2

p4 Terminal number

Off	No registration
DI1 to DI8	Contact input
DO1 to DO8	Contact output
ALM1_L1 to	Alarm status loop 1
ALM4_L1	
ALO1_L1 to	Alarm output loop 1
ALO4_L1	
ALM1_L2 to	Alarm status loop 2
ALM4_L2	
ALO1_L2 to	Alarm output loop 2
ALO4_L2	

Query SCtrlDIRegist[, p1, p2, p3] ?

Example Set the AUTO/MAN Switch (A/M) LP1 of module number 2 connected to the main unit to DI1.

```
SCtrlDIRegist, 0, 2, A-M_LP1, DI1
```

Description

- This command is valid when a PID Control Module is installed.
- ALM*_Lx(*=1 to 4, x=1 or 2) indicates the alarm status. ALM*_OUT_Lx(*=1 to 4, x=1 or 2) indicates the alarm output status including the relay action.
- The valid range of p4 options varies depending on the p3 (action) setting. For details, see the table below ("Validity of p3 settings and p4 terminal numbers").

Validity of p3 settings and p4 terminal numbers

x: valid

p3 action Description	Option	p4 options			Conditions in which p3 is valid when p4 is not Off
		Off DI1 to DI8 DO1 to DO8	ALM1_L1 to ALM4_L1 ALO1_L1 to ALO4_L1	ALM1_L2 to ALM4_L2 ALO1_L2 to ALO4_L2	
AUTO/MAN Switch (A/M) LP1	A-M_LP1	x	x	—	Valid when the control mode is not cascade
AUTO/MAN Switch (A/M) LP2	A-M_LP2	x	—	x	Valid when the control mode is not PV switching
REMOTE/LOCAL Switch (R/L) LP1	R-L_LP1	x	x	—	Valid when the RSP function is on (see odd loops)
REMOTE/LOCAL Switch (R/L) LP2	R-L_LP2	x	—	x	Valid when the RSP function is on (see even loops) Valid when the control mode is single loop (for cascade, the RSP function is fixed to off)
STOP/RUN Switch (S/R) LP1	S-R_LP1	x	x	—	Always valid
STOP/RUN Switch (S/R) LP2	S-R_LP2	x	—	x	Valid when the control mode is not PV switching
Switch to Cascade (CAS)	CAS	x	—	x	Valid when the control mode is cascade
Switch to AUTO (AUTO) LP1	AUTO_LP1	x	x	—	Valid when the control mode is not cascade
Switch to AUTO (AUTO) LP2	AUTO_LP2	x	—	x	Valid when the control mode is not PV switching
Switch to MAN (MAN) LP1	MAN_LP1	x	x	—	Valid when the control mode is not cascade

2.4 Setting Commands

p3 action		p4 options			Conditions in which p3 is valid when p4 is not Off
Description	Option	Off DI1 to DI8 DO1 to DO8	ALM1_ L1 to ALM4_ L1 ALO1_ L1 to ALO4_ L1	ALM1_ L2 to ALM4_ L2 ALO1_ L2 to ALO4_ L2	
Switch to MAN (MAN) LP2	MAN_LP2	x	—	x	Valid when the control mode is not PV switching
Switch to REMOTE (REM) LP1	REM_LP1	x	x	—	Valid when the RSP function is on (see odd loops)
Switch to REMOTE (REM) LP2	REM_LP2	x	—	x	Valid when the RSP function is on (see even loops) Valid when the control mode is single loop (for cascade, the RSP function is fixed to off)
Switch to LOCAL (LCL) LP1	LCL_LP1	x	x	—	Valid when the RSP function is on (see odd loops)
Switch to LOCAL (LCL) LP2	LCL_LP2	x	—	x	Valid when the RSP function is on (see even loops) Valid when the control mode is single loop (for cascade, the RSP function is fixed to off)
Auto-tuning START/ STOP Switch (AT) LP1	AT_LP1	x	x	—	Always valid
Auto-tuning START/ STOP Switch (AT) LP2	AT_LP2	x	—	x	Valid when the control mode is not PV switching
PV switching (SW)	SW	x	x	—	Valid when the control mode is PV switching and the input switching action is contact.
Alarm ACK (ACK) LP1	ACK_LP1	x	x	—	Always valid
Alarm ACK (ACK) LP2	ACK_LP2	x	—	x	Valid when the control mode is not PV switching
Bit-0 of SP Number LP1	SPBit0_LP1	x	x	—	Always valid
Bit-1 of SP Number LP1	SPBit1_LP1	x	x	—	Always valid
Bit-2 of SP Number LP1	SPBit2_LP1	x	x	—	Always valid
Bit-3 of SP Number LP1	SPBit3_LP1	x	x	—	Always valid

p3 action		p4 options			Conditions in which p3 is valid when p4 is not Off
Description	Option	Off DI1 to DI8 DO1 to DO8	ALM1_ L1 to ALM4_ L1 ALO1_ L1 to ALO4_ L1	ALM1_ L2 to ALM4_ L2 ALO1_ L2 to ALO4_ L2	
Bit-0 of SP Number LP2	SPBit0_LP2	x	—	x	Valid when the control mode is not PV switching
Bit-1 of SP Number LP2	SPBit1_LP2	x	—	x	Valid when the control mode is not PV switching
Bit-2 of SP Number LP2	SPBit2_LP2	x	—	x	Valid when the control mode is not PV switching
Bit-3 of SP Number LP2	SPBit3_LP2	x	—	x	Valid when the control mode is not PV switching
Bit-0 of PID Number LP1	PIDBit0_LP1	x	x	—	Valid when the PID selection is external selection (see odd loop settings)
Bit-1 of PID Number LP1	PIDBit1_LP1	x	x	—	Valid when the PID selection is external selection (see odd loop settings)
Bit-2 of PID Number LP1	PIDBit2_LP1	x	x	—	Valid when the PID selection is external selection (see odd loop settings)
Bit-3 of PID Number LP1	PIDBit3_LP1	x	x	—	Valid when the PID selection is external selection (see odd loop settings)
Bit-0 of PID Number LP2	PIDBit0_LP2	x	—	x	Valid when the PID selection is external selection (see even loop settings) Valid when the control mode is not PV switching
Bit-1 of PID Number LP2	PIDBit1_LP2	x	—	x	Valid when the PID selection is external selection (see even loop settings). Valid when the control mode is not PV switching.

p3 action		p4 options			Conditions in which p3 is valid when p4 is not Off
Description	Option	Off DI1 to DI8 DO1 to DO8	ALM1_ L1 to ALM4_ L1 ALO1_ L1 to ALO4_ L1	ALM1_ L2 to ALM4_ L2 ALO1_ L2 to ALO4_ L2	
Bit-2 of PID Number LP2	PIDBit2_ LP2	x	—	x	Valid when the PID selection is external selection (see even loop settings) Valid when the control mode is not PV switching
Bit-3 of PID Number LP2	PIDBit3_ LP2	x	—	x	Valid when the PID selection is external selection (see even loop settings) Valid when the control mode is not PV switching

SCtrlRelay

DO Terminal Action (Relay Action)

Sets the DO terminal action (relay action) of a PID module.

When the output is “contact output within module”

Syntax SCtrlRelay, p1, p2, p3, p4, p5, p6, p7

- p1 Unit number
- p2 Module number
- p3 DO number (DO1 to DO8)
- p4 Output type
 - CtrlRelay Contact output within module
- p5 Loop selection
 - LP1 Loop 1
 - LP2 Loop 2
 - COMMON Common to loop 1 and loop 2
- p6 Status (see the table below)

The valid range of p6 (status) varies depending on the p5 (loop) options.
- p7 Energize/De-energize (Energize, De_Energize)
 - Energize Energize
 - De_Energize De-energize

p6 (status)	Content	p5 (loop)
OFF	OFF	LP1, LP2, COMMON
ALM1_OUT_L1	Alarm 1 status loop 1	LP1
ALM2_OUT_L1	Alarm 2 status loop 1	LP1
ALM3_OUT_L1	Alarm 3 status loop 1	LP1
ALM4_OUT_L1	Alarm 4 status loop 1	LP1
ALM1_L1	Alarm 1 loop 1	LP1
ALM2_L1	Alarm 2 loop 1	LP1
ALM3_L1	Alarm 3 loop 1	LP1
ALM4_L1	Alarm 4 loop 1	LP1
SR_L1	STOP/RUN loop 1	LP1
AM_L1	AUTO/MAN loop 1	LP1
RL_L1	REMOTE/LOCAL loop 1	LP1
AT_L1	Auto-tuning status loop 1	LP1
EXPV_ANAPV_L1	EXPV/LOCAL loop 1	LP1
ALM1_OUT_L2	Alarm 1 status loop 2	LP2
ALM2_OUT_L2	Alarm 2 status loop 2	LP2
ALM3_OUT_L2	Alarm 3 status loop 2	LP2
ALM4_OUT_L2	Alarm 4 status loop 2	LP2
ALM1_L2	Alarm 1 loop 2	LP2
ALM2_L2	Alarm 2 loop 2	LP2
ALM3_L2	Alarm 3 loop 2	LP2
ALM4_L2	Alarm 4 loop 2	LP2
SR_L2	STOP/RUN loop 2	LP2
AM_L2	AUTO/MAN loop 2	LP2
AUTO_L2	AUTO loop 2	LP2
MAN_L2	MAN loop 2	LP2
CAS_L2	Cascade loop 2	LP2
RL_L2	REMOTE/LOCAL loop 2	LP2
AT_L2	Auto-tuning status	LP2
EXPV_ANAPV_L2	EXPV/LOCAL loop 2	LP2
DI1	DI1 status output	COMMON
DI2	DI2 status output	COMMON
DI3	DI3 status output	COMMON
DI4	DI4 status output	COMMON

2.4 Setting Commands

DI5	DI5 status output	COMMON
DI6	DI6 status output	COMMON
DI7	DI7 status output	COMMON
DI8	DI8 status output	COMMON
AI1_BOUT	AI1 burnout	COMMON
AI1_ADERR	AI1 AD error	COMMON
AI2_BOUT	AI2 burnout	COMMON
AI2_ADERR	AI2 AD error	COMMON

When the output is “Alarm” and the action is “And/Or”

Syntax SCtrlRelay,p1,p2,p3,p4,p5,p6,p7,p8

p1 Unit number

p2 Module number

p3 DO number (DO1 to DO8)

p4 Output type

Alarm	Alarm
-------	-------

p5 Energize/De-energize (Energize, De_ Energize)

Energize	Energize
De_ Energize	De-energize

p6 Action (And, Or)

And	Operate when all set alarms are in the alarm state.
Or	Operate when any of the set alarms are in the alarm state.

p7 State

Hold	Hold
Nonhold	Nonhold

p8 Relay Action on ACK (Normal, Reset)

When the output is “Alarm” and the action is “Reflash”

Syntax SCtrlRelay,p1,p2,p3,p4,p5,p6,p7,p8

p1 Unit number

p2 Module number

p3 DO number (DO1 to DO8)

p4 Output type

Alarm	Alarm
-------	-------

p5 Energize or de-energize

Energize	Energize
De_ Energize	De-energize

p6 Action

Reflash	Reflash
---------	---------

p7 Reflash time (500ms, 1s, 2s)

p8 Relay Action on ACK (Normal, Reset)

When the output is “Manual”

Syntax SCtrlRelay,p1,p2,p3,p4,p5

p1 Unit number

p2 Module number

p3 DO number (DO1 to DO8)

p4 Output type

Manual	Manual
--------	--------

p5 Energize or de-energize

Energize	Energize
De_ Energize	De-energize

Query SCtrlRelay[,p1,p2,p3]?

Example Set DO1 of module number 2 connected to the main unit to manual and energize.

```
SCtrlRelay,0,2,DO1,Manual,Energize
```

Description

- This command is valid when a PID Control Module is installed.
- If p4=CtrlRelay, p6 alarm level is indicated as ALM*_Lx(*=1 to 8, x=1 or 2). ALM*_OUT_Lx(*=1 to 8, x=1 or 2) indicates the alarm output status including the relay action.

SCtrlRangeAI

Measurement Input Range

Sets the range of the AI terminal of a PID control module.

Input type is TC or RTD

Syntax SCtrlRangeAI,p1,p2,p3,p4,p5,p6,p7,p8,p9

p1 Unit number

p2 Module number

p3 AI terminal number (AI1, AI2)

p4 Input type (TC, RTD)

p5 Range (see “Description.”)

p6 Math type (Off)

p7 Span low limit

p8 Span high limit

p9 Bias (–999999 to 999999)

Input type is not TC or RTD and math type is Scaling

Syntax SCtrlRangeAI,p1,p2,p3,p4,p5,p6,p7,p8,p9,p10,p11,p12,p13

p1 Unit number

p2 Module number

p3 AI terminal number (AI1, AI2)

p4 Input type (Volt, GS, DI)

p5 Range (see “Description.”)

p6 Math type (Scale)

p7 Span low limit

p8 Span high limit

p9 Bias (–999999 to 999999)

p10 Decimal Place (0 to 5)

p11 Scaling low limit

p12 Scaling high limit

p13 Unit (up to 6 characters, UTF-8)

Input type is GS or Volt and math type is square root

Syntax SCtrlRangeAI,p1,p2,p3,p4,p5,p6,p7,p8,p9,p10,p11,p12,p13,p14,p15,p16

p1 Unit number

p2 Module number

p3 AI terminal number (AI1, AI2)

p4 Input type (Volt, GS)

p5 Range (see “Description.”)

p6 Math type (Sqrt)

p7 Span low limit

p8 Span high limit

- p9 Bias (-999999 to 999999)
- p10 Decimal Place (0 to 5)
- p11 Scaling low limit
- p12 Scaling high limit
- p13 Unit (up to 6 characters, UTF-8)
- p14 Low-cut function (Off, On)
- p15 Low-cut point (0 to 50)
- p16 Low-cut operation mode (Zero, Linear)

Query `SCtrlRangeAI[,p1,p2,p3]?`

Example Measure -0.5000 to 1.0000 V on channel 0002. No scaling. No bias.
`SCtrlRangeAI,0002,Volt,2V,0ff,-5000,10000,0`

Description

- This command is valid when a PID Control Module is installed.
- You cannot use this command to configure settings while recording is in progress.
- You cannot use this command to configure settings while computation is in progress.
- If p4=TC/RTD, p6 is set to Off.
- If p4=TC/RTD/DI, p6 cannot be set to Sqrt.
- If p4=Volt/GS/DI, p6 cannot be set to Off.
- If p4=DI, you cannot set p9 (bias).
- The settable items for p5 are shown in the table below.

p4=Volt	p4=TC	p4=RTD	p4=GS	p4=DI
20mV	R	Pt100	1-5V	Level
60mV	S	Pt100-H	0.4-2V	DI
200mV	B	JPt100		
1V	K	JPt100-H		
2V	K-H	Cu10GE		
6V	E	Cu10LN		
20V	J	Cu10WEED		
50V	T	Cu10BAILEY		
	N	Cu10a392		
	W	Cu10a393		
	L	Cu25		
	U	Cu53		
	PLATINEL	Cu100		
	PR20-40	J263B		
	WRe3-25	Ni100SAMA		
	KpvsAu7Fe	Ni100DIN		
	NiNiMo	Ni120		
	WRe26	Pt25		
	N14	Pt50		
	XK	Pt200WEED		
		Cu10G		
		Cu50G		
		Cu100G		
		Pt46G		
		Pt100G		

- For the setting ranges of p7 (span low limit) and p8 (span high limit), see the PID Control User's Manual (IM 04L51B01-31EN).

SCtrlBurnOut

Burnout Mode

Sets the burnout action of the AI terminal of a PID module.

Syntax `SCtrlBurnOut,p1,p2,p3,p4`
 p1 Unit number
 p2 Module number
 p3 AI terminal number (AI1, AI2)
 p4 Burnout action (Off, Up, Down)

Query `SCtrlBurnOut[,p1,p2,p3]?`

Example When a burnout is detected on AI1 of module number 2 connected to the main unit, set the terminal to UP.
`SBurnOut,0,2,AI1,Up`

Description

- This command is valid when a PID Control Module is installed.
- You cannot use this command to configure settings while recording is in progress.
- You cannot use this command to configure settings while computation is in progress.

SCtrlRjc

RJC temperature

Sets the RJC temperature of the AI terminal of a PID control module.

Syntax `SCtrlRjc,p1,p2,p3,p4,p5`
 p1 Unit number
 p2 Module number
 p3 AI terminal number (AI1, AI2)
 p4 Mode (Internal, External)
 Internal Internal
 External External
 p5 Compensation temperature
 Fahrenheit -40 to 1760
 Celsius -200 to 800
 Absolute 2531~3532
 temperature

Query `SCtrlRjc[,p1,p2,p3]?`

Example Set the reference junction compensation of AI1 of module number 2 connected to the main unit to internal compensation circuit.
`SCtrlRjc,0,2,AI1,Internal`

Set the reference junction compensation of AI1 of module number 2 connected to the main unit to external reference junction compensation and the compensation temperature to -2.3.
`SCtrlRjc,0,2,AI1,External,-23`

Description

- This command is valid when a PID Control Module is installed.
- You cannot use this command to configure settings while recording is in progress.
- You cannot use this command to configure settings while computation is in progress.
- If p4=Internal, you cannot set p5.
- Absolute temperature (K) is valid when the input type is TC and the range type is KpvsAu7Fe.

SCtrlFilter

First-Order Lag Filter

Sets the first-order lag filter of the AI terminal of the PID control module.

Syntax `SCtrlFilter,p1,p2,p3,p4,p5`
 p1 Unit number
 p2 Module number
 p3 AI terminal number (AI1, AI2)
 p4 Enable or disable (On, Off)
 p5 First-order lag constant (0 to 120) Unit: sec

Query `SCtrlFilter[,p1,p2,p3]?`

Example Set the first-order lag of AI1 of module number 2 connected to the main unit to 110 (s).
`SCtrlFilter,0,2,AI1,On,110`

Description

- This command is valid when a PID Control Module is installed.

SCtrlCalibAI

Calibration Correction

Sets the calibration correction of the AI terminal of the PID control module.

Disable Calibration Correction

Syntax `SCtrlCalibAI,p1,p2,p3,p4`
 p1 Unit number
 p2 Module number
 p3 AI terminal number (AI1, AI2)
 p4 Linearizer mode
 Off Correction is not performed.

Use Calibration Correction (Linearizer approximation, linearizer bias)

Syntax `SCalibIO,p1,p2,p3,p4,p5,p6,p7,p8,p9,p10,p11,p12,p13,p14,p15,p16,p17,p18,p19p,20p,p21,p22,p23,p24,p25,p26,p27,p28,p29`
 p1 Unit number
 p2 Module number
 p3 AI terminal number (AI1, AI2)
 p4 Linearizer mode
 Appro Linearizer approximation
 Bias Linearizer bias
 p5 Number of segmental points (2 to 12)
 p6 Input value of segmental point 1
 p7 Output value of segmental point 1
 p8 Input value of segmental point 2
 p9 Output value of segmental point 2
 p10 Input value of segmental point 3 (number of segmental points ≥ 3)
 p11 Output value of segmental point 3 (number of segmental points ≥ 3)
 p12 Input value of segmental point 4 (number of segmental points ≥ 4)
 p13 Output value of segmental point 4 (number of segmental points ≥ 4)
 p14 Input value of segmental point 5 (number of segmental points ≥ 5)

p15 Output value of segmental point 5 (number of segmental points ≥ 5)
 p16 Input value of segmental point 6 (number of segmental points ≥ 6)
 p17 Output value of segmental point 6 (number of segmental points ≥ 6)
 p18 Input value of segmental point 7 (number of segmental points ≥ 7)
 p19 Output value of segmental point 7 (number of segmental points ≥ 7)
 p20 Input value of segmental point 8 (number of segmental points ≥ 8)
 p21 Output value of segmental point 8 (number of segmental points ≥ 8)
 p22 Input value of segmental point 9 (number of segmental points ≥ 9)
 p23 Output value of segmental point 9 (number of segmental points ≥ 9)
 p24 Input value of segmental point 10 (number of segmental points ≥ 10)
 p25 Output value of segmental point 10 (number of segmental points ≥ 10)
 p26 Input value of segmental point 11 (number of segmental points ≥ 11)
 p27 Output value of segmental point 11 (number of segmental points ≥ 11)
 p28 Input value of segmental point 12 (number of segmental points ≥ 12)
 p29 Output value of segmental point 12 (number of segmental points ≥ 12)

Use Calibration Correction (Correction coefficient)

Syntax `SCtrlCalibAI,p1,p2,p3,p4,p5,p6,p7,p8,p9,p10,p11,p12,p13,p14,p15,p16,p17,p18,p19p,20p,p21,p22,p23,p24,p25,p26,p27,p28,p29,p30,p31,p32,p33,p34,p35,p36,p37,p38,p39,p40,p41`
 p1 Unit number
 p2 Module number
 p3 AI terminal number (AI1, AI2)
 p4 Linearizer mode
 Correct Correction Factor
 p5 Number of correction points (2 to 12)
 p6 Uncorrected value 1
 p7 Instrument correction coefficient 1
 p8 Sensor correction coefficient 1
 p9 Uncorrected value 2
 p10 Instrument correction coefficient 2
 p11 Sensor correction coefficient 2
 p12 Uncorrected value 3 (number of segmental points ≥ 3)
 p13 Instrument correction factor 3 (number of segmental points ≥ 3)
 p14 Sensor correction factor 3 (number of segmental points ≥ 3)
 p15 Uncorrected value 4 (number of segmental points ≥ 4)
 p16 Instrument correction factor 4 (number of segmental points ≥ 4)
 p17 Sensor correction factor 4 (number of segmental points ≥ 4)
 p18 Uncorrected value 5 (number of segmental points ≥ 5)

- p19 Instrument correction factor 5 (number of segmental points ≥ 5)
- p20 Sensor correction factor 5 (number of segmental points ≥ 5)
- p21 Uncorrected value 6 (number of segmental points ≥ 6)
- p22 Instrument correction factor 6 (number of segmental points ≥ 6)
- p23 Sensor correction factor 6 (number of segmental points ≥ 6)
- p24 Uncorrected value 7 (number of segmental points ≥ 7)
- p25 Instrument correction factor 7 (number of segmental points ≥ 7)
- p26 Sensor correction factor 7 (number of segmental points ≥ 7)
- p27 Uncorrected value 8 (number of segmental points ≥ 8)
- p28 Instrument correction factor 8 (number of segmental points ≥ 8)
- p29 Sensor correction factor 8 (number of segmental points ≥ 8)
- p30 Uncorrected value 9 (number of segmental points ≥ 9)
- p31 Instrument correction factor 9 (number of segmental points ≥ 9)
- p32 Sensor correction factor 9 (number of segmental points ≥ 9)
- p33 Uncorrected value 10 (number of segmental points ≥ 10)
- p34 Instrument correction factor 10 (number of segmental points ≥ 10)
- p35 Sensor correction factor 10 (number of segmental points ≥ 10)
- p36 Uncorrected value 11 (number of segmental points ≥ 11)
- p37 Instrument correction factor 11 (number of segmental points ≥ 11)
- p38 Sensor correction factor 11 (number of segmental points ≥ 11)
- p39 Uncorrected value 12 (number of segmental points ≥ 12)
- p40 Instrument correction factor 12 (number of segmental points ≥ 12)
- p41 Sensor correction factor 12 (number of segmental points ≥ 12)

Query `SCTrlCalibAI[,p1,p2,p3]?`

Example Set three correction points on channel 0001 (measurement range: 0 to 1.0000 V). Set the correction points as follows: when the input value is 0 V, the output value is 0.0010 V; when the input value is 0.5000 V, the output value is 0.5020 V; when the input value is 1.0000 V, the output value is 0.9970 V.

`SCTrlCalibAI,0001,Appro,
3,0,10,5000,5020,10000,9970`

Description

- This command is valid when a PID Control Module is installed.
- If p4=Off, you cannot set p5 and subsequent parameters.
- You cannot set correction points beyond the number of points specified by p5.

- If the AI channel input type (p4 of the **SCTrlRangeAI** command) is set to Skip or DI, you cannot specify anything other than p4=Off.

SCTrlRangeAO

Transmission Output

Sets the transmission output range of the AO terminal of a PID control module.

Syntax `SCTrlRangeAO,p1,p2,p3,p4,p5,p6,p7`

p1 Unit number

p2 Module number

p3 AO terminal number (AO1, AO2)

p4 Transmission output (On, Off)

Off

On

p5 Terminal number

OUT1

PV1

SP1

OUT2

PV2

SP2

p6 Scaling low limit (–30000 to 30000)

p7 Scaling high limit (–30000 to 30000)

Query `SCTrlRangeAO[,p1,p2,p3]?`

Example Set the output of AO1 of module number 2 connected to the main unit to PV1.

`SCTrlRangeAO,0,2,AO1,On,
PV1,-30000,30000`

Description

- This command is valid when a PID Control Module is installed.
- If p4=Off, p5 will be set in the following combinations.

Control mode	p3=AO1	p3=AO2
Single loop or Cascade	p5=OUT1	p5=OUT2
PV switching	p5=OUT1	p5=OUT1

- p5 cannot be set to OUT2, PV2 or SP2 when the control mode is “PV switching”.

SCTrlSplitAO

Split Computation

Sets the split computation of the AO terminal of the PID control module

Syntax `SCTrlSplitAO,p1,p2,p3,p4,p5,p6,p7`
 p1 Unit number
 p2 Module number
 p3 AO terminal number (AO1, AO2)
 p4 Linearizer mode (Off)
 Off
 On
 p5 Value at the segmental point for output 0% (-1000 to 2000)
 p6 Value at the segmental point for output 100% (-1000 to 2000)

Query `SCTrlSplitAO[,p1,p2,p3]?`

Description

- This command is valid when a PID Control Module is installed.
- If p4=Off, you cannot set p5 and subsequent parameters.

SCTrlOutput

Control Output

Sets the output type of the AO terminal of a PID control module.

Syntax `SCTrlOutput,p1,p2,p3,p4,p5,p6`
 p1 Unit number
 p2 Module number
 p3 AO terminal number (AO1, AO2)
 p4 Control output type
 Current-output Current output
 Voltage-pulse Voltage pulse output
 VDC-power 15 VDC power supply
 p5 Cycle time (5 to 10000)
 0.5 (s) to 1000.0 (s)
 p6 Analog output type
 4-20mA
 0-20mA
 20-4mA
 20-0mA

Query `SCTrlOutput[,p1]?`

Example Sets the AO1 output of module number 2 connected to the main unit to current, 800 s cycle time, and 4-20mA analog output type.
`SCTrlOutput,0,2,AO1,Current-output,800,4-20mA`

Description

- This command is valid when a PID Control Module is installed.

SCTrlRangePV

Control Input Range

Sets the control input range.

Syntax `SCTrlRangePV,p1,p2,p3,p4,p5`
 p1 Loop number
 p2 PV range low limit (-30000 to 30000)
 p3 PV range high limit (-30000 to 30000)
 p4 PV range decimal place (0 to 4)
 p5 Unit (up to 6 characters, UTF-8)

Query `SCTrlRangePV[,p1]?`

Example For loop number L022, set the PV range to -30000 to 30000, decimal place to 2, and unit to "UniA."
`SCTrlRangePV,L022,-30000,30000,2,'UniA'`

Description

- This command is valid when a PID Control Module is installed.
- Set PV range high and low limits (p2, p3) so that $p2 < p3$ and $p3 - p2 \leq 30000$ are satisfied.

SCTrlPVSwitch

Input Switching PV for PV Switching

Sets the input switching PV value for PV switching

Syntax `SCTrlPVSwitch,p1,p2,p3`
 p1 Loop number
 p2 Input switching PV low limit (PV range low limit to PV range high limit)
 p3 Input switching PV high limit (PV range low limit to PV range high limit)

Query `SCTrlPVSwitch[,p1]?`

Example For loop number L022, set the input switching PV value to -30000 to 30000.

`SCTrlPVSwitch,L022,-30000,30000`

Description

- This command is valid when a PID Control Module is installed.
- If the PV switching condition is set to low temperature range or high temperature range, set input switching PV low limit to a value less than input switching PV high limit. (See the SCTrlMode command.)

SCTrlCalc

EXPV/RSP Function Setting

Sets the reference source of EXPV and RSP.

Syntax `SCTrlCalc,p1,p2,p3,p4`

p1 Loop number

p2 PVSP number

EXPV

RSP

EXPV2

p3 Channel type (IO, Math, Com, Off)

IO Input channel

Math Math channel (/MT)

Com Communication channel (/MC)

Off

p4 Channel number or terminal number

If p3=IO 0001 to 6532

If p3=Math 001 to 200

If p3=Com 001 to 500

If p3=AI 01 to 02

Query `SCTrlOutput[,p1]?`

Example For loop number L022, set EXPV of PV1 to channel A001.

`SCTrlCalc,L022,EXPV,Math,001`

Description

- This command is valid when a PID Control Module is installed.
- p2 can be set to EXPV1 or EXPV2 when the EXPV function is enabled.
- p2 can be set to RSP when the RSP function is enabled.
- p2 can be set to EXPV2 when the EXPV function is enabled and PV switching is used.
- p3 can be set to Off when the EXPV function is enabled, and p2=EXPV or EXPV2 in PV switching.

SCTrlFilterSP

Remote SP Filter

Sets the remote SP filter.

Syntax `SCTrlFilterSP,p1,p2,p3`

p1 Loop number

p2 Filter on/off

Off

On

p3 Filter value (1 to 120)

1 to 120 s

Query `SCTrlFilterSP[,p1]?`

Example For loop number L022, set the remote SP filter to 120 s.

`SCTrlFilterSP,L022,On,120`

Description

- This command is valid when a PID Control Module is installed.

SCTrlRatioSP

Remote SP Ratio

Sets the remote SP ratio.

Syntax `SCTrlRatioSP,p1,p2,p3`

p1 Loop number

p2 Ratio setting on/off

Off

On

p3 Ratio value (1 to 9999)

0.001 to 9.999 Fixed to three decimal places

Query `SCTrlFilterSP[,p1]?`

Example For loop number L022, set the remote SP filter to 120 s.

`SCTrlFilterSP,L022,On,120`

Description

- This command is valid when a PID Control Module is installed.

SCTrlBiasSP

Remote SP Bias

Sets the remote SP bias.

Syntax `SCTrlBiasSP,p1,p2,p3`

p1 Loop number

p2 Remote bias on/off

Off

On

p3 Remote bias value (-100% to 100% of PV range span)

Example For 10.0° to 100.0° -90.0° to 90.0° (-900 to 900)

Query `SCTrlBiasSP[,p1]?`

Example For loop number L022, set the remote SP bias to -150.0.

`SCTrlBiasSP,L022,On,-1500`

Description

- This command is valid when a PID Control Module is installed.

SCTrlErrPreOut

Input Error Preset Output

Sets the output value for when input errors occur.

Syntax `SCTrlErrPreOut,p1,p2`

p1 Loop number

p2 Preset output value for input error

PRESET Preset output

OUT0% Control output 0%

OUT100% Control output 100%

Query `SCTrlErrPreOut[,p1]?`

Example For loop number L022, set the output value for when input errors occur to control output 100%.

`SCTrlErrPreOut,L022,OUT100%`

Description

2.4 Setting Commands

- This command is valid when a PID Control Module is installed.

SCTrlOutLimit

Output Limiter Function in Manual Mode

Sets the output limiter function in manual mode

Syntax SCTrlOutLimit,p1,p2

p1 Loop number

p2 Output limiter switch

Off Disable the output limiter in manual mode.

On Enable the output limiter in manual mode.

Query SCTrlOutLimit[,p1]?

Example For loop number L022, enable the output limiter function.

SCTrlOutLimit,L022,On

Description

- This command is valid when a PID Control Module is installed.

SCTrlAlarm

Control Alarm

Sets the control alarm type and action

Syntax SCTrlAlarm,p1,p2,p3,p4,p5,p6,p7,p8,p9,p10,p11,p12,p13

p1 Loop number

p2 Alarm number (1 to 4)

p3 On/Off (Off, On)

p4 Type of alarm

PV-High PV high limit

PV-Low PV low limit

SP-High SP high limit

SP-Low SP low limit

Dev-High Deviation high limit

Dev-Low Deviation low limit

Dev-HL Deviation H/L limits

Dev-HL-In Deviation within H/L limits

OUT-High Control output high limit

OUT-Low Control output low limit

PV-Rate PV velocity

p5 Standby action

On On

Off Off

p6 Hysteresis (0 to 30000)

p7 On delay timer (min) (0 to 99)

p8 On delay timer (sec) (0 to 59)

p9 Off delay timer (min) (0 to 99)

p10 Off delay timer (sec) (0 to 59)

p11 Relay action

off Nonhold

Relay1 Hold

Relay2 Relay action on hold & ACK
Reset

Relay3 Relay action on nonhold & ACK

Reset

Relay4 Relay action on hold & ACK
Normal

p12 PV velocity alarm time setpoint (min) (0 to 99)

p13 PV velocity alarm time setpoint (sec) (0 to 59)

Query SCTrlAlarm[,p1,p2]?

Example For alarm number 8 of loop number L022, set the alarm type to PV high limit, no standby action, hysteresis to 150.5, on delay timer to 80min 00s, and relay action to normal.

SCTrlAlarm,L022,8,On,PV-High,Off,150.5,80,00,Relay4

Description

- This command is valid when a PID Control Module is installed.
- The decimal place of p6 is synchronized to the control PV input range of SCTrlRangePV.
- The setting range of PV velocity alarm time is 0.01 to 99.59 (min, sec).
- PV velocity alarm time setpoint can be set when p4 is set to PV-Rate (PV velocity).

SCTrlAlarmVal

SPNo Group Setting 1 (Control Alarm)

Sets the control alarm value

Syntax SCTrlAlarmVal,p1,p2,p3,p4,p5,p6

p1 Loop number

p2 Target setpoint number (1 to 8)

p3 Alarm value 1 (-30000 to 30000)

p4 Alarm value 2 (-30000 to 30000)

p5 Alarm value 3 (-30000 to 30000)

p6 Alarm value 4 (-30000 to 30000)

Query SCTrlAlarmVal [,p1,p2]?

Example For loop number L022, set the alarm value of alarm number 8 of target setpoint number 5 to 2500.5.

SCTrlAlarmVal,L022,5,8,2500.5

Description

- This command is valid when a PID Control Module is installed.
- Alarm values p3 to p6 can be set regardless of the number of alarms.

SCTrlSP**SPNo Group Setting 2 (Target Setpoint Alarm)**

Sets the target setpoint

Syntax `SCTrlSP,p1,p2,p3`
 p1 Loop number
 p2 Target setpoint number (1 to 8)
 p3 Target setpoint (target setpoint low limit to target setpoint high limit)

Query `SCTrlSP[,p1,p2]?`

Example For loop number L022, set the target setpoint of target setpoint number 8 to -2500.5.

`SCTrlSP,L022,8,-25005`

Description

- This command is valid when a PID Control Module is installed.

SCTrlSPGradient**SPNo Group Setting 3 (Target Setpoint Ramp-Rate)**

Sets the target setpoint ramp-rate

Syntax `SCTrlSPGradient,p1,p2,p3,p4,p5,p6`
 p1 Loop number
 p2 Target setpoint number (fixed to "-")
 p3 Target setpoint ramp-down rate

Off

On

p4 Target setpoint ramp-down rate value
 0.0 + 1 digit to 100.0 (%) of the PV range span

Example 0.1 to 100.0° (1 to 1000) when the PV range is 0.0 to 100.0°

p5 Target setpoint ramp-up rate

Off

On

p6 Target setpoint ramp-up rate value
 0.0 + 1 digit to 100.0 (%) of the PV range span

Example 0.1 to 100.0° (1 to 1000) when the PV range is 0.0 to 100.0°

Query `SCTrlSPGradient[,p1]?`

Example For loop number L022, set the ramp-down rate to 350.4 and the ramp-up rate to 580.9.

`SCTrlSPGradient,L022,On,3504,On,5809`

Description

- This command is valid when a PID Control Module is installed.

SCTrlPIDNo**SPNo Group Setting 4 (PID Group Number)**

Sets the target setpoint PID group number

Syntax `SCTrlPIDNo,p1,p2,p3`
 p1 Loop number
 p2 Target setpoint number (1 to 8)
 p3 PID group number (1 to 8)

Query `SCTrlPIDNo[,p1,p2]?`

Example For loop number L022, set the PID group number of target setpoint number 8 to 3.

`SCTrlPIDNo,L022,8,3`

Description

- This command is valid when a PID Control Module is installed.
- The maximum value of p3 is the number of SP groups set using p3 of the [SCTrlSPPID](#) command.

SCTrlRefPoint**Zone PID Setting 1 (Reference Point)**

Sets the zone PID reference point

Syntax `SCTrlRefPoint,p1,p2,p3`
 p1 Loop number
 p2 Reference point number (1 to number of PID groups – 1)
 p3 Reference point (PV range low limit to PV range high limit)

Query `SCTrlRefPoint[,p1,p2]?`

Example For loop number L022, set the reference point of reference point number 7 to -450.5.

`SCTrlRefPoint,L022,7,-4505`

Description

- This command is valid when a PID Control Module is installed.

SCTrlRHys**Zone PID Setting 2 (Switching Hysteresis)**

Sets the zone PID switching hysteresis

Syntax `SCTrlRHys,p1,p2`
 p1 Loop number
 p2 Switching hysteresis
 0% to 100% of PV range span

Example 0.0 to 100.0° (0 to 900) when the PV range is 10.0 to 90.0°

Query `SCTrlRHys[,p1]?`

Example For loop number L022, set the switching hysteresis to 30.8.

`SCTrlRHys,L022,308`

Description

- This command is valid when a PID Control Module is installed.

SCTrlRefDEV**Zone PID Setting 3 (Reference Deviation)**

Sets the zone PID reference deviation

Syntax `SCTrlRefDEV,p1,p2,p3`
 p1 Loop number
 p2 Reference deviation on/off (Off, On)
 p3 Reference deviation (0% to 100% of PV range span)
 Example 0.0 to 100.0° (0 to 900) when the PV range is 10.0 to 90.0°

Query `SCTrlRefDEV[,p1]?`**Example** For loop number L022, set the reference deviation to 125.8.`SCTrlRefDEV,L022,1258`**Description**

- This command is valid when a PID Control Module is installed.

SCTrlPIDPb**PID Parameter Setting 1 (Proportional Band)**

Sets the proportional band

Syntax `SCTrlPIDPb,p1,p2,p3`
 p1 Loop number
 p2 PID group number (1 to 8)
 p3 Proportional band P (1 to 9999)
 Setting range: 0.1 to 999.9%

Query `SCTrlPIDPb [,p1,p2]?`**Example** For loop number L022, set the proportional band P of PID group number 8 to 80.0%.`SCTrlPIDPb,L022,8,800`**Description**

- This command is valid when a PID Control Module is installed.

SCTrlPIDTI**PID Parameter Setting 2 (Integration Time)**

Sets the integration time

Syntax `SCTrlPIDTI,p1,p2,p3`
 p1 Loop number
 p2 PID group number (1 to 8)
 p3 Integration time I (0 to 6000)
 Setting range: 0 (OFF) to 6000 (s)

Query `SCTrlPIDTI [,p1,p2]?`**Example** For loop number L022, set the integration time of PID group number 8 to 240 s.`SCTrlPIDTI,L022,8,240`**Description**

- This command is valid when a PID Control Module is installed.

SCTrlPIDTD**PID Parameter Setting 3 (Derivative Time)**

Sets the derivative time

Syntax `SCTrlPIDTD,p1,p2,p3`
 p1 Loop number
 p2 PID group number (1 to 8)
 p3 Derivative time D (0 to 6000)
 Setting range: 0 (OFF) to 6000 (s)

Query `SCTrlPIDTD [,p1,p2]?`**Example** For loop number L022, set the derivative time of PID group number 8 to 60 s.`SCTrlPIDTD,L022,8,60`**Description**

- This command is valid when a PID Control Module is installed.

SCTrlPIDPara**PID Parameter Setting 4 (Other Controls)**

Sets control parameters

Syntax `SCTrlPIDPara,p1,p2,p3,p4,p5,p6,p7,p8,p9,p10`
 p1 Loop number
 p2 PID group number (1 to 8)
 p3 Control output low limit (-50 to 1050)
 Setting range: -5.0 to 105.0%
 p4 Control output high limit (-50 to 1050)
 Setting range: -5.0 to 105.0%
 p5 Tight shut function
 Off
 On
 p6 Manual reset (-50 to 1050)
 Setting range: -5.0 to 105.0%
 p7 Upper-side hysteresis
 0% to 100% of PV range span
 Example 0.0 to 100.0° (0 to 900) when the PV range is 10.0 to 90.0°
 p7 Lower-side hysteresis
 0% to 100% of PV range span
 Example 0.0 to 100.0° (0 to 900) when the PV range is 10.0 to 90.0°
 p9 Control direction
 Reverse Reverse
 Direct Direct
 p10 Preset output (-50 to 1050)
 Setting range: -5.0 to 105.0%

Query `SCTrlPIDPara [,p1,p2]?`**Example** For PID group number 8 of loop number L022, set the output limit to 10% to 80%, tight shut function to On, manual reset to 40%, hysteresis to -30.0 to 50.0, control direction to reverse, and preset output to 10%.`SCTrlPIDPara,L022,8,100,800,On,400,-300,500,Reverse,100`

Description

- This command is valid when a PID Control Module is installed.
- Set the control output high limit (p3) less than the control output low limit (p4).

SCTrlRefPb**Reference PID Setting 1 (Proportional Band)**

Sets the proportional band

Syntax `SCTrlRefPb,p1,p2`

p1 Loop number
p2 Proportional band P (1 to 9999)
Setting range: 0.1 to 999.9%

Query `SCTrlRefPb [,p1,p2]?`**Example** For loop number L022, set the proportional band P of the reference PID to 80.0%.`SCTrlRefPb,L022,800`**Description**

- This command is valid when a PID Control Module is installed.

SCTrlRefTI**Reference PID Setting 2 (Integration Time)**

Sets the integration time

Syntax `SCTrlRefTI,p1,p2`

p1 Loop number
p2 Integration time I (0 to 6000)
Setting range: 0 (OFF) to 6000 (s)

Query `SCTrlRefTI [,p1,p2]?`**Example** For loop number L022, set the integration time of the reference PID to 240 s.`SCTrlRefTI,L022,240`**Description**

- This command is valid when a PID Control Module is installed.

SCTrlRefTD**Reference PID Setting 2 (Derivative Time)**

Sets the derivative time

Syntax `SCTrlRefTD,p1,p2`

p1 Loop number
p2 Derivative time D (0 to 6000)
Setting range: 0 (OFF) to 6000 (s)

Query `SCTrlRefTD [,p1,p2]?`**Example** For loop number L022, set the derivative time of the reference PID to 60 s.`SCTrlRefTD,L022,60`**Description**

- This command is valid when a PID Control Module is installed.

SCTrlRefPara**Reference PID Setting 4 (Other Controls)**

Sets control parameters

Syntax `SCTrlRefPara,p1,p2,p3,p4,p5,p6,p7,p8,p9`

p1 Loop number
p2 Control output low limit (-50 to 1050)
Setting range: -5.0 to 105.0%
p3 Control output high limit (-50 to 1050)
Setting range: -5.0 to 105.0%
p4 Tight shut function
Off
On
p5 Manual reset (-50 to 1050)
Setting range: -5.0 to 105.0%
p6 Upper-side hysteresis
0% to 100% of PV range span
Example 0.0 to 100.0° (0 to 900) when the PV range is 10.0 to 90.0°
p7 Lower-side hysteresis
0% to 100% of PV range span
Example 0.0 to 100.0° (0 to 900) when the PV range is 10.0 to 90.0°
p8 Control direction
Reverse Reverse
Direct Direct
p9 Preset output (-50 to 1050)
Setting range: -5.0 to 105.0%

Query `SCTrlRefPara [,p1]?`**Example** For the reference PID of loop number L022, set the output limit to 10% to 80%, tight shut function to On, manual reset to 40%, hysteresis to -30.0 to 50.0, control direction to reverse, and preset output to 10%.`SCTrlRefPara,L022,100,800,On,400,-300,500,Reverse,100`**Description**

- This command is valid when a PID Control Module is installed.
- Set the control output high limit (p2) less than the control output low limit (p3).

SCtrlDetail

Control Detail Setting 1 (Tracking, Setpoint Limit, Ramp-Rate Time Unit)

Sets the tracking, setpoint limit, and ramp-rate time unit

Syntax `SCtrlDetail,p1,p2,p3,p4,p5,p6`

p1 Loop number

p2 Target setpoint tracking (Off, On)
Off
On

p3 PV tracking (Off, On)
Off
On

p4 Target setpoint low limit (PV range low limit to PV range high limit)

p5 Target setpoint high limit (PV range low limit to PV range high limit)

p6 Ramp-rate time unit (Hour, Min, Sec)
Hour Hours
Min Minutes
Sec Seconds

Query `SCtrlDetail[,p1]?`

Example For loop number L022, set the target setpoint tracking to On, PV tracking to On, target setpoint limits to -300.0 to 300.0, and ramp-rate time unit to minutes.

`SCtrlDetail,L022,On,On,-3000,3000,Min`

Description

- This command is valid when a PID Control Module is installed.
- Set the target setpoint high limit (p4) less than the target setpoint low limit (p5).

SCtrlOutRatio

Control Detail Setting 2 (Output Velocity Limiter)

Sets the output velocity limiter

Syntax `SCtrlOutRatio,p1,p2,p3`

p1 Loop number

p2 Output velocity limiter (Off, On)
Off
On

p3 Output velocity limiter value (1 to 10000)
Setting range: 0.1 to 100.0%/s

Query `SCtrlOutRatio[,p1]?`

Example For loop number L022, set the output velocity limiter to 10.5 (%/s).

`SCtrlOutRatio,L022,On,105`

Description

- This command is valid when a PID Control Module is installed.

SCtrlAtDetail

Control Detail Setting 3 (Auto-Tuning Details)

Sets the auto-tuning details

Syntax `SCtrlAtDetail,p1,p2,p3,p4,p5`

p1 Loop number

p2 Type
NORMAL Normal
STABILITY Stability

p3 Output limiter low limit (-50 to 1050)
Setting range: -5.0 to 105.0%

p4 Output limiter high limit (-50 to 1050)
Setting range: -5.0 to 105.0%

p5 Bias (-100% to 100% of the PV range span
Example -90.0° to 90.0° for 10.0° to 100.0°

Query `SCtrlAtDetail[,p1]?`

Example For loop number L022, set the auto-tuning type to Stability, limiter to -5% to 90%, and bias to 150.0.

`SCtrlAtDetail,L022,STABILITY,-50,900,1500`

Description

- This command is valid when a PID Control Module is installed.
- Set the output limiter low limit (p3) less than the output limiter high limit (p4).

SCtrlAntiReset

Control Detail Setting 4 (Over-Integration Suppressing Function)

Sets the over-integration suppressing function (anti-reset windup)

Syntax `SCtrlAntiReset,p1,p2,p3`

p1 Loop number

p2 Type
Auto Auto
Manual Manual

p3 Deviation band (500 to 2000)
Setting range: 50.0 to 200.0%

Query `SCtrlAntiReset[,p1]?`

Example For loop number L022, set the deviation band of the over-integration suppressing function to 70.0%.

`SCtrlAntiReset,L022,Manual,700`

Description

- This command is valid when a PID Control Module is installed.
- If p2=Auto, p3 is fixed to 0. If p2=Manual, set p3 and subsequent parameters.

SCTrlOvershoot

Control Detail Setting 5 (Control Output Suppressing Function)

Sets the control output suppressing function (overshoot-suppressing function)

Syntax `SCTrlOvershoot,p1,p2`
 p1 Loop number
 p2 Control output suppressing function
 Off Not Use
 Normal Normal mode

Query `SCTrlOvershoot[,p1]?`

Example For loop number L022, set overshoot to normal mode.

`SCTrlOvershoot,L022,Normal`

Description

- This command is valid when a PID Control Module is installed.

SCTrlGroupSW

Control Group Use/Not

Sets whether to use control groups

Syntax `SCTrlGroupSW,p1,p2`
 p1 Display group number
 p2 Use/Not
 Off Not Use
 On Use

Query `SCTrlGroupSW[,p1]?`

Example Set the group of display group number 8 to not use.

`SCTrlGroupSW,8,Off`

Description

- This command is valid when a PID Control Module is installed.
- The selectable range of display group numbers (p1) varies depending on the model.

SCTrlGroupName

Control Group Name

Sets the control group name

Syntax `SCTrlGroupName,p1,p2`
 p1 Display group number (1 to 10)
 GX10/GX20-1/GM10-1: 1 to 5
 GX20-2/GM10-2: 1 to 10
 p2 Group name (up to 16 characters, UTF-8)

Query `SCTrlGroupName[,p1]?`

Example Set the group name of display group number 8 to "Group8."

`SCTrlGroupName,8,'Group8'`

Description

- This command is valid when a PID Control Module is installed.
- The selectable range of display group numbers (p1) varies depending on the model.

SCTrlGroupSplit

Control Group Divisions [GX/GP]

Sets the number of control group divisions

Syntax `SCTrlGroupSplit,p1,p2`
 p1 Display group number (1 to 10)
 GX10/GX20-1/GM10-1: 1 to 5
 GX20-2/GM10-2: 1 to 10
 p2 Number of divisions (2, 4, 6, 8)
 The number of divisions cannot be set to 8 on the GX10.

Query `SCTrlGroupSplit[,p1]?`

Example Set the number of divisions of display group number 8 to 4.

`SCTrlGroupSplit,8,4`

Description

- This command is valid when a PID Control Module is installed.
- The selectable range of display group numbers (p1) varies depending on the model.

SCTrlGroup

Control Group Assignment

Sets loops to assign to control groups

Syntax `SCTrlGroup,p1,p2,p3,p4`
 p1 Display group number
 p2 Setting Number
 GX20/GM10: 1 to 8
 GX10: 1 to 6
 p3 Setting On, Off
 Off Not set
 On Set
 p4 Type
 INT Loop
 p5 Loop number

Query `SCTrlGroup[,p1,p2]?`

Example Assign L001, L002, L011, L012, L021, and L022 to the group with display group number 8.
`SCTrlGroup,8,1,On,INT,001;SCTrlGroup,8,2,On,INT,002;SCTrlGroup,8,3,On,INT,011;SCTrlGroup,8,4,On,INT,012;SCTrlGroup,8,5,On,INT,021;SCTrlGroup,8,6,On,INT,022;`

Description

- This command is valid when a PID Control Module is installed.
- On the GX/GP, p3 cannot be set to On exceeding the number of divisions. (See the SCTrlGroupSplit command.)

SCtrlTag

Loop Tag, Tag Comment

Sets the loop tag and tag comment

Syntax SCtrlTag, p1, p2, p3, p4

- p1 Loop number
- p2 Tag (up to 32 characters, UTF-8)
- p3 Tag No. (up to 16 alphanumeric characters, UTF-8)

Query SCtrlTag[, p1]?

Example For loop number L022, set the tag to "Tag L022" and tag No. to "Ctrl-L022."
 SCtrlTag, L022, 'Tag L022', 'Ctrl-L022'

Description

- This command is valid when a PID Control Module is installed.

SCtrlDispDV

Deviation Display Band (Control Group Display)

Sets the deviation display band

Syntax SCtrlDispDV, p1, p2

- p1 Loop number
- p2 Deviation display band (0% to 100% of PV range span)

Example 0.0° to 90.0° (0 to 900) when the PV range is 10.0 to 100.0°

Query SCtrlDispDV[, p1]?

Example For loop number L022, set the deviation display band to 30.0.
 SCtrlDispDV, L022, 300

Description

- This command is valid when a PID Control Module is installed.

SCtrlBackColor [GX/GP]

Background color (Control Group Display)

Sets the background color of the control group display.

Syntax SCtrlBackColor, p1

- p1 Background color
 White White
 Black Black

Example 0.0° to 90.0° (0 to 900) when the PV range is 10.0 to 100.0°

Query SCtrlBackColor[, p1]?

Example Set the background color of the control group display (Control group, Tuning, and Program) to black.
 SCtrlBackColor, Black

Description

- This command is valid when a PID Control Module is installed.

SCtrlOutOperate

OUT Value Manual Output Operation Type (Control Group Display)

Sets the OUT value manual output operation type

Syntax SCtrlOutOperate, p1

- p1 Confirmation method
 DIRECT Confirm with direct operation
 SETENTER Confirm with the ENTER key

Query SCtrlOutOperate[, p1]?

Example Confirm the OUT value with the ENTER key.
 SCtrlOutOperate, SETENTER

Description

- This command is valid when a PID Control Module is installed.

STagIO, SColorIO, SZoneIO, SScaleIO, SBarIO, SPartialIO, SValueIO

Control (PID) Channel Display Setting

The channel display setting parameters of the control PID module are shared with other channels. For details, see each of the following commands.

Tag and tag number	STagIO
Color	SColorIO
Zone low limit, zone high limit	SZoneIO
Scale display position, number of scale divisions	SScaleIO
Bar display position, number of bar divisions	SBarIO
Partial	SPartialIO
Upper and lower limit string	SValueIO

In addition, the following table shows the association between the PID control module channel types and commands.

Command name	PV	SP	OUT	AI	AO	DI	DO
STagIO	Y	Y	Y	Y	Y	Y	Y
SColorIO	Y	Y	Y	Y	Y	Y	Y
SZoneIO	Y	Y	Y	Y	Y	Y	Y
SScaleIO	Y	Y	Y	Y	Y	Y	Y
SBarIO	Y	Y	Y	Y	Y	Y	Y
SPartialIO	Y	Y	N	Y	N	N	N
SValueIO	N	N	N	N	N	Y	Y

Y: available, N: not available

SPrgColor

Program Control Loop Color

Sets the loop color

Syntax SPrgColor, p1, p2, p3, p4

- p1 Loop number
- p2 R value of RGB colors (0 to 255)
- p3 G value of RGB colors (0 to 255)
- p4 B value of RGB colors (0 to 255)

Query SPrgColor [,p1] ?

Example

Description

- This command can be used when a PID control module is installed and the program control function (/PG option) is enabled. For details on RGB values, see "Description" of the **SColorIO** command.

SPrgDispDetail

Auto Message Printout, Automatic Switch To Program Operation Display, Other Display Settings

Sets the detail settings for auto message printout, display switch, and start of program operation to On or Off.

Syntax SPrgDispDetail, p1, p2, p3

- p1 Program Run/Reset message (Off, On)

Off	Messages are not displayed.
On	Messages are displayed.
- p2 Automatic switch to program operation display (Off, On)

Off	Not switched to the program operation display
On	Switched to the program operation display
- p3 Detail settings at start of program operation (Off, On)

Off	Detail settings are not used (default value).
On	Detail settings are used.

Query SPrgDispDetail [,p1] ?

Example Set Program Run/Reset message to On, automatic switch to program operation display to Off, and Program RUN detail settings to On.
SPrgDispDetail, On, Off, On

Description

- This command can be used when a PID control module is installed and the program control function (/PG option) is enabled.
- p3 is a setting to set the start segment number and starting time of program operation at the start of program operation.

SCtrlEventAct

Control Event Action

Sets a control event action

When p2 (type) is set to Off

Syntax SCtrlEventAct, p1, p2

- p1 Registration number (1 to 100)
- p2 Type (Off)

When p2 (type) is set to DI, DO, or internal switch

Syntax SCtrlEventAct, p1, p2, p3, p4, p5, p6, p7, p8, p9

- p1 Registration number (1 to 100)
- p2 Type (DI, DO, SW)

DI	DI
DO	DO
SW	Internal switch
- p3 Number

When P2=SW:	1 to 100
When P2=DI or DO:	0001 to 6932
- p4 Input/output type (In, Out)

In	Varies depending on P2
Out	(DI, DO, SW). See the table below.
- p5 Status output content or operation content

Varies depending on P2 (DI, DO, SW).	See the table below.
--------------------------------------	----------------------

For operation with p5=SELECT (hold, advance, start of program operation, stop of program operation)

- p6 Pattern type (PATTERN_NO, WCONST)

PATTERN_	Program pattern number
NO	
WCONST	Variable constant W
- p7 Pattern number
- p8 Loop type (LOOP_NO, WCONST)

LOOP_NO	Loop number
WCONST	Variable constant W
- p9 Loop number

When p5 is set to a value other than those above (table below)

- p6 Empty
- p7 Element number corresponding to p5

Loop number
PV/time event number (1 to 32)

Query SCtrlEventAct [,p1]?

Example Set All loop control operation to stop when the internal switch number (SW1) becomes 0 to 1. Use Control event action number 1.
SCtrlEventAct, 1, SW, 1, In, ALL_LP_STOP_ACT

Description

- This command can be used when a PID control module is installed and the program control function (/PG option) is enabled.
- If you need multiple channels for p2 (event type) and p5 (action), use DI/DO/SW in the same module. The table below shows the number of used channels.

p2 Type	p4 Input/output type	p5 Status output/operation content	p5 Option strings	p7	Number of used channels
DI (PID control module or input type DI) DO (alarm or manual) SW	In	PROG/RESET	PRG_RST_ACT	-	1
		Pattern number setting Bin (Patr1-2)	PTNNO_BIN_1-2_W	-	1
		Pattern number setting Bin (Patr1-4)	PTNNO_BIN_1-4_W	-	2
		Pattern number setting Bin (Patr1-8)	PTNNO_BIN_1-8_W	-	3
		Pattern number setting Bin (Patr1-16)	PTNNO_BIN_1-16_W	-	4
		Pattern number setting Bin (Patr1-32)	PTNNO_BIN_1-32_W	-	5
		Pattern number setting Bin (Patr1-64)	PTNNO_BIN_1-64_W	-	6
		Pattern number setting Bin (Patr1-99)	PTNNO_BIN_1-99_W	-	7
		Pattern number setting Bcd (1 digit)	PTNNO_BCD_1Digi_W	-	4
		Pattern number setting Bcd (2 digit)	PTNNO_BCD_2Digi_W	-	8
		Hold operation	HOLD_ACT	-	1
		Advance operation	ADVANCE_ACT	-	1
		Start of program operation	PRG_RUN_ACT	-	1
		Stop of program operation	PRG_STOP_ACT	-	1
		HOLD operation with SELECT	SEL_HOLD_ACT	Auxiliary parameters p6 to p9 are available.	1
		ADVANCE operation with SELECT	SEL_ADVANCE_ACT		1
		Stop of program operation with SELECT	SEL_PRG_RUN_ACT		1
		Stop of program operation with SELECT	SEL_PRG_STOP_ACT		1
		All loop control operation stop	ALL_LP_STOP_ACT	LP	1
		All loop control operation start	ALL_LP_START_ACT	LP	1
		AUTO/MAN Switch (A/M)	A-M_ACT	LP	1
		REMOTE/LOCAL Switch (R/L)	R-L_ACT	LP	1
		STOP/RUN Switch (S/R)	S-R_ACT	LP	1
		Switch to REMOTE (REM)	REM_ACT	LP	1
		Switch to LOCAL (LCL)	LCL_ACT	LP ²	1
		Switch to Cascade (CAS)	CAS_ACT	LP ²	1
		Switch to AUTO (AUTO)	AUTO_ACT	LP ²	1
		Switch to MAN (MAN)	MAN_ACT	LP	1
		Target setpoint number Bin (SPNo1-2)	SPNO_BIN_1-2_W	LP	1
		Target setpoint number Bin (SPNo1-4)	SPNO_BIN_1-4_W	LP	2
		Target setpoint number Bin (SPNo1-8)	SPNO_BIN_1-8_W	LP	3
		Target setpoint number Bcd (1 digit)	SPNO_BCD_1Digi_W	LP	4

p2 Type	p4 Input/output type	p5 Status output/operation content	p5 Option strings	p7 ¹	Number of used channels
DO (for manual) SW (for manual)	Out	Pattern number monitoring Bin (Patr1)	PTNNO_BIN_1_R	-	1
		Pattern number monitoring Bin (Patr1-3)	PTNNO_BIN_1-3_R	-	2
		Pattern number monitoring Bin (Patr1-7)	PTNNO_BIN_1-7_R	-	3
		Pattern number monitoring Bin (Patr1-15)	PTNNO_BIN_1-15_R	-	4
		Pattern number monitoring Bin (Patr1-31)	PTNNO_BIN_1-31_R	-	5
		Pattern number monitoring Bin (Patr1-63)	PTNNO_BIN_1-63_R	-	6
		Pattern number monitoring Bin (Patr1-99)	PTNNO_BIN_1-99_R	-	7
		Pattern number monitoring Bcd (1 digit)	PTNNO_BCD_1Digi_R	-	4
		Pattern number monitoring Bcd (2 digit)	PTNNO_BCD_2Digi_R	-	8
		Segment number monitoring Bin (Seg1)	SEGNO_BIN_1_R	-	1
		Segment number monitoring Bin (Seg1-3)	SEGNO_BIN_1-3_R	-	2
		Segment number monitoring Bin (Seg1-7)	SEGNO_BIN_1-7_R	-	3
		Segment number monitoring Bin (Seg1-15)	SEGNO_BIN_1-15_R	-	4
		Segment number monitoring Bin (Seg1-31)	SEGNO_BIN_1-31_R	-	5
		Segment number monitoring Bin (Seg1-63)	SEGNO_BIN_1-63_R	-	6
		Segment number monitoring Bin (Seg1-99)	SEGNO_BIN_1-99_R	-	7
		Segment number monitoring Bcd (1 digit)	SEGNO_BCD_1Digit_R	-	4
		Segment number monitoring Bcd (2 digit)	SEGNO_BCD_2Digit_R	-	8
		PROG/RESET status output	PRG_RST_R	-	1
		Wait end signal (1 s hold)	WAIT_END_1s_R	-	1
		Wait end signal (3 s hold)	WAIT_END_3s_R	-	1
		Wait end signal (5 s hold)	WAIT_END_5s_R	-	1
		Pattern end signal (1 s hold)	PTN_END_1s_R	-	1
		Pattern end signal (3 s hold)	PTN_END_3s_R	-	1
		Pattern end signal (5 s hold)	PTN_END_5s_R	-	1
		PV event status	PV_EVENT_R	EVT	1
		Time event status	TIME_EVENT_R	EVT	1
		Wait flag	WAIT_CONT_R	-	1
		Hold-on flag	HOLD_CONT_R	-	1
		Control status	RUN_STOP_R	-	1

1 LP = loop number (1 to 652), EVT = PV/time event number (1 to 32)
2 Save behavior on each module. (Example: 001 and 002 are the same.)

SLogicMath

Logic Math Expression (/MT)

Sets the logic math expression

Syntax `SLogicMath,p1,p2,p3`

- p1 Math number
- p2 Expression on/off
 - Off Not Use
 - DO DO channel
 - SW Internal switch
- p3 Channel number
- p4 Calculation expression (up to 120 alphanumeric characters, UTF-8)

Query `SLogicMath[,p1]?`

Example Output the math result of expression 0001AND0002 as 0 or 1 to DO channel number 0105. Use Logic math number 1.
`SLogicMath,1,DO,0105,'0001AND0002'`

Description

- You cannot use this command to configure settings while recording is in progress.
- p3 can be set only for DO or SW with type set to Manual.
- This command can be used when the math function (/MT) is enabled.

SWConst

Variable Constant (/MT)

Sets the variable constant to be used in computation

Syntax `SWConst,p1,p2`

- p1 Variable constant number (1 to 100)
- p2 Value (–9.999999E+29 to 9.999999E+30, five significant digits)

Query `SWConst[,p1]?`

Example Set variable constant number 12 to 1.0000E–10.
`SWConst,12,1.0000E-10`

Description

- You can change the constant even during recording, computing, and controlling.
- This command can be used when the math function (/MT) is enabled.

2.5 Output Commands

FData

Outputs the Most Recent Channel Data

Outputs the most recent I/O channel, math channel, and communication channel data.

Syntax `FData,p1,p2,p3`

- p1 Output format
 - 0 The most recent data in ASCII format
 - 1 The most recent data in binary format
- p2 First channel
- p3 Last channel

Example Output the most recent data of channels 0001 to 0210 in ASCII format.
`FData,0,0001,0210`

Description

- If you omit p2 and p3, all channels will be output.
- Channel ranges whose first channel and end channel are different channel types are interpreted as follows:

First Channel	Last Channel	Setting
0001	A200	0001 to 9999, A001 to A200
A001	C500	A001 to A200, C001 to C500
C001	A200	Not allowed (will result in error)
A001	0001	Not allowed (will result in error)

- For the ASCII output format, see [page 2-121](#).
- For the binary output format, see [page 2-180](#).

FRelay

Outputs the Most Recent Relay and Internal Switch Status

Outputs the most recent relay (DO Channel) and internal switch status.

Syntax `FRelay,p1`

- p1 Output information
 - 0 The most recent relay (DO channel) status in ASCII format
 - 1 The most recent internal switch status in ASCII format

Example Output the relay (DO channel) status.
`FRelay,0`

Description

- For the output format, see [page 2-122](#) or [page 2-124](#).

FTransStatAO

Latest Re-transmission State Output

Outputs the latest re-transmission (AO channel) state

Syntax FTransStatAO,p1
p1 Fixed to 0

Example Output the re-transmission state.
FTransStatAO,0

Description

- For the output format, see [page 2-124](#).

FFifoCur

Outputs Channel FIFO Data

Outputs the I/O channel, math channel, and communication channel FIFO data.

Acquire the FIFO Data

Syntax FFifoCur,p1,p2,p3,p4,p5,p6,p7
p1 FIFO data output (0)
p2 Scan group (1 or 2)
p3 First channel
p4 Last channel
p5 Read start position
(-1, 0 to 999999999999)
-1 The most recent read position
p6 Read end position
(-1, 0 to 999999999999)
-1 The most recent read position
p7 Maximum number of blocks to read (1 to 9999)

Example Read the measured data of channels 0001 to 0020. Set the read start position to 180 and the read end position to the most recent position. Set the maximum number of blocks to read to 9999.

```
FFifoCur,0,1,0001,0020,180,-1,9999
```

Acquire the FIFO Data Read Range

Syntax FFifoCur,p1,p2
p1 FIFO read range output (1)
p2 Scan group (1 or 2)

Example Acquire the current readable range.
FFifoCur,1,1

Description

- For the binary output format, see [page 2-183](#).
- p2 = 2 is valid when the measurement mode is set to dual interval.

FSnap

Snapshot [GX/GP]

Outputs a snapshot data (screen image data) file.

Syntax FSnap,p1
p1 Screen image data output (GET)

Example Acquire screen image data.
FSnap,GET

Description

- A PNG image file will be stored in the data block of the binary output file (see [page 2-119](#)).

FUser

Outputs the User Level

Outputs information about the users who are currently logged in.

Syntax FUser,p1
p1 Information about the users who are currently logged in
0 Refer to your own user information.
1 Refer to information about all users who are currently logged in.
2 Refer to information 2 of the user who is currently logged in
3 Refer to information 2 of all users who are currently logged in
4 Refer to information of the user (admin property) who is currently logged in
5 Refer to information of all users (admin property) who are currently logged in

Example Refer to information about all users who are currently logged in.

```
FUser,1
```

Description

- For the ASCII output format, see [page 2-126](#).

FAddr

Outputs the IP Address

Outputs the recorder IP address information.

Syntax FAddr,p1
p1 Address output (IP)
Output address information that includes the IP address, subnet mask, default gateway, and DNS server as well as the host name and domain name.

Example Output the recorder IP address information.
FAddr,IP

Description

- For the ASCII output format, see [page 2-132](#).

FStat

Outputs the Recorder Status

Outputs the recorder status.

Syntax `FStat, p1`
 p1 Status output (0)
 0 Status 1 to 4 output
 1 Status 1 to 8 output

Example Output the recorder status.
`FStat, 0`

Description

- For the ASCII output format, see [page 2-133](#).

FLog

Outputs the Log

Outputs the alarm summary, message summary, error log, etc.

Syntax `FLog, p1, p2, p3`
 p1 Status output (0)
 ALARM Alarm summary
 MSG Message summary
 EVENT Event log
 ERROR Error log
 DHCP Ethernet address setting log
 GENERAL General communication log
 MODBUS Modbus log
 FTP FTP client log
 SNTP SNTP client log
 MAIL E-mail log
 WEB Web log
 SLMP SLMP log
 CALARM Control alarm summary log
 CTRL Control summary log
 p2 Maximum log readout length

p1	Read range
ALARM	1 to 1000
MSG	1 to 500
GENERAL	1 to 200
MODBUS	1 to 50 (1 to 200 for the GX20-2/GP20-2)
CALARM	1 to 500
CTRL	1 to 1000
Other than those above.	1 to 50

p3 Batch group number
 All All batch group numbers
 1 to the Batch group number
 number
 used

Example Output 600 alarm summary entries.
`FLog, ALARM, 600`

Description

- For the ASCII output format, see [page 2-136](#).
- p3 is valid when multi batch is in use and p1={alarm, msg, event}. Omitting it is equivalent to specifying all batch groups.

FEventLog

Outputs a Detail Event Log(/AS)

Outputs an event log. You can specify the event, user, etc.

Syntax `FEventLog, p1, p2, p3, p4, p5`
 p1 Output format
 0 The same output format as Flog, EVENT (no detailed information).
 1 Include detailed information
 p2 User name
 Up to five user names can be specified by separating each user with a colon.
 p3 Event specification (specified with an event string)
 Up to five events can be specified by separating each user with a colon. Events will be searched using a prefix search.
 p4 Maximum number of output (1 to 400)
 p5 Batch group number
 All All batch group numbers
 1 to the Batch group number
 number
 used

Example Output the log of up to 10 "message001" writing operations by User01.
`FEventLog, 1, User01, Message001, 10`

Description

- Omitting p2 is equivalent to specifying all users.
- If more than five users are specified by p2, only the first five users will be valid.
- Omitting p3 is equivalent to specifying all events.
- If more than five events are specified by p3, only the first five events will be valid.
- For the event strings of p3, see section [2.10.23 Detail Event Log Output \(FEventLog\) \(/AS\)](#).
- This command can be used only when the multi batch function (/BT) is enabled. Omitting p5 is equivalent to specifying all batch groups.

FMedia

Outputs External Storage Medium and Internal Memory Information

Outputs external storage medium and internal memory information.

File list

Syntax `FMedia, p1, p2, p3, p4`
 p1 Output type (DIR)
 p2 Path name (up to 100 characters)
 Path name for outputting the file list
 p3 File list output start position (1 to 99999999)
 p4 File list output end position (1 to 99999999, -1)
 Last position for outputting the file list.
 If you specify -1, the maximum possible number of files (as large as the recorder internal communication buffer allows) will be output.

2.5 Output Commands

Example Output all the file lists in the DRV0 directory.

```
FMedia, DIR, /DRV0/
```

Output the file lists of items 10 to 20 in the DRV0 directory.

```
FMedia, DIR, /DRV0/, 10, 20
```

Description

- Path names (p2) for the internal memory and the external media are listed below. Set the path name using a full path.
Internal memory: /MEMO/DATA/
SD memory card: /DRV0/
USB flash memory: /USB0/
- If you omit p3 and p4, the maximum possible number of files (as many as the GX internal communication buffer allows) will be output.
- For the ASCII output format, see [page 2-160](#).

Data in Files

Syntax FMedia, p1, p2, p3, p4

p1 Output type (GET)

p2 Path name (up to 100 characters)
Path name of the file for outputting data

p3 Data output start position (in bytes) (0 to 2147483647)

p4 Data output end position (in bytes) (0 to 2147483647, -1)
The last data output position. If you specify -1, the maximum file size (as large as the recorder internal communication buffer allows) will be output.

Example Output all the data in file xyz in the DRV0/DATA0 directory.

```
FMedia, GET, /DRV0/DATA0/xyz
```

Description

- If you omit p3 and p4, the maximum file size (as large as the recorder internal communication buffer allows) will be output.
- The file data will be stored in the data block of the binary output file (see [page 2-119](#)).

Free Space on the External Storage Medium

Syntax FMedia, p1

p1 Output type (CHKDSK)

Example Output the free space on the external storage medium.

```
FMedia, CHKDSK
```

Description

- For the ASCII output format, see [page 2-160](#).

FCnf

Outputs Setting Data

Outputs the recorder setting data.

Syntax FCnf, p1

p1 Operation

ALL	Read all settings.
IO	Read I/O settings.
MATH	Read Math settings.
COMM	Read communication settings.
GROUP	Read display group settings.
IP	Read IP address settings.
SECURITY	Read security settings.
MULTIBATCH	Read multi batch settings.
CONTROL	Read control settings.
CALIB	Read calibration correction settings.
SERVER	Read Ethernet server related settings.
INSTRU	Read device information settings.
OTHERS	Read settings other than above.

You can specify multiple items in the list above. Separate each item with a colon (see the example).

Example Read I/O and Math settings.

```
FCnf, IO:MATH
```

Description

- If you omit p1, all settings will be read.
- The setting data is output as the responses to the command queries. The following table lists p1 values (setting category) and the corresponding commands.

Setting Category and Target Commands

Setting category	Command
IO	SModeAI, SModeAICurrent, SModeDI, SModePID, SScaleOver, SBOLmtAI, SBOLmtAICurrent, SRangeAI, SRangeAICurrent, SRangeDI, SRangePulse, SRangeDO, SRangeAO, SMoveAve, SFilter, SBurnOut, SRjc, SAlarmIO, SAlmHysIO, SAlmDlyIO, STagIO, SColorIO, SZoneIO, SScaleIO, SBarIO, SPartialIO, SBandIO, SAlmMarkIO, SValueIO, SPresetAO
MATH	SMathBasic, SKConst, SWconst, SRangeMath, STlogMath, SRolAveMath, SAlarmMath, SAlmHysMath, SAlmDlyMath, STagMath, SColorMath, SZoneMath, SScaleMath, SBarMath, SPartialMath, SBandMath, SAlmMarkMath, SReport, SRepData, SRepTemp, SRepCh, SDigitalSign, SRepBatchInfo

COMM	SRangeCom, SValueCom, SWDCom, SAlarmCom, SAlmHysCom, SAlmDlyCom, STagCom, SColorCom, SZoneCom, SScaleCom, SBarCom, SPartialCom, SBandCom, SAlmMarkCom, SCalibUseCom, SCalibCom
GROUP	SGroup, STripLine, SSclBmp, SDualGroup
IP	SIPAddress, SDns, SDhcp
SECURITY	SKdc, SSecurity, SOpePass, SOpeLimit, SUser, SUserLimit, SSignIn, SSignInTitle, SSignInLimit, SBTPassword, SWebCustomMenu, SWebTimeOut, SSessionSecurity, SPasswdPolicy, SPasswdNotice, SAdminLimit, SChgComm
MULTIBATCH	SMltTextField, SMltFileHead, SMltFileName, SMltGroup, SMltTripLine, SMltSclBmp
CONTROL	SCtrlMode, SCtrlScan, SCtrlAction, SCtrlType, SCtrlLoopAction, SCtrlSPPID, SCtrlALNo, SCtrlAlmMode, SCtrlDIRegist, SCtrlRelay, SCtrlRangeAI, SCtrlBurnOut, SCtrlRjc, SCtrlFilter, SCtrlCalibAI, SCtrlRangeAO, SCtrlSpritAO, SCtrlOutput, SCtrlRangePV, SCtrlPVSwitch, SCtrlCalc, SCtrlFilterSP, SCtrlRatioSP, SCtrlBiasSP, SCtrlErrPreOut, SCtrlOutLimit, SCtrlAlarm, SCtrlAlarmVal, SCtrlSP, SCtrlSPGradient, SCtrlPIDNo, SCtrlRefPoint, SCtrlRHys, SCtrlRefDEV, SCtrlPIDPb, SCtrlPIDTI, SCtrlPIDTD, SCtrlPIDPara, SCtrlRefPb, SCtrlRefTI, SCtrlRefTD, SCtrlRefPara, SCtrlDetail, SCtrlOutRatio, SCtrlAtDetail, SCtrlAntiReset, SCtrlOvershoot, SCtrlGroupSW, SCtrlGroupName, SCtrlGroupSplit, SCtrlGroup, SCtrlTag, SCtrlDispDV, SCtrlBackColor, SCtrlOutOperate, SPrgColor, SPrgDispDetail, SCtrlEventAct, SLogicMath, SWConst
CALIB	SCalibIO, SSchedule, SScheduleText, SCalibUseCom, SCalibCom
SERVER	SServerEncrypt, SServer, SDarwinCnvCh, SDarwinPortLimit
INSTRU	SBTID, SInstruTag

- For the output format, see [page 2-161](#).

FChInfo

Outputs Decimal Place and Unit Information

Outputs decimal place and unit information.

Syntax FChInfo, p1, p2
 p1 First channel
 p2 Last channel

Example Output the decimal place and unit information of channels 0001 to 0003.
 FChInfo, 0001, 0003

Description

- If you omit p1 and p2, all channels will be output.
- For the output format, see [page 2-161](#).

FSysConf

Queries the System Configuration and Reconfigures Modules

Queries the System Configuration, Reconfigures Modules, and Performs Activation.

Query the System Configuration

Syntax FSysConf

Example Query the System Configuration.
 FSysConf

Description

- For the output format, see [page 2-162](#).

Reconfigures Modules

Aligns the module configuration settings that are recognized by the recorder and the actual module configuration.

Syntax FSysConf, p1

p1 Module reconfiguration (1)

Example Reconfigure the modules.

FSysConf, 1

Activate module

Modules need to be activated when the firmware in installed modules is updated or when modules are recalibrated.

Syntax FSysConf, p1

p1 Activate module (3)

Example Activate modules.

FSysConf, 3

Description

- p1 = 3 is valid when the advanced security function (/AS) is enabled.

FBTDevInfo

Bluetooth Device Information Output [GM]

Outputs the Bluetooth device information of the recorder.

Syntax `FBTDevInfo, p1`
p1 Bluetooth device information output (0)

Example Output the Bluetooth device information of the connected device.
`FBTDevInfo, 0`

Description

- p1 can be omitted.
- For the output format, see [page 2-164](#).

FReminder

Outputs Reminder Information (/AH)

Outputs reminder information.

Syntax `FReminder, p1`
p1 Reminder information designation
ALL Specifies all schedule numbers
1 or 12 Schedule number

Example Output the reminder information for schedule number 3.
`FReminder, 3`

Description

- This command is valid when the aerospace heat treatment (/AH) option is enabled.
- Omitting p1 is equivalent to specifying all registration numbers.
- For the output format, see [page 2-165](#).

FCtrlData

Control Data Output

Outputs the most recent control data.

Syntax `FCtrlData, p1, p2, p3`
p1 Output format
0 ASCII format
1 Binary format
p2 First loop number
p3 Last loop number

Example Output the most recent data of loop number 001
`FCtrlData, L001`

Description

- If you omit p2 and p3, all loop numbers will be output.
- Only the information of detected modules will be output.
- The data time outputted is not the time of a control period but the data acquisition time by a communication command.
- For the ASCII output format, see [page 2-166](#).
- For the Binary output format, see [page 2-184](#).

FCtrlNo

SP Number and PID Number Output

Outputs the SP number and PID number

Syntax `FCtrlNo, p1, p2`
p1 First loop number
p2 Last loop number

Example Output the SP number and PID number of loop number 001 currently in use.
`FCtrlNo, L001`

Description

- If you omit p1 and p2, all loop numbers will be output.
- If you omit p2, p2 is set to the same loop number as p1.
- Only the information of detected modules will be output.
- For the output format, see [page 2-167](#).

FCtrlMode

Control Mode Output

Outputs the control mode

Syntax `FCtrlMode, p1, p2`
p1 First loop number
p2 Last loop number

Example Output the control mode of loop number 001.
`FCtrlMode, L001`

Description

- If you omit p1 and p2, all loop numbers will be output.
- If you omit p2, p2 is set to the same loop number as p1.
- Only the information of detected modules will be output.
- For the output format, see [page 2-168](#).

FPrgMode (/PG)

Program Operation Mode Output

Outputs the program operation mode

Syntax `FPrgMode, p1`
p1 Program pattern number (1 to 99)

Example Output the program operation mode of program pattern number 1.
`FPrgMode, 1`

Description

- This command is valid when the program control function (/PG option) is in use.
- For the output format, see [page 2-169](#).

FPrGpTnInfo (/PG)

Program Pattern Information Output

Outputs the program pattern status

Syntax `FPrGpTnInfo, p1`
`p1` Program pattern number (1 to 99)

Example Output the program operation mode of program pattern number 1.
`FPrGpTnInfo, 1`

Description

- This command is valid when the program control function (/PG option) is in use.
- During program operation, if the selected program pattern is not being executed, an error occurs.
- When program operation is stopped, the information at the end of operation is output only when the selected program pattern matches the program pattern that was executed last.
- For the output format, see [page 2-170](#).

FPrGEvent (/PG)

PV Event and Time Event Information Output

Outputs information about PV events and time events occurring in the program pattern

Syntax `FPrGEvent, p1`
`p1` Program pattern number (1 to 99)

Example Output information about PV events and time events of program pattern number 1.
`FPrGEvent, 1`

Description

- This command is valid when the program control function (/PG option) is in use.
- When program operation is stopped, "0" is output for PV events and time events.
- For the output format, see [page 2-171](#).

FPrGEnd (/PG)

Program Control End Signal Status Output

Outputs the program control end signal status

Syntax `FPrGEnd, p1`
`p1` Program pattern number (1 to 99)

Example Output the program control end signal status of program pattern number 1.
`FPrGEnd, 1`

Description

- This command is valid when the program control function (/PG option) is in use.
- This command can output the program control end signal status for about 5 seconds after the program operation ends normally.
- The program control end signal is not output when the operation is terminated by force (terminated through reset).

- When program operation is stopped, "0" is output.
- For the output format, see [page 2-172](#).

FPrGpTnCur (/PG)

Running Program Pattern Number and Status Output

Outputs the running program pattern number and status

Syntax `FPrGpTnCur`

Example Output the running program pattern number and status.
`FPrGpTnCur`

Description

- This command is valid when the program control function (/PG option) is in use.
- When program operation is stopped, EA<crLf>EN<crLf> is returned.
- For the output format, see [page 2-172](#).

2.6 Operation Commands

OSetTime

Sets the Time

Sets the time.

Syntax `OSetTime,p1`
`p1` Time to set
 "YYYY/MO/DD_HH:MI:SS" (the underscore denote a space), "YYYY/MO/DD", or "HH:MI:SS."
 YYYY Year (2001 to 2035)
 MO Month (01 to 12)
 DD Day (01 to 31)
 HH Hour (00 to 23)
 MI Minute (00 to 59)
 SS Second (00 to 59)

Query `OSetTime?`
 The OSetTime query outputs the recorder current time.

Example Set the time to 23:00:00 on May 24, 2013.
`OSetTime,2013/05/24 23:00:00`

ORec

Starts or Stops Recording

Starts or stops recording.

Syntax `ORec,p1,p2`
`p1` Recording start or stop
 0 Start
 1 Stop
`p2` Batch group number
 All All batch group numbers
 1 to Batch group number
 the number used

Query `ORec?`
`ORec[,p1[,p2]]?` (when multi batch is enabled) (p1 is any value)

Example Start recording.
`ORec,0`

Description

- p2 is valid when multi batch (/BT) is enabled.
- Omitting p2 is equivalent to specifying all batch group numbers.

OAlarmAck

Clears Alarm Output

Clears alarm output (performs an alarm ACK).

Syntax `OAlarmAck,p1,p2,p3,p4`
`p1` Alarm output clearance (0)
`p2` Unused (optional)
`p3` Unused (optional)
`p4` ACK comment (up to 50 characters, UTF-8)

Example Clear the alarm output.
`OAlarmAck,0`
 Write the ACK comment string "Execute alarm ACK."
`OAlarmAck,0,,, Execute alarm ACK`

Individual alarm ACK

Syntax `OAlarmAck,p1,p2,p3,p4`
`p1` Individual alarm output clearance (1)
`p2` Channel number
`p3` Alarm level (1 to 4)
`p4` ACK comment (up to 50 characters, UTF-8)

Example Clear the alarm output of alarm 3 of channel 0001.
`OAlarmAck,1,0001,3`

Individual Alarm ACK (for control alarms)

Syntax `OAlarmAck,p1,p2`
`p1` Separate alarm output clearance (2)
`p2` Loop number

Example Clear the alarm output of loop L122.
`OAlarmAck,2,122`

Description

- If you send an individual alarm ACK command when the individual alarm ACK function is not in use, no action is taken, and a normal response is returned.
- p4 is ignored when alarm ACK comment input is set to Off.

OExecRec

Generates a Manual Trigger, Executes Manual Sample, Takes a Snapshot, or Causes a Timeout

Generates a manual trigger, executes manual sample, takes a snapshot, or divides the data being recorded into separate files.

Syntax `OExecRec,p1,p2`
`p1` Action type
 (GX/GP: 0, 1, 2, 3, 4)
 (GM: 0, 1, 3, 4)
 0 Execute manual sampling.
 1 Generate a manual trigger.
 2 Take a snapshot.
 3 Cause a display data timeout (divide files).
 4 Cause an event data timeout (divide files).

p2 Batch group number
 All All batch group numbers
 1 to the Batch group number
 number
 used

Example Execute manual sampling.
`OExecRec, 0`

When the measurement mode is set to dual interval

p1 Action type
 1 Generate a manual trigger.
 p2 Scan group number
 All All scan groups
 1 Scan group 1
 2 Scan group 2

Example When the measurement mode is dual interval, apply a trigger to scan group 2.
`OExecRec, 1, 2`

Description

- Manual trigger (p1 = 1) cannot be executed when the advanced security function (/AS) is enabled.
- If a manual sample is executed (p1 = 0) when there are no source channels for manual sampling, a file without any source channels will be created.
- p2 is valid when multi batch is enabled and p1=3 or 4.
- p2 is valid when the measurement mode is set to dual interval and p1=1.

OExecSNTP

Queries the Time Using SNTP

Queries the time using SNTP.

Syntax `OExecSNTP, p1`
 p1 Time query execution (0)

Example Query the time using SNTP.
`OExecSNTP, 0`

OMessage

Message Writing

Writes a message.

Write a Preset Message

Syntax `OMessage, p1, p2, p3, p4`
 p1 Action type (PRESET)
 p2 Message number (1 to 100)
 p3 Display group number
 ALL Write to all display groups
 1 to 60 Write to specified groups
 You can specify multiple groups at once.
 To do so, separate display groups with a colon.
 p4 Batch group number (1 to the number used)

Example Write the message in preset message number 8 to display groups 1 and 2.
`OMessage, PRESET, 8, 1:2`

Description

- p4 is valid when multi batch is enabled. This cannot be omitted.

Write a Free Message

Syntax `OMessage, p1, p2, p3, p4, p5`
 p1 Action type (FREE)
 p2 Message number (1 to 10)
 p3 Display group number
 ALL Write to all display groups
 1 to 60 Write to specified groups
 You can specify multiple groups at once.
 To do so, separate display groups with a colon.
 p4 Message string to write (up to 32 characters, UTF-8)
 p5 Batch group number (1 to the number used)

Example Write a free message "MARK" as message number 2 in display groups 3, 8, and 11.
`OMessage, FREE, 2, 3:8:11, 'MARK'`

Description

- p5 is valid when multi batch is enabled. This cannot be omitted.

OPassword

Changes the Password

Changes the password.

Syntax `OPassword, p1, p2, p3`
 p1 Old password (up to 20 characters, ASCII)
 p2 New password (up to 20 characters, ASCII)
 p3 New password (enter the same password as p2)

Example Change the password from "PASS001" to "WORD005."
`OPassword, 'PASS001', 'WORD005', 'WORD005'`

Description

- For the characters that you can use for the password, see [Appendix 1](#).

OMath

Starts, Stops, or Resets Computation or Clears the Computation Dropout Status Display

Starts or stops computation, resets computed values, or clears the computation dropout status display.

Syntax `OMath, p1, p2`
 p1 Action type (0)
 0 Start computation
 1 Stop computation
 2 Reset computation
 3 Clear the computation dropout status display
 p2 Batch group number

2.6 Operation Commands

All All math channels
1 to the Math channel belonging to the
number specified batch group
used

Query OMath?

Example Start computation.
OMath, 0

Description

- You cannot use this command while the recorder is saving or loading setup data.
- p2 is valid when multi batch is enabled and p1=2 (reset computation).
- Omitting p2 is equivalent to specifying all math channels.

OSaveConf

Saves Setting Data

Saves the recorder setting data to the recorder's external storage medium.

Syntax OSaveConf, p1, p2, p3
p1 File name (up to 80 characters, ASCII)
Specify the path and file name, excluding the extension.
p2 Medium
(GX/GP: SD, USB)
(GM: SD)
SD SD memory card
USB USB flash memory
p3 Setting file comment (up to 50 characters, UTF-8)

Example Save setting data to a file named "SETFILE1" to the SD memory card.
OSaveConf, 'SETFILE1', SD

Description

- If you omit p3, the default setting file comment will be added. You can edit the default setting file comment from the recorder front panel.

OSaveConfAll

Saves Setting Data at Once

Saves the setting data to the specified folder in the external storage medium.

Syntax OSaveConfAll, p1, p2
p1 Folder name (up to 80 characters, ASCII)
Specify the folder name as "path name+folder name."
p2 Medium (SD)
(GX/GP: SD, USB)
(GM: SD)
SD SD card
USB USB Flash Memory

Example Save the setting data collectively to the "CONFIG0" folder of the SD memory card
OSaveConfAll, 'CONFIG0', SD

Description

- If you omit parameter p2, the medium is set to the SD card.

- The following items are saved. File names are indicated in parentheses.
 - Setting data file (Config.GNL or Config.GSL)
 - Scale image [GX/GP only] (ScaleImageXX.png) where XX is the display group
 - Report template (Report_YY.xlsx, Report_YY.xlsm, or Report_YY.tpl) YY is the report type.
 - Trusted certificate
A "Client" folder is created in the specified folder (p1), and the data is saved there.
 - Server certificate
A "Server" folder is created in the specified folder (p1), and the data is saved there.
 - Custom display (GX/GP only)
Creates a (Setting.GCS) setting file, creates a folder indicating the custom display number in the specified folder (p1), and saves data there.
 - Program pattern file (*.GPT)
A "ProgramPattern" folder is created in the specified folder (p1), and the data is saved there.
- The folder name is constrained by the same limitations as the data save destination folder setting (see the explanation of SDirectory). For example, a folder named "ABC" can be created but not " ABC", which contains spaces in the beginning.

OCommCh

Sets a Communication Channel to a value

Sets a communication channel to a value.

Syntax OCommCh, p1, p2
p1 Communication channel
p2 Value

The setting range is as follows:
-9.9999999E+29 to -1.0000000E-30, 0,
1.0000000E-30 to 9.9999999E+29
The number of significant digits is 8.

Query OCommCh[, p1]?

Example Set communication channel C001 to 2.5350.
OCommCh, C001, 2.5350

Description

- The description of execution and response errors are not recorded in the event log.
- Custom display commands cannot be executed.

OEMail

Starts or Stops the E-mail Transmission Function

Starts or stops the e-mail transmission function.

Syntax OEMail, p1
p1 Action type
0 Start the e-mail transmission function.
1 Stop the e-mail transmission function.

Example Start the e-mail transmission function.
OEMail, 0

OMBRestore

Recovers Modbus manually

Resumes command transmission from Modbus client or Modbus master to devices in which communication errors have occurred.

Syntax OMBRestore, p1
p1 Action type
0 Modbus client (Ethernet)
1 Modbus master (serial)

Example Manually recover the Modbus client.
OMBRestore, 0

ORTReset

Resets a Relative Timer

Resets a relative timer.

Syntax ORTReset, p1
p1 Timer type
0 All timers
1 to Timer number
12 Multiple selection is possible by delimiting with colons.

Example Reset relative timer 2.
ORTReset, 2
Reset relative timers 4, 9, and 12.
ORTReset, 4:9:12

OMTReset

Resets the Match Time Timer

Resets the match time timer

Syntax OMTReset, p1
p1 Timer type
0 All timers
1 to Timer number
12 Multiple selection is possible by delimiting with colons.

Example Reset match time timer 2.
OMTReset, 2
Reset match time timers 4, 9, and 12.
ORTReset, 4:9:12

OCmdRelay

Outputs the DO Channel and Internal Switch Status

Outputs the DO channel and internal switch status.

Syntax OCmdRelay, p1
p1 Specification of a setting

- Express the setting. Set a channel status as follows: [channel number]-[status]. Use a hyphen as a separator.
- You can specify the following values for the channel number.
DO channel number
Internal switch number
- You can specify the following values for the status.
Off: Off status
On: On status
- You can specify the status of multiple channels at once. To do so, use a semicolon to separate channels as follows: [channel number]-[status]:[channel number]-[status]:. . . You can specify up to a total of 32 channels that consist of DO channels and internal switches.

Example Set channels 0101, 0102, and 0103 to On and internal switches S001 and S002 to Off.
OCmdRelay, 0101-On:0102-On:0103-On:S001-Off:S002-Off

Description

- If any of the channels that you specify do not exist or are not set to manual output (**SRangeDO** command), the settings of all channels are canceled, and a command error results.

OBatName

Sets a Batch Name

Sets a batch name.

Syntax OBatName, p1
p1 Batch group number
When multi batch is disabled: Always 1
When multi batch is enabled: 1 to the number used
p2 Batch number (up to 32 characters, ASCII)
p3 Lot number (0 to 99999999, up to eight digits, depending on Lot-No. digit)

Query OBatName [, p1] ?

Example Set the batch name structure to batch number "PRESSLINE" and the lot number 007.
OBatName, 1, 'PRESSLINE', 007

Description

- For the characters that you can use in the specified batch number (p2), see [Appendix 1](#).
- You cannot set the batch number to a single space character.
Doing so will clear the batch number.

OBatComment

Sets a Batch Comment

Sets a batch comment.

Syntax `OBatComment, p1, p2, p3`
 p1 Batch group number
 When multi batch is disabled: Always 1
 When multi batch is enabled: 1 to the number used
 p2 Comment number (1 to 3)
 p3 Comment string (up to 50 characters, UTF-8)

Query `OBatComment[, p1[, p2]]?`

Example Set comment number 2 to "THIS PRODUCT IS COMPLETED."
`OBatComment, 1, 2, 'THIS PRODUCT IS COMPLETED'`

Description

- You cannot set the comment string to a single space character. Doing so will clear the comment string.

OBatText

Sets a Batch Text

Sets a batch text.

Syntax `OBatText, p1, p2, p3, p4`
 p1 Batch group number
 When multi batch is disabled: Always 1
 When multi batch is enabled: 1 to the number used
 p2 Field number (1 to 24)
 p3 Field title (up to 20 characters, UTF-8)
 p4 Field string (up to 30 characters, UTF-8)

Query `OBatText[, p1[, p2]]?`

Example For field number 1, set the title to "Ope" and the character string to "GX."
`OBatText, 1, 'Ope', 'GX'`

Description

- You cannot set the field title or field string to a single space character. Doing so will clear them.

ODispRate

Switches the Trend Interval [GX/GP]

Switches between first trend interval (normal trend interval) and second trend interval.

Syntax `ODispRate, p1`
 p1 Trend interval
 NORMAL First trend interval (normal trend interval)
 SECOND Second trend interval

Example Switch from first trend interval to second trend interval.
`ODispRate, SECOND`

Description

- Set the second trend interval with the [STrdRate](#) command.

OLoadConf

Loads Setting Data

Loads a setting data file from the recorder external storage medium into the recorder.

Syntax `OLoadConf, p1, p2, p3, p4`
 p1 File name (up to 80 characters, ASCII)
 Specify the path and file name, excluding the extension.
 p2 Medium
 (GX/GP: SD, USB)
 (GM: SD)
 SD SD memory card
 USB USB flash memory
 p3 Settings to load
 ALL All settings
 SECURITY Security settings only
 CONTROL Control
 IP IP address settings only
 OTHERS All settings except for security and IP address settings
 Multiple options can be selected for p3. To do so, separate items with a colon.
 p4 Setting items to be excluded from the items specified by p3=OTHERS.
 SERVER Server related settings
 CALIB Calibration correction settings
 INSTRU Instrument information settings
 Multiple options can be selected for p4. To do so, separate items with a colon. If p3 is set to ALL, nothing is excluded.

Example Load all settings from the setting file "SETTING1" on the SD memory card.
`OLoadConf, 'SETTING1', SD, ALL`
 Load security and IP address settings from a setting file named "SETTING1" from the SD memory card.
`OLoadConf, 'SETTING1', SD, SECURITY: IP`
 Load settings excluding IP address settings, server related settings, and instrument information, from a setting file named "SETTING1" from the SD memory card.
`OLoadConf, 'SETTING1', SD, SECURITY: OTHERS, SERVER: INSTRU`

Description

- If you omit parameter p2, the medium is set to the SD memory card.
- For p3 and p4 values (setting category) and target commands, see [Setting Category and Target Commands on page 2-98](#).
- If you omit parameter p3, all settings will be loaded.
- If you omit parameter p4, no setting will be excluded.
- If you change the language with this command, the recorder may restart.

OLoadConfAll

Loads Setting Data at Once

Loads all settings from the specified folder of the external storage medium.

Syntax `OLoadConfAll,p1,p2`
 p1 Folder name (up to 80 characters)
 Specify the folder name as “path name+folder name.”
 p2 Medium (SD)
 (GX/GP: SD, USB)
 (GM: SD)
 SD SD card
 USB USB flash memory

Example Load all settings from the “CONFIG0” folder of the SD card.
`OLoadConfAll,'CONFIG0',SD`

Description

- The following items are loaded into the GX/GP/GM. File names are indicated in parentheses.
 - Setting data file (Config.GNL or Config.GSL)
 - Scale image [GX/GP only] (ScaleImageXX.png) where XX is the display group
 - Report template (Report_YY.xlsx, Report_YY.xlsm, or Report_YY.tpl)
YY is the report type.
 - Trusted certificate
The certificate file in the “Client” folder in the specified folder (p1) is loaded.
 - Custom display (GX/GP only)
Loads the (Setting.GCS) setting file and the settings in each folder indicating a custom display number in the specified folder (p1).
 - Program pattern file (*.GPT)
The program pattern file in the “ProgramPattern” folder in the specified folder (p1) is loaded.

OSeriApply

Applies Serial Communication Settings

Applies serial communication settings.

Syntax `OSeriApply,p1`
 p1 Apply the settings (0).

Example Apply serial communication settings.
`OSeriApply,0`

Description

- This command applies the serial communication settings specified by the **SSerialBasic** command.
- When you send this command, the serial communication settings take effect when the recorder returns a response. After this process, the connection will be cut off.

OIPApply

Applies the IP Address

Applies Ethernet communication settings.

Syntax `OIPApply,p1`

p1 Apply the settings (0).

Example Apply the IP address settings.
`OIPApply,0`

Description

- This command applies the IP address settings specified by the **SlpAddress**, **SDhcp**, **SDns**, and **SServer** commands.
- When you send this command, the IP address settings take effect when the recorder returns a response. After this process, the connection will be cut off. This includes Ethernet connections to other devices (Modbus server, FTP server, etc.).

OInit

Clears Measured Data and Initializes Setting Data

Clears the measured data in internal memory. The command also initializes setting data.

Syntax `OInit,p1,p2`
 p1 The types of data to be initialized and cleared
 SECURITY Security settings
 Memory Display data, event data, manual sampled data, report data, alarm summary, message summary
 OTHERS Settings other than those above
 ALL All measured data and settings
 You can specify multiple items at once. To do so, separate items with a colon.
 p2 Setting items to be excluded from the items specified by p1=OTHERS.
 IP IP address settings
 SERVER Server related settings
 CALIB Calibration correction settings
 INSTRU Instrument information settings
 You can specify multiple items at once. To do so, separate items with a colon. If p1 is set to ALL, nothing is excluded.

Example Delete the measured data and summary from the internal memory.

`OInit,MEMORY`

Initialize the settings excluding IP address settings and instrument information.

`OInit,MEMORY:SECURITY:OTHERS,IP:INSTRU`

Description

- IP address settings are those set with the **SlpAddress**, **SDns**, **SDhcp**, and **SDhcp** commands
- For p1 and p2 values (setting category) and target commands, see **Setting Category and Target Commands on page 2-98**.
- If you omit parameter p2, no setting will be excluded.

OUsbFApply

Applies USB Communication Settings [GM]

Applies USB communication settings.

Syntax OUsbFApply, p1
p1 Apply the settings

Example Apply the USB communication On/Off setting specified with the SUsbFunction command.
OUsbFApply, 0

OBTAApply

Applies Bluetooth Communication Settings (/C8) [GM]

Applies Bluetooth communication settings.

Syntax OBTAApply, p1
p1 Apply the settings (0)

Example Apply the Bluetooth communication On/Off setting specified with the SBluetooth command.
OBTAApply, 0

OBTClearList

Clears the Bluetooth Connection List (/C8) [GM]

Clears the Bluetooth connection list.

Syntax OBTClearList
(No parameters)

Example Clear the connected Bluetooth connection list.
OBTClearList

OLoginAssist

Assists Login [GX/GP]

Assists logging in to the recorder, during bar-code input.

Syntax OLoginAssist, p1, p2, p3
p1 Input type (1, 2)
1 User name input
2 User name and user ID input
p2 User name
p3 User ID

Example Log in with the user name "User01."
OLoginAssist, 1, 'User01'

Description

- When this command is executed, the recorder shows the login screen and waits for a user password and user ID input.
- p1 = 2 is valid when the advanced security function (/AS) is enabled.
- p3 is valid when p1 = 2. However, when the user ID is not used, p3 is invalid.
- This command is valid when the serial communication function (the **SSerialBasic** command) is set to Barcode or the USB input device (the **SUsbInPut** command) is set to Barcode.

OSendValue

Assists Touch Panel Operation Input [GX/GP]

Assists text input during touch panel operation.

Syntax OSendValue, p1, p2
p1 Fixed to 0.
p2 Character string (up to 64 characters, UTF-8)

Example On the message settings screen, enter the message "START" (display the message settings screen and select the text box for entering the message string in advance).
OSendValue, 0, 'START'

Description

- Input into a text area that displays asterisks (*****) is not possible.
- This command is valid when the serial communication function (the **SSerialBasic** command) is set to Barcode or the USB input device (the **SUsbInPut** command) is set to Barcode.

OUserLockACK

User Locked ACK (/AS)

Clears the user locked display.

Syntax OUserLockACK

Example Clears the user locked display.
OUserLockACK

Description

- This command can be executed only when logged in as an administrator (Admin user level) or a second administrator (SecondAdmin user level).
- If there are no locked users, nothing will take place.
- Second administrators (SecondAdmin user level) whose user settings are set to Lock cannot use this command to configure settings

OKeyLock

Key Lock On/Off [GM]

Turns key lock on or off.

Syntax OKeyLock, p1
p1 Key lock on/off (On, Off)
On Locks the keys
Off Releases the key lock

Example Release the key lock.

OKeyLock, Off

Description

- Turning the key lock on will lock the START, STOP, USER1, and USER2 keys. You cannot lock the key individually.
- Only administrator level users can turn key lock on and off.
- This command is invalid when the advanced security function (/AS) is enabled and the log in via communication is enabled.

OErrorClear

Clears the Error Display [GM]

Clears the error display status from the 7 segment LED.

Syntax OErrorClear,p1
p1 Error display clear type
0 Error display clear

Example Clear the error display status from the 7 segment LED.
OErrorClear,0

OSLMPRestore

Manually Restores SLMP (/E4)

Resumes command transmission from SLMP client to devices in which communication errors have occurred.

Syntax OSLMPRestore,p1
p1 Fixed to 0

Example Manually recover the SLMP client.
SLMPRestore,0

OTransChAO

Individual Re-transmission Control

Controls the re-transmission of AO channels individually

Syntax OTransChAO,p1
p1 Re-transmission value specification
Express the re-transmission value.

- Express the setting. Set a channel status as follows: [channel number]-[status]. Use a hyphen as a separator.
- You can specify the following values for the status.
Off: Off status
On: On status
- You can specify the status of multiple channels at once. To do so, use a semicolon to separate channels as follows: [channel number]-[status]:[channel number]-[status]:. . . You can specify up to 32 channels.

Example Set re-transmission of channels 0101, 0102, and 0103 to On and that of channels 201 and 202 to Off.
OTransChAO, 0101-On:0102-On:0103-On:201-Off:202-Off

Description

- This command is valid only for channels set to re-transmission (Trans) with the SRangeAO command.
- To check the re-transmission state, use FTransStatAO.

OTransAllAO

Collective re-transmission control

Controls the re-transmission of AO channels collectively

Syntax OTransAllAO,p1
p1 Re-transmission enabled or disabled.
On Re-transmission is enabled.
Off Re-transmission is disabled.

Example Set re-transmission to Off.
OTransAllAO, Off

Description

- This command is valid only for channels set to re-transmission (Trans) with the SRangeAO command.
- To check the re-transmission state, use FTransStatAO.

OCmdAO

Manual output setting

Sets the manual output value of an AO channel.

Syntax OCmdAO,p1,p2
p1 Channel number
p2 Manual output value

Query OCmdAO[,p1]?
An OCmdAO query outputs the setting.

Example Set the manual output value of channel 001 to 10 mA.
OCmdAO,001,10000

Description

- This command is valid only for channels set to manual output (ManualAO) with the SRangeAO command.
- The output range is the span range specified with the SRangeAO command.
- For p2, enter the value excluding the decimal point. (The decimal place is fixed to 3.)
- The description of execution and response errors are not recorded in the event log.
- Custom display commands cannot be executed.

OInitPara

Individual Setting Parameter Initialization

Initializes setting parameters individually

Syntax OInitPara,p1
p1 Setting parameters to initialize
RecCh Recording channels
Group Display groups

- You can specify multiple setting parameters at once. To do so, separate each parameter with a colon as in RecCh:Group.

Example Initialize recording channels and display groups.
OInitPara,RecCh:Group

Description

- Recording channels are those specified by the SrecDisp, SrecEvent, or SrecManual command.

- Display groups are those specified by the SGroup, STripLine, SScIbmp, SMItGroup, SMItTripLine, SMItScIbmp, or SDualGroup commands.

OCtrlAM

Auto/Manual/Cascade Operation Switching

Switches the control operation mode

Syntax OCtrlAM, p1, p2
 p1 Loop number
 P2 Auto/manual/cascade switching
 0 Auto (Auto)
 1 Manual (Man)
 2 Cascade (Cas)

Example Set the operation mode of unit 1, slot 5, loop 2 to manual.
 OCtrlAM, L152, 1

Description

- This command is valid when a PID Control Module is installed.
- If p2=2 (Cas), E0 is returned when cascade control is enabled and E1 when disabled.
- When the module is not installed, E1 is returned.

OCtrlSR

Operation Run/Stop Switching

Switches between operation run (RUN) and operation stop (STOP)

Syntax OCtrlSR, p1, p2
 p1 Loop number (L000 or L001 to L652)
 P2 Operation run/stop switching
 0 Run
 1 Stop

Example Stop the operation of unit 1, slot 5, loop 2.
 OCtrlSR, L152, 1

Description

- This command is valid when a PID Control Module is installed.
- When p1=L000, all loops are specified.
- Operation is not possible while a program pattern is being executed. (Possible in local mode)

OCtrlRL

Remote/Local Switching

Switches between remote and local modes

Syntax OCtrlRL, p1, p2
 p1 Loop number
 P2 Remote/Local Switching
 0 Local
 1 Remote

Example Set the input of unit 1, slot 5, loop 1 to remote.
 OCtrlRL, L151, 1

Description

- This command is valid when a PID Control Module is installed.
- The remote switching (p2=1) operation during program pattern execution is the same as the program switching of program operation (OCtrlMode command).
- When the module is not installed, E1 is returned.

OCtrlAT

Auto-Tuning Request

Starts or stops auto-tuning

Syntax OCtrlAT, p1, p2
 p1 Loop number
 P2 Auto-tuning start/stop
 0 Auto-tuning stop
 1 to 8 Start auto-tuning PID numbers
 9 Start auto-tuning reference deviation PID

Example Start auto-tuning of PID number 5 of loop 1.
 OCtrlAT, L001, 5

Description

- This command is valid when a PID Control Module is installed.
- The response when start or stop is specified with p2 is as follows according to the status at that point.
 Change from a stopped state: E0
 Stop from a running state: E0
 Start from a running state: E1
- When the module is not installed, E1 is returned.

OCtrlSPN

Selects the Target Setpoint Number

Sets the target setpoint (SP) number

Syntax OCtrlSPN, p1, p2
 p1 Loop number
 P2 Target setpoint number SP1 to SP8 (1 to 8)

Example Set the target setpoint number of unit 1, slot 5, loop 2 to 5.
 OCtrlNoSPN, L152, 5

Description

- This command is valid when a PID Control Module is installed.
- When the module is not installed, E1 is returned.

OCtrlMO

Sets the Manual Output Setpoint

Sets the manual output setpoint

Syntax `OCtrlMO,p1,p2,p3`
 p1 Loop number
 p2 Type
 0 Numeric input
 1 Shutdown (tight shut function)
 p3 Manual output setpoint (-50 to 1050 [-5.0% to 105.0%])
 Within the output high and low limits

Example Set the output value of unit 1, slot 5, loop 2 to 23.4%.

```
OCtrlMO,L152,0,234
```

Set the output value of unit 1, slot 5, loop 2 to shutdown.

```
OCtrlMO,L152,1
```

Description

- This command is valid when a PID Control Module is installed.
- You cannot set p3 if p2 is set to 1.
- When the module is not installed, E1 is returned.

OCtrlPAT

Pattern Number Switching (/PG)

Switches the program pattern number

Syntax `OCtrlPAT,p1`
 p1 Pattern number switching (1 to 99)

Query `OCtrlPat?`

Example Switch to program pattern 2.

```
OCtrlPAT,2
```

Description

- This command is valid when the program control function (/PG option) is in use.
- You can set p1 regardless of whether the pattern file is available.

OCtrlMode

Program Operation (/PG)

Switches between program operation run and stop

Syntax `OCtrlMode,p1`
 p1 Program operation mode change
 0 Start of program operation (Prog)
 1 Stop of program operation (Reset)

Example Start program operation.

```
OCtrlMode,0
```

Description

- This command is valid when the program control function (/PG option) is in use.
- This operation is applied to the pattern number specified with OCtrlPat.
- When the module is not installed, E1 is returned.

OCtrlHOLD

Hold Program Operation (/PG)

Syntax `OCtrlHOLD,p1`
 p1 Holding of program operation
 0 Release hold
 1 Hold

Example Release the holding of program operation.

```
OCtrlHOLD,0
```

Description

- This command is valid when the program control function (/PG option) is in use.
- This operation is applied to the pattern number specified with OCtrlPat.
- When program operation is stopped, E1 is returned.

OCtrlADV

Advances Program Operation (/PG)

Syntax `OCtrlAdv,p1`
 p1 Segment advance
 1 Fixed (Advance)

Example Request a segment advance during program operation.

```
OCtrlAdv,1
```

Description

- This command is valid when the program control function (/PG option) is in use.
- This operation is applied to the pattern number specified with OCtrlPat.
- When program operation is stopped, E1 is returned.

OCtrlSP

Sets the Target Setpoint (/PG)

Sets the target setpoint (SP).

Syntax `OCtrlSP,p1,p2`
 p1 Loop number
 p2 Target setpoint (PV range low limit to PV range high limit)

Example Set the target setpoint of unit 1, slot 5, loop 2 to 2.5350.

```
OCtrlSP,L152,2,5350
```

Description

- This command is valid when the program control function (/PG option) is in use.
- Operation is possible only when the program operation is being held.
- If p2 is set to a value outside the range or if the program hold is released (program is running), E1 is returned.
- This operation is applied to the pattern number specified with OCtrlPat.
- When program operation is stopped, E1 is returned.

OCtrlTSP

Sets the Final Target Setpoint (/PG)

Sets the final target setpoint (TSP)

Syntax `OCtrlTSP, p1, p2`
p1 Loop number
P2 Final target setpoint (PV range low limit to PV range high limit)

Example Set the final target setpoint of unit 1, slot 5, loop 2 to 2.5350.
`OCtrlTSP, L152, 2.5350`

Description

- This command is valid when the program control function (/PG option) is in use.
- Operation is possible only when the program operation is being held.
- If p2 is set to a value outside the range or if the program hold is released (program is running), E1 is returned.
- This operation is applied to the pattern number specified with OCtrlPat.
- When program operation is stopped, E1 is returned.

OCtrlRTIME

Sets the Segment Remaining Time (/PG)

Sets the remaining segment time

Syntax `OCtrlRTIME, p1, p2, p3`
p1 Hour (0 to 99)
P2 Minute (0 to 59)
p3 Second (0 to 59)

Example Set the remaining segment time to 11 hours 05 minutes 22 seconds.
`OCtrlRTIME, 11, 05, 22`

Description

- This command is valid when the program control function (/PG option) is in use.
- Operation is possible only when the program operation is being held.
- if the program hold is released (program is running), E1 is returned.
- This operation is applied to the pattern number specified with OCtrlPat.
- When program operation is stopped, E1 is returned.

OCtrlStSeg

Sets the Start Segment Number (/PG)

Sets the start segment of program operation

Syntax `OCtrlStSeg, p1, p2`
p1 Pattern number (1 to 99)
P2 Segment number (1 to the number of segments in use)

Query `OCtrlStSeg[, p1]?`

Example Set the start segment of program pattern number 2 to 3.
`OCtrlStSeg, 2, 3`

Description

- This command is valid when the program control function (/PG option) is in use.
- E1 is returned in the following cases.
Program pattern with the number specified by p1 is running.
Program pattern file for the number specified by p1 cannot be found.
The segment number specified by p2 is greater than the number of segments in use.
- When the program is reset, the start number returns to segment number 1.

OCtrlDlyTime

Sets the Starting Time of Program Operation (/PG)

Sets the delay time between the start of program operation to when the program pattern operation actually starts.

Syntax `OCtrlDlyTime, p1, p2, p3, p4`
p1 Pattern number (1 to 99)
P2 Hour (0 to 99)
p3 Minute (0 to 59)
p4 Second (0 to 59)

Query `OCtrlDlyTime[, p1]?`

Example Set the operation start delay time of program pattern number 2 to 5 minutes 55 seconds.
`OCtrlDlyTime, 2, 0, 5, 55`

Description

- This command is valid when the program control function (/PG option) is in use.
- E1 is returned in the following cases.
Program pattern with the number specified by p1 is running.
Program pattern file for the number specified by p1 cannot be found.
- When the program is reset, the delay time is reset to 00:00:00.

OCtrlLoadPAT

Loads a Pattern File (/PG)

Loads a program pattern file

Syntax OCtrlLoadPAT, p1, p2, p3
 p1 File name (up to 80 characters)
 p2 Medium
 (GX/GP: SD, USB)
 (GM: SD)
 SD SD memory card
 USB USB flash memory
 p3 Load destination
 Pattern file number (1 to 99)

Example Load the program pattern file "PATTERN1" from the SD memory card to pattern file number 1.

```
OCtrlLoadPAT, 'PATTERN1', SD, 1
```

Description

- This command is valid when the program control function (/PG option) is in use.
- If you omit parameter p2, the medium is set to the SD card.

OCtrlSavePAT

Saves a Pattern File (/PG)

Saves a program pattern file

Syntax OCtrlSavePAT, p1, p2, p3
 p1 File name (up to 80 characters)
 p2 Medium
 (GX/GP: SD, USB)
 (GM: SD)
 SD SD memory card
 USB USB flash memory
 p3 Save source
 Pattern file number (1 to 99)

Example Save the program pattern file of pattern file number 1 to a file named "PATTERN1" in the SD memory card.

```
OCtrlSavePAT, 'PATTERN1', SD, 1
```

Description

- This command is valid when the program control function (/PG option) is in use.
- If you omit parameter p2, the medium is set to the SD card.

OCtrlLoadPATAI

Collectively Loads Pattern Files (/PG)

Collectively Loads program pattern files

Syntax OCtrlLoadPATAI, p1, p2
 p1 Folder name (up to 80 characters)
 p2 Medium
 (GX/GP: SD, USB)
 (GM: SD)
 SD SD memory card
 USB USB flash memory

Example Collectively load program pattern files from the "Pattern" folder in the SD memory card.

```
OCtrlLoadPATAI, Pattern, SD
```

Description

- This command is valid when the program control function (/PG option) is in use.
- If you omit parameter p2, the medium is set to the SD card.
- All pattern files in the folder are loaded.
- Only the pattern files with the following fixed file names in the specified folder are loaded.
 File name: ProgPatXX.YYY
 XX: Pattern number (01 to 99)

OCtrlSavePATAI

Collectively saves Pattern Files (/PG)

Collectively saves program pattern files

Syntax OCtrlSavePATAI, p1, p2
 p1 Folder name (up to 80 characters)
 p2 Medium
 (GX/GP: SD, USB)
 (GM: SD)
 SD SD memory card
 USB USB flash memory

Example Collectively save program pattern files to the "Pattern" folder in the SD memory card.

```
OCtrlSavePATAI, Pattern, SD
```

Description

- This command is valid when the program control function (/PG option) is in use.
- If you omit parameter p2, the medium is set to the SD card.
- All pattern files are saved.
- Files are saved with fixed file names in the specified folder.
 File name: ProgPatXX.YYY
 XX: Pattern number (01 to 99)

OCtrlDelPAT

Deletes a Pattern File (/PG)

Deletes a program pattern file

Syntax OCtrlDelPAT, p1
 p1 Pattern file number (1 to 99)

Example Delete pattern file number 99.

```
OCtrlDelPAT, 99
```

Description

- This command is valid when the program control function (/PG option) is in use.

OConfCmt**Write a Setting Comment (/AS)**

Writes in the event log a comment describing the reason for changing the settings.

Syntax `OConfCmt, p1`
 p1 Setting file comment (up to 50 characters, UTF-8)

Example Set the setting comment "Alarm setpoint changed."
`OConfCmt, Alarm setpoint changed`

Description

- NULL cannot be specified in p1.
- This command is valid when the program control function (/PG option) is in use.

2.7 Communication Control Commands**CChecksum****Sets the Checksum**

Sets the presence or absence of checksum.

Syntax `CChecksum, p1`
 p1 Checksum usage
 0 Do not compute
 1 Compute

Query

Example Enable the checksum.
`CChecksum, 1`

CSFilter**Sets the Status Filter**

Sets the filter used when outputting the recorder status.

Syntax `CSFilter, p1`
 p1 Filter values for status information numbers 1 to 4 (0.0.0.0 to 255.255.255.255)

Query `CSFilter?`

Example Set the status filter value to 255.127.63.31.
`CSFilter, 255.127.63.31`

Description

- The status filter is applied to each communication connection.

CSFilterDB**Sets the status filter (expanded)**

Sets the filter used when outputting the recorder status.

Syntax `CSFilterDB, p1, p2`
 p1 Filter values for status information numbers 1 to 4 (0.0.0.0 to 255.255.255.255)
 p2 Filter values for status information numbers 5 to 8 (0.0.0.0 to 255.255.255.255)

Query `CSFilterDB?`

Example Set the status filter value of status information 1 to 4 to 255.127.63.31 and that of status information 5 to 8 to 1.2.3.4.
`CSFilterDB, 255.127.63.31, 1.2.3.4`

Description

- The status filter is applied to each communication connection.
- p2 can be omitted.

CLogin

Log in over a Communication Path

Logs in over a communication path.

Syntax CLogin, p1, p2
 p1 User name
 p2 password

Example Log in using the user name "admin" and password "password."
 CLogin, admin, password

Description

- For the characters that you can use for the password, see [Appendix 1](#).
- If this command is executed while logged in, the user is once logged out and then logged back in.

When Using the Advanced Security Function (/AS)

Syntax CLogin, p1, p2, p3, p4, p5
 p1 User name
 p2 User ID
 p3 Password
 p4 The new password when the password has expired
 p5 The new password when the password has expired for confirmation

Example Log in using the user name "admin01" and password "password01."
 CLogin, admin01, , password01

Description

- If p4 and p5 are not specified, normal login will be used.
- Even if the password has not expired, you can enter a new password in p4 in p5 to change the password and log in.
- If p4 and p5 are not the same, an error will occur.
- You cannot change to the same password (if p3 is the same as p4 and p5, an error will occur).
- If the user ID is not used, p2 is invalid.
- When using the password management, you cannot specify p4 and p5.
- For the characters that you can use for the password, see [Appendix 1](#).
- If this command is executed while logged in, the user is once logged out and then logged back in.

CLogout

Log Out over a Communication Path

Logs out over a communication path.

Syntax CLogout

Example Logs out from the recorder.
 CLogout

CBTConnect

Starts Bluetooth Communication (/C8) [GM]

Starts Bluetooth communication.

Syntax CBTConnect, p1
 p1 Bluetooth password of the device you want to connect to

Example Connect to the device whose Bluetooth password is "PaSswORD2."
 CBTConnect, 'PaSswORD2'

Description

- This command is valid only when a Bluetooth password request has been received via Bluetooth communication. If the command is invalid, error 352, "Unknown command," will occur.

ESC O

Opens an Instrument : RS-422/485 Command

Starts communication with the recorder. ESC in ASCII code is 0x1B. For details, see [Appendix 1](#).

Syntax ESC O p1
 _ Space
 p1 Instrument address (01 to 99)

Example Open the instrument at address 99.
 ESC O 99

Description

- Specify the address of the instrument that you want to communicate with.
- You can only open one instrument at any given time.
- Use a capital "O."
- For this command, use CR+LF for the terminator.
- For the responses to this command, see [page 2-120](#).

ESC C

Closes an Instrument : RS-422/485 Command

Ends communication with the recorder. ESC in ASCII code is 0x1B. For details, see [Appendix 1](#).

Syntax ESC C p1
 _ Space
 p1 Instrument address (01 to 99)

Example Close the instrument at address 77.
 ESC C 77

Description

- This command closes the connection to the instrument you are communicating with.
- Use a capital "C."
- For this command, use CR+LF for the terminator.
- For the responses to this command, see [page 2-120](#).

2.8 Instrument Information Output Commands

_MFG

Outputs the Instrument Manufacturer

Outputs the instrument manufacturer.

Syntax `_MFG`

Description

- For the ASCII output format, see [page 2-173](#).

_INF

Outputs the Instrument's Product Name

Outputs the instrument's product name.

Syntax `_INF`

Description

- For the ASCII output format, see [page 2-173](#).

_COD

Outputs the Instrument's Basic Specifications

Outputs the instrument's basic specifications.

Syntax `_COD`

Description

- For the ASCII output format, see [page 2-174](#).

_VER

Outputs the Instrument's Firmware Version Information

Outputs the instrument's firmware version information.

Syntax `_VER`

Description

- For the ASCII output format, see [page 2-174](#).

_OPT

Outputs the Instrument's Option Installation Information

Outputs the instrument's option installation information.

Syntax `_OPT`

Description

- For the ASCII output format, see [page 2-175](#).

_TYP

Outputs the Instrument's Temperature Unit and Daylight Saving Time Installation Information

Outputs whether the instrument's Fahrenheit temperature unit and daylight saving time setting is enabled or disabled.

Syntax `_TYP`

Description

- For the ASCII output format, see [page 2-176](#).

_ERR

Outputs the Instrument's Error Number Information

Outputs the error description that corresponds to the error number.

Syntax `_ERR, p1, p2, . . .`

Write the details of the negative response returned from the recorder in p1, p2, etc.

Example Output the error description when negative response "E1,10:1:2,500:2:5" is returned.

`_ERR,10:1:2,500:2:5`

Description

- For the ASCII output format, see [page 2-176](#).

_UNS or _UNR

Outputs the Instrument's Unit Configuration Information

Outputs the instrument's unit configuration information.

Syntax `_UNS` Outputs the status that is recognized by the device.
`_UNR` Outputs the installation status.

Description

- For the ASCII output format, see [page 2-177](#).

_MDS or _MDR)

Outputs the Instrument's Module Configuration Information

Outputs the instrument's module configuration information.

Syntax `_MDS` Outputs the status that is recognized by the device.
`_MDR` Outputs the installation status.

Description

- For the ASCII output format, see [page 2-178](#).

2.9 Responses to Commands

This section explains the responses that recorder returns in response to commands. There are three types of responses: affirmative response, negative response, and data output response.

2.9.1 Affirmative Response (For commands other than output request commands)

If the recorder successfully completes the processing of a received command that is not an output request command, it returns an affirmative response.

Syntax

`E0CRLF`

“*CRLF*” is the terminator that the recorder uses. “*CRLF*” will be used in the explanation of the syntax. In the response examples, “*CRLF*” will be omitted.

2.9.2 Negative Response

If a command syntax error, setting error, or other error occurs, the recorder returns a negative response.

Syntax

`E1,p,p,···,pCRLF`

`p` Error number and the position of error occurrence

The detailed format of `p` is indicated below. The recorder outputs the error number, the position of the command where the error occurred, and the position of the parameter where the error occurred, each separated by a colon.

`en:cp:pp`

`en` Error number.

`cp` A value indicating the command position where the error occurred. The position is numbered in order with the first command as 1. For a single command, the recorder outputs 1.

`pp` A value indicating the parameter position where the error occurred. The position is numbered in order with the first parameter in each command as 1. For errors that pertain to the entire command (for example, error in the command name), the recorder outputs 0.

If errors occur in multiple parameters, the recorder outputs numbers separated by commas in ascending order.

Response Example 1

If error number 3 occurs in the second parameter of a single command, the recorder outputs:

`E1,3:1:2`

Response Example 2

If error number 1 occurs in the third parameter and error number 100 occurs in the fifth parameter of a single command, the recorder outputs:

`E1,1:1:3,100:1:5`

Response Example 3

In a string of two commands, if error number 10 occurs in the second parameter of the first command and error number 500 occurs in the fifth parameter of the second command, the recorder outputs:

```
E1,10:1:2,500:2:5
```

Error Messages

You can use the “instrument’s error number information output command” (`_ERR`) to output the error message that corresponds to an error number of a negative response.

2.9.3 Data Output Response

There are two types of data output: ASCII and binary.

ASCII Output

The responses to the following commands are in ASCII.

- Queries for operation commands and setting commands
- ASCII data output requests of output commands

Syntax

```
EACRLF  
ASCII string data . . . . . CRLF  
ASCII string data . . . . . CRLF  
|  
ASCII string data . . . . . CRLF  
ENCRLF
```

The recorder adds a header (EA) in front of the ASCII string output data and a footer (EN) at the end. The recorder adds the two characters `CRLF` to the end of headers, footers, and ASCII string data.

Binary Output

The responses to output commands consisting of binary data output requests are in binary.

Format

The following figure shows the binary output format. The recorder adds a header to the front of binary output data and a checksum at the end. The request data is entered in the data block.

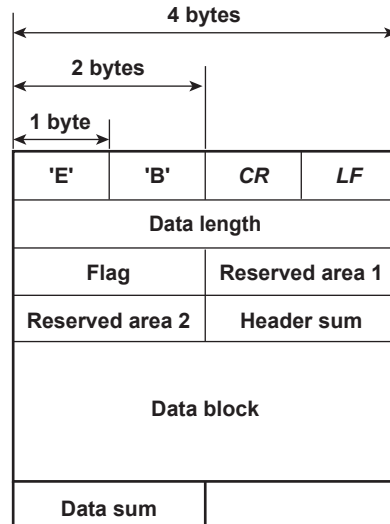

EBCRLF

The EBCRLF block stores ASCII code “E,” ASCII code “B,” followed by “CR” “LF.” This indicates that the output data is binary.

Data length (32 bits unsigned integer, big endian)

The data length block indicates the length of “flag + reserved area 1 + reserved area 2 + header sum + data block + data sum” in bytes.

Flag (16 bits, big endian)

The flag block indicates information of the entire data block.

Bit	Flag Value		Flag Meaning
	0	1	
15	Always zero		Not used
14	No	Yes	Data sum inclusion
13	Always zero		Not used
:			
1			
0	Intermediate data	Last data	If the output data is continuous data, this flag indicates whether the last value in the data block is intermediate data or last data.

Reserved area 1 (16 bits), reserved area 2 to (16 bits)

Not used

Header sum (16 bits, big endian)

The header sum block indicates the sum of “data length + flag + reserved area 1 + reserved area 2.”

Data Block

The actual output data. The format varies depending on the output content. For details, see section 2.11, “[Format of the Data Block of Binary Output](#).”

Data sum (16 bits, big endian)

The data sum block indicates the sum of the data block. Use the CChecksum command to specify whether to include data sum. By default, check sum is set to “No.” Whether data sum is included is expressed by a flag in the header block. If the data sum block is not included, the area itself will not be included. For the check sum calculation method, see [Appendix 5 Check Sum Calculation Method](#).

2.9.4 Output in Response to RS-422/485 Commands

The table below shows the responses to the ESC O command and ESC C command. ESC in ASCII code is 0x1B. For details, see [Appendix 1 ASCII Character Codes](#).

Syntax	Meaning	Response
ESC O <u> </u> xxCRLF (<u> </u> : Space)	Opens an instrument	<ul style="list-style-type: none"> Response from the destination instrument ESC OxxCRLF If there is no instrument at the address specified by the command* No response
ESC C <u> </u> xxCRLF (<u> </u> : Space)	Closes an instrument	<ul style="list-style-type: none"> Response from the destination instrument ESC CxxCRLF If there is no instrument at the address specified by the command* No response

* Some possible reasons why the condition “there is no instrument at the address specified by the command” occurs are command error, the address assigned to the instrument is different, the instrument is not turned on, and the instrument is not connected through serial interface.

- “xx” in the table represents the instrument address. You can specify any address within the range of 01 to 99 and within the addresses assigned to the communication target instruments.
- You can only open one instrument at any given time.
- When you open an instrument with the ESC O command, you can send commands to it.
- Use CR+LF for the terminator.

2.10 ASCII Output Format

This section explains the ASCII output format.

- In the following format descriptions, the terminator is denoted by “<crLf>.”
- One space (ASCII code : 0x 20) is denoted by an underscore (_). Consecutive spaces are denoted by alternating underscores (_) and overscores (^).
- An I/O channel is expressed as a four-digit number (e.g., 0102), a math channel is expressed as “A” followed by a three-digit number (e.g., A015), and a communication channel is expressed as “C” followed by a three-digit number (e.g., C120).

2.10.1 Most Recent Channel Data (FData)

The output in response to the command “FData,0” is shown below.

Syntax

```
EA<crLf>
DATE_YY/mo/dd<crLf>
TIME_hh:mm:ss.mmmt<crLf>
s_cccca1a2a3a4uuuuuuuuuuufdddddE-pp<crLf>
s_cccca1a2a3a4uuuuuuuuuuufdddddE-pp<crLf>
...
s_cccca1a2a3a4uuuuuuuuuuufdddddE-pp<crLf>
EN<crLf>
```

yy/mo/dd	Data time (year, month, day)
	YY Year (00 to 99)
	mo Month (01 to 12)
	dd Day (01 to 31)
hh:mm:ss.mmmt	Data time (hour, minute, second, millisecond)
	hh Hour (00 to 23)
	mm Minute (00 to 59)
	ss Second (00 to 59)
	mmm Millisecond (000 to 999)
	A period is inserted between the minute and millisecond.
t	Reserved (space)
s	Data status
	N Normal
	D Differential input
	S Skip
	O Over
	E Errors
	B Burnout
	C Communication channel error
cccc	Channel number (I/O channel, math channel, communication channel)
a1a2a3a4	a1 Alarm status (level 1)
	a2 Alarm status (level 2)
	a3 Alarm status (level 3)
	a4 Alarm status (level 4)
	a1, a2, a3, and a4 is set to one of the following:
	H High limit alarm
	L Low limit alarm
	h Difference high limit alarm
	l Difference low limit alarm
	R High limit on rate-of-change alarm
	r Low limit on rate-of-change alarm
	T Delay high limit alarm
	t Delay low limit alarm
	Space No alarm
	The alarm statuses of control alarms (when a PID control module is installed) are all set to zero.
uuuuuuuuuu	Unit (fixed to 10 characters. Output flush left. Unused character positions are filled with spaces.)

	<pre> mV - - - - V = = = = °C - - - - </pre>	<pre> mV V °C </pre>
f	Sign (+ or -)	
ddddddddd	Mantissa (00000000 to 99999999; 8 digits)	
	For erroneous data (data status is E), the mantissa is 99999999.	
	If the data status is O (±over), the mantissa is 99999999 (+over) or -99999999 (-over).	
	If the data status is B (burnout), the mantissa is 99999999 (+burnout) or -99999999 (-burnout).	
pp	Exponent (00 to 05)	
	On channels set to Log scale (/LG), pp is a two digit integer, and the sign before pp is + or -. If the data status is E, O, or B, this value will be +99, including the sign.	

2.10.2 Most Recent (DO Channel) Status (FRelay)

The output in response to the command "FRelay,0" is shown below.

Syntax

When no expandable I/O is connected

```
EA<crLf>
M00:aaa...<crLf>
M01:aaa...<crLf>
M02:aaa...<crLf>
M03:aaa...<crLf>
M04:aaa...<crLf>
M05:aaa...<crLf>
M06:aaa...<crLf>
M07:aaa...<crLf>
M08:aaa...<crLf>
M09:aaa...<crLf>
EN<crLf>
```

When an expandable I/O or sub unit is connected

Only the information of detected units will be output.

```
EA<crLf>
Unit:nf
M00:aaa...<crLf>
M01:aaa...<crLf>
M02:aaa...<crLf>
M03:aaa...<crLf>
M04:aaa...<crLf>
M05:aaa...<crLf>
M06:aaa...<crLf>
M07:aaa...<crLf>
M08:aaa...<crLf>
M09:aaa...<crLf>
Unit:nf
M00:aaa...<crLf>
M01:aaa...<crLf>
M02:aaa...<crLf>
M03:aaa...<crLf>
M04:aaa...<crLf>
M05:aaa...<crLf>
M06:aaa...<crLf>
M07:aaa...<crLf>
M08:aaa...<crLf>
M09:aaa...<crLf>
:
Unit:nf
M00:aaa...<crLf>
M01:aaa...<crLf>
M02:aaa...<crLf>
```

```

M03:aaa...<crLf>
M04:aaa...<crLf>
M05:aaa...<crLf>
M06:aaa...<crLf>
M07:aaa...<crLf>
M08:aaa...<crLf>
M09:aaa...<crLf>
EN<crLf>

```

nn Unit number

f * Main unit

(Space) Expandable I/O or sub unit

aaa... Outputs the relay (DO channel) status of module numbers 00 to 09.

If the module installed in the corresponding module number is not a DO module, a hyphen is output.

If the module installed in the corresponding module number is a DO module, "1" or "0" is output for the number of channels in the module in ascending order by channel number.

"1" indicates relay (DO channel) ON state, and "0" indicates relay (DO channel) OFF state.

If the DO terminal action (relay action) of a PID control module is set to "Contact output within module," the DO (relay) status is fixed to OFF.

2.10.3 Internal Switch Status (FRelay)

The output in response to the command "FRelay,1" is shown below.

Syntax

```
EA<crLf>
S001-010:aaaaaaaaa<crLf>
S011-020:aaaaaaaaa<crLf>
S021-030:aaaaaaaaa<crLf>
S031-040:aaaaaaaaa<crLf>
S041-050:aaaaaaaaa<crLf>
S051-060:aaaaaaaaa<crLf>
S061-070:aaaaaaaaa<crLf>
S071-080:aaaaaaaaa<crLf>
S081-090:aaaaaaaaa<crLf>
S091-100:aaaaaaaaa<crLf>
EN<crLf>
```

aaa...a The most recent internal switch status is output.
The internal switch status is output 10 channels per line over 10 lines.
"1" indicates that the internal switch is ON, and "0" indicates that the internal switch is OFF.

2.10.4 Latest re-transmission output (AO channel) state (FTransStatAO)

The output in response to the command "FTransStatAO" is shown below.

Syntax

When no expandable I/O is connected

```
EA<crLf>
M00:aaa...<crLf>
M01:aaa...<crLf>
M02:aaa...<crLf>
M03:aaa...<crLf>
M04:aaa...<crLf>
M05:aaa...<crLf>
M06:aaa...<crLf>
M07:aaa...<crLf>
M08:aaa...<crLf>
M09:aaa...<crLf>
EN<crLf>
```

When an expandable I/O or sub unit is connected

Only the information of detected units will be output.

```
EA<crLf>
Unit:nf
M00:aaa...<crLf>
M01:aaa...<crLf>
M02:aaa...<crLf>
M03:aaa...<crLf>
M04:aaa...<crLf>
M05:aaa...<crLf>
M06:aaa...<crLf>
M07:aaa...<crLf>
M08:aaa...<crLf>
M09:aaa...<crLf>
:
Unit:nf
M00:aaa...<crLf>
M01:aaa...<crLf>
M02:aaa...<crLf>
M03:aaa...<crLf>
M04:aaa...<crLf>
M05:aaa...<crLf>
M06:aaa...<crLf>
```

```
M07:aaa...<crLf>
M08:aaa...<crLf>
M09:aaa...<crLf>
EN<crLf>
```

nn Unit number

f * Main unit

(Space) Expandable I/O or sub unit

aaa... Outputs the re-transmission (AO channel) states of module numbers 00 to 09.
If the module installed in the corresponding module number is not an AO module,
a hyphen is output.

If the module installed in the corresponding module number is a AO module, "1"
or "0" is output for the number of channels in the module in ascending order by
channel number.

"1" indicates re-transmission (AO channel) ON state, and "0" indicates re-
transmission (AO channel) OFF state.

If the channel range setting is Skip or manual output, a hyphen is output.

2.10.5 Users Who Are Currently Logged In (FUser)

The output in response to the command "FUser,0" is shown below.

Syntax

```
EA<crLf>
p_l_uuuuuuuuuuuuuuuuuuuuuu_abcdefghijklmnopqrstuvwxy<crLf>
EN<crLf>
```

p	<p>Login mode</p> <ul style="list-style-type: none"> M Via general communication W Via Web (HTTP server) F Via FTP server S RS-232, RS-422/485, USB communication, or Bluetooth D Via front panel
l	<p>User level</p> <ul style="list-style-type: none"> A Administrator B Second administrator (only when the advanced security function (/AS) enabled) U User M Monitor (only when the advanced security function (/AS) enabled)
uuuuuuuuuuuuuuuuuuuuuu	<p>User name (fixed to 20 characters. Unused character positions are filled with spaces.)</p>
abcdefghijklmnopqrstuvwxy	<p>Authority of user</p> <ul style="list-style-type: none"> F Free L Lock <p>a through y represent actions. p through y are output only when the advanced security function (/AS) is enabled.</p> <ul style="list-style-type: none"> a Memory b Math c Data save d Message e Batch f Alarm ACK g Communication h Touch operation i Time set j Setting operation k External media m System operation n Output operation p Calibration correction setting operation q to y Not used (Spaces)

2.10.6 All Users Who Are Currently Logged In (FUser)

The output in response to the command "FUser,1" is shown below.

Syntax

```
EA<crLf>
p_l_ffffffffffffffffffffffff_abcdefghijklmnopqrstuvwxy<crLf>
p_l_ffffffffffffffffffffffff_abcdefghijklmnopqrstuvwxy<crLf>
p_l_ffffffffffffffffffffffff_abcdefghijklmnopqrstuvwxy<crLf>
p_l_ffffffffffffffffffffffff_abcdefghijklmnopqrstuvwxy<crLf>
EN<crLf>
```

p	Login mode
	M Via general communication
	W Via Web (HTTP server)
	F Via FTP server
	S RS-232, RS-422/485, USB communication, or Bluetooth
	D Via front panel
l	User level
	A Administrator
	B Second administrator (only when the advanced security function (/AS) enabled)
	U User
	M Monitor (only when the advanced security function (/AS) enabled)
ffffffffffffffffffffffff	User name (fixed to 20 characters. Unused character positions are filled with spaces.)
abcdefghijklmnopqrstuvwxy	Authority of user
	F Free
	L Lock
	a through y represent actions. p through y are output only when the advanced security function (/AS) is enabled.
	a Memory
	b Math
	c Data save
	d Message
	e Batch
	f Alarm ACK
	g Communication
	h Touch operation
	i Time set
	j Setting operation
	k External media
	m System operation
	n Output operation
	p Calibration correction setting operation
	q to y Not used (Spaces)

The output in response to the command "FUser,3" is shown below.

Syntax

```
EA<crLf>
p_l_fffffffffffffffffffffff_abcdefghijklmnopqrstuvwxyABCDEFGHIJKLMN<crLf>
p_l_fffffffffffffffffffffff_abcdefghijklmnopqrstuvwxyABCDEFGHIJKLMN<crLf>
p_l_fffffffffffffffffffffff_abcdefghijklmnopqrstuvwxyABCDEFGHIJKLMN<crLf>
p_l_fffffffffffffffffffffff_abcdefghijklmnopqrstuvwxyABCDEFGHIJKLMN<crLf>
EN<crLf>
```

P	Login mode M Via general communication W Via Web (HTTP server) F Via FTP server S RS-232, RS-422/485, USB communication, or Bluetooth D Via front panel
l	User level A Administrator B Second administrator (only when the advanced security function (/AS) enabled) U User M Monitor (only when the advanced security function (/AS) enabled)
ffffffffffffffffffffffff abcdefghijklmnopqrstuvwxyABCDEFGHIJKLMN	User name (fixed to 20 characters. Unused character positions are filled with spaces.) Authority of user F Free L Lock a Memory b Math c Data save d Message e Batch f Alarm ACK g Communication h Touch operation i Time set j Setting operation k External media m System operation n Output operation p Calibration correction setting operation q to y Not used (Spaces) A Remote/Local operation B Control operation C Tuning operation D Program operation E SP operation F to N Not used (Spaces) p through y are output only when the advanced security function (/AS) is enabled.

2.10.7 Instrument Address (FAddr)

The output in response to the command "FAddr,IP" is shown below.

Syntax

```
EA<crLf>
IP_Address_ _ _ :xxx.xxx.xxx.xxx<crLf>
Subnet_Mask_ _ _ :xxx.xxx.xxx.xxx<crLf>
Default_Gateway_ :xxx.xxx.xxx.xxx<crLf>
Primary_DNS_ _ _ :xxx.xxx.xxx.xxx<crLf>
Secondary_DNS_ _ :xxx.xxx.xxx.xxx<crLf>
Host_ _ _ _ _ _ :yyyyyyyyyyyyyyyyyyyy...<crLf>
Domain_ _ _ _ _ :zzzzzzzzzzzzzzzzzzzz...<crLf>
EN<crLf>
```

xxx	IP address number (0 to 255)
yyy...	Host name (fixed to 64 characters. Unused character positions are filled with spaces.)
zzz...	Domain name (fixed to 64 characters. Unused character positions are filled with spaces.)

2.10.8 Recorder status (FStat)

The output in response to the command "FStat,0" is shown below.

Syntax

```
EA<crLf>
aaa.bbb.ccc.ddd<crLf>
EN<crLf>
```

The output in response to the command "FStat,1" is shown below.

Syntax

```
EA<crLf>
aaa.bbb.ccc.ddd.eee.fff.ggg.hhh<crLf>
EN<crLf>
```

```
aaa      Status information 1 (see table below)
bbb      Status information 2 (see table below)
ccc      Status information 3 (see table below)
ddd      Status information 4 (see table below)
eee      Status information 5 (see table below)
fff      Status information 6 (see table below)
ggg      Status information 7 (see table below)
hhh      Status information 8 (see table below)
```

Status Information 1

Bit	Name	Description
0	Under control	Set to 1 while the recorder is under control.
1	Memory sampling	Set to 1 during recording
2	Computing	Set to 1 while computation is in progress.
3	Alarm activated	Set to 1 when an alarm is activated.
4	Accessing medium	Set to 1 while the SD medium is being accessed.
5	E-mail started	Set to 1 while the e-mail transmission has been started.
6	Buzzer activated	Set to 1 when the buzzer is activated.
7	Re-transmitting	Set to 1 while re-transmitting.

Status Information 2

Bit	Name	Description
0	-	-
1	-	-
2	Memory end	Set to 1 when the free space in the external memory is low.
3	Touch operation login	Set to 1 when a user is logged in through touch operation.
4	User lock out present	Set to 1 when a user lock out occurs, and remains at 1 until user locked ACK is issued (only when the advanced security function (/AS) enabled).
5	-	-
6	Measurement error	Set to 1 while measurement errors are detected on an AI module or when a burnout has occurred.
7	Communication error	Set to 1 when a Modbus master, Modbus client, WT communication, or SLMP communication error has occurred.

Status 3 and 4 are edge operations. They are cleared when read.

Status Information 3

Bit	Name	Description
0	Computation dropout	Set to 1 when computation cannot keep up.
1	Decimal and unit information setting	Set to 1 when the decimal or unit information is changed.
2	Command error	Set to 1 when there is a command syntax error.
3	Execution error	Set to 1 when there is a command execution error.
4	SNTP error at startup	Set to 1 when SNTP time synchronization fails at startup.
5	-	-
6	-	-
7	-	-

Status Information 4

Bit	Name	Description
0	-	-
1	Medium access complete	Set to 1 when a display, event, manual-sample, report, or screen-image data file is saved to the external storage medium. Set to 1 when settings have been successfully saved or loaded.
2	Report generation complete	Set to 1 when report generation is complete.
3	Timeout	Set to 1 when a timer expires.
4	Saving or loading complete	Set to 1 when the saving or loading of setting parameters, report template, scale image, custom display settings, and trusted certificate is complete.
5	-	-
6	-	-
7	-	-

Status Information 5

Bit	Name	Description
0	Batch group #1 memory sampling	Set to 1 while recording is in progress.
1	Batch group #2 memory sampling	Set to 1 while recording is in progress.
2	Batch group #3 memory sampling	Set to 1 while recording is in progress.
3	Batch group #4 memory sampling	Set to 1 while recording is in progress.
4	Batch group #5 memory sampling	Set to 1 while recording is in progress.
5	Batch group #6 memory sampling	Set to 1 while recording is in progress.
6	Batch group #7 memory sampling	Set to 1 while recording is in progress.
7	Batch group #8 memory sampling	Set to 1 while recording is in progress.

Status Information 6

Bit	Name	Description
0	Batch group #9 memory sampling	Set to 1 while recording is in progress.
1	Batch group #10 memory sampling	Set to 1 while recording is in progress.
2	Batch group #11 memory sampling	Set to 1 while recording is in progress.
3	Batch group #12 memory sampling	Set to 1 while recording is in progress.
4	-	-
5	-	-
6	-	-
7	-	-

Status Information 7

Bit	Name	Description
0	-	-
1	-	-
2	-	-
3	-	-
4	-	-
5	-	-
6	-	-
7	-	-

Status Information 8

Bit	Name	Description
0	-	-
1	-	-
2	-	-
3	-	-
4	-	-
5	-	-
6	-	-
7	-	-

2.10.9 Alarm Summary (FLog)

The output in response to the command "FLog,ALARM" is shown below.

Syntax

```
EA<crLf>
yyyy/mo/dd_hh:mm:ss.ttt_kkk_cccc_lss<crLf>
...
EN<crLf>
```

```

yyyy/mo/dd_hh:mm:ss.ttt  Time of alarm occurrence
                          YYYY          Year (1900 to 2099)
                          mo           Month (01 to 12)
                          dd           Day (01 to 31)
                          hh           Hour (00 to 23)
                          mm           Minute (00 to 59)
                          ss           Second (00 to 59)
                          ttt          Millisecond (000 to 999)
                          A period is inserted between the minute and
                          millisecond.
kkk                        Alarm cause
                          OFF          Alarm release
                          ON_         Alarm occurrence
                          ACK         All channel alarm ACK, Individual alarm
                          ACK         ACK
                          ALL         All channel alarm OFF
cccc                        Channel number (set to four spaces if the alarm cause is
                          "ACK" or "ALL")
l                            Alarm level (1 to 4)
ss                           Alarm type
                          H_          High limit alarm
                          h_          Difference high limit alarm
                          L_          Low limit alarm
                          l_          Difference low limit alarm
                          R_          High limit on rate-of-change alarm
                          r_          Low limit on rate-of-change alarm
                          T_          Delay high limit alarm
                          t_          Delay low limit alarm

```

If the cause of alarm is "all channel alarm ACK" or "all channel alarm OFF," the channel number, alarm level, and alarm type will be blank.

If the cause of alarm is "individual alarm ACK," the alarm type will be blank.

2.10.10 Message Summary (FLog)

The output in response to the command "FLog,MSG" is shown below.

Syntax

```
EA<crLf>
yyyY/mo/dd_hh:mm:ss_YYY/MO/DD_HH:MM:SS_t_mmm...m_zzz_ggg...g_uuu...
u<crLf>
...
EN<crLf>
```

yyyY/mo/dd_hh:mm:ss	Time when the message was written
YYY	Year (1900 to 2099)
mo	Month (01 to 12)
dd	Day (01 to 31)
hh	Hour (00 to 23)
mm	Minute (00 to 59)
ss	Second (00 to 59)
YYY/MO/DD_HH:MM:SS	Data position where message was written
YYY	Year (1900 to 2099)
MO	Month (01 to 12)
DD	Day (01 to 31)
HH	Hour (00 to 23)
MM	Minute (00 to 59)
SS	Second (00 to 59)
t	Message type
	N Normal message
	H Freehand message
mmm...m	Message (fixed to 48 characters. Unused character positions are filled with spaces.) For freehand message, the string "(image)" is output.
zzz	Operation property (3 characters)
	KEY Touchscreen operation, key operation
	REM Remote
	COM Ethernet communication
	SER Serial communication (RS-232, RS-422/485, USB communication, or Bluetooth)
	ACT Event action
	SYS System
	EXT Operation from an external device (e.g. Modbus)
	WEB Operation from web pages (GM, only when the advanced security function (/AS) is enabled)
ggg...g	Target group (multiple groups are expressed using dot delimiters) (fixed to 16 characters. Unused character positions are filled with spaces.)
	ALL All display groups
	aa.bb.cc.dd... Multiple display groups
uuu...u	User name (fixed to 20 characters. Unused character positions are filled with spaces.)

2.10.11 Event log (FLog)

The output in response to the command "FLog,EVENT" is shown below.

Syntax

```
EA<crLf>
yyyy/mo/dd_hh:mm:ss_zzz_-sss...s_uuu...u<crLf>
...
EN<crLf>
```

```
yyyy/mo/dd_hh:mm:ss Time of event occurrence
                        YYYY      Year (1900 to 2099)
                        mo        Month (01 to 12)
                        dd        Day (01 to 31)
                        hh        Hour (00 to 23)
                        mm        Minute (00 to 59)
                        ss        Second (00 to 59)

zzz                    Event cause
                        KEY       Touchscreen operation, key operation
                        REM       Remote
                        COM       Ethernet communication
                        SER       Serial communication (RS-232, RS-
                                422/485, USB communication, or
                                Bluetooth)
                        ACT       Event action
                        SYS       System
                        EXT       Operation from an external device (e.g.
                                Modbus)
                        WEB       Operation from web pages (GM, only when
                                the advanced security function (/AS) is
                                enabled)

sss...s                Event string (fixed to 16 characters. Unused character
                                positions are filled with spaces.)
                                See section "2.10.23 Detail Event Log Output (FEventLog (/
                                AS)".

uuu...u                User name (fixed to 20 characters. Unused character
                                positions are filled with spaces.)
```

2.10.12 Error Log (FLog)

The output in response to the command "FLog,ERROR" is shown below.

Syntax

```
EA<crLf>
yyyy/mo/dd_hh:mm:ss_nnn_uuu...u<crLf>
...
EN<crLf>
```

```
yyyy/mo/dd_hh:mm:ss Time of error occurrence
                        YYYY      Year (1900 to 2099)
                        mo        Month (01 to 12)
                        dd        Day (01 to 31)
                        hh        Hour (00 to 23)
                        mm        Minute (00 to 59)
                        ss        Second (00 to 59)

nnn                    Error code (001 to 999)
uuu...u                Error message (fixed to 80 characters. Unused character
                                positions are filled with spaces.)
```

2.10.13 Address Setting Log (FLog)

The output in response to the command "FLog,DHCP" is shown below.

Syntax

```
EA<crLf>
yyyy/mo/dd_hh:mm:ss_kkk...k_mmm...m<crLf>
...
EN<crLf>
```

```
yyyy/mo/dd_hh:mm:ss Time of occurrence
                        yyyy      Year (1900 to 2099)
                        mo        Month (01 to 12)
                        dd        Day (01 to 31)
                        hh        Hour (00 to 23)
                        mm        Minute (00 to 59)
                        ss        Second (00 to 59)

kkk...k                Type (fixed to 15 characters. Unused character positions are
                        filled with spaces. See table below.)

mmm...m                Message (fixed to 20 characters. Unused character positions are
                        filled with spaces. See table below.)
```

Type	Message	Error Message
LINK	ON	Ethernet connection detected
	OFF	Ethernet disconnection detected
SET	Address (e.g., 10.0.122.3)	IP address set
DHCP	OFF	DHCP disabled
	ON	DHCP enabled
	RENEWING	Acquired IP address renewing
	RELEASING	Acquired IP address releasing
	REJECTING	Acquired IP address rejecting*
	RENEWED	IP address renewed
	RELEASED	IP address released
	EXTENDED	IP address extension application complete
	ESEND	DHCP message transmission failed
	ESERVER	DHCP server search failed
	ESERVFAIL	DHCP server response failed (reception timeout)
	ERENEWED	IP address renewal failed
	ERELEASED	IP address release failed
	EEXTENDED	IP address extension application failed
EEXPIRED	IP address lease expiration	
DNS	UPDATED	DNS host name registration complete
	REMOVED	DNS host name removal complete
	EFORMERR	DNS message syntax error
	ESERVFAIL	DNS server processing error
	ENXDOMAIN	DNS server query rejected (domain does not exist)
	EREFUSED	DNS server query rejected (process not allowed)
	EYXDOMAIN	DNS server query rejected (record exists)
	EYXRESET	DNS server query rejected (record exists)
	ENXRESET	DNS server query rejected (record does not exist)
	ENOTAUTH	DNS server query rejected (not authenticated)
	ENOTZONE	DNS server query rejected (query error)
	ENOTIMP	DNS server query rejected (The command is not implemented.)
	ENONAME	Tried to register an blank host name to the DNS server.

* If the recorder cannot accept the IP address obtained from the DHCP server, the recorder will reject the address and immediately return a response to the DHCP server.

2.10.14 General Communication Log (FLog)

The output in response to the command "FLog,General" is shown below.

Syntax

```
EA<crLf>
yyyy/mo/dd_hh:mm:ss_nn_uuu...u_fm...m<crLf>
...
EN<crLf>
```

```
yyyy/mo/dd_hh:mm:ss Time of command Tx/Rx
                        YYYY          Year (1900 to 2099)
                        mo            Month (01 to 12)
                        dd            Day (01 to 31)
                        hh            Hour (00 to 23)
                        mm            Minute (00 to 59)
                        ss            Second (00 to 59)
nn                      Connection ID
                        s0            Serial (general)
                        s1            Bluetooth connection
                        s2            USB connection
                        e0            Ethernet connection #0 (general)
                        e1            Ethernet connection #1 (general)
                        e2            Ethernet connection #2 (general)
                        e3            Ethernet connection #3 (general)
uuu...u                User name (fixed to 20 characters. Unused character positions
                        are filled with spaces.)
f                      Multiple command flag
                        Space         Single command
                        *              Multiple commands
d                      Tx/Rx
                        >              Tx (command: connected instrument to
                        recorder)
                        <              Rx (Response: recorder to connected
                        instrument)
mmm...m                Message (fixed to 40 characters. Unused character positions are
                        filled with spaces.)
                        The recorder normally outputs the data that has been transmitted
                        or received as-is, but it sometimes outputs special messages.
                        Special messages are shown below.
                        (output)        Data output
                        (Over length)   Command length too long
                        (timed out)     Timeout
                        (disconnected)  Disconnection (occurs when an
                        Ethernet connection is disconnected)
```

2.10.15 Modbus Communication Log (FLog)

The output in response to the command "FLog,Modbus" is shown below.

Syntax

```
EA<crLf>
yyyy/mo/dd_hh:mm:ss_c_XXXXXX_kkk...k_nnn_d<crLf>
...
EN<crLf>
```

```
yyyy/mo/dd_hh:mm:ss Time of error occurrence
                        YYYY      Year (1900 to 2099)
                        mo        Month (01 to 12)
                        dd        Day (01 to 31)
                        hh        Hour (00 to 23)
                        mm        Minute (00 to 59)
                        ss        Second (00 to 59)

c                      Communication type
                        M         Modbus master
                        C         Modbus client

XXXXXX                 Event that occurred (fixed to 6 characters)
                        ACTIVE    Activated
                        READY_    Command ready state
                        CLOSE_    Disconnected
                        HALT_     Command halted
                        _ _ _     Other than those above

kkk...k                Details (fixed to 15 characters. Unused character positions are
                        filled with spaces. See table below.)

nnn                    Command number (0 to 999)
d                      Command type
                        R         Read
                        W         Write
                        O         Write immediately (write from the custom display)
                        N         Miscellaneous
```

Detail*	Meaning
SKIP	Command not set.
INVALID	Command cannot be executed.
WAITING	Server/slave communication recovery wait.
CLOSED	Server/slave connection closed.
RESOLVING	Server/slave connection being established (resolving address).
CONNECTING	Server/slave connection being established (requesting connection).
UNREACH	Server/slave connection failed (peer not found).
TIMEDOUT	Server/slave connection failed (timeout occurred).
BROKEN	Response message corrupt (CRC error).
ERR_FC	Response message was an illegal function message.
ERR_ADDR	Response message was an illegal data address message.
ERR_VALUE	Response message was an illegal data value message.
ERR_DEVICE	Response message was a slave device failure message
ERR_ACK	Response message was an acknowledge message.
ERR_BUSY	Response message was a slave device busy message.
ERR_NEGATIVE	Response message was a negative acknowledge message.
ERR_GATE_PATH	Response message was a gateway path unavailable message.
ERR_GATE_TARGET	Response message was a gateway target device failed to respond message.
BAD_SLAVE	The slave address of the response message is invalid (does not match the command).
BAD_FC	The function code of the response message is invalid (does not match the command).

Detail*	Meaning
BAD_ADDR	The address of the response message is invalid (does not match the command).
BAD_NUM	The register of the response message is invalid (does not match the command).
BAD_CNT	The number of registers in the response message is invalid (does not match the command).
NO_DATA	Data has not yet been received once.
BAD_DATA	Data conversion of the response message failed.
VALID	Data is being acquired normally.
DROP_OUT	Communication dropout occurred due to the inability to keep up.
STALE	The response from the connected device is slow relative to the read cycle.
START	Modbus or communication settings were changed.
STOP	Modbus or communication settings were changed.

* “_” expresses an underscore.

2.10.16 FTP Client Log (FLog)

The output in response to the command “FLog,FTP” is shown below.

Syntax

```
EA<crLf>
yyyy/mo/dd_hh:mm:ss_XXXXXXXX_k_fff...f<crLf>
...
EN<crLf>
```

yyyy/mo/dd_hh:mm:ss Time of error occurrence

YYYY Year (1900 to 2099)
 mo Month (01 to 12)
 dd Day (01 to 31)
 hh Hour (00 to 23)
 mm Minute (00 to 59)
 ss Second (00 to 59)

XXXXXXXX

Detailed code (fixed to 9 characters)

TCPIP_ _ _ Internal processing error
 HOSTADDR_ IP address not set
 HOSTNAME_ Unable to resolve server host name
 UNREACH_ Unable to connect to server
 CONNECT_ Unable to connect to data port
 SEND_ _ _ Transmission to data port failed
 RECV_ _ _ Reception from data port failed
 REPLY_ _ = Received reject response from server
 SERVER_ _ = Invalid server response
 CMDSEND_ _ Error in sending command to control port
 CMDRECV_ _ Error in receiving command from control port
 USER_ _ _ _ Invalid user name
 PASS_ _ _ _ Invalid password
 ACCT_ _ _ = Internal processing error
 TIMEOUT_ _ Response timeout
 LINK_ _ _ Ethernet cable not connected
 FILE_ _ _ _ File access failed
 NOFD_ _ _ _ Internal processing error
 NOID_ _ _ _ Internal processing error
 PARAM_ _ = Internal processing error
 CERT_ _ = Certificate verification error
 SSL_ _ _ = Encryption communication error

k Server type (P, S)

fff...f File name (fixed to 51 characters including extension. Unused character positions are filled with spaces.)

2.10.17 SNTP (Time Adjustment) Client Log (FLog)

The output in response to the command "FLog,SNTP" is shown below.

Syntax

```
EA<crLf>
yyyY/mo/dd_hh:mm:ss_nnn_XXXXXXXXXX<crLf>
...
EN<crLf>
```

```
yyyY/mo/dd_hh:mm:ss Time of error occurrence
      YYY Y      Year (1900 to 2099)
      mo         Month (01 to 12)
      dd         Day (01 to 31)
      hh         Hour (00 to 23)
      mm         Minute (00 to 59)
      ss         Second (00 to 59)
```

```
nnn Error code
XXXXXXXXXX Detailed code (fixed to 9 characters)
          SUCCESS _  Success
          EOVER _ _  Adjustment limit exceeded
          EDORMANT _  Internal processing error
          EHOSTNAME _ Host name lookup failed
          ETCPIP _ =  Internal processing error
          ESEND _ _ = Packet transmission failed
          ETIMEDOUT _ Response timeout occurred
          EBROKEN _  Response packet corrupt
          ERECV _ _  Reception error
          EINVALID _ Internal processing error
          ENOID _ _ = Internal processing error
```

2.10.18 E-Mail Client Log (FLog)

The output in response to the command "FLog,MAIL" is shown below.

Syntax

```
EA<crLf>
yyyY/mo/dd_hh:mm:ss_ffffff_eeeeeeeeeeee_n_uuu...u<crLf>
...
EN<crLf>
```

```
yyyY/mo/dd_hh:mm:ss  Time of transmission
                        YYYY          Year (1900 to 2099)
                        mo            Month (01 to 12)
                        dd            Day (01 to 31)
                        hh            Hour (00 to 23)
                        mm            Minute (00 to 59)
                        ss            Second (00 to 59)

ffffff                Cause (fixed to 6 characters)
ALARM_                Alarm mail
TIMER_                Scheduled mail
POWER_                Power-on, power failure recovery
Memory                Low external storage memory
ERROR_                Error notification
REPORT_               Report file
TEST_                 Test mail
PASSWD                User lock out

eeeeeeeeeeee         Detailed error code (fixed to 12 characters)
HOSTADDR_ _ _ _      IP address not set
HOSTNAME_ _ _ _      Unable to resolve server host name
TIMEOUT_ = = =       Communication with server timed out
LINK_ _ _ = = =      Ethernet cable not connected
UNREACH_ _ _ = = =   Unable to connect to server
HELO_ _ _ = = =      Server rejected greeting message
MAILFROM_ _ _ _ _    Server rejected sender
RCPTTO_ _ _ _ _      Server rejected recipient
DATA_ _ _ _ _ _ _    Server rejected the data transmission
                    command
TCPIP_ _ _ _ _ _     Internal processing error
INVAL_ _ _ _ _ _     Internal processing error
SMTPAUTH_ _ _ = =    SMTP AUTH authentication failed
ANOTSUPPORT_ _ _ _   Unsupported authentication method
POP3UNREACH_ _ _ _   Unable to connect to POP3 server
POP3TIMEOUT_ _ _ _   POP3 server connection timed out
POP3HOSTNAME_ _ _ _  Unable to resolve POP3 host name
POP3AUTH_ _ _ _ _    POP3 server authentication failed
CERT_ _ _ = = = =    Certificate verification error
SSL_ _ _ = = = =     Encryption communication error

n                    recipient
1                    Recipient 1
2                    Recipient 2
+                    Recipient 1+2

uuu...u              Recipient mail address (fixed to 30 characters. Unused
                    character positions are filled with spaces.)
                    The user name section of the recipient mail address (the "XXXX"
                    section of "XXXX@abc.def.ghi") is output.
```

2.10.19 Web Log (FLog)

The output in response to the command “FLog,WEB” is shown below.

Syntax

```
EA<crLf>
yyyY/mo/dd_hh:mm:ss_XX.XXX.XXX.XXX_mmmmmmmmm_uuu...u_ccc_nnn...<crLf>
...
EN<crLf>
```

yyyY/mo/dd_hh:mm:ss Time of error occurrence

- yyyY Year (1900 to 2099)
- mo Month (01 to 12)
- dd Day (01 to 31)
- hh Hour (00 to 23)
- mm Minute (00 to 59)
- ss Second (00 to 59)

XXX.XXX.XXX.XXX Source IP address

mmmmmmmm HTTP query method

- GET GET method
- POST POST method

uuu...u Access destination URL (fixed to 24 characters. Unused character positions are filled with spaces.)

ccc HTTP response code (fixed to 32 characters. Unused character positions are filled with spaces. See table below.)

nnn... Error message (see table below)

HTTP Response Code	Error Message
100	Continue
101	Switching Protocols
201	Created
202	Accepted
203	Non-Authoritative Information
204	No Content
205	Reset Content
206	Partial Content
400	Bad Request
401	Unauthorized
403	Forbidden
404	Not Found
405	Method Not Allowed
406	Not Acceptable
407	Proxy Authentication Required
408	Request Time-out
409	Conflict
410	Gone
411	Length Required
412	Precondition Failed
413	Request Entity Too Large
414	Request-URI Too Large
415	Unsupported Media Type
500	Internal Server Error
501	Not Implemented
502	Bad Gateway
503	Server Unavailable
504	Gateway Time-out
505	HTTP Version Not Supported

2.10.20 SLMP Log (FLog)

The output in response to the command "FLog,SLMP" is shown below.

Syntax

```
EA<crLf>
yyyY/mo/dd_hh:mm:ss_XXXXXX_kkk...k_nnn_d<crLf>
...
EN<crLf>
```

```
yyyY/mo/dd_hh:mm:ss Time of command Tx/Rx
                        yyyY      Year (1900 to 2099)
                        mo         Month (01 to 12)
                        dd         Day (01 to 31)
                        hh         Hour (00 to 23)
                        mm         Minute (00 to 59)
                        ss         Second (00 to 59)

XXXXXX Occurred event
        ACTIVE      Communication has been successfully
                   established and normal data has been
                   acquired.
        READY_     Communication has been successfully
                   established but normal data has not
                   been acquired.
        CLOSE_     TCP connection in progress.
        HALT_ _    Communication has failed and has
                   entered a communication recovery wait
                   state
                   _ _ _ _      Other than those above

kkk...k Detail
nnn      Command number (0 to 999)
d        Command type
        R          Read
        W          Write
        O          Immediate write
        N          Others
```

Detail	Group	Meaning
START	Communication status	SLMP was started.
STOP		SLMP was stopped.
DROPOUT		Command could not be processed within the specified interval.
SKIP	Command problem	Command is not specified.
INVALID		Command cannot be executed.
WAITING	Communication problem	Server communication recovery wait
CLOSED		Server connection closed
RESOVING		Server connection is being established (resolving address).
CONNECTING		Server connection is being established (requesting connection).
UNREACH		Server connection failed (peer not found).
TIMEOUT		Server connection failed (timeout occurred).
ERROR		Response problem
BROKEN	Response message is corrupt.	
BAD_HEAD	Response message header error	
BAD_LEN	Response message size error	
BAD_DATA	Response message data error	
ERROR:□□□□	Error response received (4-digit error number displayed in the squares)	
VALID	Data condition	
STALE		Data is old.

2.10.21 Control Alarm Summary (FLog)

The output in response to the command "FLog,CALARM" is shown below.

Syntax

```
EA<crLf>
yyyy/mo/dd_hh:mm:ss.ttt_kkk_cccc_lsssss<crLf>
...
EN<crLf>
```

```
yyyy/mo/dd_hh:mm:ss.ttt Time of control alarm occurrence
                        YYYY      Year (1900 to 2099)
                        mo        Month (01 to 12)
                        dd        Day (01 to 31)
                        hh        Hour (00 to 23)
                        mm        Minute (00 to 59)
                        ss        Second (00 to 59)
                        ttt       Millisecond (000 to 999)
                        A period is inserted between the minute and
                        millisecond.

kkk                    Alarm cause
                        OFF       Alarm release
                        ON_      Alarm occurrence
                        ACK      All channel alarm ACK, individual alarm
                        ACK
                        ALL      All channel alarm OFF

cccc                    Loop number (L001 to L692)
l                       Alarm level (1 to 4)
sssss                  Alarm type
                        PVH_ _   PV high limit
                        PVL_ _   PV low limit
                        SPH_ _   SP high limit
                        SPL_ _   SP low limit
                        DVH_ _   Deviation high limit
                        DVL_ _   Deviation low limit
                        DVO_ _   Deviation H/L limits
                        DVI_ _   Deviation within H/L limits
                        OTH_ _   Control output high limit
                        OTL_ _   Control output low limit
                        PVR_ _   PV velocity
```

If the cause of alarm is "all channel alarm ACK" or "all channel alarm OFF," the loop number, alarm level, and alarm type will be blank.

If the cause of alarm is "individual alarm ACK," the loop number and alarm level will be output.

2.10.22 Control Summary (FLog)

The output in response to the command "FLog,CTRL" is shown below.

Syntax

```
EA<crLf>
yyyy/mo/dd_hh:mm:ss_aaa...a_sss...s<crLf>
...
EN<crLf>
```

```

yyyy/mo/dd_hh:mm:ss      Time of control occurrence
                          yyyy          Year (1900 to 2099)
                          mo           Month (01 to 12)
                          dd           Day (01 to 31)
                          hh           Hour (00 to 23)
                          mm           Minute (00 to 59)
                          ss           Second (00 to 59)

aaa...a                  Name (up to 13 characters)
                          Pattern number_loop number_type
                          Pattern number Up to 2 characters
                          Loop number   Up to 4 characters
                          Type          Up to 5 characters
                          If the maximum number of characters is not used,
                          unused characters become spaces.

sss...s                  Status (up to 12 characters)
```

Name	State	Description
Loop number	LOCAL	Control operation changed to local.
	REMOTE	Control operation changed to remote.
	PROGRAM	Control operation changed to program.
	AUTO	Control operation changed to auto.
	MANUAL	Control operation changed to manual.
	CASCADE	Control operation changed to cascade.
	RUN	Run control operation
	STOP	Stop control operation
	AT**_ON	Auto-tuning start **: PID number (value) or "R"
	AT OFF	Auto-tuning stop
Pattern number	PROG RUN	Program operation run
	PROG RESET	Program operation stop
	HOLD ON	Program operation hold start
	HOLD OFF	Program operation hold release
	WAIT ON	Program operation wait start
	WAIT OFF	Program operation wait release
	ADVANCE	Program operation advance execution
Pattern number_loop number_type	PVE**_ON	PV event occurrence in program operation **: Event number (value)
	PVE**_OFF	PV event release in program operation **: Event number (value)
Pattern number	TME**_ON	Time event occurrence in program operation **: Event number (value)
	TME**_OFF	Time event release in program operation **: Event number (value)

Type	Description
PVH _ _	PV high limit
PVL _ _	PV low limit
SPH _ _	SP high limit
SPL _ _	SP low limit
DVH _ _	Deviation high limit
DVL _ _	Deviation low limit
DVO _ _	Deviation H/L limits
DVI _ _	Deviation within H/L limits
OTH _ _	Control output high limit
OTL _ _	Control output low limit
PVR _ _	PV velocity

2.10.23 Detail Event Log Output (FEventLog) (/AS)

The output in response to the command "FEventLog" is shown below. Output is possible when the advanced security function (/AS) is enabled. Output from Web operation is possible only when the GM's advanced security function (/AS) is enabled.

Syntax

```
EA<crLf>
yyyy/mo/dd_hh:mm:ss_zzz_sss...s_uuu...u_ddd...<crLf>
...
EN<crLf>
```

```
yyyy/mo/dd_hh:mm:ss Time of event occurrence
                        YYYY          Year (1900 to 2099)
                        mo            Month (01 to 12)
                        dd            Day (01 to 31)
                        hh            Hour (00 to 23)
                        mm            Minute (00 to 59)
                        ss            Second (00 to 59)

zzz                    Event cause
                        KEY          Touchscreen operation, key operation
                        REM          Remote
                        COM          Ethernet communication
                        SER          Serial communication (RS-232, RS-
                                422/485, USB communication, or Bluetooth)
                        ACT          Event action
                        SYS          System
                        EXT          Operation from an external device (e.g.
                                Modbus)
                        WEB          Operation from web pages (GM, only when
                                the advanced security function (/AS) is
                                enabled)

sss...s                Event string (fixed to 16 characters. Unused character
                                positions are filled with spaces. See the table below.)

uuu...u                User name (fixed to 20 characters. Unused character
                                positions are filled with spaces.)

ddd...                 Detailed information (see table below)
```

Event string, detailed information

Operations that are marked with an asterisk will be logged regardless of whether the advanced security function is enabled or disabled.

All other operations are logged only when the advanced security function (/AS) is enabled.

Operation	Event string	### information and detailed information
	Information is included in ###	Blue text indicates the detailed information output format.
Error, system notification		
Error occurrence	Error###	### Error number (output in the event string)
Expiration	Expiring##	## Schedule number
		s... Title
		Example: 'Check Data'
Calibration operation		
A/D calibration	ExecA/DCal	Unit:uu,Slot:ss
		uu Unit
		ss Slot
Module calibration	CalModule	Unit:uu,Slot:ss,m**
		uu Unit
		ss Slot
		m Module name
		Example: Unit:00,Slot:01,GX90YA-04-C1

Operation	Event string	### information and detailed information
Login		
Power off*	POWER OFF	—
Power on*	POWER ON	—
Login*	LOGIN	—
Logout*	LOGOUT	—
User lock out	UserLocked	User:UUU UUU User number
Control		
Mode change	ChgMode	ss*** ss*** Mode [Operate, A/Dcal, FirmUpdate]
Time change*	TIME CHANGE	—
New time*	NEW TIME	—
Start time adjustment*	TIME ADJ START	amm:ss:xxx.yyy Difference a Sign (- lag, + lead) mm Minute ss Second xxx Millisecond yyy Microsecond Example: +00:01:000.000
Stop time adjustment*	TIME ADJ END	—
SNTP time change*	SNTP ADJUST	—
DST start*	DST START	—
DST end*	DST END	—
Password change	ChgPasswd	User:UUU UUU User number
User locked ACK	UserLockedACK	—
Alarm ACK	AlarmACK	Channel:cc***,Level:ll***,aa*** cc*** Channel (ALL for all ACK) ll*** Level (ALL for all ACK) aa*** ACK comment
Message writing	Message#####	### Front half: Message number (output in the event string) Normal messages: 001 to 100 Free messages: F01 to F10 Freehand message: Hnd ### Latter half: Batch group number (output in the event string) When multi batch is disabled: (space) Batch group number (when multi batch is enabled): -01 to -12 Example: "Message001" "MessageF01-12" <Detailed information> Data Time:tt*** tt*** Data timestamp (only for add messages. Not output for other messages.) The format is the same as the time section of the FLog command output. Example: Data Time:2012/03/13 10:25:28 When multi batch is disabled: (space) When multi batch is enabled: -01 to -12 Batch group number When multi batch is disabled: (space) When multi batch is enabled:
Recording start	Record Start###	###
Recording stop	Record Stop###	###

Operation	Event string	### information and detailed information
Manual sample	ManualSample	— -01 to -12 Batch group number
Math start	MathStart	—
Math stop	MathStop	—
Math reset	MathRST###	### When multi batch is disabled: (space) When multi batch is enabled: (space) Resetting of all math channels -01 to -12 Resetting of math channels belonging to the specified batch group
Acknowledge math dropout	MathACK	—
Mail start	MailStart	—
Mail stop	MailStop	—
Modbus manual recovery	RefModbus	ss*** Type [Client, Master]
Manually SLMP communication recovery	RefSLMP	—
Display data saved	SaveDisp###	### When multi batch is disabled: (space) When multi batch is enabled: -01 to -12 Batch group number Via event action • During all save, only the batch groups that were saved are recorded in the operation log. • During all save, if there are no batch group that were saved, ### is not added. An operation log entry is recorded, and then an error operation log entry is recorded.
Event data saved	SaveEven###	### When multi batch is disabled: (space) When multi batch is enabled: -01 to -12 Batch group number Via event action • During all save, only the batch groups that were saved are recorded in the operation log. • During all save, if there are no batch group that were saved, ### is not added. An operation log entry is recorded, and then an error operation log entry is recorded.
Manual data saved	ManualSave	ss*** Data type [Data, Report, ManualSample, AlarmSummary]. [All] for all data. [Cancel] if canceled.
Snapshot	Snapshot	—
Set batch number	SetBatchNo###	### When multi batch is disabled: (space) When multi batch is enabled: -01 to -12 Batch group number
Set lot number	SetLotNo###	### When multi batch is disabled: (space) When multi batch is enabled: -01 to -12 Batch group number
Batch text Field setting	SetTextField###	### When multi batch is disabled: (space) When multi batch is enabled: -01 to -12 Batch group number No:nn nn Text field number
Display update rate change	ChgRate	ss*** Trend interval string Example: 1min/div

Operation	Event string	### information and detailed information
Timer reset	TimerRST	Timer:ttt,ttt,ttt... ttt List of timer numbers that were reset (ALL for all timers)
Match time timer reset	MTimerRST	Timer:ttt,ttt,ttt... ttt List of timer numbers that were reset (ALL for all timers)
Communication channel write (screen operation only)	WriteComm	kk...,CCCC=dd... kk... Write type [Internal,External] C Communication channel dd... Value Example: Internal,C001=1.234
DO channel write (for WriteDO manual operation) (screen operation/general communication command only)		CCCC=dd... C DO channel dd... Value [ON, OFF] Example: 0901=OFF
SW channel write (for manual operation) (screen operation/general communication command only)	WriteSW	CCCC=dd... C Internal switch dd... Value [ON, OFF] Example: S001=ON
Settings saved	Save#####	##*# Save type (output in the event string) Report Report Scale Scale image When multi batch is enabled, a hyphen followed by the specified batch group number is added. Example: SaveScale-02 Custom Custom display Parameter Setting parameter Cert Certificate All All settings
		<Detailed information> ---- When ### = Report ---- cc...,rr... cc... Report format [EXCEL, PDF] rr... Report type [Hour, Day, Week, Month, Hour+Day, Day+Week, Day+Month, Batch, Custom]
		---- When ### = Scale ---- Group:gg gg Group number
		---- When ### = Custom ---- No:nn... nn... Display number (ALL for all custom display screen)
Settings loaded	Load#####	##*# Load type (output in the event string) Report Report Scale Scale image When multi batch is enabled, a hyphen followed by the specified batch group number is added. Example: LoadScale-02 Custom Custom display

Operation	Event string	### information and detailed information
		Parameter Setting parameter Cert Certificate All All settings
		<Detailed information> ---- When ### = Report ---- cc•••,rr••• cc••• Report format [EXCEL, PDF] rr••• Report type [Hour, Day, Week, Month, Hour+Day, Day+Week, Day+Month, Batch, Custom]
		---- When ### = Scale ---- Group:gg gg Group number
		---- When ### = Custom ---- No:nn••• nn••• Display number (ALL for all custom display screen)
		---- When ### = Parameter ---- ss••• ss••• Loaded settings [Security, IP, Other, All, w/o-SERVER, w/o-CALIB, w/o-INSTRU] * "w/o-" indicates that the setting is excluded.
Create a key	GeneKey#####	### Action (output in the event string) Start Start Done Complete Cancel Cancel
Installation of certificate	InstallServCert	ss•••,kk••• ss••• Certification type: Main/Middle [Main, Chained] kk••• Purpose: SSL, PDF [COM, PDF] Example: Main,PDF
Certificate creation	CreateCert	—
Touch screen calibration reset	ExecTouchCal	—
Initialize	Initialize	ss••• Initialize type [Security, Other, Data, w/o-IP, w/o-SERVER, w/o-CALIB, w/o-INSTRU] * "w/o-" indicates that the setting is excluded. (List of initialized settings. All for all settings.) Example: Security, Other, Data
Sign in	Sign In	l,ss••• l Level (1 to 3) ss••• File name
Multi batch change	ChgMultiBatch	(s,num)=(b1,b2)->(a1,a2) b1,b2 Before change a1,a2 After change The following settings (those that have been changed among two settings) s On/Off (before and after change) [ON, OFF] num Number of multi batches (before and after change)

Operation	Event string	### information and detailed information
		Example: (s,num)=(OFF,3)->(ON,12) When multi batch settings are loaded, if the settings have not changed, the details are not output.
Lock the keys	Keylock ON	—
Release the key lock	Keylock OFF	—
Turn on the Bluetooth function	Bluetooth ON	—
Turn off the Bluetooth function	Bluetooth OFF	—
Clear the Bluetooth connection list	BTListClear	—
Fixed IP address mode	FixedIPMode	—
Saving of unsaved data	DiffAutoSave	—
AO re-transmission operation	AOTrans	CCCC=d*** c AO channel (for individual channel operation), ALL (for collective channel operation) d Value [ON, OFF] Example: 0901=OFF
AO manual output operation (screen operation only)	AOManual	CCCC=d*** c AO channel d Value [ON, OFF] Example: 0001=1234
Individual initialization	IndivInit	sss*** Initialize type [RecordCh,DisplayGroup...] (List of initialized settings) Example: RecordCh,DisplayGroup
Module		
Reconfiguration	ConfigModule	—
Module disconnection	RemoveModule	Unit:uu,Slot:ss,mm***,ji***,vv*** u Unit s Slot mm*** Module name ji*** Serial number vv*** Version number Example: Unit00,Slot:01,GX90XA-10-U2,0000,1,00.00
Modules installed	AttachModule	Unit:uu,Slot:ss,mm***,ji***,vv*** u Unit s Slot mm*** Module name ji*** Serial number vv*** Version number
Module information	InfoModule	Unit:uu,Slot:ss,dd***,UU*** u Unit s Slot dd*** Calibration date (same format as the log date) UU*** Calibration user Example:

Operation	Event string	### information and detailed information
Module activation	ApplyModule	—
Module update	UpdateModule	Unit:uu,Slot:ss,mm***,ij***,vv*** u Unit s Slot mm*** Module name ij*** Serial number vv*** Version number
Setting changes during recording		
Alarm setting change	SetAlarm	cccc:l:(s,typ,val,hys,l,Otyp,Ono)=(b1,b2,b3,b4,b5,b6,b7)->(a1,a2,a3,a4,a5,a6,a7) c Channel l Level b1,***,b7 Before change a1,***,a7 After change The following settings (those that have been changed among the following seven settings) s On/Off [ON, OFF] typ Type [H,L,R,r,h,l,T,t] val Alarm value hys Hysteresis l Logging [ON, OFF] Otyp Output type [OFF,DO,SW] Ono Output number Example 1: 0001:1:(s,typ,val,hys,l,Otyp,Ono)=(off,TH,off,-2.000,0.0005,DO,0001)->(off,TL,off,-2.000,0.0005,SW,001) Example 2: 0002:2:(val)=(-2.000)->(-1.000)
Alarm delay setting change	SetAlmDelay	cccc:(hour,min,sec)=(b1,b2,b3)->(a1,a2,a3) cccc Channel b1,b2,b3 Before change a1,a2,a3 After change The following settings (those that have been changed among the following three settings) hour Delay hour min Delay minute sec Delay second Example: A100:(hour,min,sec)=(00,00,00)->(01,02,03)
Calibration correction/set point change	SetCCModePnt	cccc:(mode,num)=(b1,b2)->(a1,a2) c Channel b1,b2 Before change a1,a After change The following settings (those that have been changed among the following two settings) mode Mode [OFF, Bias, Appro, Corr] num Number of set points Example: 0001:(mode,num)=(OFF,3)->(Appro,12)
Calibration correction value change	SetCCValue	cccc:pp:(input,output)=(b1,b2)->(a1,a2) c Channel p Set number b1,b2 Before change a1,a2 After change

Operation	Event string	### information and detailed information
		<p>The following settings (those that have been changed among the following two settings)</p> <p>input Calibration correction value output Output calibration value</p> <p>Example: 0001:02:(output)=(1.234)->(2.234) (b1)->(a1)</p> <p>Folder name Example: (DATA0)->(DATA1)</p>
Save directory change	SetDirectory	
Recipient address change	SetRecipient	<p>Recipient:l</p> <p>l Recipient number [1, 2]</p> <p>Example: Recipient:1</p>
Source address change	SetSender	—
Subject change	SetSubject	—
Login change	SetLogin	<p>User:UUU</p> <p>UUU User number</p>
Schedule setting	SetSchedule##	<p>## Schedule number</p> <p>(s,dd,ck,cy,bz,cc,t,1,2)=(b1,b2,b3,b4,b5,b6,b7,b8,b9)->(a1,a2,a3,a4,a5,a6,a7,a8,a9)</p> <p>b1,•••b9 Before change a1,•••a9 After change</p> <p>The following settings (those that have been changed among the following eight settings)</p> <p>s On/Off dd Date [yyyy/mo/dd] ck Notification day [1 to 10] cy Renotification interval [10min, 30min, 1h, 8h] bz Notification buzzer [ON, OFF] cc Load settings [ON, OFF] t Title 1 Notification content 1 2 Notification content 2</p> <p>However, the title before change, notification content 1 before and after change, and notification content 2 before and after change are not output (spaces).</p> <p>Example: 02:(s,ck,t,2)=(OFF,3,,)->(ON,4,'abc',)</p>
Correction coefficient setting	SetCFactor	<p>cccc:pp:(uncorrected, instru,sensor)=(b1,b2,b3)->(a1,a2,a3)</p> <p>c Channel p Correction position b1,b2,b3 Before change a1,a2,a3 After change</p> <p>The following settings (those that have been changed among the following two settings)</p> <p>Uncorrected value (before and after change) Instrument correction coefficient (before and after change) Sensor correction coefficient (before and after change)</p> <p>Example: 0001:02:(sensor)=(1.234)->(2.234)</p>

2.10 ASCII Output Format

Operation	Event string	### information and detailed information
Math variable constant change	ChgMathW	<p>(www)=(b->a)</p> <p>www Constant number b Before change a After change</p> <p>Example: (W001)=(-9.9999999E+29->1E-30)</p>
Calibration correction/set point change (communication channels)	SetComCCMode Pnt	<p>uuu:dd:cccc:sssssssss(mode,num)=(b1,b2)->(a1,a2)</p> <p>u u: 0 d d: 0 c Communication channel number</p> <p>s,***s Serial number: Null b1,b2 Before change a1,a2 After change</p> <p>The following settings (those that have been changed among the following two settings)</p> <p>mode Mode (before and after change) [OFF, Bias, Appro, Corr] num Number of set points (before and after change)</p> <p>Example: 000:00:C001::(mode,num)=(OFF,3)->(Appro,12)</p>
Calibration correction value change (communication channels)	SetCom #####	<p>Action (output in the event string)</p> <p>###: CCValue: Linearizer Approximation/Linearizer Bias</p> <p>uuu:pp:dd:cccc:sssssssss:(input,output)=(b1,b2)->(a1,a2)</p> <p>u u: 0 p Correction position d d: 0 c Communication channel number</p> <p>s,***s Serial number: Null b1,b2 Before change a1,a2 After change</p> <p>The following settings (those that have been changed among the following two settings)</p> <p>input Calibration correction value (before and after change) output Output calibration value (before and after change)</p> <p>Example: 000:02:00:C001::(output)=(1.234)->(2.234)</p>

Operation	Event string	### information and detailed information
Calibration correction value change	SetCom #####	Action (output in the event string) ###: CFactor: Correction coefficient uuu:pp:dd:cccc:sssssssss(uncorrected,instru,sensor)=(b1,b2,b3)->(a1,a2,a3)
Correction coefficient setting (communication channels)		u u: 0 p Correction position d d: 0 c Communication channel number s,***s Serial number: Null b1,b2,b3 Before change a1,a2,a3 After change The following settings (those that have been changed among the following two settings) Uncorrected value (before and after change) Instrument correction coefficient (before and after change) Sensor correction coefficient (before and after change) Example: 000:02:00:C001::(sensor)=(1.234)->(2.234)
Change while recording is stopped		
Setting change	SetParameter	ss***:kk*** ss*** Setting file name kk*** Setting change type [Security,Comm,I/OCh,MathCh,CommCh,Other] (list of changed settings) Example: 000111_131219_095412.GSL:Security,Comm,I/OCh,MathCh,CommCh,Other
Schedule setting	SetSchedule	Same as the setting changes during recording.
Setting difference	SetDiff	ss***:dd*** ss*** Setting file name before setting change dd*** Setting file name after setting change
Setting comment	SetComment	cc*** cc*** Setting comment
Updating		
Other updates	Update###	### Action (output in the event string) Web Web application <Detailed information> vv*** vv... Version number

2.10.24 External Storage Medium and Internal Memory File List (FMedia)

The output in response to the command "FMedia,DIR" is shown below.

Syntax

```
EA<crLf>
yy/mm/dd_hh:mi:ss_lll...l_fff...<crLf>
yy/mm/dd_hh:mi:ss_<DIR>_ddddddd...<crLf>
EN<crLf>
```

yyyy/mo/dd_hh:mm:ss	Time of file generation
	yy Year (1900 to 2099)
	mm Month (01 to 12)
	dd Day (01 to 31)
	hh Hour (00 to 23)
	mi Minute (00 to 59)
	ss Second (00 to 59)
lll...l	File size (fixed to 10 characters. Unused character positions are filled with spaces.)
	For directories, <DIR> is output.
fff...	File name

2.10.25 External Storage Medium Free Space (FMedia)

The output in response to the command "FMedia,CHKDSK" is shown below.

Syntax

```
EA<crLf>
zzzzzzz_Kbytes_free<crLf>
EN<crLf>
```

zzzzzzz	Free space (KB)
---------	-----------------

2.10.26 Setting Data (FCnf)

The output in response to the command "FCnf" is shown below.

Syntax

```
EA<crLf>
<Response to a setting query>
EN<crLf>
```

The setting data is output in the format of the response to a setting query.

2.10.27 Decimal Place and Unit Information (FChInfo)

The output in response to the command "FChInfo" is shown below.

Syntax

```
EA<crLf>
s_cccc_uuuuuuuuuu,pp<crLf>
s_cccc_uuuuuuuuuu,pp<crLf>
s_cccc_uuuuuuuuuu,pp<crLf>
EN<crLf>
```

s	Data status
	N Normal
	D Differential input
	S Skip
cccc	Channel number (I/O channel, math channel, communication channel)
uuuuuuuuuu	Unit information (fixed to 10 characters. Unused character positions are filled with spaces.)
pp	Decimal place (00 to 05)
	The decimal place of the mantissa on channels set to LOG scale (/LG)

2.10.28 System Configuration (FSysConf)

The output in response to the command "FSysConf" is shown below.

Syntax

When no expandable I/O is connected

```
EA<crLf>
Unit:00
00:cccccccccccccccc_uuuuuuuuuuuuuuuu_defghijklmnopqrs<crLf>
01:cccccccccccccccc_uuuuuuuuuuuuuuuu_defghijklmnopqrs<crLf>
02:cccccccccccccccc_uuuuuuuuuuuuuuuu_defghijklmnopqrs<crLf>
03:cccccccccccccccc_uuuuuuuuuuuuuuuu_defghijklmnopqrs<crLf>
04:cccccccccccccccc_uuuuuuuuuuuuuuuu_defghijklmnopqrs<crLf>
05:cccccccccccccccc_uuuuuuuuuuuuuuuu_defghijklmnopqrs<crLf>
06:cccccccccccccccc_uuuuuuuuuuuuuuuu_defghijklmnopqrs<crLf>
07:cccccccccccccccc_uuuuuuuuuuuuuuuu_defghijklmnopqrs<crLf>
08:cccccccccccccccc_uuuuuuuuuuuuuuuu_defghijklmnopqrs<crLf>
09:cccccccccccccccc_uuuuuuuuuuuuuuuu_defghijklmnopqrs<crLf>
EN<crLf>
```

When an expandable I/O or sub unit is connected

```
EA<crLf>
U00f:cccccccccccccccc_uuuuuuuuuuuuuuuu_DEFGHIJKLMNOPQRS<crLf>
U01f:cccccccccccccccc_uuuuuuuuuuuuuuuu_DEFGHIJKLMNOPQRS<crLf>
U02f:cccccccccccccccc_uuuuuuuuuuuuuuuu_DEFGHIJKLMNOPQRS<crLf>
U03f:cccccccccccccccc_uuuuuuuuuuuuuuuu_DEFGHIJKLMNOPQRS<crLf>
U04f:cccccccccccccccc_uuuuuuuuuuuuuuuu_DEFGHIJKLMNOPQRS<crLf>
U05f:cccccccccccccccc_uuuuuuuuuuuuuuuu_DEFGHIJKLMNOPQRS<crLf>
U06f:cccccccccccccccc_uuuuuuuuuuuuuuuu_DEFGHIJKLMNOPQRS<crLf>
Unit:nn
00:cccccccccccccccc_uuuuuuuuuuuuuuuu_defghijklmnopqrs<crLf>
01:cccccccccccccccc_uuuuuuuuuuuuuuuu_defghijklmnopqrs<crLf>
02:cccccccccccccccc_uuuuuuuuuuuuuuuu_defghijklmnopqrs<crLf>
03:cccccccccccccccc_uuuuuuuuuuuuuuuu_defghijklmnopqrs<crLf>
04:cccccccccccccccc_uuuuuuuuuuuuuuuu_defghijklmnopqrs<crLf>
05:cccccccccccccccc_uuuuuuuuuuuuuuuu_defghijklmnopqrs<crLf>
06:cccccccccccccccc_uuuuuuuuuuuuuuuu_defghijklmnopqrs<crLf>
07:cccccccccccccccc_uuuuuuuuuuuuuuuu_defghijklmnopqrs<crLf>
08:cccccccccccccccc_uuuuuuuuuuuuuuuu_defghijklmnopqrs<crLf>
09:cccccccccccccccc_uuuuuuuuuuuuuuuu_defghijklmnopqrs<crLf>
Unit:nn
00:cccccccccccccccc_uuuuuuuuuuuuuuuu_defghijklmnopqrs<crLf>
01:cccccccccccccccc_uuuuuuuuuuuuuuuu_defghijklmnopqrs<crLf>
02:cccccccccccccccc_uuuuuuuuuuuuuuuu_defghijklmnopqrs<crLf>
03:cccccccccccccccc_uuuuuuuuuuuuuuuu_defghijklmnopqrs<crLf>
04:cccccccccccccccc_uuuuuuuuuuuuuuuu_defghijklmnopqrs<crLf>
05:cccccccccccccccc_uuuuuuuuuuuuuuuu_defghijklmnopqrs<crLf>
06:cccccccccccccccc_uuuuuuuuuuuuuuuu_defghijklmnopqrs<crLf>
07:cccccccccccccccc_uuuuuuuuuuuuuuuu_defghijklmnopqrs<crLf>
08:cccccccccccccccc_uuuuuuuuuuuuuuuu_defghijklmnopqrs<crLf>
09:cccccccccccccccc_uuuuuuuuuuuuuuuu_defghijklmnopqrs<crLf>
:
Unit:nn
00:cccccccccccccccc_uuuuuuuuuuuuuuuu_defghijklmnopqrs<crLf>
01:cccccccccccccccc_uuuuuuuuuuuuuuuu_defghijklmnopqrs<crLf>
02:cccccccccccccccc_uuuuuuuuuuuuuuuu_defghijklmnopqrs<crLf>
03:cccccccccccccccc_uuuuuuuuuuuuuuuu_defghijklmnopqrs<crLf>
04:cccccccccccccccc_uuuuuuuuuuuuuuuu_defghijklmnopqrs<crLf>
05:cccccccccccccccc_uuuuuuuuuuuuuuuu_defghijklmnopqrs<crLf>
06:cccccccccccccccc_uuuuuuuuuuuuuuuu_defghijklmnopqrs<crLf>
07:cccccccccccccccc_uuuuuuuuuuuuuuuu_defghijklmnopqrs<crLf>
08:cccccccccccccccc_uuuuuuuuuuuuuuuu_defghijklmnopqrs<crLf>
09:cccccccccccccccc_uuuuuuuuuuuuuuuu_defghijklmnopqrs<crLf>
EN<crLf>
```

Output example when an expandable I/O or sub unit is connected

- The unit information area (e.g. U00) will contain the expansion module name. All seven units are output regardless of whether expansion modules are available.
- The module information area (after Unit) will contain I/O module names. Only the units that have modules installed will be output.

```
EA
U00*:GX20-1J          GX20-1J          -----
U01 :GX90EX-02-TP1   GX90EX-02-TP1   -----
U02 :-----         -----
U03 :-----         -----
U04 :-----         -----
U05 :-----         -----
U06 :-----         -----
Unit:00
00:GX90XA-10-U2      GX90XA-10-U2      -----
01:GX90XA-10-U2      GX90XA-10-U2      -----
02:-----         -----
03:-----         -----
04:-----         -----
05:-----         -----
06:-----         -----
07:-----         -----
08:-----         -----
09:-----         -----
Unit:01
00:GX90XA-10-U2      GX90XA-10-U2      -----
01:-----         -----
02:-----         -----
03:-----         -----
04:-----         -----
05:-----         -----
06:-----         -----
07:-----         -----
08:-----         -----
09:-----         -----
EN
```

```
cccccccccccccccccc  Module models that are actually installed
                      -----  Module not installed (16 hyphens)
                      Displays the module model code.
uuuuuuuuuuuuuuuuuu  Module models recognized by the GX
                      -----  Module not installed (16 hyphens)
                      Displays the module model code.
defghijklmnopqrs    Module status
- Normal
x Error
d to s express the following items.
d   System data error
e   Calibration value error
f   Parameter error
g   Reserved (-)
h   FRAM error
i   Reserved (-)
j   Reserved (-)
k   Reserved (-)
l   A/D error
m   RJC error
n   Reserved (-)
o   Reserved (-)
p   Reserved (-)
q   Reserved (-)
r   Reserved (-)
s   Reserved (-)

nn                    Unit number
f                     * GX/GP or GM main unit
```

DEFGHIJKLMNOPQRS

(Space) Expandable I/O or sub unit
Expansion module status
D to S express the following items.
D System data error (-: normal, X: error)
E Ethernet error (-: normal, X: error)
F to S Reserved (-)

2.10.29 Bluetooth Device Information (FBTDevInfo)

The output in response to the command "FBTDevInfo" is shown below.

Syntax

```
EA<crLf>  
(BD address),(module information)<crLf>  
EN<crLf>
```

(BD address) Format: xx:xx:xx:xx:xx:xx
(module information) xxxx (user-defined character string)

Before the Bluetooth function is turned on after power-on, the xx of the BD address area will be spaces, and the module information area will be empty (no characters).

Output Example

When p1 is omitted

```
EA<crLf>  
B4:17:D3:AC:07:AA,Init R02.01.1(build 000)<crLf>  
EN<crLf>
```

2.10.30 Reminder Information Output (FReminder)

The output in response to the command "FReminder" is shown below.

Syntax

```
EA<crLf>
nn ssssss yyy/mo/dd_YY/MO/DD_e...<crLf>
EN<crLf>
```

nn		Schedule number (01 to 12)
ssssss		Status
	None	No registration
	Normal	Before notification
	Notice	Notifying
	Expire	After expiration
yyy/mo/dd		Previous set date
YY/MO/DD		Expiration date
e...		

If the status is None, the subsequent information is not output.

Output Example

```
EA
01_None
02_Normal_2015/02/28_2015/03/30_30
03_Notice_2015/02/25_2015/02/28_3
04_Expire_2015/02/20_2015/02/13_-7
05_Normal_2015/02/28_2015/03/30_30
06_Normal_2015/02/28_2015/03/30_30
07_Normal_2015/02/28_2015/03/30_30
08_None
09_None
10_None
11_None
12_None
EN
```

2.10.31 Outputs the Most Recent Control Data (FCtrlData)

The output in response to the command "FCtrlData" is shown below. Outputs the most recent control data per loop.

Syntax

```
EA<crLf>
DATE_YY/mo/dd<crLf>
TIME_hh:mm:ss.mmmt<crLf>
llll,S_fdddddE-pp,S_fdddddE-pp,S_fdddddE-pp,aaaa1aaaa2aaaa3aaaa4<crLf>
EN<crLf>
```

yy/mo/dd	Data time (year, month, day)
	YY Year (00 to 99)
	mo Month (01 to 12)
	dd Day (01 to 31)
hh:mm:ss.mmmt	Data time (hour, minute, second, millisecond)
	hh Hour (00 to 23)
	mm Minute (00 to 59)
	ss Second (00 to 59)
	mmm Millisecond (000 to 999)
	A period is inserted between the minute and millisecond.
t	Reserved (space)
llll	Loop number
s	Data status
	N Normal
	S Skip
	O Over
	E Errors
	B Burnout
	F No data
	M Luck of data/Module not installed
f	Sign (+ or -)
ddddddd	Mantissa (00000000 to 99999999; 8 digits)
	If the data status is O (\pm over) or B (burnout), the mantissa will be the value of -5% to 105% of the range.
	If the data status is E, the mantissa is 99999999.
pp	Exponent (00 to 04)
aaaa1aaaa2aaaa3aaaa4	Alarm Status
	aaaa1 Alarm status 1
	aaaa2 Alarm status 2
	aaaa3 Alarm status 3
	aaaa4 Alarm status 4
	aaaa1, aaaa2, aaaa3, or aaaa4 is set to one of the following:
	PVH PV high limit
	PVL PV low limit
	SPH SP high limit
	SPL SP low limit
	DVH Deviation high limit
	DVL Deviation low limit
	DVO Deviation H/L limits
	DVI Deviation within H/L limits
	OTH Control output high limit
	OTL Control output low limit
	PVR PV velocity
	If an alarm has not occurred, the alarm status is set to space.
S_fdddddE-pp	is in order of PV, SP, and OUT.
	The data time outputted is not the time of a control period but the data acquisition time by a communication command.

2.10.32 SP Number and PID Number Output (FCtrlNo.)

The output in response to the command "FCtrlNo" is shown below.

Syntax

```
EA<crLf>
LOOP,l111<crLf>
SPNO,x<crLf>
PIDNO,y<crLf>
EN<crLf>
```

l111	Loop number (L001 to L692)
x	SP number (1 to 8)
y	PID number (1 to 8, R)

Output Example

```
FCtrlNo,L001
EA
LOOP,L001<crLf>
SPNO,1<crLf>
PIDNO,2<crLf>
EN
```

2.10.33 Control Mode Output (FCtrlMode)

The output in response to the command "FCtrlMode" is shown below.

Syntax

```
EA<crLf>
l111,xxx.xxx.xxx.xxx<crLf>
EN<crLf>
```

```
l111 Loop number (L001 to L692)
xxx  The states of bits 31 to 24, 23 to 16, 15 to 8, and 7 to 0 are indicated in order using
      decimal notation.
      Bit 0
          0 RUN
          1 STOP
      Bit 1
          0 LOCAL
          1 REMOTE
      Bit 2
      Bit 3
          0 AUTO
          1 MANUAL
          2 CASCADE
      Bit 4
          0 Auto-tuning off
          1 Auto-tuning on
      Bits 5 to 7
          Not used
      Bit 8
          0 AI1 not used
          1 AI1 used
      Bit 9
          0 AI2 not used
          1 AI2 used
      Bit 10
          0 EXPV1 not used
          1 EXPV1 used
      Bit 11
          0 EXPV2 not used
          1 EXPV2 used
      Bits 12 to 28
          Not used
      Bits 29 and 30
          0 PROG
          1 RESET
          2 LOCAL
      Bit 31
          0 Program operation not available
          1 Program operation available
```

Output Example

When program operation is in progress, auto-tuning is in progress, cascade operation is in progress, and when in PROG, REMOTE, and RUN states

```
EA<crLf>
L001,128.000.000.026<crLf>
EN<crLf>
```

2.10.34 Program Operation Mode Output (FPrgMode)

The output in response to the command "FPrgMode" is shown below.

Syntax

```
EA<crLf>
pp,xxx.xxx.xxx.xxx<crLf>
EN<crLf>
```

PP	Program pattern number (1 to 99)
xxx	The states of bits 31 to 24, 23 to 16, 15 to 8, and 7 to 0 are indicated in order using decimal notation.
Bit 0	0 Program stopped 1 Program running
Bit 1	0 Not holding 1 Holding
Bit 2	0 Not waiting 1 Waiting
Bits 3 to 31	Not used

Output Example

When not waiting, not holding, and program is running

```
EA<crLf>
01,000.000.000.001<crLf>
EN<crLf>
```

2.10.35 Program Pattern Information Output (FPrgPtnInfo)

The output in response to the command "FPrgPtnInfo" is shown below.

Syntax

```
EA<crLf>
PTNNO,a<crLf>
SEGNO,b<crLf>
SEGUSE,c<crLf>
SEGTM, hh:mm:ss<crLf>
WAITTM, hh:mm:ss<crLf>
RPT-MODE,d<crLf>
RPT-CNT,e<crLf>
RPT-REM,f<crLf>
RPT-START,g<crLf>
RPT-END,h<crLf>
STARTTM, yy/mo/dd hh:mm:ss<crLf>
ENDTM, yy/mo/dd hh:mm:ss<crLf>
EN<crLf>
```

PTNNO	Running pattern number a (1 to 99)
SEGNO	Running segment number b (1 to 99)
SEGUSE	Number of segments c of the currently selected pattern (1 to 99)
SEGTM	Remaining segment time
	hh Hours (00 to 99)
	mm Minutes (00 to 59)
	ss Seconds (00 to 59)
WAITTM	Elapsed time of waiting
	hh Hours (00 to 99)
	mm Minutes (00 to 59)
	ss Seconds (00 to 59)
RPT-MODE	Repeat setting d of the running pattern
	0 ON
	1 OFF
	2 Repeat indefinitely
RPT-CNT	Repeat count e of the running pattern (0 to 999)
RPT-REM	Remaining repeat count f of the running pattern (0 to 999)
RPT-START	Start segment number g of repeat operation (1 to 99)
RPT-END	End segment number h of repeat operation (1 to 99)
STARTTM	Program operation start time
	yy Year (00 to 99)
	mo Month (01 to 12)
	dd Day (01 to 31)
	hh Hour (00 to 99)
	mm Minute (00 to 59)
	ss Second (00 to 59)
ENDTM	Program operation stop time
	yy Year (00 to 99)
	mo Month (01 to 12)
	dd Day (01 to 31)
	hh Hour (00 to 99)
	mm Minute (00 to 59)
	ss Second (00 to 59)

Output Example

```
EA<crLf>
PTNNO, 5
SEGNO, 10
SEGUSE, 7
SEGTM, 11:05:22
WAITTM, 00:06:00
RPT-MODE, 1
RPT-CNT, 20
RPT-REM, 2
RPT-START, 3
RPT-END, 6
STARTTM, 17/05/03 10:00:00
ENDTM, 17/05/05 10:00:00
EN<crLf>
```

2.10.36 PV event and time event information output (FPrgEvent)

The output in response to the command "FPrgEvent" is shown below.

Syntax

```
EA<crLf>
pp, xxx.xxx.xxx.xxx<crLf>
pp, yyy.yyy.yyy.yyy<crLf>
EN<crLf>
```

pp	Program pattern number (1 to 99)
xxx	The states of bits 31 to 24, 23 to 16, 15 to 8, and 7 to 0 are indicated in order using decimal notation.
	Bit 0
	. 0 PV event 1 off
	. 1 PV event 1 on
	.
	Bit 31
	. 0 PV event 32 off
	. 1 PV event 32 on
yyy	The states of bits 31 to 24, 23 to 16, 15 to 8, and 7 to 0 are indicated in order using decimal notation.
	Bit 0
	. 0 Time event 1 off
	. 1 Time event 1 on
	.
	Bit 31
	. 0 Time event 32 off
	. 1 Time event 32 on

Output Example

```
FPrgEvent, 1
When PV event 1 and time events 2 and 3 are occurring
EA<crLf>
01,000.000.000.001<crLf>
01,000.000.000.006<crLf>
EN<crLf>
```

2.10.37 Program control end signal status output (FPrgEnd)

The output in response to the command "FPrgEnd" is shown below.

Syntax

```
EA<crLf>
pp,x<crLf>
EN<crLf>
```

pp	Program pattern number (1 to 99)
x	Program control end signal status
	0 5-second program control end signal is off
	1 5-second program control end signal is on

Output Example

```
FPrgEnd,1
When the 5-second program control end signal is on
EA<crLf>
01,1<crLf>
EN<crLf>
```

2.10.38 Currently Running Program Pattern Number and Status Output (FPrgPtnCur)

The output in response to the command "FPrgPtnCur" is shown below.

Syntax

```
EA<crLf>
pp,xxx.xxx.xxx.xxx<crLf>
oo,cccc
...
oo,ccc
EN<crLf>
```

pp	Program pattern number (1 to 99)
xxx	The states of bits 31 to 24, 23 to 16, 15 to 8, and 7 to 0 are indicated in order using decimal notation.
	Bit 0
	0 Program stopped
	1 Program running
	Bit 1
	0 Not holding
	1 Holding
	Bit 2
	0 Not waiting
	1 Waiting
	Bits 3 to 31
	Not used
oo	Number (1 to 20)
cccc	Loop number (L001 to L692)

Output Example

```
Program pattern 1, not holding, not waiting, program running, loop1 and loop2 assignment
EA<crLf>
01,000.000.000.001<crLf>
01,L001
02,L011
EN<crLf>
```

2.10.39 Instrument Manufacturer (_MFG)

The output in response to the command “_MFG” is shown below. Outputs the instrument manufacturer.

Output Example

```
EA<crLf>
YOKOGAWA<crLf>
EN<crLf>
```

2.10.40 Instrument's Product Name (_INF)

The output in response to the command “_INF” is shown below.

Output Example

```
EA<crLf>
'GX20/GP20',123456789,xx-xx-xx-xx-xx-xx,Rx.xx.xx <crLf>
EN<crLf>
```

'GX20/GP20'	Product name ('GX20/GP20', 'GX10/GP10', or 'GM10')
123456789	Product serial number
xx-xx-xx-xx-xx-xx	MAC address (xx's are hexadecimals)
Rx.xx.xx	Firmware version

2.10.41 Instrument's Basic Specifications (_COD)

The output in response to the command “_COD” is shown below.

Output Example

```
EA<crLf>
'GX20',-1,J,1,M <crLf>
EN<crLf>
```

`GX20`	Model
-1	Type -1 100 channels -2 500 channels
J	Display language J Japanese E English C Chinese
1	Supply voltage Blank (when the product name is GX10, GX20, or GM10) 1 100 VAC, 240 VAC (when the product name is GP10 or GP20)
M	Power cord Blank (when the product name is GX10, GX20, or GM10) M PSE cable D UL/CSA cable F VDE cable R AS cable Q BS cable H GB cable N NBR cable

2.10.42 Instrument's Firmware Version Information (_VER)

The output in response to the command “_VER” is shown below.

Output Example

```
EA<crLf>
B999999,Rx.xx.xx, 'Main Program'<crLf>
B999999,Rx.xx.xx, 'Web Program'<crLf>
EN<crLf>
```

B999999	Firmware part number (first line), Web program part number (second line)
Rx.xx.xx	Firmware version (first line), Web program version (second line)

2.10.43 Instrument's Option Installation Information (_OPT)

The output in response to the command “_OPT” is shown below.

Output Example

```
EA<crLf>
/C2, 'RS-232'<crLf>
/C3, 'RS-422/485'<crLf>
/C8, 'Bluetooth'<crLf>
/D5, 'VGA output'<crLf>
/FL, 'Fail output (1 point) ' <crLf>
/MT, 'Mathematical function (with report function) ' <crLf>
/MC, 'Communication channel function'<crLf>
/P1, '24 VDC/AC power supply'<crLf>
/UH, 'USB interface (Host 2 ports) ' <crLf>
/AS, 'Advanced security functions'<crLf>
/BT, 'Multi-batch function'<crLf>
/AH, 'Aerospace heat treatment'<crLf>
/E1, 'EtherNet/IP communication'<crLf>
/E2, 'WT connect functions'<crLf>
/E3, 'OPC-UA server'<crLf>
/E4, 'SLMP communication'<crLf>
/CG, 'Custom display functions'<crLf>
/LG, 'Log scale functions'<crLf>
/PG, 'Program pattern'<crLf>
/U__0, 'Model pre-installed with analog (universal) input
module(s) ' <crLf>
/CR__, 'Model pre-installed with digital output module(s) and/or
digital input module(s) ' <crLf>
EN<crLf>
```

/C2	RS-232
/C3	RS-422/485
/C8	Bluetooth
/D5	VGA output
/FL	Fail output, 1 point
/MT	Math (including the report function)
/MC	Communication channel function
/P1	24VDC/AC power supply
/UH	USB interface (host 2 ports)
/AS	Advanced security function (Part 11 compliant)
/BT	Multi batch function
/AH	Aerospace heat treatment
/E1	EtherNet/IP communication
/E2	WT communication
/E3	OPC-UA server
/E4	SLMP communication
/CG	Custom display function
/LG	Log scale
/PG	Program control
/UX ₁ X ₂ 0	Model pre-installed with analog (universal) input modules
	X ₁ Terminal type
	S Screw terminal
	C Clamp terminal
	X ₂ Number of analog (universal) input modules installed
	1, 2, 3, 4, 5, 6, 7, 8, 9, A (where A represents 10)
/CRY ₁ Y ₂	Model pre-installed with digital output modules and/or digital input modules
	Y ₁ Number of digital output (C contact) modules installed
	1,2,3,4,5
	Y ₂ Number of digital input modules installed
	1,2

2.10.44 Instrument's Temperature Unit and Daylight Saving Time Installation Information (_TYP)

The output in response to the command "_TYP" is shown below.

Output Example

```
EA<crLf>
DST,'Summer time/Winter time'<crLf>
DEGF,'degF'<crLf>
EN<crLf>
```

DST	Daylight saving time enabled
DEGF	Fahrenheit temperature unit enabled

2.10.45 Instrument's Error Number Information (_ERR)

The output in response to the command "_ERR" is shown below.

Output Example

```
EA<crLf>
10:1:2,'Dram Error'<crLf>
500:2:5,'Media Error'<crLf>
EN<crLf>
```

2.10.46 Instrument's Unit Configuration Information (_UNS or _UNR)

The output in response to the command “_UNS” or “_UNR” is shown below.

Syntax

```
EA<crLf>
p1,p2,p3,p4,p5,p6,p7,p8,p9,p10<crLf>
p1,p2,p3,p4,p5,p6,p7,p8,p9,p10<crLf>
...
EN<crLf>
```

Output Example

```
EA<crLf>
Main,0,'GX20-1J',1234567,xx-xx-xx-xx-xx-xx,R1.01.01,/MT /C2,0,10,--
-----<crLf>
Sub,1,'GX90EX-02-ET1',1234567,xx-xx-xx-xx-xx-xx,R1.01.01,,0,6,-----
-----<crLf>
EN<crLf>
```

One line (p1 to p10) contains configuration information of a single unit.

p _n	Value	Description
p1	Main, Sub	Unit dependency (main or sub) information. Main: Main unit (Only a single one exists in a system. GX/GP or GM main unit) Sub: Sub unit (Units other than the main unit. GX/GP expandable I/O or GM sub unit)
p2	0,1	Unit address number. The address number of the main unit is 0.
p3	'GX20-1J', 'GX90EX-02- ET1'	Unit name (model name). Enclosed in single quotation marks. The main unit model or expansion module model in the expandable I/O unit or sub unit
p4	1234567	Product serial number.
p5	xx-xx-xx- xx-xx-xx	MAC address. xx = hexadecimal
p6	R1.01.01	Firmware version. The output format is “R+version.”
p7	/MT /C2	Options. Codes of installed options delimited by spaces.
p8	0	Fixed at 0.
p9	6, 10	Maximum number of installable modules. If there are not installable modules, 0 is output.
p10	----- -----	Unit status. The unit status is output in a character string. See the Expansion module status in section 2.10.24, “System Configuration (FSysConf).”

The main unit and expansion module information is output (indicated in green below).

Without an expandable I/O or sub unit

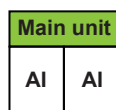

With an expandable I/O or sub unit

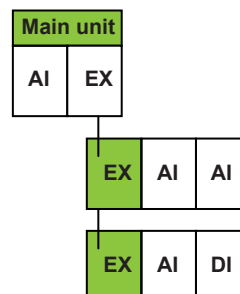

EX: Expansion module
AI, DI, etc.: I/O module

2.10.47 Instrument's Module Configuration Information (_MDS or MDR)

The output in response to the command “_MDS” or “_MDR” is shown below.

Syntax

```
EA<crLf>
p1,p2,p3,p4,p5,p6,p7,p8,p9,p10,p11<crLf>
p1,p2,p3,p4,p5,p6,p7,p8,p9,p10,p11<crLf>
...
EN<crLf>
```

Output Example

```
EA<crLf>
Main,0,1,'GX90YD-06-11',1234567,R1.01.01,,0,0,6,-----
<crLf>
Main,0,9,'GX90EX-02-ET1',1234567,R1.01.01,,0,0,0,-----
<crLf>
Sub,1,0,'GX90XA-10-U2',1234567,R1.01.01,,0,10,0,-----
<crLf>
Sub,1,1,'GX90XA-10-U2',1234567,R1.01.01,,0,10,0,-----
<crLf>
Sub,1,2,'GX90XA-10-U2',1234567,R1.02.01,,0,10,0,-----
<crLf>
Sub,2,0,'GX90XA-10-U2',1234567,R1.02.01,,0,10,0,-----
<crLf>
Sub,2,1,'GX90XD-16-11',1234567,R1.01.01,,0,16,0,-----
<crLf>
EN<crLf>
```

One line (p1 to p11) contains configuration information of a single module.

p _n	Value	Description
p1	Main, Sub	Unit dependency (main or sub) information. Main: Main unit (Only a single one exists in a system. GX/GP or GM main unit) Sub: Sub unit (Units other than the main unit. GX/GP expandable I/O or GM sub unit)
p2	0, 1, 2	Address number of the unit that the module is installed in. Fixed at 0.
p3	0, 1, 2	Slot number of the unit that the module is installed in (0 reference).
p4	'GX90YD-06-11', 'GX90EX-02-ET1', 'GX90XA-10-U2', 'GX90XD-16-11'	Module name (model name). Enclosed in single quotation marks. <ul style="list-style-type: none"> All modules installed in the main unit A module installed in an expandable I/O or sub unit (excluding the expansion module)
p5	1234567	Product serial number.
p6	R1.01.01, R1.02.01	Module firmware version. The output format is “R+version.”
p7	Space	Options. Codes of installed options delimited by spaces.
p8	0	Fixed at 0.
p9	0, 10, 8	Maximum number of input channels allowed on the module. If there are no inputs, 0 is output.
p10	0, 16	Maximum number of output channels allowed on the module. If there are no outputs, 0 is output.
p11	-----	Module status. The Module status is output in a character string.

The I/O module information is output (indicated in green below).

Without an expandable I/O or sub unit **With an expandable I/O or sub unit**

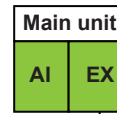
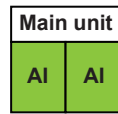

EX: Expansion module
 AI, DI, etc.: I/O module

2.11 Format of the Data Block of Binary Output

This section explains the data that is stored in the data block in the binary output of data output response. For the entire structure of the binary output format, see [“Binary Output” on page 2-119](#).

2.11.1 Most Recent Channel Data (FData)

The output in response to the command “FData,1” is shown below. Outputs the most recent I/O channel, math channel, and communication channel data.

Configuration

The figure below shows the structure of the output data. Data is stored in “Block 1.”

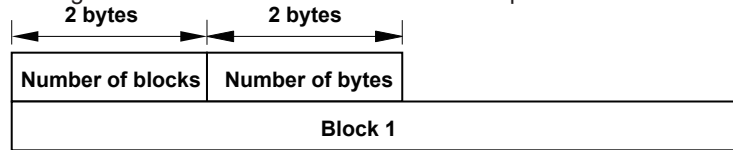

Number of Blocks (16 bits)

Always 1.

Number of Bytes (16 bits)

Stores the number of bytes of block 1.

Block 1

The figure below shows the structure of block 1.

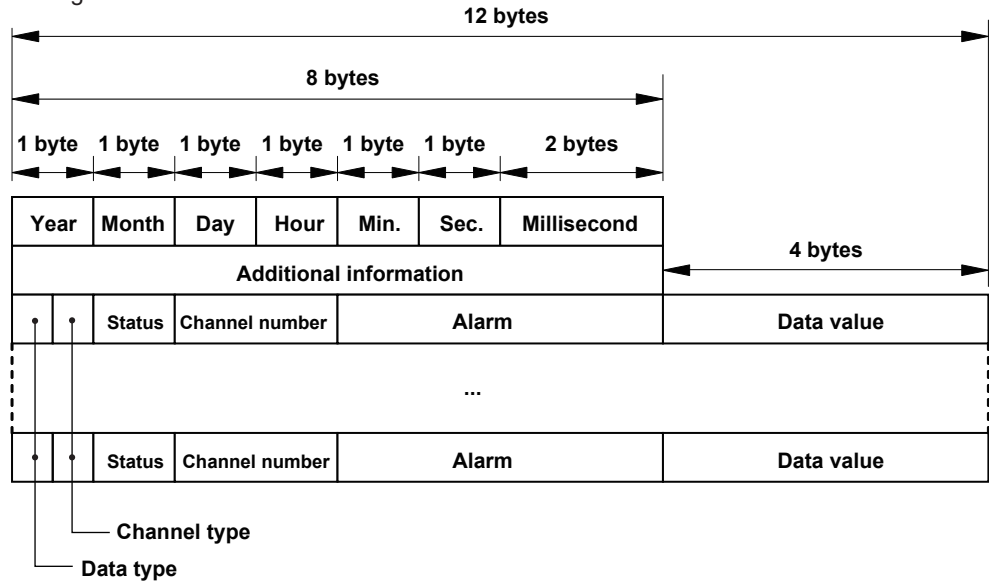

Data Time

Item (Number of Bits)	Value
Year (8 bits)	0 to 99
Month (8 bits)	1 to 12
Day (8 bits)	1 to 31
Hour (8 bits)	0 to 23
Minute (8 bits)	0 to 59
Second (8 bits)	0 to 59
Millisecond (16 bits)	0 to 999

Additional Information (64 bits)

Bit 0: Daylight saving time (0: standard time; 1: daylight saving time)

Data Type (4 bits)

Indicates the data type. (1: 32 bit signed integer (big endian); 2: 32 bit floating point)
 Data values for channels set to Log scale (/LG) are 32-bit floating-point type.
 The alarm statuses of control alarms (when a PID control module is installed) are all set to zero.

Channel Type (4 bits)

Indicates the channel type.

Value	Channel Type
1	I/O channel
2	Math channel
3	Communication channel

Status (8 bits)

Indicates the channel status.

Bit	Value	Channel Status
0 to 4	0	No error
	1	Skip
	2	+Over
	3	-OVER
	4	+Burnout
	5	-Burnout
	6	A/D error
	7	Invalid data
5	16	Math result is NaN.
	17	Communication error
5	0	No A/D calibration value error
	1	A/D calibration value error
6	0	No RJC error
	1	RJC error
7	0	Reserved

Channel Number (16 bits)

Indicates the channel number. Stored in the following manner depending on the channel type.

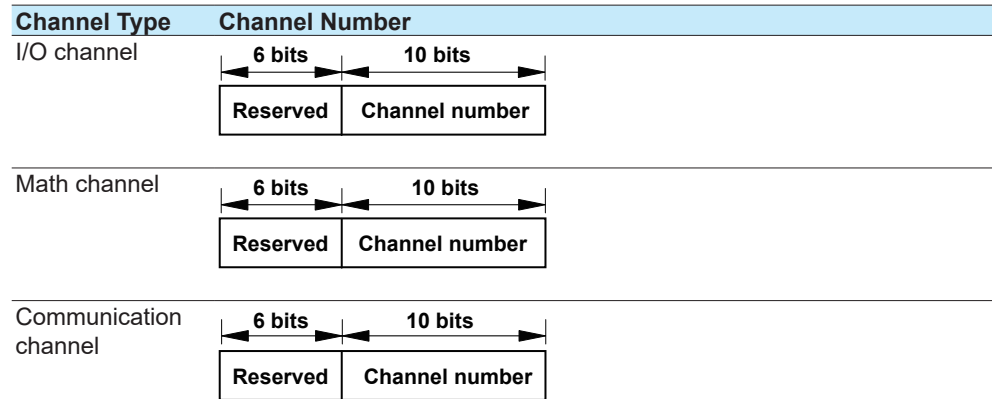

Alarm (32 bits)

Indicates the alarm status.

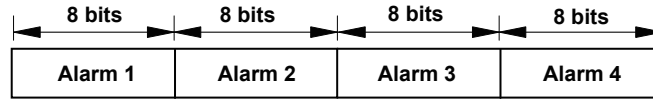

The eight bit values of alarm 1 to alarm 4 are described in the table below.

Bit	Value	Description
0 to 5	0	No alarm
	1	High limit alarm
	2	Low limit alarm
	3	Difference high limit alarm
	4	Difference low limit alarm
	5	High limit on rate-of-change alarm
	6	Low limit on rate-of-change alarm
	7	Delay high limit alarm
6	8	Delay low limit alarm
	0	No alarm is activated.
7	1	An alarm is activated.
	0	Alarm nonhold state
	1	Alarm hold state

2.11.2 Channel FIFO Data (FFifoCur)

The output in response to the command "FFifoCur,0" is shown below. Outputs the I/O channel, math channel, and communication channel FIFO data.

Configuration

Data is stored in "Block 1" shown below.

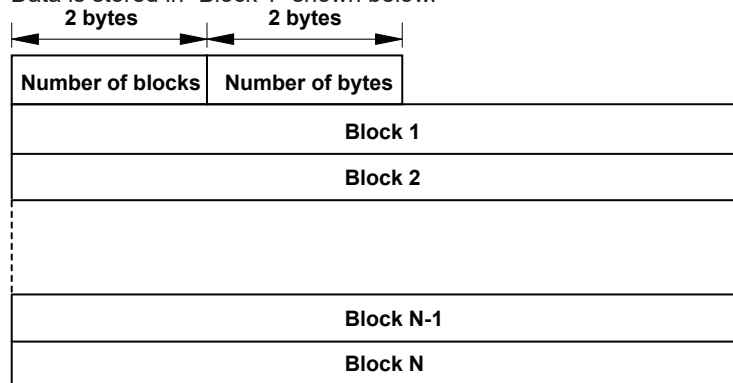

Number of Blocks (16 bits)

Number of stored blocks. Stores the number of blocks that can be output within the range specified by the read start position and end position.

Number of Bytes (16 bits)

Stores the number of bytes per block.

Block

The content of the block is the same as that of "Block 1" described in section ["2.11.1 Most Recent Channel Data \(FData\)"](#).

2.11.3 FIFO Data Read Range (FFifoCur)

The output in response to the command "FFifoCur,1" is shown below. Outputs FIFO data read position information.

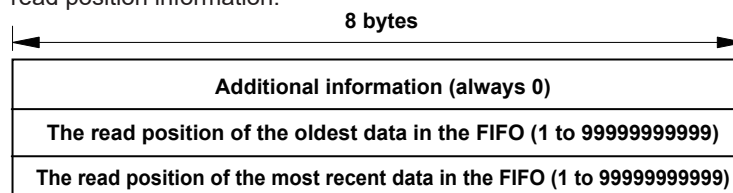

The read position of the oldest data in the FIFO

This is the oldest data number within the readable data range.

The read position of the most recent data in the FIFO

This is the most recent data number within the readable data range.

2.11.4 The Most Recent Control Data (FCtrlData)

The output in response to the command “FCtrlData,1” is shown below. Outputs the most recent control data per loop.

The figure below shows the structure of the output data. Data is stored in “Block 1.”

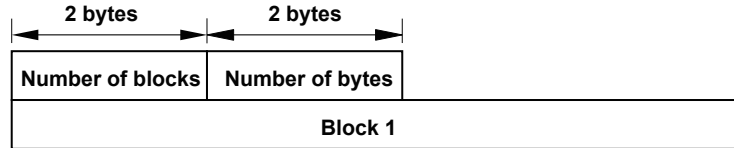

Number of Blocks (16 bits)

Always 1.

Number of Bytes (16 bits)

Stores the number of bytes of block 1.

Block 1

The figure below shows the structure of block 1.

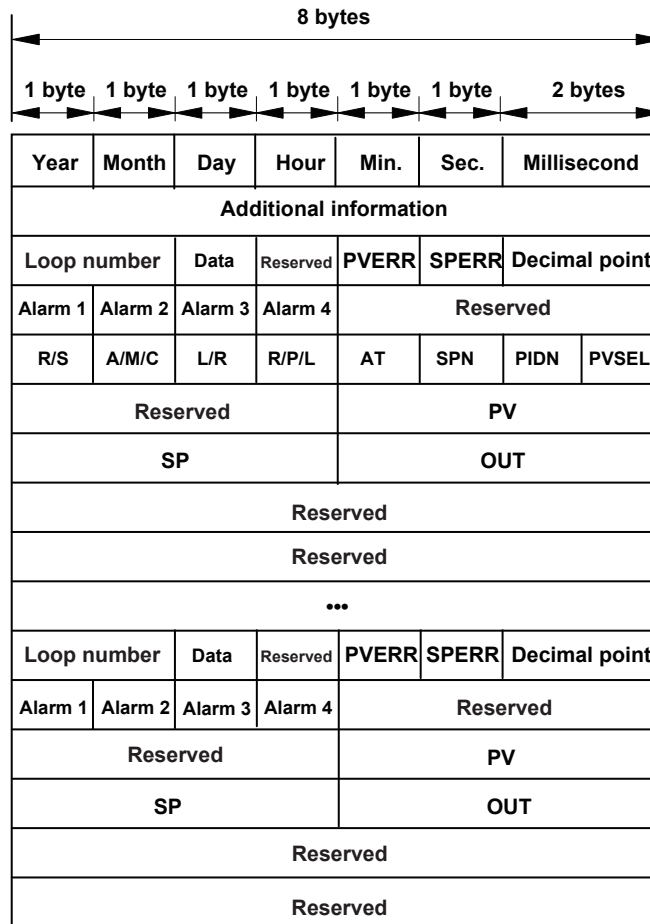

Data Time

Item (Number of Bits)	Value
Year (8 bits)	0 to 99
Month (8 bits)	1 to 12
Day (8 bits)	1 to 31
Hour (8 bits)	0 to 23
Minute (8 bits)	0 to 59
Second (8 bits)	0 to 59
Millisecond (16 bits)	0 to 999

Additional Information (64 bits)

Bit 0: Daylight saving time (0: standard time; 1: daylight saving time)

Loop Number (16 bits)

001 to 692

Data Information (8 bits)

Indicates the data information (or the module status.)

0: Not used, 1: No data, 2: Normal, 3: Lack of data/Module not installed.

PVERR (8 bits)

Indicates the PV error.

Bit	Value	Description
0 to 4	0	No error
	1	Skip
	2	+OVER
	3	-OVER
	4	+Burnout
	5	-Burnout
	6	A/D error
	7	Invalid data
5	0	No A/D calibration value error
	1	A/D calibration value error
6	0	No RJC error
	1	RJC error
7	0	Reserved

SPERR (8 bits)

Indicates the SP error.

Bit	Value	Description
0 to 4	0	No error
	1	Skip
	2	+OVER
	3	-OVER
	4	+Burnout
	5	-Burnout
	6	A/D error
	7	Invalid data
5	0	No A/D calibration value error
	1	A/D calibration value error
6	0	No RJC error
	1	RJC error
7	0	Reserved

Decimal Point Place (16 bits)

Indicates the decimal point place.

Bit	Value	Description
0 to 3	0 to 4	PV
4 to 7	0 to 4	SP
8 to 11	1	OUT

Alarm (32 bits)

Indicates the alarm status.

The eight bit values of alarm 1 to alarm 4 are described in the table below.

Bit	Value	Description
0 to 5	0	No alarm
	1	High limit alarm
	2	Low limit alarm
	3	Difference high limit alarm
	4	Difference low limit alarm
	5	High limit on rate-of-change alarm
	6	Low limit on rate-of-change alarm
	7	Delay high limit alarm
6	8	Delay low limit alarm
	0	No alarm is activated.
7	1	An alarm is activated.
	0	Alarm nonhold state
	1	Alarm hold state

R/S (8 bits)

Indicates the RUN or STOP of the control operation.

0: RUN, 1: STOP

A/M/C (8 bits)

Indicates the AUTO, MANUAL or CASCADE of the control operation.

0: AUTO, 1: MANUAL, 2: CASCADE

L/R (8 bits)

Indicates the LOCAL or REMOTE of the control operation.

0: LOCAL, 1: REMOTE

R/P/L (8 bits)

Indicates the RESET, PROGRAM or LOCAL of the control operation.

0: RESET, 1: PROG, 2: LOCAL

AT (8 bits)

Indicates the On or Off of the Auto tuning.

0: OFF, 1: ON

SPN (8 bits)

1 to 8: SP group number

PIDN (8 bits)

1 to 8: PID group number, 9: Reference PID

PVSEL (8 bits)

Indicates the status of PV input.

Bit	Value	Description
0	ON	AI1 is used for PV1.
1	ON	EXPV1 is used for PV1.
2	ON	AI2 is used for PV2.
3	ON	EXPV2 is used for PV2.
4	ON	AI2 is used for PV1 (when PV switching is selected.)
5	ON	EXPV2 is used for PV1 (when PV switching is selected.)

PV (32 bits)

Indicates the PV value using an integer.

When the data status is Over or Burnout, the integer will be the value of -5% to 105% of the range.

SP (32 bits)

Indicates the SP value using an integer.

When the data status is Over or Burnout, the integer will be the value of -5% to 105% of the range.

OUT (32 bits)

Indicates the OUT value using an integer.

However, when the Tight shut function is used, the SD is -S1 and Invalid data is -100.

Blank

Appendix 1 ASCII Character Codes

The ASCII character code table is shown below.

		Upper 4 Bits							
		0	1	2	3	4	5	6	7
Lower 4 Bits	0			SP (space)	0	@	P	'	p
	1			!	1	A	Q	a	q
	2			"	2	B	R	b	r
	3			#	3	C	S	c	s
	4			\$	4	D	T	d	t
	5			%	5	E	U	e	u
	6			&	6	F	V	f	v
	7			'	7	G	W	g	w
	8			(8	H	X	h	x
	9)	9	I	Y	i	y
	A	LF (line feed)		*	:	J	Z	j	Z
	B		ESC	+	;	K	[k	{
	C			,	<	L	\	l	
	D	CR (return)		-	=	M]	m	}
	E			.	>	N	^	n	~
	F			/	?	O	_	o	

Characters Used in Commands

In addition to alphanumeric characters, the following characters are used: commas as delimiters, semicolons as sub delimiters, question marks as query symbols, single quotation marks to indicate user-defined character strings, and "CR" (return) "LF" (line feed) as terminators.

Characters That Can Be Used in User-Defined Character Strings

The table below shows the characters that can be used in user-defined character strings (tags, tag No., messages, etc.).

Item	Command and Parameter	Description
Directory name	p1 of the SDirectory command	The characters other than those in blue cells and those in thick frames can be used.
File name	p2 of the SFileName command	
Batch number	p2 of the OBatName command	
Password	p5 of SUser p1, p2, and p3 of OPassword p2 of CLogin	The characters other than those in blue cells and SP (space) can be used.
Character strings that users specify other than those above		The characters other than those in blue cells can be used.

Appendix 2 Login Procedure

To communicate using the general communication feature, you must log in to the recorder from your PC. If you complete the procedure successfully up to "Login complete" in the following figure, you will be able to use the commands.

When Using the Login Function

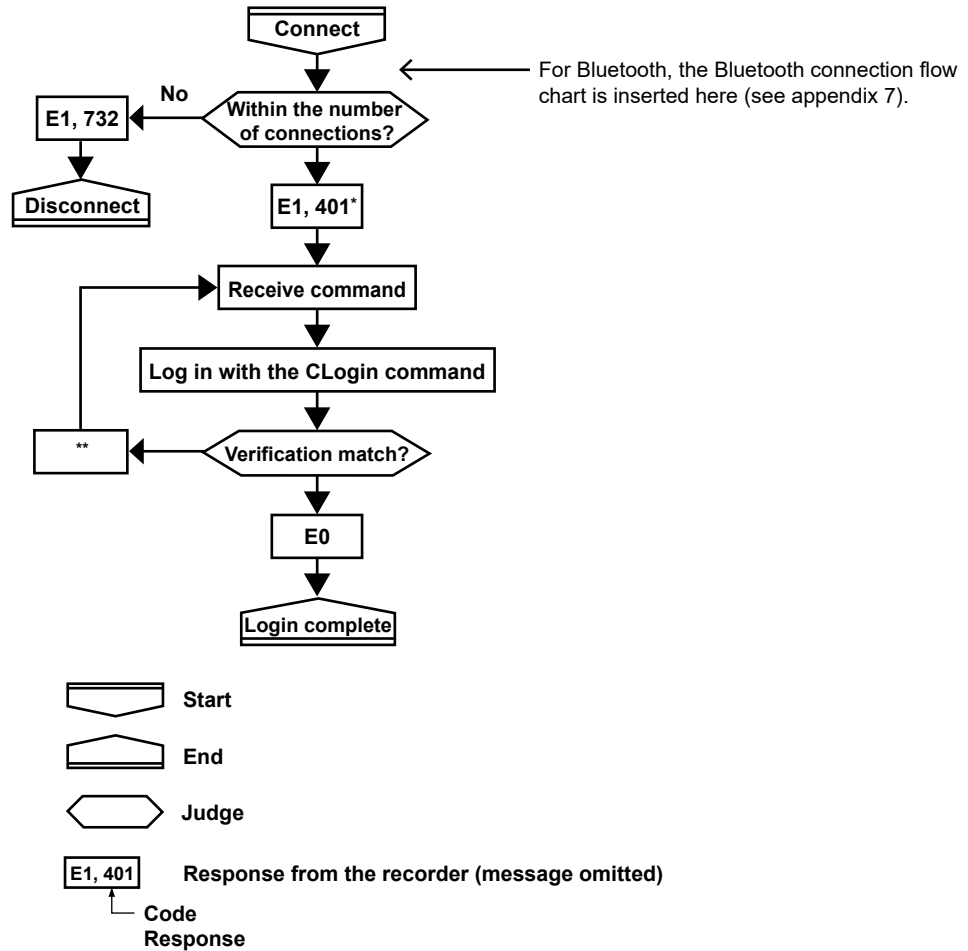

* "E1,402" is returned when the advanced security function (/AS) is enabled.

** E251. If the format of the CLogin command is not correct, verification is not performed, and an error code indicating the error is returned.

The following error code is returned when the advanced security function (/AS) is enabled.

251, 262, 263, 264, 265, 272, 273, 267

When the password management is in use, the following error code is returned in addition to the error code above.

004,252,261,651,657,760,761,762,763,764,765,766,768,769,770,771,772,773,774,775

When Not Using the Login Function

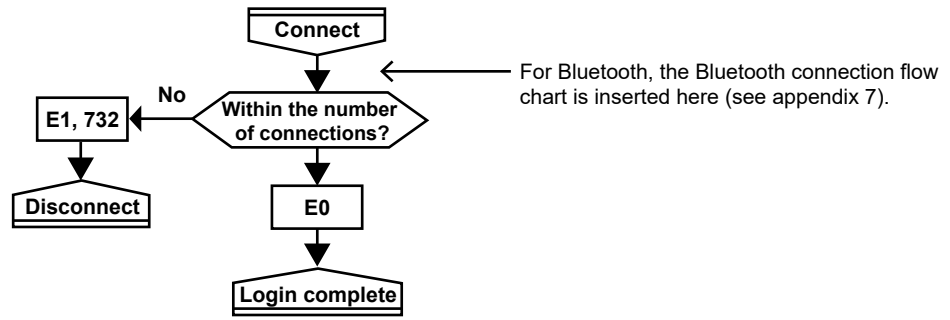

 Start

 End

 Judge

 E1, 401 Response from the recorder (message omitted)
Code Response

Appendix 3 Output Flow Chart of External Storage Medium Files and File Lists

Example for Outputting File `aaaa.dtd`

The flow chart for outputting file `aaaa.dtd` in the `DATA0` directory on the external storage medium is shown below.

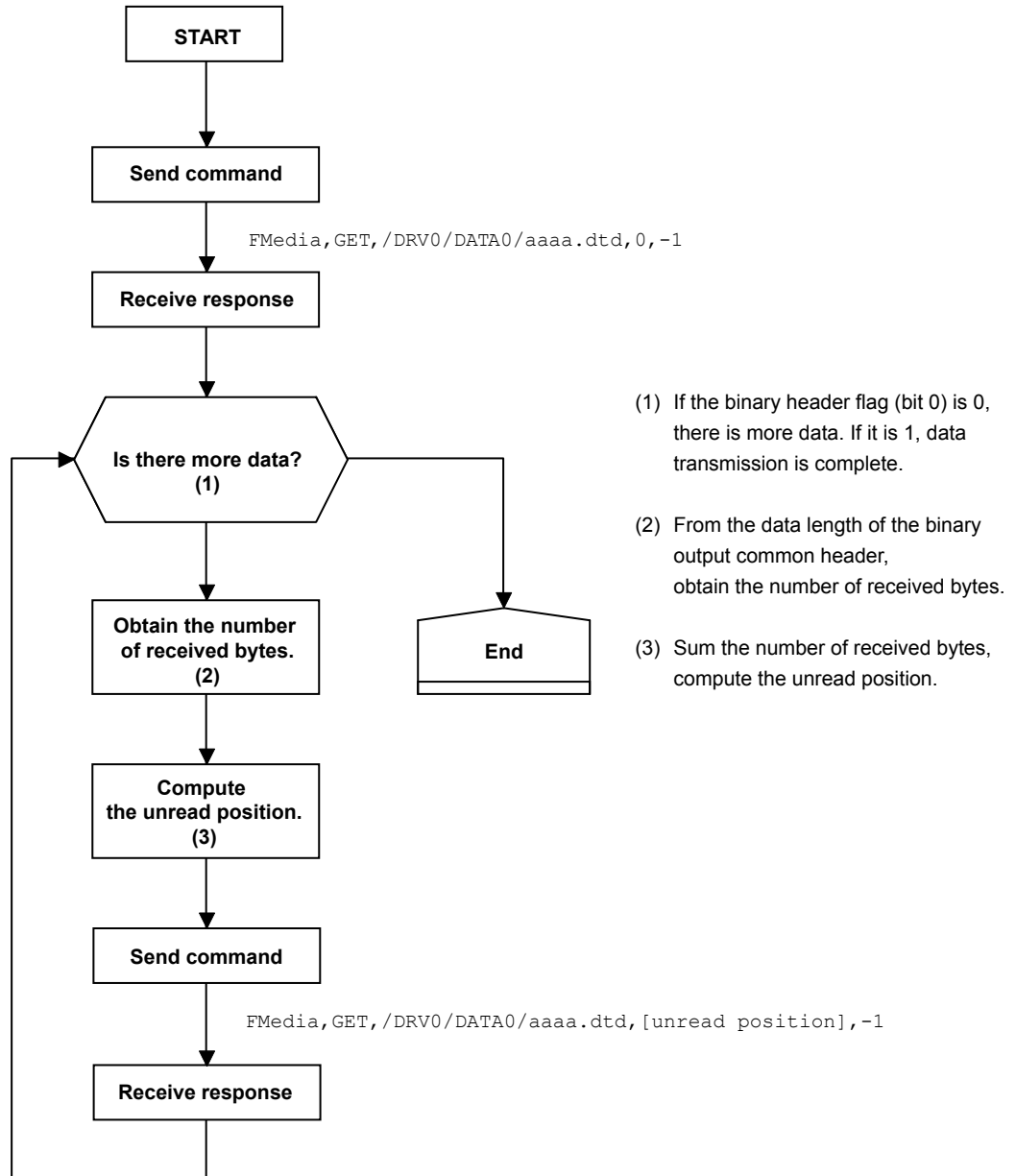

Example for Outputting a File List

The flow chart for outputting the list of files in the DATA0 directory on the external storage medium is shown below.

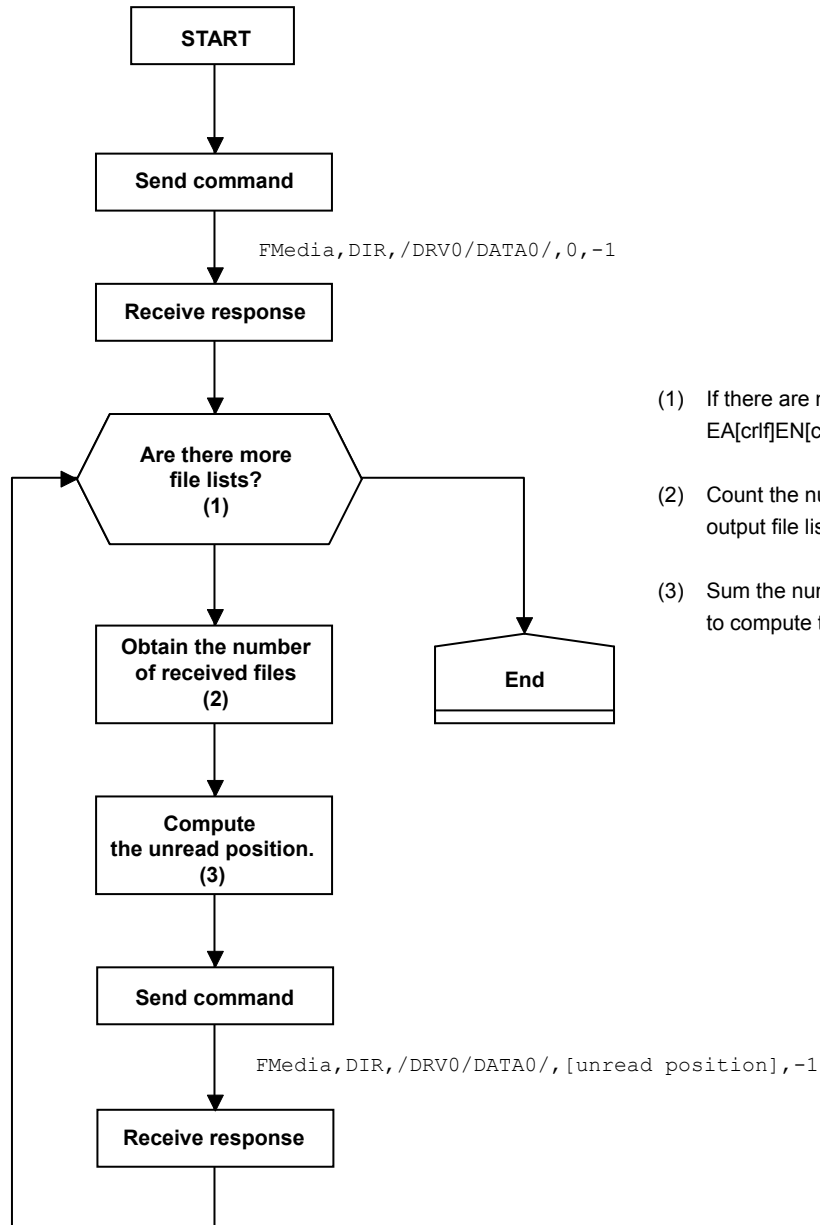

- (1) If there are no more files, EA[crf]EN[crf] is output.
- (2) Count the number of lines in the output file list.
- (3) Sum the number of lines in the file lists to compute the unread position.

Appendix 4 FIFO Data Output Flow Chart

Overview of the FIFO Buffer

The recorder internal memory is equipped with a dedicated FIFO (First-In-First-Out) buffer for outputting measured data. Measured data is written to the buffer at every scan interval. The PC can continuously retrieve the most recent measured data from the FIFO buffer. The size of the internal memory allocated for the FIFO buffer varies depending on the model. The number of data entries that the FIFO buffer can store varies depending on the number of channels and scan interval. The number of data entries that the FIFO buffer can store and the data length can be determined with the following formula.

Data entries = $2000000 \div \{16 + (12 \times [\text{number of channels}])\}$ (fractions truncated)

Data length = [data entries] × [scan interval]

Example If there are 10 I/O channels, 10 math channels, and 10 communication channels, and the scan interval is 100 ms, the number data entries will be 5319, and the data length will be 531.9 seconds or 8.865 minutes.

Example of FIFO Buffer Operation

The following example shows the case when the scan interval is 1 second and the FIFO internal memory size is for 8 scan intervals.

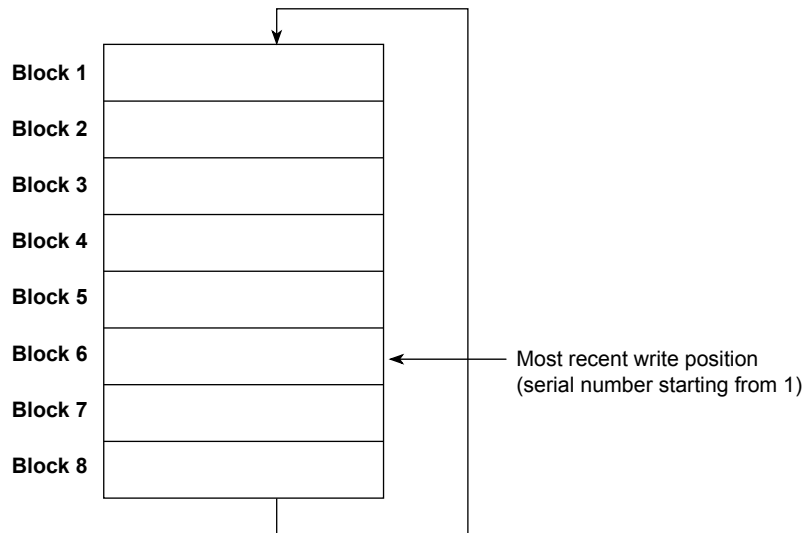

Writing of Measured Data in the FIFO Buffer

Writing to the FIFO buffer takes place every scan interval. If measured data is written to block 8, the most recent value will be written to block 1 in the next scan interval, overwriting the old value. This is called FIFO wraparound.

On the other hand, the most recent write position is managed using serial numbers starting with 1. The serial number does not return to 1 even when a FIFO wraparound occurs.

Reading Measured Data

The FFifoCur,0 command is used to read measured data. The read start position and read end position are specified using serial numbers. You can use the FFifoCur,1 command to read the serial numbers for the positions that data can be read from.

Appendix 5 Check Sum Calculation Method

The check sum of binary data is calculated using an algorithm like the one shown below.

```
int CalcSum(unsigned char *buf, int len)
{
    int    odd;
    unsigned long    sum;
    unsigned char    *p;

    sum = 0;
    odd = len & 1;
    len >>= 1;

    for (p = buf ; len ; len --, p += 2)
    {
        sum += (*p << 8) | *(p + 1);
    }

    if (odd)    sum += (*p << 8);

    sum = (sum & 0xffff) + ((sum >> 16) & 0xffff);
    if (sum > 0xffff)    sum = sum - 0xffff;

    return ((~sum) & 0xffff);
}
```

Appendix 6 Data Group Name and Data Name for WT Communication

The table below shows the parameters p5 (Data Group Name) and p6 (Data Name) for SWattData Command.

Parameters p5 (Data Group Name) and p6 (Data Name) for SWattData Command

WT1800

p5 (Data group name)	p6 (Data name)	Description	WT Function mark
Off	-	Data assignment is disabled.	-
ELEMENT1 to ELEMENT6	URMS	True rms voltage	Urms
	UMN	Rectified mean voltage calibrated to the rms value	Umn
	UDC	Simple voltage average	Udc
	IRMS	True rms current	Irms
	IMN	Rectified mean current calibrated to the rms value	Imn
	IDC	Simple current average	Idc
	P	Active power	P
	S	Apparent power	S
	Q	Reactive power	Q
	LAMBda	Power factor	λ
	PHI	Phase difference	ϕ
	FU	voltage frequency	fU
	FI	current frequency	fi
	TIME	Integration time	Time
	WH	sum of watt hours	WP
	WHP	Sum of positive P (consumed watt hours)	WP+
	WHM	Sum of negative P (watt hours returned to the power supply)	WP-
	AH	Sum of positive and negative ampere hours	q
	AHP	Sum of positive I (ampere hours)	q+
	AHM	Sum of negative I (ampere hours)	q-
ElemHrm1 to ElemHrm6	UK 1	RMS voltage of harmonic order 1	U(1)
	UK T	Rms voltage	U(Total)
	IK 1	RMS current of harmonic order 1	I(1)
	IK T	Rms current	I(Total)
	UTHD	Ratio of the total harmonic voltage to U(1) or U(Total)	Uthd
	ITHD	Ratio of the total harmonic current to I(1) or I(Total)	Ithd
SigmaA to SigmaC	URMS	True rms voltage	Urms Σ^1
	UMN	Rectified mean voltage calibrated to the rms value	Umn Σ
	IRMS	True rms current	Irms Σ
	IMN	Rectified mean current calibrated to the rms value	Imn Σ
	P	Active power	P Σ
	S	Apparent power	S Σ
	LAMBda	Power factor	$\lambda\Sigma$
	PHI	Phase difference	$\phi\Sigma$
	WH	Sum of positive and negative watt hours	WP Σ
	WHP	Sum of positive P (consumed watt hours)	WP+ Σ
	WHM	Sum of negative P (watt hours returned to the power supply)	WP- Σ
	AH	Sum of positive and negative ampere hours	q Σ
AHP	Sum of positive I (ampere hours)	q+ Σ	
AHM	Sum of negative I (ampere hours)	q- Σ	

Continued on next page

Data group name	Data name	Description	WT Function mark
Other	ETA1	Efficiency 1	η 1
	ETA2	Efficiency 2	η 2
	ETA3	Efficiency 3	η 3
	ETA4	Efficiency 4	η 4
	F1	User-defined function 1	F1
	F2	User-defined function 2	F2
	F3	User-defined function 3	F3
	F4	User-defined function 4	F4
	F5	User-defined function 5	F5
	F6	User-defined function 6	F6
	F7	User-defined function 7	F7
	F8	User-defined function 8	F8
	F9	User-defined function 9	F9
	F10	User-defined function 10	F10
	F11	User-defined function 11	F11
	F12	User-defined function 12	F12
	F13	User-defined function 13	F13
	F14	User-defined function 14	F14
F15	User-defined function 15	F15	
F16	User-defined function 16	F16	
F17	User-defined function 17	F17	
F18	User-defined function 18	F18	
DeltaA to DeltaC	DU1	Delta computation voltage 1	Δ U1
	DU2	Delta computation voltage 2	Δ U2
	DU3	Delta computation voltage 3	Δ U3
	DUS	Delta computation wiring voltage	Δ U Σ
	DI	Delta computation current	Δ I
	DP1	Delta computation power 1	Δ P1
	DP2	Delta computation power 2	Δ P2
	DP3	Delta computation power 3	Δ P3
DPS	Delta computation wiring power	Δ P Σ	
Motor	SPEED	Motor rotating speed	Speed
	TORQUE	Motor torque	Torque
	SYNCSP	Synchronous speed	SyncSp
	SLIP	Slip (%)	Slip
	PM	Mechanical output of the motor (mechanical power)	Pm
Aux	Aux1	Auxiliary input 1	Aux1
	Aux2	Auxiliary input 2	Aux2

1 Will become Σ A, Σ B, or Σ C depending on the WT1800 wiring type.

WT500

Data group name	Data name	Description	WT Function mark	
Off	-	Data assignment is disabled.	-	
ELEMENT to ELEMENT3	URMS	True rms voltage	Urms	
	UMN	Rectified mean voltage calibrated to the rms value	Umn	
	UDC	Simple voltage average	Udc	
	URMN	Rectified mean voltage	Urmn	
	UAC	AC component	Uac	
	IRMS	True rms current	Irms	
	IMN	Rectified mean current calibrated to the rms value	Imn	
	IDC	Simple current average	Idc	
	IRMN	Rectified mean current	Irmn	
	IAC	AC component	Iac	
	P	Active power	P	
	S	Apparent power	S	
	Q	Reactive power	Q	
	LAMBda	Power factor	λ	
	PHI	Phase difference	φ	
	FU	Voltage frequency	fU	
	FI	Current frequency	fI	
	UPPeak	Maximum voltage	U+pk	
	UMPeak	Minimum voltage	U-pk	
	IPPeak	Maximum current	I+pk	
	IMPeak	Minimum current	I-pk	
	CFU	Voltage crest factor	CfU	
	CFI	Current crest factor	CfI	
	TIME	Integration time	Time	
	WH	Sum of positive and negative watt hours	WP	
	WHP	Sum of positive P (consumed watt hours)	WP+	
	WHM	Sum of negative P (watt hours returned to the power supply)	WP-	
	AH	Sum of positive and negative ampere hours	q	
	AHP	Sum of positive I (ampere hours)	q+	
	AHM	Sum of negative I (ampere hours)	q-	
	WS	Volt-ampere hours	WS	
	WQ	Var hours	WQ	
	ElemHrm1 to ElemHrm3	UK_0	Rms voltage of harmonic order 0	U(0)
		UK_1	Rms voltage of harmonic order 1	U(1)
		UK_T	Rms voltage	U(Total)
		IK_0	Rms current of harmonic order 0	I(0)
		IK_1	Rms current of harmonic order 1	I(1)
		IK_T	Rms current	I(Total)
		PK_0	Active power of harmonic order 0	P(0)
		PK_1	Active power of harmonic order 1	P(1)
PK_T		Active power	P(Total)	
SK_0		Apparent power of harmonic order 0	S(0)	
SK_1		Apparent power of harmonic order 1	S(1)	
SK_T		Total apparent power	S(Total)	
QK_0		Reactive power of harmonic order 0	Q(0)	
QK_1		Reactive power of harmonic order 1	Q(1)	
QK_T		Total reactive power	Q(Total)	
LAMBDA0		Power factor of harmonic order 0	λ (0)	
LAMBDA1		Power factor of harmonic order 1	λ (1)	
LAMB DAT		Total power factor	λ (Total)	
PHIK_1		Phase difference between the voltage and current of harmonic order 1	φ (1)	
PHIK_T		Total phase difference	φ (Total)	

Continued on next page

Data group name	Data name	Description	WT Function mark
ElemHrm1 to ElemHrm3	PHIUk3	Phase difference between harmonic voltage U(3) and the fundamental signal U(1).	φ U(3)
	PHIk3	Phase difference between harmonic current I(3) and the fundamental signal I(1).	φ I(3)
	UTHD	Ratio of the total harmonic voltage to U(1) or U(Total)	Uthd
	ITHD	Ratio of the total harmonic current to I(1) or I(Total)	Ithd
	PTHD	Ratio of the total harmonic active power to P(1) or P(Total)	Pthd
SigmaA	URMS	True rms voltage	Urms Σ
	UMN	Rectified mean voltage calibrated to the rms value	Umn Σ
	UDC	Simple voltage average	Udc Σ
	URMN	Rectified mean voltage	Urmn Σ
	UAC	AC component	Uac Σ
	IRMS	True rms current	Irms Σ
	IMN	Rectified mean current calibrated to the rms value	Imn Σ
	IDC	Simple current average	Idc Σ
	IRMN	Rectified mean current	Irmn Σ
	IAC	AC component	Iac Σ
	P	Active power	P Σ
	S	Apparent power	S Σ
	Q	Reactive power	Q Σ
	LAMBda	Power factor	$\lambda\Sigma$
	PHI	Phase difference	$\varphi\Sigma$
	WH	Sum of positive and negative watt hours	WP Σ
	WHP	Sum of positive P (consumed watt hours)	WP+ Σ
	WHM	Sum of negative P (watt hours returned to the power supply)	WP- Σ
	AH	Sum of positive and negative ampere hours	q Σ
	AHP	Sum of positive I (ampere hours)	q+ Σ
	AHM	Sum of negative I (ampere hours)	q- Σ
WS	Integrated value of S Σ	WS Σ	
WQ	Integrated value of Q Σ	WQ Σ	
Other	ETA1	Efficiency 1	η 1
	ETA2	Efficiency 2	η 2
	F1	User-defined function 1	F1
	F2	User-defined function 2	F2
	F3	User-defined function 3	F3
	F4	User-defined function 4	F4
	F5	User-defined function 5	F5
	F6	User-defined function 6	F6
	F7	User-defined function 7	F7
F8	User-defined function 8	F8	
Delta	DELTA1	Delta computation 1	Δ F1
	DELTA2	Delta computation 2	Δ F2
	DELTA3	Delta computation 3	Δ F3
	DELTA4	Delta computation 4	Δ F4
Phase	PHI_U1U2	The phase difference between the fundamental voltage of element 1, U1(1), and the fundamental voltage of element 2, U2(1)	φ U1-U2
	PHI_U1U3	The phase difference between the fundamental voltage of element 1, U1(1), and the fundamental voltage of element 3, U3(1)	φ U1-U3
	PHI_U1I1	The phase difference between the fundamental voltage of element 1, U1(1), and the fundamental current of element 1, I1(1)	φ U1-I1

Continued on next page

Appendix 6 Data Group Name and Data Name for WT Communication

Data group name	Data name	Description	WT Function mark
Phase	PHI_U1I2	The phase difference between the fundamental voltage of element 1, U1(1), and the fundamental current of element 2, I2(1)	φ U1-I2
	PHI_U1I3	The phase difference between the fundamental voltage of element 1, U1(1), and the fundamental current of element 3, I3(1)	φ U1-I3

WT300

Data group name	Data name	Description	WT Function mark
Off	-	Data assignment is disabled.	-
ELEMENT1 to ELEMENT3	U	voltage	U
	I	current	I
	P	active power	P
	S	apparent power	S
	Q	reactive power	Q
	LAMBda	power factor	λ
	PHI	phase difference	φ
	FU	voltage frequency	fU
	FI	current frequency	fI
	UPPeak	Maximum voltage	U+pk
	UMPeak	Minimum voltage	U-pk
	IPPeak	Maximum current	I+pk
	IMPeak	Minimum current	I-pk
	PPPeak	Maximum active power	P+pk
	PMPeak	Minimum active power	P-pk
	TIME ¹	Integration time	Time
	WH	sum of watt hours	WP
	WHP	Sum of positive P (consumed watt hours)	WP+
	WHM	Sum of negative P (watt hours returned to the power supply)	WP-
	AH	Sum of positive and negative ampere hours	q
	AHP	Sum of positive I (ampere hours)	q+
	AHM	Sum of negative I (ampere hours)	q-
	ElemHrm1 to ElemHrm3	UK_1	RMS voltage of harmonic order 1
UK_T		Rms voltage	U(Total)
IK_1		RMS current of harmonic order 1	I(1)
IK_T		Rms current	I(Total)
PK_1		Active power of harmonic order 1	P(1)
PK_T		Active power	P(Total)
LAMBDA1		Power factor of harmonic order 1	λ (1)
PHIK_1		Phase difference between the voltage and current of harmonic order 1	φ (1)
PHIUk3		Phase difference between harmonic voltage U(3) and the fundamental signal U(1).	φ U(3)
PHIik3		Phase difference between harmonic current I(3) and the fundamental signal I(1).	φ I(3)
UTHD		Ratio of the total harmonic voltage to U(1) or U(Total)	Uthd
ITHD		Ratio of the total harmonic current to I(1) or I(Total)	Ithd
Uhdf_1		relative harmonic content of harmonic voltage of order 1	Uhdf(1)
Ihdf_1		relative harmonic content of harmonic current of order 1	Ihdf(1)
Phdf_1		relative harmonic content of harmonic power of order 1	Phdf(1)
FPLL ²		Current frequency or voltage frequency of PLL source	fPLL

Continued on next page

Data group name	Data name	Description	WT Function mark
SigmaA	U	voltage	U Σ
	I	current	I Σ
	P	active power	P Σ
	S	apparent power	S Σ
	Q	reactive power	Q Σ
	LAMBda	power factor	$\lambda\Sigma$
	PHI	phase difference	$\phi\Sigma$
	WH	Sum of positive and negative watt hours	WP Σ
	WHP	Sum of positive P (consumed watt hours)	WP+ Σ
	WHM	Sum of negative P (watt hours returned to the power supply)	WP- Σ
	AH	Sum of positive and negative ampere hours	q Σ
	AHP	Sum of positive I (ampere hours)	q+ Σ
AHM	Sum of negative I (ampere hours)	q- Σ	
Other	MATH	Computed value, such as efficiency	Math

- 1 "TIME" is valid only when the data group is "ELEMENT1."
- 2 "PFL" is valid only when the data group is "ElemHrm1."

Appendix 7 Bluetooth Communication Connection Flow Chart

To compose the complete Bluetooth communication connection flow chart, in appendix 2, insert the following flow chart after “Connect” in the flow chart shown under “When Using the Login Function” when the communication login function is in use or “When Not Using the Login Function” when the function is not in use.

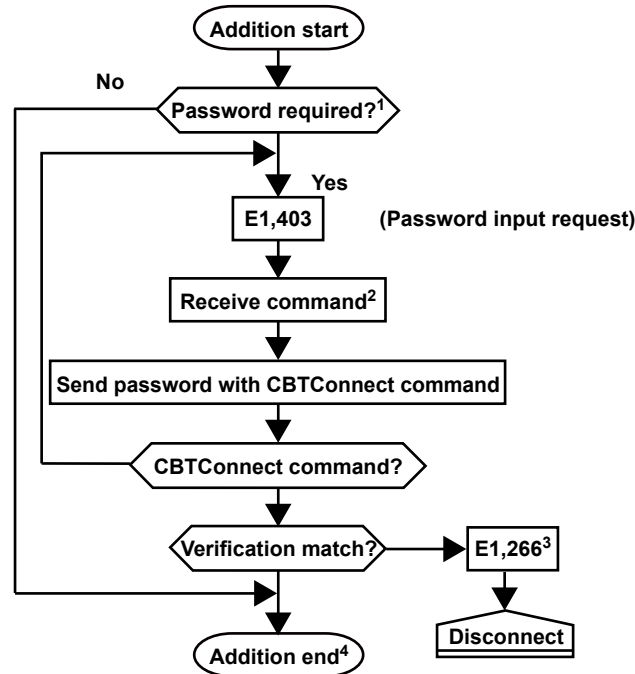

 Start

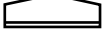
 End

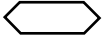
 Judge

 E1,401 Response from the recorder (message omitted)

Code

- 1 A Bluetooth password is required when the first terminal tries to establish a connection when the password usage is enabled.
- 2 If no input is received within 2 minutes of a password input request (E403), Bluetooth communication will be disconnected.
- 3 If an error occurs during the CBTConnect command check (the number of parameters, whether the command is a query, etc.), the flow chart sequence follows the same path as when the password verification fails.
- 4 The above sequence between “Addition start” and “Addition end” is not recorded in the general log.