

EZ-LIGHT® TL50HZ High Brightness Universal AC Voltage Tower Light

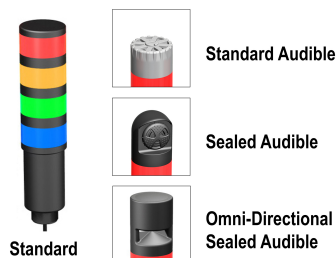

Datasheet

Multi-Color General-Purpose or Audible Indicators



- Similar in design and construction to standard TL50 Tower Lights, but more than 4 times brighter, improving visibility in areas with high levels of ambient light
- Rugged, cost-effective, and easy-to-install multi-segment indicators
- Illuminated segments provide easy-to-see operator guidance and indication of equipment status
- Displays up to 5 colors
- Available in black or light gray housing
- Audible models available with standard, sealed, or omni-directional audible element
- Compact devices are completely self-contained, no controller needed
- 100 V ac to 240 V ac operation
- No assembly required

Non-Audible Models

Model ¹	# of LED Colors	LED Colors ²	Connection ³	Inputs
TL50HZR	1	Red	4-wire PVC cable	100 V ac to 240 V ac
TL50HZGR	2	Green, Red		
TL50HZGYR	3	Green, Yellow, Red		
TL50HZBGYR	4	Blue, Green, Yellow, Red	5-wire PVC cable	
TL50HZWBGYR	5	White, Blue, Green, Yellow, Red	6-wire PVC cable	

Audible Models

Standard Audible Model ¹			# of LED Colors	LED Colors ²	Connection ³	Inputs
TL50HZRA			1	Red	4-wire PVC cable	100 V ac to 240 V ac
TL50HZGRA			2	Green, Red		
TL50HZGYRA			3	Green, Yellow, Red	5-wire PVC cable	
TL50HZBGYRA			4	Blue, Green, Yellow, Red	6-wire PVC cable	

Sealed Audible Model ¹			# of LED Colors	LED Colors ²	Connection ³	Inputs
Continuous	Pulsed at 1.6 Hz	Staccato				
TL50HZRALS	TL50HZRALS3	TL50HZRALS4	1	Red	4-wire PVC cable	100 V ac to 240 V ac
TL50HZGRALS	TL50HZGRALS3	TL50HZGRALS4	2	Green, Red		
TL50HZGYRALS	TL50HZGYRALS3	TL50HZGYRALS4	3	Green, Yellow, Red	5-wire PVC cable	
TL50HZBGYRALS	TL50HZBGYRALS3	TL50HZBGYRALS4	4	Blue, Green, Yellow, Red	6-wire PVC cable	

¹ Models with black housing are listed. For gray housing, add the suffix "C" at the end of the cabled model number or before the "QP" in 150 mm (6 in) PVC cable model numbers. For example, TL50HZRC or TL50HZRCQP.

² The first color listed is the bottom color, going up in successive order. Four color options are only available in audible cabled models. Five color options are only available in non-audible cabled models.

³

- To order the 150 mm (6 in) PVC cable model, add the suffix "QP" to the model number. For example, TL50HZRQP.
- Models with a quick disconnect require a mating cordset.



Omni-Directional Sealed Audible Model ¹			# of LED Colors	LED Colors ²	Connection ³	Inputs
Continuous	Pulsed at 1.6 Hz	Staccato				
TL50HZRAOS	TL50HZRAOS3	TL50HZRAOS4	1	Red	4-wire PVC cable	100 V ac to 240 V ac
TL50HZGRAOS	TL50HZGRAOS3	TL50HZGRAOS4	2	Green, Red		
TL50HZGYRAOS	TL50HZGYRAOS3	TL50HZGYRAOS4	3	Green, Yellow, Red	5-wire PVC cable	
TL50HZBGYRAOS	TL50HZBGYRAOS3	TL50HZBGYRAOS4	4	Blue, Green, Yellow, Red	6-wire PVC cable	

Omni-Directional Sealed Audible Model with Intensity Adjustment ¹			# of LED Colors	LED Colors ²	Connection ³	Inputs
Continuous	Pulsed at 1.6 Hz	Staccato				
TL50HZRAOSI	TL50HZRAOS3I	TL50HZRAOS4I	1	Red	4-wire PVC cable	100 V ac to 240 V ac
TL50HZGRAOSI	TL50HZGRAOS3I	TL50HZGRAOS4I	2	Green, Red		
TL50HZGYRAOSI	TL50HZGYRAOS3I	TL50HZGYRAOS4I	3	Green, Yellow, Red	5-wire PVC cable	
TL50HZBGYRAOSI	TL50HZBGYRAOS3I	TL50HZBGYRAOS4I	4	Blue, Green, Yellow, Red	6-wire PVC cable	

Wiring Diagram

4-Wire

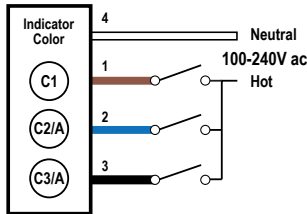

5-Wire

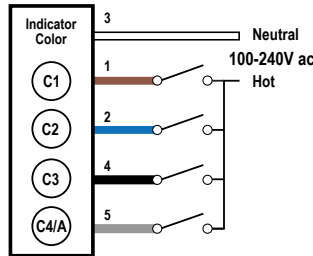

6-Wire

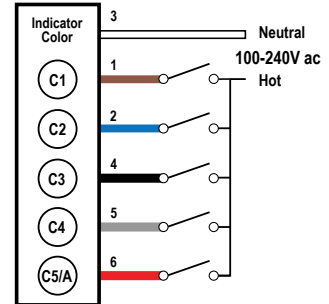

4-Wire Key:

- 1 = Brown
- 2 = Blue
- 3 = Black
- 4 = White

4-Wire Key:

- C1 = Color 1
- C2 = Color 2
- C3 = Color 3
- A = Audible

5-Wire Key:

- 1 = Brown
- 2 = Blue
- 3 = White
- 4 = Black
- 5 = Gray

5-Wire Key:

- C1 = Color 1
- C2 = Color 2
- C3 = Color 3
- C4 = Color 4
- A = Audible

6-Wire Key:

- 1 = Brown
- 2 = Blue
- 3 = White
- 4 = Black
- 5 = Gray
- 6 = Red

6-Wire Key:

- C1 = Color 1
- C2 = Color 2
- C3 = Color 3
- C4 = Color 4
- C5 = Color 5
- A = Audible

Specifications

Supply Voltage and Current

100 V ac to 240 V ac; 50 Hz or 60 Hz

Indicators—maximum current per LED color:

60 mA at 100 V ac

55 mA at 120 V ac

40 mA at 240 V ac

Standard Audible Alarm: 30 mA maximum current

Sealed Audible Alarm: 35 mA maximum current

Omni-Directional Sealed Audible Alarm: 45 mA maximum current

Supply Protection Circuitry

Protected against transient voltages

Input Response Time

Indicator On/Off: 500 ms (maximum)

Audible Adjustment

Standard Audible Alarm: Unscrew the cover (up to 1.5 turns maximum) to adjust the audible intensity. (Do not exceed 1.5 turns or the cover may detach during operation.) For maximum intensity, rotate the center plug 180° counterclockwise to remove it.

Sealed Audible Alarm and **Omni-Directional** Sealed Audible Alarm with Intensity Adjustment: Rotate the front cover until the desired intensity is reached.

Omni-Directional Sealed Audible Alarm: No adjustment.

Audible Alarm

Standard Audible Alarm: 2.7 kHz ± 500 Hz oscillation frequency; maximum intensity 92 dB at 1 m (3.3 ft) (typical)

Sealed Audible Alarm: 2.9 kHz ± 250 Hz oscillation frequency; maximum intensity 94 dB at 1 m (3.3 ft) (typical)

Omni-Directional Sealed Audible Alarm: 2.1 kHz ± 250 Hz oscillation frequency; maximum intensity 99 dB at 1 m (3.3 ft) (typical)

Omni-Directional Sealed Audible Alarm with Intensity Adjustment: 2.1 kHz ± 250 Hz oscillation frequency; maximum intensity 95 dB at 1 m (3.3 ft) (typical)

Typical **Reduction** in Sound Intensity with Audible Adjustment (maximum to minimum)

- Standard Audible: 30 dB
- Sealed Audible: 20 dB
- **Omni-Directional** Sealed Audible: 12 dB

Construction

Bases and Covers: ABS

Light Segment: Polycarbonate

Operating Conditions

Non-Audible: -40 °C to +50 °C (-40 °F to +122 °F)

Standard and Sealed Audible: -20 °C to +50 °C (-4 °F to +122 °F)

95% at +50 °C maximum relative humidity (non-condensing)

Vibration and Mechanical Shock

All models meet Mil Std. 202F requirements. Method 201A (vibration: 10 Hz to 60 Hz max., double amplitude 0.06 inch, maximum acceleration 10G). Also meets IEC 947-5-2 requirements: 30G 11 ms duration, half sine wave.

Environmental Rating

NEMA/UL Type 13

Non-Audible and Sealed Audible: IEC IP67

Standard Audible: IEC IP50

Certifications



Indicators

LEDs are independently selected; 1 to 5 colors depending on model

Indicator Characteristics

Color	Dominant Wavelength (nm) or Color Temperature (CCT)	Lumen Output (Typical at 25 °C)
Green	525 nm	60
Red	625 nm	32
Yellow	590 nm	23
Blue	475 nm	23
White	5000 K	50

Leakage Current Immunity

500 µA

Application Note: The use of relay output PLC is recommended since there is no leakage current. Solid state output PLCs often have leakage current above 1 mA and, therefore, turn the light on in the off state. To counteract the leakage current, a shunt resistor must be used. A resistor must be applied from the neutral wire of the device to the hot wire of each channel of the device.

Connections

4-wire, 5-wire, or 6-wire 2 m (6.5 ft) integral cable; 4-pin or 5-pin 150 mm (6 in) PVC cable with QD, depending on model

Required Overcurrent Protection



WARNING: Electrical connections must be made by qualified personnel in accordance with local and national electrical codes and regulations.

Overcurrent protection is required to be provided by end product application per the supplied table.

Overcurrent protection may be provided with external fusing or via Current Limiting, Class 2 Power Supply.

Supply wiring leads < 24 AWG shall not be spliced.

For additional product support, go to www.bannerengineering.com.

Supply Wiring (AWG)	Required Overcurrent Protection (Amps)
20	5.0
22	3.0
24	2.0
26	1.0
28	0.8
30	0.5

Dimensions

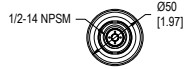
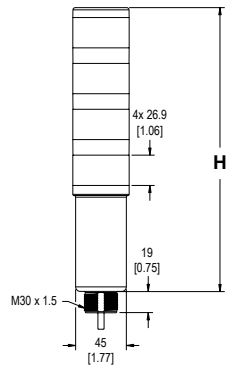

# of Colors	Tower Height (H)			
	Non-Audible	Standard Audible*	Sealed Audible	Omni-Directional Sealed Audible
1	130.2 mm (5.1 in)	161.0 mm (6.3 in)	184.1 mm (7.2 in)	198.1 mm (7.8 in)
2	170.9 mm (6.7 in)	201.7 mm (7.9 in)	224.8 mm (8.9 in)	238.8 mm (9.4 in)
3	211.6 mm (8.3 in)	242.4 mm (9.5 in)	265.5 mm (10.5 in)	279.5 mm (11.0 in)
4	252.3 mm (9.9 in)	283.1 mm (11.1 in)	306.2 mm (12.1 in)	320.2 mm (12.6 in)
5	293.0 mm (11.5 in)	-	-	-

* Tower height (H) with top unscrewed approximately 3.5 mm to allow sound to escape

Accessories

Cordsets

4-Pin Micro-Style Cordsets				
Model	Length	Style	Dimensions	Pinout (Female)
MQAC2-406	1.83 m (6 ft)	Straight		<p>1 = Brown 2 = Blue 3 = Black 4 = White</p>
MQAC2-415	4.57 m (15 ft)			
MQAC2-430	9.14 m (30 ft)			

5-Pin Micro-Style Cordsets				
Model	Length	Style	Dimensions	Pinout
MQAC2-506	1.83 m (6 ft)	Straight		<p>1 = Brown 2 = Blue 3 = White 4 = Black 5 = Gray</p>
MQAC2-515	4.57 m (15 ft)			
MQAC2-530	9.14 m (30 ft)			

Mounting Brackets

SMB30A

- Right-angle bracket with curved slot for versatile orientation
- Clearance for M6 (¼ in) hardware
- Mounting hole for 30 mm sensor
- 12-ga. stainless steel

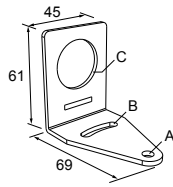

Hole center spacing: A to B=40
Hole size: A=ø 6.3, B= 27.1 x 6.3, C=ø 30.5

SMB30FA

- Swivel bracket with tilt and pan movement for precise adjustment
- Mounting hole for 30 mm sensor
- 12-ga. 304 stainless steel
- Easy sensor mounting to extrude rail T-slot
- Metric and inch size bolt available

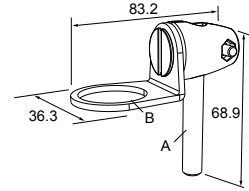

Bolt thread: SMB30FA, A= 3/8 - 16 x 2 in; SMB30FAM10, A= M10 - 1.5 x 50
Hole size: B= ø 30.1

SMB30MM

- 12-ga. stainless steel bracket with curved mounting slots for versatile orientation
- Clearance for M6 (¼ in) hardware
- Mounting hole for 30 mm sensor

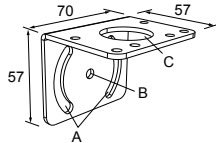

Hole center spacing: A = 51, A to B = 25.4
Hole size: A = 42.6 x 7, B = ø 6.4, C = ø 30.1

SMBAMS30P

- Flat SMBAMS series bracket
- 30 mm hole for mounting sensors
- Articulation slots for 90°+ rotation
- 12-ga. 300 series stainless steel

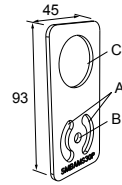

Hole center spacing: A=26.0, A to B=13.0
Hole size: A=26.8 x 7.0, B=ø 6.5, C=ø 31.0

SMBAMS30RA

- Right-angle SMBAMS series bracket
- 30 mm hole for mounting sensors
- Articulation slots for 90°+ rotation
- 12-ga. (2.6 mm) cold-rolled steel

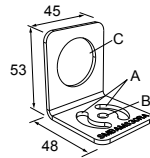

Hole center spacing: A=26.0, A to B=13.0
Hole size: A=26.8 x 7.0, B=ø 6.5, C=ø 31.0

SMB30SC

- Swivel bracket with 30 mm mounting hole for sensor
- Black reinforced thermoplastic polyester
- Stainless steel mounting and swivel locking hardware included

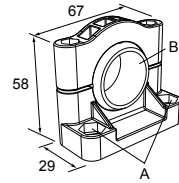

Hole center spacing: A=ø 50.8
Hole size: A=ø 7.0, B=ø 30.0



All measurements are listed in millimeters [inches], unless noted otherwise.

LMB Sealed Right-Angle Bracket

Model	Description	Construction	
LMB30RA	Direct-Mount Models: Bracket kit with base, 30 mm adapter, set screw, fasteners, o-rings, and gaskets	Black polycarbonate	
LMB30RAC		Gray polycarbonate	
LMBE12RA	Pipe-Mount Models: Bracket kit with base, ½-14 pipe adapter, set screw, fasteners, o-rings, and gaskets. For use with stand-off pipe (listed and sold separately)	Black polycarbonate	
LMBE12RAC		Gray polycarbonate	

Elevated Mount System

Model	Features	Components
SA-M30TE12 - Black Acetal	<ul style="list-style-type: none"> • Streamlined black acetal or white UHMW stand-off pipe adapter/cover • Connects between 30 mm light base and ½ in. NPSM/ DN15 pipe • Mounting hardware included 	
SA-M30TE12C - White UHMW		

Model			Features	Components
Polished 304 Stainless Steel	Black Anodized Aluminum	Clear Anodized Aluminum	<ul style="list-style-type: none"> Elevated-use stand-off pipe (½ in. NPSM/DN15) Polished 304 stainless steel, black anodized aluminum, or clear anodized aluminum surface ½ in. NPT thread at both ends Compatible with most industrial environments 	
SOP-E12-150SS 150 mm (6 in) long	SOP-E12-150A 150 mm (6 in) long	SOP-E12-150AC 150 mm (6 in) long		
SOP-E12-300SS 300 mm (12 in) long	SOP-E12-300A 300 mm (12 in) long	SOP-E12-300AC 300 mm (12 in) long		
SOP-E12-900SS 900 mm (36 in) long	SOP-E12-900A 900 mm (36 in) long	SOP-E12-900AC 900 mm (36 in) long		
SA-E12M30 - Black Acetal			<ul style="list-style-type: none"> Streamlined black acetal or white UHMW mounting base adapter/cover Connects between ½ in. NPSM/DN15 pipe and 30 mm (1-3/16 in) drilled hole Mounting hardware included 	
SA-E12M30C - White UHMW				

Pipe Mounting Flange

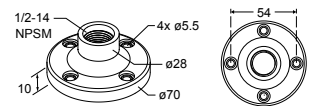
Pipe Mounting Flange			
Model	Features	Construction	
SA-F12	<ul style="list-style-type: none"> For use elevated stand-off pipes (½ in, NPSM/DN15) M5 mounting hardware and nitrile gasket included 	Die-cast zinc base with black paint	

Banner Engineering Corp. Limited Warranty

Banner Engineering Corp. warrants its products to be free from defects in material and workmanship for one year following the date of shipment. Banner Engineering Corp. will repair or replace, free of charge, any product of its manufacture which, at the time it is returned to the factory, is found to have been defective during the warranty period. This warranty does not cover damage or liability for misuse, abuse, or the improper application or installation of the Banner product.

THIS LIMITED WARRANTY IS EXCLUSIVE AND IN LIEU OF ALL OTHER WARRANTIES WHETHER EXPRESS OR IMPLIED (INCLUDING, WITHOUT LIMITATION, ANY WARRANTY OF MERCHANTABILITY OR FITNESS FOR A PARTICULAR PURPOSE), AND WHETHER ARISING UNDER COURSE OF PERFORMANCE, COURSE OF DEALING OR TRADE USAGE.

This Warranty is exclusive and limited to repair or, at the discretion of Banner Engineering Corp., replacement. IN NO EVENT SHALL BANNER ENGINEERING CORP. BE LIABLE TO BUYER OR ANY OTHER PERSON OR ENTITY FOR ANY EXTRA COSTS, EXPENSES, LOSSES, LOSS OF PROFITS, OR ANY INCIDENTAL, CONSEQUENTIAL OR SPECIAL DAMAGES RESULTING FROM ANY PRODUCT DEFECT OR FROM THE USE OR INABILITY TO USE THE PRODUCT, WHETHER ARISING IN CONTRACT OR WARRANTY, STATUTE, TORT, STRICT LIABILITY, NEGLIGENCE, OR OTHERWISE.

Banner Engineering Corp. reserves the right to change, modify or improve the design of the product without assuming any obligations or liabilities relating to any product previously manufactured by Banner Engineering Corp. Any misuse, abuse, or improper application or installation of this product or use of the product for personal protection applications when the product is identified as not intended for such purposes will void the product warranty. Any modifications to this product without prior express approval by Banner Engineering Corp will void the product warranties. All specifications published in this document are subject to change; Banner reserves the right to modify product specifications or update documentation at any time. Specifications and product information in English supersede that which is provided in any other language. For the most recent version of any documentation, refer to:

www.bannerengineering.com.