

# ST1-MANIFOLD-FC

## Flow Computer



## Proprietary Notice

The information contained in this publication is derived in part from proprietary and patent data. This information has been prepared for the expressed purpose of assisting operating and maintenance personnel in the efficient use of the instrument described herein. Publication of this information does not convey any rights to use or reproduce it or to use for any purpose other than in connection with the installation, operation and maintenance of the equipment described herein.

Copyright 1999  
Printed in USA. All Rights Reserved.



## WARNING!

This instrument contains electronic components that are susceptible to damage by static electricity. Proper handling\* procedures must be observed during the removal, installation, or handling of internal circuit boards or devices.

### \*Handling Procedure

1. Power to unit must be removed.
2. Personnel must be grounded, via wrist strap or other safe, suitable means, before any printed circuit board or other internal device is installed, removed or adjusted.
3. Printed circuit boards must be transported in a conductive bag or other conductive container. Boards must not be removed from protective enclosure until the immediate time of installation. Removed boards must be placed immediately in protective container for transport, storage, or return to factory.

### Comments

This instrument is not unique in its content of ESD (electrostatic discharge) sensitive components. Most modern electronic designs contain components that utilize metal oxide technology (NMOS, CMOS, etc.). Experience has proven that even small amounts of static electricity can damage or destroy these devices. Damaged components, even though they appear to function properly, may exhibit early failure.



## SAFETY INSTRUCTIONS

The following instructions must be observed.

- This instrument was designed and is checked in accordance with regulations in force EN 60950 ("Safety of information technology equipment, including electrical business equipment"). A hazardous situation may occur if this instrument is not used for its intended purpose or is used incorrectly. Please note operating instructions provided in this manual.
  - The instrument must be installed, operated and maintained by personnel who have been properly trained. Personnel must read and understand this manual prior to installation and operation of the instrument.
  - This instrument is internally fused. Replace the internal fuse with the following specified type and rating only:

| <b>Input Power</b> | <b>Recommended Fuse</b> |
|--------------------|-------------------------|
| 115 VAC            | 160 mA slow blow fuse   |
| 230 VAC            | 80 mA slow blow fuse    |
| 12-24 VDC          | 800 mA slow blow fuse   |
- Disconnect power supply before replacing fuse!**
- The manufacturer assumes no liability for damage caused by incorrect use of the instrument or for modifications or changes made to the instrument.

## Symbols Used On Unit

| <u>Number</u> | <u>Symbol</u> | <u>Publication</u>  | <u>Description</u>                                                                                                           |
|---------------|---------------|---------------------|------------------------------------------------------------------------------------------------------------------------------|
| 1             | ==            | IEC 417, No. 5031   | Direct current                                                                                                               |
| 2             |               | IEC 417, No. 5172   | Equipment protected throughout by DOUBLE INSULATION or REINFORCED INSULATION (equivalent to Class II of IEC 536—see annex H) |
| 3             |               | ISO 3864, No. B.3.1 | Caution (refer to accompanying documents)                                                                                    |

## Technical Improvements

- The manufacturer reserves the right to modify technical data without prior notice.

# CONTENTS

## 1. DESCRIPTION

|                           |   |
|---------------------------|---|
| 1.1 Unit Description..... | 1 |
| 1.2 Unit Features.....    | 1 |
| 1.3 Specifications.....   | 2 |

## 2. INSTALLATION

|                                  |   |
|----------------------------------|---|
| 2.1 General Mounting Hints ..... | 6 |
| 2.2 Mounting Diagrams .....      | 6 |

## 3. APPLICATIONS

|                                            |   |
|--------------------------------------------|---|
| 3.1 Manifold Liquid Volume .....           | 7 |
| 3.2 Manifold Corrected Liquid Volume ..... | 8 |
| 3.3 Manifold Liquid Mass .....             | 9 |

## 4. WIRING

|                                     |    |
|-------------------------------------|----|
| 4.1 Typical Wiring.....             | 10 |
| 4.2 Wiring In Hazardous Areas ..... | 11 |

## 5. UNIT OPERATION

|                                                             |    |
|-------------------------------------------------------------|----|
| 5.1 Front Panel Operation Concept for Run Mode.....         | 12 |
| 5.2 General Operation.....                                  | 13 |
| 5.3 Ratemeter/Totalizer Operation .....                     | 13 |
| 5.3.1 Password Protection for Rate/Total mode .....         | 13 |
| 5.3.2 Relay Operation in Rate/Total mode.....               | 13 |
| 5.3.3 Pulse Output in Rate/Total mode .....                 | 13 |
| 5.3.4 Analog Output in Rate/Total mode .....                | 14 |
| 5.3.5 RS-232 Serial Port Operation in Rate/Total mode ..... | 14 |
| 5.3.6 RS-485 Serial Port Operation in Rate/Total mode ..... | 14 |

## 6. PROGRAMMING

|                                                          |    |
|----------------------------------------------------------|----|
| 6.1 Front Panel Operation Concept for Program Mode ..... | 15 |
| 6.2 Setup Menus.....                                     | 16 |
| 6.3 Setup Sub-Menus .....                                | 17 |
| 6.3.1 SELECT FLOW EQUATION .....                         | 17 |
| 6.3.2 SETUP INDICATORS (Total).....                      | 17 |
| 6.3.3 SETUP INDICATORS (Density).....                    | 17 |
| 6.3.4 SETUP INDICATORS (Rate) .....                      | 18 |
| 6.3.5 SETUP INDICATORS (Temperature) .....               | 18 |
| 6.3.6 SETUP FLOW INPUT .....                             | 19 |
| 6.3.7 SETUP AUX1 INPUT .....                             | 21 |
| 6.3.8 SETUP AUX2 INPUT .....                             | 22 |
| 6.3.9 SET FLUID PROPERTIES .....                         | 23 |
| 6.3.10 SETUP PULSE OUTPUT .....                          | 24 |
| 6.3.11 SETUP ANALOG OUTPUT.....                          | 24 |
| 6.3.12 SETUP RELAYS .....                                | 25 |
| 6.3.13 SETUP CONTROL INPUTS .....                        | 27 |
| 6.3.14 SETUP REALTIME CLOCK(Time).....                   | 28 |
| 6.3.15 SETUP REALTIME CLOCK(Date).....                   | 28 |
| 6.3.16 SERIAL USAGE (RS-232/485) .....                   | 29 |
| 6.3.17 SERIAL USAGE (Modem Options).....                 | 29 |
| 6.3.18 SET DATALOG/PRINT(Configure) .....                | 30 |
| 6.3.19 SET DATALOG/PRINT (Select_list).....              | 31 |
| 6.3.20 ADMINISTRATIVE SETUP .....                        | 31 |
| 6.3.21 SETUP NETWORK CARD .....                          | 32 |

## 7. PRINCIPLE OF OPERATION

|                                                     |    |
|-----------------------------------------------------|----|
| 7.1 General .....                                   | 33 |
| 7.2 Flow Equations.....                             | 33 |
| 7.3 Calculating the Expansion Factor .....          | 36 |
| 7.4 Computation of Viscosity Coef. A and B.....     | 37 |
| 7.5 Linearization Table .....                       | 38 |
| 7.5.1 Linearization Table General Information ..... | 38 |
| 7.5.2 Linearization Table for Pulse Inputs.....     | 38 |
| 7.5.3 Linearization Table Interpolation .....       | 38 |
| 7.6 Universal Viscosity Curve (UVC) .....           | 38 |
| 7.7 Strouhal Roshko Curve (StRo).....               | 38 |

# CONTENTS

## 8. TEST, SERVICE and MAINTENANCE

|                                             |    |
|---------------------------------------------|----|
| 8.1 Test Menus .....                        | 39 |
| 8.2 Test Sub-Menus .....                    | 40 |
| 8.2.1 Audit Trail .....                     | 40 |
| 8.2.2 Error History .....                   | 40 |
| 8.2.3 Print System Setup .....              | 40 |
| 8.2.4 Keypad test .....                     | 41 |
| 8.2.5 Display test .....                    | 41 |
| 8.2.6 Calibrate Aux1 0mA .....              | 42 |
| 8.2.7 Calibrate Aux1 20mA .....             | 42 |
| 8.2.8 Calibrate Aux2 0mA .....              | 43 |
| 8.2.9 Calibrate Aux2 20mA .....             | 43 |
| 8.2.10 Calibrate Thermistor: 100 Ohms ..... | 44 |
| 8.2.11 Calibrate Thermistor: Open .....     | 44 |
| 8.2.12 Calibrate Aux2 0V .....              | 45 |
| 8.2.13 Calibrate Aux2 10V .....             | 45 |
| 8.2.14 Calibrate 100 ohm RTD .....          | 45 |
| 8.2.15 Calibrate 4mA Out .....              | 46 |
| 8.2.16 Calibrate 20mA Out .....             | 46 |
| 8.2.17 Analog In Test .....                 | 46 |
| 8.2.18 Pulse input test .....               | 47 |
| 8.2.19 Analog out test .....                | 47 |
| 8.2.20 Excitation out test .....            | 47 |
| 8.2.21 Pulse out test .....                 | 48 |
| 8.2.22 Relay test .....                     | 48 |
| 8.2.23 Control input test .....             | 48 |
| 8.2.24 Battery Voltage test .....           | 49 |
| 8.2.25 Data logger utility .....            | 49 |
| 8.3 Internal Fuse Replacement .....         | 50 |

## 9. RS-232 SERIAL PORT

|                                                                |    |
|----------------------------------------------------------------|----|
| 9.1 RS-232 Serial Port Description .....                       | 51 |
| 9.2 Instrument Setup by PC Over Serial Port .....              | 51 |
| 9.3 Operation of Serial Communication Port with Printers ..... | 51 |
| 9.4 ST1-MANIFOLD-FC RS-232 Port Pinout .....                   | 51 |

## 10. RS-485 SERIAL PORT

|                                                           |    |
|-----------------------------------------------------------|----|
| 10.1 RS-485 Serial Port Description .....                 | 52 |
| 10.2 General .....                                        | 52 |
| 10.3 Operation of Serial Communication Port with PC ..... | 52 |
| 10.4 ST1-MANIFOLD-FC RS-485 Port Pinout .....             | 52 |

## 11. FLOW COMPUTER SETUP SOFTWARE

|                                                   |    |
|---------------------------------------------------|----|
| 11.1 System Requirements .....                    | 53 |
| 11.2 Cable and Wiring Requirements .....          | 53 |
| 11.3 Installation for Windows™ .....              | 53 |
| 11.4 Using the Flow Computer Setup Software ..... | 54 |
| 11.5 File Tab .....                               | 54 |
| 11.6 Setup Tab .....                              | 54 |
| 11.7 View Tab .....                               | 55 |
| 11.8 Misc. Tab .....                              | 55 |

## 12. GLOSSARY OF TERMS

|                            |    |
|----------------------------|----|
| 12 Glossary Of Terms ..... | 57 |
|----------------------------|----|

## 13. DIAGNOSIS AND TROUBLESHOOTING

|                                                           |    |
|-----------------------------------------------------------|----|
| 13.1 Response of ST1-MANIFOLD-FC on Error or Alarm: ..... | 60 |
| 13.2 Diagnosis Flow Chart and Troubleshooting .....       | 61 |
| 13.3 Error & Warning Messages: .....                      | 62 |
| 13.3.1 Sensor/Process Alarms .....                        | 62 |
| 13.3.2 Self Test Alarms .....                             | 63 |

|                                                  |    |
|--------------------------------------------------|----|
| <b>APPENDIX A</b> (FLUID PROPERTIES TABLE) ..... | 64 |
|--------------------------------------------------|----|

|                                       |    |
|---------------------------------------|----|
| <b>APPENDIX B</b> (Setup Menus) ..... | 65 |
|---------------------------------------|----|

|                                                     |    |
|-----------------------------------------------------|----|
| <b>APPENDIX C</b> (RS485 Modbus RTU Protocol) ..... | 66 |
|-----------------------------------------------------|----|

## Unit Description

### 1. Description

#### 1.1 Unit Description:

The piping layout for a flow measurement manifold is shown in figure-1. Such flow-meter manifolds are used to increase the flow measurement turn down range beyond that which can be satisfied by a single flowmeter. The system is automatic in operation and will decide the flow and display information being measured most accurately by either the High Range Flowmeter-1 (FM-1) or the Low Range Flowmeter-2 (FM-2) and control the bypass valve position.

The flow measurement manifold consists of:

- High flow range flowmeter (FM-1)
- Low flow range flowmeter (FM-2)
- Bypass valve (normally open, energize to close)
- Flow Measurement Instrument/Controller (ST1-Manifold-FC)
- Interconnecting piping
- Ancillary temperature measurement device(s)  
(as needed)

The principle of operation is that the flow is always measured by the larger flowmeter (FM-1). If the larger flowmeter indicates a flow rate measurement below its measurement range, a bypass valve is closed diverting all the fluid flow through the smaller flow meter (FM-2) where the measurement is then made. The operator will only see information based on the in-range meter.

In the case where the bypass valve is open, most of the flow is diverted around the smaller flowmeter (FM-2). The small portion of the fluid passing through the flowmeter may cause the meter to coast, but it will not be overranged.

**Figure-1**

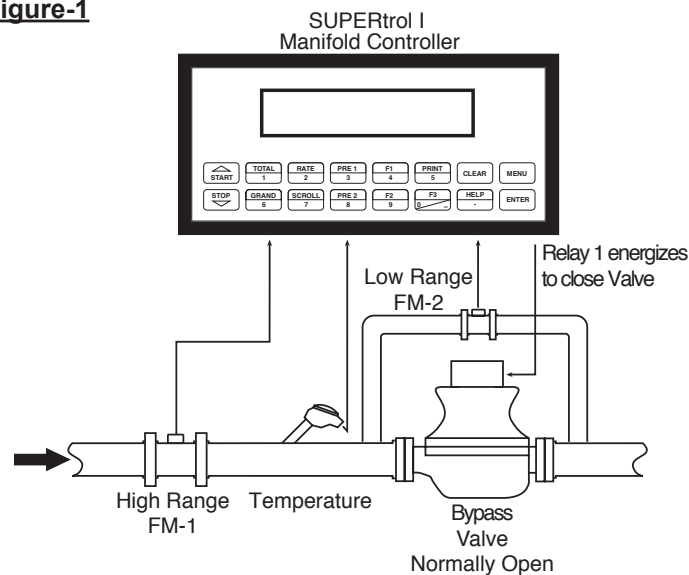

## Unit Features

### 1.2 Unit Features:

The ST1-MANIFOLD-FC Flow Computer offers the following features:

- Automatically Selects In-Range Meter for Best Accuracy
- Automatic Valve Control/Meter Selection
- Displays Rate/Total Through Manifold
- Supports Pulse Producing Flowmeters  
Turbine, Positive Displacement, Coriolis, Vortex
- Volume, Corrected Volume or Mass Equation
- Universal Viscosity Curve (UVC) and Strouhal/Roshko Advanced Linearization Methods
- API 2540 Equations for Petroleum Fluids
- User Entry of Fluid Properties (10 Selectable)
- Menu Selectable Hardware & Software Features
- Data Logging of Rate/Total Over Wide Range
- Two Line LCD or VFD Display
- Isolated Pulse and Analog Outputs Standard
- RS-232 Port Standard, RS-485 Optional
- Windows™ Setup Software
- DDE/OPC Server & HMI Software Available

### 1.3 Specifications:

#### Specifications:

##### Flow Meters and Computations

Meter Types: Supports pulse producing meters including: vortex, single rotor turbine, magnetic, PD flowmeter, Coriolis

Linearization: 40 point table, UVC table or Strouhal/Roshko

Computations: Volume, Corrected Volume & Mass  
Fluid Computations: Density, Temperature, Viscosity

##### Environmental

Operating Temperature: 0°C to +50°C

Storage Temperature: -40°C to +85 C

Humidity : 0-95% Non-condensing

Materials: U.L. approved

**Approvals:** CE Compliant, UL/CUL Listed

##### Display

Type: 2 lines of 20 characters, Blue VFD or Backlit LCD

Character Size: 0.2" nominal

User programmable label descriptors and units of measure

##### Keypad

Keypad Type: Membrane Keypad with 16 keys

Keypad Rating: Sealed to NEMA 4X

##### Enclosure

Size: See Dimensions

Depth behind panel: 6.5" including mating connector

Type: DIN

Materials: Plastic, UL94V-0, Flame retardant

Bezel: Textured per matt finish

##### Fluid Types

General Purpose, User entry of fluid properties for up to 10 fluids.

##### Real Time Clock

The ST1-Manifold-FC is equipped with a battery backed real time clock with display of time and date.

Format:

12 or 24 hour time display

Day, Month, Year date display

##### Excitation Voltage

Menu Selectable: 5, 12 or 24 VDC @ 100 mA (fault protected with self resetting fuse)

##### Relay Outputs

The relay outputs are menu assignable to (Individually for each relay) Low Rate Alarm, Hi Rate Alarm, Temperature, Density or General purpose warning (security).

Number of relays: 2 (4 optional)

Contact Style: Form C contacts

Contact Ratings: 5 amp, 240 VAC or 30 VDC

Capabilities: Alarm Delay, Setpoint, Hysteresis,

Duration

**NOTE:** Relay 1 is reserved for manifold control.

##### Power Input

The factory equipped power option is internally fused. An internal line to line filter capacitor and MOV are provided for added transient suppression.

110 VAC Power: 85 to 127 Vrms, 50/60 Hz

220 VAC Power: 170 to 276 Vrms, 50/60 Hz

DC Power:

12 VDC (10 to 14 VDC)

24 VDC (14 to 28 VDC)

Power Consumption:

AC: 11.0 VA (11W)

DC: 300 mA max.

##### Flow Inputs:

###### Pulse Inputs:

Number of Flow Inputs: 2, one for larger and one for smaller flowmeters

Input Impedance: 10 K $\Omega$  nominal

Pullup Resistance: 10 K $\Omega$  to 5 VDC (menu selectable)

Pull Down Resistance: 10 K $\Omega$  to common

Trigger Level: (menu selectable)

High Level Input

Logic On: 3 to 30 VDC

Logic Off: 0 to 1 VDC

Low Level Input (mag pickup)

Sensitivity:

10 mV or 100 mV

Minimum Count Speed:

Menu selectable: 1-99 seconds

Maximum Count Speed:

Menu Selectable: 40Hz, 3000Hz or 20 kHz

Overvoltage Protection: 50 VDC

##### Control Inputs

Switch Inputs are menu selectable for Reset, Lock, Inhibit, Alarm Acknowledge, Print, or Not Used.

Control Input Specifications

Number of Control Inputs: 3

Input Scan Rate: 10 scans per second

Logic 1: 4 - 30 VDC

Logic 0: 0 - 0.8 VDC

Input Impedance: 100 K $\Omega$

Control Activation:

Positive Edge or Pos. Level based on product definition for switch usage.

**Auxiliary / Compensation Inputs**

The auxiliary/compensation inputs are menu selectable for manifold temperature, small meter temperature or not used. These inputs are used for the compensated inputs when performing compensated flow calculations. They can also be used as a general purpose input for display and alarming.

Number of inputs: 2

Operation: Ratiometric

Accuracy: 0.02% FS at 20° C (current input)

Basic Measurement Resolution:  
16 bit

Update Rate: 1 update/sec minimum

Automatic Fault detection:

- Signal Over-range/under-range
- Current Loop Broken
- Fault mode to user defined default settings

Fault Protection:

- Reverse Polarity: No ill effects
- Over-Voltage Limit (Voltage Input): 50 VDC

Available Input Ranges

- Current (Two): 4-20 mA, 0-20 mA
- RTD: (One) 100 Ohm DIN RTD Standard Three Wire
- Thermistor (One) - Consult Factory

**Isolated Analog Output**

The analog output is menu assignable to correspond to the Manifold Rate/Total, Temperature, Computed Density.

Type: Isolated Current Sourcing

Available Ranges: 4-20 mA, 0-20 mA

Resolution: 12 bit

Accuracy: 0.05% FS at 20° C

Update Rate: 1 update/sec minimum

Temperature Drift: Less than 200 ppm/C

Maximum Load: 1000 ohms (at nominal line voltage)

Compliance Effect: Less than .05% Span

60 Hz rejection: 40 dB minimum

Calibration: Operator assisted Learn Mode

Averaging: User entry of damping constant to cause a smooth control action

**Isolated Pulse output**

The isolated pulse output is menu assignable to Manifold Total.

Pulse Output Form: Photo MOS Relay

Maximum On Current: 100 mA

Maximum Off Voltage: 30 VDC

Saturation Voltage: 1.0 VDC

Maximum Off Current: 0.1 mA

Pulse Duration: 10 mSec or 100 mSec (user selectable)

Pulse output buffer: 256

Fault Protection

- Reverse polarity: Shunt Diode

**Serial Communication**

The serial port can be used for printing, data recording, and/or communication with a computer.

RS-232:

Device ID: 01-99

Baud Rates: 300, 600, 1200, 2400, 4800, 9600, 19200

Parity: None, Odd, Even

Handshaking: None, Software, Hardware

Print Setup: Configurable print list and formatting

RS-485: (optional 2nd COM port)

Device ID: 01-247

Baud Rates: 2400, 4800, 9600, 19200

Parity: None, Odd, Even

Protocol: Modbus RTU (Half Duplex)

**Setup Diskette Capabilities**

Capabilities include: View Live Results Configure unit, Upload and Download to unit, Load and Save to file, Print Setup,

**Data Logging Capabilities**

Capabilities:

Permits unit to automatically gather data during use.

Data Log List:

User selectable: includes Large/Small Temperatures, Density, Viscosity, Large/Small and Manifold Ratemeters/Totalizers, Grand Totalizer, Time and Date, Fluid, Setpoint 1 & 2, Frequency 1 & 2, K-Factor 1 & 2.

Data Log Event Trigger:

selectable: includes interval, time of day, front key, external contact, end of batch

Data Log Format:

selectable: Printer format, Database CSV format

Data Transmission:

Selectable: Output may be transmitted immediately or held in data log for later polling

Remote Request Capabilities include:

Send data log, clear data log

**External Modem Support Capabilities:**

Compatibility: Hayes Compatible

Polling Capabilities:

Answers incoming calls, responds to requests for information of action

Call Out Capabilities:

Can initiate call on user selectable event condition, or upon error

Error Handling:

Supports multiple retry, automatic disconnect upon loss of line or remote inactivity

## Operating Mode

The Flow Computer can be thought of as making a series of measurements of the Flow1 and Flow2 flow and temperature sensors and then performing calculations to arrive at the in-range result(s) which is then updated periodically on the display. The analog output, the pulse output, and the alarm relays are also updated. The cycle then repeats itself.

**Step 1:** Update the measurements of input signals-  
Raw Input Measurements are made at each input using equations based on input signal type selected. The system notes the "out of range" input signal as an alarm condition. The unit alternates between Flow1 and Flow2 measurements.

**Step 2:** Compute the Flowing Fluid Parameters-  
The temperature, viscosity, and density equations are computed as needed based on the flow equation and input usage selected by the user.

**Step 3 :** Compute the Volumetric Flow-  
Uncompensated flow is the term given to the flow in volume units. The value is computed based on the flowmeter input type selected and augmented by any performance enhancing linearization that has been specified by the user. A decision is made to show either the large or small meter flow and the display of the manifold rate.

**Step 4:** Compute the Corrected Volume Flow at Reference Conditions-  
In the case of a corrected volume flow calculation, the Flow1, Flow2 and Manifold corrected volume flows are computed as required by the selected compensation equation.

**Step 5 :** Compute the Mass Flow-  
All required information is now available to compute the Flow1, Flow2 and Manifold mass flow rates as volume flow times reference density.

**Step 6:** Check Flow Alarms-  
The flow alarm functions have been assigned to either the large meter flow rate or temperatures during the setup of the instrument. A comparison is now made by comparing the current flow rates against the specified hi and low limits.

**Step 7:** Compute the Analog Output-  
This Manifold flow rate or Manifold total value is now used to compute the analog output.

**Step 8:** Compute the Manifold Flow Totals by Summation-  
A flow total increment is computed for the in-range totalizer. The totalizer format also includes provisions for total rollover.

**Step 9:** Total Preset Comparisons-  
The Manifold total associated with a preset function is then compared against the corresponding preset value and any required control actions taken.

**Step 10:** Pulse Output Service-  
The pulse output is next updated by scaling the Manifold total increment which has just been determined by the pulse output scaler and summing it to any residual pulse output amount.

**Step 11:** Update Display and Printer Output-  
The instrument finally runs a task to update the various table entries associated with the front panel display and serial outputs.

## Setup Mode

The setup mode is password protected by means of numeric operator and supervisor lock out codes established by the user. In addition, a secret, manufacturers numeric unlock entry sequence is available. A jumper on Control Input 3 can also prevent access.

The system also provides a minimum implementation of an "audit trail" which tracks significant setup changes to the unit. This feature is increasingly being found of benefit to users or simply required by Weights and Measurement Officials in systems used in commerce, trade, or "custody transfer" applications.

A software program is also available which runs on a PC using a RS-232 Serial for connection to the Flow Computer. Illustrative examples may be downloaded in this manner.

The setup mode has numerous subgrouping of parameters needed for flow calculations. There is a well conceived hierarchy to the setup parameter list. Selections made at the beginning of the setup affect offerings further down in the lists.

In the setup mode, the flow computer activates the correct setup variables based on the instrument configuration, the flow equation, and the hardware selections made for the compensation transmitter type, the flow transmitter type, and meter enhancements (linearization) options selected. All required setup parameters are enabled. All setup parameters not required are suppressed.

A help line prompt is provided for each entry. In addition a help message is available which may be accessed by depressing the "HELP" key.

Also note that in the setup mode are parameter selections which have preassigned industry standard values. The unit will assume these values unless they are modified by the user.

Most of the process input variables have available a "default" or emergency value which must be entered. These are the values that the unit assumes when a malfunction is determined to have occurred on the corresponding input.

It is possible to enter in a nominal constant value for temperature or density by placing the desired nominal value into both the lo and hi values. This is also a convenience when performing bench top tests without simulators.



**Maintenance (Test) Mode:**

The Maintenance Mode of the ST1-MANIFOLD-FC is the Test and Calibration Mode for the device. This mode provides a number of specialized utilities required for factory calibration, instrument checkout on start-up, and periodic calibration documentation.

A supervisor password is required to gain access to this specialized mode of operation. Normally quality, calibration, and maintenance personnel will find this mode of operation very useful. It is also useful for factory testing.

Many of these tests may be used during start-up of a new system. Inputs signals may be read, and output signals may be exercised to verify the electrical interconnects before the entire system is put on line.

The following action items may be performed in the Maintenance Mode:

- Print Calibration/Maintenance Report
- Examine Audit Trail
- Perform Keypad Checkout
- Perform Display Checkout
- Perform Pulse Input Checkout
- Perform Pulse Output Checkout
- Perform Control Input Checkout
- Perform Relay Output Checkout
- Perform Analog Input Checkout
- Perform Analog Output Checkout
- Calibrate Analog Inputs using the Learn Feature
- Calibrate Analog Output using the Learn Feature
- Battery Check
- Datalog Printing and Clearing

Note that a calibration of the analog input/output will advance the audit trail counters since it effects the accuracy of the system.

**RS-232 Serial Port**

The ST1-MANIFOLD-FC has a general purpose RS-232 Port which may be used for any one of the following purposes:

- Transaction Printing
- Periodic Printing of Datalog
- Print Internal Datalog
- Remote Metering by Modem (optional)
- Computer Communication Link
- Configuration by Computer
- Print System Setup
- Print Calibration/Malfunction History
- Remote Control

**Instrument Setup by PC's over Serial Port**

A Setup program is provided with the ST1-MANIFOLD-FC that enables the user to rapidly configure the ST1-MANIFOLD-FC using a Personnel Computer. Included in the setup software are common instrument applications which may be used as a starting point for your application. This permits the user to have an excellent starting point and helps speed the user through the instrument setup.

**Operation of Serial Communication Port with Printers**

ST1-MANIFOLD-FC's RS-232 channel supports a number of operating modes. One of these modes is intended to support operation with a printer in metering applications requiring transaction printing, data logging, and/or printing of calibration and maintenance reports.

For transaction printing, the user defines the items to be included in the printed document. The user can also select what initiates the transaction print generated as part of the setup of the instrument. The transaction document may be initiated via a front panel key depression, a remote contact closure.

In data logging, the user defines the items to be included in each data log as a print list. The user can also select when or how often he wishes a data log to be made. This is done during the setup of the instrument as either a time of day or as a time interval between logging. Data can be extracted with the *TrolLink* program.

The system setup and maintenance report lists all the instrument setup parameters and usage for the current instrument configuration. In addition, the Audit trail information is presented along with a status report listing any observed malfunctions which have not been corrected.

The user initiates the printing of this report at a designated point in the menu by pressing the print key on the front panel.

**Operation of Serial Port with Modems (optional)**

The ST1-MANIFOLD-FC RS-232 channel supports a number of operating modes. One of these modes is intended to support operation with a modem in remote metering applications.

An external modem is intentionally being used with the ST1-MANIFOLD-FC. This permits use with the variety of modem standards worldwide while avoiding the specialized approvals required for equipment that is deemed to fall under the category of telecommunication equipment.

In the modem mode, the ST1-MANIFOLD-FC is assumed to be operating in a remote metering role. The ST1-MANIFOLD-FC will support key items in the Hayes Compatible "AT" Command Set. In this role, the ST1-MANIFOLD-FC will have the following special abilities:

0. Monitor the modem status as a task of the system
1. Instruct the modem to answer an incoming call ATA
2. Respond to the calling modem at the programmed baud rate and protocol
3. Terminate the telephone connection in event the connection is lost.

In addition, the ST1-MANIFOLD-FC is capable of initiating a call to a designated telephone number in the event of a metering malfunction. Consult factory for additional details on remote metering software.

## 2. Installation

### General Mounting Hints

#### 2.1 General Mounting Hints:

The ST1-MANIFOLD-FC Flow Computer should be located in an area with a clean, dry atmosphere which is relatively free of shock and vibration. The unit is installed in a 5.43" (138mm) wide by 2.68" (68mm) high panel cutout. (see Mounting Dimensions) To mount the Flow Computer, proceed as follows:

### Mounting Procedure

- a. Prepare the panel opening.
- b. Slide the unit through the panel cutout until the it touches the panel.
- c. Install the screws (provided) in the mounting bracket and slip the bracket over the rear of the case until it snaps in place.
- d. Tighten the screws firmly to attach the bezel to the panel. 3 in. lb. of torque must be applied and the bezel must be parallel to the panel.

#### Termination Connectors:

- Minimum Wire Gauge: 22 AWG
- Maximum Wire Gauge: 14 AWG
- Voltage/current limits are limited by unit specifications.

#### Permanently Connected Equipment:

##### UL 3101-1, Section 6.12.2.1 specifies that:

- A switch or circuit breaker shall be included in the building installation;
- It shall be in close proximity to the equipment and within easy reach of the OPERATOR;
- It shall be marked as the disconnecting device for the equipment.

Ensure that the switch or circuit breaker chosen is suitable for the power requirements of the unit.



#### NOTE:

##### Bezel Adaptor Instructions:

To provide protection type IP65/NEMA 4X, the unit has to be mounted with the bezel adaptor and the gasket (supplied with the mounting kit). The bezel has to be glued to the unit with silicon (see Figure below)

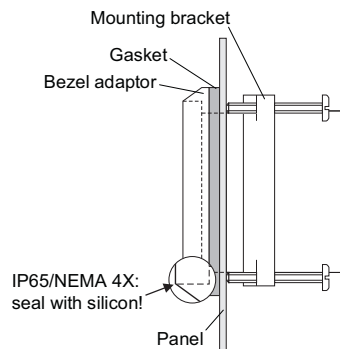

#### 2.2 Mounting Diagrams:

|                                                                                                                                                              |                                                                                                                                                            |
|--------------------------------------------------------------------------------------------------------------------------------------------------------------|------------------------------------------------------------------------------------------------------------------------------------------------------------|
| <h4 style="text-align: center;">Standard Mounting</h4> <p style="text-align: center;">Flow Computer<br/>Mounting Bracket</p>                                 | <h4 style="text-align: center;">Bezel Kit Mounting</h4> <p style="text-align: center;">Flow Computer<br/>Bezel Adaptor<br/>Gasket<br/>Mounting Bracket</p> |
| <h4>Dimensions</h4> <p style="text-align: center;">Dotted Line Shows Optional Bezel Kit</p> <p style="text-align: center;">Dimensions are in inches (mm)</p> |                                                                                                                                                            |

### 3. Applications

#### Liquid Volume

#### 3.1 Liquid Volume

**Measurements:**

Flowmeter sensors measure the actual volume in the Flow1 and Flow2 liquid lines. A temperature sensor can also be installed to correct for UVC or STRO linearization of turbine flowmeters.

**Calculations:**

- Volume flow is calculated using the flowmeter frequency output and the user entered K-Factor.  
 $MANIFOLD\ FLOW = FLOW1\ IF\ FLOW1 > PRE1$   
 $MANIFOLD\ FLOW = FLOW2\ IF\ FLOW1 < PRE1 - HYS$

**Output Results:**

- Display Results  
 Flow1, Flow2, Manifold Flow Rates, Total, Resettable Total, Non-Resettable Total
- Analog Output  
 Manifold Rate or Total
- Pulse Output  
 Manifold Total
- Relay Outputs  
 Manifold Rate or Total Alarms

**Applications:**

The Flow Computer can monitor actual volume flow and total of any liquid. (Common applications include automotive and aerospace testing) Flow alarms are provided via relays and datalogging is available via analog (4-20mA) and serial outputs.

#### Liquid Volume Illustration

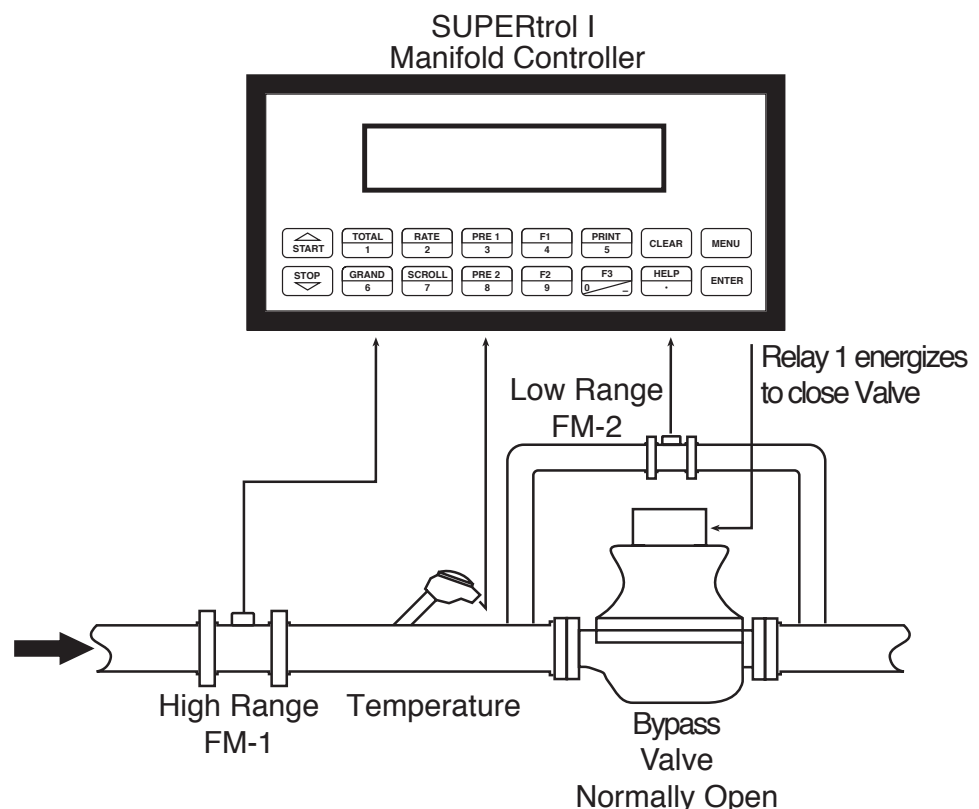

#### Calculations

Pulse Input; Average K-Factor

$$\text{Flow1 or Flow2 Volume Flow} = \frac{\text{input frequency} \cdot \text{time scale factor}}{\text{K-Factor}}$$

$MANIFOLD\ FLOW = FLOW1\ IF\ FLOW1 > PRE1$   
 $MANIFOLD\ FLOW = FLOW2\ IF\ FLOW1 < PRE1 - HYS$

**Corrected Liquid Volume**

**3.2 Corrected Liquid Volume**

**Measurements:**

Flowmeter sensors measure the actual volume in the liquid manifold lines. A temperature sensor is installed to correct for liquid thermal fluid expansion as well as optional UVC or STRO linearization of turbine flowmeters.

**Calculations:**

- Flow1 and Flow2 Corrected Manifold Volume at a base or reference condition is calculated using the respective flow and temperature inputs as well as the thermal fluid expansion coefficient stored in the flow computer. Use the "SET FLUID PROPERTIES" submenu to define reference temperature and density values for standard condition(s).

$$\text{MANIFOLD FLOW} = \text{FLOW1 IF FLOW1} > \text{PRE1}$$

$$\text{MANIFOLD FLOW} = \text{FLOW2 IF FLOW1} < \text{PRE1} - \text{HYS}$$

**Output Results:**

- Display Results  
Flow1, Flow2, Corrected Manifold Flow Rate, Resettable Total, Non-Resettable Total, Temperature, Density
- Analog Output  
Corrected Manifold Rate or Total
- Pulse Output  
Corrected Manifold Total
- Relay Outputs  
Corrected Manifold Rate , Total or Temperature Alarms

**Applications:**

Monitoring corrected manifold volume flow and total of any liquid. (Common applications include automotive and aerospace testing) Flow alarms are provided via relays and datalogging is available via analog (4-20mA) and serial outputs.

**Corrected Liquid Volume Illustration**

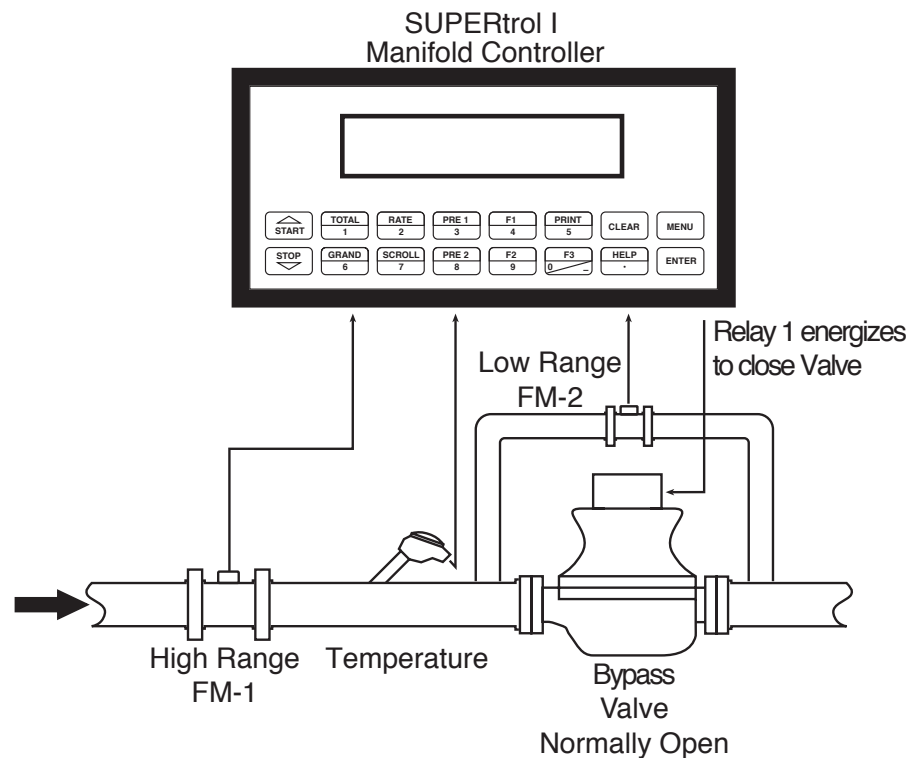

**Calculations**

Flow1 and Flow2 Volume Flows

As calculated in section 3.1

Corrected Volume Flow (Temp. Transmitter)

Manifold Corrected Vol. Flow =  

$$\text{manifold vol. flow} * (1 - \text{Therm.Exp.Coef.} * (\text{Tf} - \text{Tref}))^2$$
 (See also API 2540 equation)

**Liquid Mass**

**3.3 Liquid Mass**

**Measurements:**

Flow1 and Flow2 actual volumes are measured by the respective flow element in the manifold. Flow1 and Flow2 temperatures are measured by the Flow1 and Flow2 temperature transmitters.

**Calculations:**

- The density and mass flow are measured directly or calculated using the reference density and the thermal expansion coefficient of the liquid as well as optional UVC or STRO linearization of turbine flowmeters (see "SET FLUID PROPERTIES" submenu)

**Output Results:**

- Display Results  
Flow1, Flow2, Manifold Mass Flow Rate, Resettable Total, Non-Resettable Total, Temperature, Density
- Analog Output  
Manifold Mass Rate, Total
- Pulse Output  
Manifold Mass Total
- Relay Outputs  
Manifold Mass Flow Rate, Total, Temperature or Alarms

**Applications:**

Monitoring of the mass flow and total of any liquid. (Common applications include automotive and aerospace testing). Flow alarms are provided via relays and datalogging is available via analog (4-20mA) and serial outputs.

**Liquid Mass Illustration**

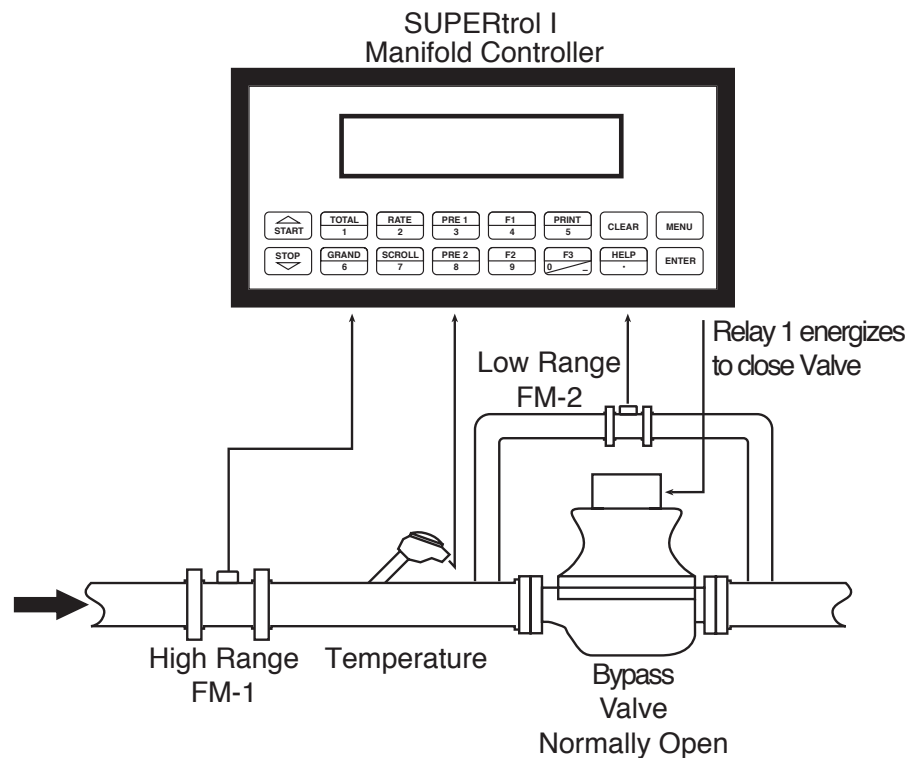

**Calculations**

Flow1 and Flow2 Volume Flows

As calculated in section 3.1

Mass Flow

Manifold Mass Flow = (Manifold volume flow rate \* density)

## 4 WIRING

### 4.1 Typical Wiring:

#### Flow Meters

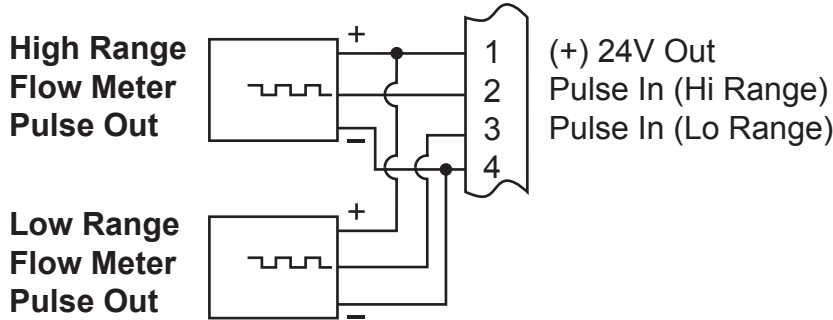

#### Temperature Transmitter 1

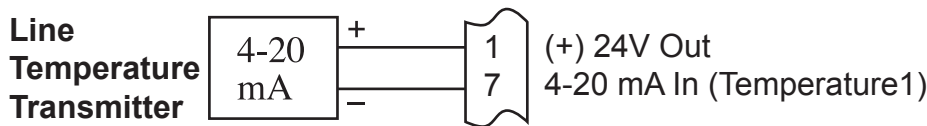

#### Temperature Transmitter 2

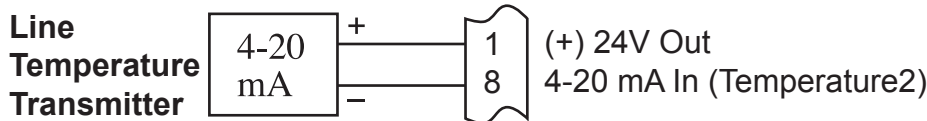

#### Bypass Control Valve

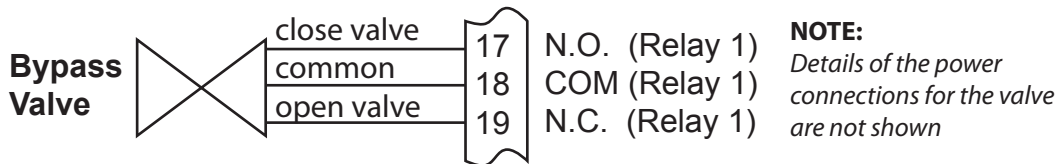

**NOTE** Bypass valve should fail open on loss of power or if computations are paused.

|    |                     |            |             |
|----|---------------------|------------|-------------|
| 1  | DC OUTPUT           |            | FLOW        |
| 2  | PULSE IN 1 (Flow 1) |            | IN          |
| 3  | PULSE IN 2 (Flow 2) |            |             |
| 4  | COMMON              |            |             |
| 5  | -----               | Vin +      | Temp. 2     |
| 6  | RTD EXCIT +         | Thermistor | Temp. 1     |
| 7  | RTD SENS +          | lin +      | Temp. 1     |
| 8  | RTD SENS -          | lin +      | Temp. 2     |
| 9  | CNTR IN 1           |            |             |
| 10 | CNTR IN 2           |            | SEE USER    |
| 11 | CNTR IN 3           |            | MANUAL      |
| 12 | COMMON              |            |             |
| 13 | PULSE OUTPUT +      |            |             |
| 14 | PULSE OUTPUT -      |            |             |
| 15 | ANALOG OUTPUT +     |            | 4-20 mA     |
| 16 | ANALOG OUTPUT -     |            |             |
| 17 | NC                  | RLY1       | 25 NC       |
| 18 | COM                 | Valve      | 26 COM RLY3 |
| 19 | NO                  | Control    | 27 NO       |
| 20 | NC                  |            | 28 NC       |
| 21 | COM                 | RLY2       | 29 COM RLY4 |
| 22 | NO                  |            | 30 NO       |
| 23 | AC LINE             | DC +       | POWER IN    |
| 24 | AC LINE             | DC -       |             |

Specify available power when ordering

Relays 3 and 4 are optional

4.2 Wiring In Hazardous Areas:

Examples using MLT787S+ Barrier

**Flow1**  
**Temperature Input**  
**(4-20mA Transmitter)**

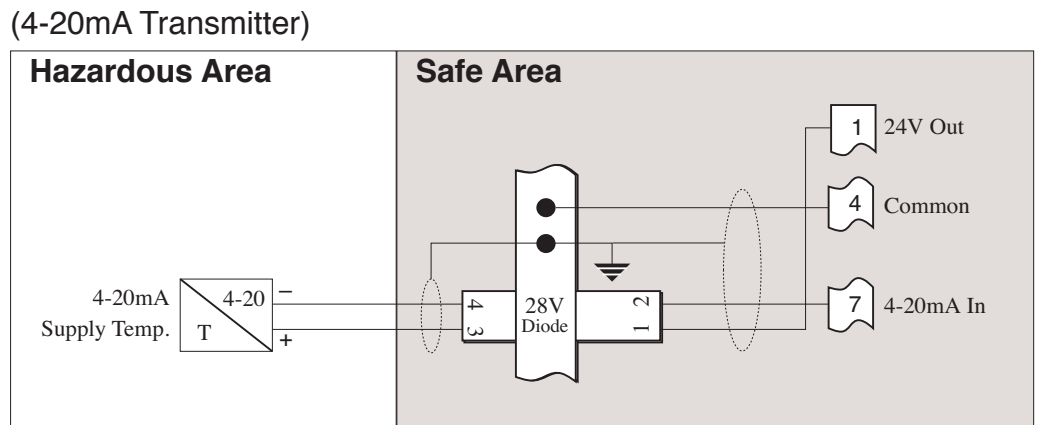

**Flow2**  
**Temperature Input**  
**(4-20mA Transmitter)**

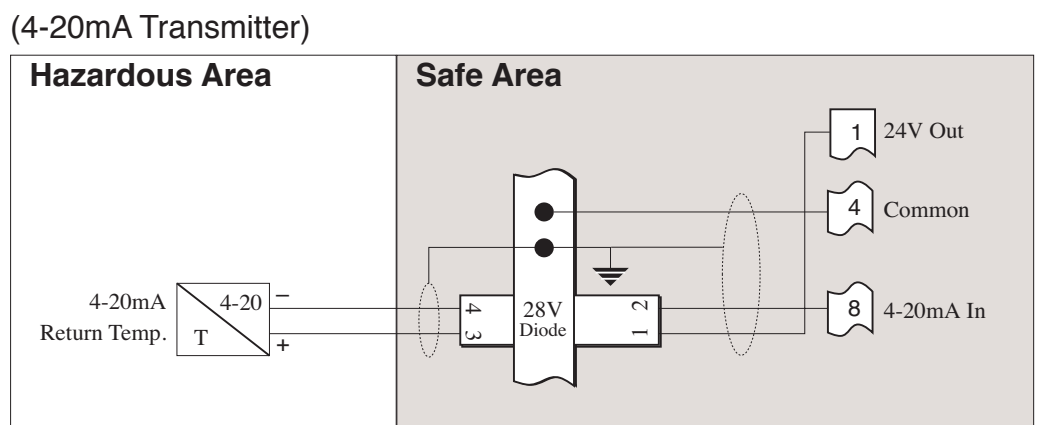

## 5. UNIT OPERATION

### 5.1 Front Panel Operation Concept for Run Mode

The ST1-MANIFOLD-FC is fully programmable through the front panel. Please review the following usage summary before attempting to use the instrument.

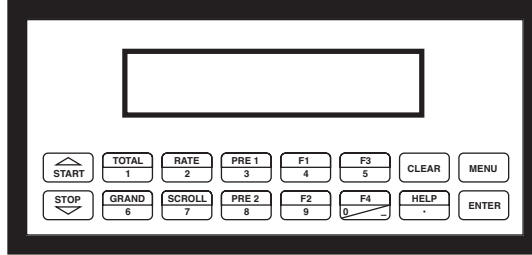

#### How To Use On-Line Help

#### HELP

On-line help is provided to assist the operator in using this product. The help is available during RUN and SETUP modes simply by pressing the HELP key. The HELP key is used to enter decimals when entering numeric values.

#### How To Select Fluid

#### SELECT FLUID

Press F1 and ENTER simultaneously. Press the  $\Delta$   $\nabla$  keys to view fluid name. Press ENTER to select fluid.

#### How To Use Function Keys

#### FUNCTION KEYS

In the RUN mode, several keys have a special, direct access feature, to display an item of interest (i.e. MANIFOLD RATE, TOTAL, etc.). Press the key to view your choice. These keys and the F1, F2 & F4 keys allow the operator to view more than one piece of information. Slowly pressing these keys additional times will display additional information. Example: Rate Key shows Manifold Rate, Flow1 Rate, Flow2 Rate.

#### How To Clear The Manifold Total, Flow1 Total, Flow2 Total

#### CLEARING TOTALIZERS

To clear the totals, you must press the TOTAL Function Key quickly 4 times until you see a display called "CLEAR TOTAL". Then press CLEAR to reset Manifold, Flow1 and Flow2 totals. You will be asked to verify this action. The operator will be prompted to enter password if the unit is locked.

#### How To Clear The Manifold Grand Total, Flow1 Grand Total, Flow2 Grand Total

#### CLEARING GRAND TOTALS

To clear the grand totals, you must press the GRAND Function Key quickly 4 times until you see a display called "CLEAR GRAND TOTAL". Then press CLEAR to reset Manifold, Flow1 and Flow2 grand totals. You will be asked to verify this action. The supervisor will be prompted to enter the supervisor password if the unit is locked.

#### How To Enter Presets

#### PRESET KEYS

In the RUN mode, PRE 1 & PRE 2 keys are used to view and/or change the preset setpoints. To view the Presets, simply press the desired Preset key. Rapidly press the Preset keys 3 times, then press the Clear key for direct editing of the preset setpoints. PRE1 is used to select the switchover point between flowmeter 1 and flowmeter 2.

#### How To Create a Scroll List

#### SCROLL

Rapidly press the Scroll key three times to setup a display list. Press the CLEAR key to remove old scroll list. Press the function key F3 for the item you wish to add. Use the  $\Delta$   $\nabla$  keys to assign the line or to remove the selection.

#### How To Use The F3 Print Key

#### PRINT

The PRINT key is used to print on demand. When the F3 Print key is pressed, a user defined list of data (MANIFOLD TOTAL, MANIFOLD RATE, PRE 1, etc.) is sent to the RS-232 port. A timed message of "PRINTING" will be displayed to acknowledge the print request.

#### How To Use The Menu Key

#### MENU KEY

The MENU key is used to enter the Setup and Test modes. Press the MENU key to enter the Setup and Test modes. (See section 6 for Setup mode, section 8 for Test mode). The MENU key is also used as "escape" in Setup and Test Programming. Pressing the MENU key while programming in the Sub-Menu groups will backup the display to that Sub-Menu group heading. Pressing the MENU key while viewing the Sub-Menu groups will backup the display to the Top Level Menu.

#### How To Acknowledge Alarms

#### ACKNOWLEDGING ALARMS

Most alarm messages are self-clearing. Press the ENTER key to acknowledge and clear alarms.

NOTE: Some keys and functions are password protected. Enter the password to gain access. The passwords are factory set as follows:

Operator = 0                      Supervisor = 2000

Alarms in the Alarm Error History will reassert themselves when power is cycled. Clear the alarm history to prevent this from happening once all problems are solved.



## General Operation

### 5.2 General Operation

The ST1-MANIFOLD-FC flowmeter manifold controller is a special flow instrument intended to accept inputs from two pulse output flowmeters, one larger and one smaller, and which also controls the bypass valve. The instrument setup contains the calibration information for both flowmeters as well as the manifold flow rate switch setpoint and hysteresis.

The instrument operation may be summarized as follows:

1. Measure the flow rate signal from the high range flowmeter (FM-1)
2. Decides if the flowrate in FM1 is below the user specified preset setpoint low flow rate for the high range flowmeter (FM-1):  
If yes, close the bypass valve  
If no, open the bypass valve
3. If the bypass valve is open display flowrate and totalization based on the high range flowmeter (FM-1).  
If the bypass valve is closed, display flowrate and total based on the low range flowmeter (FM-2).
4. Analog Output, Relays, Pulse Output, etc... is based on which ever flowmeter is active at the time.

This special version of the ST1 has two pulse, flow input channels.

**Figure-1**

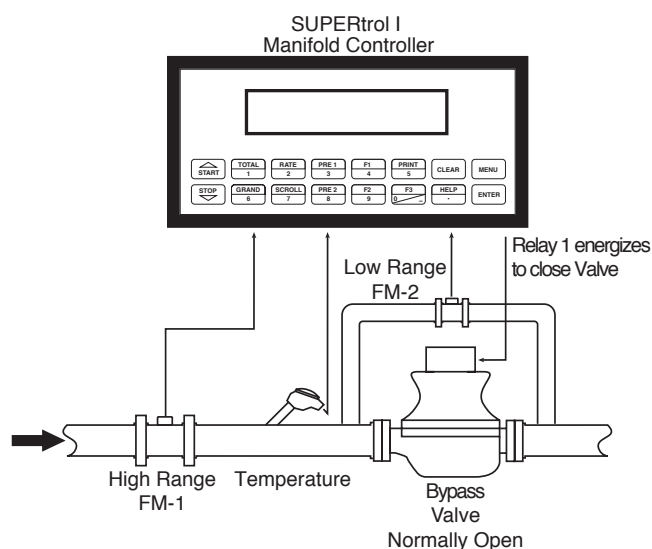

## Rate/Total Operation

### 5.3 Ratemeter/Totalizer Operation

The Ratemeter/Totalizer mode is used primarily to monitor Manifold flowrate and Manifold accumulated total. The relays can be used to trigger flow, total or temperature alarms. Relay 1 is reserved to control the bypass valve

## Password Protection (Rate/Total mode)

### 5.3.1 Password Protection for Rate/Total mode

After an Operator and/or Supervisor Password is entered in the setup mode (see section 6.4.23, ADMINISTRATIVE SETUP submenu), the unit will be locked. The unit will prompt the user for the password when trying to perform the following functions:

- Clear Total
- Clear Grand Total
- Enter Menu
- Edit Preset 1 (PRE 1 Key)
- Edit Preset 2 (PRE 2 Key)

The Supervisor password should be reserved for supervisors. The Supervisor password will allow access to restricted areas of the Setup and Test menus.

## Relay Operation (Rate/Total mode)

### 5.3.2 Relay Operation in Rate/Total mode

Up to four relays are available (two standard) for bypass valve control and alarm outputs. The relays 2, 3 and 4 can be assigned to trip according to Manifold Rate, Manifold Total or alarms. The relays can be programmed for low or high alarms. Preset 1 (RLY1) and Preset 2 (RLY2) are easily accessible by pressing the PRE 1 or PRE 2 key on the front panel. Preset 3 and Preset 4 are accessible only through the setup menu. Relays 3 and 4 can be used for temperature alarms and general system alarms.

## Pulse Output (Rate/Total mode)

### 5.3.3 Pulse Output in Rate/Total mode

The isolated pulse output (open collector) is menu assignable to Manifold Total or None. The total will be implied by the Flow Equation selected: Volume, Corrected Volume or Mass. The pulse output duration can be set for 10mS (50 Hz max) or 100mS (5 Hz max). A pulse output scale factor (pulse value) can be set to scale the pulse output. The pulse output is ideal for connecting to remote totalizers or other devices such as a PLC. See section 1.3 for electrical specifications.

### Analog Output (Rate/Total mode)

#### 5.3.4 Analog Output in Rate/Total mode

The analog output is menu assignable to correspond to the Manifold Volume Rate, Manifold Corrected Volume Rate or Manifold Mass Rate, Manifold Volume Total or Manifold Corrected Volume Total or Manifold Mass Total, Flow1 Temperature or Computed Flow1 Density. The analog output is ideal for "trend" tracking using strip chart recorders or other devices.

### RS-232 Serial Port (Rate/Total mode)

#### 5.3.5 RS-232 Serial Port Operation in Rate/Total mode

The RS-232 serial port can be used for programming (using the Setup Program) or for communicating to printers and computers in the Operating Mode (Run Mode).

##### **PC Communications:**

The Setup Program also allows the user to query the unit for operating status such as Manifold Flow Rate, Manifold Flow Total, Temperature, Density, Presets, etc.

##### **Operation of RS-232 Serial Port with Printers:**

###### Transaction Printing

For transaction printing, the user defines the items to be included in the printed document (see section 6.3.20 SET DATA OUTPUT, Select\_list). The transaction document can be initiated by pressing the F3 PRINT key or by a remote contact closure on Control Input 3.

###### Data Logging

In data logging, the user defines the items to be included in each data log (see section 6.3.20 SET PRINTER OUTPUT, Select\_list). The user can also select when (time of day) or how often (print interval) the data log is to be made (see section 6.3.19 SET PRINTER OUTPUT, Configure). Data logs can also be initiated using the F3 print key or control input.

###### System Setup and Maintenance Report

The system setup and maintenance report lists all of the instrument setup parameters and usage for the current instrument configuration. The audit trail information and a status report is also printed. This report is initiated in the Test menu (see section 8.2.3 PRINT SYSTEM SETUP).

### RS-485 Serial Port (Rate/Total mode)

#### 5.3.6 RS-485 Serial Port (optional)

##### **RS-485 Port Description:**

The optional RS-485 card utilizes Modbus RTU protocol to access a variety of process parameters and totalizers. The Relays can be controlled via Modbus. In addition, action routines (such as totalizer reset) can be executed. For further information, contact factory and request RS-485 Protocol manual.

##### **Operation of Serial Communication Port with PC**

The ST1-MANIFOLD-FC's RS-485 channel supports a number of Modbus RTU commands. Modbus RTU drivers are available for a variety of Man Machine Interface software for IBM compatible PC's.

The user reads and writes information from/to the RS-485 using the Modbus RTU register and coil commands. The ST1-MANIFOLD-FC then responds to these information and command requests.

Process variables and totalizers are read in register pairs in IEEE 32 bit floating point format. Time and date are read as a series of integer register values. Alarms are individually read as coils. Action routines are initiated by writing to coils.

## 6. PROGRAMMING

### 6.1 Front Panel Operation Concept for Program Mode

The ST1-MANIFOLD-FC is fully programmable through the front panel. Please review the following usage summary before attempting to use the instrument. Refer to Appendix B as an aid in locating individual sub-menus.

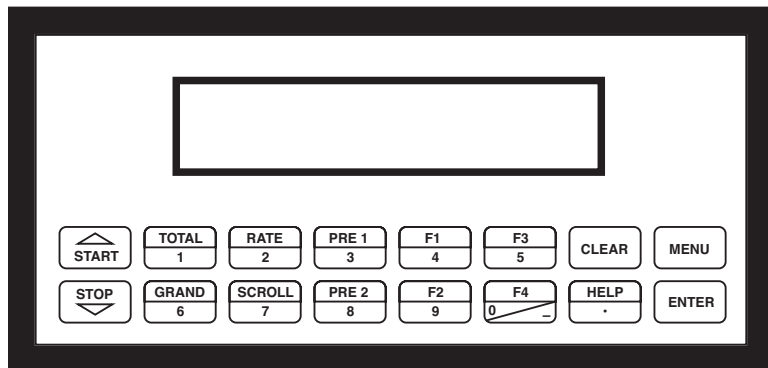

#### Setup Mode:

#### How To Make Mode Changes

#### **MODE CHANGES**

Pressing the MENU key will offer selections of RUN, SETUP, TEST. RUN is the normal operating mode for the instrument. SETUP offers various sub-menus used for instrument setup. TEST offers various sub-menus for Test, Calibration and System Start-up.

#### How To Navigate Through Sub-Menu Groups

#### **Submenu GROUP NAVIGATION**

Use the UP and DOWN arrow keys to navigate up and down through the Sub-Menu groups when in the SETUP or TEST mode. Press the ENTER key to enter a desired setup or test Sub-Menu group.

#### How To Select Program Choices

#### **SELECTION OF ITEM**

During setup, the unit will often offer multiple choices for a given topic. The topic prompt appears on the top line of the display. The choices are shown on the lower line of the display.

**To select an item, press the key beneath the desired choice. The selected choice will blink. Press the ENTER key to accept the selected choice.**

#### How To Enter Numeric Values

#### **NUMERIC ENTRY**







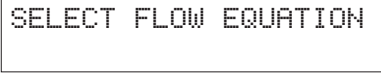

The keys labeled "0 - 9", "-", ".", CLEAR and ENTER are used to enter numerical values. A leading 0 will assume that you intend to enter a minus "-" sign. Press the CLEAR key to clear the existing value and to enable editing.

#### How To Enter Text Characters

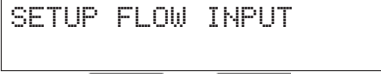
#### **TEXT CHARACTER ENTRY**

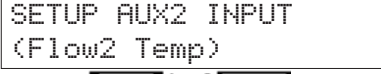
Some setup items (i.e. Descriptors, Units Label) require the user to enter text characters. Press CLEAR to enable editing. The UP and DOWN arrow keys are used to scroll through the available character sets for each individual character. Press the ENTER key to accept the character and advance to the next character until all characters needed for the label have been entered.



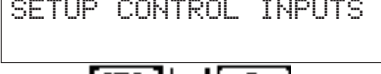
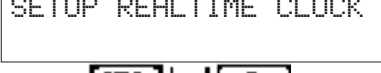
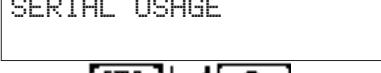
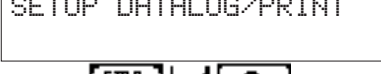
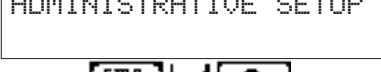
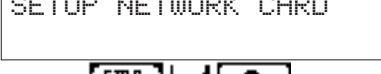





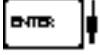

### 6.2 Setup Menus

| Menus                            | Display                                                                             | Notes                                               |
|----------------------------------|-------------------------------------------------------------------------------------|-----------------------------------------------------|
| 6.2.1<br>Top Level Setup<br>Menu |    | Select Setup to enter the instrument setup routine. |
| 6.2.2<br>Submenu<br>Groups       |    | Refer to Page 17 for Details.                       |
|                                  |    | Refer to Pages 17-18 for Details.                   |
|                                  |    | Refer to Pages 19-20 for Details.                   |
|                                  |    | Refer to Page 21 for Details.                       |
|                                  |    | Refer to Pages 22 for Details.                      |
|                                  |  | Refer to Pages 23 for Details.                      |
|                                  |  | Refer to Page 24 for Details.                       |
|                                  |  | Refer to Pages 24 for Details.                      |
|                                  |  | Refer to Pages 25-26 for Details.                   |
|                                  |  | Refer to Page 27 for Details.                       |
|                                  |  | Refer to Page 28 for Details.                       |
|                                  |  | Refer to Page 29 for Details.                       |
|                                  |  | Refer to Pages 30-31 for Details.                   |
|                                  |  | Refer to Pages 31 for Details.                      |
|                                  |  | Refer to Page 32 for Details.*                      |

\* Optional Menu only appears if option is installed

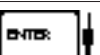
### 6.3 Setup Sub-Menus

| Sub-menus                                           | Display                                             | Notes                                                                    |
|-----------------------------------------------------|-----------------------------------------------------|--------------------------------------------------------------------------|
| <b>6.3.1<br/>SELECT<br/>FLOW EQUATION</b>           | <pre>SELECT FLOW EQUATION</pre>                     | Press ENTER to enter Select Flow Equation submenus.                      |
|                                                     | <pre>SELECT FLOW EQUATION Volume Mass Cor/Vol</pre> | Press ENTER when desired flow equation is flashing.                      |
|                                                     | <pre>DENS EXTRACT METHOD Therm_Coef API_2540</pre>  | Press ENTER when desired density extraction method is flashing.          |
|                                                     | <pre>Advance To SETUP INDICATORS (Total)</pre>      |                                                                          |
| <b>6.3.2<br/>SETUP<br/>INDICATORS<br/>(Total)</b>   | <pre>SETUP INDICATORS</pre>                         | Press ENTER to begin setup of the Indicators                             |
|                                                     | <pre>SETUP INDICATORS Total Dens Rate Temp</pre>    | Press ENTER when Total is flashing to configure the Totalizer Indicators |
|                                                     | <pre>TOTAL DESCRIPTOR TOTAL</pre>                   | Enter the desired Total Descriptor                                       |
|                                                     | <pre>VOLUME UNITS gal</pre>                         | Enter the desired Volume Units Label for the Totalizer.                  |
|                                                     | <pre>TOT DEC PLACES (0-3) 0</pre>                   | Select the desired Total Decimal Place. 0-3 decimal places allowed.      |
|                                                     | <pre>Advance To SETUP INDICATORS (Density)</pre>    |                                                                          |
| <b>6.3.3<br/>SETUP<br/>INDICATORS<br/>(Density)</b> | <pre>SETUP INDICATORS Total Dens Rate Temp</pre>    | Press ENTER when Dens is flashing to configure the Density Indicators.   |
|                                                     | <pre>DENSITY DESCRIPTOR DENS</pre>                  | Enter the desired Density Descriptor.                                    |
|                                                     | <pre>MASS UNITS lbs</pre>                           | Enter the desired Mass Units Label for Density.                          |
|                                                     | <pre>DENS DEC PLACES(0-6) 4</pre>                   | Select the desired Density Decimal Place. 0-6 decimal places allowed.    |
|                                                     | <pre>DENSITY DEFAULT 1 lbs/g</pre>                  | Enter the default density setting.                                       |
|                                                     | <pre>Advance To SETUP INDICATORS (Rate)</pre>       |                                                                          |









| Sub-menus                                                                           | Display                                                                                                                                                                                                | Notes                                                                      |
|-------------------------------------------------------------------------------------|--------------------------------------------------------------------------------------------------------------------------------------------------------------------------------------------------------|----------------------------------------------------------------------------|
| <b>6.3.4</b><br><b>SETUP</b><br><b>INDICATORS</b><br>(Rate)                         | SETUP INDICATORS<br>Total Dens <b>Rate</b> Temp                                                                                                                                                        | Press ENTER when Rate is flashing to configure the Ratemeter Indicators    |
|                                                                                     |                                                                                                                       |                                                                            |
|                                                                                     | RATE TIME BASE<br>Sec Min Hour Day                                                                                                                                                                     | Select the desired Rate Time Base.                                         |
|                                                                                     |                                                                                                                       |                                                                            |
|                                                                                     | RATE DESCRIPTOR<br><span style="float: right;">RATE</span>                                                                                                                                             | Enter the desired Descriptor for the Ratemeter.                            |
|                                                                                     |                                                                                                                       |                                                                            |
|                                                                                     | RATE DEC PLACES(0-3)<br><span style="float: right;">2</span>                                                                                                                                           | Select the desired Rate Decimal Place. 0-3 decimal places allowed.         |
|    |                                                                                                                                                                                                        |                                                                            |
| RATE AVG FILTER<br><span style="float: right;">0</span>                             | Enter desired Rate Averaging Filter for Flow1/ Flow2 rates.                                                                                                                                            |                                                                            |
|   |                                                                                                                                                                                                        |                                                                            |
| QUICK UPDATE %<br><span style="float: right;">1</span>                              | Enter desired Percent of Change for Quick Update. If the current Flow1/Flow2 flowrate deviates by an amount greater than the percentage value entered, the Rate Averaging is restarted with new value. |                                                                            |
|  |                                                                                                                                                                                                        |                                                                            |
| Advance To<br>SETUP INDICATORS<br>(Temperature)                                     |                                                                                                                                                                                                        |                                                                            |
| <b>6.3.5</b><br><b>SETUP</b><br><b>INDICATORS</b><br>(Temperature)                  | SETUP INDICATORS<br>total Dens Rate <b>Temp</b>                                                                                                                                                        | Press ENTER when Temp is flashing to configure the Temperature Indicators. |
|                                                                                     |                                                                                                                     |                                                                            |
|                                                                                     | TEMP DESCRIPTOR<br><span style="float: right;">TEMP</span>                                                                                                                                             | Enter the desired Temperature Descriptor.                                  |
|                                                                                     |                                                                                                                     |                                                                            |
|                                                                                     | TEMPERATURE SCALE<br>Deg_C <span style="float: right;">Deg_F</span>                                                                                                                                    | Enter the desired Temperature Scale.                                       |
|                                                                                     |                                                                                                                     |                                                                            |
|                                                                                     | TEMP DEC PLACES(0-3)<br><span style="float: right;">1</span>                                                                                                                                           | Select the desired Temperature Decimal Place. 0-3 decimal places allowed.  |
|  |                                                                                                                                                                                                        |                                                                            |
| TEMPERATURE DEFAULT<br><span style="float: right;">60 F</span>                      | Enter the default temperature                                                                                                                                                                          |                                                                            |
|  |                                                                                                                                                                                                        |                                                                            |
| Advance To<br>SETUP FLOW INPUT                                                      |                                                                                                                                                                                                        |                                                                            |

| Submenus                                                                 | Display                                                                                                                            | Notes                                                                                                                                    |
|--------------------------------------------------------------------------|------------------------------------------------------------------------------------------------------------------------------------|------------------------------------------------------------------------------------------------------------------------------------------|
| <b>6.3.6<br/>SETUP<br/>FLOW INPUT</b>                                    | <pre> SETUP FLOW INPUT                     </pre>                                                                                  | Press ENTER to begin setup of Flow Input.                                                                                                |
|                                                                          | <pre>                     ENTER                     </pre>                                                                         |                                                                                                                                          |
|                                                                          | <pre> EXCITATION VOLTAGE 5v      12v     24v                     </pre>                                                            | Select the desired Excitation Voltage.<br>NOTE: DC models do not support the 24V selection.                                              |
|                                                                          | <pre>                     ENTER                     </pre>                                                                         |                                                                                                                                          |
|                                                                          | <pre> PULSE TRIGGER LEVEL 10mV    100mV   2.5V                     </pre>                                                          | Select the desired Input Pulse Trigger Level.                                                                                            |
|                                                                          | <pre>                     ENTER                     </pre>                                                                         |                                                                                                                                          |
|                                                                          | <pre> LOW PASS FILTER 40Hz    3KHz    20KHz                     </pre>                                                             | Select the desired Low Pass Filter.<br>(Max. Count Speed).                                                                               |
|                                                                          | <pre>                     ENTER                     </pre>                                                                         |                                                                                                                                          |
|                                                                          | <pre> INPUT TERMINATION Pullup  Pulldown None                     </pre>                                                           | Select the proper input termination.                                                                                                     |
|                                                                          | <pre>                     ENTER                     </pre>                                                                         |                                                                                                                                          |
|                                                                          | <pre> MAX WINDOW (1-99)                                      1 sec                     </pre>                                      | Enter the desired Maximum Sample Window Time (1-99 sec).                                                                                 |
|                                                                          | <pre>                     ENTER                     </pre>                                                                         |                                                                                                                                          |
|                                                                          | <pre> K_FACTOR TYPE AvgK   LinTbl UVC   StRo                     </pre>                                                            | Enter the desired K-Factor Type. See side note.                                                                                          |
|                                                                          | <pre>                     ENTER                     </pre>                                                                         |                                                                                                                                          |
|                                                                          | <pre> AVERAGE KA-FACTOR           ##### P/gal                     </pre>                                                           | If Avg selected, Enter the desired Average K-Factor (KA for Flow1).                                                                      |
| <pre>                     ENTER                     </pre>               |                                                                                                                                    |                                                                                                                                          |
| <pre> AVERAGE KB-FACTOR           ##### P/gal                     </pre> | Enter the desired Average K-Factor (KB for Flow2).                                                                                 |                                                                                                                                          |
| <pre>                     ENTER                     </pre>               |                                                                                                                                    |                                                                                                                                          |
| <pre> CHANGE TABLE A           No      Yes                     </pre>    | If LinTbl selected, Select YES to change that table                                                                                |                                                                                                                                          |
| <pre>                     ENTER                     </pre>               |                                                                                                                                    |                                                                                                                                          |
| Through<br>40 Points                                                     | <pre>                     LINEAR TABLE KA                     Fre01:##### Hz                     </pre>                            | Enter the desired frequency/ K-Factor pair (in ascending order of Hz) for each point in the Linearization Table. (Table A = Flow1)       |
|                                                                          | <pre>                     LINEAR TABLE KA                     KA--01:##### P/gal                     </pre>                        | <b>NOTE:</b> Enter 0 for Fre value of any point (other than Fre01) to exit the routine and use only the values entered up to that point. |
| <pre>                     ENTER                     </pre>               |                                                                                                                                    |                                                                                                                                          |
| <pre> CHANGE TABLE A           No      Yes                     </pre>    | Enter the desired frequency/ K-Factor pair (in ascending order of Hz) for each point in the Linearization Table. (Table B = Flow2) |                                                                                                                                          |
| <pre>                     ENTER                     </pre>               |                                                                                                                                    |                                                                                                                                          |
| Through<br>40 Points                                                     | <pre>                     LINEAR TABLE KA                     Fre01:##### Hz                     </pre>                            | <b>NOTE:</b> Enter 0 for Fre value of any point (other than Fre01) to exit the routine and use only the values entered up to that point. |
|                                                                          | <pre>                     LINEAR TABLE KA                     KA--01:##### P/gal                     </pre>                        |                                                                                                                                          |
| <pre>                     ENTER                     </pre>               |                                                                                                                                    |                                                                                                                                          |
| <pre> CHANGE TABLE A           No      Yes                     </pre>    | If UVC selected, Select YES to change that table                                                                                   |                                                                                                                                          |
| <pre>                     ENTER                     </pre>               |                                                                                                                                    |                                                                                                                                          |
| Through<br>40 Points                                                     | <pre>                     LINEAR TABLE KA                     Fre01:##### Hz/ck                     </pre>                         | Enter the desired Hz/ck/ K-Factor pair (in ascending order of Hz/ck) for each point in the Linearization Table. (Table A = Flow1)        |
|                                                                          | <pre>                     LINEAR TABLE KA                     KA--01:##### P/gal                     </pre>                        | <b>NOTE:</b> Enter 0 for Hz/ckvalue of any point (other than Hz/ck01) to exit the routine and use the values entered up to that point.   |
| <pre>                     ENTER                     </pre>               |                                                                                                                                    |                                                                                                                                          |
| <pre> CHANGE TABLE A           No      Yes                     </pre>    | Enter the desired Hz/ck/ K-Factor pair (in ascending order of Hz/ck) for each point in the Linearization Table. (Table B = Flow2)  |                                                                                                                                          |
| <pre>                     ENTER                     </pre>               |                                                                                                                                    |                                                                                                                                          |
| Through<br>40 Points                                                     | <pre>                     LINEAR TABLE KB                     Fre01:##### Hz/ck                     </pre>                         | <b>NOTE:</b> Enter 0 for Hz/ck value of any point (other than Hz/ck01) to exit the routine and use the values entered up to that point.  |
|                                                                          | <pre>                     LINEAR TABLE KB                     KB--01:##### P/gal                     </pre>                        |                                                                                                                                          |
| <pre>                     ENTER                     </pre>               |                                                                                                                                    |                                                                                                                                          |









Continued On Next Page











| Sub-menus                                                                           | Display                                                                                                                                                                       | Notes                                                                                                                                                                |
|-------------------------------------------------------------------------------------|-------------------------------------------------------------------------------------------------------------------------------------------------------------------------------|----------------------------------------------------------------------------------------------------------------------------------------------------------------------|
| <p>6.3.6<br/> <b>SETUP<br/>           FLOW INPUT<br/>           (continued)</b></p> | <p>Through<br/>40 Points</p> <div style="border: 1px solid black; padding: 2px;">           LINEAR TABLE KB<br/>           RoB01:#####<br/>           [ENTR] ↓         </div> | <p>If StRo selected, Enter the desired St/ Ro pair (in ascending order of St/Ro) for each point in the Linearization Table. (Table A Is Flow1; Table B is Flow2)</p> |
|                                                                                     | <div style="border: 1px solid black; padding: 2px;">           LINEAR TABLE KB<br/>           StB01:#####<br/>           [ENTR] ↓         </div>                              | <p><b>NOTE:</b> Enter 0 for Ro value of any point (other than RoA01) to exit the routine and use the values entered up to that point.</p>                            |
|                                                                                     | <p>Through<br/>40 Points</p> <div style="border: 1px solid black; padding: 2px;">           LINEAR TABLE KB<br/>           RoB01:#####<br/>           [ENTR] ↓         </div> |                                                                                                                                                                      |
|                                                                                     | <div style="border: 1px solid black; padding: 2px;">           LINEAR TABLE KB<br/>           StB01:#####<br/>           [ENTR] ↓         </div>                              |                                                                                                                                                                      |
|                                                                                     | <div style="border: 1px solid black; padding: 2px;">           LOW FLOW RATE ALARM<br/>           ##### gal/s<br/>           [ENTR] ↓         </div>                          | <p>Enter the desired volumetric Low Rate Alarm for manifold. This will trigger a visual message if alarm conditions occur. The relays are not affected.</p>          |
|                                                                                     | <div style="border: 1px solid black; padding: 2px;">           HIGH FLOW RATE ALARM<br/>           ##### gal/s<br/>           [ENTR] ↓         </div>                         | <p>Enter the desired volumetric High Rate Alarm for manifold. This will trigger an alarm message if alarm conditions occur. The relays are not affected.</p>         |
|                                                                                     | <div style="border: 1px solid black; padding: 2px;">           METER EXPAN [xe - 6]<br/>                             0 ppm/f<br/>           [ENTR] ↓         </div>           | <p>If UVC or StRo selected, Enter the expansion coefficient for the meter housing.</p>                                                                               |
|                                                                                     | <div style="border: 1px solid black; padding: 2px;">           CALIBRATION TEMPERATURE<br/>                                     70 F<br/>           [ENTR] ↓         </div>   | <p>If UVC or StRo selected, Enter the calibration temperature.</p>                                                                                                   |
|                                                                                     | <div style="border: 1px solid black; padding: 2px;">           H2O DENSITY AT 4 DEG C<br/>                             8.34519 lbs/g<br/>           [ENTR] ↓         </div>   | <p>If UVC or StRo selected, Enter the density of water at 4° C.</p>                                                                                                  |
|                                                                                     | <p>Advance To<br/>           SETUP AUX1 INPUT</p>                                                                                                                             |                                                                                                                                                                      |



| Sub-menus                 | Display                                                                                  | Notes                                                                                                               |
|---------------------------|------------------------------------------------------------------------------------------|---------------------------------------------------------------------------------------------------------------------|
| 6.3.7<br>SETUP AUX1 INPUT | <pre>                     SETUP AUX1 INPUT                     </pre>                    | Press ENTER to begin setup of the Auxiliary 1 Input corresponding to Flow1 temperature.                             |
|                           |         |                                                                                                                     |
|                           | <pre> AUX1 INPUT TYPE None                               Temp                     </pre> | Select "Temp" to indicate a temperature transmitter will be used on the Flow1 line.                                 |
|                           |         |                                                                                                                     |
|                           | <pre> AUX1 SIGNAL TYPE Therm. Current RTD                     </pre>                     | If "Temp" selected, Choose Signal Type: Thermistor, Current Range or RTD. (Skip if "None" selected)                 |
|                           |         |                                                                                                                     |
|                           | <pre> CURRENT RANGE 4-20mA                            0-20mA                     </pre>  | If "Current" selected, Choose applicable Current Range for the transmitter. (Skip if "None" selected)               |
|                           |         |                                                                                                                     |
|                           | <pre> AUX1 LOW SCALE ##### F                     </pre>                                  | Enter the low temperature scale corresponding to the low temperature signal.                                        |
|                           |        |                                                                                                                     |
|                           | <pre> AUX1 FULL SCALE ##### F                     </pre>                                 | Enter the high temperature scale corresponding to the high temperature signal.                                      |
|                           |       |                                                                                                                     |
|                           | <pre> AUX1 Offset Temp ##### F                     </pre>                                | Enter the Low Offset Temperature. to correct for any small errors observed in the measurement on Flow1 temperature. |
|                           |       |                                                                                                                     |
|                           | <pre> AUX1 LOW ALARM ##### F                     </pre>                                  | Enter the Low setpoint for the Temperature Alarm warning to the operator.                                           |
|                           |       |                                                                                                                     |
|                           | <pre> AUX1 HIGH ALARM ##### F                     </pre>                                 | Enter the High setpoint for the Temperature Alarm warning to the operator.                                          |
|                           |       |                                                                                                                     |
|                           | <p>Advance To<br/>SETUP AUX2 INPUT</p>                                                   |                                                                                                                     |

| Sub-menus                                                     | Display                                                                | Notes                                                                                                                                     |
|---------------------------------------------------------------|------------------------------------------------------------------------|-------------------------------------------------------------------------------------------------------------------------------------------|
| <p>6.3.8<br/>SETUP AUX 2 INPUT</p>                            | <pre> SETUP AUX2 INPUT                 </pre>                          | <p>Press ENTER to begin setup of the Auxiliary 2 Input corresponding to Flow2 temperature.</p>                                            |
| <p><b>NOTE:</b><br/>If "None" selected:<br/>TEMP2 = TEMP1</p> | <pre> ENTER:                 </pre>                                    |                                                                                                                                           |
|                                                               | <pre> AUX2 INPUT TYPE None      Temp      AUX1                 </pre>  | <p>Select "Temp" to indicate a temperature transmitter will be used on the Flow2 line or else use AUX1 for Flow2 Temperature as well.</p> |
|                                                               | <pre> ENTER:                 </pre>                                    |                                                                                                                                           |
|                                                               | <pre> AUX2 SIGNAL TYPE Voltage    Current                 </pre>       | <p>If "Temp" selected, Choose Voltage or Current for the transmitter input type. (Skip if "None" selected)</p>                            |
|                                                               | <pre> ENTER:                 </pre>                                    |                                                                                                                                           |
|                                                               | <pre> VOLTAGE RANGE 0-10V    0-5V    1-5V                 </pre>       | <p>If "Voltage" selected, Choose applicable Voltage Range for the transmitter.</p>                                                        |
|                                                               | <pre> ENTER:                 </pre>                                    |                                                                                                                                           |
|                                                               | <pre> CURRENT RANGE 4-20mA    0-20mA                 </pre>            | <p>If "Current" selected, Choose applicable Current Range for the transmitter.</p>                                                        |
|                                                               | <pre> ENTER:                 </pre>                                    |                                                                                                                                           |
|                                                               | <pre> AUX2 LOW SCALE         ##### F                 </pre>            | <p>Enter the low temperature scale corresponding to the low temperature signal.</p>                                                       |
|                                                               | <pre> ENTER:                 </pre>                                    |                                                                                                                                           |
|                                                               | <pre> AUX2 FULL SCALE         ##### F                 </pre>           | <p>Enter the high temperature scale corresponding to the high temperature signal.</p>                                                     |
|                                                               | <pre> ENTER:                 </pre>                                    |                                                                                                                                           |
|                                                               | <pre> AUX2 LOW ALARM         ##### F                 </pre>            | <p>Enter the Low setpoint for the Temperature Alarm warning to the operator.</p>                                                          |
|                                                               | <pre> ENTER:                 </pre>                                    |                                                                                                                                           |
|                                                               | <pre> AUX2 HIGH ALARM         ##### F                 </pre>           | <p>Enter the High setpoint for the Temperature Alarm warning to the operator.</p>                                                         |
|                                                               | <pre> ENTER:                 </pre>                                    |                                                                                                                                           |
|                                                               | <p style="text-align: center;">Advance To<br/>SET FLUID PROPERTIES</p> |                                                                                                                                           |

| Sub-menus                                                                           | Display                                                                             | Notes                                                                                                                   |                                                                                                                                                                                     |
|-------------------------------------------------------------------------------------|-------------------------------------------------------------------------------------|-------------------------------------------------------------------------------------------------------------------------|-------------------------------------------------------------------------------------------------------------------------------------------------------------------------------------|
| <b>6.3.9<br/>SET FLUID<br/>PROPERTIES</b>                                           | <pre>SET FLUID PROPERTIES</pre>                                                     | Press ENTER at this prompt to Set Fluid Properties.                                                                     |                                                                                                                                                                                     |
|                                                                                     |    | <pre>FLUID NUMBER (0-9) 0</pre>                                                                                         | Up to 10 Fluid types may be stored in the unit. Select the number of the desired fluid to edit.                                                                                     |
|                                                                                     |    | <pre>FLUID NAME Generic #0</pre>                                                                                        | Shows name and number of fluid selected. Enter the desired name using the up/down arrow keys.                                                                                       |
|                                                                                     |    | <pre>REF. DENSITY ##### lbs/g</pre>                                                                                     | Enter the Reference Density. This is used in the calculation of density when you have a temp transmitter and used for corrected flow calculation if you have a density transmitter. |
|                                                                                     |    | <pre>REF. TEMPERATURE ##### F</pre>                                                                                     | Enter the Reference Temperature.                                                                                                                                                    |
|                                                                                     |   | <pre>EXPAN. FACTOR [xe-6] #####</pre>                                                                                   | Enter the proper Fluid Expansion Factor. (If Temp Compensated for Mass or Corrected Volume) See Section 7.3, Calculating the Fluid Expansion Factor.                                |
|                                                                                     |  | <pre>VISCOSITY COEF. A 0.000</pre>                                                                                      | Enter the Viscosity A Coefficient. See section 7.4, Computation of Viscosity Coef. A and B.                                                                                         |
|                                                                                     |  | <pre>VISCOSITY COEF. B 0.000</pre>                                                                                      | Enter the Viscosity B Coefficient. See section 7.4, Computation of Viscosity Coef. A and B.                                                                                         |
|  | <pre>Advance To SETUP PULSE OUTPUT</pre>                                            | NOTE: The propertire for several common fluids are listed in Appendix A. These are also included in the setup software. |                                                                                                                                                                                     |

| Sub-menus                                                                                                                     | Display                                                                                                                       | Notes                                                                                                                              |
|-------------------------------------------------------------------------------------------------------------------------------|-------------------------------------------------------------------------------------------------------------------------------|------------------------------------------------------------------------------------------------------------------------------------|
| <p>6.3.10<br/>                     SETUP<br/>                     PULSE OUTPUT</p>                                            | <p>SETUP PULSE OUTPUT</p>                                                                                                     | <p>Press ENTER at this prompt to setup the Pulse Output.</p>                                                                       |
|                                                                                                                               | <p style="text-align: center;">ENTER: </p>   |                                                                                                                                    |
|                                                                                                                               | <p>PULSE OUTPUT USAGE<br/>                     Off Total</p>                                                                  | <p>Select the desired Pulse Output Usage. "Total" corresponds to Manifold Total.</p>                                               |
|                                                                                                                               | <p style="text-align: center;">ENTER: </p>   |                                                                                                                                    |
|                                                                                                                               | <p>PULSE WIDTH<br/>                     10mS 100mS</p>                                                                        | <p>Select the desired Pulse Width for the Pulse Output.</p>                                                                        |
|                                                                                                                               | <p style="text-align: center;">ENTER: </p>   |                                                                                                                                    |
|                                                                                                                               | <p>PULSE VALUE<br/>                     ##### gal/P</p>                                                                       | <p>Enter the desired Pulse Value for the Pulse Output (Units per Pulse).</p>                                                       |
|                                                                                                                               | <p style="text-align: center;">ENTER: </p>   |                                                                                                                                    |
|                                                                                                                               | <p style="text-align: center;">Advance To<br/>                     SETUP ANALOG OUTPUT</p>                                    |                                                                                                                                    |
| <p>6.3.11<br/>                     SETUP<br/>                     ANALOG OUTPUT</p>                                           | <p>SETUP ANALOG OUTPUT</p>                                                                                                    | <p>Press ENTER when Analog is flashing to setup the Analog Output.</p>                                                             |
|                                                                                                                               | <p style="text-align: center;">ENTER: </p> |                                                                                                                                    |
|                                                                                                                               | <p>ANALOG OUTPUT USAGE<br/>                     Rate Tot Temp Dens</p>                                                        | <p>Select the desired Analog Output Usage. "Rate" corresponds to Manifold Rate</p>                                                 |
|                                                                                                                               | <p style="text-align: center;">ENTER: </p> |                                                                                                                                    |
|                                                                                                                               | <p>ANALOG OUTPUT RANGE<br/>                     4-20mA 0-20mA</p>                                                             | <p>Select the desired current range for the Analog Output.</p>                                                                     |
|                                                                                                                               | <p style="text-align: center;">ENTER: </p> |                                                                                                                                    |
|                                                                                                                               | <p>LS ANALOG OUTPUT<br/>                     ##### gal/m</p>                                                                  | <p>Enter desired Analog Output Low Scale Value.<br/> <b>NOTE:</b> Units label will correspond with output usage type selected.</p> |
| <p style="text-align: center;">ENTER: </p> |                                                                                                                               |                                                                                                                                    |
| <p>FS ANALOG OUT 20mA<br/>                     ##### gal/m</p>                                                                | <p>Enter desired Analog Output Full Scale Value.</p>                                                                          |                                                                                                                                    |
| <p style="text-align: center;">ENTER: </p> |                                                                                                                               |                                                                                                                                    |
| <p>ANALOG OUT DAMPING<br/>                     0.0</p>                                                                        | <p>Enter the desired Analog Output Damping Constant. Increase value to slow response time and eliminate "bounce".</p>         |                                                                                                                                    |
|                                                                                                                               | <p style="text-align: center;">ENTER: </p> |                                                                                                                                    |
|                                                                                                                               | <p style="text-align: center;">Advance To<br/>                     SETUP RELAYS</p>                                           |                                                                                                                                    |







| Sub-menus                                                                               | Display                                                                                                                   | Notes                                                                                                                                                                    |
|-----------------------------------------------------------------------------------------|---------------------------------------------------------------------------------------------------------------------------|--------------------------------------------------------------------------------------------------------------------------------------------------------------------------|
| <p>6.3.12<br/> <b>SETUP RELAYS</b><br/>                     (Relay 1 &amp; Relay 2)</p> | <pre>                     SETUP RELAYS                     R1y1 R1y2 R1y3 R1y4                     [ENTER]</pre>          | <p>Select the desired Relay for setup.<br/>                     (Relays 3 &amp; 4 Optional)</p>                                                                          |
|                                                                                         | <pre>                     RELAY 1  USAGE                     RATE                     [ENTER]</pre>                       | <p>If Relay 1 or Relay 2 Selected,<br/>                     Select Manifold Rate, Manifold Total</p>                                                                     |
|                                                                                         | <pre>                     RELAY 1 DELAY      sec                                0                     [ENTER]</pre>       | <p>If Rate selected, enter desired relay activation<br/>                     delay value.</p>                                                                            |
|                                                                                         | <pre>                     RELAY 1 MODE                     LO_ALARM                     [ENTER]</pre>                     | <p>Select the desired Relay Activation.<br/>                     Low: Relay activates when Manifold reading is<br/>                     below setpoint.</p>              |
|                                                                                         | <pre>                     RELAY 1 SETPOINT                                ##### gal/m                     [ENTER]</pre>   | <p>Enter the desired Setpoint. The Setpoint can<br/>                     be edited in run mode using the PRE 1 key<br/>                     (PRE 2 key for Relay 2).</p> |
|                                                                                         | <pre>                     RELAY 1 HYSTERESIS                                ##### gal/m                     [ENTER]</pre> | <p>If Manifold Rate, selected, Enter desired Relay<br/>                     Hysteresis.</p>                                                                              |
|                                                                                         | <p>Advance To<br/>                     SETUP RELAYS 3, 4</p>                                                              |                                                                                                                                                                          |

| Sub-menus                                                                                                                                                                  | Display                                                                                                                   | Notes                                                                                                                                                                                                                                   |
|----------------------------------------------------------------------------------------------------------------------------------------------------------------------------|---------------------------------------------------------------------------------------------------------------------------|-----------------------------------------------------------------------------------------------------------------------------------------------------------------------------------------------------------------------------------------|
| <p>6.3.12 (Continued)<br/> <b>SETUP RELAYS</b><br/>                     (Relay 3 &amp; Relay 4)</p>                                                                        | <pre>                     SETUP RELAYS                     R1y1 R1y2 R1y3 R1y4                     [ENTER]</pre>          | <p>Select the desired Relay for setup.<br/>                     (Relays 3 &amp; 4 Optional)</p>                                                                                                                                         |
| <p><b>NOTE:</b><br/>                     Settings for Relays 3 &amp; 4 may be entered even if relays are not supplied. The settings will still trigger display alarms.</p> | <pre>                     RELAY 3 USAGE                     Rate Total Aux NA</pre>                                       | <p>If Relay 3 Selected,<br/>                     Choose Manifold Rate, Total, Aux or NA.</p>                                                                                                                                            |
|                                                                                                                                                                            | <pre>                     RELAY 4 USAGE                     Rate Tot Aux Alrm NA                     [ENTER]</pre>        | <p>If Relay 4 Selected,<br/>                     Choose Manifold Rate, Total, Aux, Alrm or NA.</p>                                                                                                                                      |
|                                                                                                                                                                            | <pre>                     ASSIGN AUX CHANNEL                     AUX 1      AUX 2                     [ENTER]</pre>       | <p>If Aux selected, enter desired auxilliary channel.</p>                                                                                                                                                                               |
|                                                                                                                                                                            | <pre>                     RELAY 3 DELAY      sec                                0                     [ENTER]</pre>       | <p>If Rate / Aux selected, enter desired relay activation delay value.</p>                                                                                                                                                              |
|                                                                                                                                                                            | <pre>                     RELAY 3 MODE                     LO_ALARM      HI_ALARM                     [ENTER]</pre>       | <p>Select the desired Relay Activation for Rate/Aux.<br/>                     Low: Relay activates when Manifold reading is below setpoint.<br/>                     High: Relay activates when Manifold reading is above setpoint.</p> |
|                                                                                                                                                                            | <pre>                     RELAY 3 DURATION                                #####                     [ENTER]</pre>         | <p>If Manifold Total Selected, Enter desired Relay Duration.</p>                                                                                                                                                                        |
|                                                                                                                                                                            | <pre>                     RELAY 3 SETPOINT                                ##### gal                     [ENTER]</pre>     | <p>Enter the desired Setpoint.</p>                                                                                                                                                                                                      |
|                                                                                                                                                                            | <pre>                     RELAY 3 HYSTERESIS                                ##### gal/m                     [ENTER]</pre> | <p>If Manifold Rate, selected, Enter desired Relay Hysteresis.</p>                                                                                                                                                                      |
|                                                                                                                                                                            | <p style="text-align: center;">Advance To<br/>                     SETUP CONTROL INPUTS</p>                               |                                                                                                                                                                                                                                         |

**RELAY NOTES & CONSIDERATIONS**

1. Relay activation is based on the computed readings not the displayed value. Therefore the display damping factor will not affect the relay response time. The RELAY DELAY feature allows the user to enter a time delay for relay activation. This feature is very useful in applications where short over/under range conditions are not considered alarm conditions.
2. Setting the relays to NA (Not Assigned), will allow the relay activation to be controlled via the RS-232 Serial and/or RS-485 Modbus ports.
3. Relay 3 and Relay 4 settings may be used to trigger display alarm conditions to the operator even if the relays are not supplied.

| Sub-menus                                                     | Display                                                                                   | Notes                                                                                                                                                                                                                              |
|---------------------------------------------------------------|-------------------------------------------------------------------------------------------|------------------------------------------------------------------------------------------------------------------------------------------------------------------------------------------------------------------------------------|
| <p>6.3.13<br/> <b>SETUP CONTROL<br/>           INPUTS</b></p> | <pre>           SETUP CONTROL INPUTS           </pre>                                     | <p>Press Enter to begin setup of the Control Inputs.</p>                                                                                                                                                                           |
|                                                               | <pre>           SETUP CONTROL INPUTS           Input1 Input2 Input3           </pre>      | <p>Select the desired Control Input for setup.</p>                                                                                                                                                                                 |
|                                                               | <pre>           CONTROL INPUT1 USAGE           INHIBIT_TOTAL      NA           </pre>     | <p>If Control Input 1 Selected, Select Inhibit Total or NA (Not Assigned).</p>                                                                                                                                                     |
|                                                               | <pre>           CONTROL INPUT2 USAGE           RESET_TOTAL       NA           </pre>      | <p>If Control Input 2 Selected, Select Reset Total or NA (Not Assigned).</p>                                                                                                                                                       |
|                                                               | <pre>           CONTROL INPUT3 USAGE           Prn  Ack  KeyLk  NA           </pre>       | <p>If Control Input 3 Selected, Select Prn (Print), Ack (acknowledge alarm), KeyLk (Keylock) or NA (Not Assigned). ACK will acknowledge and clear alarms and warning messages. The Alarm History is <b><u>NOT</u></b> cleared.</p> |
| <p>Advance To<br/>           SETUP REALTIME CLOCK</p>         | <p><b>Note:</b> Alarms may reassert themselves if alarm conditions are still present.</p> |                                                                                                                                                                                                                                    |

| Sub-menus                                                                                                                          | Display                                                                                                                     | Notes                                                 |
|------------------------------------------------------------------------------------------------------------------------------------|-----------------------------------------------------------------------------------------------------------------------------|-------------------------------------------------------|
| <b>6.3.14<br/>SETUP REALTIME<br/>CLOCK</b><br>(Time)                                                                               | SETUP REALTIME CLOCK                                                                                                        | Press Enter to begin setup of the Realtime Clock.     |
|                                                                                                                                    | <br>SETUP REALTIME CLOCK<br>Time Date      | Select Time to set the time.                          |
|                                                                                                                                    | <br>CLOCK TYPE<br>24HR 12HR                | Select 24Hr or 12Hr clock                             |
|                                                                                                                                    | <br>SELECT CLOCK AM/PM<br>AM PM            | If 12Hr Clock,<br>Enter AM or PM                      |
|                                                                                                                                    | <br>TIME OF DAY HH:MM:SS<br>##:##:##       | Enter time of day.                                    |
| <br>Advance To<br>SETUP REALTIME CLOCK<br>(Date) |                                                                                                                             |                                                       |
| <b>6.3.15<br/>SETUP REALTIME<br/>CLOCK</b><br>(Date)                                                                               | SETUP REALTIME CLOCK<br>Time Date                                                                                           | Select Date to enter the date.                        |
|                                                                                                                                    | <br>DATE: MONTH, DAY, YEAR<br>##/##/#### | Enter the date. (Month, Day, Last two digits of Year) |
| <br>Advance To<br>SERIAL USAGE                  |                                                                                                                             |                                                       |



| Sub-menus                                                                                                                                                  | Display                                                                                                                                                                     | Notes                                                                                                                                                      |                                                                                                   |
|------------------------------------------------------------------------------------------------------------------------------------------------------------|-----------------------------------------------------------------------------------------------------------------------------------------------------------------------------|------------------------------------------------------------------------------------------------------------------------------------------------------------|---------------------------------------------------------------------------------------------------|
| <b>6.3.16<br/>SERIAL USAGE<br/>(RS-232/485)</b>                                                                                                            | <pre>SERIAL USAGE</pre>                                                                                                                                                     | Press Enter to begin setup of the Serial Port.                                                                                                             |                                                                                                   |
|                                                                                                                                                            | <pre>                     ENTER                     SERIAL HARDWARE                     RS232          RS485                 </pre>                                         | Select Serial Hardware type for standard port. Select RS485 only on special order. (See SETUP NETWORK CARD for RS485 Modbus option)                        |                                                                                                   |
|                                                                                                                                                            | <pre>                     ENTER                     DEVICE ID                     ##                 </pre>                                                                 | Select the Device ID.                                                                                                                                      |                                                                                                   |
|                                                                                                                                                            | <pre>                     ENTER                     BAUD RATE                     300  600 1200 &lt;more&gt;                 </pre>                                         | Select the desired Baud Rate.                                                                                                                              |                                                                                                   |
|                                                                                                                                                            | <pre>                     BAUD RATE                     2400 4800 9600 19200                     ENTER                 </pre>                                               | (If <more> selected)                                                                                                                                       |                                                                                                   |
|                                                                                                                                                            | <pre>                     ENTER                     PARITY                     None   Odd   Even                     ENTER                 </pre>                           | Select the desired Parity.                                                                                                                                 |                                                                                                   |
|                                                                                                                                                            | <pre>                     ENTER                     HANDSHAKING                     None Software Hardware                     ENTER                 </pre>                 | Set the Handshake.                                                                                                                                         |                                                                                                   |
|                                                                                                                                                            | <pre>                     ENTER                     DEVICE LINE FEED                     &lt;CR&gt;          &lt;CR+LF&gt;                     ENTER                 </pre> | Choose end of line termination. Only choose <CR> if your external device automatically assigns a line feed for every <CR> carriage return.                 |                                                                                                   |
|                                                                                                                                                            | <b>6.3.17<br/>SERIAL USAGE<br/>(Modem Options)</b>                                                                                                                          | <pre>                     ENTER                     MODEM OPTIONS                     No          Yes                     ENTER                 </pre>     | Select "Yes" if the serial port will be used to control a modem.                                  |
|                                                                                                                                                            |                                                                                                                                                                             | <pre>                     ENTER                     MODEM INIT MASTER                     No          Yes                     ENTER                 </pre> | Select "Yes" to have the unit engage in a configuration conversation with the modem on power up . |
| <pre>                     ENTER                     MODEM AUTO ANSWER                     No          Yes                     ENTER                 </pre> |                                                                                                                                                                             | If "YES" selected for Modem Init Master, choose the desired Modem Auto Answer mode.                                                                        |                                                                                                   |
| <pre>                     ENTER                     CALL OUT DAY OF WEEK                     1                     ENTER                 </pre>            |                                                                                                                                                                             | Enter the day of the week to perform Call Out transmission. (0 = daily, 1 - 7 = Mon - Sun)                                                                 |                                                                                                   |
| <pre>                     ENTER                     CALL OUT TIME                     ##:##:##                     ENTER                 </pre>            |                                                                                                                                                                             | Enter the time of day to perform Call Out transmission. (HH:MM:SS)                                                                                         |                                                                                                   |

Continued on Next Page

| Sub-menus                                                                            | Display                                                                       | Notes                                                                                                                                                                   |
|--------------------------------------------------------------------------------------|-------------------------------------------------------------------------------|-------------------------------------------------------------------------------------------------------------------------------------------------------------------------|
| <b>6.3.17</b><br><b>SERIAL USAGE</b><br><b>(Modem Options)</b><br><b>(continued)</b> | <pre>CALL ON ERROR/ALARM No                               Yes ENTER: ↓</pre>  | Select "Yes" to have the unit perform a Call Out transmission upon error/alarm condition.                                                                               |
|                                                                                      | <pre>CALL OUT PHONE #                                 0 ENTER: ↓</pre>        | Call Out Phone Number to be dialed for "Call Out Time" or "Print On Error/Alarm". (Up to 20 digits with "." used to pause between digits)                               |
|                                                                                      | <pre>NUMBER OF REDIALS                                 0 ENTER: ↓</pre>       | Enter the number of redials to be performed on call out time if busy or no answer (error/ alarm tries until connected).                                                 |
|                                                                                      | <pre>HANGUP IF 2MIN INACT No                               Yes ENTER: ↓</pre> | Select "Yes" to perform hangup if there is inactivity for more than 2 minutes.                                                                                          |
|                                                                                      | Advance To<br>SETUP DATALOG/PRINT                                             |                                                                                                                                                                         |
| <b>6.3.18</b><br><b>SETUP</b><br><b>DATALOG/PRINT</b><br><b>(Configure)</b>          | <pre>SETUP DATALOG/PRINT ENTER: ↓</pre>                                       | Press Enter to setup the Datalog/Print information.                                                                                                                     |
|                                                                                      | <pre>SETUP DATALOG/PRINT Config Select_list ENTER: ↓</pre>                    | Select Config to configure the Datalog/Print information.                                                                                                               |
|                                                                                      | <pre>OUTPUT FORMAT Printer Term Dbase ENTER: ↓</pre>                          | Select the type of Output Format.                                                                                                                                       |
|                                                                                      | <pre>PAGE LENGTH [99 max]                                 99 ENTER: ↓</pre>   | Enter the desired Page Length. If Printer selected above.                                                                                                               |
|                                                                                      | <pre>TOP MARGIN [99 max]                                 3 ENTER: ↓</pre>     | Enter the desired Top Margin. If Printer selected above.                                                                                                                |
|                                                                                      | <pre>DATALOG ONLY No                               Yes ENTER: ↓</pre>         | Select Yes to record events to the datalogger only. Events will not be sent to the serial port.                                                                         |
|                                                                                      | <pre>PRINT TIME  HH:MM:SS             00:00:00 ENTER: ↓</pre>                 | Enter Print Time, printer will print at this time every day. Enter 00:00:00 to inhibit print time.                                                                      |
|                                                                                      | <pre>PRINT INTERVAL             00:00:00 ENTER: ↓</pre>                       | Enter Print Interval, Enter 00:00:00 to inhibit print interval..                                                                                                        |
|                                                                                      | <pre>ENABLE PRINT KEY NO                               YES ENTER: ↓</pre>     | Select YES to enable Print Key. Select NO to disable Print Key                                                                                                          |
|                                                                                      | <pre>CLEAR TOTAL IF PRINT NO                               YES ENTER: ↓</pre> | Select Yes to clear the total after printing. This feature is useful for recording totals, then clearing totals automatically after log or printout has been completed. |
| Advance To<br>SETUP DATALOG/PRINT<br>(Select_list)                                   |                                                                               |                                                                                                                                                                         |

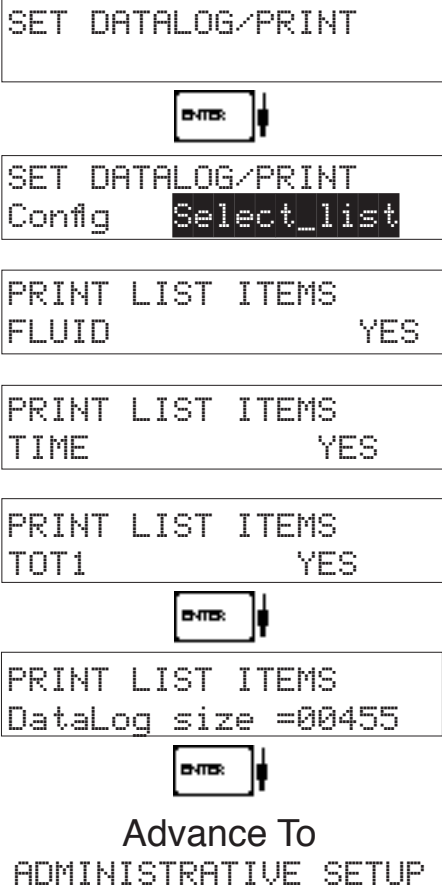
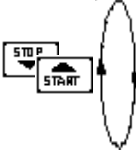
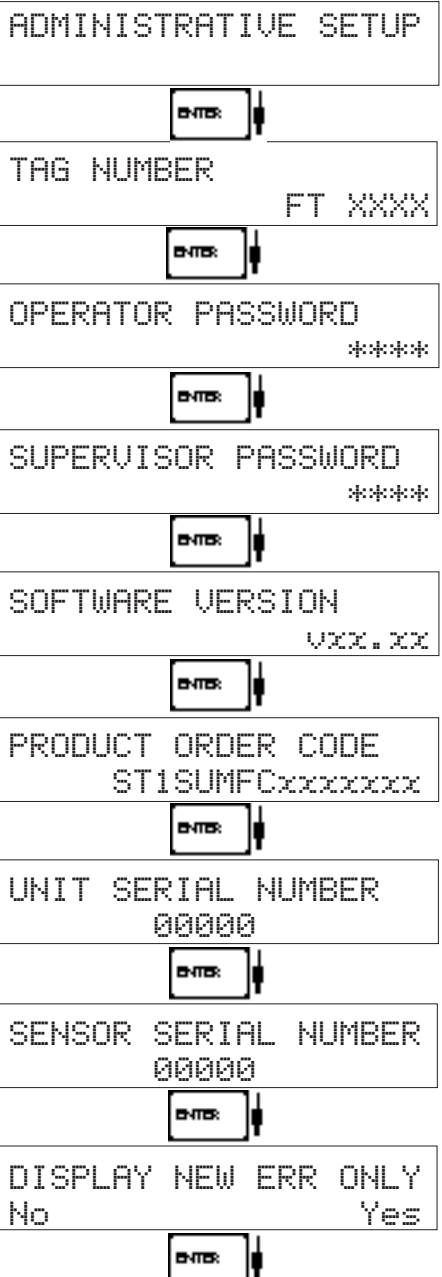
| Sub-menus                                                                                                                                                                             | Display                                                                             | Notes                                                                                                                                                                                                                                                                                                                                                                                                                                                                                                                                                                                                                                                                                                                   |
|---------------------------------------------------------------------------------------------------------------------------------------------------------------------------------------|-------------------------------------------------------------------------------------|-------------------------------------------------------------------------------------------------------------------------------------------------------------------------------------------------------------------------------------------------------------------------------------------------------------------------------------------------------------------------------------------------------------------------------------------------------------------------------------------------------------------------------------------------------------------------------------------------------------------------------------------------------------------------------------------------------------------------|
| <b>6.3.19</b><br><b>SETUP</b><br><b>DATALOG/PRINT</b><br>(Select_list)                                                                                                                |   | <p>Press enter to begin Setup Datalog/Print routine.</p> <p>Press enter when Select_list is selected to setup print list.</p> <p>Use Up and Down arrow keys to view list status.</p> <p>Press the Print or function key for the items that you wish to add or remove from the list. Items marked with Yes will be added to the list, items marked with No will be removed from the list.</p> <p>Suffix <b>M</b> corresponds to Manifold</p> <p>The Select Print List Information display shows the current possible Datalog size.</p>                                                                                                                                                                                   |
| <b>List Items:</b><br>FLUID<br>TIME<br>TOTM<br>RATEM<br>GRNDM<br>TEMP1<br>DENS1<br>PRE1<br>PRE2<br>PRE3<br>PRE4<br>FREQ1<br>FREQ2<br>KA-F<br>KB-F<br>TEMP2<br>DENS2<br>RATE1<br>RATE2 |    |                                                                                                                                                                                                                                                                                                                                                                                                                                                                                                                                                                                                                                                                                                                         |
| <b>6.3.20</b><br><b>ADMINISTRATIVE</b><br><b>SETUP</b>                                                                                                                                |  | <p>Press Enter to begin Administrative Setup.</p> <p>Use the up and down arrow keys to define the tag number.</p> <p>Enter Operator Password. (Factory Set to 0)</p> <p>Enter Supervisor Password, if logged in as supervisor. (Factory Set to 2000)</p> <p>This display is used to show the software version of the installed software.</p> <p>This display is used to show the product order code (model number).</p> <p>This display is used to show the unit's serial number.</p> <p>This display is used to show the sensor's serial number.</p> <p>If yes is selected, an error message will only appear once until acknowledged by user.</p> <p>Advance to Network Card only if a Network Card is installed.</p> |

6.3.21  
**SETUP  
 NETWORK CARD  
 (optional)**

```
SETUP NETWORK CARD
```

Press Enter to setup Network Card

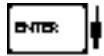

```
SELECT NTW PROTOCOL  
ModbusRTU
```

Select desired Network Protocol.

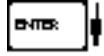

```
NETWORK DEVICE ID  
1
```

Enter the device address on network (00-255).

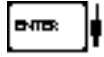

```
BAUD RATE  
2400 4800 9600 19200
```

Select the desired Baud Rate.



```
PARITY  
None      Odd      Even
```

Select the desired Parity.



```
Advance To  
INSTRUMENT TYPE
```

## 7. Principle Of Operation

### General Operation

#### 7.1 General:

A flowmeter manifold controller is a special flow instrument intended to accept inputs from two pulse output flowmeters, one larger and one smaller, and which also controls the bypass valve. The instrument setup contains the calibration information for both flowmeters as well as the manifold flow rate switch setpoint and hysteresis.

The instrument operation may be summarized as follows:

1. Measure the flow rate signal from the high range flowmeter (FM-1)
2. Decides if the flowrate is below the user specified low flow rate for the high range flowmeter (FM-1):
  - If yes, close the bypass valve
  - If no, open the bypass valve
3. If the bypass valve is open display flowrate and totalization based on the high range flowmeter (FM-1).
  - If the bypass valve is closed, display flowrate and total based on the low range flowmeter (FM-2).
4. Analog Output, Relays, Pulse Output, etc... is based on which ever flowmeter is active at the time.

This special version of the ST1 has two pulse, flow input channels.

#### Valve Specifications-

The valve should be a normally open, energize to close, valve of the same line size as the larger flowmeter (FM-1).

To be effective as a bypass around the smaller flowmeter (FM-2) the valve should present a minimal pressure drop at the maximum flowrate. Full port valves perform best.

#### Note concerning Fluid Information

The user will be prompted for Fluid Information during the setup of the instrument. The unit can store the fluid properties for up to 10 different fluids at one time. See also Appendix A for common fluid properties for liquids.

### Flow Equations

#### 7.2 Flow Equations:

##### Input Temperature Computation:

###### General Case

$$Tf1 = [\% \text{ input span} \cdot (\text{temp FS} - \text{Temp low scale})] + \text{temp low scale}$$

$$Tf2 = [\% \text{ input span} \cdot (\text{temp FS} - \text{Temp low scale})] + \text{temp low scale}$$

##### Fluid Properties:

###### Liquid Generic Case

$$\text{liquid density1} = \text{reference density} \cdot (1 - (\text{Therm. Exp. Coef.} \times 10^{-6} (Tf - Tref))^2)$$

$$\text{liquid density2} = \text{reference density} \cdot (1 - (\text{Therm. Exp. Coef.} \times 10^{-6} (Tf - Tref))^2)$$

###### Liquid API Case

$$\text{liquid density1} = \text{reference density} \cdot (\text{VCF API2540})$$

$$\text{liquid density2} = \text{reference density} \cdot (\text{VCF API2540})$$

##### Where:

Tf1 = Flow1 Temperature via AUX 1

Tf2 = Flow2 Temperature via AUX 2

**NOTE:** If AUX2 Usage = AUX1; TF2 = TF1

Liquid Density1 = Computed density at Flow1 Temperature from AUX1

Liquid Density2 = Computed density at Flow2 Temperature from AUX2

**NOTE:** If AUX2 Usage = AUX1; Liquid Density2 = Liquid Density1

**NOTE:** If both AUX1 and AUX2 Usage = NONE: TF2 = TF1 = Default Temperature

## 7.2 Flow Equations: (Continued)

### Fluid Equations Viscosity Computation:

#### Liquid Case

$$\dagger \text{ centistokes1} = \left( A \exp \frac{B}{(\text{Deg F} + 459.67)} \right)$$

$$\dagger \text{ centistokes2} = \left( A \exp \frac{B}{(\text{Deg F} + 459.67)} \right)$$

**Where:** centistokes = cP/(kg/l)

centistokes1 = computed viscosity in Flow1

centistokes2 = computed viscosity in Flow2

### Uncompensated Flow Computation:

#### Pulse Input; Average K-Factor

$$\text{Volume Flow1, 2} = \frac{\text{input frequency} \cdot \text{time scale factor}}{\text{K-Factor}}$$

#### Pulse Input; Linear Table

$$\text{Volume Flow1, 2} = \frac{\text{input frequency} \cdot \text{time scale factor}}{\text{K-Factor (Hz)}}$$

#### Pulse Input; UVC Table

$$\text{Volume Flow1, 2} = \frac{\text{input frequency} \cdot \text{time scale factor}}{\text{K-Factor (Hz/cstk)}}$$

#### Pulse Input; Strouhal/Roshko Table

$$\text{Volume Flow1, 2} = \frac{\text{input frequency} \cdot \text{time scale factor}}{\text{Strouhal Cal} / (1 + 3 \cdot \text{meter exp coeff.} \cdot 10^{-6} (\text{Tf-Tcal}))}$$

$$\text{Roshko Cal1, 2} = \frac{\text{input frequency} \cdot (1 + 2 \cdot \text{meter exp coeff.} \cdot 10^{-6} (\text{Tf-Tcal}))}{\text{cstk}}$$

### Manifold Flow Computation:

Manifold Flow = Flow1 if Flow1 > Pre1

Manifold Flow = Flow2 if Flow1 < Pre1 – Hys

### Corrected Volume Flow Computation:

#### Liquid Case

##### Generic Case

Standard Volume Flow = volume flow • (1 - Therm.Exp.Coeff. • (Tf-Tref))<sup>2</sup>

##### API Case

Standard Volume Flow = volume flow • (UCF API2540)

### Mass Flow Computation:

Mass Flow = volume flow • density

## 7.2 Flow Equations: (Continued)

### Flow Equations

**API 2540 Equation.** The American Petroleum Institute, in a joint program with the National Bureau of Standards (NIST), developed a density equation based on 463 samples of five different oil products. The results of this work are incorporated into Chap. 11.1, "Volume Correction Factors," of API Standard 2540 (1987).

The density equation is based on the thermal-expansion coefficient of the product at 60°F (15.6°C) base temperature, which is calculated from the base density as

$$\alpha_b = \frac{K_0}{\rho_b^{*2}} + \frac{K_1}{\rho_b^*} \quad (2.188)$$

where the base density  $\rho_b^*$  is in kilograms per cubic meter. The empirically derived constants  $K_0$  and  $K_1$  for the five product groups are given in Table 2.23. The density of the product at flowing temperature is then calculated as

$$\rho_F^* = \rho_b^* \exp [-\alpha_b \Delta T_F (1 + 0.8 \alpha_b \Delta T_F)] \quad (2.189)$$

where  $\Delta T_F = T_F - 60$ . The specific gravity at flowing or measured temperature is then

**TABLE 2.23** Constants  $K_0$  and  $K_1$  for Five Product Groups

| Product group                       | $K_0$    | $K_1$  |
|-------------------------------------|----------|--------|
| Crude oils and JP4†                 | 341.0957 | 0.0    |
| Jet fuels, kerosenes, solvents      | 330.3010 | 0.0    |
| Gasolines and naphthenes            | 192.4571 | 0.2438 |
| Lubricating oils                    | 144.0427 | 0.1895 |
| Diesel oil, heating oils, fuel oils | 103.8720 | 0.2701 |

*Note:* Pentanes and hydrocarbons lower in the hydrocarbon chain are *not* covered by this data.

†API News Release 1987 added JP4.

The above information was obtained from "Flow Measurement Engineering Handbook, 3rd Edition" by Richard W Miller.

### API 2540 Expansion Factor Equation

1. Select the values for  $K_0$  and  $K_1$  for the fluid group to be measured
2. Convert the base reference density for your fluid into the corresponding density units of  $\text{kg/m}^3$
3. Solve for  $\alpha_b$  using equation above
4.  $C = \alpha_b \cdot 1,000,000$

### 7.3 Calculating the Fluid Expansion Factor for Generic Case

#### Calculating Expansion Factor

The liquid density is a function of the flowing temperature for many fluids. This unit solves an equation which represents this physical property of the fluid.

The information which the unit uses to describe the fluid is entered by the user in the following variables: Reference Temperature, Reference Density, Fluid Expansion Factor. Values for common fluids are listed in Appendix A for the generic case.

This information is available for many fluids in one or more of the following forms:

Fluid Specific Gravity vs. Temp. Table

Specific Gravity vs. Temp. Graph

Fluid Density vs. Temp. Table

Fluid Density vs. Temp. Graph

Begin by obtaining one of the fluid properties for the fluid you are using from available manufacturers information or Engineering Handbooks. In some cases this information is listed on the Material Safety Data Sheet for the fluid.

Two temperature-specific gravity pairs will be required to compute the temperature coefficient.

The reference temperature is simply chosen by the user. Common reference temperatures are 60° F or 15° C.

The reference temperature should be chosen so that it is in the application temperature range. i.e. application temperature range -10 to 120° F, reference temperature of 60° F chosen.

Enter the reference temperature you have chosen at this point.

The reference specific gravity corresponds to the fluid SPECIFIC GRAVITY at the reference temperature chosen.

You may convert the fluid density information to specific gravity if it is in units other than specific gravity. Use EQ1.

#### Expansion Factor Equations

EQ1.

$$\text{Spec.Grav.} = \text{Density of Fluid} / \text{Density of Water}$$

Given the reference temperature, reference specific gravity, a second temp. and a second Spec.Grav., the Expansion Factor (C Factor) can be computed as follows:

EQ2. Used for Liquid Mass and Corrected Volume Equations

$$C = \left[ \frac{1 - \sqrt{(\text{Spec.Grav.2} / \text{Ref.Spec.Grav.})}}{\text{Temp.2} - \text{Ref.Temp}} \right] \times 1,000,000$$

Given the reference temperature, reference density, a second temp. and a second density, the Expansion Factor (C Factor) can be computed as follows:

EQ3. Used for Liquid Mass and Corrected Volume Equations

$$C = \left[ \frac{1 - \sqrt{(\text{Dens.2} / \text{Ref.Dens.})}}{\text{Temp.2} - \text{Ref.Temp}} \right] \times 1,000,000$$

**C = Fluid Expansion Factor**



## 7.4 Computation of Viscosity Coef. A and B

### Computation of Viscosity Coef. A & B

The flow computer solves a generic equation which computes the viscosity in cstk as a function of temperature. Two parameters must be entered for this calculation to be performed. These are the setup parameters Viscosity Coef. A and Viscosity Coef. B. A table listing these values for common fluids is available in Appendix A.

Alternately, if your intended fluid is not listed, the Viscosity Coef. A and B can be derived from two known temperature/viscosity pairs. Begin by obtaining this information for your intended fluid. Convert these known points to units of Degrees F and centistoke (cstk)

The information is now in a suitable form to compute the Viscosity Coef. A and Viscosity Coef. B using the following equation based on the fluid state.

For a liquid, A and B are computed as follows:

$$B = \frac{(T1 + 459.67) \cdot (T2 + 459.67) \cdot \ln [ \text{cstk1}/\text{cstk2} ]}{(T2 + 459.67) - (T1 + 459.67)}$$

$$A = \frac{\text{cstk1}}{\exp [ B / ( T1 + 459.67 ) ]}$$

$$\text{NOTE: cS} = \frac{\text{cP} \cdot \text{Density of Water at } 4^{\circ}\text{C}}{\text{Density of Fluid at Flowing Conditions}}$$

**7.5 Linearization Table**

**Linearization Table General Information**

**7.5.1 Linearization Table General Information**

The Linearization Table is used when the flow input device gives a nonlinear input signal. The unit uses up to 40 different points, as entered by the operator, to form a curve for linearizing the input signal.

Notes:

- 1) A minimum of three points must be set up.
- 2) If "0" is entered for the frequency of any point other than point 1, the Flow Computer assumes there are no more points above the points that preceded them. The display will advance to the next setup prompt.
- 3) If the input frequency is above the highest or below the lowest frequency programmed, the unit will use the last known point for the K factor in computing the resulting actual flow.
- 4) Frequencies, Hz/Cstks or Roshko numbers should be entered in ascending order.

**Linearization Table (Pulse Inputs)**

**7.5.2 Linearization Table for Pulse Inputs**

The linearization table for pulse inputs programming is quite simple when values of frequency and K factors are known. The Flow Computer asks for 40 different frequencies (Freq) and 40 corresponding K factors (K). It then uses this data to determine what the actual volume flow rate is for any given input frequency on the respective flowmeter. Usually the necessary data is provided with the flowmeter.

**Linearization Table Interpolation**

**7.5.3 Linearization Table Interpolation**

The Linearization Table routine uses the entered data to determine the K factor for any given input frequency or input flow signal. This is done by taking the closest data points above and below the input signal, then using those points to interpolate the K factor, then calculating the uncompensated volume flow from the data. Below are the formulas.

Parameters:

Determine closest point above input signal  
 signal = X, K factor (correction factor) = KA

Determine closest point below input signal  
 signal = Y, K factor (correction factor) = KB

Let input signal = H,  
 unknown K factor (correction factor) = KN

To find KN use this formula:

$$\frac{H - Y}{X - Y} \times (KA - KB) + KB = KN$$

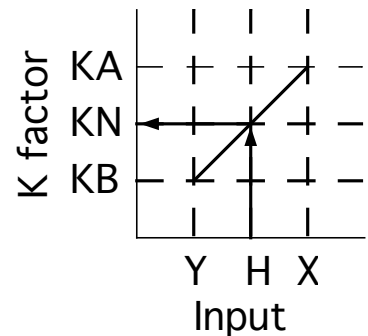

**Universal Viscosity Curve**

**7.6 Universal Viscosity Curve (UVC)**

A Universal Viscosity Curve is a presentation of the calibration of a turbine flowmeter's K-Factor as a function of the Hz/cstks. It is used to represent the combined effects of flowrate and viscosity on the calibration of the flowmeter. It is entered as a table of point pairs in ascending order of Hz/cstks.

**Strouhal Roshko Curve**





**7.7 Strouhal Roshko Curve (StRo)**

A Strouhal Roshko Curve is a presentation of the calibration of a turbine flowmeter's calibration as a table or curve of Strouhal number as a function of Roshko number. It is used to represent the combined effects of flowrate, flow-temperature and viscosity on the calibration of the turbine flowmeter. It is entered as a table of point pairs in ascending order of Roshko numbers.



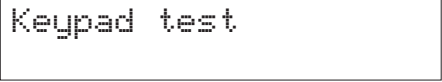

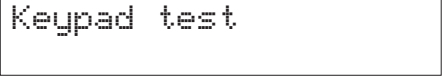
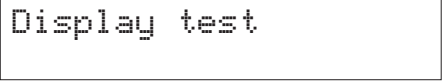

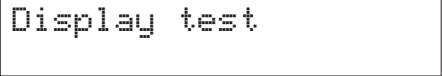







## 8.2 Test Sub-Menus





| Sub-menus                                                         | Display                                                                                                      | Notes                                                                                                                                                       |
|-------------------------------------------------------------------|--------------------------------------------------------------------------------------------------------------|-------------------------------------------------------------------------------------------------------------------------------------------------------------|
| <b>8.2.1</b><br><b>Audit Trail</b><br><b>Submenu Group</b>        | <pre>Audit Trail</pre>                                                                                       | Press Enter to view the audit trail information.                                                                                                            |
|                                                                   | <pre>                     Config_Audit  nnnnn                     hh:mm:ss  dd/mm/yy                 </pre>  | The configuration audit trail format:<br>nnnnn= number of critical menu changes,<br>hh:mm:ss; mm/dd/yy = time and date of last change.                      |
|                                                                   | <pre>                     Cal_Audit  nnnnn                     hh:mm:ss  dd/mm/yy                 </pre>     | The calibration audit trail format:<br>nnnnn= number of calibration changes,<br>hh:mm:ss; dd/mm/yy = time and date of last change.                          |
|                                                                   | <pre>Audit Trail</pre>                                                                                       | Press Menu to get back to audit trail top-level menu.                                                                                                       |
| <b>8.2.2</b><br><b>Error History</b><br><b>Submenu Group</b>      | <pre>Error history</pre>                                                                                     | Press Enter to view error history.<br><b>NOTE:</b> Press Print Key to print Error History. Printout will include time/date of each errors first occurrence. |
|                                                                   | <pre>                     Error history                     Flow rate alarm low                 </pre>       | Press Up/Down arrow keys to scroll through all error message history. Press CLEAR to clear entire error log.                                                |
|                                                                   | <pre>Error history</pre>                                                                                     | Press Menu to get back to error history top-level menu.                                                                                                     |
| <b>8.2.3</b><br><b>Print System Setup</b><br><b>Submenu Group</b> | <pre>Print System Setup</pre>                                                                                | Press enter key to enter print system setup submenu                                                                                                         |
|                                                                   | <pre>                     Print System Setup                     Press ENTER to print                 </pre> | Press enter to begin printing the system setup.                                                                                                             |
|                                                                   | <pre>                     Print System Setup                     -- Printing ---                 </pre>      | This message will display as the data transmission takes place.                                                                                             |
|                                                                   | <pre>Print System Setup</pre>                                                                                | Press Menu to get back to print system setup top-level menu.                                                                                                |

| Sub-menus                                                   | Display                                                                             | Notes                                                                                                  |
|-------------------------------------------------------------|-------------------------------------------------------------------------------------|--------------------------------------------------------------------------------------------------------|
| <b>8.2.4</b><br><b>Keypad test</b><br><b>Submenu Group</b>  |    | Press Enter to enter keypad test                                                                       |
|                                                             |    | Press the various keys and the display will show the key that was pressed. Press Menu to exit the test |
|                                                             |    | Press Menu to get back to Keypad test top-level menu.                                                  |
| <b>8.2.5</b><br><b>Display test</b><br><b>Submenu Group</b> |    | Press Enter to enter display test.                                                                     |
|                                                             |   | Upon pressing enter, each digit on the display will scroll 0-9 then A-Z. Press menu to exit the test.  |
|                                                             |  | Press Menu to get back to Display test top-level menu.                                                 |







**ALL UNITS ARE CALIBRATED AT THE FACTORY PRIOR TO SHIPMENT**  
**CAUTION:**  
 This unit must be calibrated using precision and calibrated equipment.  
 Equipment needed is as follows: Frequency Generator, Digital Multimeter,  
 Precision Current/Voltage Source, Oscilloscope, Frequency Counter.









| <u>Sub-menus</u>                            | <u>Display</u>                                                                                                                                                                                                                                                                                                                                      | <u>Notes</u>                                                                                                                               |
|---------------------------------------------|-----------------------------------------------------------------------------------------------------------------------------------------------------------------------------------------------------------------------------------------------------------------------------------------------------------------------------------------------------|--------------------------------------------------------------------------------------------------------------------------------------------|
| Calibration Submenu Group                   | <div style="border: 1px solid black; padding: 5px; width: fit-content; margin: 0 auto;">Calibrate</div> <div style="text-align: center; margin-top: 5px;">  </div>                                                                                                 | Press Enter to begin the calibration routine. (Please note the caution above)                                                              |
| 8.2.6<br>Calibrate Aux1: 0mA Submenu Group  | <div style="border: 1px solid black; padding: 5px; width: fit-content; margin: 0 auto;">                     Calibrate Aux1: 0mA<br/>                     Iin=TB1-7 GND=TB1-4                 </div> <div style="text-align: center; margin-top: 5px;">  </div>    | Connect Current Source (+) TB1-7, (-) TB1-4. Input 0mA and press Enter.                                                                    |
|                                             | <div style="border: 1px solid black; padding: 5px; width: fit-content; margin: 0 auto;">                     Calibrate Aux1: 0mA<br/>                     CALIBRATING --                 </div> <div style="text-align: center; margin-top: 10px;">  </div>       | This message is displayed during calibration.                                                                                              |
|                                             | <div style="border: 1px solid black; padding: 5px; width: fit-content; margin: 0 auto;">                     Calibrate Aux1: 0mA<br/>                     *** DONE ***                 </div> <div style="text-align: center; margin-top: 10px;">  </div>        | This message is displayed when the 0mA calibration is finished.                                                                            |
|                                             | <div style="border: 1px solid black; padding: 5px; width: fit-content; margin: 0 auto;">                     Calibrate Aux1: 0mA<br/>                     Iin=TB1-7 GND=TB1-4                 </div> <div style="text-align: center; margin-top: 5px;">  </div>  | The display will automatically return to the Calibrate Aux1 0mA submenu. Press the Down arrow key to advance to the Aux1 20mA calibration. |
| 8.2.7<br>Calibrate Aux1: 20mA Submenu Group | <div style="border: 1px solid black; padding: 5px; width: fit-content; margin: 0 auto;">                     Calibrate Aux1: 20mA<br/>                     Iin=TB1-7 GND=TB1-4                 </div> <div style="text-align: center; margin-top: 5px;">  </div> | Connect Current Source (+) TB1-7, (-) TB1-4. Input 20mA and press Enter.                                                                   |
|                                             | <div style="border: 1px solid black; padding: 5px; width: fit-content; margin: 0 auto;">                     Calibrate Aux1: 20mA<br/>                     0 CALIBRATING --                 </div> <div style="text-align: center; margin-top: 10px;">  </div>   | This message is displayed during calibration.                                                                                              |
|                                             | <div style="border: 1px solid black; padding: 5px; width: fit-content; margin: 0 auto;">                     Calibrate Aux1: 20mA<br/>                     *** DONE ***                 </div> <div style="text-align: center; margin-top: 10px;">  </div>       | This message is displayed when the 20mA calibration is finished.                                                                           |
|                                             | <div style="border: 1px solid black; padding: 5px; width: fit-content; margin: 0 auto;">                     Calibrate Aux1: 20mA<br/>                     Iin=TB1-7 GND=TB1-4                 </div> <div style="text-align: center; margin-top: 5px;">  </div> | The display will automatically return to the Calibrate Aux1 20mA submenu. Press the Down arrow key to advance to the Aux2 0mA calibration. |
|                                             | <p>Advance to<br/>Calibrate Aux2: 0mA</p>                                                                                                                                                                                                                                                                                                           |                                                                                                                                            |

| Sub-menus                                                             | Display                                                                                                                                 | Notes                                                                                                                                           |
|-----------------------------------------------------------------------|-----------------------------------------------------------------------------------------------------------------------------------------|-------------------------------------------------------------------------------------------------------------------------------------------------|
| <b>8.2.8</b><br><b>Calibrate Aux2: 0mA</b><br>Submenu Group           | <pre>Calibrate Aux2: 0mA Iin=TB1-8 GND=TB1-4</pre>     | To Calibrate: Connect Current Source (+) TB1-8, (-) TB1-4. Input 0mA and press Enter.                                                           |
|                                                                       | <pre>Calibrate Aux2: 0mA 0 CALIBRATING --</pre>                                                                                         | This message is displayed during calibration.                                                                                                   |
|                                                                       | <pre>Calibrate Aux2: 0mA *** DONE ***</pre>                                                                                             | This message is displayed when the 0mA calibration is finished.                                                                                 |
|                                                                       | <pre>Calibrate Aux2: 0mA Iin=TB1-8 GND=TB1-4</pre>     | The display will automatically return to the Calibrate Aux2 0mA submenu. Press the Down arrow key to advance to the AUX2 20mA calibration.      |
| <b>8.2.9</b><br><b>Calibrate Aux2: 20mA</b><br>Submenu Group          | <pre>Calibrate Aux2: 20mA Iin=TB1-8 GND=TB1-4</pre>  | To Calibrate: Connect Current Source (+) TB1-8, (-) TB1-4. Input 20mA and press Enter.                                                          |
|                                                                       | <pre>Calibrate Aux2: 20mA 0 CALIBRATING --</pre>                                                                                        | This message is displayed during calibration.                                                                                                   |
|                                                                       | <pre>Calibrate Aux2: 20mA *** DONE ***</pre>                                                                                            | This message is displayed when the 20mA calibration is finished.                                                                                |
|                                                                       | <pre>Calibrate Aux2: 20mA Iin=TB1-8 GND=TB1-4</pre>  | The display will automatically return to the Calibrate Aux2 20mA submenu. Press the Down arrow key to advance to the calibrate 0mA output menu. |
| <p style="text-align: center;">Advance to<br/>Cal Therm: 100 Ohms</p> |                                                                                                                                         |                                                                                                                                                 |

| Sub-menus                                               | Display                                                                                                                                                                      | Notes                                                                                                                                                           |
|---------------------------------------------------------|------------------------------------------------------------------------------------------------------------------------------------------------------------------------------|-----------------------------------------------------------------------------------------------------------------------------------------------------------------|
| <p>8.2.10<br/>Cal Therm: 100 Ohms<br/>Submenu Group</p> | <pre>Cal Therm: 100 Ohms Therm TB1-6 to TB1-4</pre>                                         | <p>To Calibrate: Place a 100 ohm 0.1% resistor between TB1-6 and TB1-4. Press enter to calibrate.</p>                                                           |
|                                                         | <pre>Cal Therm: 100 Ohms  0 CALIBRATING --</pre>                                                                                                                             | <p>This message is displayed during calibration.</p>                                                                                                            |
|                                                         | <pre>Cal Therm: 100 Ohms *** DONE ***</pre>                                                                                                                                  | <p>This message is displayed when the calibration is finished.</p>                                                                                              |
|                                                         | <pre>Cal Therm: 100 Ohms Therm TB1-6 to TB1-4</pre>  <p>Advance to<br/>Cal Therm: Open</p>  | <p>The display will automatically return to the Cal Therm: 100 Ohms top-level menu. Press the Down arrow key to advance to the Thermistor Open calibration.</p> |
| <p>8.2.11<br/>Cal Therm: Open<br/>Submenu Group</p>     | <pre>Cal Therm: Open Therm TB1-6 to TB1-4</pre>                                           | <p>To Calibrate: Remove the 100Ω 0.1% resistor from TB1-6 and TB1-4 and leave open. Press enter to calibrate.</p>                                               |
|                                                         | <pre>Cal Therm: Open  0 CALIBRATING --</pre>                                                                                                                                 | <p>This message is displayed during calibration.</p>                                                                                                            |
|                                                         | <pre>Cal Therm: Open *** DONE ***</pre>                                                                                                                                      | <p>This message is displayed when the calibration is finished.</p>                                                                                              |
|                                                         | <pre>Cal Therm: Open Therm TB1-6 to TB1-4</pre>  <p>Advance to<br/>Calibrate Aux2: 0V</p> | <p>The display will automatically return to the Cal Therm Open top-level menu. Press the Down arrow key to advance to the Aux2: 0V calibration.</p>             |













| Sub-menus                                                             | Display                                                                                                                                 | Notes                                                                                                                                                     |
|-----------------------------------------------------------------------|-----------------------------------------------------------------------------------------------------------------------------------------|-----------------------------------------------------------------------------------------------------------------------------------------------------------|
| <b>8.2.12</b><br><b>Calibrate Aux2: 0V</b><br><b>Submenu Group</b>    | <pre>Calibrate Aux2:  0V Vin=TB1-5  GND=TB1-4</pre>    | To Calibrate: Connect Voltage Source (+) TB1-5, (-) TB1-4. Input 0V and press Enter.                                                                      |
|                                                                       | <pre>Calibrate Aux2:  0V  0 CALIBRATING --</pre>                                                                                        | This message is displayed during calibration.                                                                                                             |
|                                                                       | <pre>Calibrate Aux2:  0V *** DONE ***</pre>                                                                                             | This message is displayed when the 0V calibration is finished.                                                                                            |
|                                                                       | <pre>Calibrate Aux2:  0V Iin=TB1-5  GND=TB1-4</pre>    | The display will automatically return to the Calibrate Aux2 0V top-level menu. Press the Down arrow key to advance to the Aux2 10V calibration.           |
| <b>8.2.13</b><br><b>Calibrate Aux2: 10V</b><br><b>Submenu Group</b>   | <pre>Calibrate Aux2: 10V Iin=TB1-5  GND=TB1-4</pre>  | To Calibrate: Connect Voltage Source (+) TB1-5, (-) TB1-4. Input 10V and press Enter.                                                                     |
|                                                                       | <pre>Calibrate Aux2: 10V  0 CALIBRATING --</pre>                                                                                        | This message is displayed during calibration.                                                                                                             |
|                                                                       | <pre>Calibrate Aux2: 10V *** DONE ***</pre>                                                                                             | This message is displayed when the 10V calibration is finished.                                                                                           |
|                                                                       | <pre>Calibrate Aux2: 10V Iin=TB1-5  GND=TB1-4</pre>  | The display will automatically return to the Calibrate Aux2 10V top-level menu. Press the Down arrow key to advance to the 100 ohm RTD calibration.       |
| Advance to<br>Cal RTD 100ohm                                          |                                                                                                                                         |                                                                                                                                                           |
| <b>8.2.14</b><br><b>Calibrate 100 ohm RTD</b><br><b>Submenu Group</b> | <pre>Cal RTD 100ohm JMP TB1-6,7 100R=7,8</pre>       | To Calibrate: Connect a jumper wire between TB1-6 and TB1-7, Place a 100 ohm 0.1% resistor between TB1-7 and TB1-8. Press enter to calibrate.             |
|                                                                       | <pre>Cal RTD 100ohm  0 CALIBRATING --</pre>                                                                                             | This message is displayed during calibration.                                                                                                             |
|                                                                       | <pre>Cal RTD 100ohm *** DONE ***</pre>                                                                                                  | This message is displayed when the RTD calibration is finished.                                                                                           |
|                                                                       | <pre>Cal RTD 100ohm JMP TB1-6,7 100R=7,8</pre>       | The display will automatically return to the Calibrate 100 ohm RTD top-level menu. Press the Down arrow key to advance to the 0mA analog out calibration. |
| Advance to<br>Calibrate 0mA Aout                                      |                                                                                                                                         |                                                                                                                                                           |





| Sub-menus                                             | Display                                                                                                                                                                                                                  | Notes                                                                                                                                                                                                                   |
|-------------------------------------------------------|--------------------------------------------------------------------------------------------------------------------------------------------------------------------------------------------------------------------------|-------------------------------------------------------------------------------------------------------------------------------------------------------------------------------------------------------------------------|
| <b>8.2.15</b><br>Calibrate 0mA Aout<br>Submenu Group  | <pre>Calibrate 0mA Aout + TB1-15      - TB1-16</pre>                                                                                                                                                                     | Connect ammeter to (+) TB1-15, (-) TB1-16. Press enter.                                                                                                                                                                 |
|                                                       |  <pre>Calibrate 0mA Aout Enter mA: 0.00000</pre>                                                                                        | To trim 0mA analog output: Press CLEAR to enable editing and enter a small negative number (i.e. -0.100) to force a display reading, then clear and enter small quantity measured on your meter.                        |
|                                                       |  <pre>Calibrate 0mA Aout + TB1-15      - TB1-16</pre>  | The display will return to Calibrate 0mA out. Press the down arrow key to advance to the 20mA analog out or repeat above if necessary.                                                                                  |
| <b>8.2.16</b><br>Calibrate 20mA Aout<br>Submenu Group | <pre>Calibrate 20mA Aout + TB1-15      - TB1-16</pre>                                                                                                                                                                    | Connect ammeter to (+) TB1-15, (-) TB1-16. Press enter.                                                                                                                                                                 |
|                                                       |  <pre>Calibrate 20mA out Enter mA: 20.00000</pre>                                                                                       | To trim 20mA analog output: Press CLEAR to enable editing and enter the current reading that is on the ammeter display. Press enter.                                                                                    |
|                                                       |  <pre>Calibrate 20mA Aout + TB1-15      - TB1-16</pre>                                                                                | The display will automatically return to the Calibrate 20mA Aout submenu. Calibration is complete.                                                                                                                      |
|                                                       |  <pre>Calibrate</pre>                                                                                                                 | Press the Menu key to go back to Calibrate top-level menu.                                                                                                                                                              |
| <b>8.2.17</b><br>Analog In Test<br>Submenu Group      | <pre>Analog In Test</pre>                                                                                                                                                                                                | Press enter to test the analog inputs.                                                                                                                                                                                  |
|                                                       |  <pre>Analog In Test    mA T7:00.000  T8:00.000</pre>                                                                                 | To check current input accuracy: Use TB1-4 as Reference Ground, input 0-20mA to TB1-7 and/or TB1-8. Display should show current being input. Use ammeter to verify input. Use Up/Down arrow keys to check other inputs. |
|                                                       |  <pre>Analog In Test</pre>                                                                                                            | Press Menu key to return to Analog In Test top-level menu.                                                                                                                                                              |

**NOTE:**

Press the  $\Delta \nabla$  keys for additional analog input tests for RTD, Thermistor, and Voltage on terminal 5. Connect only one signal type at a time based on the Analog Input test being performed.

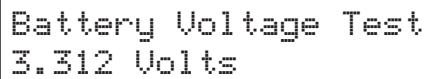
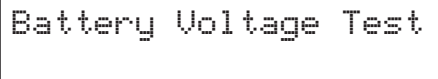
| Sub-menus                                                                         | Display                                                                                                                                                                                                                                                                                                                                                                                                              | Notes                                                                                                                                                                                                                |
|-----------------------------------------------------------------------------------|----------------------------------------------------------------------------------------------------------------------------------------------------------------------------------------------------------------------------------------------------------------------------------------------------------------------------------------------------------------------------------------------------------------------|----------------------------------------------------------------------------------------------------------------------------------------------------------------------------------------------------------------------|
| <b>8.2.18</b><br><b>Pulse input test</b><br><b>Submenu Group</b>                  | <div style="border: 1px solid black; padding: 5px; text-align: center;">Pulse input test</div>                                                                                                                                                                                                                                                                                                                       | Press Enter key to test the pulse input.                                                                                                                                                                             |
|  | <div style="border: 1px solid black; padding: 5px; text-align: center;">                         ENTER: <br/>                         Pulse input test<br/>                         Trigger level 2.50<br/>                         ENTER:  </div> | Use the Up/Down arrow keys to select the appropriate trigger level.                                                                                                                                                  |
|  | <div style="border: 1px solid black; padding: 5px; text-align: center;">                         Pulse input test<br/>                         count speed 3kHz<br/>                         ENTER:  </div>                                                                                                                         | Use the Up/Down arrow keys to select the appropriate frequency range.                                                                                                                                                |
|                                                                                   | <div style="border: 1px solid black; padding: 5px; text-align: center;">                         Pulse input test<br/>                         F1: 0 F2: 0<br/>                         MENU:  </div>                                                                                                                               | To check Pulse input accuracy at the above settings: Use TB1-4 as reference ground, input a frequency on TB1-2 and/or TB1-3. The display should show frequency being input. Use a frequency counter to verify input. |
|                                                                                   | <div style="border: 1px solid black; padding: 5px; text-align: center;">Pulse input test</div>                                                                                                                                                                                                                                                                                                                       | Press Menu key to return to Pulse input test top-level menu.                                                                                                                                                         |
| <b>8.2.19</b><br><b>Analog out test</b><br><b>Submenu Group</b>                   | <div style="border: 1px solid black; padding: 5px; text-align: center;">Analog out test</div>                                                                                                                                                                                                                                                                                                                        | Press Enter to test the analog output.                                                                                                                                                                               |
|                                                                                   | <div style="border: 1px solid black; padding: 5px; text-align: center;">                         ENTER: <br/>                         Analog out test<br/>                         *0 4 10 15 20 mA<br/>                         MENU:  </div> | To simulate analog output: Connect an ammeter to (+) TB1-15, (-) TB1-16. Press the key under the desired setting to move the asterisk (*). The unit should output the selected current.                              |
|                                                                                   | <div style="border: 1px solid black; padding: 5px; text-align: center;">Analog out test</div>                                                                                                                                                                                                                                                                                                                        | Press Menu key to return to Analog out test top-level menu.                                                                                                                                                          |
| <b>8.2.20</b><br><b>Excitation out test</b><br><b>Submenu Group</b>               | <div style="border: 1px solid black; padding: 5px; text-align: center;">Excitation out test</div>                                                                                                                                                                                                                                                                                                                    | Press Enter to test the excitation output.                                                                                                                                                                           |
|                                                                                   | <div style="border: 1px solid black; padding: 5px; text-align: center;">                         ENTER: <br/>                         Excitation out test<br/>                         *5v 12v 24v<br/>                         MENU:  </div>  | To test the excitation output: Connect a voltmeter to (+) TB1-1, (-) TB1-4. Press the key under the desired setting to move the asterisk (*). The unit should output the selected voltage.                           |
|                                                                                   | <div style="border: 1px solid black; padding: 5px; text-align: center;">Excitation out test</div>                                                                                                                                                                                                                                                                                                                    | Press Menu key to return to Excitation out test top-level menu.                                                                                                                                                      |

| Sub-menus                                              | Display                                        | Notes                                                                                                                                                                                                                     |
|--------------------------------------------------------|------------------------------------------------|---------------------------------------------------------------------------------------------------------------------------------------------------------------------------------------------------------------------------|
| <p>8.2.21<br/>Pulse out test<br/>Submenu Group</p>     | <p>Pulse out test</p>                          | <p>Press Enter key to test the pulse output.</p>                                                                                                                                                                          |
|                                                        | <p>Pulse out test<br/>*0Hz 1Hz 10Hz 20Hz</p>   | <p>To simulate a frequency on the pulse output: Connect a frequency counter to (+)TB1-13, (-)TB1-14. Press the key under the desired setting to move the asterisk (*). The unit should output the selected frequency.</p> |
|                                                        | <p>Pulse out test</p>                          | <p>Press Menu key to return to Pulse out test top-level menu.</p>                                                                                                                                                         |
| <p>8.2.22<br/>Relay test<br/>Submenu Group</p>         | <p>Relay Test</p>                              | <p>Press Enter to test the relays.<br/> Turning ON Relay 1 will close the bypass valve if it is connected.</p>                           |
|                                                        | <p>R1y1 R1y2 R1y3 R1y4<br/>Off Off Off Off</p> | <p>To manually control the relay outputs: Press the key under the desired relay to toggle the relays On/Off. Use an ohmmeter to check the relay contacts.</p>                                                             |
|                                                        | <p>Relay Test</p>                              | <p>Press Menu key to return to Relay Test top-level menu.</p>                                                                                                                                                             |
| <p>8.2.23<br/>Control input test<br/>Submenu Group</p> | <p>Control inputs test</p>                     | <p>Press Enter to test the control inputs.</p>                                                                                                                                                                            |
|                                                        | <p>TB1-9 TB1-10 TB1-11<br/>Off Off Off</p>     | <p>To check the control inputs: Use TB1-12 as reference, input a positive 3-30 VDC signal to TB1-9, TB1-10 and/or TB1-11, The Display will show ON when input is active, OFF when inactive.</p>                           |
|                                                        | <p>Control inputs test</p>                     | <p>Press Menu key to return to control input test top-level menu.</p>                                                                                                                                                     |

| Sub-menus                                                            | Display                                                                             | Notes                                                                                                          |
|----------------------------------------------------------------------|-------------------------------------------------------------------------------------|----------------------------------------------------------------------------------------------------------------|
| <b>8.2.24</b><br><b>Battery Voltage test</b><br><b>Submenu Group</b> |    | Press Enter key to view the battery voltage.                                                                   |
|                                                                      |    | The display will show the battery voltage. Replace battery at 2.5 VDC or below.                                |
|                                                                      |    | Press Menu key to return to battery voltage test top-level menu.                                               |
| <b>8.2.25</b><br><b>Data logger utility</b><br><b>Submenu Group</b>  |    | Press Enter to use data logger utility.                                                                        |
|                                                                      |    | The displays shows the number of Data Logs. Press the Down arrow key to advance to PRT (print) or CLR (clear). |
|                                                                      |  | Press F3 PRINT key to output data logger logs to printer, Press CLEAR key to clear the data logger contents.   |
|                                                                      |  | Press Menu key to return to Data logger utility top-level menu.                                                |

### 8.3 Internal Fuse Replacement

#### Instructions:

1. Make sure you follow proper E.S.D. Precautions. All persons performing this replacement must follow proper grounding procedures.
2. Turn the power to the unit off.
3. Disconnect the two piece connector rear terminal block, leaving all connections in place.
4. Remove the unit from the panel.
5. Remove the four machine screws (see fig. 1) which hold the two sections of the case together.
6. The rear section of the case should detach from the rest of the case. It may be necessary to cut the wiring label along the joint where the two sections connect. With the rear section of the case removed the fuse will be exposed (located near the rear terminal, AC connection).
7. Locate the Fuse F1 (see fig. 2) and unplug the fuse from its socket.
8. Insert the new fuse into the socket. Insure that the pins are fully inserted and straight.
9. Reassemble the case and install the four machine screws which join the two sections of the case.
10. Reinstall the unit into the panel.
11. Reconnect the rear terminal block.
12. Turn the unit back on.

#### Fuse Specifications:

- |                  |                |                                   |
|------------------|----------------|-----------------------------------|
| 110 VAC Power:   | 160mA/250V, TD | Wickman 19372-030-k or equivalent |
| 220 VAC Power:   | 80mA/250V, TD  | Wickman 19372-026-k or equivalent |
| 12/24 VDC Power: | 800mA/250V, TD | Wickman 19374-046-k or equivalent |

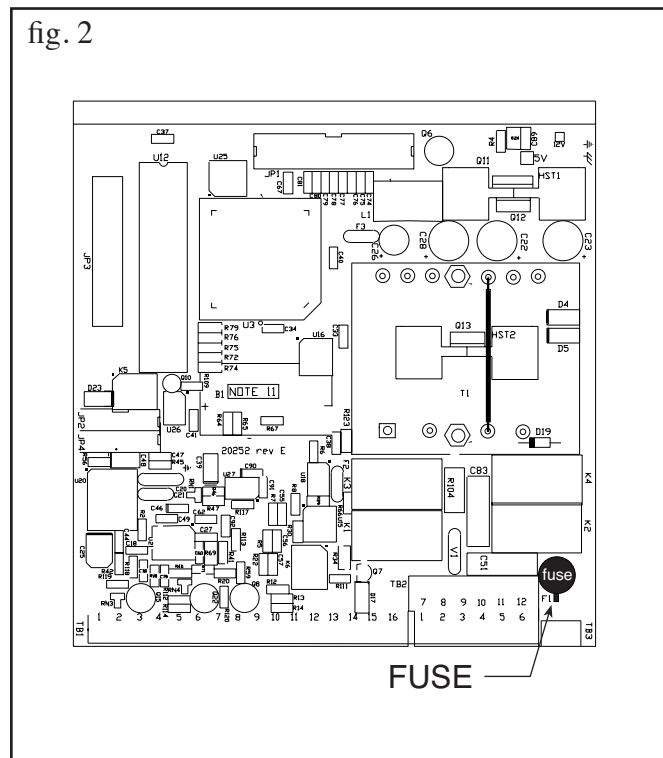
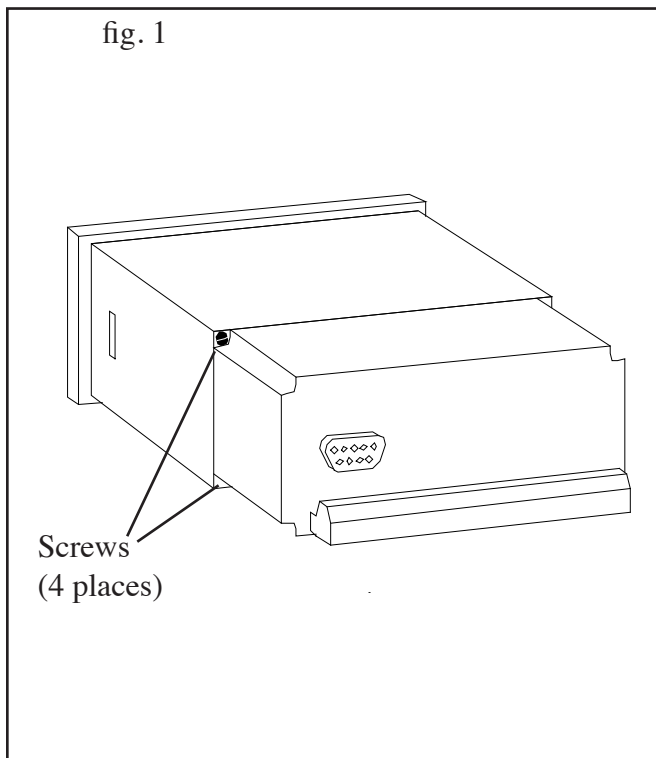

## 9. RS-232 Serial Port

### 9.1 RS-232 Port Description:

The ST1-MANIFOLD-FC has a general purpose RS-232 Port which may be used for any one of the following purposes:

- Transaction Printing
- Data Logging
- Remote Metering by Modem (optional)
- Computer Communication Link
- Configuration by Computer
- Print System Setup
- Print Calibration/Malfunction History

### 9.2 Instrument Setup by PC's over Serial Port

A Diskette program is provided with the ST1-MANIFOLD-FC that enables the user to rapidly configure the ST1-MANIFOLD-FC using a Personal Computer. Included on the diskette are common instrument applications which may be used as a starting point for your application. This permits the user to have an excellent starting point and helps speed the user through the instrument setup.

### 9.3 Operation of Serial Communication Port with Printers

ST1-MANIFOLD-FC's RS-232 channel supports a number of operating modes. One of these modes is intended to support operation with a printer in metering applications requiring transaction printing, data logging and/or printing of calibration and maintenance reports.

For transaction printing, the user defines the items to be included in the printed document. The user can also select what initiates the transaction print generated as part of the setup of the instrument. The transaction document may be initiated via a front panel key depression or upon a remote contact closure.

In data logging, the user defines the items to be included in each data log as a print list. The user can also select when or how often he wishes a data log to be made. This is done during the setup of the instrument as either a time of day or as a time interval between logging.

The system setup and maintenance report list all the instrument setup parameters and usage for the current instrument configuration. In addition, the Audit trail information is presented as well as a status report listing any observed malfunctions which have not been corrected. The user initiates the printing of this report at a designated point in the menu by pressing the print key on the front panel.

### 9.4 ST1-MANIFOLD-FC RS-232 Port Pinout

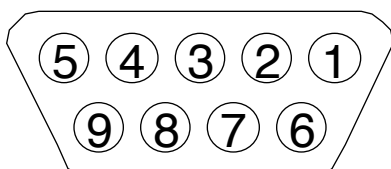

- 1 Handshake Line
- 2 Transmit
- 3 Receive
- 4 Optional Modem Power Out (+)
- 5 Ground
- 6 Optional Modem Power Out (+)
- 7 Do Not Use
- 8 Do Not Use
- 9 Do Not Use

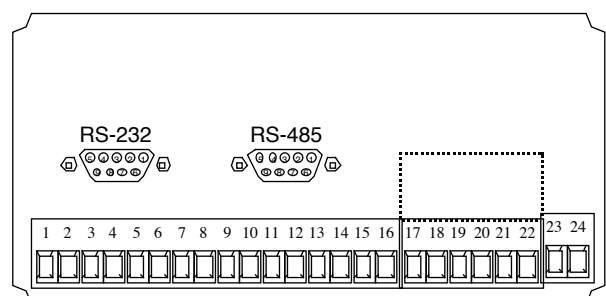

## 10. RS-485 Serial Port (optional)

### 10.1 RS-485 Port Description:

The ST1-MANIFOLD-FC has a an optional general purpose RS-485 Port which may be used for any one of the following purposes:

#### Accessing Process Parameters

Manifold Flow, Flow1, Flow2 Rate, Temperatures, Densities, Viscosities, Setpoints, Month, Day, Year, Hour, Minutes, Seconds, etc.

#### Accessing System Alarms

System, Process, Self Test, Service Test Errors

#### Accessing Totalizers

Manifold Flow Totalizers and Grand Totalizer

#### Executing Various Action Routines

Reset Alarms, Reset Totalizers, Print Transaction, Reset Error History

### 10.2 General

The optional RS-485 card utilizes Modbus RTU protocol to access a variety of process parameters and totalizers. In addition, action routines can be executed. See Appendix C for further information and details on this option.

### 10.3 Operation of Serial Communication Port with PC

The flow computer's RS-485 channel supports a number of Modbus RTU commands. Refer to port pinout (below) for wiring details. Modbus RTU drivers are available from third party sources for a variety of Man Machine Interface software for IBM compatible PC's.

The user reads and writes information from/to the RS-485 using the Modbus RTU commands. The ST1-MANIFOLD-FC then responds to these information and command requests.

Process variables and totalizers are read in register pairs in IEEE 32 bit floating point format. Time and date are read as a series of integer register values. Alarms are individually read as coils. Action routines are initiated by writing to coils.

### 10.4 ST1-MANIFOLD-FC RS-485 Port Pinout

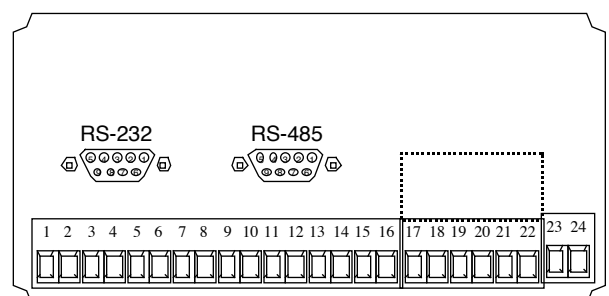
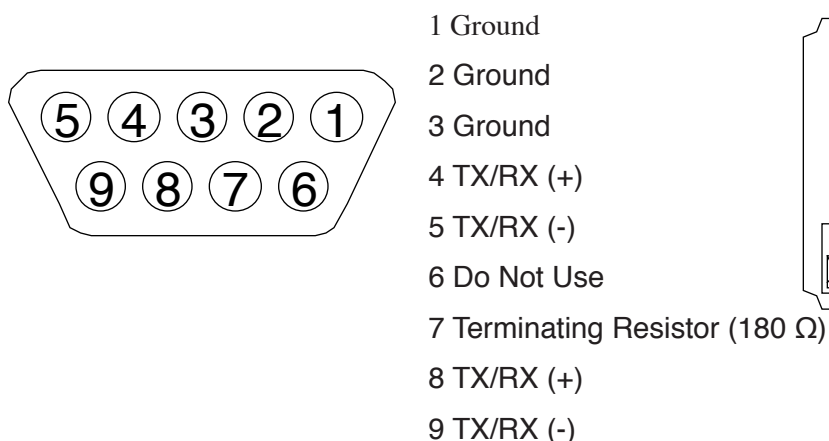

**NOTE:** To terminate cable end, connect Pin 7 to either Pin 4 or Pin 8.



## 11. Flow Computer Setup Software

The ST1-MANIFOLD-FC setup program provides for configuring, monitoring and controlling a ST1-MANIFOLD-FC unit over the RS-232 link.

Sample applications are stored in disk files. The setup program calls these *Templates*. You can store the setup from the program's memory to either the ST1-MANIFOLD-FC (*Downloading* the file) or to a disk file (*Saving* the file) for later usage. Similarly you can load the setup in program memory from either a disk file (*Opening* a file) or from the ST1-MANIFOLD-FC unit (*Uploading* a file).

The program can monitor outputs from the unit while it is running.

The program can reset alarms and totalizers.

For assistance there are mini-helps at the bottom of each screen in the program. There is also context sensitive help available for each screen accessible by pressing the F1 key.

### 11.1 System Requirements:

Windows® XP/Vista/7/8/10

4 MB RAM

3 MB free disk space

Communication Port - RS-232 (A USB to RS232 converter is required for PCs without RS-232 port)

RS-232 Cable - Mounting Style "P" - Panel Mount units require a cable which matches the available communication port on your PC and a 9 pin male connection for the ST1LE serial port.

Mounting Style "W" - Wall Mount units require a cable which matches the available communication port on your PC and a 4 wire connection to the terminal block on ST1LE serial port. A RS232 DB 9 female to individual wires may be required in order to connect to the terminal block RS232 connector in this enclosure style.

### 11.2 Cable and Wiring Requirements:

The serial communication port on your PC is either a 25 pin or 9 pin connector. No cabling is supplied with the setup software. A cable must be purchased separately or made by the user. It is recommended to purchase a modem cable which matches the available communication port on your PC and a 9 pin male connection for the ST1LE serial port.

### 11.3 Installation for Windows

It is good practice to quit all unnecessary programs running before beginning the installation procedure. In some instances, it may be required that anti-virus programs be disabled.

Software installation can be done either from a file downloaded from our website or from an installation disc provided with the product. To install from the disc, simply open the CD/DVD drive and insert the installation disc.

A setup wizard window should be launched. In case there is none, open the Explorer and navigate to the CD/DVD drive. Double click on the Setup file.

Once the wizard is running, simply follow the prompts until the installation process is completed.

For installation from the Web, launch your browser application and download the setup file to your hard drive.

After completion of the downloading process, run the setup program to execute the setup wizard that will handle the automatic installation of the software.

## 11.4 Using the Flow Computer Setup Software

The setup software window consists of several menu “Tabs”. Each tab is organized into groups containing various configuration and/or monitoring functions. To view the tab windows, simply click on the tab. The previous tab window will be hidden as the new tab window is brought to the foreground.

## 11.5 File Tab

The File Tab has three sections. Any of the options on this tab can also be accessed from the File submenu.

The **Template Section** provides for opening and saving templates. The *Save* and *Save As* buttons provide the standard Windows functionality for dealing with files. The *Open* button is used to open existing templates or files.

There are two additional menu items available *only* from the pull down File menu: *Open existing file* and *Templates*.

The *Open existing file*, option allows for creating custom templates using one of the existing template in memory as the starting point. Assign a new name for this new template. The template will be saved under this new name.

The *Open Template* option will bring up a list of predefined templates that can be loaded into the program. These predefined templates are useful as a starting point when defining custom templates.

A typical scenario using the setup program would be the following:

- Open up a predefined template from the supplied list
- Choose ‘Save As’ to save this to a new file name
- Proceed to customize the template by making any changes that are needed
- Save the setup to disk (if you want to reuse this template)
- Download the template to an attached unit.

The **Communications with ST1-MANIFOLD-FC Section** allows the user to upload the setup from the unit or download the setup to the unit.

The **Print (report) Section** allows the user to:

1. Configure the current Windows printer through the Select Printer option.
2. Print a Maintenance Report through the PC's printer using the Print Maintenance option.
3. Print the current setup through the PC's printer using Print Setup option.

## 11.6 Setup Tab

The Setup tab is where majority of the ST1-MANIFOLD-FC instrument setup modifications are done. The Setup tab is divided into five sections.

**System Section:** Flow Equation, Indicators

**Input Section:** Flow, Fluid, Aux 1 & 2 (Compensation Inputs 1 & 2),  
Control Inputs

**Output Section:** Pulse, Currents

**Relay Section:** Relays 1, 2, 3, 4

**Other Settings Section:** Administration, Communication, Serial Usage,  
Datalog Printing, Time Clock

**NOTE:** Many setup items are enabled or disabled depending on previous setup selections, It is important to work your way through the above list in the order shown. Be sure to verify your selections when you are through programming to insure that no settings were changed automatically.

## 11.7 View Tab

The View Tab screen allows for viewing selected group items on the PC in a similar format as shown on the unit display. Data from the following groups can be viewed in the List of Values section:

Process Parameters (i.e. rate, temperature)

Totalizers (i.e. total, grand total)

Error Log

Software Version

The setup software assumes the current setup has been uploaded from the flow computer into the PC. It is important that the setup program and the ST1-MANIFOLD-FC unit are using the same setup information at all times or the data will be inconsistent. It is best to upload or download the setup before using this feature.

To start the viewer, first check the boxes of items to view and then click the start button. The data will appear in the appropriate sections and will be continuously updated. The refresh rate is dependent on the number of items that are being viewed and the baud rate of the connection. Data in the List of Values section can be collapsed by clicking on the 'minus' sign in front of the group title. The data can be expanded by clicking on the 'plus' sign in front of the group title. If a group is collapsed and data in the group changes on refresh, the group will automatically expand. Changing the view items requires stopping the current viewing, checking the new selections and then restarting the viewer.

If communication errors occur while reading data from the ST1-MANIFOLD-FC device, the word 'Error' will appear in place of the actual value. If the connection to the ST1-MANIFOLD-FC is lost, the viewer will time out with a message saying the device is not responding.

The viewer will attempt to communicate with the ST1-MANIFOLD-FC device matching the device ID set in the communications screen. If you are having trouble establishing communication, compare settings for the PC and the flow computer. Also verify the connections between the PC and flow computer.

## 11.8 Misc. Tab

This tab has three sections: Tools, Actions and Options.

The tools section contains various system administration activities such as creating/modifying the initial sign-on screen.

Create Sign-on and Create Print Header

The Actions section is used to send commands to the ST1-MANIFOLD-FC unit.

Reset Totalizers, Reset Alarms, Reset Alarm History

The Options section has the following selections:

Network Card Setup

Additional capabilities may be provided in the future.

**NOTE:** Future options appear as disabled buttons on the screen.

## 12. Glossary Of Terms

### Acknowledge & Clear Alarms

Acknowledge is used to clear alarm relays and remove any visual alarm messages from the display. In the run mode, press the ENTER key or activate CONTROL INPUT 3 (if set for *ACK*) to momentarily clear alarms and alarm messages. Alarms will reassert themselves if alarm conditions are still present.

### Analog Output

The analog signal (4-20mA) that is generated by the ST1-MANIFOLD-FC. It can correspond to the Manifold Flow Rate or Total. This output is used primarily for transmission of process information to remote systems.

### Audit Trail

The audit trail is used to track the number of changes made to the units setup program.

### Baud Rate

The speed of serial communication transmissions, expressed in bits per second.

### Calibration Temperature

The temperature at which a flow sensor was calibrated on a test fluid.

### C-Factor (Fluid Expansion Factor)

A parameter in a flow equation which is used to describe the relationship between density or volume and temperature changes.

### Corrected Volume Flow

The equivalently volume at a reference temperature condition which involves the measurement of liquid volume flow using a flow sensor and temperature sensor to compensate for thermal expansion.

### Custody Transfer

Weights and Measure metering codes often specify several requirements for instruments and mechanisms to prevent and track changes in the setup of an instrument which may be used in the commercial sale of goods. The ST1-MANIFOLD-FC tracks setup and calibration changes via the Audit Trail.

### Data Logger

The capturing of information for later use and the mechanism for specifying the conditions where a capture should be made.

### DC Output / Excitation Voltage

An on-board DC power supply used to power peripheral sensors. The ST1-MANIFOLD-FC offers excitation voltages of 5VDC, 12VDC or 24VDC when powered by AC voltage.

### Default Value

The value to be used by the instrument if a sensor failure or out of range signal is detected.

### Expansion Factor

See C-Factor

### Flow Alarm

A visual indication that the volumetric flowrate is above or below the flow alarm setpoint specified by the user.

### Flow Equation

A recognized relationship between the process parameters for flow, temperature, pressure and density used in flow measurements.

### Follow, Alarm

Alarm relays which are non latching and whose output state is based solely on the comparison of the current process value and the alarm setpoint (trip point).

## 12. Glossary Of Terms (Continued)

### Function Key

A key on a push-button panel or keyboard (whose function is described by the key label) used to perform an instrument function or special routine.

### Handshake

A means of controlling the information flow between two pieces of equipment to prevent the sending device from transmitting information at a rate faster than what can be accepted by the receiver.

### Hysteresis

The relay hysteresis is a "dead band" setting which allows the relay to remain energized for a given amount below the setpoint. This is used to prevent relay chatter when the process value is near the setpoint value.

Example: If the Preset is set at 100, and the hysteresis is set at 10, the relay will energize when the rate, temp or dens. reaches 100, the relay will remain energized until the reading falls below 90.

### Input Termination

Input signal lines on digital inputs often require pullup or pulldown resistor configurations to operate properly with different sensor configurations. The ST1-MANIFOLD-FC contains such resistors and may be enabled via the setup menu.

### Inhibit Totalizer

"*Inhibit Total*" is a Control Input 1 setting that is used to stop the totalization. If enabled, a voltage level on control input 1 will inhibit the total as long as the voltage is present. This feature is useful during meter proving and in applications that provide a sensor to signal the flow computer when fluid is present.

### K-Factor

A scaling factor derived from the pulses produced by a flowmeter output, expressed in pulses per unit (i.e. pulses/gallon)

### Limit Setpoint

An alarm trip point setting which specifies the value or magnitude of a process parameter necessary to activate an alarm indicator or control relay.

### Linear Flowmeter

A flow measurement device whose output is proportional to flow.

### Linearization

The mathematical correction of a nonlinear device. The ST1-MANIFOLD-FC uses a linearization Table which is made up of input/output values and makes interpolations of the table to arrive at a "linearized" measurement.

### LinTbl

Abbreviation for Linearization Table.

### Low Pass Filter

A low pass filter passes low input frequencies while blocking high frequencies. In the ST1-MANIFOLD-FC, this is the maximum input count speed to be encountered in an application. It is expressed in counts per second (Hz).

### Manifold Controller

An electronic instrument that receives inputs from two or more flowmeters and it automatically selects the best flowmeter to use to accurately compute the flowrate through the system by controlling one or more external flow control valves.

### Mass Flow

Mass Flow is inferred by the volumetric flow and density (or implied density) of a fluid.

### Max Window

The max. window time sets the maximum sample time (1 to 99 sec) for the ratemeter.

## 12. Glossary Of Terms (Continued)

### Meter Expansion Coef.

A coefficient in an equation which may be used to correct for changes in flowmeter housing dimensional changes with temperature.

### Modem Init Master

The "Modem Init Master" menu allows the user to select whether the unit will engage in a configuration conversation with the modem on power up or impart no setup information to the modem and use it "as is". For most users it is recommended to choose "yes" for "Modem Init Master".

### Parity

A method for detecting errors in transmissions of serial communications data.

### Preset

A set point used to trigger the relay outputs of the ST1-MANIFOLD-FC.

### Print Interval

The print interval allows the ST1-MANIFOLD-FC to transmit information to the serial port at selectable time intervals.

### Private Code

An operator password code which authorizes changes to the setup of the instrument but blocks access to the Service/Calibration/Test mode. The private code also blocks the clearing of the Grand Total.

### Process Parameters

Any sensor information which has been scaled to engineering units including Flow, Temperature and Density.

### Pulldown (Input Termination)

The termination of an input at which the input is pulled down to ground through a resistor. Inputs that are terminated by this method need to be driven high with a positive voltage pulse.

### Pullup (Input Termination)

The termination of an input at which the input is pulled up to a positive voltage through a resistor. Inputs that are terminated by this method need to be pulled low with a sinking current or contact to ground .

### Pulse Output

The pulse output of the ST1-MANIFOLD-FC is available for remote accumulation of the Manifold total or sent to peripheral devices, such as a PLC. The output can be scaled using the Pulse Output Scaling Constant.

### Quick Update %

This feature is used to disable the rate averaging filter when a significant change in the flow rate occurs. The user can enter the percent of change needed to be detected to disable the averaging feature. This is especially useful during start-up and shutdown of flow.

### Rate Averaging Filter

The rate averaging filter is used to stabilize fluctuating rate displays. Higher settings provide more averaging for a more stable display. Derived from the equation:

$$\frac{(\text{OLD DATA} \times \text{"Avg. Filter"} + \text{NEW DATA})}{(\text{"Avg. Filter"} + 1)}$$

## 12. Glossary Of Terms (Continued)

**Ratometer**

Any device used to display the speed of a process. The ratemeter in the ST1-MANIFOLD-FC displays flow rate.

**Ref. Dens.**

Abbreviation for Reference Density. This is the fluid density at reference conditions of temperature.

**Ref. Temp.**

Abbreviation for Reference Temperature. This represents the base or reference condition to which corrected flow will be computed.

**Roshko**

A parameter defined as:  $R_o = \frac{f \cdot \text{temperature correction}}{cst_k}$

**STP Reference**

The users desired pressure and/or temperature to be considered as the reference condition in the computation of fluid properties or corrected volume conditions.

**Strouhal**

A calibration parameter defined as temperature corrected K-factor for a turbine flowmeter.

**Time Constant**

A damping factor for an averaging filter for the analog output. (see also Rate Averaging Filter)

**Totalizer**

Any device which accumulates and displays a total count.

**UVC**

Abbreviation for Universal Viscosity Curve. A presentation of the combined flowrate/viscosity calibration for a turbine flowmeter.

**VFD**

Abbreviation for Vacuum Fluorescent Display

**Visc Coef**

Abbreviation for Viscosity Coefficient. One or more coefficients in an equation used to describe the viscosity as a function of temperature for a fluid.

**Volume Flow**

The measurement of volumetric flow.

## 13. Diagnosis and Troubleshooting

### 13.1 Response of ST1-MANIFOLD-FC on Error or Alarm:

Error and warning indications which occur during operation are indicated in the RUN mode alternately with the measured values. The ST1-MANIFOLD-FC Flow Computer has three types of error:

| TYPE OF ERROR         | DESCRIPTION                                                       |
|-----------------------|-------------------------------------------------------------------|
| Sensor/Process Alarms | Errors detected due to sensor failure or process alarm conditions |
| Self Test Errors      | Errors detected during self test.                                 |
| System Alarms         | Errors detected due to system failure                             |

Some alarms are self clearing. Other alarms require the user to acknowledge and clear the alarm. Press the ENTER button to acknowledge and clear alarms. Alarms may reassert themselves if the alarm condition is still present.

**NOTE:** A historical error alarm log is available in the "Test Mode".

The following descriptions suggest possible causes and corrective actions for each alarm message.



### 13.2 Diagnosis Flow Chart and Troubleshooting

All instruments undergo various stages of quality control during production. The last of these stages is a complete calibration carried out on state-of-the-art calibration rigs.

A summary of possible causes is given below to help you identify faults.

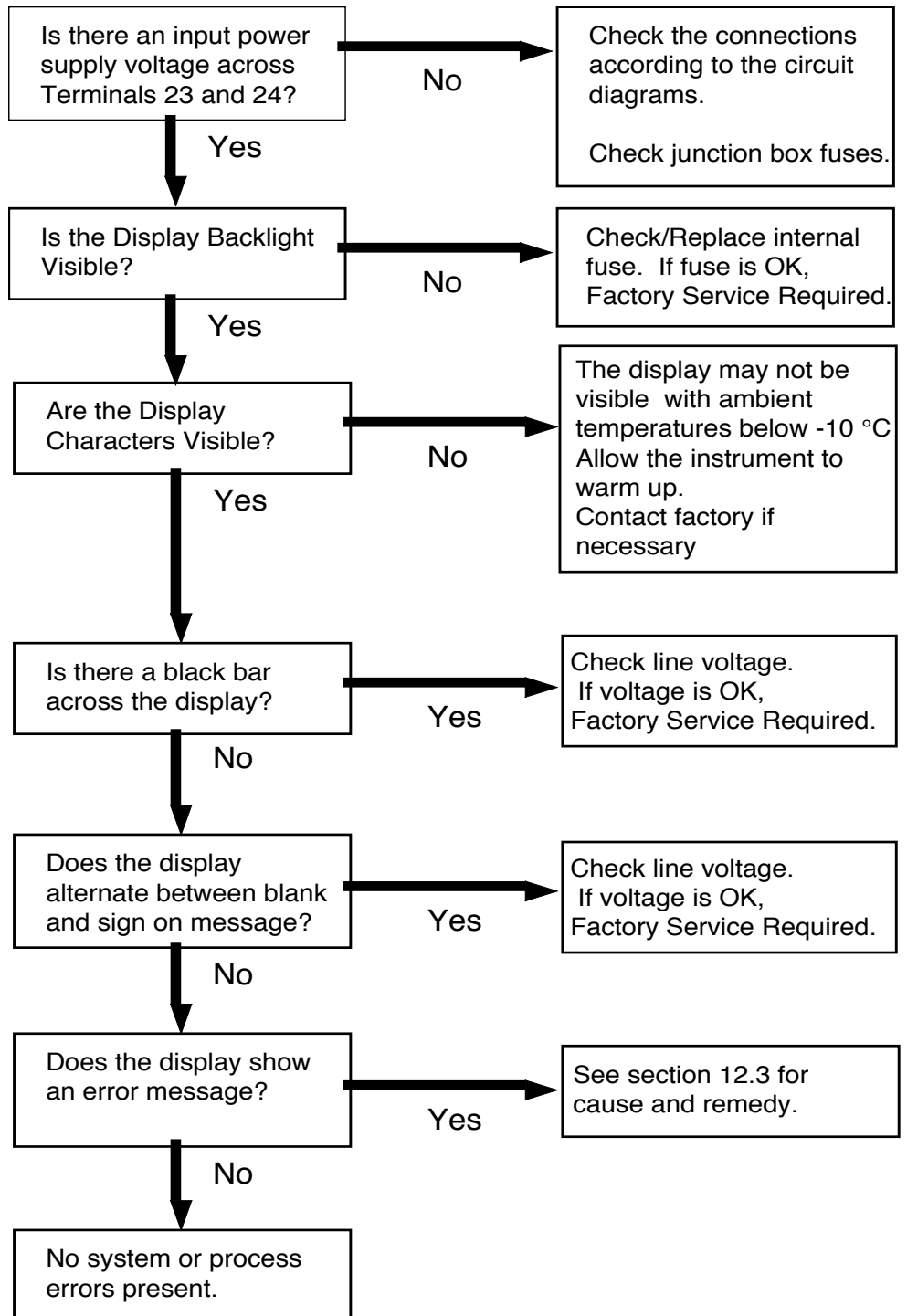

## 13.3 Error & Warning Messages:

### 13.3.1 Sensor/Process Alarms

| Error/Warning Message                                                                                                                                       | Cause                                                                                                                                                                                                     | Remedy                                                                                                                                                                                     |
|-------------------------------------------------------------------------------------------------------------------------------------------------------------|-----------------------------------------------------------------------------------------------------------------------------------------------------------------------------------------------------------|--------------------------------------------------------------------------------------------------------------------------------------------------------------------------------------------|
| <b>TOTALIZER ROLLOVER</b>                                                                                                                                   | Displayed when totalizer rolls over                                                                                                                                                                       | Acknowledge Rollover, Remedy not required                                                                                                                                                  |
| <b>AUX INPUT TOO LOW!</b>                                                                                                                                   | 4-20 mA Input current at aux input smaller than 3.5 mA:<br><ul style="list-style-type: none"> <li>• Faulty Wiring</li> <li>• Transmitter not set to "4-20 mA"</li> <li>• Transmitter defective</li> </ul> | <ul style="list-style-type: none"> <li>• Check wiring</li> <li>• Check function of sensor</li> </ul>                                                                                       |
| <b>RATE OVERFLOW ERROR</b>                                                                                                                                  | Pulse counter overflowed. The totalizer may have lost counts.                                                                                                                                             | <ul style="list-style-type: none"> <li>• Report error to factory</li> <li>• Check application conditions</li> <li>• Check wiring</li> </ul>                                                |
| <b>PULSE OUT OVERFLOW</b>                                                                                                                                   | Calculated pulse frequency too large:<br><ul style="list-style-type: none"> <li>• Pulse width setting too long</li> <li>• Larger pulse scaler needed</li> </ul>                                           | <ul style="list-style-type: none"> <li>• Adjust pulse value</li> <li>• Adjust pulse width</li> <li>• Check process conditions</li> </ul>                                                   |
| <b>LOW ALARM</b><br><b>HIGH ALARM</b><br><br><b>TEMP 1 LOW ALARM</b><br><b>TEMP 1 HIGH ALARM</b><br><br><b>TEMP 2 LOW ALARM</b><br><b>TEMP 2 HIGH ALARM</b> | Limit value exceeded.                                                                                                                                                                                     | <ul style="list-style-type: none"> <li>• Check application if necessary</li> <li>• Check limit value</li> <li>• Adjust the limit value if required</li> </ul>                              |
| <b>MODEM NOT PRESENT</b>                                                                                                                                    | The setup expects modem usage and a modem is not responding.                                                                                                                                              | <ul style="list-style-type: none"> <li>• Check setup for proper baud rate, parity, etc.</li> <li>• Check modem connection and cycle power to the unit.</li> <li>• Replace modem</li> </ul> |
| <b>SOFTWARE ERROR<br/>RESET</b>                                                                                                                             | Abnormal program execution has occurred. Problem was self diagnosed and logged.                                                                                                                           | <ul style="list-style-type: none"> <li>• Report error to factory</li> </ul>                                                                                                                |
| <b>EXTENDED PFI LOCKUP</b>                                                                                                                                  | Unit was operated with an input power level lower than safe operating range for an extended period of time.                                                                                               | <ul style="list-style-type: none"> <li>• Check data in unit. Totalizer may have inaccuracies</li> <li>• Investigate brownout cause.</li> </ul>                                             |

### 13.3 Error & Warning Messages: (Continued)

#### 13.3.2 Self Test Alarms

| <b>Error/Warning Message</b> | <b>Cause</b>                                                                                                                                                                                                                                                   | <b>Remedy</b>                                                                                                                                                                      |
|------------------------------|----------------------------------------------------------------------------------------------------------------------------------------------------------------------------------------------------------------------------------------------------------------|------------------------------------------------------------------------------------------------------------------------------------------------------------------------------------|
| <b>AUX INPUT TOO HIGH!</b>   | Analog input signal of the auxiliary input exceeded by more than 3%:<br><ul style="list-style-type: none"> <li>• Sensor overranged</li> <li>• Incorrect full scale setting of transmitter</li> <li>• Function error in transmitter or faulty wiring</li> </ul> | <ul style="list-style-type: none"> <li>• Check analog signal range</li> <li>• Check the application conditions</li> <li>• Check wiring</li> </ul>                                  |
| <b>BATTERY LOW WARNING</b>   | Battery voltage too low                                                                                                                                                                                                                                        | <ul style="list-style-type: none"> <li>• Replace Battery</li> <li>• Consult Factory for service information</li> </ul>                                                             |
| <b>A to D NOT CONVERTING</b> | Fault in analog/digital converter                                                                                                                                                                                                                              | <ul style="list-style-type: none"> <li>• Unit may self correct, Press ENTER to acknowledge &amp; clear alarm</li> <li>• If error reasserts, factory service is required</li> </ul> |
| <b>TIME CLOCK ERROR</b>      | The correct time/date is no longer shown                                                                                                                                                                                                                       | <ul style="list-style-type: none"> <li>• Re-enter time and date.</li> <li>• If error occurs again contact factory</li> </ul>                                                       |
| <b>CAL CHECKSUM ERROR</b>    | Calibration constants have been corrupted                                                                                                                                                                                                                      | <ul style="list-style-type: none"> <li>• Report error to factory</li> </ul>                                                                                                        |
| <b>SETUP CHECKSUM ERROR</b>  | The units setup has been corrupted                                                                                                                                                                                                                             | <ul style="list-style-type: none"> <li>• Report error to factory</li> </ul>                                                                                                        |

**Appendix A****Fluid Properties Table**

| FLUID            | REF. DENSITY<br>#/GAL | REF. TEMP. (°F) | EXPANSION COEF.<br>(e-6 format) | VISC. A     | VISC. B     |
|------------------|-----------------------|-----------------|---------------------------------|-------------|-------------|
| MIL-C-7024D      | 6.3888                | 60              | 288.8549                        | 0.0129297   | 2280.6224   |
| Water            | 8.3389                | 60              | 101.5                           | 0.001969    | 3315.61     |
| MIL-O-5606       | 7.33005               | 60              | 204.86589                       | 0.005878456 | 4369.3741   |
| MIL-23699        | 8.27149               | 60              | 171.4619                        | 0.00024452  | 6560.735394 |
| Jet A-1          | 6.71589               | 60              | 260.773                         | 0.015339    | 2443.5331   |
| 50/50Ethyl       | 9.0335                | 60              | 151.2799                        | 0.000500763 | 4677.3209   |
| Diesel           | 7.0157                | 60              | 239.11922                       | 0.00504669  | 3378.793514 |
| ATF(Dextron-III) | 7.126                 | 60              | 217.2616                        | 0.001319326 | 5626.0083   |
| AV Gas           | 5.878498              | 60              | 379.203                         | 0.017985217 | 1705.6512   |
| Mo Gas           | 6.1709                | 60              | 351.3892                        | 0.01074523  | 2459.2074   |

**NOTE 1** Any 10 fluids may be present in the ST1 Manifold FC at a given time. The above table includes many common fluids used with this model. Contact KEP if you require assistance in changing/obtaining the information for other fluids.

**NOTE 2** Each of the above fluid properties have been optimized for a fluid temperature range of approximately 50° F to 200° F.



## **Appendix C - RS485 Modbus RTU Protocol**

### **Introducing ST1-MANIFOLD-FC with RS-485 & Modbus RTU Protocol**

When the ST1-MANIFOLD-FC is equipped with the RS-485 communication option, the protocol it uses is the Modbus RTU protocol. This protocol defines a message structure that hosts and clients will recognize and use on the RS-485 network over which they communicate. It describes the process a master device (PC compatible) uses to request access to another device (ST1-MANIFOLD-FC), how it will respond to requests from the other devices, and how errors will be detected and reported. It establishes a common format for the layout and contents of message fields.

During communications on a Modbus RTU network, the protocol determines how each ST1-MANIFOLD-FC will know its device address, recognize a message addressed to it, determine the kind of action to be taken, and extract any data or other information contained in the message. If a reply is required, the ST1-MANIFOLD-FC will construct the reply message and send it using Modbus RTU protocol.

#### **RTU Mode**

The ST1-MANIFOLD-FC with RS-485 communications option supports the Modbus RTU (Remote Terminal Unit) mode only. The Modbus ASCII mode is not supported. The main advantage of the RTU mode is that its greater character density allows better data throughput than ASCII for the same baud rate. The Modbus RTU uses a Master-Slave Query-Response Cycle in which the ST1-MANIFOLD-FC is the slave device.

#### **Control Functions**

The ST1-MANIFOLD-FC with RS-485 communications option supports the following function codes:

| <b>CODE</b> | <b>NAME</b>               | <b>DESCRIPTION</b>                                                         |
|-------------|---------------------------|----------------------------------------------------------------------------|
| 01          | Read Coil Status          | Read a single coil                                                         |
| 03          | Read Holding Register     | Read a range of holding registers                                          |
| 05          | Force Single Coil         | Forces a single coil (0x reference) to either ON or OFF                    |
| 06          | Preset Single Register    | Presets a value into a single holding register (4x reference)              |
| 15          | Force Multiple Coil       | Forces each coil (0x reference) in a sequence of coils to either ON or OFF |
| 16          | Preset Multiple Registers | Presets values into a sequence of holding registers (4x reference)         |

**Appendix C - RS485 Modbus RTU Protocol**

**ST1-MANIFOLD-FC RS-485 Port Pinout (recommended mating connector: DB-9M)**

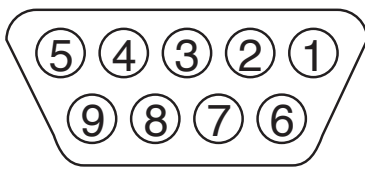

- 1 Ground
- 2 Ground
- 3 Ground
- 4 TX/RX (+)
- 5 TX/RX (-)
- 6 Do Not Use
- 7 Terminating Resistor (180 Ω)
- 8 TX/RX (+) (spare internally connected to 4)
- 9 TX/RX (-) (spare internally connected to 5)

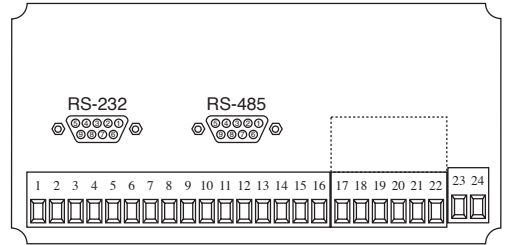

**ST1-MANIFOLD-FC RS-485 Port Pinout (Terminal Block Option)**

- 1 Common
- 2 TX/RX (+)
- 3 TX/RX (-)
- 4 Terminating Resistor (180Ω)

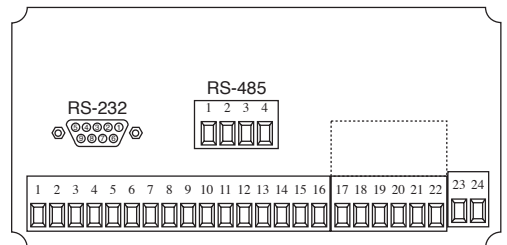

**Installation Overview**

A two wire RS-485 may be multidropped up to 4000 ft. and up to 32 units may be chained together. A RS-485 to RS-232 interface adaptor is required at the PC. An optically isolated type is recommended. Suitable wiring should be selected based on anticipated electrical interference. Terminators should be used to help improve the quality of electronic signals sent over the RS-485 wires. The RS-485 chain should be terminated at the beginning (RS-485 adaptor) and at the last device in the RS-485 chain and nowhere else. On the ST1-MANIFOLD-FC this is accomplished by connecting a jumper from terminal 7 to terminal 4 or 8 at the RS-485 port when DB-9 connector is used. Place jumper between terminals 2 and 4 when the terminal block option is used. If lightning protection is required, a suitable surge protector should be used.

For additional information, refer to the technical requirements of EIA-485, interface adaptor user manual and the communication software user manual

**ST1-MANIFOLD-FC Communication Setup Menu**

The setup menu allows Modbus RTU Protocol communications parameters of: Device ID, Baud Rate, and Parity to be selected to match the parameters of your RS-485 network. Each ST1-MANIFOLD-FC must have it's own Device ID and the same Baud Rate and Parity setting.

## Appendix C - RS485 Modbus RTU Protocol

### Register & Coil Usage

#### **Register Usage** (each register is 2 bytes)

| ST1-MANIFOLD-FC Data    | Register          | Data Type | Access     |
|-------------------------|-------------------|-----------|------------|
| Manifold Flow Rate *    | Reg 40001 & 40002 | Float     | Read       |
| Manifold Total *        | Reg 40005 & 40006 | Float     | Read       |
| Manifold Grand Total *  | Reg 40007 & 40008 | Float     | Read       |
| Temperature 1           | Reg 40009 & 40010 | Float     | Read       |
| Density 1               | Reg 40011 & 40012 | Float     | Read       |
| Preset 1                | Reg 40013 & 40014 | Float     | Read/Write |
| Preset 2                | Reg 40015 & 40016 | Float     | Read/Write |
| Preset 3                | Reg 40017 & 40018 | Float     | Read/Write |
| Preset 4                | Reg 40019 & 40020 | Float     | Read/Write |
| Year                    | Reg 40021         | Integer   | Read       |
| Month                   | Reg 40022         | Integer   | Read       |
| Day                     | Reg 40023         | Integer   | Read       |
| Hours                   | Reg 40024         | Integer   | Read       |
| Minutes                 | Reg 40025         | Integer   | Read       |
| Seconds                 | Reg 40026         | Integer   | Read       |
| Viscosity 1             | Reg 40027 & 40028 | Float     | Read       |
| Transaction Number      | Reg 40029         | Integer   | Read       |
| Unused                  | Reg 40030         | —         | —          |
| Unused                  | Reg 40031 & 40032 | —         | —          |
| Unused                  | Reg 40033 & 40034 | —         | —          |
| Unused                  | Reg 40035 & 40036 | —         | —          |
| Pulse Input 1 Frequency | Reg 40037 & 40038 | Float     | Read       |
| Pulse Input 2 Frequency | Reg 40039 & 40040 | Float     | Read       |
| KA Factor               | Reg 40041 & 40042 | Float     | Read       |
| KB Factor               | Reg 40043 & 40044 | Float     | Read       |
| Fluid Number            | Reg 40045         | Integer   | Read/Write |
| Unused                  | Reg 40046         | —         | —          |
| Temperature 2           | Reg 40047 & 40048 | Float     | —          |
| Density 2               | Reg 40049 & 40050 | Float     | —          |
| Viscosity 2             | Reg 40051 & 40052 | Float     | —          |
| Rate 1                  | Reg 40053 & 40054 | Float     | —          |
| Rate 2                  | Reg 40055 & 40056 | Float     | —          |
| Reserved                | Reg 40057 & 40058 | Float     | —          |
| Reserved                | Reg 40059 & 40060 | Float     | —          |
| Reserved                | Reg 40061 & 40062 | Float     | —          |
| Reserved                | Reg 40063 & 40064 | Float     | —          |

\* Parameters are active only when the instrument is configured for these calculations.

**NOTE:** The Float data type follows the IEEE format for a 32 bit float.

#### **COIL USAGE** (each coil is 1 bit)

| ST1-MANIFOLD-FC Data                     | Coil       | Data Type | Access |
|------------------------------------------|------------|-----------|--------|
| Error-Pulse Out Overflow                 | Coil 00001 | bit       | Read   |
| Alarm-Flow Rate Alarm Low Manifold Rate  | Coil 00002 | bit       | Read   |
| Alarm-Flow Rate Alarm High Manifold Rate | Coil 00003 | bit       | Read   |
| Alarm-Temp Alarm Low 1                   | Coil 00004 | bit       | Read   |
| Alarm-Temp Alarm High 1                  | Coil 00005 | bit       | Read   |
| Alarm-Temp Alarm Low 2                   | Coil 00008 | —         | —      |
| Alarm-Temp Alarm High 2                  | Coil 00009 | —         | —      |
| Unused                                   | Coil 00010 | —         | —      |
| Unused                                   | Coil 00011 | —         | —      |
| Unused                                   | Coil 00012 | —         | —      |
|                                          | Coil 00013 | —         | —      |



**Appendix C - RS485 Modbus RTU Protocol****Register & Coil Usage (continued)**

| <b>ST1-MANIFOLD-FC Data</b>                | <b>Coil</b> | <b>Data Type</b> | <b>Access</b> |
|--------------------------------------------|-------------|------------------|---------------|
| Reserved                                   | Coil 00014  | bit              | Read          |
| Error-Software Error Reset                 | Coil 00015  | bit              | Read          |
| Error-Extended PFI Lockup                  | Coil 00016  | bit              | Read          |
| Unused                                     | Coil 00017  | –                | –             |
| Unused                                     | Coil 00018  | –                | –             |
| Error-Cal Checksum Error                   | Coil 00019  | bit              | Read          |
| Error-Modem Not Found                      | Coil 00020  | bit              | Read          |
| Error-Setup Checksum Error                 | Coil 00021  | bit              | Read          |
| Error-Rate Overflow Error                  | Coil 00022  | bit              | Read          |
| Error-A to D Not Converting                | Coil 00023  | bit              | Read          |
| Error-Aux Input Too Low                    | Coil 00024  | bit              | Read          |
| Error-Aux Input Too High                   | Coil 00025  | bit              | Read          |
| Error-Flow Input Too Low                   | Coil 00026  | bit              | Read          |
| Error-Flow Input Too High                  | Coil 00027  | bit              | Read          |
| Reserved                                   | Coil 00028  | bit              | Read          |
| Error-RTD Out Of Range                     | Coil 00029  | bit              | Read          |
| Warning-Battery Low Warning                | Coil 00030  | bit              | Read          |
| Error-Time Clock Error                     | Coil 00031  | bit              | Read          |
| Warning-Totalizer Rollover                 | Coil 00032  | bit              | Read          |
| Command-Reset Total                        | Coil 00033  | bit              | Read/Write    |
| Command-Reset Errors                       | Coil 00034  | bit              | Read/Write    |
| Command-Print Command                      | Coil 00035  | bit              | Read/Write    |
| Status-Instrument Type Rate/Total or Batch | Coil 00036  | bit              | Read          |
| Reserved                                   | Coil 00037  | bit              | Read/Write    |
| Reserved                                   | Coil 00038  | bit              | Read/Write    |
| Reserved                                   | Coil 00039  | bit              | Read/Write    |
| Reserved                                   | Coil 00040  | bit              | Read          |
| Reserved                                   | Coil 00041  | bit              | Read          |
| Reserved                                   | Coil 00042  | bit              | Read          |
| Command-Relay 1 Command**                  | Coil 00043  | bit              | Read/Write    |
| Command-Relay 2 Command**                  | Coil 00044  | bit              | Read/Write    |
| Command-Relay 3 Command**                  | Coil 00045  | bit              | Read/Write    |
| Command-Relay 4 Command**                  | Coil 00046  | bit              | Read/Write    |
| Status-Relay 1 Status                      | Coil 00047  | bit              | Read          |
| Status-Relay 2 Status                      | Coil 00048  | bit              | Read          |
| Status-Relay 3 Status                      | Coil 00049  | bit              | Read          |
| Status-Relay 4 Status                      | Coil 00050  | bit              | Read          |
| Status-Control 1 Status                    | Coil 00051  | bit              | Read          |
| Status-Control 2 Status                    | Coil 00052  | bit              | Read          |
| Status-Control 3 Status                    | Coil 00053  | bit              | Read          |
| Unused                                     | Coil 00054  | –                | –             |
| Unused                                     | Coil 00055  | –                | –             |
| Unused                                     | Coil 00056  | –                | –             |
| Unused                                     | Coil 00057  | –                | –             |
| Unused                                     | Coil 00058  | –                | –             |
| Unused                                     | Coil 00059  | –                | –             |
| Unused                                     | Coil 00060  | –                | –             |
| Unused                                     | Coil 00061  | –                | –             |
| Unused                                     | Coil 00062  | –                | –             |
| Unused                                     | Coil 00063  | –                | –             |
| Unused                                     | Coil 00064  | –                | –             |

\*\* Relay commands are only active if relays have been configured for “NA” (not assigned) in the setup menus.