User's Manual

ROTAMASS 3 Series
Modbus Communication Type
(Option /MB2 and /MB3)
Coriolis Mass Flow and Density Meter
Integral Type RCCT3
Remote Type RCCF31 + RCCS3
Remote Type RCCR31 + RCCS3

IM 01R04B08-00E-E, additional manual to IM 01R04B04-00□-E

vigilantplant.[™]

Contents

1. INTRODUCTION	1-1
2. AMPLIFIER FOR MODBUS COMMUNICATION	2-1
2.1 Characteristics of the ROTAMASS with Modbus Communication type.....	2-1
2.2 Specification.....	2-1
3. ABOUT MODBUS.....	3-1
3.1 Outline.....	3-1
3.2 Wiring System Configuration.....	3-1
4. GETTING STARTED.....	4-1
4.1 Wiring in ROTAMASS 3 Terminal Box	4-1
4.2 Communication Setting.....	4-2
4.3 Reading and Writing Values	4-3
5. OPERATION OF ROTAMASS 3 SERIES MODBUS COMMUNICATION TYPE	5-1
5.1 Operation via display.....	5-1
5.2 Operation via HART	5-1
5.3 Operation via Modbus	5-1
5.3.1 Operation via Modbus option /MB2	5-2
5.3.2 Operation via Modbus option /MB3.....	5-2
6. PARAMETER TREE, DISPLAY MENU.....	6-1

7. MODBUS REGISTERS	7-1
7.1 Register Mapping.....	7-1
7.2 Modbus Holding Register Address Summary	7-3
7.3 Modbus Holding Register for Outputs (only /MB3).....	7-8
7.4 Modbus Specific Holding Register	7-9
7.5 Modbus Input Register Summary	7-10
7.6 Modbus Holding Register Settings for Outputs	7-12
7.7 Modbus Holding Register Settings for Outputs (only /MB3)	7-27
7.8 Modbus Flexible Register	7-34
7.8.1 Register of “Fast reading/writing area”	7-36
7.8.2 Example for “Fast reading”	7-37
7.8.3 Example for “Fast writing”	7-39
8. TECHNICAL DETAILS OF MODBUS COMMUNICATION	8-1
8.1 Supported Modbus Register Types.....	8-1
8.2 Supported Modbus Function Codes.....	8-1
8.3 Supported Exception Codes.....	8-1
8.4 Modbus Initialization.....	8-2
8.5 Communication Status Register.....	8-3
8.6 Byte Order of Transmission	8-4
8.6.1 Byte order of short value.....	8-5
8.6.2 Byte order of long value	8-5
8.6.3 Byte order of float value	8-5
8.6.4 Byte order of string value.....	8-5
8.6.5 Example of float value transmission	8-6
8.7 Transmission of Device Status Information	8-6
8.7.1 Error, Alarm and Warning descriptions.....	8-7
8.7.2 Reading of ordered errors, alarms and warnings	8-8
8.7.3 Reading of absolute errors and warnings	8-8
8.7.4 Reading of Autozero Initial and history values	8-9

8.8 Transmission of Device Status Information	8-10
8.9 Modbus Write Protection	8-10
9. MODBUS COMMUNICATION TOOL.....	9-1
9.1 Preconditions	9-1
9.2 Installation and Start	9-1
9.3 Using the Modbus Communication Tool	9-1

Blank Page

1. INTRODUCTION

Regarding this User's Manual

- This manual is additional to the standard manual IM 01R04B04-00□-E. All information and specifications which are not specially for Modbus type must be regarded in the standard manual.
- These manuals should be provided to the end user.
- Before use, read these manuals thoroughly to comprehend its contents.
- The contents of these manuals may be changed without prior notice.
- All rights are reserved. No part of this manual may be reproduced in any form without Yokogawa's written permission.
- Yokogawa makes no warranty of any kind with regard to this material, including, but not limited to, implied warranties of merchantability and suitability for a particular purpose.
- All reasonable effort has been made to ensure the accuracy of the contents of this manual. However, if any errors or omissions are found, please inform Yokogawa.
- Yokogawa assumes no responsibilities for this product except as stated in the warranty.
- Please note that this user's manual may not be revised for any specification changes, construction changes or operating part changes that are not considered to affect function or performance.
- If the customer or any third party is harmed by the use of this product, Yokogawa assumes no responsibility for any such harm owing to any defects in the product which were not predictable, or for any indirect damages.

Blank Page

2. AMPLIFIER FOR MODBUS COMMUNICATION

Refer to IM 01R04B04-00E for further details about the amplifier. This section encompasses topics applicable to only the Modbus communication type.

2.1 Characteristics of the ROTAMASS with Modbus Communication type

Rota Yokogawa has two Modbus communication type options for ROTAMASS 3 Series in the portfolio: /MB2 and /MB3

These two options differ in the output and input capabilities.

- I/O connection with /MB2:
 - 1 Modbus RS-485 communication line

- I/O connection with /MB3:
 - 1 Modbus RS-485 communication line
 - 1 Current output with HART communication
 - 1 Pulse / status output
 - 1 Status input

Please consider the following limitation:

- (1) Only one current output (Iout1) exists.
- (2) No intrinsically safe outputs are available.
- (3) Simultaneous write access of Modbus and HART should be avoided.
- (4) The display is just available in English language.

2.2 Specification

For specifications other than below, refer to chapter 11 "Technical Data" of IM 01R04B04-00E.

- Modbus® communication (/MB1, /MB2 + /MB3)
- Physical interface RS485 as two wire data bus according EIA/TIA-485
- Maximal bus length is depending from bus topology and communication speed.
- Addresses: 1 to 247
- Baud rates: 1200, 2400, 4800, 9600, 19200, 38400, 57600, 76800, 115200
- Data formats: E/1, O/1, N/1, N/2 (parity/stop bits)
- Modes: RTU, ASCII

Blank Page

3. ABOUT MODBUS

3.1 Outline

Modbus is an open bi-directional digital communication protocol widely used in the industrial environment.

The Modbus communication type of the ROTAMASS 3 is in accordance with the specification of the Modbus Organization, and consequently provides interoperability with devices from various manufacturers.

Featuring transmission of all measurement variables and units as input registers and other parameters as holding registers, the Modbus communication type's software enables a flexible instrumentation system to be implemented.

For more information about engineering, design, construction work, start-up and maintenance of Modbus, refer to the Modbus Organization (www.modbus.org).

3.2 Wiring System Configuration

The number of devices that can be connected to a single bus without repeater is 32. The maximum cable length depends on baud rate, cable properties and network configuration. When constructing systems, both the basic and overall design must be carefully considered to allow device performance to be fully exhibited.

The following instruments are required for use with Modbus devices:

- **Termination:**

Modbus requires two terminations at the ends of the trunk line. Refer to the supplier for details of terminations.

- **Field devices:**

Connect your Modbus communication type ROTAMASS 3 Series to a v. One or more ROTAMASS 3 Series and other field devices can be connected. For the terminal assignment on the ROTAMASS 3 Series, see chapter 4.1.

- **Host:**

Used for accessing field devices. A dedicated host (such as DCS) is used for an instrumentation line while dedicated communication tools are used for startup or maintenance. For operation of the host, refer to the instruction manual for each host. No details of the host are explained in the rest of this manual.

- **Cable:**

Used for connecting devices. Refer to http://www.modbus.org/docs/Modbus_over_serial_line_V1_02.pdf for details of instrumentation cabling. If the total length of the cable is in a range of 2 to 3 meters for laboratory or other experimental use, the following simplified cable (a twisted pair wire with a cross section of 0.9 mm² or more and cycle period of within 5 cm (2 inches) may be used). Termination processing depends on the type of device being deployed. For the ROTAMASS, clamp terminal are used.

Connect the devices as shown in Figure 3.1. Connect the terminations at both ends of the trunk, with a minimum length of the spur for connection.

The polarity of signal must be maintained.

Figure 3.1 Device Connection

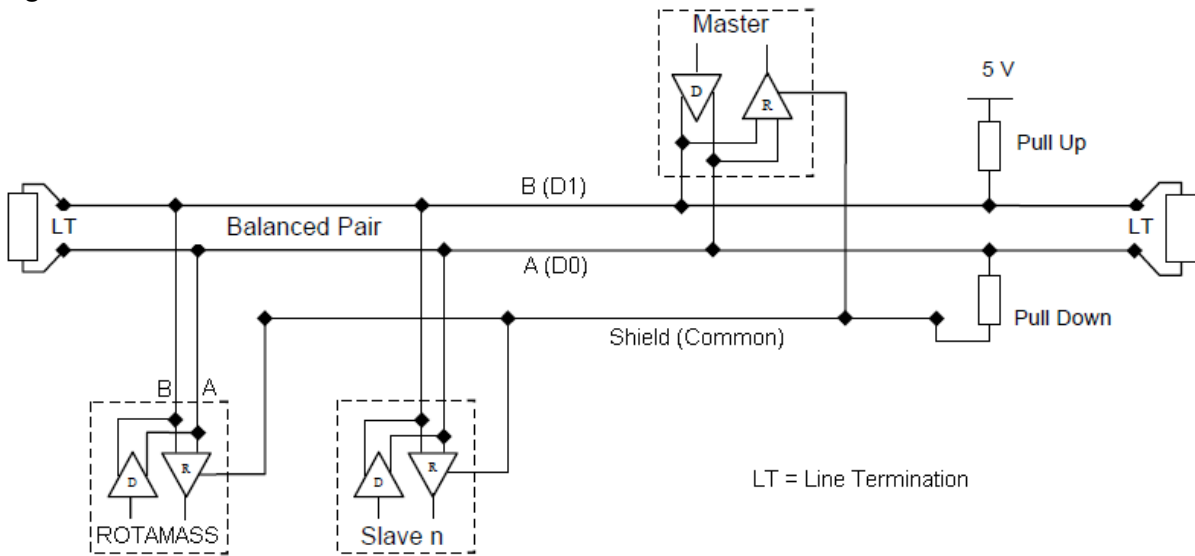

Before using a Modbus configuration tool other than the existing host, confirm it does not affect the loop functionality in which all devices are already installed in operation. Disconnect the relevant control loop from the bus if necessary.

4. GETTING STARTED

Modbus is a digital communication protocol and differs in operation from 4 to 20 mA transmission and the HART communication. It is recommended that users use Modbus devices in accordance with the procedures described in this section. The procedures assume that Modbus devices will be set up on a bench of an instrument shop.

4.1 Wiring in ROTAMASS 3 Terminal Box

Figure 4.1 I/O-Terminal Overview Option /MB3

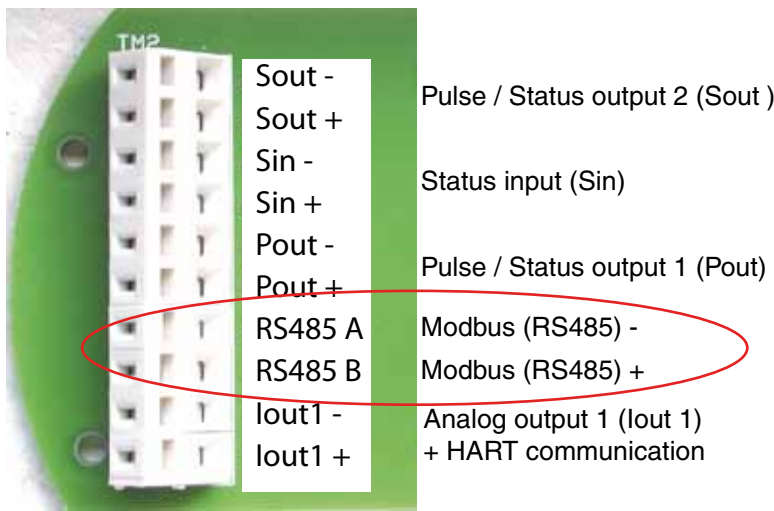

F31.EPS

Figure 4.2 I/O-Terminal Overview Option /MB2

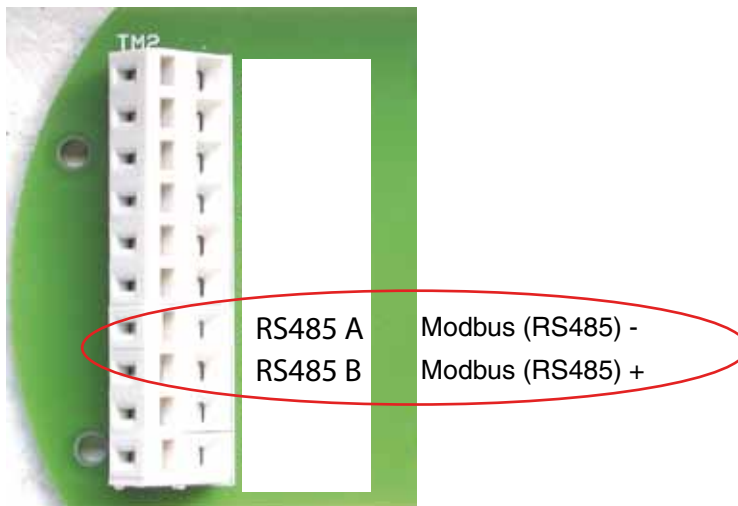

F32.EPS

Wiring:

- Confirm one ferrite core is attached to the flowmeter.
- Insert the power cable into the ferrite core before connecting to the terminals. Fix the ferrite core to the cable with clamping wire.

- Connect the power cables to the terminals according to the figures below.
- Connect the Modbus- cables to the terminals according to the figure below.
- For the connection of protective ground conductor to PE terminal of RCCF31 / RCCT3□ use a crimp-on ring type terminal. For RCCR31 connect the protective ground conductor to PE terminal of terminal board.

**NOTE**

The maximum length of Modbus cable depends on different influences. Please see the Modbus-specification.

4.2 Communication Setting

To activate Modbus, the following settings are required. They are located in the Modbus Communication menu in "Detailed Setup".

**IMPORTANT**

Do not turn off the power supply immediately after setting. When the parameters are saved to the EEPROM, the redundant processing is executed for the improvement of reliability. If the power is turned off within 60 seconds after setting is made, the modified parameters are not saved and the settings may return to the previous values.

Table 4.1 Communication Parameters (Bold values: default settings)

Function	Parameter	Description and Setting
Device address	Device address	Select: 1 to 247 Set the device address for ROTAMASS where the host expects to communicate. Make sure that no other device on the bus uses the same address!
Baud rate	Baud rate	Select: 1200, 2400, 4800, 9600, 19200 , 38400, 57600, 76800, 115200 Make sure that host and ROTAMASS use the same baud rate for communication
Communication settings	Data format	Select: Even 1 stop bit , Odd 1 stop bit, None 1 stop bit, None 2 stop bits Make sure that host and ROTAMASS use the same communication settings.
Bus mode	Modbus mode	Select: RTU , ASCII Make sure that host and ROTAMASS communicate in the same Modbus mode.
Modbus initialization	Modbus init	 IMPORTANT The Modbus communication module must be restarted after changing any of the above settings! This can be done by either powering off and on the device or by executing the function "Modbus init". Please note that the settings in the menu will be updated after initialization of the Modbus communication module.

4.3 Reading and Writing Values

Unlike other communication protocols Modbus does not use standardized device description files but store data and parameters in registers. An overview of the Modbus registers of ROTAMASS can be found in chapter 7.

For configuration the ROTAMASS Modbus communication tool is available from Yokogawa which can address parameters of ROTAMASS which are mapped onto Modbus. The tool can be found on the DVD which is attached to each device. It is running under all recent PC- system and supports all communication settings of ROTAMASS. To connect to ROTAMASS the user needs a RS232 to RS485 or USB to RS485 converter.

Blank Page

5. OPERATION OF ROTAMASS 3 SERIES MODBUS COMMUNICATION TYPE

5.1 Operation via display

For general information regarding the operation via display refer to the instruction manual of the standard type IM 01R04B04-00E-E. For the Modbus communication type the operation via display is basically the same. Extensions and restrictions are described below:

1. A menu has been added to "Detailed Setup" to configure the Modbus communication settings of ROTAMASS. To establish communication please make sure to match the communication settings of your host system.
2. Only the English language is available.
3. Current output 2 is not available for Modbus communication type. All menu items referring to current output 2 have therefore been removed from the display menu.



NOTE

Due to the ability of /MB3 to communicate simultaneously via HART and Modbus the operation of the display menu is slightly slower than experienced with a standard device.

5.2 Operation via HART

ROTAMASS 3 Series Modbus communication type supports also full configuration via HART communication protocol on current output 1.

For wiring and general information regarding the operation via HART communication protocol refer to the instruction manual of the standard type IM 01R04B04-00E-E.

Unless a special DD/DTM for the Modbus communication type is available the standard DD/DTM will be loaded. Therefore a few restrictions apply:

1. The Modbus communication settings menu is not available via HART but only in the display menu of ROTAMASS.
2. When changing the menu text to German, the display language will remain in English since German language texts are not available.
3. All settings for current output 2 are visible in the standard DD/DTM. However, any settings made for current output 2 will have no effect in the device since this output is not available.

5.3 Operation via Modbus

All ROTAMASS 3 Series Modbus communication options support reading access to all measurement values in holding and input registers. Configuration of all parameters via Modbus is also supported.

For detailed information of available parameters refer to the menu tree in chapter 6.

For configuration of selection parameters for each selection a specific value has to be written. The selection values are found in the table in chapter 7.



NOTE

The Modbus communication settings of ROTAMASS can be changed via Modbus. However, communication continues with the previous settings. The new settings will only be taken in effect after execution of the function "Modbus Init" or a restart of ROTAMASS.



IMPORTANT

Other communication protocols handle dependencies and refreshes of parameters in device description files. In the opposite Modbus accesses only single registers (values or parameters) and the host has usually no information about any other conditions. Furthermore according Modbus specification only few exception codes for certain transmission errors are defined. Therefore only physical transmission is secured by the protocol but any logical check has to be done individually by the host system. For more information refer to chapter 8.

5.3.1 Operation via Modbus option /MB2

ROTAMASS 3 Series Modbus communication option /MB2 support reading access to all measurement values in holding and input registers.

With option /MB2 all input/output relevant registers and HART relevant registers are not accessible.

No input/output functions are available and physically connected. Consequently no HART communication is possible.

The option /MB2 supports only Modbus communication.

5.3.2 Operation via Modbus option /MB3

ROTAMASS 3 Series Modbus communication option /MB3 support reading access to all measurement values in holding and input registers.

The configuration of all parameters via Modbus is supported.

Modbus communication option /MB3 is the further developed option /MB1.

6. PARAMETER TREE, DISPLAY MENU

Parameters in dark grey are not mapped onto Modbus for ROTAMASS with option /MB2 and /MB3. In option /MB2 parameters in light grey cannot be accessed via HART communication on current output 1 or via the display menu. The output functions are not available. The default value of selection items is typed in bold letters.

Legend:

Default settings	
Bold	Not mapped in option /MB2
	Not mapped in Modbus

Language	English
	German
	French
	Russian

Process Variables	View fld dev vars	Mass flow	R
		Volume flow	R
		Density	R
		Temperature	R
		Concentration meas	R
		Net flow	R
		F-Total flex	R
		R-Total flex	R
		D-Total flex	R
		F-Total mass	R
		R-Total mass	R
		D-Total mass	R
		F-Total volume	R
		R-Total volume	R
		D-Total volume	R
		F-Total net	R
		R-Total net	R
		D-Total net	R
		F-Total energy	R
		Velocity	R
		Drive gain	R
	View outputs	Analog output 1	R
		Analog output 1	R
		Analog output 1%	R
		Analog output 1mA	R
		Pulse/Status out 1	R
		Pulse output 1	R
		Status output 1	R
		Pulse/Status out 2	R
		Pulse output 2	R
		Status output 2	R

	View input	SI function		R	
	Totalizer	Total reset cntrl	Inhibit	Sel	
			Enable		
			Total reset	Not Execute	
				Reset flex totals	EXE
				Reset mass totals	EXE
				Reset volume totals	EXE
				Reset net totals	EXE
				Reset all totals	EXE
Diag/Service	Self test/Status	Self Test	LCD Test	EXE	
			Self Test	EXE	
			Key Test	EXE	
		Status	Event Overview	R	
			Error	R	
			Alarm	R	
			Warning	R	
		Hist Overview ord	Hist Overview ord	R	
			Clear History	EXE	
		Hist Overview abs	Hist Overview abs	R	
	Error		R		
	Alarm		R		
	Warning		R		
	Clear History		EXE		
		Error History	R		
	Input/Output test	Analog output 1	R/W		
		Pulse output 1	R/W		
		Status output 1	R/W		
		Pulse output 2	R/W		
		Status output 2	R/W		
Status input		R			

Diag/Service	Auto zero check	Autozero history	Data set	1 Newest	Sel
				2	
				3	
				4	
				5	
				Initial	
		Autozero initial	Val		R
			Dens		R
			Temp		R
			Date		R
		Autozero range			R
		Autozero fluctuation range			R
		Autozero	Zero tuning	Inhibit	Sel
				Enable	
			Autozero time	3min	Sel
			30s		
		Autozero Exe		EXE	
		Autozero value		R	
	Output trim	AO 1 trim 4mA		EXE	
		AO 1 trim 20mA		EXE	

Basic Setup	Tag		R/W	
	Long Tag		R/W	
Basic Setup	Display config	Disp select 1	Sel	
				Volume flow
				Density
				Temperature
				Concentration meas
				Net flow
				F-Total flex
				R-Total flex
				D-Total flex
				F-Total mass
				R-Total mass
				D-Total mass
				F-Total volume
				R-Total volume
				D-Total volume
				F-Total net
				R-Total net
				D-Total net
				F-Total energy
			Velocity	
			Drive gain	
		Disp select 2	Mass flow	Sel
			Volume flow	
			Density	
			Temperature	
		Concentration meas		
		Net flow		
		F-Total flex		
		R-Total flex		
		D-Total flex		
		F-Total mass		
		R-Total mass		
		D-Total mass		
		F-Total volume		
		R-Total volume		
		D-Total volume		
		F-Total net		
		R-Total net		
		D-Total net		
		F-Total energy		
		Velocity		
		Drive gain		
		None		

Basic Setup

Disp select 3	Mass flow
	Volume flow
	Density
	Temperature
	Concentration meas
	Net flow
	F-Total flex
	R-Total flex
	D-Total flex
	F-Total mass
	R-Total mass
	D-Total mass
	F-Total volume
	R-Total volume
	D-Total volume
	F-Total net
	R-Total net
	D-Total net
	F-Total energy
	Velocity
	Drive gain
	None

Sel

Disp select 4	Mass flow
	Volume flow
	Density
	Temperature
	Concentration meas
	Net flow
	F-Total flex
	R-Total flex
	D-Total flex
	F-Total mass
	R-Total mass
	D-Total mass
	F-Total volume
	R-Total volume
	D-Total volume
	F-Total net
	R-Total net
	D-Total net
	F-Total energy
	Velocity
	Drive gain
	None

Sel

Basic Setup	Display contrast		-5	Sel	
			-4		
			-3		
			-2		
			-1		
			0		
			+1		
			+2		
			+3		
			+4		
			+5		
	Mass flow	Mass flow unit	g/s		Sel
			g/min		
			g/h		
			kg/s		
		kg/min			
		kg/h			
		kg/d			
		t/min			
		t/h			
		t/d			
		lb/s			
		lb/min			
		lb/h			
		lb/d			
	Mass flow LRV		R/W		
	Mass flow URV		R/W		
	Mass flow damping		R/W		
Density	Density unit	g/ml	Sel		
		kg/l			
		kg/m ³			
		lb/gal			
		lb/Cuft			
		g/cm ³			
		g/l			
		°Bé hv			
		°Bé lt			
		°API			
	Density LRV			R/W	
	Density URV			R/W	
	Density damping			R/W	

Basic Setup	Temperature	Temperature unit	degC	Sel
			degF	
			K	
		Temperature LRV		R/W
		Temperature URV		R/W
		Temperature damping		R/W
	Analog 1 select	Mass flow		Sel
		Volume flow		
		Density		
		Temperature		
		Concentration meas		
		Net flow		
		None		
	Pulse/Status out 1	Pulse/Stat 1 select	Pulse	Sel
			Status Out	
		No Function		
	Pulse 1 select	Mass flow	Sel	
		Volume flow		
		Density		
		Temperature		
		Concentration meas		
		Net flow		
		None		
		F-Total mass		
		R-Total mass		
		F-Total volume		
		R-Total volume		
		F-Total net		
		R-Total net		

Basic Setup	Pulse 1 unit	Hz	Sel
		g/P	
		kg/P	
		t/P	
		lb/P	
		cm ³ /P	
		l/P	
		m ³ /P	
		gal/P	
		kgal/P	
		Cuft/P	
		bbl/P	
		Impgal/P	
		kImpgal/P	
		l(N)/P	
		m ³ (N)/P	
		SI/P	
		Scuft/P	
		Sm ³ /P	
		Pulse 1 rate	
	SO 1 function	No Function	Sel
		Flow direction	
		Total switch	
		Mass flow alm 1	
		Mass flow alm 2	
		Mass flow alm 1+2	
		Vol flow alm 1	
		Vol flow alm 2	
		Vol flow alm 1+2	
		Density alm 1	
		Density alm 2	
		Density alm 1+2	
		Temp alm 1	
		Temp alm 2	
		Temp alm 1+2	
		Concentr. meas alm 1	
		Concentr. meas alm 2	
		Concentr. meas alm 1+2	
		Net flow alm 1	
		Net flow alm 2	
		Net flow alm 1+2	
		Slug Alarm	
		Empty alarm	
		Corrosion Alarm	
		All alarms	
		All errors	
		All alarms & errors	

Basic Setup	Pulse/Status out 2	Pulse/Stat 2 select	Pulse	Sel
			Status Out	
			No Function	
		Pulse 2 select	Mass flow	Sel
			Volume flow	
			Density	
			Temperature	
			Concentration meas	
			Net flow	
			None	
			F-Total mass	
			R-Total mass	
			F-Total volume	
			R-Total volume	
			F-Total net	
		R-Total net		
	Pulse 2 unit	Hz	Sel	
		g/P		
		kg/P		
		t/P		
		lb/P		
		cm ³ /P		
		l/P		
		m ³ /P		
		gal/P		
		kgal/P		
		Cuft/P		
		bb/P		
		Impgal/P		
		kImpgal/P		
		l(N)/P		
		m ³ (N)/P		
		Sl/P		
		Scuft/P		
		Sm ³ /P		
	Pulse 2 rate		R/W	

Basic Setup	SO 2 function		No Function	Sel
			Flow direction	
			Total switch	
			Mass flow alm 1	
			Mass flow alm 2	
			Mass flow alm 1+2	
			Vol flow alm 1	
			Vol flow alm 2	
			Vol flow alm 1+2	
			Density alm 1	
			Density alm 2	
			Density alm 1+2	
			Temp alm 1	
			Temp alm 2	
			Temp alm 1+2	
			Concentr. meas alm 1	
			Concentr. meas alm 2	
			Concentr. meas alm 1+2	
			Net flow alm 1	
			Net flow alm 2	
		Net flow alm 1+2		
		Slug Alarm		
		Empty alarm		
		Corrosion Alarm		
		All alarms		
		All errors		
		All alarms & errors		
SI function		No function	Sel	
		Autozero		
		Reset flex totals		
		Reset mass totals		
		Reset volume totals		
		Reset net totals		
		Reset all totals		
		0% signal lock		
Totalizer	Total flex select	Mass	Sel	
		Volume		
		Net		

Basic Setup	Total flex unit	g	Sel
		kg	
		t	
		lb	
		cm ³	
		l	
		m ³	
		gal	
		kgal	
		Cuft	
		bbbl	
		Impgal	
		KImpgal	
		l(N)	
		m ³ (N)	
		Sl	
		Scuft	
		MMscuft	
		Sm ³	
	Total mass unit	g	Sel
		kg	
		t	
		lb	
	Total volume unit	cm ³	Sel
		l	
		m ³	
		gal	
		kgal	
		Cuft	
		bbbl	
		Impgal	
		KImpgal	
		l(N)	
	m ³ (N)		
	Sl		
	Scuft		
	MMscuft		
	Sm ³		

Basic Setup			Total net unit	g		
				kg		
				t		
				lb		
				cm ³		
				l		
				m ³		
				gal		
				kgal		
				Cuft		
				bbbl		
				Impgal		
				KImpgal		
			Total switch select	Flex total		Sel
				Mass total		
	Volume total					
	Net total					
Detailed Setup	Display config	Disp select 1	Mass flow	Sel		
			Volume flow			
			Density			
			Temperature			
			Concentration meas			
			Net flow			
			F-Total flex			
			R-Total flex			
			D-Total flex			
			F-Total mass			
			R-Total mass			
			D-Total mass			
			F-Total volume			
			R-Total volume			
			D-Total volume			
			F-Total net			
			R-Total net			
			D-Total net			
			F-Total energy			
			Velocity			
			Drive gain			

Detailed Setup

Disp select 2	Mass flow
	Volume flow
	Density
	Temperature
	Concentration meas
	Net flow
	F-Total flex
	R-Total flex
	D-Total flex
	F-Total mass
	R-Total mass
	D-Total mass
	F-Total volume
	R-Total volume
	D-Total volume
	F-Total net
	R-Total net
	D-Total net
	F-Total energy
	Velocity
	Drive gain
	None

Sel

Disp select 3	Mass flow
	Volume flow
	Density
	Temperature
	Concentration meas
	Net flow
	F-Total flex
	R-Total flex
	D-Total flex
	F-Total mass
	R-Total mass
	D-Total mass
	F-Total volume
	R-Total volume
	D-Total volume
	F-Total net
	R-Total net
	D-Total net
	F-Total energy
	Velocity
	Drive gain
	None

Sel

Detailed Setup	Disp select 4	Mass flow	Sel
		Volume flow	
		Density	
		Temperature	
		Concentration meas	
		Net flow	
		F-Total flex	
		R-Total flex	
		D-Total flex	
		F-Total mass	
		R-Total mass	
		D-Total mass	
		F-Total volume	
		R-Total volume	
		D-Total volume	
		F-Total net	
		R-Total net	
		D-Total net	
		F-Total energy	
		Velocity	
	Drive gain		
	None		
	Display contrast	-5	Sel
		-4	
		-3	
		-2	
		-1	
		0	
		+1	
		+2	
		+3	
		+4	
		+5	
	Disp period	0.5s	Sel
		1.0s	
		2.0s	
	Language	English	Sel
		German	
		French	
		Russian	

Detailed Setup	Sensor model	RCCS30		Sel	
		RCCS31			
		RCCS32			
		RCCS33			
		RCCS34			
		RCCS36			
		RCCS38			
		RCCS39			
		RCCS39/IR			
		RCCS39/XR			
		RCCS30/LR			
	Sensor constants	Mass flow	SK20		R/W
			SKT		R/W
			SKTK		R/W
			RV		R/W
			Qnom		R
			SKP		R/W
			SKPT		R/W
		Density	KD		R/W
			fl20		R/W
			FTC1		R/W
			FTCK		R/W
			FPC		R/W
			FPTC		R/W
			FQC1		R/W
			FQC2		R/W
	Config fld variables	Flow direction	Forward		Sel
		Reverse			

Detailed Setup	Mass flow	Mass flow unit	g/s	Sel
			g/min	
			g/h	
			kg/s	
			kg/min	
			kg/h	
			kg/d	
			t/min	
			t/h	
			t/d	
			lb/s	
			lb/min	
			lb/h	
			lb/d	
		Mass flow format	xxxxxxx	Sel
			xxxxx.X	
			xxx.XX	
			xx.XXX	
			xx.XXXX	
			x.XXXXX	
		Mass flow LRV		R/W
		Mass flow URV		R/W
		Mass flow damping		R/W
		Mass flow lowcut		R/W
		Mass flow alm 1 sel	No function	Sel
			More than	
			Less than	
		Mass flow alm 1 crit		R/W
	Mass flow alm 2 sel	No function	Sel	
		More than		
		Less than		
	Mass flow alm 2 crit		R/W	
	Mass flow fix val sel	Inhibit	Sel	
		Enable		
	Mass flow fixed val		R/W	

Detailed Setup	Volume flow	Vol flow unit	cm ³ /s	Sel
			cm ³ /min	
			cm ³ /h	
			l/s	
			l/min	
			l/h	
			l/d	
			m ³ /s	
			m ³ /min	
			m³/h	
			m ³ /d	
			gal/s	
			gal/min	
			gal/h	
			gal/d	
			Cuft/s	
			Cuft/min	
			Cuft/h	
			Cuft/d	
			bb/s	
			bb/min	
			bb/h	
			bb/d	
			Impgal/s	
			Impgal/min	
			Impgal/h	
			Impgal/d	
			l(N)/s	
			l(N)/min	
			l(N)/h	
			l(N)/d	
			m ³ (N)/s	
		m ³ (N)/min		
		m ³ (N)/h		
		m ³ (N)/d		
		Sl/s		
		Sl/min		
		Sl/h		
		Sl/d		
		Scuft/s		
		Scuft/min		
		Scuft/h		
		Scuft/d		
		Sm ³ /s		
		Sm ³ /min		
		Sm ³ /h		
		Sm ³ /d		

Detailed Setup	Vol flow format	xxxxxxx	Sel	
		xxxxx.X		
		xxxx.XX		
		xxx.XXX		
		xx.XXXX		
		x.XXXXX		
	Vol flow LRV		R/W	
	Vol flow URV		R/W	
	Vol flow damping		R/W	
	Vol flow lowcut		R/W	
	Vol flow alm 1 sel	No function	Sel	
		More than		
		Less than		
	Vol flow alm 1 crit		R/W	
	Vol flow alm 2 sel	No function	Sel	
		More than		
		Less than		
	Vol flow alm 2 crit		R/W	
	Density	Density unit	g/ml	Sel
			kg/l	
			kg/m ³	
			lb/gal	
			lb/Cuft	
			g/cm ³	
		g/l		
		°Bé hv		
		°Bé lt		
		°API		
	Density format	xxxxxxx	Sel	
		xxxxx.X		
		xxxx.XX		
		xxx.XXX		
		xx.XXXX		
		x.XXXXX		
	Density LRV		R/W	
	Density URV		R/W	
	Density damping		R/W	

Detailed Setup	Density lowcut		R/W	
	Density alm 1 sel	No function	Sel	
		More than		
		Less than		
	Density alm 1 crit		R/W	
	Density alm 2 sel	No function	Sel	
		More than		
		Less than		
	Density alm 2 crit		R/W	
	Ref. Density sel	Inhibit	Sel	
		Fixed		
		Calculated		
	Reference density		R/W	
	Reference density setup	Reference temperature	R/W	
		Temp coeff. a (carrier)	R/W	
		Temp coeff. b (carrier)	R/W	
	Density offset		R/W	
	Pressure Unit	bar	Sel	
		psi		
		MPa		
	Pressure		R/W	
	Temperature	Temperature unit	degC	Sel
			degF	
			K	
		Temperature format	xxxxxxx	Sel
		xxxxx.X		
		xxxx.XX		
		xxx.XXX		
		xx.XXXX		
		x.XXXXX		
	Temperature LRV		R/W	
	Temperature URV		R/W	
	Temperature damping		R/W	
	Temp alm 1 sel	No function	Sel	
		More than		
		Less than		

Detailed Setup		Temp alm 1 crit		R/W
		Temp alm 2 sel	No function	Sel
			More than	
			Less than	
		Temp alm 2 crit		R/W
		Temp fix val select	Inhibit	Sel
			Enable	
		Temp fixed value		R/W
		Temp gain		R/W
		Velocity unit	m/s	Sel
		ft/s		
	Config Output/Input	Analog output 1	Analog 1 select	Mass flow Sel
			Volume flow	
			Density	
			Temperature	
			Concentration meas	
			Net flow	
			None	
		Analog 1 alarm Out	<2.4 mA	Sel
			<3.6 mA	
			<4.0 mA	
			>21.0 mA	
			>21.6 mA	
			Hold	
			Measured value	
		Analog 1 low LMT		R/W
		Analog 1 high LMT		R/W
	Pulse/Status out 1	Pulse/Stat 1 select	Pulse	Sel
			Status out	
			No function	

Detailed Setup	Pulse 1 select	Mass flow	Sel	
		Volume flow		
		Density		
		Temperature		
		Concentration meas		
		Net flow		
		None		
		F-Total mass		
		R-Total mass		
		F-Total volume		
		R-Total volume		
		F-Total net		
		R-Total net		
		Pulse 1 unit	Hz	Sel
			g/P	
			kg/P	
			t/P	
			lb/P	
			cm ³ /P	
			l/P	
			m ³ /P	
			gal/P	
			kgal/P	
			Cuft/P	
			bb/P	
			Impgal/P	
			klmpgal/P	
			l(N)/P	
			m ³ (N)/P	
			Sl/P	
			Scuft/P	
			Sm ³ /P	
		Pulse 1 rate		R/W
	Pulse 1 active mode	On Active	Sel	
		Off Active		
	Pulse 1 width	0.05ms	Sel	
		0.1ms		
		0.5ms		
		1ms		
		5ms		
		10ms		
		50ms		
		100ms		
		50ms		
		1000ms		

Detailed Setup	Pulse 1 at alarm	OP/0Hz	Sel
		Measured value	
		Hold	
	SO 1 function	No Function	Sel
		Flow direction	
		Total switch	
		Mass flow alm 1	
		Mass flow alm 2	
		Mass flow alm 1+2	
		Vol flow alm 1	
		Vol flow alm 2	
		Vol flow alm 1+2	
		Density alm 1	
		Density alm 2	
		Density alm 1+2	
		Temp alm 1	
		Temp alm 2	
		Temp alm 1+2	
		Concentr. meas alm 1	
		Concentr. meas alm 2	
		Concentr. meas alm 1+2	
		Net flow alm 1	
		Net flow alm 2	
		Net flow alm 1+2	
		Slug Alarm	
		Empty alarm	
		Corrosion Alarm	
		All alarms	
		All errors	
		All alarms & errors	
	SO1 active mode	On Active	Sel
		Off Active	
	Pulse/Status out 2	Pulse/Stat 2 select	Sel
		Pulse	
		Status out	
		No function	

Detailed Setup

Pulse 2 select	Mass flow	Sel
	Volume flow	
	Density	
	Temperature	
	Concentration meas	
	Net flow	
	None	
	F-Total mass	
	R-Total mass	
	F-Total volume	
	R-Total volume	
	F-Total net	
	R-Total net	

Pulse 2 unit	Hz	Sel
	g/P	
	kg/P	
	t/P	
	lb/P	
	cm ³ /P	
	l/P	
	m ³ /P	
	gal/P	
	kgal/P	
	Cuft/P	
	bb/P	
	Impgal/P	
	klmpgal/P	
	l(N)/P	
	m ³ (N)/P	
	Sl/P	
	Scuft/P	
	Sm ³ /P	

Pulse 2 rate R/W

Pulse 2 active mode	On Active	Sel
	Off Active	

Pulse 2 width	0.05ms	Sel
	0.1ms	
	0.5ms	
	1ms	
	5ms	
	10ms	
	50ms	
	100ms	
	50ms	
	1000ms	

Detailed Setup	Pulse 2 at alarm	OP/0Hz	Sel
		Measured value Hold	
	SO2 function	No Function	Sel
		Flow direction Total switch Mass flow alm 1 Mass flow alm 2 Mass flow alm 1+2 Vol flow alm 1 Vol flow alm 2 Vol flow alm 1+2 Density alm 1 Density alm 2 Density alm 1+2 Temp alm 1 Temp alm 2 Temp alm 1+2 Concentr. meas alm 1 Concentr. meas alm 2 Concentr. meas alm 1+2 Net flow alm 1 Net flow alm 2 Net flow alm 1+2 Slug Alarm Empty alarm Corrosion Alarm All alarms All errors All alarms & errors	
	SO2 active mode	On Active	Sel
		Off Active	
	Status input	SI function	Sel
		No function Autozero Reset flex totals Reset mass totals Reset volume totals Reset net totals Reset all totals 0% signal lock	
		SI active mode	Sel
		On Active Off Active	

Detailed Setup	HART output	PV is	Mass flow	Sel
			Volume flow	
			Density	
			Temperature	
			Concentration meas	
			Net flow	
			None	
		SV is	Mass flow	Sel
			Volume flow	
			Density	
			Temperature	
			Concentration meas	
			Net flow	
			None	
			F-Total mass	
			R-Total mass	
			F-Total volume	
			R-Total volume	
			F-Total net	
			R-Total net	
			F-Total flex	
			R-Total flex	
			D-Total mass	
			D-Total volume	
			D-Total net	
			D-Total flex	
			F-Total energy	
			Velocity	
			Drive gain	
		TV is	Mass flow	Sel
		Volume flow		
		Density		
		Temperature		
		Concentration meas		
		Net flow		
		None		
		F-Total mass		
		R-Total mass		
		F-Total volume		
		R-Total volume		
		F-Total net		
		R-Total net		
		F-Total flex		
		R-Total flex		
		D-Total mass		
		D-Total volume		
		D-Total net		
		D-Total flex		
		F-Total energy		
		Velocity		
		Drive gain		

Detailed Setup	QV is		Mass flow	Sel
			Volume flow	
			Density	
			Temperature	
			Concentration meas	
			Net flow	
			None	
			F-Total mass	
			R-Total mass	
			F-Total volume	
			R-Total volume	
			F-Total net	
			R-Total net	
			F-Total flex	
			R-Total flex	
			D-Total mass	
			D-Total volume	
			D-Total net	
			D-Total flex	
			F-Total energy	
		Velocity		
		Drive gain		
Totalizer	Total flex select	Mass		Sel
		Volume		
		Net		
	Total flex unit	g		Sel
		kg		
		t		
		lb		
		cm ³		
		l		
		m ³		
		gal		
		kgal		
		Cuft		
		bbl		
		Impgal		
		KImpgal		
		l(N)		
		m ³ (N)		
		Sl		
		Scuft		
		MMscuft		
		Sm ³		
	Total mass unit	g		
		kg		
		t		
		lb		

Detailed Setup	Total volume unit	cm ³	Sel	
		l		
		m ³		
		gal		
		kgal		
		Cuft		
		bbl		
		Impgal		
		kimpgal		
		l(N)		
		m ³ (N)		
		Sl		
		Scuft		
		MMscuft		
		Sm ³		
	Total net unit	g		
		kg		
		t		
		lb		
		cm ³		
		l		
		m ³		
		gal		
		kgal		
		Cuft		
		bbl		
		Impgal		
		kimpgal		
	Total unit energy	MJ		Sel
		Btu		
	Energy factor	Heat of combustion	R/W	
		Heat of combustion unit	MJ/kg	Sel
		Btu/lb		
		MJ/m ³ (N)		
		Btu/Scuft		
Total switch select	Flex total	Sel		
	Mass total			
	Volume total			
	Net total			
Total limit switch		R/W		
Total at alarm	Hold	Sel		
	Continue total			
Total reset cntrl	Inhibit	Sel		
	Enable			

Detailed Setup			Total reset	Not Execute	
				Reset flex totals	Exe
				Reset mass totals	Exe
				Reset volume totals	Exe
				Reset net totals	Exe
				Reset all totals	Exe
	HART communication		Poll addr		R/W
			Num req pream		R/W
			Num resp pream		R/W
			Master Reset		Exe
	Modbus communication		Modbus Init		R/W
			Device Address		R/W
			Baud rate		R/W
			Data Format		R/W
			Modbus Mode		R/W
			Master Reset		Exe
	Concentration setup		Reference temperature		R/W
			Ref. density carrier		R/W
		Temp. coeff. a carrier		R/W	
		Temp. coeff. b carrier		R/W	
		Ref. density product		R/W	
		Temp. coeff. a product		R/W	
		Temp. coeff. b product		R/W	
Concentration meas		Concentr. meas unit	°Brix	Sel	
			Wt-% sol		
			Vol% sol		
			Vol%		
			Wt-%		
		Concentr. meas format	xxxxxx	Sel	
			xxxx.X		
			xxxx.XX		
			xxx.XXX		
			xx.XXXX		
			x.XXXXX		

Detailed Setup	Concentr.meas LRV		R/W	
	Concentr. meas URV		R/W	
	Concentr. meas damping		R/W	
	Concentr. meas lowcut		R/W	
	Conc meas alm 1 sel	No function	Sel	
		More than		
		Less than		
	Conc meas alm 1 crit		R/W	
	Conc meas alm 2 sel	No function	Sel	
		More than		
		Less than		
	Conc meas alm 2 crit		R/W	
	Net flow	Net flow select	Mass	Sel
			Volume	
		Net flow unit	g/s	Sel
		g/min		
		g/h		
		kg/s		
		kg/min		
		kg/h		
		kg/d		
		t/min		
		t/h		
		t/d		
		lb/s		
		lb/min		
		lb/h		
		lb/d		
		cm ³ /s		
		cm ³ /min		
		cm ³ /h		
		l/s		
		l/min		
		l/h		
		l/d		
		m ³ /s		
		m ³ /min		
		m ³ /h		
		m ³ /d		
		gal/s		
		gal/min		
		gal/h		
		gal/d		
		Cuft/s		

Detailed Setup		Cuft/min		
		Cuft/h		
		Cuft/d		
		bbl/s		
		bbl/min		
		bbl/h		
		bbl/d		
		Impgal/s		
		Impgal/min		
		Impgal/h		
		Impgal/d		
		Net flow format	xxxxxxx	Sel
			xxxxx.X	
			xxxx.XX	
			xxx.XXX	
			xx.XXXX	
			x.XXXXX	
		Net flow LRV		R/W
		Net flow URV		R/W
		Net flow damping		R/W
		Net flow lowcut		R/W
		Net flow alm 1 sel	No function	Sel
			More than	
			Less than	
		Net flow alm 1 crit		R/W
	Net flow alm 2 sel	No function	Sel	
		More than		
		Less than		
	Net flow alm 2 crit		R/W	
	Measuring range		R	
	Slug detection	Slug alarm select	Sel	
		Not apply		
		Apply		
		Drive gain	R	
		Slug criteria	R/W	
		Slug duration	R/W	
		After slug	Sel	
		Measured value		
		Hold		
		Drive gain damping		

Detailed Setup	Empty pipe detect	Empty pipe alm sel	Not apply	Sel
			Apply	
		Empty pipe crit		R/W
		After empty pipe	Massflow=Zero	Sel
			Measured Value	
			Hold	
	Corrosion detect	Corrosion alm sel	Not apply	Sel
			Apply	
		Corrosion crit		R/W
		Corrosion damp		R/W
	Fluid max temp			R
	Device information	Distributor		R
		Tag		R/W
		Long Tag		R/W
		Descriptor		R/W
		Message		R/W
		Date		R/W
		Sensor model		R
		Sensor S/N		R
		Assembly number		R
		Serial no. converter		R
		Serial no. detector		R
		Device S/W	Device S/W version	R
			Device S/W date	R
		Device id		R
		Universal rev		R
		Fld dev rev		R
		Software rev		R
		Hardware rev		R

Blank Page

7. MODBUS REGISTERS

7.1 Register Mapping

Used Modbus register types:

Register type	Size	Data Format	Data Type	Description
Short	16 bit	US16	Integer (2 Byte)	Unsigned 16-bit integers in the range of 0 to 65535.
Long	32 bit	US32	2 Integer (4 Byte)	Unsigned 32-bit integers in the range of 0 to 4294967295. 2 consecutive registers used to store the value.
Float	32 bit	FL32	Floating-point (4 Byte)	Float value in single precision in the IEEE-754 format.. 2 consecutive registers used to store the value.
String	16 bit	US16	8-bit ASCII (n * 2 Byte)	One or more consecutive registers. Each register contains 2 ASCII characters.

Legend:

Option /MB1	Parameter available in Option /MB1
Option /MB2	Parameter available in Option /MB2
Option /MB3	Parameter available in Option /MB3
Data format	Used register types
No. 16 bit Register	Number of used registers per value
Read/Write	Register is readable or writable or both
Holding register Modicon	Address offset of 40001 to Modicon holding register mapping
Input register Modicon	Address offset of 30001 to Modicon input register mapping
Flex Input	This register can be mapped to the "Flexible Input Register"
Flex Holding	This register can be mapped to the "Flexible Holding Register"

The Modbus registers are mapped into the following areas:

Parameter	Option /MB1	Option /MB2	Option /MB3	Data format	No. 16 bit Register	Read Write	Address			
							Holding Register	Holding Register Modicon	Input Register	Input Register Modicon
						R/W		4x		3x
Fast Access area Input register	x	x	x	US16 or FL32	1 or 2	R	-	-	0	30001
						
							96	30097		
Fast Access area Flex input register	-	x	x	US16 or FL32	1 or 2	R	-	-	98	30099
						
							118	30119		
Fast Writing area Flex holding register	-	x	x	US16 or FL32	1 or 2	R/W	0	40001		
							-	-
							22	40023		
Modbus communication register	x	x	x	US16	1	R/W	512	40513		
							-	-
							514	40515		
Holding Register for Measurement	x	x	x	US16 or FL32	1 or 2	R/W	528	40529		
							-	-
							3600	43601		
Holding Register for Display and Protection	-	x	x	US16 or FL32	1 or 2	R/W	3616	43617		
							-	-
							3952	43953		
Holding Register for HART and other outputs	-	-	x	US16 or FL32	1 or 2	R/W	4000	44001		
							-	-
							4784	44785		
Holding Register Byte order setting	-	x	x	US16	1	R/W	6272	46273		
							6288	46289	-	-
							6304	46305		
Holding Register Parameter Access Status	-	x	x	US16	1	R	6752	46753		
Holding Register for "Flexible Input Register Selection"	-	x	x	US16	1	R/W	6912	46913		
							-	-
							7056	47057		
Holding Register for "Flexible Holding Register Selection"	-	x	x	US16	1	R/W	7072	47073		
							-	-
							7216	47217		

7.2 Modbus Holding Register Address Summary

Parameter	Option /MB1	Option /MB2	Option /MB3	Flex input	Flex holding	Data format	No. 16 bit Register	Read Write	Address			
									Holding Register	Holding Register Modicon	Input Register	Input Register Modicon
Device address	x	x	x	-	-	US16	1	R/W	512	40513	-	-
Baud rate, Data format	x	x	x	-	-	US16	1	R/W	513	40514	-	-
Modbus mode	x	x	x	-	-	US16	1	R/W	514	40515	-	-
Mass flow	x	x	x	x	-	FL32	2	R	528	40529	0	30001
Volume flow	x	x	x	x	-	FL32	2	R	544	40545	2	30003
Density	x	x	x	x	-	FL32	2	R	560	40561	4	30005
Temperature	x	x	x	x	-	FL32	2	R	576	40577	6	30007
F-Total flex	x	x	x	x	-	FL32	2	R	592	40593	8	30009
R-Total flex	x	x	x	x	-	FL32	2	R	608	40609	10	30011
D-Total flex	x	x	x	x	-	FL32	2	R	624	40625	12	30013
F-Total mass	x	x	x	x	-	FL32	2	R	640	40641	14	30015
R-Total mass	x	x	x	x	-	FL32	2	R	656	40657	16	30017
D-Total mass	x	x	x	x	-	FL32	2	R	672	40673	18	30019
F-Total vol	x	x	x	x	-	FL32	2	R	688	40689	20	30021
R-Total vol	x	x	x	x	-	FL32	2	R	704	40705	22	30023
D-Total vol	x	x	x	x	-	FL32	2	R	720	40721	24	30025
F-Total net	x	x	x	x	-	FL32	2	R	736	40737	26	30027
R-Total net	x	x	x	x	-	FL32	2	R	752	40753	28	30029
D-Total net	x	x	x	x	-	FL32	2	R	768	40769	30	30031
Concentration meas	x	x	x	x	-	FL32	2	R	784	40785	32	30033
Net flow	x	x	x	x	-	FL32	2	R	800	40801	34	30035
F-Total energy	x	x	x	x	-	FL32	2	R	816	40817	36	30037
Velocity	x	x	x	x	-	FL32	2	R	832	40833	38	30039
Total reset cntrl	x	x	x	x	x	US16	1	R/W	848	40849	-	-
Total reset	x	x	x	-	-	US16	1	W	864	40865	-	-
Event overview error	-	x	x	x	-	US16	1	R	880	40881	-	-
Event overview alarm	-	x	x	x	-	US16	1	R	881	40882	-	-
Event overview warning	-	x	x	x	-	US16	1	R	882	40883	-	-
Error group1/2	x	x	x	x	-	US16	1	R	896	40897	42	30043
Alarm group1/2	x	x	x	x	-	US16	1	R	912	40913	43	30044
Warning group1/2	x	x	x	x	-	US16	1	R	928	40929	44	30045
Autozero to history	-	x	x	-	x	US16	2	W	944	40945	-	-
Autozero tuning	x	x	x	x	x	US16	1	R/W	960	40961	-	-
Autozero time	x	x	x	x	x	US16	1	R/W	976	40977	-	-
Autozero exe	x	x	x	-	-	US16	1	W	992	40993	-	-
Autozero value	x	x	x	x	-	FL32	2	R	1008	41009	-	-
Autozero range	-	x	x	x	-	FL32	2	R	1024	41025	-	-
Autozero fluctuation range	-	x	x	x	-	FL32	2	R	1040	41041	-	-
Flow direction	x	x	x	x	x	US16	1	R/W	1056	41057	-	-
Mass flow unit	x	x	x	x	x	US16	1	R/W	1072	41073	45	30046
Mass flow LRV	x	x	x	x	x	FL32	2	R/W	1088	41089	-	-
Mass flow URV	x	x	x	x	x	FL32	2	R/W	1104	41105	-	-
Mass flow damping	x	x	x	x	x	FL32	2	R/W	1120	41121	-	-
Mass flow lowcut	x	x	x	x	x	FL32	2	R/W	1136	41137	-	-

Parameter	Option /MB1	Option /MB2	Option /MB3	Flex input	Flex holding	Data format	No. 16 bit Register	Read Write	Address			
									Holding Register	Holding Register Modicon	Input Register	Input Register Modicon
Mass flow alm 1 sel	x	x	x	x	x	US16	1	R/W	1152	41153	-	-
Mass flow alm 1 crit	x	x	x	x	x	FL32	2	R/W	1168	41169	-	-
Mass flow alm 2 sel	-	x	x	x	x	US16	1	R/W	1184	41185	-	-
Mass flow alm 2 crit	-	x	x	x	x	FL32	2	R/W	1200	41201	-	-
Mass flow fix val sel	x	x	x	x	x	US16	1	R/W	1216	41217	-	-
Mass flow fixed val	x	x	x	x	x	FL32	2	R/W	1232	41233	-	-
Vol flow unit	x	x	x	x	x	US16	1	R/W	1248	41249	46	30047
Vol flow LRV	x	x	x	x	x	FL32	2	R/W	1264	41265	-	-
Vol flow URV	x	x	x	x	x	FL32	2	R/W	1280	41281	-	-
Vol flow damping	x	x	x	x	x	FL32	2	R/W	1296	41297	-	-
Vol flow lowcut	x	x	x	x	x	FL32	2	R/W	1312	41313	-	-
Vol flow alm 1 sel	x	x	x	x	x	US16	1	R/W	1328	41329	-	-
Vol flow alm 1 crit	x	x	x	x	x	FL32	2	R/W	1344	41345	-	-
Vol flow alm 2 sel	-	x	x	x	x	US16	1	R/W	1360	41361	-	-
Vol flow alm 2 crit	-	x	x	x	x	FL32	2	R/W	1376	41377	-	-
Density unit	x	x	x	x	x	US16	1	R/W	1392	41393	47	30048
Density LRV	x	x	x	x	x	FL32	2	R/W	1408	41409	-	-
Density URV	x	x	x	x	x	FL32	2	R/W	1424	41425	-	-
Density damping	x	x	x	x	x	FL32	2	R/W	1440	41441	-	-
Density lowcut	x	x	x	x	x	FL32	2	R/W	1456	41457	-	-
Density alm 1 sel	x	x	x	x	x	US16	1	R/W	1472	41473	-	-
Density alm1 crit	x	x	x	x	x	FL32	2	R/W	1488	41489	-	-
Density alm 2 sel	-	x	x	x	x	US16	1	R/W	1504	41505	-	-
Density alm 2 crit	-	x	x	x	x	FL32	2	R/W	1520	41521	-	-
Ref. density sel	x	x	x	x	x	US16	1	R/W	1536	41537	-	-
Reference density	x	x	x	x	x	FL32	2	R/W	1552	41553	-	-
Density offset	x	x	x	x	x	FL32	2	R/W	1568	41569	-	-
Pressure	x	x	x	x	x	FL32	2	R/W	1584	41585	-	-
Pressure unit	x	x	x	x	x	US16	1	R/W	1600	41601	-	-
Temperature unit	x	x	x	x	x	US16	1	R/W	1616	41617	48	30049
Temperature LRV	x	x	x	x	x	FL32	2	R/W	1632	41633	-	-
Temperature URV	x	x	x	x	x	FL32	2	R/W	1648	41649	-	-
Temperature damping	x	x	x	x	x	FL32	2	R/W	1664	41665	-	-
Temp alm 1 sel	x	x	x	x	x	US16	1	R/W	1680	41681	-	-
Temp alm 1 crit	x	x	x	x	x	FL32	2	R/W	1696	41697	-	-
Temp alm 2 sel	-	x	x	x	x	US16	1	R/W	1712	41713	-	-
Temp alm 2 crit	-	x	x	x	x	FL32	2	R/W	1728	41729	-	-
Temp fix val select	x	x	x	x	x	US16	1	R/W	1744	41745	-	-
Temp fixed val	x	x	x	x	x	FL32	2	R/W	1760	41761	-	-
Temp gain	x	x	x	x	x	FL32	2	R/W	1776	41777	-	-
Velocity unit	x	x	x	x	x	US16	1	R/W	1792	41793	49	30050
Total flex select	x	x	x	x	x	US16	1	R/W	1808	41809	-	-
Total flex unit	x	x	x	x	x	US16	1	R/W	1824	41825	50	30051
Total mass unit	x	x	x	x	x	US16	1	R/W	1840	41841	51	30052
Total volume unit	x	x	x	x	x	US16	1	R/W	1856	41857	52	30053
Total net unit	x	x	x	x	x	US16	1	R/W	1872	41873	53	30054
Total switch select	x	x	x	x	x	US16	1	R/W	1888	41889	-	-

Parameter	Option /MB1	Option /MB2	Option /MB3	Flex input	Flex holding	Data format	No. 16 bit Register	Read Write	Address			
									Holding Register	Holding Register Modicon	Input Register	Input Register Modicon
								R/W	4x		3x	
Total limit switch	x	x	x	x	x	FL32	2	R/W	1904	41905	-	-
Total unit energy	x	x	x	x	x	US16	1	R/W	1920	41921	54	30055
Total at alarm	-	x	x	x	x	US16	1	R/W	1936	41937	-	-
Energy factor/ heat of combust	-	x	x	x	x	FL32	2	R/W	1952	41953	-	-
Energy fact/ heat of comb unit	-	x	x	x	x	US16	1	R/W	1968	41969	-	-
Device id	-	x	x	x	-	US16	2	R	1984	41985	-	-
Modbus option	-	x	x	x	-	US16	1	R	2000	42001	-	-
SK20	-	x	x	x	x	FL32	2	R/W	2016	42017	-	-
SKT	-	x	x	x	x	FL32	2	R/W	2032	42033	-	-
SKTK	-	x	x	x	x	FL32	2	R/W	2048	42049	-	-
RV	-	x	x	x	x	FL32	2	R/W	2064	42065	-	-
Qnom	-	x	x	x	-	FL32	2	R	2080	42081	-	-
KD	-	x	x	x	x	FL32	2	R/W	2096	42097	-	-
fl20	-	x	x	x	x	FL32	2	R/W	2112	42113	-	-
FTC1	-	x	x	x	x	FL32	2	R/W	2128	42129	-	-
FTCK	-	x	x	x	x	FL32	2	R/W	2144	42145	-	-
SKP	-	x	x	x	x	FL32	2	R/W	2160	42161	-	-
SKPT	-	x	x	x	x	FL32	2	R/W	2176	42177	-	-
FPC	-	x	x	x	x	FL32	2	R/W	2192	42193	-	-
FPTC	-	x	x	x	x	FL32	2	R/W	2208	42209	-	-
FQC1	-	x	x	x	x	FL32	2	R/W	2224	42225	-	-
FQC2	-	x	x	x	x	FL32	2	R/W	2240	42241	-	-
Modbus init (Restart Modbus)	x	x	x	-	-	US16	1	W	2256	42257	-	-
Reference temperature	-	x	x	x	x	FL32	2	R/W	2272	42273	-	-
Ref. density carrier	-	x	x	x	x	FL32	2	R/W	2288	42289	-	-
Temp. coeff. A carrier	-	x	x	x	x	FL32	2	R/W	2304	42305	-	-
Temp. coeff. B carrier	-	x	x	x	x	FL32	2	R/W	2320	42321	-	-
Ref. density product	-	x	x	x	x	FL32	2	R/W	2336	42337	-	-
Temp. coeff. A product	-	x	x	x	x	FL32	2	R/W	2352	42353	-	-
Temp. coeff. B product	-	x	x	x	x	FL32	2	R/W	2368	42369	-	-
Concentration meas unit	x	x	x	x	x	US16	1	R/W	2384	42385	55	30056
Concentration meas LRV	x	x	x	x	x	FL32	2	R/W	2400	42401	-	-
Concentration meas URV	x	x	x	x	x	FL32	2	R/W	2416	42417	-	-
Concentration meas Damp	x	x	x	x	x	FL32	2	R/W	2432	42433	-	-
Concentration meas lowcut	x	x	x	x	x	FL32	2	R/W	2448	42449	-	-
Conc meas alm 1 sel	x	x	x	x	x	US16	1	R/W	2464	42465	-	-
Conc meas alm 1 crit	x	x	x	x	x	FL32	2	R/W	2480	42481	-	-
Conc meas alm 2 sel	-	x	x	x	x	US16	1	R/W	2496	42497	-	-
Conc meas alm 2 crit	-	x	x	x	x	FL32	2	R/W	2512	42513	-	-
Net flow select	-	x	x	x	x	US16	1	R/W	2528	42529	-	-
Net flow unit	x	x	x	x	x	US16	1	R/W	2544	42545	56	30057
Net flow LRV	x	x	x	x	x	FL32	2	R/W	2560	42561	-	-
Net flow URV	x	x	x	x	x	FL32	2	R/W	2576	42577	-	-
Net flow damping	x	x	x	x	x	FL32	2	R/W	2592	42593	-	-
Net flow lowcut	x	x	x	x	x	FL32	2	R/W	2608	42609	-	-

Parameter	Option /MB1	Option /MB2	Option /MB3	Flex input	Flex holding	Data format	No. 16 bit Register	Read Write	Address			
									Holding Register	Holding Register Modicon	Input Register	Input Register Modicon
									R/W	4x		3x
Net flow alm 1 sel	x	x	x	x	x	US16	1	R/W	2624	42625	-	-
Net flow alm 1 crit	x	x	x	x	x	FL32	2	R/W	2640	42641	-	-
Net flow alm 2 sel	-	x	x	x	x	US16	1	R/W	2656	42657	-	-
Net flow alm 2 crit	-	x	x	x	x	FL32	2	R/W	2672	42673	-	-
Slug alarm select	-	x	x	x	x	US16	1	R/W	2688	42689	-	-
Slug criteria	-	x	x	x	x	FL32	2	R/W	2704	42705	-	-
Slug duration	-	x	x	x	x	US16	1	R/W	2720	42721	-	-
After slug	-	x	x	x	x	US16	1	R/W	2736	42737	-	-
Drive gain damping	-	x	x	x	x	FL32	2	R/W	2752	42753	-	-
Empty pipe alarm sel	-	x	x	x	x	US16	1	R/W	2768	42769	-	-
Empty pipe criteria	-	x	x	x	x	FL32	2	R/W	2784	42785	-	-
After empty pipe	-	x	x	x	x	US16	1	R/W	2800	42801	-	-
Sensor model	x	x	x	x	x	US16	1	R/W	2816	42817	-	-
Corrosion alarm sel	-	x	x	x	x	US16	1	R/W	2832	42833	-	-
Corrosion criteria	-	x	x	x	x	FL32	2	R/W	2848	42849	-	-
Corrosion damp	-	x	x	x	x	FL32	2	R/W	2864	42865	-	-
Master reset	x	x	x	-	-	US16	1	W	2880	42881	-	-
Write protect	-	x	x	x	x	US16	1	R/W	2896	42897	-	-
Key status	-	x	x	x	x	US16	1	R/W	2912	42913	-	-
Fluid max temp	-	x	x	x	-	FL32	2	R	2944	42945	-	-
Actual density	x	x	x	x	-	FL32	2	R	2960	42961	40	30041
Mass flow in "g/s"	x	x	x	x	-	FL32	2	R	2976	42977	57	30058
Volume flow in "cm ³ /s"	x	x	x	x	-	FL32	2	R	2992	42993	59	30060
Density in "g/cm ³ "	x	x	x	x	-	FL32	2	R	3008	43009	61	30062
Temperature in "°C"	x	x	x	x	-	FL32	2	R	3024	43025	63	30064
F-Total mass in "g"	x	x	x	x	-	FL32	2	R	3040	43041	65	30066
R-Total mass in "g"	x	x	x	x	-	FL32	2	R	3056	43057	67	30068
D-Total mass in "g"	x	x	x	x	-	FL32	2	R	3072	43073	69	30070
F-Total vol in "cm ³ "	x	x	x	x	-	FL32	2	R	3088	43089	71	30072
R-Total vol in "cm ³ "	x	x	x	x	-	FL32	2	R	3104	43105	73	30074
D-Total vol in "cm ³ "	x	x	x	x	-	FL32	2	R	3120	43121	75	30076
S1 amplitude	x	x	x	x	-	FL32	2	R	3136	43137	77	30078
S2 amplitude	x	x	x	x	-	FL32	2	R	3152	43153	79	30080
Drive gain	x	x	x	x	-	FL32	2	R	3168	43169	81	30082
Frequency	x	x	x	x	-	FL32	2	R	3184	43185	83	30084
Phase difference	x	x	x	x	-	FL32	2	R	3200	43201	85	30086
History ordered	-	x	x	x	-	US16	10	R	3216	43217	-	-
Clear history ordered	-	x	x	x	x	US16	1	R/W	3232	43233	-	-
Hist overview error	-	x	x	x	-	US16	1	R	3248	43249	-	-
Hist overview alarm	-	x	x	x	-	US16	1	R	3249	43250	-	-
Hist overview warning	-	x	x	x	-	US16	1	R	3250	43251	-	-
Hist abs error group1/2	-	x	x	x	-	US16	1	R	3264	43265	-	-
Hist abs alarm group1/2	-	x	x	x	-	US16	1	R	3265	43266	-	-
Hist abs warning group1/2	-	x	x	x	-	US16	1	R	3266	43267	-	-
History abs entry 1-4	-	x	x	x	-	US16	16	R	3280	43281	-	-
History abs entry 5-8	-	x	x	x	-	US16	16	R	3296	43297	-	-
History abs entry 9-10	-	x	x	x	-	US16	8	R	3312	43313	-	-

Parameter	Option /MB1	Option /MB2	Option /MB3	Flex input	Flex holding	Data format	No. 16 bit Register	Read Write	Address			
									Holding Register	Holding Register Modicon	Input Register	Input Register Modicon
								R/W		4x		3x
Clear history absolute	-	x	x	-	x	US16	2	W	3360	43361	-	-
Tag	-	x	x	x	x	String	4	R/W	3376	43377	-	-
Long tag	-	x	x	x	x	String	11	R/W	3392	43393	-	-
Distributor	-	x	x	x	-	String	4	R	3408	43409	-	-
Descriptor	-	x	x	x	x	String	8	R/W	3424	43425	-	-
Message	-	x	x	x	x	String	16	R/W	3440	43441	-	-
Date	-	x	x	x	x	US16	2	R/W	3456	43457	-	-
Sensor S/N	-	x	x	x	-	US32	2	R	3472	43473	-	-
Assembly number	-	x	x	x	-	US32	2	R	3488	43489	-	-
Serial no. converter	-	x	x	x	-	String	8	R	3504	43505	-	-
Serial no. detector	-	x	x	x	-	String	8	R	3512	43513	-	-
Software rev	-	x	x	x	-	US16	1	R	3520	43521	-	-
Hardware rev	-	x	x	x	-	US16	1	R	3521	43522	-	-
Device S/W version	-	x	x	x	-	String	10	R	3536	43537	-	-
Device S/W date	-	x	x	x	-	US16	2	R	3552	43553	-	-
MS code line 1	-	x	x	x	-	String	16	R	3568	43569	-	-
MS code line 2	-	x	x	x	-	String	16	R	3584	43585	-	-
MS code line 3	-	x	x	x	-	String	16	R	3600	43601	-	-
Disp select 1	-	x	x	x	x	US16	1	R/W	3616	43617	-	-
Disp select 2	-	x	x	x	x	US16	1	R/W	3632	43633	-	-
Disp select 3	-	x	x	x	x	US16	1	R/W	3648	43649	-	-
Disp select 4	-	x	x	x	x	US16	1	R/W	3664	43665	-	-
Disp contrast	-	x	x	x	x	US16	1	R/W	3680	43681	-	-
Disp period	-	x	x	x	x	US16	1	R/W	3696	43697	-	-
Mass flow format	-	x	x	x	x	US16	1	R/W	3712	43713	-	-
Vol flow format	-	x	x	x	x	US16	1	R/W	3728	43729	-	-
Density format	-	x	x	x	x	US16	1	R/W	3744	43745	-	-
Temperature format	-	x	x	x	x	US16	1	R/W	3760	43761	-	-
Conc meas format	-	x	x	x	x	US16	1	R/W	3776	43777	-	-
Net flow format	-	x	x	x	x	US16	1	R/W	3792	43793	-	-
Test LCD	-	x	x	x	x	US16	1	R/W	3808	43809	-	-
Test keys	-	x	x	x	x	US16	1	R/W	3824	43825	-	-
Enable WRT 10 min	-	x	x	-	x	String	4	W	3840	43841	-	-
New password	-	x	x	-	x	String	4	W	3856	43857	-	-
Software seal	-	x	x	x	-	US16	1	R	3872	43873	-	-
AZ active value	-	x	x	x	-	FL32	2	R	3888	43889	-	-
AZ active density	-	x	x	x	-	FL32	2	R	3890	43891	-	-
AZ active temperature	-	x	x	x	-	FL32	2	R	3892	43893	-	-
AZ initialize value	-	x	x	x	-	FL32	2	R	3904	43905	-	-
AZ initialize density	-	x	x	x	-	FL32	2	R	3906	43907	-	-
AZ initialize temperature	-	x	x	x	-	FL32	2	R	3908	43909	-	-
AZ initialize date	-	x	x	x	-	US16	2	R	3910	43911	-	-
AZ history entry 1-2	-	x	x	x	-	US16	16	R	3920	43921	-	-
AZ history entry 3-4	-	x	x	x	-	US16	16	R	3936	43937	-	-
AZ history entry 5	-	x	x	x	-	US16	8	R	3952	43953	-	-

7.3 Modbus Holding Register for Outputs (only /MB3)

Parameter	Option /MB1	Option /MB2	Option /MB3	Flex input	Flex holding	Data format	No. 16 bit Register	Read Write	Address			
									Holding Register	Holding Register Modicon	Input Register	Input Register Modicon
Universal rev	-	-	x	x	-	US16	1	R	4000	44001	-	-
Fld. dev rev.	-	-	x	x	-	US16	1	R	4001	44002	-	-
Poll address	-	-	x	x	x	US16	1	R/W	4016	44017	-	-
Num req pream	-	-	x	x	-	US16	1	R	4032	44033	-	-
Num resp pream	-	-	x	x	x	US16	1	R/W	4048	44049	-	-
Analog output 1 Unit	-	-	x	x	-	US16	1	R	4064	44065	91	30092
Analog output 1	-	-	x	x	-	FL32	2	R	4080	44081	92	30093
Analog output 1%	-	-	x	x	-	FL32	2	R	4096	44097	94	30095
Analog output 1 mA	-	-	x	x	-	FL32	2	R	4112	44113	96	30097
Pulse output 1	-	-	x	x	-	FL32	2	R	4128	44129	-	-
Status output 1	-	-	x	x	-	US16	1	R	4144	44145	-	-
Pulse output 2	-	-	x	x	-	FL32	2	R	4160	44161	-	-
Status output 2	-	-	x	x	-	US16	1	R	4176	44177	-	-
View input	-	-	x	x	-	US16	1	R	4192	44193	-	-
Analog output 1 (Test)	-	-	x	-	x	FL32	2	W	4208	44209	-	-
Pulse output 1 (Test)	-	-	x	-	x	US16	1	W	4224	44225	-	-
Status output 1 (Test)	-	-	x	-	x	US16	1	W	4240	44241	-	-
Pulse output 2 (Test)	-	-	x	-	x	FL32	2	W	4256	44257	-	-
Status output 2 (Test)	-	-	x	-	x	US16	1	W	4272	44273	-	-
Status Input (Test)	-	-	x	x	-	US16	1	R	4288	44289	-	-
Analog 1 select	-	-	x	x	x	US16	1	R/W	4304	44305	-	-
Analog 1 alarm out	-	-	x	x	x	US16	1	R/W	4320	44321	-	-
Analog 1 low LMT	-	-	x	x	x	FL32	2	R/W	4336	44337	-	-
Analog 1 high LMT	-	-	x	x	x	FL32	2	R/W	4352	44353	-	-
Pulse/Stat 1 select	-	-	x	x	x	US16	1	R/W	4368	44369	-	-
Pulse 1 select	-	-	x	x	x	US16	1	R/W	4384	44385	-	-
Pulse 1 unit	-	-	x	x	x	US16	1	R/W	4400	44401	-	-
Pulse 1 rate	-	-	x	x	x	FL32	2	R/W	4416	44417	-	-
Pulse 1 active mode	-	-	x	x	x	US16	1	R/W	4432	44433	-	-
Pulse 1 width	-	-	x	x	x	US16	1	R/W	4448	44449	-	-
Pulse 1 at alarm	-	-	x	x	x	US16	1	R/W	4464	44465	-	-
SO 1 function	-	-	x	x	x	US16	1	R/W	4480	44481	-	-
SO 1 active mode	-	-	x	x	x	US16	1	R/W	4496	44497	-	-
Pulse/Stat 2 select	-	-	x	x	x	US16	1	R/W	4512	44513	-	-
Pulse 2 select	-	-	x	x	x	US16	1	R/W	4528	44529	-	-
Pulse 2 unit	-	-	x	x	x	US16	1	R/W	4544	44545	-	-
Pulse 2 rate	-	-	x	x	x	FL32	2	R/W	4560	44561	-	-
Pulse 2 active mode	-	-	x	x	x	US16	1	R/W	4576	44577	-	-
Pulse 2 width	-	-	x	x	x	US16	1	R/W	4592	44593	-	-
Pulse 2 at alarm	-	-	x	x	x	US16	1	R/W	4608	44609	-	-
SO 2 function	-	-	x	x	x	US16	1	R/W	4624	44625	-	-
SO 2 active mode	-	-	x	x	x	US16	1	R/W	4640	44641	-	-
PV is	-	-	x	x	x	US16	1	R/W	4656	44657	-	-
SV is	-	-	x	x	x	US16	1	R/W	4672	44673	-	-
TV is	-	-	x	x	x	US16	1	R/W	4688	44689	-	-

Parameter	Option /MB1	Option /MB2	Option /MB3	Flex input	Flex holding	Data format	No. 16 bit Register	Read Write	Address			
									Holding Register	Holding Register Modicon	Input Register	Input Register Modicon
									R/W	4x		3x
QV is	-	-	x	x	x	US16	1	R/W	4704	44705	-	-
SI function	-	-	x	x	x	US16	1	R/W	4720	44721	-	-
SI active mode	-	-	x	x	x	US16	1	R/W	4736	44737	-	-
Output trim AO1 4mA	-	-	x	-	x	FL32	2	W	4752	44753	-	-
Output trim AO1 20mA	-	-	x	-	x	FL32	2	W	4768	44769	-	-
Measuring range	-	-	x	x	-	US16	1	R	4784	44785	-	-

7.4 Modbus Specific Holding Register

Parameter	Option /MB1	Option /MB2	Option /MB3	Flex input	Flex holding	Data format	No. 16 bit Register	Read Write	Address			
									Holding Register	Holding Register Modicon	Input Register	Input Register Modicon
									R/W	4x		3x
Modbus Initialization												
Device address	x	x	x	-	-	US16	1	R/W	512	40513	-	-
Baud rate, Data format	x	x	x	-	-	US16	1	R/W	513	40514	-	-
Modbus mode	x	x	x	-	-	US16	1	R/W	514	40515	-	-
Modbus option	-	x	x	-	-	US16	1	R	2000	42001	-	-
Modbus init (Restart Modbus)	x	x	x	-	-	US16	1	W	2256	42257	-	-
Modbus Byte order setting												
Byte order long register	-	x	x	-	-	US16	1	R/W	6272	46273	-	-
Byte order float register	-	x	x	-	-	US16	1	R/W	6288	46289	-	-
Byte order string register	-	x	x	-	-	US16	1	R/W	6304	46305	-	-
Modbus Communication Status												
Holding register	-	x	x	-	-	US16	2	R	6752	46753	87	30088
Access status	-	x	x	-	-	US16	2	R	6753	46754	88	30089
Access count	-	x	x	-	-	US16	2	R	6754	46755	89	30090
Failed count	-	x	x	-	-	US16	2	R	6755	46756	90	30091
Device Reset (Master reset)												
Master reset	x	x	x	-	-	US16	1	W	2880	42881	-	-
Write protection												
Write protect	-	x	x	x	-	US16	1	R	2896	42897	-	-
Key status	-	x	x	x	-	US16	1	R/W	2912	42913	-	-
Enable WRT 10 min	-	x	x	-	-	String	4	W	3840	43841	-	-
New password	-	x	x	-	-	String	4	W	3856	43857	-	-
Software seal	-	x	x	x	-	US16	1	R	3872	43873	-	-

7.5 Modbus Input Register Summary

Parameter	Option /MB1	Option /MB2	Option /MB3	Flex input	Flex holding	Data format	No. 16 bit Register	Read Write	Address			
									Holding Register	Holding Register Modicon	Input Register	Input Register Modicon
									R/W	4x		3x
Mass flow	x	x	x	x	-	FL32	2	R	528	40529	0	30001
Volume flow	x	x	x	x	-	FL32	2	R	544	40545	2	30003
Density	x	x	x	x	-	FL32	2	R	560	40561	4	30005
Temperature	x	x	x	x	-	FL32	2	R	576	40577	6	30007
F-Total flex	x	x	x	x	-	FL32	2	R	592	40593	8	30009
R-Total flex	x	x	x	x	-	FL32	2	R	608	40609	10	30011
D-Total flex	x	x	x	x	-	FL32	2	R	624	40625	12	30013
F-Total mass	x	x	x	x	-	FL32	2	R	640	40641	14	30015
R-Total mass	x	x	x	x	-	FL32	2	R	656	40657	16	30017
D-Total mass	x	x	x	x	-	FL32	2	R	672	40673	18	30019
F-Total vol	x	x	x	x	-	FL32	2	R	688	40689	20	30021
R-Total vol	x	x	x	x	-	FL32	2	R	704	40705	22	30023
D-Total vol	x	x	x	x	-	FL32	2	R	720	40721	24	30025
F-Total net	x	x	x	x	-	FL32	2	R	736	40737	26	30027
R-Total net	x	x	x	x	-	FL32	2	R	752	40753	28	30029
D-Total net	x	x	x	x	-	FL32	2	R	768	40769	30	30031
Concentration meas	x	x	x	x	-	FL32	2	R	784	40785	32	30033
Net flow	x	x	x	x	-	FL32	2	R	800	40801	34	30035
F-Total energy	x	x	x	x	-	FL32	2	R	816	40817	36	30037
Velocity	x	x	x	x	-	FL32	2	R	832	40833	38	30039
Actual density	x	x	x	x	-	FL32	2	R	2960	42961	40	30041
Error group1/2	x	x	x	x	-	US16	1	R	896	40897	42	30043
Alarm group1/2	x	x	x	x	-	US16	1	R	912	40913	43	30044
Warning group1/2	x	x	x	x	-	US16	1	R	928	40929	44	30045
Mass flow unit	x	x	x	x	x	US16	1	R/W	1072	41073	45	30046
Vol flow unit	x	x	x	x	x	US16	1	R/W	1248	41249	46	30047
Density unit	x	x	x	x	x	US16	1	R/W	1392	41393	47	30048
Temperature unit	x	x	x	x	x	US16	1	R/W	1616	41617	48	30049
Velocity unit	x	x	x	x	x	US16	1	R/W	1792	41793	49	30050
Total flex unit	x	x	x	x	x	US16	1	R/W	1824	41825	50	30051
Total mass unit	x	x	x	x	x	US16	1	R/W	1840	41841	51	30052
Total volume unit	x	x	x	x	x	US16	1	R/W	1856	41857	52	30053
Total net unit	x	x	x	x	x	US16	1	R/W	1872	41873	53	30054
Total unit energy	x	x	x	x	x	US16	1	R/W	1920	41921	54	30055
Concentration meas unit	x	x	x	x	x	US16	1	R/W	2384	42385	55	30056
Net flow unit	x	x	x	x	x	US16	1	R/W	2544	42545	56	30057
Mass flow in "g/s"	x	x	x	x	-	FL32	2	R	2976	42977	57	30058
Volume flow in "cm ³ /s"	x	x	x	x	-	FL32	2	R	2992	42993	59	30060
Density in "g/cm ³ "	x	x	x	x	-	FL32	2	R	3008	43009	61	30062
Temperature in "°C"	x	x	x	x	-	FL32	2	R	3024	43025	63	30064
F-Total mass in "g"	x	x	x	x	-	FL32	2	R	3040	43041	65	30066

Parameter	Option /MB1	Option /MB2	Option /MB3	Flex input	Flex holding	Data format	No. 16 bit Register	Read Write	Address			
									Holding Register	Holding Register Modicon	Input Register	Input Register Modicon
									R/W	4x		3x
R-Total mass in "g"	x	x	x	x	-	FL32	2	R	3056	43057	67	30068
D-Total mass in "g"	x	x	x	x	-	FL32	2	R	3072	43073	69	30070
F-Total vol in "cm ³ "	x	x	x	x	-	FL32	2	R	3088	43089	71	30072
R-Total vol in "cm ³ "	x	x	x	x	-	FL32	2	R	3104	43105	73	30074
D-Total vol in "cm ³ "	x	x	x	x	-	FL32	2	R	3120	43121	75	30076
S1 amplitude	x	x	x	x	-	FL32	2	R	3136	43137	77	30078
S2 amplitude	x	x	x	x	-	FL32	2	R	3152	43153	79	30080
Drive gain	x	x	x	x	-	FL32	2	R	3168	43169	81	30082
Frequency	x	x	x	x	-	FL32	2	R	3184	43185	83	30084
Phase difference	x	x	x	x	-	FL32	2	R	3200	43201	85	30086
Holding register	-	x	x	-	-	US16	2	R	6752	46753	87	30088
Access status	-	x	x	-	-	US16	2	R	6753	46754	88	30089
Access count	-	x	x	-	-	US16	2	R	6754	46755	89	30090
Failed count	-	x	x	-	-	US16	2	R	6755	46756	90	30091
Analog output 1 Unit	-	-	x	x	-	US16	1	R	4064	44065	91	30092
Analog output 1	-	-	x	x	-	FL32	2	R	4080	44081	92	30093
Analog output 1%	-	-	x	x	-	FL32	2	R	4096	44097	94	30095
Analog output 1 mA	-	-	x	x	-	FL32	2	R	4112	44113	96	30097
Flex input register 01	-	x	x	-	-	US16	1	R	-	-	98	30099
Flex input register 02	-	x	x	-	-	US16	1	R	-	-	99	30100
Flex input register 03	-	x	x	-	-	US16	1	R	-	-	100	30101
Flex input register 04	-	x	x	-	-	US16	1	R	-	-	101	30102
Flex input register 05	-	x	x	-	-	US16	1	R	-	-	102	30103
Flex input register 06	-	x	x	-	-	US16	1	R	-	-	103	30104
Flex input register 07	-	x	x	-	-	US16	1	R	-	-	104	30105
Flex input register 08	-	x	x	-	-	US16	1	R	-	-	105	30106
Flex input register 09	-	x	x	-	-	US16	1	R	-	-	106	30107
Flex input register 10	-	x	x	-	-	US16	1	R	-	-	107	30108
Flex input register 11	-	x	x	-	-	US16	1	R	-	-	108	30109
Flex input register 12	-	x	x	-	-	US16	1	R	-	-	109	30110
Flex input register 13	-	x	x	-	-	US16	1	R	-	-	110	30111
Flex input register 14	-	x	x	-	-	US16	1	R	-	-	111	30112
Flex input register 15	-	x	x	-	-	US16	1	R	-	-	112	30113
Flex input register 16	-	x	x	-	-	US16	1	R	-	-	113	30114
Flex input register 17	-	x	x	-	-	US16	1	R	-	-	114	30115
Flex input register 18	-	x	x	-	-	US16	1	R	-	-	115	30116
Flex input register 19	-	x	x	-	-	US16	1	R	-	-	116	30117
Flex input register 20	-	x	x	-	-	US16	1	R	-	-	117	30118

7.6 Modbus Holding Register Settings for Outputs

All available parameters are assigned to holding registers wherein the measurement values are assigned to input registers on Modbus. A list of all available parameters and registers for Modbus communication option /MB2 and option /MB3 can be found in the table below. The table contains also the selection values which can be written to selection parameters.

Parameter	Data range	Selection	Unit	Register	Read Write	Address	
					R, W	Holding register	Input register
Device address	1 to 247	-	-	US16	R/W	512	-
Baud rate Data format	1200 E1	0	-	US16	R/W	513	-
	1200 O1	1					
	1200 N2	2					
	1200 N1	3					
	2400 E1	4					
	2400 O1	5					
	2400 N2	6					
	2400 N1	7					
	4800 E1	8					
	4800 O1	9					
	4800 N2	10					
	4800 N1	11					
	9600 E1	12					
	9600 O1	13					
	9600 N2	14					
	9600 N1	15					
	19200 E1	16					
	19200 O1	17					
	19200 N2	18					
	19200 N1	19					
	38400 E1	20					
	38400 O1	21					
	38400 N2	22					
	38400 N1	23					
	57600 E1	24					
	57600 O1	25					
	57600 N2	26					
	57600 N1	27					
	76800 E1	28					
	76800 O1	29					
	76800 N2	30					
	76800 N1	31					
	115200 E1	32					
	115200 O1	33					
	115200 N2	34					
115200 N1	35						
Modbus mode	RTU	0	-	US16	R/W	514	-
	ASCII	1					
Modbus init	Not execute	0	-	US16	W	2256	-
	Execute	1					
Mass flow	-	-	Mass flow unit	FL32	R	528	0

Parameter	Data range	Selection	Unit	Register	Read Write	Address	
					R, W	Holding register	Input register
Volume flow	-	-	Vol flow unit	FL32	R	544	2
Density	-	-	Density unit	FL32	R	560	4
Temperature	-	-	Temp. unit	FL32	R	576	6
F-Total flex	-	-	Total flex unit	FL32	R	592	8
R-Total flex	-	-	Total flex unit	FL32	R	608	10
D-Total flex	-	-	Total flex unit	FL32	R	624	12
F-Total mass	-	-	Total mass unit	FL32	R	640	14
R-Total mass	-	-	Total mass unit	FL32	R	656	16
D-Total mass	-	-	Total mass unit	FL32	R	672	18
F-Total vol	-	-	Total vol unit	FL32	R	688	20
R-Total vol	-	-	Total vol unit	FL32	R	704	22
D-Total vol	-	-	Total vol unit	FL32	R	720	24
F-Total net	-	-	Total net unit	FL32	R	736	26
R-Total net	-	-	Total net unit	FL32	R	752	28
D-Total net	-	-	Total net unit	FL32	R	768	30
Concentration meas	0 to 110	-	Conc meas unit	FL32	R	784	32
Net flow	-	-	Mass flow unit	FL32	R	800	34
F-Total energy	-	-	Total unit energy	FL32	R	816	36
Velocity	-	-	Velocity unit	FL32	R	832	38
Total reset cntrl	Inhibit	0	-	US16	R/W	848	-
	Enable	1					
Total reset	Not execute	0	-	US16	W	864	-
	Reset flex totals	1					
	Reset mass totals	2					
	Reset volume totals	3					
	Reset net totals	4					
	Reset all totals	5					
Event overview error	-	-	-	US16	R	880	-
Event overv. alarm	-	-	-	US16	R	881	-
Event overv. warning	-	-	-	US16	R	882	-
Error group1/2	Group1: High byte Group2: Low byte	-	-	US16	R	896	42
Alarm group1/2	Group1: High byte Group2: Low byte	-	-	US16	R	912	43
Warning group1/2	Group1: High byte Group2: Low byte	-	-	US16	R	928	44
Autozero to history	mm/dd/yyyy	-	-	US16	R/W	944	-
Autozero tuning	Inhibit	0	-	US16	R/W	960	-
	Enable	1					
Autozero time	3 min	0	-	US16	R/W	976	-
	30 s	1					
Autozero exe	Not execute	0	-	US16	R/W	992	-
	Execute	1					
Autozero value	depends on size	-	kg/h	FL32	R	1008	-
Autozero range	depends on size	-	kg/h	FL32	R	1024	-
Autozero fluctuation	depends on size	-	kg/h	FL32	R	1040	-
Flow direction	Forward	0	-	US16	R/W	1056	-
	Reverse	1					

Parameter	Data range	Selection	Unit	Register	Read Write	Address	
					R, W	Holding register	Input register
Mass flow unit	g/s	70	-	US16	R/W	1072	45
	g/min	71					
	g/h	72					
	kg/s	73					
	kg/min	74					
	kg/h	75					
	kg/d	76					
	t/min	77					
	t/h	78					
	t/d	79					
	lb/s	80					
	lb/min	81					
	lb/h	82					
	lb/d	83					
Mass flow LRV	-Qmax to Qmax	-	Mass flow unit	FL32	R/W	1088	-
Mass flow URV	-Qmax to Qmax	-	Mass flow unit	FL32	R/W	1104	-
Mass flow damping	0 to 200	-	Sec.	FL32	R/W	1120	-
Mass flow lowcut	0 to Qmax	-	Mass flow unit	FL32	R/W	1136	-
Mass flow alm 1 sel	No function	0	-	US16	R/W	1152	-
	More than	1					
	Less than	2					
Mass flow alm 1 crit	-110% to 110%	-	Mass flow unit	FL32	R/W	1168	-
	of URV						
Mass flow alm 2 sel	No function	0	-	US16	R/W	1184	-
	More than	1					
	Less than	2					
Mass flow alm 2 crit	-110% to 110%	-	Mass flow unit	FL32	R/W	1200	-
	of URV						
Mass flow fix val sel	Inhibit	0	-	US16	R/W	1216	-
	Enable	1					
Mass flow fixed val	0 to Qnom	-	Mass flow unit	FL32	R/W	1232	-

Parameter	Data range	Selection	Unit	Register	Read Write	Address	
					R, W	Holding register	Input register
Vol flow unit	cm ³ /s	240	-	US16	R/W	1248	46
	cm ³ /min	241					
	cm ³ /h	242					
	l/s	24					
	l/min	17					
	l/h	138					
	l/d	221					
	m ³ /s	28					
	m ³ /min	131					
	m ³ /h	19					
	m ³ /d	29					
	gal/s	22					
	gal/min	16					
	gal/h	136					
	gal/d	235					
	Cuft/s	26					
	Cuft/min	15					
	Cuft/h	130					
	Cuft/d	27					
	bb/s	132					
	bb/min	133					
	bb/h	134					
	bb/d	135					
	Impgal/s	137					
	Impgal/min	18					
	Impgal/h	30					
	Impgal/d	31					
	l(N)/s	176					
	l(N)/min	175					
	l(N)/h	122					
	l(N)/d	222					
	m ³ (N)/s	183					
	m ³ (N)/min	182					
	m ³ (N)/h	121					
	m ³ (N)/d	181					
	Sl/s	180					
	Sl/min	179					
	Sl/h	178					
	Sl/d	177					
	Scuft/s	186					
Scuft/min	123						
Scuft/h	248						
Scuft/d	184						
Sm ³ /s	190						
Sm ³ /min	189						
Sm ³ /h	188						
Sm ³ /d	187						

Parameter	Data range	Selection	Unit	Register	Read Write	Address	
					R, W	Holding register	Input register
Vol flow LRV	-Qvmax to Qvmax	-	Vol flow unit	FL32	R/W	1264	-
Vol flow URV	-Qvmax to Qvmax	-	Vol flow unit	FL32	R/W	1280	-
Vol flow damping	0 to 200	-	Sec.	FL32	R/W	1296	-
Vol flow lowcut	0 to Qvmax	-	Vol flow unit	FL32	R/W	1312	-
Vol flow alm 1 sel	No function	0	-	US16	R/W	1328	-
	More than	1					
	Less than	2					
Vol flow alm 1 crit	-110% to 110%	-	Vol flow unit	FL32	R/W	1344	-
	of URV						
Vol flow alm 2 sel	No function	0	-	US16	R/W	1360	-
	More than	1					
	Less than	2					
Vol flow alm 2 crit	-110% to 110%	-	Vol flow unit	FL32	R/W	1376	-
	of URV						
Density unit	g/ml	95	-	US16	R/W	1392	47
	kg/l	96					
	kg/m ³	92					
	lb/gal	93					
	lb/Cuft	94					
	g/cm ³	91					
	g/l	97					
	°Bé hv	102					
	°Bé lt	103					
°API	104						
Density LRV	0 to 5 kg/l	-	Density unit	FL32	R/W	1408	-
Density URV	0 to 5 kg/l	-	Density unit	FL32	R/W	1424	-
Density damping	0 to 200	-	Sec.	FL32	R/W	1440	-
Density lowcut	0 to 5 kg/l	-	Density unit	FL32	R/W	1456	-
Density alm 1 sel	No function	0	-	US16	R/W	1472	-
	More than	1					
	Less than	2					
Density alm 1 crit	0 to Density URV	-	Density unit	FL32	R/W	1488	-
Density alm 2 sel	No function	0	-	US16	R/W	1504	-
	More than	1					
	Less than	2					
Density alm 2 crit	0 to Density URV	-	Density unit	FL32	R/W	1520	-
Ref. density sel	Inhibit	0	-	US16	R/W	1536	-
	Fixed	1					
	Calculated	2					
Reference density	0 to 5 kg/l	-	Density unit	FL32	R/W	1552	-
Density offset	-9999.99 to +9999.99	-	g/l	FL32	R/W	1568	-
Pressure	0 to 400 bar	-	Pressure Unit	FL32	R/W	1584	-
Pressure unit	bar	7	-	US16	R/W	1600	-
	psi	6					
	MPa	237					

Parameter	Data range	Selection	Unit	Register	Read Write		Address	
					R, W	Holding register	Input register	
Temperature unit	degC	32	-	US16	R/W	1616	48	
	degF	33						
	K	35						
Temperature LRV	Std: -200 to 230°C	-	Temperature unit	FL32	R/W	1632	-	
	High.T: 0 to 400°C							
Temperature URV	Std: -200 to 230°C	-	Temperature unit	FL32	R/W	1648	-	
	High.T: 0 to 400°C							
Temperature damping	0 to 200	-	Sec.	FL32	R/W	1664	-	
Temp alm 1 sel	No function	0	-	US16	R/W	1680	-	
	More than	1						
	Less than	2						
Temp alm 1 crit	Std: -200 to 230°C	-	Temperature unit	FL32	R/W	1696	-	
	High.T: 0 to 400°C							
Temp alm 2 sel	No function	0	-	US16	R/W	1712	-	
	More than	1						
	Less than	2						
Temp alm 2 crit	Std: -200 to 230°C	-	Temperature unit	FL32	R/W	1728	-	
	High.T: 0 to 400°C							
Temp fix val select	Inhibit	0	-	US16	R/W	1744	-	
	Enable	1						
Temp fixed val	Std: -200 to 230°C	-	Temperature unit	FL32	R/W	1760	-	
	High.T: 0 to 400°C							
Temp gain	0.8 to 1.2	-	-	FL32	R/W	1776	-	
Velocity unit	m/s	21	-	US16	R/W	1792	49	
	ft/s	20						
Total flex select	Mass	0	-	US16	R/W	1808	-	
	Volume	1						
	Net	2						
Total flex unit	g	60	-	US16	R/W	1824	50	
	kg	61						
	t	62						
	lb	63						
	cm ³	245						
	l	41						
	m ³	43						
	gal	40						
	kgal	243						
	Cuft	112						
	bbl	46						
	Impgal	42						
	klmpgal	244						
	l(N)	167						
	m ³ (N)	166						
	SI	171						
	Scuft	168						
MMscuft	249							
Sm ³	172							

Parameter	Data range	Selection	Unit	Register	Read Write	Address	
					R, W	Holding register	Input register
Total mass unit	g	60	-	US16	R/W	1840	51
	kg	61					
	t	62					
	lb	63					
Total volume unit	cm ³	245	-	US16	R/W	1856	52
	l	41					
	m ³	43					
	gal	40					
	kgal	243					
	Cuft	112					
	bbl	46					
	Impgal	42					
	klmpgal	244					
	l(N)	167					
	m ³ (N)	166					
	Sl	171					
	Scuft	168					
	MMscuft	249					
Sm ³	172						
Total net unit	g	60	-	US16	R/W	1872	53
	kg	61					
	t	62					
	lb	63					
	cm ³	245					
	l	41					
	m ³	43					
	gal	40					
	kgal	243					
	Cuft	112					
	bbl	46					
	Impgal	42					
	klmpgal	244					
	Total switch select	Flex					
Mass		1					
Volume		2					
Net		3					
Total limit switch	0 to 9999999	-	Total unit	FL32	R/W	1904	-
Total unit energy	MJ	164	-	US16	R/W	1920	54
	Btu	165					
Total at alarm	Hold	0	-	US16	R/W	1936	-
	Continue	1					
Energy factor/heat of combustion	0 to 100000	-	heat of combustion unit	FL32	R/W	1952	-
Energy factor/ heat of combustion unit	MJ/kg	210	-	US16	R/W	1968	-
	Btu/lb	211					
	MJ/m ³ (N)	212					
	Btu/Scuft	213					

Parameter	Data range	Selection	Unit	Register	Read Write	Address	
					R, W	Holding register	Input register
Device ID	-	-	-	US16	R	1984	-
Modbus option	/MB2	2	-	US16	R/W	2000	-
	/MB3	3					
SK20	-	-	MHz×kg/h	FL32	R/W	2016	-
SKT	-	-	E-4×1/K	FL32	R/W	2032	-
SKTK	-	-	E-7×1/K ²	FL32	R/W	2048	-
RV	-	-	%(kg/l)	FL32	R/W	2064	-
Qnom	-	-	Mass flow unit	FL32	R	2080	-
KD	-	-	E-4×1/bar	FL32	R/W	2096	-
fl20	-	-	E-7×1/(bar×K)	FL32	R/W	2112	-
FTC1	-	-	kg/l	FL32	R/W	2128	-
FTCK	-	-	Hz	FL32	R/W	2144	-
SKP	-	-	E-4×1/K	FL32	R/W	2160	-
SKPT	-	-	E-7×1/K ²	FL32	R/W	2176	-
FPC	-	-	E-4×1/bar	FL32	R/W	2192	-
FPTC	-	-	E-7×1/(bar×K)	FL32	R/W	2208	-
FQC1	-	-	E-10×s/g	FL32	R/W	2224	-
FQC2	-	-	E-13×(s/g) ²	FL32	R/W	2240	-
Modbus init	Not execute	0	-	US16	R/W	2056	-
	Execute	1					
Reference temperature	-	-	Temperature unit	FL32	R/W	2272	-
Ref. density carrier	-	-	Density unit	FL32	R/W	2288	-
Temp. coeff. a carrier	-	-	E-3×(1/Temp unit)	FL32	R/W	2304	-
Temp. coeff. b carrier	-	-	E-5×(1/Temp unit ²)	FL32	R/W	2320	-
Ref. density product	-	-	Density unit	FL32	R/W	2336	-
Temp. coeff. a product	-	-	E-3×(1/Temp unit)	FL32	R/W	2352	-
Temp. coeff. b product	-	-	E-5×(1/Temp unit ²)	FL32	R/W	2368	-
Concentration meas unit	°Brix	101	-	US16	R/W (/CST) R/(C□□)	2384	55
	Wt -% sol	105					
	Vol % sol	106					
	Wt -%	247					
	Vol %	149					
Conc meas LRV	0 to 110	-	Conc meas unit	FL32	R/W	2400	-
Conc meas URV	0 to 110	-	Conc meas unit	FL32	R/W	2416	-
Conc meas damp	0 to 200	-	Sec	FL32	R/W	2432	-
Conc meas lowcut	0 to 10%	-	Conc meas unit	FL32	R/W	2448	-
Conc meas alm 1 sel	No function	0	-	US16	R/W	2464	-
	More than	1					
	Less than	2					
Conc meas alm 1 crit	0 to 110% of URV	-	Conc meas unit	FL32	R/W	2480	-
Conc meas alm 2 sel	No function	0	-	US16	R/W	2496	-
	More than	1					
	Less than	2					

Parameter	Data range	Selection	Unit	Register	Read Write	Address	
					R, W	Holding register	Input register
Conc meas alm 2 crit	0 to 110% of URV	-	Conc meas unit	FL32	R/W	2512	-
Net flow select	Mass	0	-	US16	R/W	2528	-
	Volume	1					
Net flow unit	g/s	70	-	US16	R/W	2544	56
	g/min	71					
	g/h	72					
	kg/s	73					
	kg/min	74					
	kg/h	75					
	kg/d	76					
	t/min	77					
	t/h	78					
	t/d	79					
	lb/s	80					
	lb/min	81					
	lb/h	82					
	lb/d	83					
	cm ³ /s	240					
	cm ³ /min	241					
	cm ³ /h	242					
	l/s	24					
	l/min	17					
	l/h	138					
	l/d	221					
	m ³ /s	28					
	m ³ /min	131					
	m ³ /h	19					
	m ³ /d	29					
	gal/s	22					
	gal/min	16					
	gal/h	136					
	gal/d	235					
	Cuft/s	26					
	Cuft/min	15					
Cuft/h	130						
Cuft/d	27						
bb/s	132						
bb/min	133						
bb/h	134						
bb/d	135						
Impgal/s	137						
Impgal/min	18						
Impgal/h	30						
Impgal/d	31						
Net flow LRV	-Qmax to Qmax	-	Net flow unit	FL32	R/W	2560	-
Net flow URV	-Qmax to Qmax	-	Net flow unit	FL32	R/W	2576	-
Net flow damping	0 to 200	-	Sec	FL32	R/W	2592	-

Parameter	Data range	Selection	Unit	Register	Read Write	Address	
					R, W	Holding register	Input register
Net flow lowcut	0 to Qmax	-	Net flow unit	FL32	R/W	2608	-
Net flow alm 1 sel	No function	0	-	US16	R/W	2624	-
	More than	1					
	Less than	2					
Net flow alm 1 crit	-110% to 110%	-	Net flow unit	FL32	R/W	2640	-
	of URV						
Net flow alm 2 sel	No function	0	-	US16	R/W	2456	-
	More than	1					
	Less than	2					
Net flow alm 2 crit	-110% to 110%	-	Net flow unit	FL32	R/W	2672	-
	of URV						
Slug alarm select	Not apply	0	-	US16	R/W	2688	-
	Apply	1					
Slug criteria	0 to 13.3	-	V	FL32	R/W	2704	-
Slug duration	0 to 120	-	Sec	US16	R/W	2720	-
After slug	Measured value	0	-	US16	R/W	2736	-
	Hold	1					
Drive gain damping	0 to 200	-	Sec	FL32	R/W	2752	-
Empty pipe alm sel	Not apply	0	-	US16	R/W	2768	-
	Apply	1					
Empty pipe crit	0 to 5 kg/l	-	Density unit	FL32	R/W	2784	-
After empty pipe	Massflow=Zero	0	-	US16	R/W	2800	-
	Measured value	1					
	Hold	2					
Sensor model	RCCS30	0	-	US16	R/W	2816	-
	RCCS31	1					
	RCCS32	2					
	RCCS33	3					
	RCCS34	4					
	RCCS36	5					
	RCCS38	6					
	RCCS39	7					
	RCCS39/IR	8					
	RCCS39/XR	9					
RCCS30/LR	10						
Corrosion alm sel	Not apply	0	-	US16	R/W	2832	-
	Apply	1					
Corrosion criteria	0 to Density URV	-	Density unit	FL32	R/W	2848	-
Corrosion damp	0 to 10	-	Hour	FL32	R/W	2864	-
Master reset	Not execute	0	-	US16	R/W	2880	-
	Execute	1					
Write protect	No	0	-	US16	R/W	2896	-
	Yes	1					
Key status	Inhibit	0	-	US16	R/W	2912	-
	Enable	1					
Fluid max temp	-	-	Temp. unit	FL32	R	2944	-
Actual density	-	-	Density unit	FL32	R	2960	40

Parameter	Data range	Selection	Unit	Register	Read Write	Address	
					R, W	Holding register	Input register
Mass Flow in "g/s"	-	-	g/s	FL32	R	2976	57
Vol Flow in "cm ³ /s"	-	-	cm ³ /s	FL32	R	2992	59
Density in "g/cm ³ "	-	-	g/cm ³	FL32	R	3008	61
Temperature in "°C"	-	-	°C	FL32	R	3024	63
F-Total mass in "g"	-	-	g	FL32	R	3040	65
R-Total mass in "g"	-	-	g	FL32	R	3056	67
D-Total mass in "g"	-	-	g	FL32	R	3072	69
F-Total vol in "cm ³ "	-	-	cm ³	FL32	R	3088	71
R-Total vol in "cm ³ "	-	-	cm ³	FL32	R	3104	73
D-Total vol in "cm ³ "	-	-	cm ³	FL32	R	3120	75
S1 Amplitude	-	-	%	FL32	R	3136	77
S2 Amplitude	-	-	%	FL32	R	3152	79
Drive gain	-	-	V	FL32	R	3168	81
Frequency	-	-	Hz	FL32	R	3184	83
Phase difference	-	-	mrاد	FL32	R	3200	85
History ordered	-	-	-	US16	R	3216	-
Clear history ordered	Not execute	0	-	US16	R/W	3232	-
	Execute	1					
Hist overview error	-	-	-	US16	R	3248	-
Hist overv. alarm	-	-	-	US16	R	3249	-
Hist overv. warning	-	-	-	US16	R	3250	-
Hist abs error group1/2	Group1: High byte Group2: Low byte	-	-	US16	R	3264	-
Hist abs alarm group1/2	Group1: High byte Group2: Low byte	-	-	US16	R	3265	-
Hist abs warning group1/2	Group1: High byte Group2: Low byte	-	-	US16	R	3266	-
History abs entry 1-4	(see chapter 8.7.3)	-	-	US16	R	3280	-
History abs entry 5-8	(see chapter 8.7.3)	-	-	US16	R	3296	-
History abs entry 9-10	(see chapter 8.7.3)	-	-	US16	R	3312	-
Clear history absolute	mm/dd/yyyy	-	-	US16	W	3360	-
Tag	PACKED ASCII, 8 chars, *)	-	-	String	R/W	3376	-
	ASCII (22)						
Long tag	ASCII (22)	-	-	String	R/W	3392	-
Distributor	-	-	-	String	R	3408	-
Descriptor	PACKED ASCII, 16 chars, *)	-	-	String	R/W	3424	-
	PACKED ASCII, 32 chars, *)						
Message	PACKED ASCII, 32 chars, *)	-	-	String	R/W	3440	-
Date	mm/dd/yyyy	-	-	US16	R/W	3456	-
Sensor S/N	-	-	-	US32	R	3472	-
Assembly number	-	-	-	US32	R	3488	-
Serial no. converter	-	-	-	String	R	3504	-
Serial no. detector	-	-	-	String	R	3512	-
Software rev	-	-	-	US16	R	3520	-
Hardware rev	-	-	-	US16	R	3521	-
Device S/W version	-	-	-	String	R	3536	-

Parameter	Data range	Selection	Unit	Register	Read Write	Address	
					R, W	Holding register	Input register
Device S/W date	-	-	-	US16	R	3552	-
MS code line 1	-	-	-	String	R	3568	-
MS code line 2	-	-	-	String	R	3584	-
MS code line 3	-	-	-	String	R	3600	-
Disp select 1	Mass flow	0	-	US16	R/W	3616	-
	Volume flow	1					
	Density	2					
	Temperature	3					
	Concentration	4					
	Net flow	5					
	F-Total flex	6					
	R-Total flex	7					
	D-Total flex	8					
	F-Total mass	9					
	R-Total mass	10					
	D-Total mass	11					
	F-Total volume	12					
	R-Total volume	13					
	D-Total volume	14					
	F-Total net	15					
	R-Total net	16					
	D-Total net	17					
	F-Total energy	18					
	Velocity	19					
Drive gain	20						
Disp select 2	Mass flow	0	-	US16	R/W	3632	-
	Volume flow	1					
	Density	2					
	Temperature	3					
	Concentration	4					
	Net flow	5					
	F-Total flex	6					
	R-Total flex	7					
	D-Total flex	8					
	F-Total mass	9					
	R-Total mass	10					
	D-Total mass	11					
	F-Total volume	12					
	R-Total volume	13					
	D-Total volume	14					
	F-Total net	15					
	R-Total net	16					
	D-Total net	17					
	F-Total energy	18					
	Velocity	19					
	Drive gain	20					
None	21						

Parameter	Data range	Selection	Unit	Register	Read Write	Address	
					R, W	Holding register	Input register
Disp select 3	Mass flow	0	-	US16	R/W	3648	-
	Volume flow	1					
	Density	2					
	Temperature	3					
	Concentration	4					
	Net flow	5					
	F-Total flex	6					
	R-Total flex	7					
	D-Total flex	8					
	F-Total mass	9					
	R-Total mass	10					
	D-Total mass	11					
	F-Total volume	12					
	R-Total volume	13					
	D-Total volume	14					
	F-Total net	15					
	R-Total net	16					
	D-Total net	17					
	F-Total energy	18					
	Velocity	19					
	Drive gain	20					
None	21						
Disp select 4	Mass flow	0	-	US16	R/W	3664	-
	Volume flow	1					
	Density	2					
	Temperature	3					
	Concentration	4					
	Net flow	5					
	F-Total flex	6					
	R-Total flex	7					
	D-Total flex	8					
	F-Total mass	9					
	R-Total mass	10					
	D-Total mass	11					
	F-Total volume	12					
	R-Total volume	13					
	D-Total volume	14					
	F-Total net	15					
	R-Total net	16					
	D-Total net	17					
	F-Total energy	18					
	Velocity	19					
	Drive gain	20					
None	21						

Parameter	Data range	Selection	Unit	Register	Read Write	Address	
					R, W	Holding register	Input register
Disp contrast	-5	0	-	US16	R/W	3680	-
	-4	1					
	-3	2					
	-2	3					
	-1	4					
	0	5					
	1	6					
	2	7					
	3	8					
	4	9					
5	10						
Disp period	0.5 s	0	-	US16	R/W	3696	-
	1.0 s	1					
	2.0 s	2					
Mass flow format	xxxxxxx	0	-	US16	R/W	3712	-
	xxxxx.X	1					
	xxxx.XX	2					
	xxx.XXX	3					
	xx.XXXX	4					
	x.XXXXX	5					
Vol flow format	xxxxxxx	0	-	US16	R/W	3728	-
	xxxxx.X	1					
	xxxx.XX	2					
	xxx.XXX	3					
	xx.XXXX	4					
	x.XXXXX	5					
Density format	xxxxxxx	0	-	US16	R/W	3744	-
	xxxxx.X	1					
	xxxx.XX	2					
	xxx.XXX	3					
	xx.XXXX	4					
	x.XXXXX	5					
Temperature format	xxxxxxx	0	-	US16	R/W	3760	-
	xxxxx.X	1					
	xxxx.XX	2					
	xxx.XXX	3					
	xx.XXXX	4					
	x.XXXXX	5					
Conc meas format	xxxxxxx	0	-	US16	R/W	3776	-
	xxxxx.X	1					
	xxxx.XX	2					
	xxx.XXX	3					
	xx.XXXX	4					
	x.XXXXX	5					

Parameter	Data range	Selection	Unit	Register	Read Write	Address	
					R, W	Holding register	Input register
Net flow format	xxxxxxx	0	-	US16	R/W	3792	-
	xxxxx.X	1					
	xxxx.XX	2					
	xxx.XXX	3					
	xx.XXXX	4					
	x.XXXXX	5					
Test LCD	Not execute	0	-	US16	W	3808	-
	Execute	1					
Test keys	Not execute	0	-	US16	W	3824	-
	Execute	1					
Enable WRT 10 min	PACKED ASCII, 8	-	-	String	W	3840	-
	chars, *)						
New password	PACKED ASCII, 8	-	-	String	W	3856	-
	chars, *)						
Software seal	Break	0	-	US16	W	3872	-
	Keep	1					
AZ active value	-	-	Mass flow unit	FL32	R	3888	-
AZ active density	-	-	Density unit	FL32	R	3890	-
AZ active temperat.	-	-	Temp. unit	FL32	R	3892	-
AZ initialize value	-	-	Mass flow unit	FL32	R	3904	-
AZ initialize density	-	-	Density unit	FL32	R	3906	-
AZ initialize temperat	-	-	Temp. unit	FL32	R	3908	-
AZ initialize date	mm/dd/yyyy	-	-	US16	R	3910	-
AZ history entry 1-2	(see chapter 8.7.4)	-	-	US16	R	3920	-
AZ history entry 3-4	(see chapter 8.7.4)	-	-	US16	R	3936	-
AZ history entry 5	(see chapter 8.7.4)	-	-	US16	R	3952	-

7.7 Modbus Holding Register Settings for Outputs (only /MB3)

Parameter	Data range	Selection	Unit	Register	Read Write	Address	
					R, W	Holding register	Input register
Universal rev	-	-	-	US16	R	4000	-
Fld. dev rev.	-	-	-	US16	R	4001	-
Poll address	0 to 15	-	-	US16	R/W	4016	-
Num req pream	-	-	-	US16	R	4032	-
Num resp pream	5 to 20	-	-	US16	R/W	4048	-
Analog output 1 Unit	-	-	-	US16	R	4064	91
Analog output 1	-	-	AO unit	FL32	R	4080	92
Analog output 1%	-	-	%	FL32	R	4096	94
Analog output 1 mA	-	-	mA	FL32	R	4112	96
Pulse output 1	-	-	Hz	FL32	R	4128	-
Status output 1	SO 1 active mode	-	-	US16	R	4144	-
Pulse output 2	-	-	Hz	FL32	R	4160	-
Status output 2	SO 2 active mode	-	-	US16	R	4176	-
View input	SI function	-	-	US16	R	4192	-
Analog output 1 (Test)	2.0 to 22.0	-	mA	FL32	R/W	4208	-
Pulse output 1 (Test)	1 to 10000	-	Hz	FL32	W	4224	-
	"0" stop test						
Status output 1 (Test)	On active	0	-	US16	W	4240	-
	Off active	1					
	End test	2					
Pulse output 2 (Test)	1 to 10000	-	Hz	FL32	W	4256	-
	"0" stop test						
Status output 2 (Test)	On active	0	-	US16	W	4272	-
	Off active	1					
	End test	2					
Status input (Test)	Open	0	-	US16	R	4288	-
	Short	1					
Analog 1 select	Mass flow	0	-	US16	R/W	4304	-
	Volume flow	1					
	Density	2					
	Temperature	3					
	Concentr meas	4					
	Net flow	5					
	None	6					
Analog 1 alarm out	<2.4mA	0	-	US16	R/W	4320	-
	<3.6mA	1					
	4.0mA	2					
	>21mA	3					
	>21.6mA	4					
	Hold	5					
	Measured value	6					
Analog 1 low LMT	NAMUR:	-	mA	FL32	R/W	4336	-
	3.8 to 20.5 mA						
	Not NAMUR:						
	2.4 to 21.6 mA						

Parameter	Data range	Selection	Unit	Register	Read Write	Address	
					R, W	Holding register	Input register
Analog 1 high LMT	NAMUR:3.8 to 20.5 mA	-	mA	FL32	R/W	4352	-
	Not NAMUR:2.4 to 21.6 mA						
Pulse/Stat 1 select	Pulse	0	-	US16	R/W	4368	-
	Status out	1					
	No function	2					
Pulse 1 select	Mass flow	0	-	US16	R/W	4384	-
	Volume flow	1					
	Density	2					
	Temperature	3					
	Concentration meas	4					
	Net flow	5					
	None	6					
	F-Total mass	7					
	R-Total mass	8					
	F-Total volume	9					
	R-Total volume	10					
	F-Total net	11					
R-Total net	12						
Pulse 1 unit	Hz	38	-	US16	R/W	4400	-
	g/P	191					
	kg/P	192					
	t/P	193					
	lb/P	194					
	cm ³ /P	195					
	l/P	196					
	m ³ /P	197					
	gal/P	198					
	kgal/P	199					
	Cuft/P	200					
	bbl/P	201					
	Impgal/P	202					
	klmpgal/P	203					
	l(N)/P	204					
	m ³ (N)/P	205					
	Sl/P	206					
Scuft/P	207						
Sm ³ /P	208						
Pulse 1 rate	0 to 10000	-	Pulse 1 unit	FL32	R/W	4416	-
Pulse 1 active mode	On active	0	-	US16	R/W	4432	-
	Off active	1					

Parameter	Data range	Selection	Unit	Register	Read Write	Address	
					R, W	Holding register	Input register
Pulse 1 width	0.05ms	0	-	US16	R/W	4448	-
	0.1ms	1					
	0.5ms	2					
	1ms	3					
	5ms	4					
	10ms	5					
	50ms	6					
	100ms	7					
	500ms	8					
	1000ms	9					
Pulse 1 at alarm	0P/0Hz	0	-	US16	R/W	4464	-
	Measured value	1					
	Hold	2					
SO 1 function	No function	0	-	US16	R/W	4480	-
	Flow direction	1					
	Total switch	2					
	Mass flow alm 1	3					
	Mass flow alm 2	4					
	Mass flow alm 1+2	5					
	Vol flow alm 1	6					
	Vol flow alm 2	7					
	Vol flow alm 1+2	8					
	Density alm 1	9					
	Density alm 2	10					
	Density alm 1+2	11					
	Temp alm 1	12					
	Temp alm 2	13					
	Temp alm 1+2	14					
	Conc. meas alm 1	15					
	Conc. meas alm 2	16					
	Conc. meas alm1+2	17					
	Net flow alm 1	18					
	Net flow alm 2	19					
	Net flow alm 1+2	20					
	Slug alarm	21					
	Empty alarm	22					
	Corrosion alarm	23					
	All alarms	24					
	All errors	25					
All alarms & errors	26						
SO 1 active mode	On active	0	-	US16	R/W	4496	-
	Off active	1					
Pulse/Stat 2 select	Pulse	0	-	US16	R/W	4512	-
	Status out	1					
	No function	2					

Parameter	Data range	Selection	Unit	Register	Read Write	Address	
					R, W	Holding register	Input register
Pulse 2 select	Mass flow	0	-	US16	R/W	4528	-
	Volume flow	1					
	Density	2					
	Temperature	3					
	Concentration meas	4					
	Net flow	5					
	None	6					
	F-Total mass	7					
	R-Total mass	8					
	F-Total volume	9					
	R-Total volume	10					
	F-Total net	11					
R-Total net	12						
Pulse 2 unit	Hz	38	-	US16	R/W	4544	-
	g/P	191					
	kg/P	192					
	t/P	193					
	lb/P	194					
	cm ³ /P	195					
	l/P	196					
	m ³ /P	197					
	gal/P	198					
	kgal/P	199					
	Cuft/P	200					
	bb/P	201					
	Impgal/P	202					
	klmpgal/P	203					
	l(N)/P	204					
	m ³ (N)/P	205					
	Sl/P	206					
Scuft/P	207						
Sm ³ /P	208						
Pulse 2 rate	0 to 10000	-	Pulse 1 unit	FL32	R/W	4560	-
Pulse 2 active mode	On active	0	-	US16	R/W	4576	-
	Off active	1					
Pulse 2 width	0.05ms	0	-	US16	R/W	4592	-
	0.1ms	1					
	0.5ms	2					
	1ms	3					
	5ms	4					
	10ms	5					
	50ms	6					
	100ms	7					
	500ms	8					
1000ms	9						

Parameter	Data range	Selection	Unit	Register	Read Write	Address	
					R, W	Holding register	Input register
Pulse 2 at alarm	0P/0Hz	0	-	US16	R/W	4608	-
	Measured value	1					
	Hold	2					
SO 2 function	No function	0	-	US16	R/W	4624	-
	Flow direction	1					
	Total switch	2					
	Mass flow alm 1	3					
	Mass flow alm 2	4					
	Mass flow alm 1+2	5					
	Vol flow alm 1	6					
	Vol flow alm 2	7					
	Vol flow alm 1+2	8					
	Density alm 1	9					
	Density alm 2	10					
	Density alm 1+2	11					
	Temp alm 1	12					
	Temp alm 2	13					
	Temp alm 1+2	14					
	Conc. meas alm 1	15					
	Conc. meas alm 2	16					
	Conc. meas alm1+2	17					
	Net flow alm 1	18					
	Net flow alm 2	19					
Net flow alm 1+2	20						
Slug alarm	21						
Empty alarm	22						
Corrosion alarm	23						
All alarms	24						
All errors	25						
All alarms & errors	26						
SO 2 active mode	On active	0	-	US16	R/W	4640	-
	Off active	1					
PV is	Mass flow	0	-	US16	R/W	4656	-
	Volume flow	1					
	Density	2					
	Temperature	3					
	Concentr meas	4					
	Net flow	5					
	None	6					

Parameter	Data range	Selection	Unit	Register	Read Write	Address	
					R, W	Holding register	Input register
SV is	Mass flow	0	-	US16	R/W	4672	-
	Volume flow	1					
	Density	2					
	Temperature	3					
	Concentration	4					
	Net flow	5					
	None	6					
	F-Total mass	7					
	R-Total mass	8					
	F-Total volume	9					
	R-Total volume	10					
	F-Total net	11					
	R-Total net	12					
	F-Total flex	13					
	R-Total flex	14					
	D-Total mass	15					
	D-Total volume	16					
	D-Total net	17					
	D-Total flex	18					
	F-Total energy	19					
	Velocity	20					
Drive gain	21						
TV is	Mass flow	0	-	US16	R/W	4688	-
	Volume flow	1					
	Density	2					
	Temperature	3					
	Concentration	4					
	Net flow	5					
	None	6					
	F-Total mass	7					
	R-Total mass	8					
	F-Total volume	9					
	R-Total volume	10					
	F-Total net	11					
	R-Total net	12					
	F-Total flex	13					
	R-Total flex	14					
	D-Total mass	15					
	D-Total volume	16					
	D-Total net	17					
	D-Total flex	18					
	F-Total energy	19					
	Velocity	20					
Drive gain	21						

Parameter	Data range	Selection	Unit	Register	Read Write	Address	
					R, W	Holding register	Input register
QV is	Mass flow	0	-	US16	R/W	4704	-
	Volume flow	1					
	Density	2					
	Temperature	3					
	Concentration	4					
	Net flow	5					
	None	6					
	F-Total mass	7					
	R-Total mass	8					
	F-Total volume	9					
	R-Total volume	10					
	F-Total net	11					
	R-Total net	12					
	F-Total flex	13					
	R-Total flex	14					
	D-Total mass	15					
	D-Total volume	16					
	D-Total net	17					
	D-Total flex	18					
	F-Total energy	19					
	Velocity	20					
Drive gain	21						
SI function	No function	0	-	US16	R/W	4720	-
	Autozero	1					
	Reset flex totals	2					
	Reset mass totals	3					
	Reset volume totals	4					
	Reset net totals	5					
	Reset all totals	6					
	0% Signal lock	7					
SI active mode	On active	0	-	US16	R/W	4736	-
	Off active	1					
Output trim AO1 4mA	2.0 to 6.0	-	mA	FL32	R/W	4752	-
Output trim AO1 20mA	18.0 to 22.0	-	mA	FL32	R/W	4768	-
Measuring range	NAMUR	0	-	US16	R	4784	-
	Not NAMUR	1					

7.8 Modbus Flexible Register

This section describes the functionality of the flexible register and their configuration.
The 3 Series Modbus communication type offers

- 20 flexible “Input registers” for fast Modbus reading, up to 10 “FL32 values” or 10 “US16 values” can be assigned for reading
- 20 flexible “Holding registers” for fast Modbus writing, up to 10 “FL32 values” or 10 “US16 values” can be assigned for writing
- 4 predefined “Holding registers” for fast Modbus writing, 4 predefined functions can be executed with fast access
- Transmission time for fast reading, writing and executing: see chapter 8.8

Table 7.8.1 Flexible Input Register Selection

Parameter	Data Value	Selection	Unit	Register	Read Write	Address	
					R, W	Holding register	Input register
Flex input register select 01	0	Holding reg	-	US16	R/W	6912	-
Flex input register select 02	0	Holding reg	-	US16	R/W	6928	-
Flex input register select 03	0	Holding reg	-	US16	R/W	6944	-
Flex input register select 04	0	Holding reg	-	US16	R/W	6960	-
Flex input register select 05	0	Holding reg	-	US16	R/W	6976	-
Flex input register select 06	0	Holding reg	-	US16	R/W	6992	-
Flex input register select 07	0	Holding reg	-	US16	R/W	7008	-
Flex input register select 08	0	Holding reg	-	US16	R/W	7024	-
Flex input register select 09	0	Holding reg	-	US16	R/W	7040	-
Flex input register select 10	0	Holding reg	-	US16	R/W	7056	-

Up to 10 holding registers can be mapped to the fast reading area by writing a “Holding Register Address” to the “Flex input register select □□”. After configuring of the “Flex input register select □□” the Modbus communication has to be initialized by “Modbus Init”.

After “Modbus Init” the “Holding Register” can be read with fast access.

The configuration of the “Flex input register select □□” will be reset to 0 after performing “Master Reset”.

All “Holding Register” in the range 512 to 4992 can be mapped to the flex input register except the “Modbus Specific Register” in chapter 7.4.

Table 7.8.2 Flexible Holding Register Selection

Parameter	Data Value	Selection	Unit	Register	Read Write	Address	
					R, W	Holding register	Input register
Flex holding reg. select 01	0	Holding reg	-	US16	R/W	7072	-
Flex holding reg. select 02	0	Holding reg	-	US16	R/W	7088	-
Flex holding reg. select 03	0	Holding reg	-	US16	R/W	7104	-
Flex holding reg. select 04	0	Holding reg	-	US16	R/W	7120	-
Flex holding reg. select 05	0	Holding reg	-	US16	R/W	7136	-
Flex holding reg. select 06	0	Holding reg	-	US16	R/W	7152	-
Flex holding reg. select 07	0	Holding reg	-	US16	R/W	7168	-
Flex holding reg. select 08	0	Holding reg	-	US16	R/W	7184	-
Flex holding reg. select 09	0	Holding reg	-	US16	R/W	7200	-
Flex holding reg. select 10	0	Holding reg	-	US16	R/W	7216	-

Up to 10 holding registers can be mapped to the fast writing area by writing a “Holding Register Address” to the “Flex holding register select □□”. After configuring of the “Flex holding register select □□” the Modbus communication has to be initialized by “Modbus Init”.

After “Modbus Init” the “Holding Register” can be written with fast access. The configuration of the “Flex holding register select □□” will be reset to 0 after performing “Master Reset”.

When writing to a “Fast Holding Register” the new value will be stored and the Modbus response will not wait for the action. The appropriate action is performed after the communication when the new written value is different to the old one in the register.

All “Holding Register” in the range 512 to 4992 can be mapped to the flex holding register except the “Modbus Specific Register” in chapter 7.4.

The following 4 holding register are mapped fix to the fast writing area. To initiate an action a valid value has to be written. To inhibit the functionality and prepare it for the next action a subsequent “0” has to be sent. Writing the same value as before does not cause an action.

Table 7.8.3 Modbus predefined Holding Register

Parameter (holding register)	Option /MB1	Option /MB2	Option /MB3	Flex input	Flex holding	Data format	16 bit Register	Read Write	Address			
								R, W	Holding register	Modicon	Input register	Modicon
										4x		3x
Total reset (fast access)	-	x	x	-	-	US16	1	W	0	40001	-	-
Autozero exe (fast access)	-	x	x	-	-	US16	1	W	1	40002	-	-
Modbus init (fast access)	-	x	x	-	-	US16	1	W	2	40003	-	-
Master reset (fast access)	-	x	x	-	-	US16	1	W	3	40004	-	-

7.8.1 Register of “Fast reading/writing area”

Parameter (holding register)	Option /MB1	Option /MB2	Option /MB3	Flex input	Flex holding	Data format	16 bit Register	Read Write	Address			
									Holding register	Modicon	Input register	Modicon
									R, W	4x		3x
Flex input register 01	-	x	x	-	-	US16	1	R	-	-	98	30099
Flex input register 02	-	x	x	-	-	US16	1	R	-	-	99	30100
Flex input register 03	-	x	x	-	-	US16	1	R	-	-	100	30101
Flex input register 04	-	x	x	-	-	US16	1	R	-	-	101	30102
Flex input register 05	-	x	x	-	-	US16	1	R	-	-	102	30103
Flex input register 06	-	x	x	-	-	US16	1	R	-	-	103	30104
Flex input register 07	-	x	x	-	-	US16	1	R	-	-	104	30105
Flex input register 08	-	x	x	-	-	US16	1	R	-	-	105	30106
Flex input register 09	-	x	x	-	-	US16	1	R	-	-	106	30107
Flex input register 10	-	x	x	-	-	US16	1	R	-	-	107	30108
Flex input register 11	-	x	x	-	-	US16	1	R	-	-	108	30109
Flex input register 12	-	x	x	-	-	US16	1	R	-	-	109	30110
Flex input register 13	-	x	x	-	-	US16	1	R	-	-	110	30111
Flex input register 14	-	x	x	-	-	US16	1	R	-	-	111	30112
Flex input register 15	-	x	x	-	-	US16	1	R	-	-	112	30113
Flex input register 16	-	x	x	-	-	US16	1	R	-	-	113	30114
Flex input register 17	-	x	x	-	-	US16	1	R	-	-	114	30115
Flex input register 18	-	x	x	-	-	US16	1	R	-	-	115	30116
Flex input register 19	-	x	x	-	-	US16	1	R	-	-	116	30117
Flex input register 20	-	x	x	-	-	US16	1	R	-	-	117	30118
Totalizer reset (fast access)	-	x	x	-	-	US16	1	R/W	0	40001	-	-
Autozero exe (fast access)	-	x	x	-	-	US16	1	W	1	40002	-	-
Modbus init (fast access)	-	x	x	-	-	US16	1	W	2	40003	-	-
Master reset (fast access)	-	x	x	-	-	US16	1	W	3	40004	-	-
Flex holding register 01	-	x	x	-	-	US16	1	R/W	4	40005	-	-
Flex holding register 02	-	x	x	-	-	US16	1	R/W	5	40006	-	-
Flex holding register 03	-	x	x	-	-	US16	1	R/W	6	40007	-	-
Flex holding register 04	-	x	x	-	-	US16	1	R/W	7	40008	-	-
Flex holding register 05	-	x	x	-	-	US16	1	R/W	8	40009	-	-
Flex holding register 06	-	x	x	-	-	US16	1	R/W	9	40010	-	-
Flex holding register 07	-	x	x	-	-	US16	1	R/W	10	40011	-	-
Flex holding register 08	-	x	x	-	-	US16	1	R/W	11	40012	-	-
Flex holding register 09	-	x	x	-	-	US16	1	R/W	12	40013	-	-
Flex holding register 10	-	x	x	-	-	US16	1	R/W	13	40014	-	-
Flex holding register 11	-	x	x	-	-	US16	1	R/W	14	40015	-	-
Flex holding register 12	-	x	x	-	-	US16	1	R/W	15	40016	-	-
Flex holding register 13	-	x	x	-	-	US16	1	R/W	16	40017	-	-
Flex holding register 14	-	x	x	-	-	US16	1	R/W	17	40018	-	-
Flex holding register 15	-	x	x	-	-	US16	1	R/W	18	40019	-	-
Flex holding register 16	-	x	x	-	-	US16	1	R/W	19	40020	-	-
Flex holding register 17	-	x	x	-	-	US16	1	R/W	20	40021	-	-
Flex holding register 18	-	x	x	-	-	US16	1	R/W	21	40022	-	-
Flex holding register 19	-	x	x	-	-	US16	1	R/W	22	40023	-	-
Flex holding register 20	-	x	x	-	-	US16	1	R/W	23	40024	-	-

7.8.2 Example for “Fast reading”

Example:

Setting 3 “Float Values” for fast read access

The following example shows the selection of 3 float values assigned to the flex input register for “Fast reading”

Write the addresses of the three selected register into the

“Flex input register select 01”

“Flex input register select 02”

“Flex input register select 03”

Perform Modbus initialization by writing “1” to the holding register “Modbus init (Restart Modbus)” addr. 2256 (42257).

After Modbus initialization the selected values can be read via the

“Flex input register 01/02”

“Flex input register 03/04”

“Flex input register 05/06”

Result of Flex input register selection

Parameter (holding register)	Value	Selection	Unit	Register	Read Write	Address	
					R, W	Holding register	Input register
Flex input register select 01	528	Mass Flow	-	US16	R/W	6912	-
Flex input register select 02	576	Density	-	US16	R/W	6928	-
Flex input register select 03	3168	Drive Gain	-	US16	R/W	6944	-

Result of Flex input register (after performing "Modbus Init")

Parameter (holding register)	Selection	Unit	Register	Read Write	Address	
				R, W	Holding register	Input register
Flex input register 01	Mass flow	Mass flow unit	FL32	R	-	98
Flex input register 03	Density	Density unit	FL32	R	-	100
Flex input register 05	Drive Gain	V	FL32	R	-	102

Example:

Setting 2 “Float Values” and 2 “Unit values” for fast read access

The following example shows the selection of 2 float values and 2 US16 register assigned to the flex input register for “Fast reading”. Write the addresses of the four selected register into the

“Flex input register select 01”

“Flex input register select 02”

“Flex input register select 03”

“Flex input register select 04”

Perform Modbus initialization by writing “1” to the holding register “Modbus init (Restart Modbus)” addr. 2256 (42257).

After Modbus initialization the selected values can be read via the

“Flex input register 01/02”

“Flex input register 03”

“Flex input register 04/05”

“Flex input register 6”

Result of Flex input register selection

Parameter (holding register)	Value	Selection	Unit	Register	Read Write	Address	
					R, W	Holding register	Input register
Flex input register select 01	528	Mass Flow	-	US16	R/W	6912	-
Flex input register select 02	1072	Mass Flow Unit	-	US16	R/W	6928	-
Flex input register select 03	576	Density	-	US16	R/W	6944	-
Flex input register select 04	1392	Density Unit	-	US16	R/W	6960	-

Result of Flex input register (after performing "Modbus Init")

Parameter (holding register)	Selection	Unit	Register	Read Write	Address	
				R, W	Holding register	Input register
Flex input register 01	Mass flow	Mass flow unit	FL32	R	-	98
Flex input register 03	Mass flow Unit	-	US16	R	-	100
Flex input register 04	Density	Density unit	FL32	R	-	101
Flex input register 06	Density Unit	-	US16	R	-	103

7.8.3 Example for “Fast writing”

Example:

Setting 3 “Float Values” for fast write access

The following example shows the selection of 3 float values assigned to the flex holding register for “Fast writing”

Write the addresses of the three selected register into the

“Flex holding register select 01”

“Flex holding register select 02”

“Flex holding register select 03”

Perform Modbus initialization by writing “1” to the holding register “Modbus init (Restart Modbus)” addr. 2256 (42257).

After Modbus initialization the selected values can be read or written via the

“Flex holding register 01/02”

“Flex holding register 03/04”

“Flex holding register 05/06”

Result of Flex holding register selection

Parameter (holding register)	Value	Selection	Unit	Register	Read Write	Address	
					R, W	Holding register	Input register
Flex holding register select 01	2288	Ref. density carrier	-	US16	R/W	7072	-
Flex holding register select 02	2304	Temp. coeff. A carrier	-	US16	R/W	7088	-
Flex holding register select 03	2320	Temp. coeff. B carrier	-	US16	R/W	7104	-

Result of Flex holding register (after performing "Modbus Init")

Parameter (holding register)	Selection	Unit	Register	Read Write	Address	
				R, W	Holding register	Input register
Flex holding register 01	Ref. density carrier	-	FL32	R/W	4	40005
Flex holding register 03	Temp. coeff. A carrier	Temp unit	FL32	R/W	6	40007
Flex holding register 05	Temp. coeff. B carrier	Temp unit	FL32	R/W	8	40009

Example:

Setting 2 "Float Values" and 2 "Unit values" for fast write access

The following example shows the selection of 2 float values and 2 US16 register assigned to the flex holding register for "Fast writing". Write the addresses of the four selected register into the

"Flex holding register select 01"

"Flex holding register select 02"

"Flex holding register select 03"

"Flex holding register select 04"

Perform Modbus initialization by writing "1" to the holding register "Modbus init (Restart Modbus)" addr. 2256 (42257).

After Modbus initialization the selected values can be read or written via the

"Flex holding register 01"

"Flex holding register 02/03"

"Flex holding register 04/05"

"Flex holding register 6"

Result of Flex holding register selection

Parameter (holding register)	Value	Selection	Unit	Register	Read Write	Address	
					R, W	Holding register	Input register
Flex holding register select 01	1072	Temp Unit	-	US16	R/W	7072	-
Flex holding register select 02	2304	Temp. coeff. A carrier	-	US16	R/W	7088	-
Flex holding register select 03	2320	Temp. coeff. B carrier	-	US16	R/W	7104	-
Flex holding register select 04	1392	Density Unit	-	US16	R/W	7120	-

Result of Flex holding register (after performing "Modbus Init")

Parameter (holding register)	Selection	Unit	Register	Read Write	Address	
				R, W	Holding register	Input register
Flex holding register 01	Temp unit	-	US16	R/W	4	40005
Flex holding register 02	Temp. coeff. A carrier	Temp unit	FL32	R/W	5	40006
Flex holding register 04	Temp. coeff. B carrier	Temp unit	FL32	R/W	7	40008
Flex holding register 06	Density Unit	-	US16	R/W	9	40010

8. TECHNICAL DETAILS OF MODBUS COMMUNICATION

8.1 Supported Modbus Register Types

Register type	Size	Data Format	Data Type	Description
Short	16 bit	US16	Integer (2 Byte)	Unsigned 16-bit integers in the range of 0 to 65535.
Long	32 bit	US32	2 Integer (4 Byte)	Unsigned 32-bit integers in the range of 0 to 4294967296 2 consecutive registers used to store the value.
Float	32 bit	FL32	Floating-point (4 Byte)	Float value in single precision in the IEEE-754 format. 2 consecutive registers used to store the value.
String	16 bit	STRING	8-bit ASCII (n * 2 Byte)	One or more consecutive registers. Each register contains 2 ASCII characters.

8.2 Supported Modbus Function Codes

ROTAMASS 3 Series Modbus communication type supports the following “Function Codes” to communicate with the host.

Function Code Description	Function Code		Data Type	Register Address
Read holding register	03	0x03	16-bit Integer	4x
Read input register	04	0x04	16-bit Integer	3x
Write single register (holding)	06	0x06	16-bit Integer	4x
Write multiple register (holding)	16	0x10	16-bit Integer	4x
Report slave ID	17	0x11	16-bit Integer	-
Read/Write multiple register	23	0x17	16-bit Integer	4x
Read device identification	43	0x2B	16-bit Integer	-

8.3 Supported Exception Codes

ROTAMASS 3 Series Modbus communication type supports the following “Exception Codes” to indicate physical transmission errors.

Exception Code Description	Exception Code		Description
Illegal function	1	0x01	The function code in the query is not supported
Illegal data address	2	0x02	The data address received in the query is outside the initialized memory area
Illegal data value	3	0x03	The data in the request is illegal.

8.4 Modbus Initialization

Parameter (holding register)	Option /MB1	Option /MB2	Option /MB3	Flex input	Flex holding	Data format	16 bit Register	Read Write	Address			
									Holding register	Holding register Modicon	Input register	Input register Modicon
									R, W	4x		3x
Modbus initialization												
Device address	x	x	x	-	-	US16	1	R/W	512	40513	-	-
Baud rate, Data format	x	x	x	-	-	US16	1	R/W	513	40514	-	-
Modbus mode	x	x	x	-	-	US16	1	R/W	514	40515	-	-
Modbus option	-	x	x	-	-	US16	1	R	2000	42001	-	-
Modbus init (Restart Modbus)	x	x	x	-	-	US16	1	W	2256	42257	-	-
Master reset	x	x	x	-	-	US16	1	W	2880	42881	-	-

Table 8.4.1 Modbus initialization

Register	Parameter	Description and Setting
Holding register 512	Device address	Select: 1 to 247 Set the device address for ROTAMASS 3 where the host expects to communicate. Make sure that no other device on the bus uses the same address.
Holding register 513	Baud rate	Select: 1200, 2400, 4800, 9600, 19200, 38400, 57600, 76800, 115200 Make sure that host and ROTAMASS 3 use the same baud rate for communication
Holding register 513	Data format	Select: Even 1 stop bit, Odd 1 stop bit, None 1 stop bit, None 2 stop bits Make sure that host and ROTAMASS 3 use the same communication settings.
Holding register 514	Modbus mode	Select: RTU, ASCII Make sure that host and ROTAMASS 3 communicate in the same Modbus mode.
Holding register 2256	Modbus init	 IMPORTANT The Modbus communication module must be restarted after changing any of the above settings. This can be done by either powering off and on the device or by executing the function "Modbus init". Please note that the settings in the menu will be updated after initialization of the Modbus communication module.
Holding register 2000	Modbus option	Indication: Modbus option /MB2, Modbus option /MB3 Indicates the selected ROTAMASS 3 Modbus communication option.
Holding register 2880	Master reset	Default: all parameters set to default except board constants, calibration constants, detector depending parameter and Concentration measuring settings in service menu. Settings of "Flex input register select □□" and "Flex holding register select □□" will be reset to zero.

8.5 Communication Status Register

ROTAMASS 3 Series Modbus communication type has implemented a “Communication Status Register” to signal logical errors like violation of data ranges, invalid selections or write protection at the time when a register is being written.

Values which are invalid or out of range will not be stored and the previous content of the register will be kept and returned to the host. The “Communication Status Register” will be updated with the last written register, the status, the access counts and the failed counts.

Writing to registers which are not accessible because of ROTAMASS 3 is in write protection mode or the option model is not correct will also be indicated in the “Communication Status Register”.

Values which consist of two or more registers like float values or ASCII values have to be written with the defined register size at once. When writing only single registers of the parameter (e.g. writing only 1 register of a 4 register ASCII value) the data will not be accepted and returns status information in the “Communication status register”.

When writing multiple registers the data will not be returned and as a consequence the master will not be able to check it. Therefore to make sure if these values are accepted and stored in the device the only solution is to read back the value after writing using another read command!

For details of Modbus communication refer to the specification

http://www.modbus.org/docs/Modbus_Application_Protocol_V1_1b.pdf.

Parameter	Option /MB1	Option /MB2	Option /MB3	Flex input	Flex holding	Data format	16 bit Register	Read Write	Address			
									Holding register	Holding register Modicon	Input register	Input register Modicon
									R, W	4x		3x
Modbus Communication Status												
Holding Register	-	x	x	x	-	US16	2	R	6752	46753	87	30088
Access Status	-	x	x	x	-	US16	2	R	6753	46754	88	30089
Access Count	-	x	x	x	-	US16	2	R	6754	46755	89	30090
Failed Count	-	x	x	x	-	US16	2	R	6755	46756	90	30091

Table 8.5.1 Modbus Communication Status

Register	Parameter	Description and Setting
Holding register 6752	Holding Register	Indication: Holding register address of last Modbus transaction Indicates the address of the last read or written holding register.
Holding register 6753	Access status	Indication: Status of last Modbus transaction Indicates the status of the last read or write transaction acc. to table .
Holding register 6754	Access count	Indication: Count of Modbus transaction with success Indicates the summarized counts of successful transactions.
Holding register 6754	Failed count	Indication: Count of Modbus transaction which failed Indicates the summarized counts of unsuccessful transactions.

Table 8.5.2 Modbus access status bit

Access Status	Status bit	Status value	Priority	Description
Good	0x0000	0	low	The transmission of the value was successful.
Invalid selection	0x0001	1		The selected enumerator is not supported
Value out of range	0x0002	2		The received value is outside the allowed range
Not enough data	0x0004	4		The received data count is less than the register size.
Too much data	0x0008	8		The received data count is more than the register size.
Not readable	0x0010	16		The selected register is not readable (Write only register).
Not writable	0x0020	32		The selected register is not writable (Read only register).
Service Mode not open	0x0040	64		The service register of the ROTAMASS are not accessible.
Device in write protect Mode	0x0080	128		The ROTAMASS is in write protect mode.
Register not in option /MB2	0x0100	256		The selected register is not supported in the option /MB2.
Register not supported	0x0200	512	high	The selected register is not supported in the ROTAMASS.

8.6 Byte Order of Transmission

This section describes the transmission of values consist of two or more registers. In case of differences in the memory model of ROTAMASS 3 Series Modbus communication type and the host system it might be necessary to swap registers and/or single bytes.

The following registers define the transmission order.

These registers will not be changed after a "Modbus Init" or a "Master Reset".

Parameter	Option /MB1	Option /MB2	Option /MB3	Flex input	Flex holding	Data format	16 bit Register	Read Write	Address			
									Holding register	Holding register Modicon	Input register	Input register Modicon
									R, W	4x		3x
Modbus Byte order Setting												
Byte Order Long Register	-	x	x	-	-	US16	1	R/W	6272	46273	-	-
Byte Order Float Register	-	x	x	-	-	US16	1	R/W	6288	46289	-	-
Byte Order String Register	-	x	x	-	-	US16	1	R/W	6304	46305	-	-

Table 8.6.1 Modbus byte order setting

Register	Parameter	Description and Setting
Holding register 6272	Byte order long register	Select: 0 to 3, default: 1 Set the order of the byte transmission for long values during the Modbus protocol. The default transmission order is "Low address first, high byte first" Make sure that host and ROTAMASS 3 use the same byte order for communication
Holding register 6288	Byte order float register	Select: 0 to 3, default: 1 Set the order of the byte transmission for float values during the Modbus protocol. The default transmission order is "Low address first, high byte first" Make sure that host and ROTAMASS 3 use the same byte order for communication
Holding register 6304	Byte order string register	Select: 0 to 1 Set the order of the byte transmission for string values during the Modbus protocol. The default transmission order is "High byte first" Make sure that host and ROTAMASS 3 use the same byte order for communication

8.6.1 Byte order of short value

Short value (2 byte)	Order code	34567	
		Byte 1	Byte 0
Value in Hex		87	07
Modbus Notation		A	B
Modbus Register		Addr. n	
Byte order (default) (High byte first)	-	A	B



NOTE

The order of the byte transmission for short values (single register) is fix during the Modbus protocol.

8.6.2 Byte order of long value

Long value (4 byte)	Order code	3456789			
		Byte 3	Byte 2	Byte 1	Byte 0
Value in Hex		00	34	BF	15
Modbus Notation		A	B	C	D
Modbus Register		Addr. n+1		Addr. n	
Byte order	0	A	B	C	D
Byte order (default) (Low address first, High byte first)	1	C	D	A	B
Byte order	2	B	A	D	C
Byte order	3	D	C	B	A

8.6.3 Byte order of float value

Float value (4 byte) (in IEEE-754 notation)	Order code	44.996628			
		Byte 3	Byte 2	Byte 1	Byte 0
Value in Hex		42	33	FC	8C
Modbus Notation		A	B	C	D
Modbus Register		Addr. n+1		Addr. n	
Byte order	0	A	B	C	D
Byte order (default) (Low address first, High byte first)	1	C	D	A	B
Byte order	2	B	A	D	C
Byte order	3	D	C	B	A

8.6.4 Byte order of string value

String value (6 byte)	Order code	123456					
		Byte 5	Byte 4	Byte 3	Byte 2	Byte 1	Byte 0
Value in Hex		31	32	33	34	35	36
Modbus Notation		A	B	C	D	E	F
Modbus Register		Addr. n		Addr. n+1		Addr. n+2	
Byte order (default) (High byte first)	0	A	B	C	D	E	F
Byte order	1	B	A	D	C	F	E

8.6.5 Example of float value transmission

The following illustration shows the storage of a float value in the IEEE-754 format and the order of transmission in Modbus protocol on a typical example.

The mass flow value in user unit (holding register 528/529 decimal or 210/211 hex) should be read using Modbus command 3:

Storage in registers:

Float value	44.996628			
Byte number	Byte 3	Byte 2	Byte 1	Byte 0
Values in hex in IEEE-754 notation	42	33	FC	8C
Register no.	529 dec. (211 hex)		528 dec. (210 hex)	

Transmission via Modbus (all values in hex):

Request from host	Device address	Function code	Start address	Number of registers	Checksum
	01	03	02 10	00 02	C4 76

Response from ROTAMASS	Device address	Function Code	Number of bytes	Data				Checksum 7B 3D
	01	03	04	44.996628				
				Byte 1	Byte 0	Byte 3	Byte 2	
				FC	8C	42	33	
Reg. 528 dec. (Reg. 210 hex)		Reg. 529 dec. (Reg. 211 hex)						

Because of the order of transmission the registers eventually need to be swapped to get the float value in the standard IEEE-754 format. Commercially available software might do this automatically. However, those users who intend to write their own communication software must be aware of the order of transmission when reading multiple registers and swap registers and/or bytes if necessary.

8.7 Transmission of Device Status Information

Modbus protocol is designed to reduce overhead. Therefore there is no continuous transmission of status information. ROTAMASS 3 Series Modbus communication type provides three holding and input registers to read the current status of error (Holding register 896, Input register 42), alarm (Holding register 912, Input register 43) and warning (Holding register 928, Input register 44) messages at the time when the registers are being read. History information is provided by ROTAMASS (Holding register 3264), alarm (Holding register 3265) and warning (Holding register 3266)

The number of error, alarm and warning messages corresponds with the bit number of the registers. If several messages are present at a time, all corresponding bits are set at once.

Register bit no.	15	14	13	12	11	10	9	8	7	6	5	4	3	2	1	0
Error	E16	E15	E14	E13	E12	E11	E10	E9	E8	E7	E6	E5	E4	E3	E2	E1
Alarm	A16	A15	A14	A13	A12	A11	A10	A9	A8	A7	A6	A5	A4	A3	A2	A1
Warning	W16	W15	W14	W13	W12	W11	W10	W9	W8	W7	W6	W5	W4	W3	W2	W1

For a detailed description of meaning of and countermeasure for each error, alarm and warning message please see below or refer to chapter 8 of the standard instruction manual IM 01R04B04-00E-E.

8.7.1 Error, Alarm and Warning descriptions

EAW Code	EAW Bit value	EAW No.	Name	Meaning	Description
Errors					
0x0101	0x0001	E-01	Frequency fault	Frequency fault detected	Driving frequency out of range
0x0102	0x0002	E-02	Signal fault	Signal fault detected	Phase difference out of range
0x0103	0x0004	E-03	EEPROM fault	EEPROM fault detected	CRC-Error
0x0104	0x0008	E-04	CPU fault	CPU fault detected	Micro processor is not working
0x0105	0x0010	E-05	DSP fault	DSP fault detected	Micro processor is not working
0x0106	0x0020	E-06	Sensor 1 fault	Sensor 1 Signal fault detected	Sensor 1 signal below 7% for 3 min
0x0107	0x0040	E-07	Sensor 2 fault	Sensor 2 Signal fault detected	Sensor 2 signal below 7% for 3 min
0x0108	0x0080	E-08	Temp sens fault	Temperature Sensor Fault detected	T<-220°C or T>550°C
Alarms					
0x0201	0x0001	A-01	MF 1 criteria	Mass flow L Alarm	Mass flow below MF 1 criteria
0x0202	0x0002	A-02	MF 2 criteria	Mass flow H Alarm	Mass flow above MF 2 criteria
0x0203	0x0004	A-03	VF 1 criteria	Volume flow L Alarm	Volume flow below VF 1 criteria
0x0204	0x0008	A-04	VF 2 criteria	Volume flow H Alarm	Volume flow above VF 2 criteria
0x0205	0x0010	A-05	Dens. 1 criteria	Density L Alarm	Density below Dens. 1 criteria
0x0206	0x0020	A-06	Dens. 2 criteria	Density H Alarm	Density above Dens. 2 criteria
0x0207	0x0040	A-07	Temp. 1 criteria	Temperature L Alarm	Temperature below Temp. 1 criteria
0x0208	0x0080	A-08	Temp. 2 criteria	Temperature H Alarm	Temperature above Temp. 2 criteria
0x0209	0x0100	A-09	Conc. 1 criteria	Concentration L Alarm	Concentration below Conc. 1 criteria
0x020A	0x0200	A-10	Conc. 2 criteria	Concentration H Alarm	Concentration above Conc. 2 criteria
0x020B	0x0400	A-11	Netflow 1 crit.	Net flow L Alarm	Net flow below Net flow 1 crit.
0x020C	0x0800	A-12	Netflow 2 crit.	Net flow H Alarm	Net flow above Net flow 2 crit.
0x020D	0x1000	A-13	Total thr exceed	Total threshold exceed	Totalizer value exceeds total threshold
0x020E	0x2000	A-14	Slug detection	Slug flow detected	Slug criterion is reached
0x020F	0x4000	A-15	Empty pipe det.	Empty pipe detectd	Empty pipe criterion is reached
0x0210	0x8000	A-16	Corrosion det.	Corrosion detected	Corrosion criterion is reached
Warnings					
0x0301	0x0001	W-01	Density low	Density lower 0.3 kg/l	Density lower than 0.3 kg/l
0x0302	0x0002	W-02	Fixed dens act.	Fixed Dens selected	Parameter Dens fix val sel is enabled
0x0303	0x0004	W-03	Fixed temp act.	Fixed Temp selected	Parameter Temp fix val sel is enabled
0x0304	0x0008	W-04	Fixed MF active	Fixed MF selected	Parameter MF fix val sel is enabled
0x0305	0x0010	W-05	Autozero running	Autozero is running ...	Autozero process is performed, started by user action or status input
0x0306	0x0020	W-06	AZ val error	Autozero value out of range	Auto zero value is out of the internal detector depending range
0x0307	0x0040	W-07	AZ fluct error	Autozero fluctuation out of range	Auto zero fluctuation is out of the internal detector depending range
0x0308	0x0080	W-08	Sensor simul.	Sensor simulation active	Fixed frequency or fixed phase difference is enabled
Warnings not available for option /MB2					
0x0300	0x0100	W-09	Fixed Prim Out	Analog output 1 fixed	Analog output 1 fixed at 4mA for multidrop operation
0x030A	0x0200	W-10	Prim Out sat.	Analog output 1 saturated	Analog output 1 reaches less than 3.8mA or more than 20.5mA
0x030B	0x0400	W-11	Sec Out sat.	Analog output 2 saturated	Analog output 2 reaches less than 3.8mA or more than 20.5mA
0x030C	0x0800	W-12	Tert Out sat.	Pulse/Status output 1 saturated	Relation between pulse width and pulse rate of Pulse/Status output 1 is too high
0x030D	0x1000	W-13	Quart Out sat.	Pulse/Status output 2 saturated	Relation between pulse width and pulse rate of Pulse/Status output 2 is too high
0x030E	0x2000	W-14	Sec. Dig. Out. sat.	Sec. dig. out sat.	Analog output 2 saturated
0x030F	0x4000	W-15	In multidrop mode	In multidrop mode	Analog output 1 in multidrop operation
0x0310	0x8000	W-16	not used		

8.7.2 Reading of ordered errors, alarms and warnings

History Ordered	Addr. 3232 (43233)
History Ordered	EAW code (Register 1)
	EAW code (Register 2)
	EAW code (Register 3)
	EAW code (Register 4)
	EAW code (Register 5)
	EAW code (Register 6)
	EAW code (Register 7)
	EAW code (Register 8)
	EAW code (Register 9)
	EAW code (Register 10)

EAW Code	EAW No.
0x030A	W-10
0x0101	E-01
0x0000	-
0x0000	-
0x0000	-
0x0000	-
0x0000	-
0x0000	-
0x0000	-
0x0000	-

Clearing the table “History Ordered” can be performed by writing “0x01” (apply) to the holding register “Clear History ord” at address 3248 (43249).

8.7.3 Reading of absolute errors and warnings

History Abs. Entry 1-4	Addr. 3296 (43297)
History Abs Entry 1	mm/dd (Register 1)
	yyyy (Register 2)
	E bit value (Register 3)
	W bit value (Register 4)
History Abs Entry 2	mm/dd (Register 5)
	yyyy (Register 6)
	E bit value (Register 7)
	W bit value (Register 8)
History Abs Entry 3	Entry 9 (Register 9)
	Entry 10 (Register 10)
	Entry 11 (Register 11)
	Entry 12 (Register 12)
History Abs Entry 4	Entry 13 (Register 13)
	Entry 14 (Register 14)
	Entry 15 (Register 15)
	Entry 16 (Register 16)

EAW Bit/Date	EAW No. /Date
0x0919	09/25
0x07DD	2013
0x0001	E-01
0x0200	W-10
0x0916	09/22
0x07DD	2013
0x0002	E-02
0x0200	W-10
0x0000	-
0x0000	-
0x0000	-
0x0000	-
0x0000	-
0x0000	-
0x0000	-

Writing a date value to the holding register “Clear History Abs” will store the actual register values of “History absolute” 3264 (43265) to the history and clears the “History absolute”.

Clear History Abs	Addr. 3360(43361)
ClearHistory Abs	mm/dd (Register 1)
	yyyy (Register 2)

Date	Date
0x0919	09/25
0x07DD	2013

8.7.4 Reading of Autozero Initial and history values

Autozero active values	Addr. 3888 (43889)
Autozero Active	AZ active value ----- (Register 1/2)
	Density active value ----- (Register 3/4)
	Temperature active value ----- (Register 5/6)

Example	
0x5CAB ----- 0xC157	-13.4601
0x6A08 ----- 0x3F81	1.01105
0x75CE ----- 0x424A	50.615

Autozero initialize values	Addr. 3904 (43905)
Autozero Initial	AZ initial value ----- (Register 1/2)
	Density initial value ----- (Register 3/4)
	Temperature initial value ----- (Register 5/6)
	mm/dd (Register 7)
	yyyy (Register 8)

Example	
0x5CAB ----- 0xC157	-12.8794
0x6A08 ----- 0x3F81	1.0052
0x75CE ----- 0x424A	50.6123
0x0901	09/01
0x07DD	2013

Autozero History Entry 1-2	Addr. 3920 (43921)
Autozero Initial Entry 1/2	AZ entry value ----- (Register 1/2)
	Density entry value ----- (Register 3/4)
	Temperature entry value ----- (Register 5/6)
	mm/dd (Register 7)
	yyyy (Register 8)
	AZ entry value ----- (Register 9/10)
	Density entry value ----- (Register 11/12)
	Temperature entry value ----- (Register 13/14)
	mm/dd (Register 15)
	yyyy (Register 16)

Example	
0x5CAB ----- 0xC157	-13.4601
0x6A08 ----- 0x3F81	1.01105
0x75CE ----- 0x424A	50.615
0x091E	09/30
0x07DD	2013
0x6477 ----- 0xC156	-13.3995
0x627B ----- 0x3F71	0.942909
0x754E ----- 0x424A	50.6146
0x0919	09/25
0x07DD	2013

Writing a date value to the holding register "Autozero to History" will store the actual register values of autozero, density and temperature to the history with the time stamp.

Clear History Abs	Addr. 944(40945)
Autozero to History	mm/dd (Register 1)
	yyyy (Register 2)

Date	Date
0x091E	09/30
0x07DD	2013

8.8 Transmission of Device Status Information

Modbus protocol is designed to support different communication speed in the range of 2400 to 115200 Baud. Depending on the selected baud rate the access time varies.

Therefore the total “transmission time” is composed of the
 Command request time (depends on baud rate) +
 ROTAMASS Access time +
 Command responds time (depends on baud rate)

Table 8.8.1 ROTAMASS Transmission Time

Action	Transmission Time		
	Modbus Response time + Request time ⁽¹⁾	Access Time	
		ROTAMASS Reaction time ⁽²⁾	ROTAMASS Storage time ⁽³⁾
Fast reading of input or flex input register	< 9 ms	< 10 ms	-
Fast writing to flex holding register	< 9 ms	< 10 ms	500 ms max.
Fast execution of predefined holding register	< 9 ms	< 10 ms	500 ms max.
Reading from holding register	< 9 ms	around 500 ms	
Writing to holding register	< 9 ms	around 500 ms	

⁽¹⁾ Time the command needs for transmission (Example):

Modbus function code 6, writing of holding register,
 Baud rate 19200Bd, 8 Data Bit, 1 Stop bit, 17 Bytes in total

⁽²⁾ Time the ROTAMASS needs to react on the request from the master and send the response.

⁽³⁾ Time the ROTAMASS needs to store the new value without burden or delay the Modbus communication.
 Writing again to the same register during the storage time should be avoided.

8.9 Modbus Write Protection

Parameter	Option /MB1	Option /MB2	Option /MB3	Flex input	Flex holding	Data format	16 bit Register	Read Write	Address			
									Holding register	Holding register Modicon	Input register	Input register Modicon
									R, W	4x		3x
Write protection												
Write protect	-	x	x	x	-	US16	1	R	2896	42897	-	-
Key status	-	x	x	x	-	US16	1	R/W	2912	42913	-	-
Enable WRT 10 min	-	x	x	-	-	String	4	W	3840	43841	-	-
New password	-	x	x	-	-	String	4	W	3856	43857	-	-
Software seal	-	x	x	x	-	US16	1	R	3872	43873	-	-

Table 8.9.1 Write protection

Register	Parameter	Description and Setting
Holding register 2896	Write Protect	Yes: Write protection is activated. No: Write protection is deactivated. Write protect function is provided to inhibit parameter change. That becomes active by entering a password in "New password". Write protect status is released for 10 minutes by entering the password in "Enable wrt 10 min".
Holding register 3856	New password	Enter new password to change state of write protection. While write protect status is released, enter a new password twice, within 30 sec in "New Password".
Holding register 3840	Enable wrt 10 min	"Enable Write" release write protect status for 10 minutes. It will not be possible to set a new password when 10 minutes have elapsed. If a parameter, which is write enabled, is changed while the device is in "Enable wrt 10min", release time is extended for further 10 minutes.
Holding register 3872	Software seal	The first indication in Software seal menu is 'keep'. The "Software seal" menu is reserved as evidence so that user is able to confirm whether the Joker password is used or not. This evidence is saved. After the joker password setting it shows 'break'. After setting a new password and release via "Enable wrt 10 min", the Software seal shows "keep" again.
Holding register 2912	Key Status	Enable: Infrared keys are activated. Inhibit: Infrared keys are deactivated.

**NOTE**

- When the write protect function is active, data setting changes in all parameters of RCC□3 are inhibited and cannot be changed using the Modbus register. Also the setting via the infrared pushbuttons is prohibited.
- If 8 characters are input as "space", the Write protect function is in release status irrespective of time.
- If RCC□3 powers off and on again within 10 minutes after releasing of write protect status, "Enable Write" becomes unavailable.

**NOTE**

The specific register

"Device address," holding register 512

"Baud rate, Data format," holding register 513

"Modbus mode," holding register 514

are not write protected during the write protection is active.

They should not be changed via Modbus during this device status.

Blank Page

9. MODBUS COMMUNICATION TOOL

9.1 Preconditions

The Modbus Communication Tool was designed to support the parameters and values of the ROTAMASS 3 Series Modbus communication type which are available via Modbus.

The Modbus Communication Tool supports the same communication settings as ROTAMASS.

Baud rates: 2400, 4800, 9600, 19200, 38400, 57600, 76800, 115200

Data formats: 8E1, 8O1, 8N2, 8N1

Modbus modes: RTU, ASCII

The Modbus Communication Tool was successfully tested on the following operating systems:

Win XP 32bit, Win 7 32bit, Win 7 64bit

The Modbus Communication Tool uses the .NET 2.0 Framework from Microsoft. The installer will check the availability of .NET 2.0 and ask you for installation if necessary.

The Modbus Communication Tool is provided on a "AS IS" basis. Although it might work on other Windows versions and with other Modbus devices this was not tested and Rota Yokogawa does not provide any liability, warranty or support for its use.

9.2 Installation and Start

The Modbus Communication Tool comes with installers for 32bit and 64bit operating systems. Please select the appropriate installer according to the operating system installed on your computer. If in doubt please check the documentation of your operating system.

For the installation administrator privileges are required. If you do not possess administrator privileges please contact your system administrator for installation.

After successful installation an entry in your start menu will be generated and an icon will be placed on your desktop. To start the application simply double-click on the entry in the start menu or on the desktop icon.

9.3 Using the Modbus Communication Tool

After starting the Modbus Communication Tool by double-clicking the entry in the start menu or the desktop icon a pop-up window with logo and disclaimer will appear. Please read and confirm. In the next window the communication settings are shown. Here the device address, COM port of the computer, baud rate, data format and Modbus mode can be adjusted.



NOTE

The default settings are device address 1, 19200 baud, data format 8E1, Modbus RTU.

Make sure that all communication settings of the computer and the connected ROTAMASS match. To establish a connection check also proper wiring of the lines A (D-) and B (D+) between the RS485 interface and ROTAMASS.

After opening the COM port by pressing the button the connection will be tested and the result will be indicated.

Adjustment of the communication settings

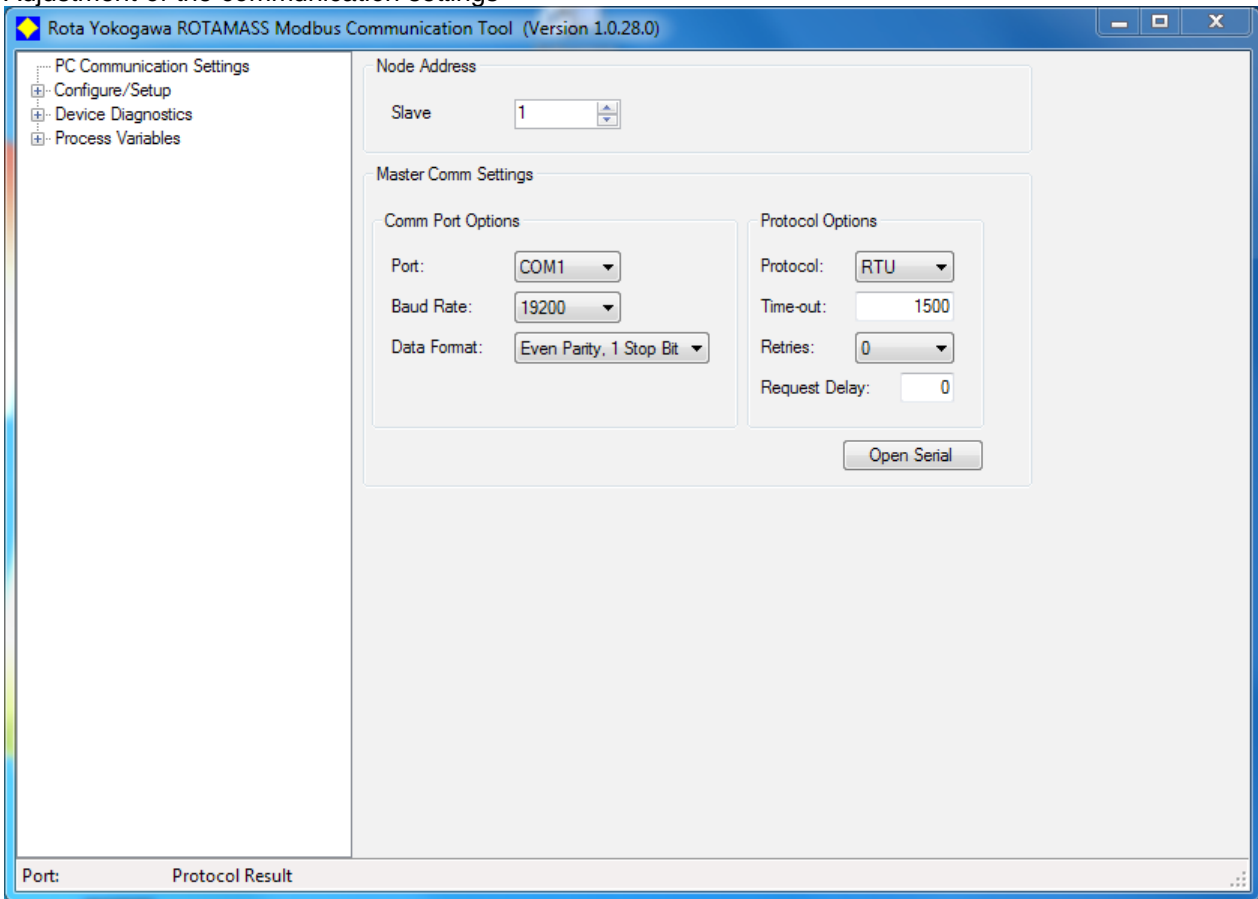

Reading of measurement values

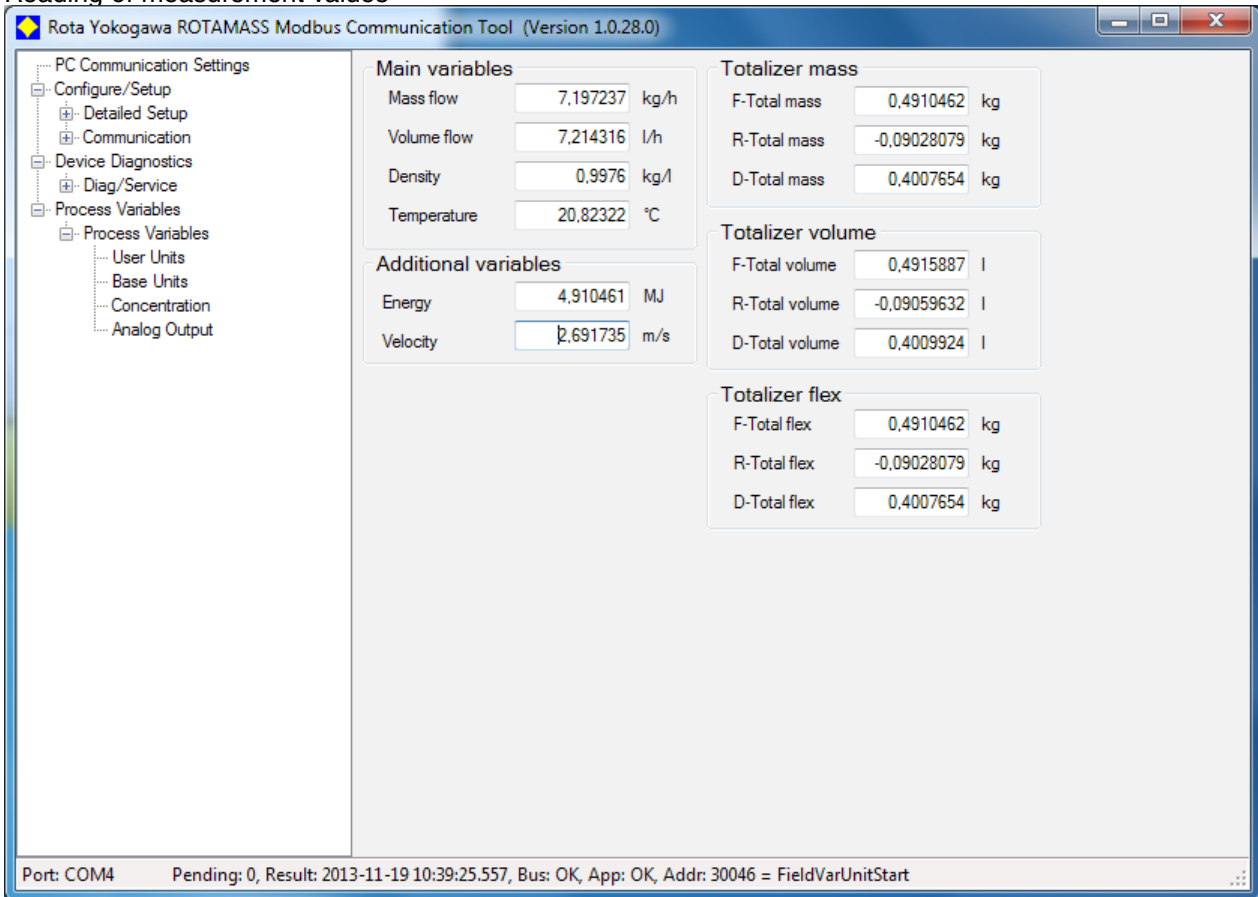

Configuration

The screenshot displays the configuration window for the Rota Yokogawa ROTAMASS Modbus Communication Tool (Version 1.0.28.0). The left sidebar shows a tree view of configuration options, with 'Mass Flow' selected under 'Config Field Variables'. The main area is titled 'Mass Flow' and contains the following settings:

- Output Range Value:** Mass flow LRV is set to 0 kg/h, and Mass flow URV is set to 45 kg/h.
- Output Conditioning:** Mass flow damping is set to 3 s, and Mass flow low cut is set to 0 kg/h.
- Alarm 1:** Mass flow alarm 1 select is set to 'No function' (dropdown), and Mass flow alarm 1 criterion is set to 0 kg/h.
- Alarm 2:** Mass flow alarm 2 select is set to 'No function' (dropdown), and Mass flow alarm 2 criterion is set to 45 kg/h.

At the bottom of the configuration area, there are 'Read' and 'Apply' buttons. The status bar at the very bottom shows: 'Port: COM4 Pending: 0, Result: 2013-11-19 10:41:13.803, Bus: OK, App: OK, Addr: 41185 = MassFlowAlarm2Sel'.

YOKOGAWA ELECTRIC CORPORATION
World Headquarters
9-32, Nakacho 2-chome, Musashino-shi
Tokyo 180-8750
Japan
www.yokogawa.com

YOKOGAWA CORPORATION OF AMERICA
2 Dart Road
Newnan GA 30265
USA
www.yokogawa.com/us

YOKOGAWA EUROPE B.V.
Euroweg 2
3825 HD AMERSFOORT
The Netherlands
www.yokogawa.com/eu

YOKOGAWA ELECTRIC ASIA Pte. LTD.
5 Bedok South Road
Singapore 469270
Singapore
www.yokogawa.com/sg

YOKOGAWA CHINA CO. LTD.
3F Tower D Cartelo Crocodile Building
No.568 West Tianshan Road Changing District
Shanghai, China
www.yokogawa.com/cn

YOKOGAWA MIDDLE EAST B.S.C.(c)
PO. Box 10070, Manama
Building 577, Road 2516, Busaiteen 225
Muharraq, Bahrain
www.yokogawa.com/bh

Yokogawa has an extensive sales and distribution network.
Please refer to the European website (www.yokogawa.com/eu) to contact your nearest representative.



YOKOGAWA ◆