Introduction

Thank you for purchasing the PR300 Power and Energy Meter.

This manual provides information about the procedure for installing, wiring and operating the PR300 Power and Energy Meter, as well as precautions for handling the product. Read this manual carefully before use, in order to use the product correctly and safely. (Record the parameter settings of the PR300 on MEMO column in Appendix 4, "Parameter List" of this manual.)

■ Intended Readers

This manual is intended for personnel in charge of the installation and wiring, instrumentation and control equipment, maintenance of equipment, and operation and monitoring.

■ Related Documents

The following user's manuals all relate to the PR300 Power and Energy Meter. Read them as necessary.

Printed manuals

Model PR300 Power and Energy Meter Startup Manual <Installation>	Document number: IM 77C01E01-02E
--	----------------------------------

Model PR300 Power and Energy Meter Startup Manual <Initial Setup Operations>	
--	--

	Document number: IM 77C01E01-03E
--	----------------------------------

Electronic manual (PDF file)

Model PR300 Power and Energy Meter Communication Interface User's Manual (RS-485 and Ethernet Communications)	
---	--

	Document number: IM 77C01E01-10E
--	----------------------------------

■ Notes on This Manual

- The contents of this manual are subject to change without prior notice for reasons of performance and/or functional enhancements.
- Every effort has been made to ensure accuracy in the preparation of this manual. Should any errors or omissions come to your attention however, please contact your nearest Yokogawa branch or sales office.
- Reprinting and reproducing the contents of this manual either in part or in their entirety, is prohibited without the prior consent of Yokogawa.
- The document concerning TCP/IP software has been created by Yokogawa based on the BSD Networking Software, Release 1 that has been licensed from the University of California.

■ Trademark

- All the brands or names of Yokogawa Electric's products used in this manual are either trademarks or registered trademarks of Yokogawa Electric Corporation.
- Ethernet is a registered trademark of XEROX Corporation in the United States.
- Company and product names that appear in this manual are trademarks or registered trademarks of their respective holders.

■ Documentation Conventions

Symbols

This manual uses the following symbols.

● Symbols Used in the Main Text



NOTE

Draws attention to information that is essential to understanding the operation and/or features of the product.

TIP

Gives additional information to complement the present topic.

See Also

Gives reference locations for further information on the topic.

■ Description of Displays

- (1) Some of the representations of product displays shown in this manual may be exaggerated, simplified, or partially omitted for reasons of convenience when explaining them.
- (2) Figures and illustrations representing the PR300's displays may differ from the real displays in regard to the position and/or indicated characters (uppercase or lowercase, for example), the extent of difference does not impair a correct understanding of the functions and the proper operations and monitoring of the system.

■ Revision Information

1st Edition: April, 2006

4th Edition: June 2008

2nd Edition: August, 2006

5th Edition: September, 2017

3rd Edition: February, 2007

Notices

■Regarding This User's Manual

- This manual should be passed on to the end user. Keep the manual in a safe place.
- Read this manual carefully to gain a thorough understanding of how to operate this product before you start using it.
- This manual is intended to describe the functions of this product. Yokogawa Electric Corporation (hereinafter referred to as Yokogawa) does not guarantee that these functions are suited to the particular purpose of the user.
- Under absolutely no circumstances may the contents of this manual, in part or in whole, be transcribed or reproduced without prior consent.
- The contents of this manual are subject to change without prior notice.
- Every effort has been made to ensure accuracy in the preparation of this manual. Should any errors or omissions come to your attention however, please contact your nearest Yokogawa representative or our sales office.

■Regarding Protection, Safety, and Prohibition Against Unauthorized Modification

- In order to protect the product and the system controlled by it against damage and ensure its safe use, be certain to strictly adhere to all of the instructions and precautions relating to safety contained in this document. Yokogawa does not guarantee safety if products are not handled according to these instructions.
- The following safety symbols are used on the product and/or in this manual.

● Symbols Used on the Product and in This Manual



This symbol on the product indicates that the operator must refer to an explanation in the user's manual in order to avoid the risk of injury or death of personnel or damage to the instrument. The manual describes how the operator should exercise special care to avoid electric shock, electrocution or other dangers that may result in injury or loss of life.



Protective Grounding Terminal

This symbol indicates that the terminal must be connected to ground prior to operating the equipment.



CAUTION

- **Power supply**
Check that the voltage of the power supply agrees with the rated supply voltage of the Meter.
 - **Protective grounding**
To avoid electric shock, be sure to provide protective grounding before turning on the Meter.
 - **Need for protective grounding**
Do not cut the internal or external protective grounding conductor of the Meter or disconnect the conductor from the protective grounding terminal. In either case, the protective functions of the Meter will become ineffective, resulting in a hazardous situation.
 - **Defect of protective grounding**
If the protective functions of protective grounding or fuses are assumed to be defective, do not operate the Meter. Before putting the Meter into operation, check that the protective functions are normal.
 - **Use in a gaseous environment**
Do not put the Meter in operation in a location where any combustible or explosive gases or fumes are present. It is extremely dangerous to use the Meter under such conditions.
 - **Removal of casing**
No person except Yokogawa service personnel is allowed to remove the casing. Removing the casing is hazardous since the Meter contains high-voltage parts.
 - **External wiring**
Securely provide protective grounding before wiring the Meter to the measuring object or external control circuit.
 - **Damage to protective construction**
Operating the Meter in a way not described in this manual may impair the protective construction of the Meter.
-

■Force Majeure

- Yokogawa does not make any warranties regarding the product except those mentioned in the WARRANTY that is provided separately.
- Yokogawa assumes no liability to any party for any loss or damage, direct or indirect, caused by the use or any unpredictable defect of the product.
- Be sure to use the spare parts approved by Yokogawa when replacing parts or consumables.
- Modification of the product is strictly prohibited.
- Reverse engineering such as the disassembly or decompilation of the product is strictly prohibited.
- No portion of the product supplied by Yokogawa may be transferred, exchanged, leased, or sublet for use by any third party without the prior permission of Yokogawa.

Checking the Package

Verify the package as explained below before starting to use the product. Should the delivered product be wrong or the package be missing any item, contact the vendor from which you purchased the product.

Checking the Model and Suffix Codes

The PR300 bears a nameplate. Confirm that “MODEL” and “SUFFIX” (suffix codes) shown on the nameplate agree with those of the product ordered.

Model	Suffix Codes	Description
PR300	-□ □ □ □ □ -6 □ -0	Power and Energy Meter
Phase and wire system	-3	Universal three-phase three-wire system (single-phase two-wire, single-phase three-wire, and three-phase three-wire systems)
	-4	Universal three-phase four-wire system (single-phase two-wire, single-phase three-wire, three-phase three-wire, and three-phase four-wire systems)
	-5	Three-phase four-wire system (2.5 element) *1
Input voltage/ input current	1	Universal voltage input *2 (150 V, 300 V, 600 V) / 1 A
	2	Universal voltage input *2 (150 V, 300 V, 600 V) / 5 A
Additional input and output function	0	1 digital input
	1	1 digital input, 1 analog output
	2	1 digital input, 1 pulse output
	3	1 digital input, 1 analog output, 1 pulse output
Communication function	0	RS-485 communication
	3	RS-485 communication, Ethernet communication *3
Optional measuring function	0	None
	3	Demand measurement (1 demand alarm output)
Power supply	-6	100-240 V AC ±10% (50/60 Hz) or 130-300 V DC ±15%
Phase indication format	A	A, B, and C indications
	R	R, S, and T indications
	-0	Always 0

*1 Can be used only when the voltage is in a state of equilibrium. In cases where “Three-phase four-wire system (2.5 element)” is specified, the input current specification of 1 A AC is not applicable.

*2 Set the voltage range (150 V, 300 V or 600 V) according to the rated input voltage to be measured.

Rated input voltage	Voltage range	Allowable input voltage
120 V	150 V	150 V
240 V	300 V	300 V
480 V	600 V	600 V

*3 For Ethernet communication, the RS-485 communication interface is exclusively for the Ethernet-serial gateway function.

Serial Number (NO.)

Also inform this number shown in “NO.” on the nameplate when contacting the vendor from which you purchased the PR300.

Checking the Accessories

(1) JIS/ANSI-mounting kit



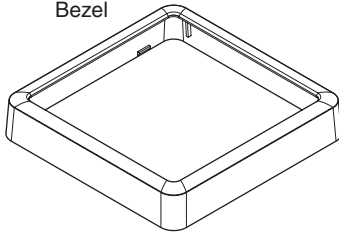

Bezel

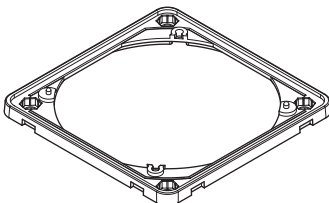

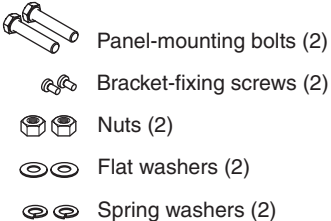
Panel-mounting bracket





-  Panel-mounting bolts (2)
-  Bracket-fixing screws (2)
-  Nuts (2)
-  Flat washers (2)
-  Spring washers (2)

(2) DIN-mounting brackets
(for DIN 96-square instrument panel mounting)

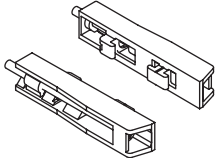

(3) Dust cover
(with 1 fixing screw)

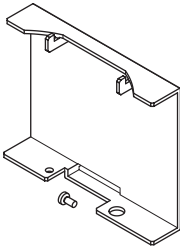

(4) Terminal cover
(with 3 fixing screws)

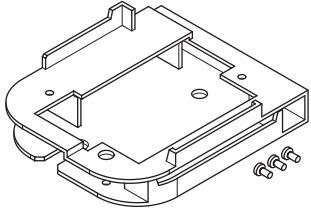

(5) Shorting bar
(for RS-485 communication termination)



(7) Startup Manuals
(Installation/Initial Setup Operations)

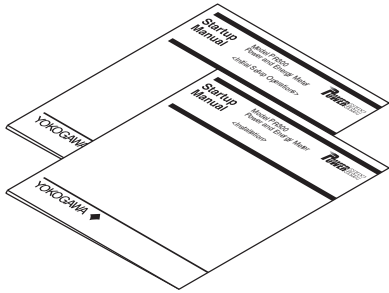

(6) Tag number labels

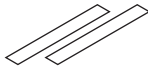

Item Name	Qty	Remarks	
(1) JIS/ANSI-mounting kit	Bezel	1	
	Panel-mounting bracket	1	
	Panel-mounting bolts	2	
	Bracket-fixing screws	2	
	Flat washers	2	
	Spring washers	2	
	Nuts	2	
(2) DIN-mounting brackets	2	Used to mount the PR300 according to the DIN 96-square instrument size.	
(3) Dust cover		1	Attached onto the top of the PR300 main unit.
	Fixing screw	1	
(4) Terminal cover		1	Attached to the PR300 terminal section. (Must always be attached to avoid a possible electric shock.)
	Fixing screws	3	
(5) Shorting bar	1	Used in RS-485 communication if the PR300 is a terminal device.	
(6) Tag number label	2		
(7) Startup manual	2	A quick reference manual for use in initial installation.	

Contents

Introduction	i
Notices	ii
Checking the Package	iii
■ Checking the Model and Suffix Codes	iii
■ Checking the Accessories	iv
Chapter 1 Installation and Wiring	
1.1 Installation with the ANSI 4-inch Round Form or JIS 110-square Instrument Size	1-1
External Dimensions	1-1
Panel Cutout Dimensions	1-1
Mounting Method.....	1-2
1.2 Installation with the DIN 96-square Instrument Size	1-3
External Dimensions	1-3
Panel Cutout Dimensions	1-3
Mounting Method.....	1-4
1.3 Wiring	1-5
Crimping Terminal Recommendations	1-5
Single-phase two-wire system (voltage input, current input, power supply)	1-6
Single-phase three-wire system (voltage input, current input, power supply)	1-6
Three-phase three-wire system (voltage input, current input, power supply)	1-6
Three-phase four-wire system (voltage input, current input, power supply)	1-7
Three-phase four-wire system (2.5 element) (voltage input, current input, power supply)	1-7
Other Wiring	1-8
1.4 Attaching the Dust Cover and Terminal Cover	1-9
Chapter 2 Preparations before Starting Measurement (Set up the PR300 First)	
2.1 Component Names and Functions	2-1
2.2 Setting the Phase and Wire System	2-2
Range of Phase and Wire System Options	2-3
2.3 Setting the Voltage Range	2-4
Range of Voltage Range Options	2-5
Chapter 3 Parameter Setting Operations	
3.1 Basic Parameter Setting Operations	3-1
Methods of Changing Parameter Setpoints	3-1
3.2 Setting the VT and CT Ratios	3-2
Setting the VT Ratio	3-2
Setting the CT Ratio	3-3
3.3 Setting the Integrated Low-cut Power.....	3-4
3.4 Setting RS-485 Communication Conditions	3-6
3.5 Setting Ethernet Communication Conditions	3-8
3.6 Setting Pulse Output Conditions	3-10
3.7 Setting Analog Output Conditions	3-12
Relationship between Scale Values and Measurement Inputs (Example)	3-13
3.8 Setting Demand Measurement Conditions	3-14
3.9 Setting the Measured Value Display Pattern	3-16
3.10 Setting the “Indicator-out” Mode and Locking Parameters	3-19
Setting the Indicator-out Mode.....	3-19
Locking and Unlocking Parameters	3-20



Chapter 4	Operation for Display of Measurement Items and Measurement Method	
4.1	Measurement Items	4-1
4.2	Switching Display Pattern	4-2
	Switching Display Pattern	4-2
	Initial Values and Example Display Patterns	4-2
4.3	Displaying Measured, Instantaneous, and Maximum/Minimum Values	4-3
	Example Display and Measuring Ranges of Active Power (Regenerative Power)	4-3
	Example Display and Measuring Ranges of Reactive Power	4-3
	Example Display and Measuring Ranges of Apparent Power	4-3
	Example Display and Measuring Ranges of Voltage	4-4
	Example Display and Measuring Ranges of Current	4-4
	Example Display and Measuring Ranges of Power Factor	4-4
	Example Display and Measuring Ranges of Frequency	4-5
	How to Switch between Instantaneous Value, Maximum Value, and Minimum Value	4-5
4.4	Phase Switching for Voltage and Current	4-6
	How to Switch the Phase for Single-phase Three-wire, Three-phase Three-wire and Three-phase Four-wire (2.5 element) Systems	4-6
	How to Switch the Phase for Three-phase Four-wire System	4-6
	How to Read the Phase Indication Lamp	4-6
4.5	Displaying Energy Values	4-7
	Example Display and Measuring Ranges of Active Energy and Regenerative Energy	4-7
	Example Display and Measuring Ranges of LEAD Reactive Energy and LAG Reactive Energy	4-7
	Example Display and Measuring Ranges of Apparent Energy	4-7
	Operation for Energy Value Display	4-8
	Optional Integrating Function	4-9
4.6	Resetting Measured Values	4-10
	Resetting Maximum and Minimum Values	4-10
	Resetting Energy Value	4-10
	Canceling Reset Item Selection (Returning to the Measured Value screen without resetting)	4-11
	Reset Items and Details	4-11
4.7	Demand Measurement (Optional Measuring Function)	4-12
	Example Demand Display and Measuring Ranges	4-12
	Demand Measurement Procedure	4-12
	Operation for Demand Measurement	4-13
	Demand Alarm	4-14
	Example Demand Measurement	4-14
Chapter 5	Troubleshooting	
5.1	Error Display and Recommended Response	5-1
5.2	Maintenance	5-2
Appendix		
Appendix 1	Specifications of PR300	A-1
	Measuring Function	A-1
	Power Items and Equations	A-2
	Input Specifications	A-2
	Digital Input Specifications	A-3
	Analog Output Specifications (additional output function)	A-3
	Pulse Output Specifications (additional output function)	A-3
	Demand Alarm Output Specifications (optional measuring function)	A-4
	Communication Specifications	A-4
	Standard Performance	A-6
	Safety and EMC Standards	A-7
	Environmental Conditions	A-8
	Mounting and Shape	A-8
Appendix 2	System Reset	A-9
Appendix 3	Parameter Map	A-10
Appendix 4	Parameter List	A-12
Appendix 5	Alphanumeric Characters Table for 7-segment LED	A-16

Index

1.1 Installation with the ANSI 4-inch Round Form or JIS 110-square Instrument Size

The PR300 can be installed so that it handles ANSI 4-inch round form or JIS 110-square instruments panel cutouts by attaching the "JIS/ANSI-mounting kit" accessory.

External Dimensions

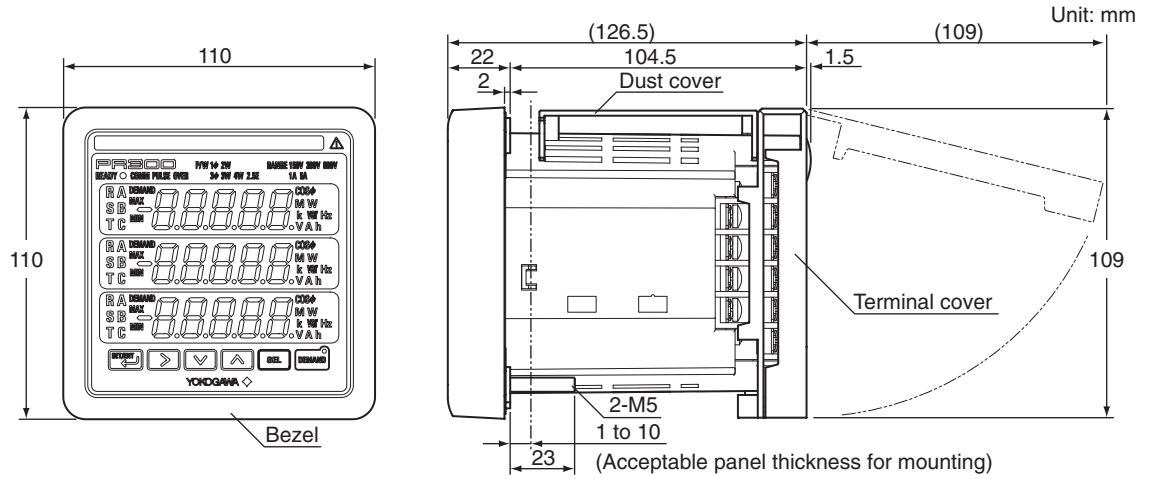

Panel Cutout Dimensions

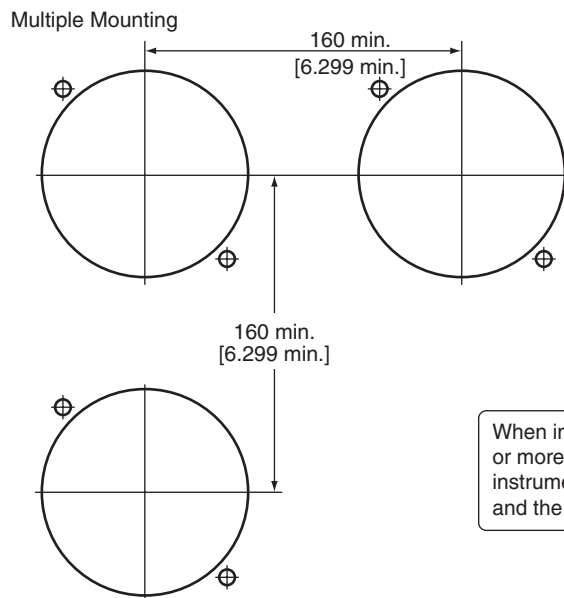
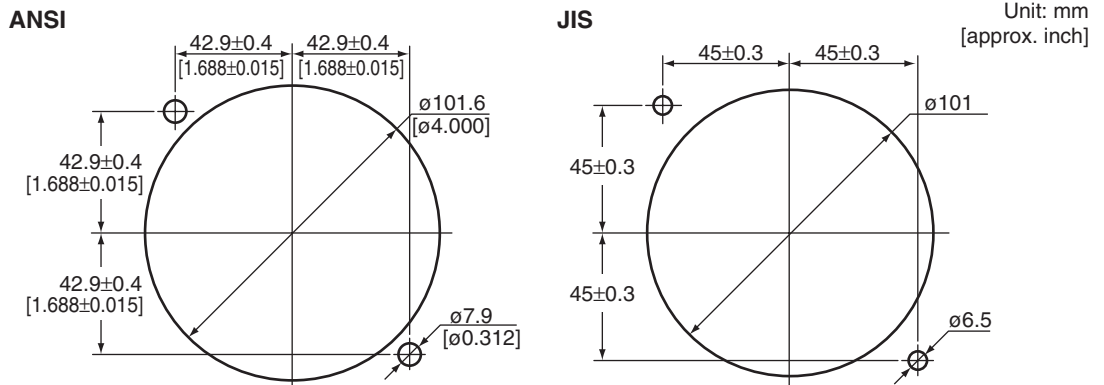

When installing the PR300, provide spacing of 50 mm or more between each face of the PR300 body and the instrument next to the PR300 or between each face and the wall surface.

● Normal Allowable Deviation = ± (Value of JIS B 0401-1998 Tolerance Grade IT18) / 2

! WARNING

- Install the PR300 in the secondary side of the existing breaker.
- Provide spacing of 50 mm or more between the products.

! NOTE

- Do not install the PR300 in the following types of environments, as they may cause the PR300 to malfunction or fail. **Avoid sites:**
 - exposed to significant shock or vibration; where corrosive gases are present; where large amounts of dust are present; exposed to water; exposed to direct sunlight; outside; at altitudes above 2000 m.
- The PR300 mounting position is for vertical panels only.

Mounting Method

1 Set the direction of the panel-mounting bracket.

The diagram on the right shows the front of the bracket (the side into which the panel-mounting bolt is inserted). Rotating the bracket 90° makes the bracket compatible with either ANSI or JIS panel cutouts. Set the bracket to either the ANSI or JIS mark according to which type of panel you are installing, as shown in the diagram on the right.

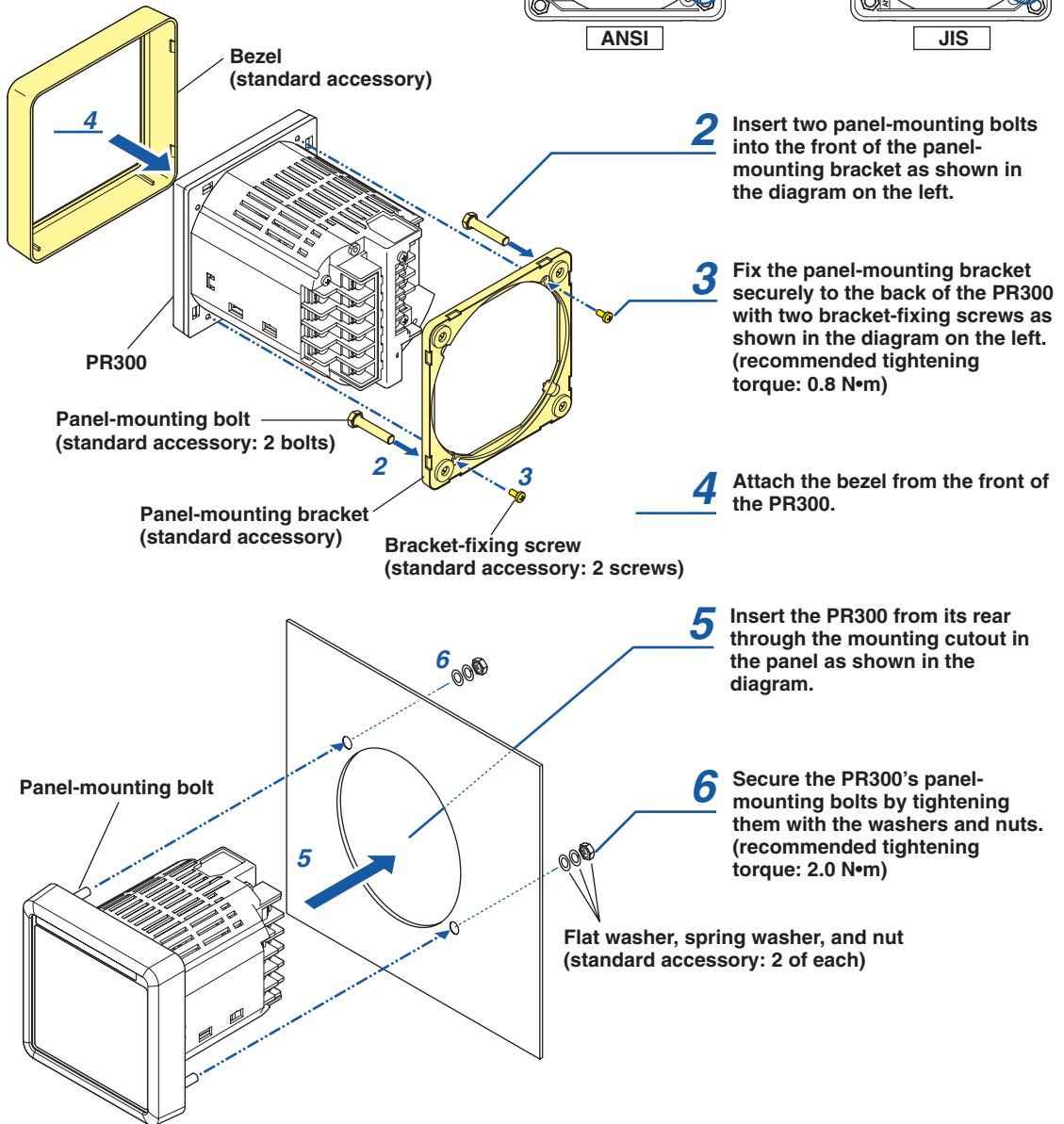
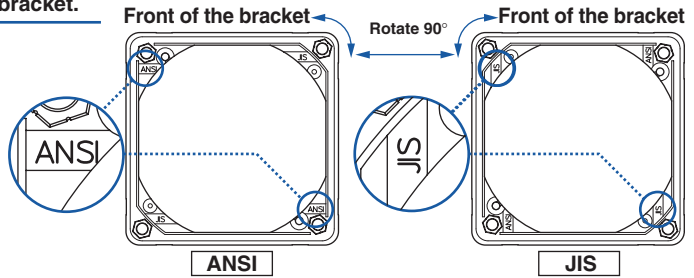

1.2 Installation with the DIN 96-square Instrument Size

External Dimensions

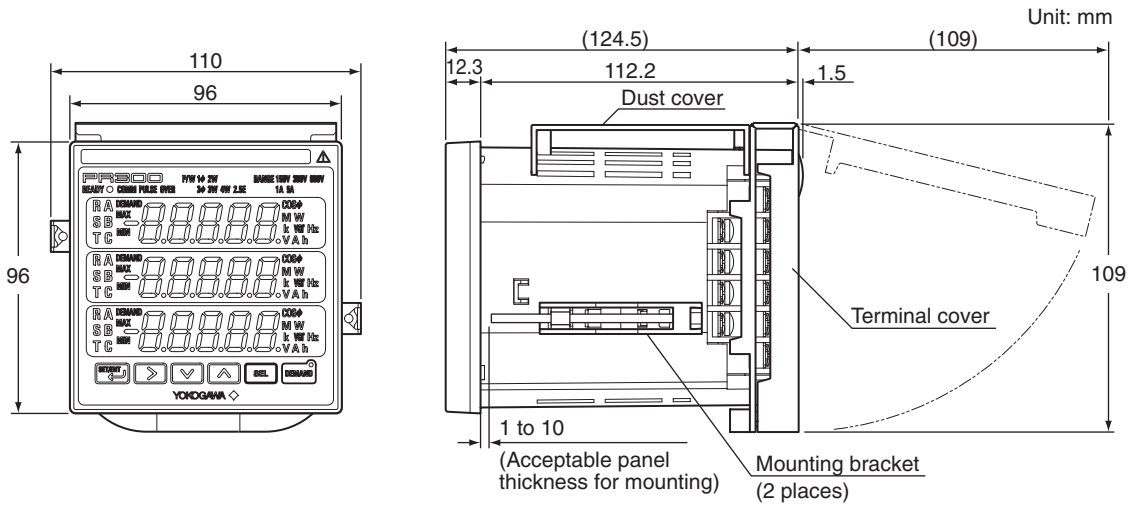

Panel Cutout Dimensions

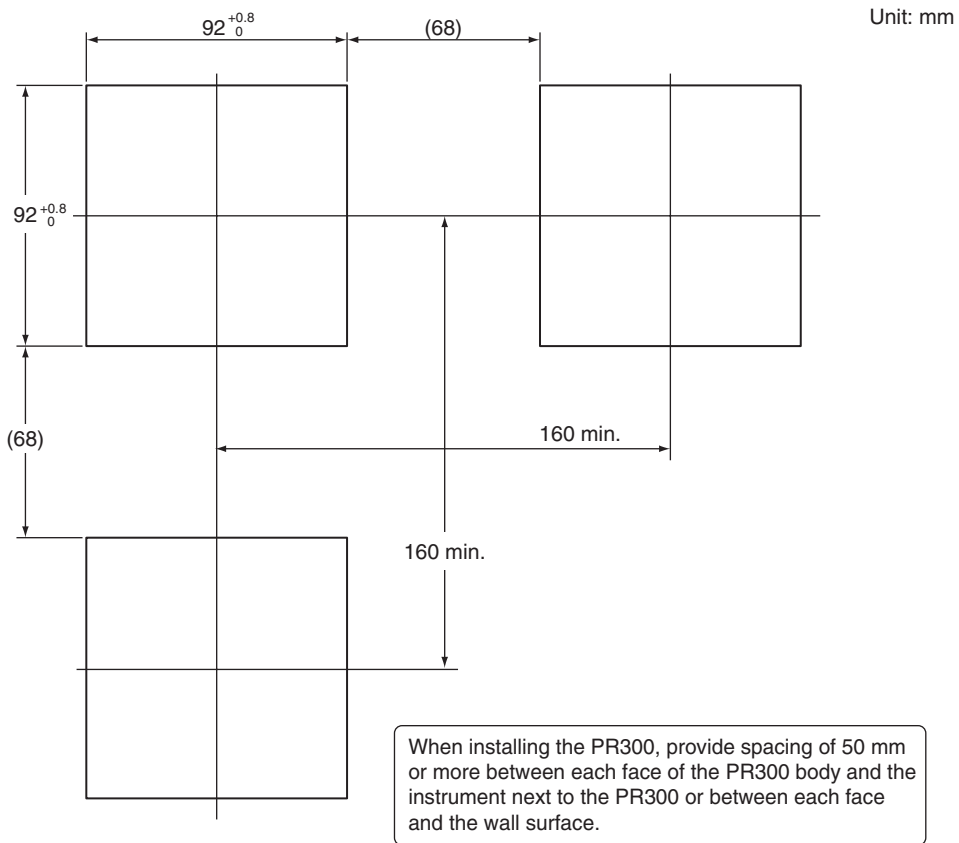

● Normal Allowable Deviation = \pm (Value of JIS B 0401-1998 Tolerance Grade IT18) / 2

 **WARNING**

- Install the PR300 in the secondary side of the existing breaker.
- Provide spacing of 50 mm or more between the products.

 **NOTE**

- Do not install the PR300 in the following types of environments, as they may cause the PR300 to malfunction or fail. **Avoid sites:**
exposed to significant shock or vibration; where corrosive gases are present; where large amounts of dust are present; exposed to water; exposed to direct sunlight; outside; at altitudes above 2000 m.
- The PR300 mounting position is for vertical panels only.

Mounting Method

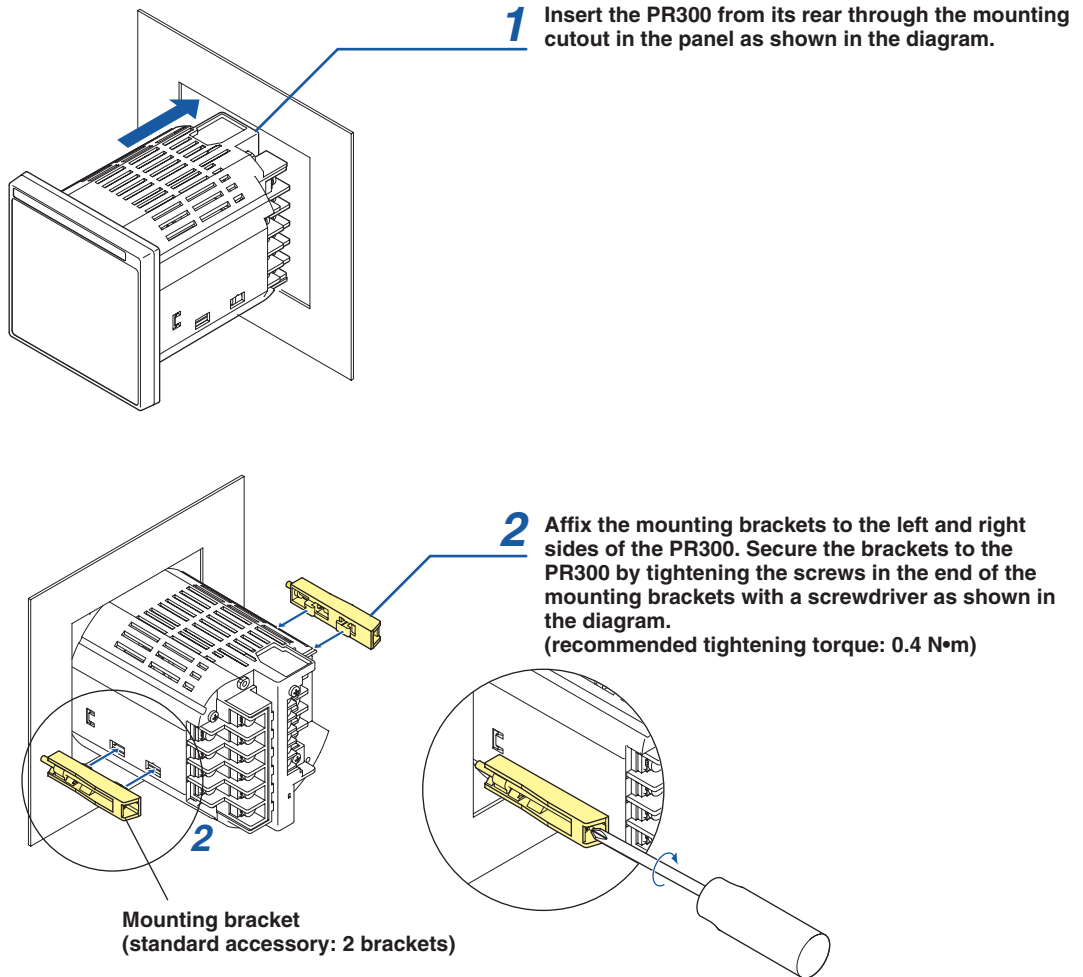

1.3 Wiring



WARNING

- As there is a danger of electric shock, turn off the power supply and check that the cables to be connected are not conducting electricity before carrying out the wiring procedure.
- For safety, be sure to install a circuit breaker switch that conforms to an IEC60947-compatible product, 5 A, 100 V or 220 V AC near the PR300 so as to be operated easily, and clearly indicate that the device is used to de-energize the PR300.
- The wiring procedure for the PR300 should be carried out by a qualified person (an electrician etc.) with knowledge of electrical matters and who has actual experience.
- Install a current transformer (CT) inside a panel when using a conduit for wiring.
- Use a UL Listed Panel only for the panel on which the PR300 is installed.
- If the voltage is below 600 V AC, it is possible to connect the PR300 directly without using a voltage transformer (VT) and if the current is below 5 A AC, it is possible to do so without using a current transformer (CT). However, in order to use the PR300 safely, the use of VT and CT is recommended. Use a UL Listed VT and CT for the PR300.
- Perform wiring for the voltage and current input in the same circuit.
- Check the following before turning on the power. Using the PR300 beyond the stated specifications may cause it to heat up and burn out.
 - Check that the power supply voltage, input voltage, and input current values to be applied to the PR300 agree with its specifications.
 - Check that the external wiring is connected to the terminals in accordance with the specifications.
- Do not touch the screws in locations (a) to (f) shown in the wiring diagrams. They are an essential part of the structure of the PR300. Loosening or tightening them may result in a malfunction or failure of the PR300.
- Be sure to attach the terminal cover to prevent electric shock (refer to Section 1.4).



NOTE

- When attaching the terminal cover

Since the terminal cover of PR300 has the structure of preventing electric shock, the terminal cover cannot be attached after completing all wiring. Refer to Section 1.4, “Attaching the Dust Cover and Terminal Cover” before wiring.

 - (1) Attach the terminal cover after completing the wiring to the terminals 2, 4, 6, 8, 23, 24, and 25.
 - (2) Execute the wiring to the terminals other than those mentioned above after attaching the terminal cover.

If the dust cover is required, attach it before attaching the terminal cover.
- Do not ground the input circuit when connecting voltage and current directly without using VT and CT.

Carry out the wiring referring to the diagrams on pages 1-6, 1-7, and 1-8. The wiring for voltage input, current input, and power supply is M4 screw terminal connection. For other wiring it is M3 screw terminal connection. The connector for connecting to the Ethernet is RJ45.

Use strand wires for the wiring. Wiring cables with a nominal cross-sectional area of 1.25 mm² or thicker are recommended for voltage/current input and power supply; cables with a nominal cross-sectional area of 0.5 mm² or thicker are recommended for other signals.

Crimping Terminal Recommendations

Applicable terminals	ød (mm)	A (mm)	F (mm)	Recommended tightening torque
M4	4.4 max.	7.0 max.	7.8 max.	1.2 N•m
M3	3.3 max.	5.8 max.	6.7 max.	0.6 N•m

Applicable wire size: 1.04 to 2.63 mm² for M4, 0.25 to 1.65 mm² for M3

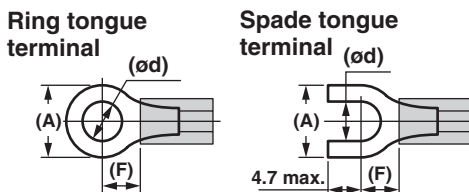

Single-phase two-wire system (voltage input, current input, power supply)

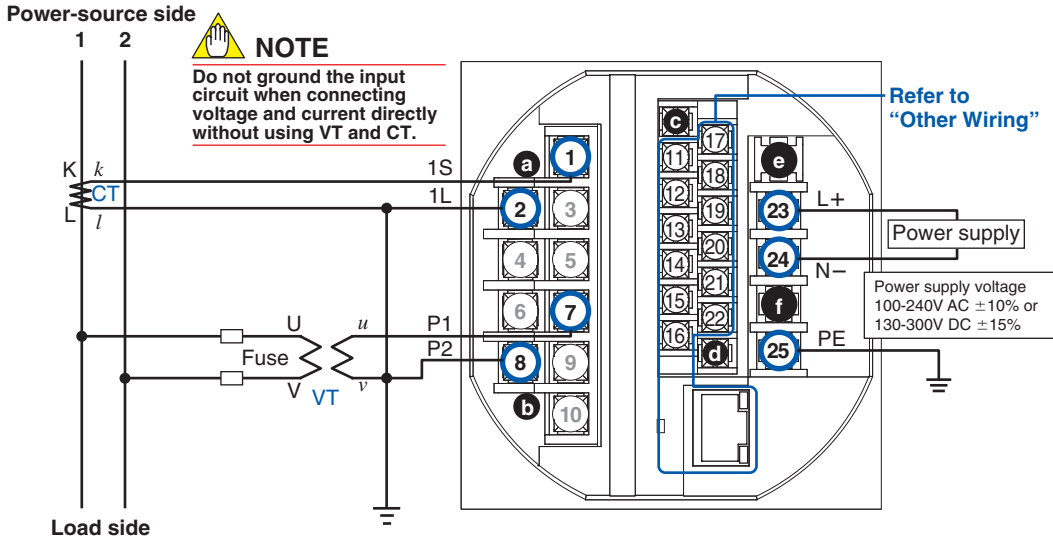

Single-phase three-wire system (voltage input, current input, power supply)

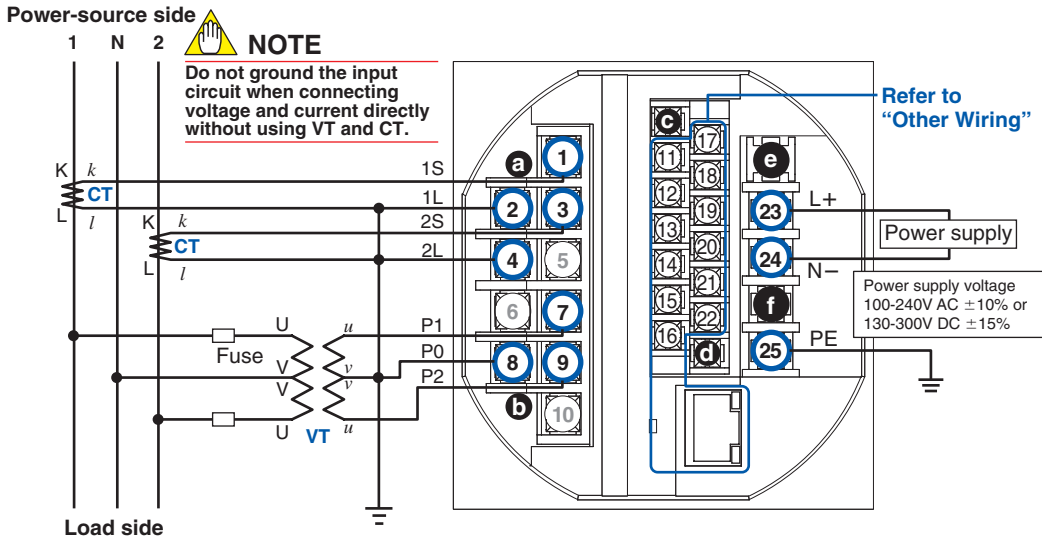

Three-phase three-wire system (voltage input, current input, power supply)

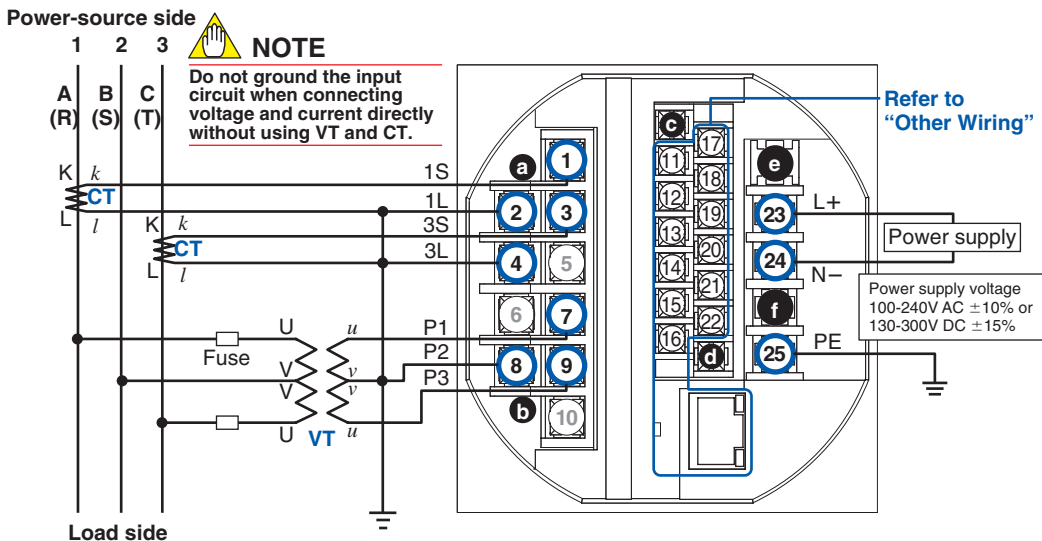

Three-phase four-wire system (voltage input, current input, power supply)

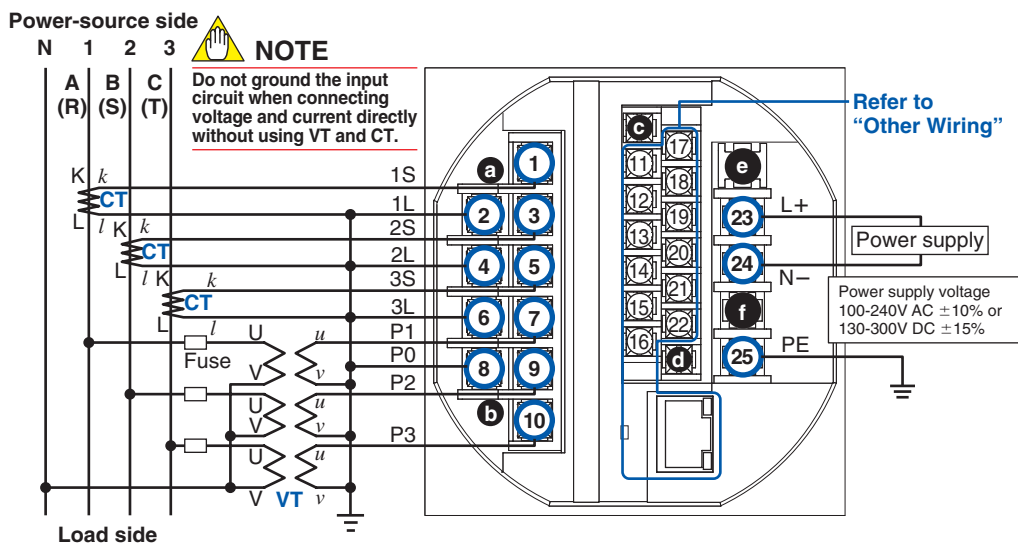

Three-phase four-wire system (2.5 element) (voltage input, current input, power supply)

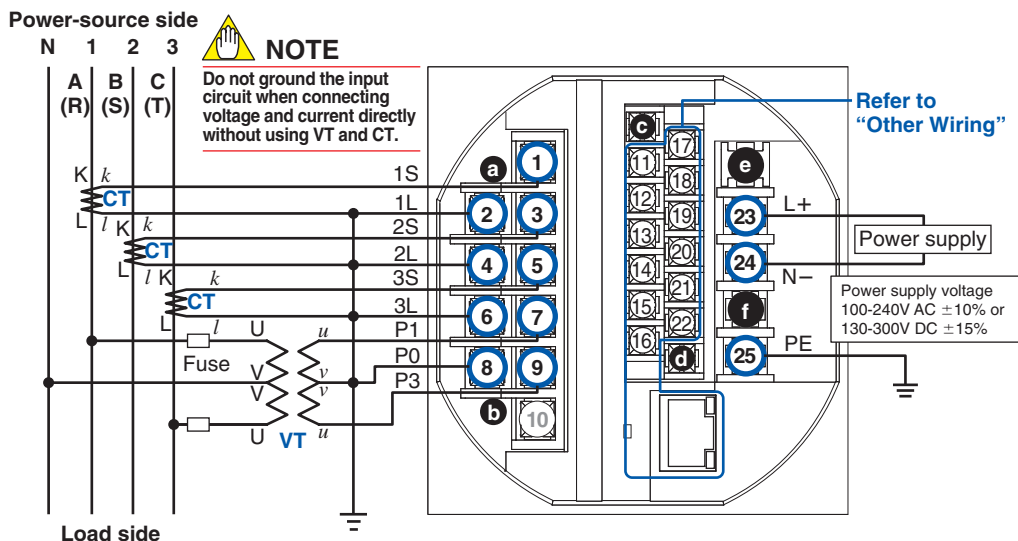

Other Wiring

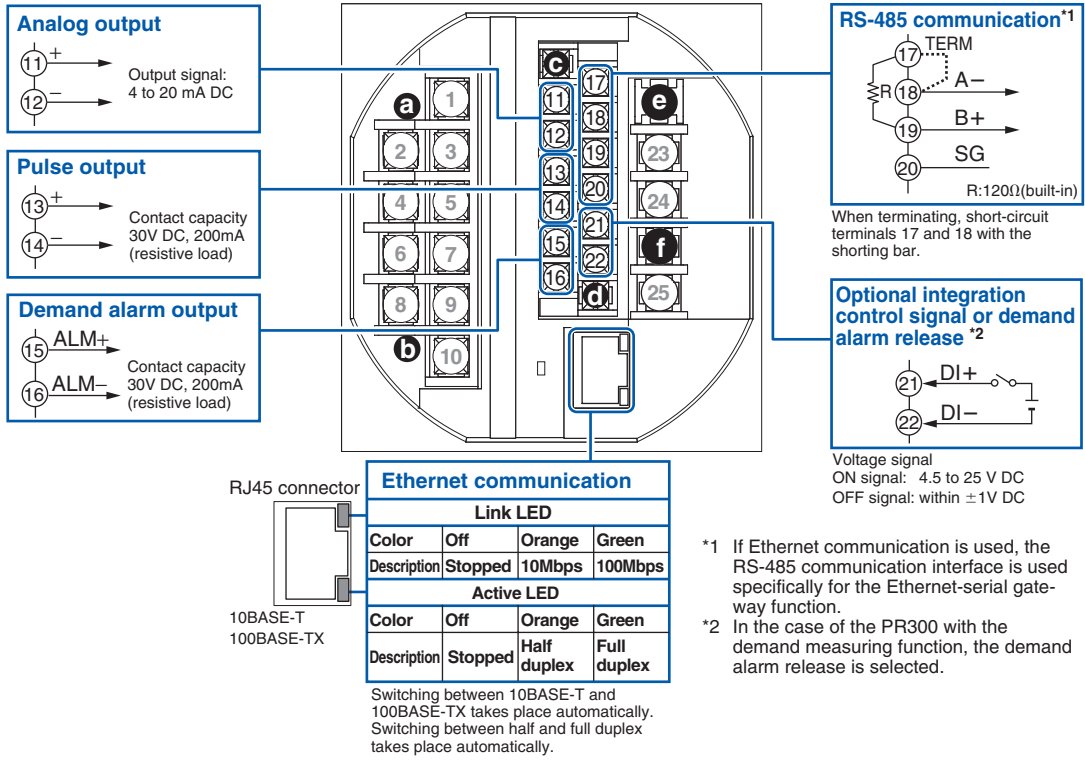

*1 If Ethernet communication is used, the RS-485 communication interface is used specifically for the Ethernet-serial gateway function.
 *2 In the case of the PR300 with the demand measuring function, the demand alarm release is selected.

1.4 Attaching the Dust Cover and Terminal Cover



WARNING

As there is a danger of electric shock, do not attach the dust cover and terminal cover while the wires are live.



NOTE

- Attach the dust cover before attaching the terminal cover.
- The recommended tightening torque for the screws for attaching the dust cover and terminal cover is 0.8N•m.

Attaching the Dust Cover

- 1 Insert the two protruding portions on the underside of the dust cover into the grooves on the upper side of the PR300 as shown in the diagram below.

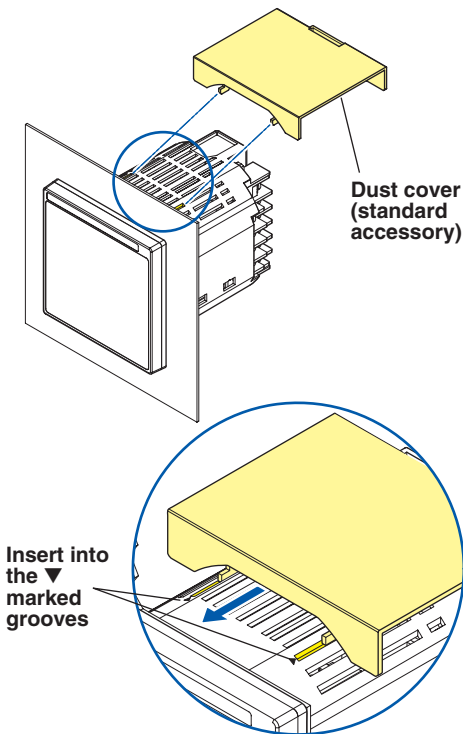

- 2 Secure the dust cover with the screw provided as shown in the diagram below.

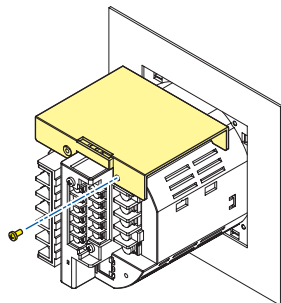

Attaching the Terminal Cover

- 1 Complete the wiring to the terminals 2, 4, 6, 8, 23, 24 and 25, then secure the terminal cover in the open state shown in the diagram below with the two screws provided.

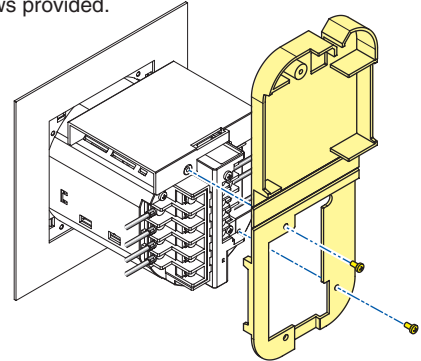

- 2 Complete the wiring to other terminals with the terminal cover open shown in the diagram below.

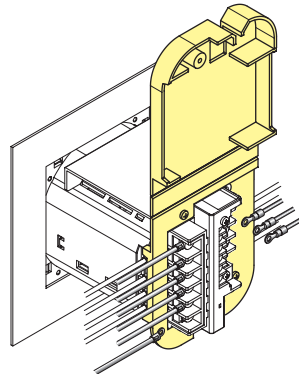



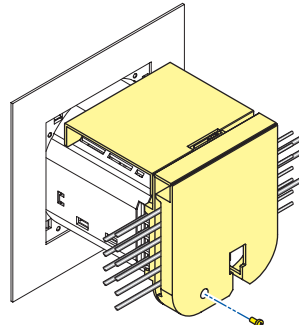

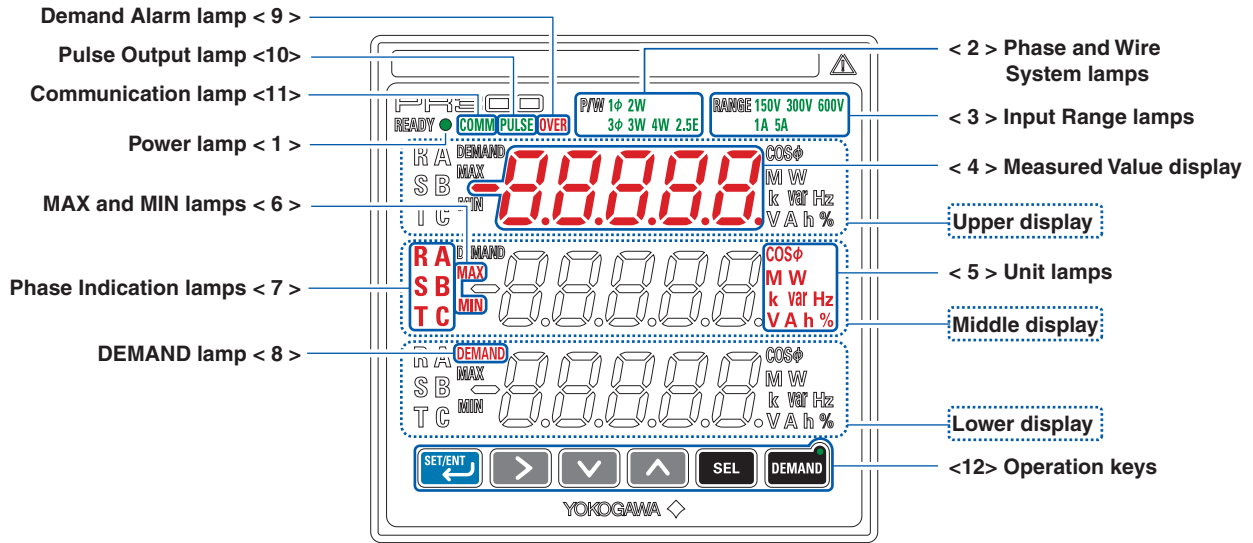

- 3 Close the terminal cover and secure it with the screw provided as shown in the diagram below.



2.1 Component Names and Functions



Name	Display Color	Description
<1> Power lamp	Green	Lights up and remains lit when the PR300 is turned on and operating normally. Blinks (4 times/second) if a communication error occurs, and continues to blink until the PR300 returns to normal.
<2> Phase and Wire System lamps	Green	The phase and wire system option set in the PR300 lights up.
<3> Input Range lamps	Green	The voltage range option set in the PR300 and the current range (rated input) option specified at the time of ordering light up.
<4> Measured Value display	Red	Shows a measured value of power, energy, etc. Also shows a parameter symbol and its setpoint at the time of parameter setting.
<5> Unit lamps	Red	Show the unit symbol of a measured value for each measurement item. These unit symbols are shown in combination depending on the type of measured value.
<6> MAX and MIN lamps	Red	Light up when the maximum or minimum measured value is displayed.
<7> Phase Indication lamps	Red	Light up to tell for which phase the voltage or current value is being measured.
<8> DEMAND lamp	Red	Lights up when the measured value of demand power or demand current is displayed. (Only supported for a PR300 with the demand measuring function.)
<9> Demand Alarm lamp	Red	Lights up if the demand value exceeds the demand alarm point at any point in time other than the demand alarm mask time.
<10> Pulse Output lamp	Green	Lights up when the output is turned on in the pulse output mode and goes out when the output is turned off.
<11> Communication lamp	Green	Blinks while RS-485 or Ethernet communication is in progress.
<12> Operation keys	     	On the Measured Value screen, this key is used, for example, to switch the display pattern. Also used to set parameters on the Parameter screen. On the Measured Value screen, these keys are used, for example, to move from one digit to another in an energy reading. Also used to set parameters on the Parameter screen. On the Measured Value screen, this key is used, for example, to show the maximum/minimum value. Also used to set parameters on the Parameter screen. On the Measured Value screen, this key is used, for example, to switch the phase of voltage/current. Also used to set parameters on the Parameter screen. This key is used to start or stop demand measurement. The lamp (green) in the key lights up in the demand measurement.

2.2 Setting the Phase and Wire System

This section explains how to set the phase and wire system by taking as an example the case when a three-phase four-wire system is changed to a three-phase three-wire system.

Operation

Startup screen

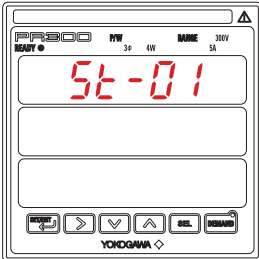

1 Turn on the PR300.

The PR300 shows the station number for about 5 seconds, then the Measured Value screen appears.

Measured Value screen

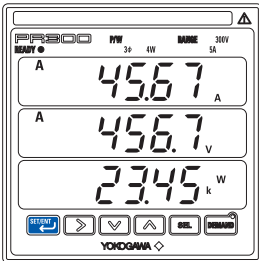

2 Hold down for at least 3 seconds.

VT Ratio screen

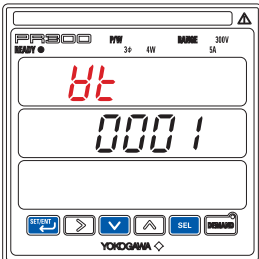

The parameter **Vt** (VT ratio) appears.

3 Simultaneously hold down + for at least 3 seconds.

Specification Change Confirmation screen



The Specification Change Confirmation screen appears.

4 Using or , show **YES** on the lower display.

Specification Change Confirmation screen



5 Press once.

Phase and Wire System screen

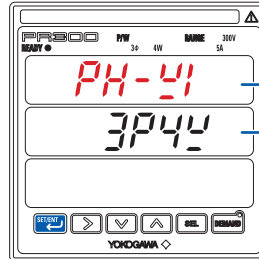

The Phase and Wire System screen appears.

Parameter symbol for phase and wire system

Current value

6 Press once.

Phase and Wire System Setting screen

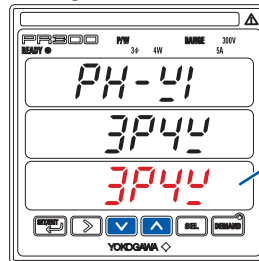

The Phase and Wire System Setting screen appears.

Setpoint

7 Using or , select the setpoint.

Phase and Wire System Setting screen

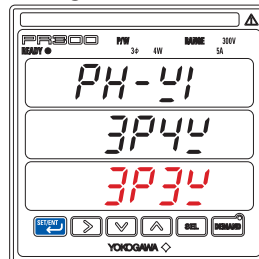

8 Press once to blink the setpoint.

Phase and Wire System Setting screen

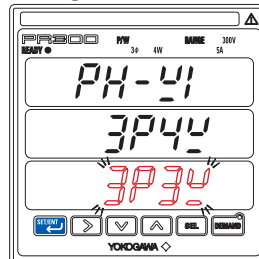

To re-set the parameter: Press any key other than

while all digits of the setpoint are blinking. The PR300 returns to the initial setting screen.

9 Press once while the setpoint is blinking.

The setpoint is confirmed and the PR300 returns to the Phase and Wire System screen. The phase and wire system thus set is shown as the current value.

Phase and Wire System screen

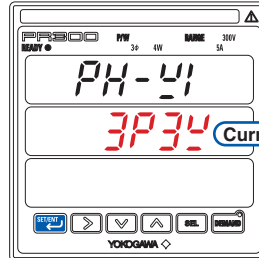

When proceeding to set the voltage range, start from step 6 in Section 2.3, "Setting the Voltage Range," with this screen (figure on the left) shown as is.

10 Hold down for at least 3 seconds.

Startup screen

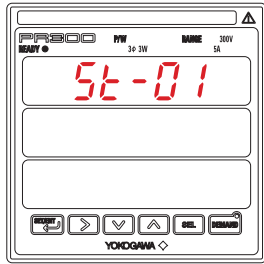

The PR300 shows the Startup screen for about 5 seconds, then the Measured Value screen appears.

Measured Value screen

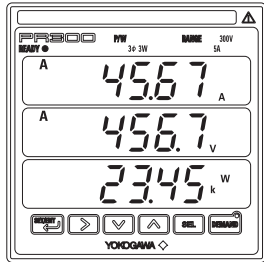

Setting completed.



NOTE

If you change the phase and wire system, all parameters other than those related to RS-485 and Ethernet communications are initialized (to factory-set values). Change the phase and wire system before setting parameters such as the VT and CT ratios.

Range of Phase and Wire System Options

Parameter Symbol	Parameter Name	Setting Type	Setting Range (Details)		Initial Value (Factory-set Value)	
			Model and Suffix Codes			
PH-41	Phase and wire system	Selection	PR300-3□□□□-6□-0	Single-phase two-wire system	1P2W	Three-phase three-wire system
				Single-phase three-wire system	1P3W	
				Three-phase three-wire system	3P3W	
			PR300-4□□□□-6□-0	Single-phase two-wire system	1P2W	Three-phase four-wire system
				Single-phase three-wire system	1P3W	
				Three-phase three-wire system	3P3W	
				Three-phase four-wire system	3P4W	
			PR300-5□□□□-6□-0	Three-phase four-wire system (2.5 element)	2.5E	Three-phase four-wire system (2.5 element)



NOTE

- If single-phase three-wire system is selected, the voltage range is fixed at 300 V (between P0 and P1, P0 and P2). The voltage range cannot be selected.
- Three-phase four-wire system (2.5 element) can be used only when the voltage is in a state of equilibrium. In addition, the phase and wire system cannot be changed.

2.3 Setting the Voltage Range

This section explains how to set the voltage range by taking as an example the case when the voltage range is changed from 300 V to 600 V.

Operation

Startup screen

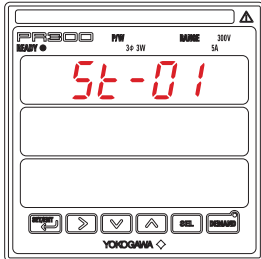

1 Turn on the PR300.

The PR300 shows the station number for about 5 seconds, then the Measured Value screen appears.

Measured Value screen

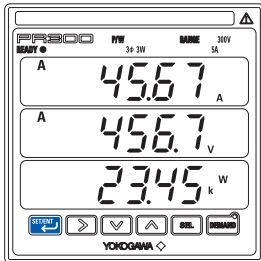

2 Hold down for at least 3 seconds.

VT Ratio screen

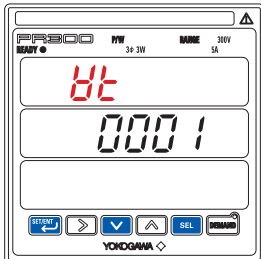

The parameter (VT ratio) appears.

3 Simultaneously hold down + for at least 3 seconds.

Specification Change Confirmation screen



The Specification Change Confirmation screen appears.

4 Using or , show on the lower display.

Specification Change Confirmation screen

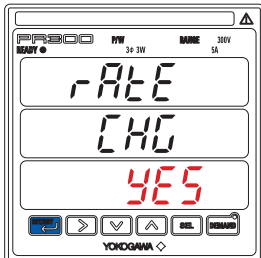

5 Press once.

Phase and Wire System screen

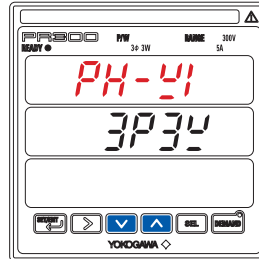

The Phase and Wire System screen appears.

6 Using or , show the Voltage Range screen.

Voltage Range screen

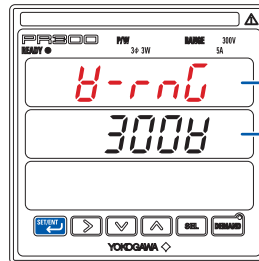

The Voltage Range screen appears.

Parameter symbol for voltage range

Current value

7 Press once.

Voltage Range Setting screen

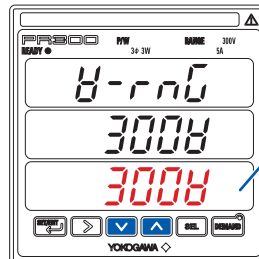

The Voltage Range Setting screen appears.

Setpoint

8 Using or , select the setpoint.

Voltage Range Setting screen

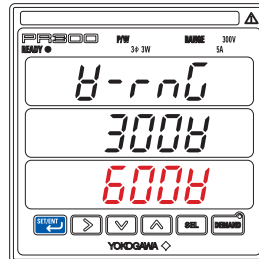

9 Press once to blink the setpoint.

Voltage Range Setting screen

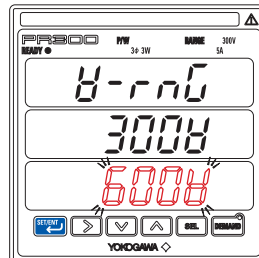

To re-set the parameter:
Press any key other than while all digits of the setpoint are blinking. The PR300 returns to the initial setting screen.

10 Press once while the setpoint is blinking.

Voltage Range screen

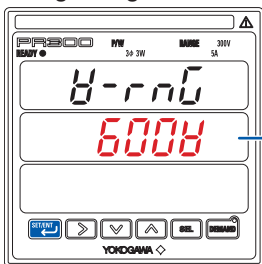

The setpoint is confirmed and the PR300 returns to the Voltage Range screen. The voltage range thus set is shown as the current value.

Current value

11 Hold down for at least 3 seconds.

When proceeding to set the phase and wire system, press or to show the Phase and Wire System screen, with this screen (figure in the upper-left corner) shown as is. After showing the Phase and Wire System screen, start from step 6 in Section 2.2, "Setting the Phase and Wire System."

Startup screen

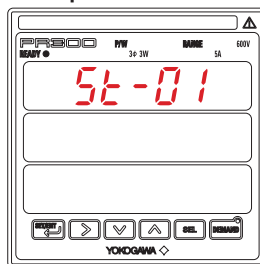

The PR300 shows the Startup screen for about 5 seconds, then the Measured Value screen appears.

Measured Value screen

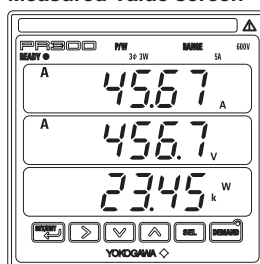

Setting completed.



NOTE

If you change the voltage range, all parameters other than those related to RS-485 and Ethernet communications are initialized (to factory-set values). Change the voltage range before setting parameters such as the VT and CT ratios.

Range of Voltage Range Options

Parameter Symbol	Parameter Name	Setting Type	Setting Range (Details)	Initial Value (Factory-set Value)
U-rnG	Voltage range	Selection	150V <i>150V</i>	300V
			300V <i>300V</i>	
			600V <i>600V</i>	



NOTE

- The voltage range of single-phase three-wire system is fixed at 300V (between P0 and P1, P0 and P2). The voltage range cannot be selected.
- Select the voltage range of three-phase four-wire system by the phase voltage (between P0 and P1, P0 and P2, P0 and P3).

3.1 Basic Parameter Setting Operations



NOTE

Set parameters only after setting the phase and wire system and the voltage range. If you change the phase and wire system or voltage range after setting a parameter, the parameter will be initialized (to a factory-set value). Parameters related to RS-485 and Ethernet communications will not be initialized, however.

Methods of Changing Parameter Setpoints

Four setting types - integral numeric value, fixed-point numeric value, floating-point numeric value, and selection - have been defined for the parameters of the PR300. For each setting type, the following explains basic operations used to set parameters.

Integral numeric value or fixed-point numeric value

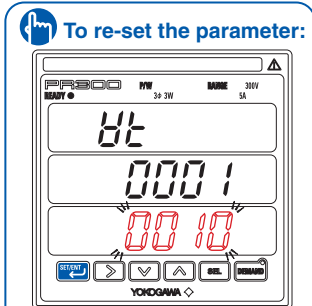
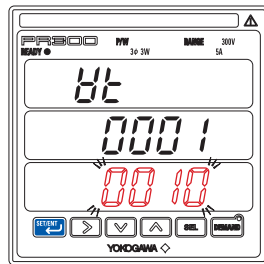
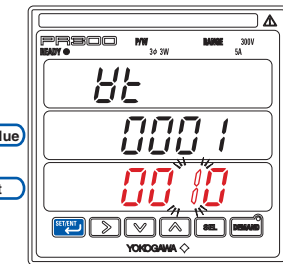
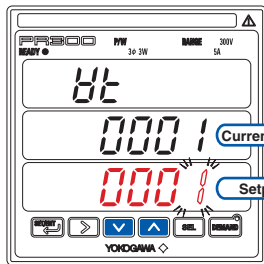

1 Using **[DOWN]** or **[UP]**, change the numeric value.
 To move to the digit to be changed, use the following keys:
[SEL] To the left
[RIGHT] To the right

2 After changing the numeric value, press **[SETPOINT]** once.
 This causes all digits of the setpoint to start blinking.

3 Press **[SETPOINT]** while all digits of the setpoint are blinking.
 This confirms the setpoint.

Floating-point numeric value

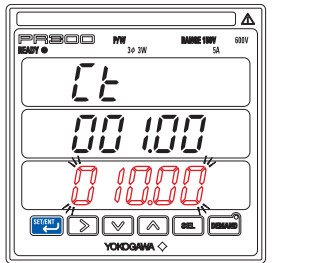
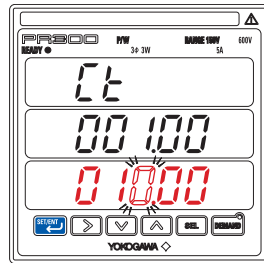
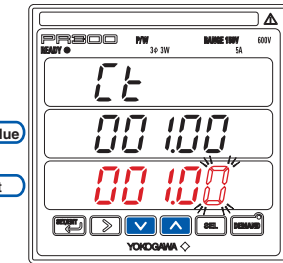
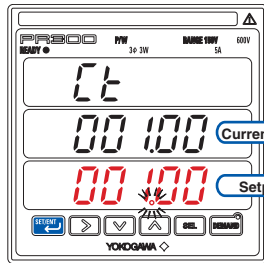

1 Using **[SETPOINT]**, confirm the number of decimal places.
 To move the decimal point, use the following keys:
[SEL] To the left
[RIGHT] To the right

2 Using **[DOWN]** or **[UP]**, change the numeric value.
 To move to the digit to be changed, use the following keys:
[SEL] To the left
[RIGHT] To the right

3 After changing the numeric value, press **[SETPOINT]** once.
 This causes all digits of the setpoint to start blinking.

4 Press **[SETPOINT]** while all digits of the setpoint are blinking.
 This confirms the setpoint.

Selection

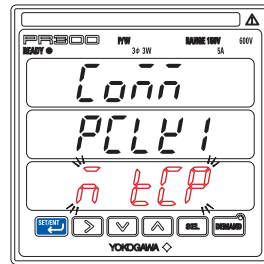
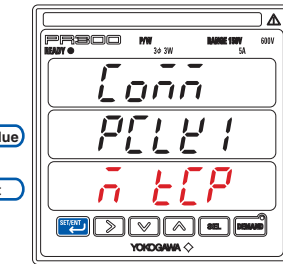
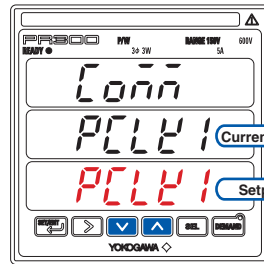

Key operations used to set parameters	
[SETPOINT]	Moves from the Measured Value screen to the Parameter screen (hold down the key), or confirms the setpoint.
[RIGHT]	Shows a parameter from the menu, moves through the digits of a setpoint (numeric value) to the right, or moves the decimal point to the right.
[DOWN]	Shows the next parameter or menu item, or changes the setpoint.
[UP]	Shows the previous parameter or menu item, or changes the setpoint.
[SEL]	Returns from the Parameter screen to the Menu screen, moves through the digits of a setpoint (numeric value) to the left, or moves the decimal point to the left.

1 Change the setpoint using **[DOWN]** or **[UP]**.

2 After changing the setpoint, press **[SETPOINT]** once.
 This causes all digits of the setpoint to start blinking.

3 Press **[SETPOINT]** while all digits of the setpoint are blinking.
 This confirms the setpoint.

3.2 Setting the VT and CT Ratios

Setting the VT Ratio

This section explains how to set the VT ratio by taking as an example the case when the VT ratio is changed from the initial value (1) to 4.

Operation

Measured Value screen

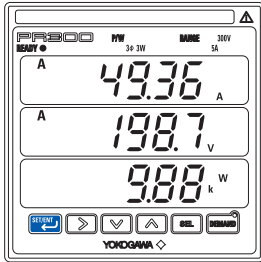

1 Hold down for at least 3 seconds.

VT Ratio screen

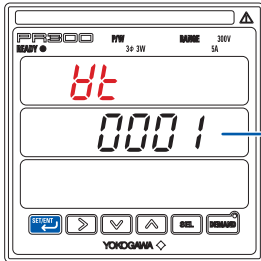

The parameter **vt** (VT ratio) appears.

Current value

2 Press once.

VT Ratio Setting screen

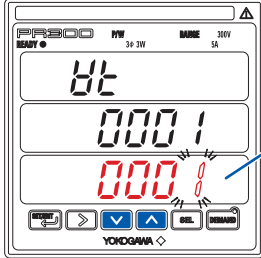

The screen changes to the one for setting the parameter **vt** and the alterable digit blinks.

Setpoint

3 Using or , change the setpoint.

VT Ratio Setting screen

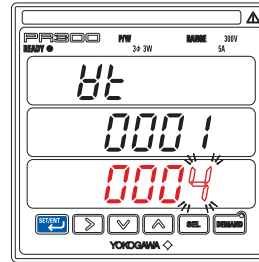

To move to the digit to be changed, use the following keys:
 To the left To the right

4 Press once to blink the setpoint.

VT Ratio Setting screen

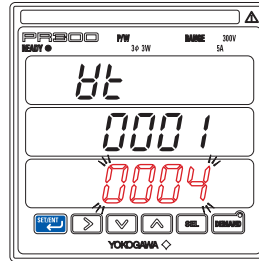

To re-set the parameter: Press any key other than while all digits of the setpoint are blinking. The PR300 returns to the initial setting screen.

5 Press once while the setpoint is blinking.

The setpoint is confirmed and the PR300 returns to the VT Ratio screen.

VT ratio setting completed.

To return to the Measured Value screen, hold down .

If you do not operate any key for more than 5 minutes on the Parameter screen, the PR300 automatically returns to the Measured Value screen.

When proceeding to set the CT ratio, press once and start from step **3** in "Setting the CT Ratio."

Parameter Setting Types and Ranges

Parameter Symbol	Parameter Name	Setting Type	Setting Range (Details)	Initial value (Factory-set Value)
vt	VT ratio	Integral numeric value	1 to 6000	1

Setting the CT Ratio

This section explains how to set the CT ratio by taking as an example the case when the CT ratio is changed from the initial value (1.00) to 10.00.

Operation

Measured Value screen

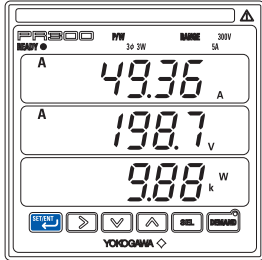

1 Hold down for at least 3 seconds.

VT Ratio screen

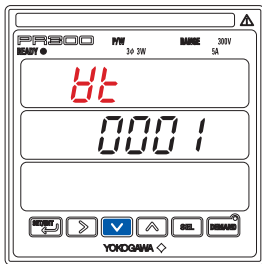

The parameter (VT ratio) appears.

2 Press once.

CT Ratio screen

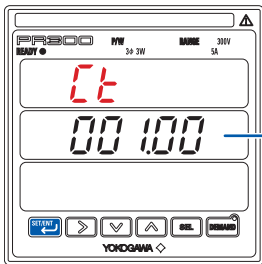

The parameter (CT ratio) appears.

3 Press once.

CT Ratio Setting screen

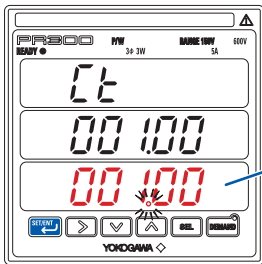

The screen changes to the one for setting the parameter and the decimal point blinks.

To move the decimal point, use the following keys:
 To the left To the right

4 Press once to fix the position of the decimal point.

CT Ratio Setting screen

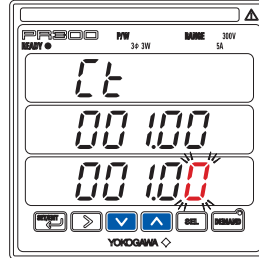

The alterable digit blinks.

5 Using or , change the setpoint.

CT Ratio Setting screen

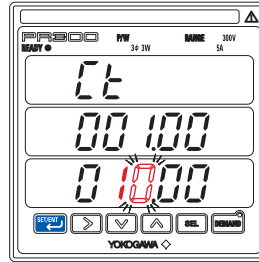

To move to the digit to be changed, use the following keys:
 To the left To the right

6 Press once to blink the setpoint.

CT Ratio Setting screen

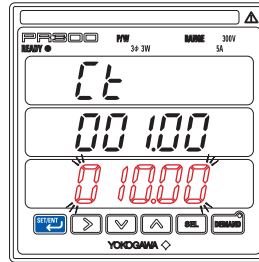

To re-set the parameter: Press any key other than while all digits of the setpoint are blinking. The PR300 returns to the initial setting screen.

7 Press once while the setpoint is blinking.

The setpoint is confirmed and the PR300 returns to the CT Ratio screen.

CT ratio setting completed.

To return to the Measured Value screen, hold down .

If you do not operate any key for more than 5 minutes on the Parameter screen, the PR300 automatically returns to the Measured Value screen.

Parameter Setting Types and Ranges

Parameter Symbol	Parameter Name	Setting Type	Setting Range (Details)	Initial Value (Factory-set Value)
	CT ratio	Floating-point numeric value	0.05 to 32000	1.00



NOTE

Set the VT and CT ratios so that the value of “secondary rated power × VT ratio × CT ratio” is smaller than 10 GW. If this value exceeds 10 GW, the updated VT or CT ratio will not be incorporated but revert to the current value before change.

3.3 Setting the Integrated Low-cut Power

This section explains how to set the integrated low-cut power by taking as an example the case when the integrated low-cut power is changed from the initial value (0.05%) to 0.1%.

Operation

Measured Value screen

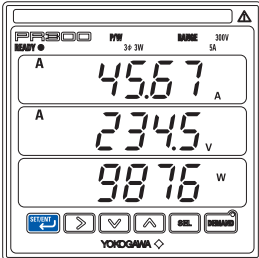

1 Hold down for at least 3 seconds.

VT Ratio screen

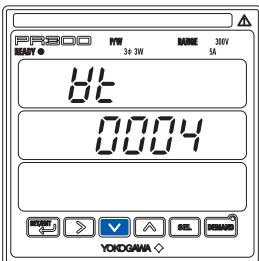

The parameter **vt** (VT ratio) appears.

2 Press twice.

Integrated Low-cut Power screen

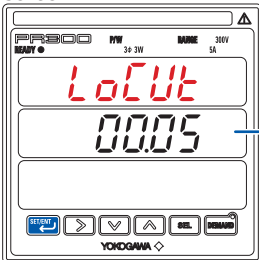

The parameter **LoCut** (integrated low-cut power) appears.

Current value

3 Press once.

Integrated Low-cut Power Setting screen

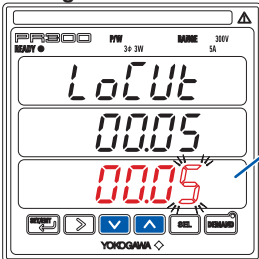

The screen changes to the one for setting the parameter **LoCut** and the alterable digit blinks.

Setpoint

4 Using or , change the setpoint.

Integrated Low-cut Power Setting screen

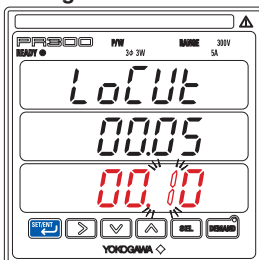

To move to the digit to be changed, use the following keys:

To the left

To the right

5 Press once to blink the setpoint.

Integrated Low-cut Power Setting screen

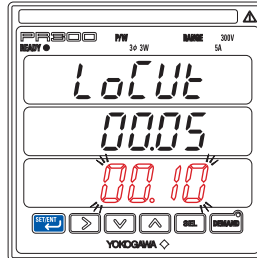

To re-set the parameter: Press any key other than while all digits of the setpoint are blinking. The PR300 returns to the initial setting screen.

6 Press once while the setpoint is blinking.

The setpoint is confirmed and the PR300 returns to the Integrated Low-cut Power screen.

Integrated low-cut power setting completed.

To return to the Measured Value screen, hold down .

If you do not operate any key for more than 5 minutes on the Parameter screen, the PR300 automatically returns to the Measured Value screen.

Parameter Setting Types and Ranges

Parameter Symbol	Parameter Name	Setting Type	Setting Range (Details)	Initial Value (Factory-set Value)
<i>LoCut</i>	Integrated low-cut power	Fixed-point numeric value	0.05 to 20.00 (%)	0.05

Integrated low-cut power

This parameter is used to prevent active power (regenerative power), reactive power (LEAD/LAG) and apparent power from being calculated as energy if they are smaller than the integrated low-cut power. Set this parameter as a percent (%) of the rated power.

3.4 Setting RS-485 Communication Conditions

This section explains how to set RS-485 communication conditions by taking as an example the case when the protocol is changed from the initial value to Modbus/RTU.

Operation

Measured Value screen

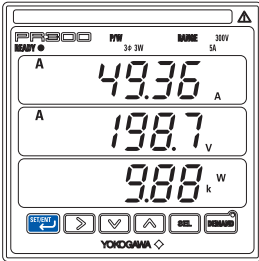

1 Hold down **SET/ENT** for at least 3 seconds.

VT Ratio screen

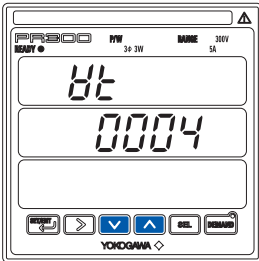

The parameter **vt** (VT ratio) appears.

2 Using **▲** or **▼**, show **r485**.

RS-485 Communication Menu screen

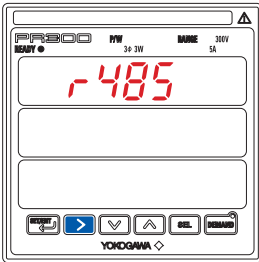

3 Press **▶** once.

Station Number screen

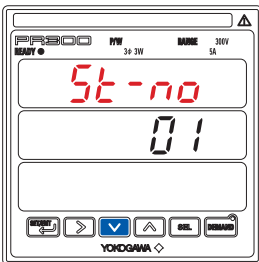

The parameter **St-no** (station number) appears.

4 Press **▼** once.

Protocol screen

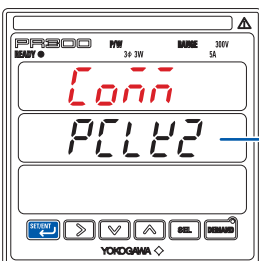

The parameter **Lon** (protocol) appears.

5 Press **SET/ENT** once.

Protocol Setting screen

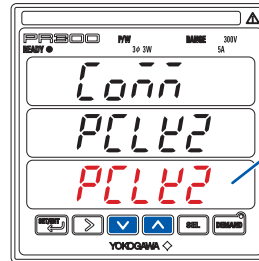

The screen changes to the one for setting the parameter **Lon**.

6 Using **▼** or **▲**, select the setpoint.

Protocol Setting screen

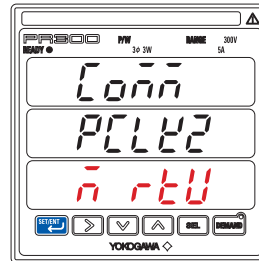

7 Press **SET/ENT** once to blink the setpoint.

Protocol Setting screen

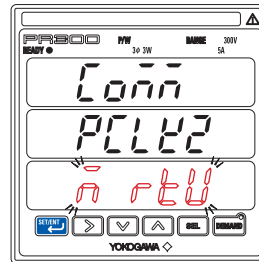

8 To re-set the parameter: Press any key other than **SET/ENT** while all digits of the setpoint are blinking. The PR300 returns to the initial setting screen.

8 Press **SET/ENT** once while the setpoint is blinking.

The setpoint is confirmed and the PR300 returns to the Protocol screen.

Protocol setting completed.

To return to the RS-485 Communication Menu screen, press **SEL**.

To return to the Measured Value screen, hold down **SET/ENT**.

If you do not operate any key for more than 5 minutes on the Parameter screen, the PR300 automatically returns to the Measured Value screen.

Protocol screen

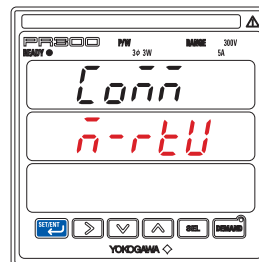

Each press of **▼** cycles through the parameter options, as shown below.

Refer to "Parameter Setting Types and Ranges" on the next page to set other parameters in the same manner.

Baud rate: **b-rt** Parity: **Pr** Stop bit: **StP** Data length: **dLn**



NOTE

- The Modbus/TCP protocol can only be selected for a PR300 with the Ethernet communication function.
- If the protocol is set to Modbus/TCP, the station number, baud rate, stop bit, and data length setpoints are fixed as shown below.
Station number = 01, Baud rate = 9600 bps, Stop bit = 1 bit, Data length = 8 bits

Parameter Setting Types and Ranges

Parameter Symbol	Parameter Name	Setting Type	Setting Range (Details)	Initial Value (Factory-set Value)
r485	RS-485 communication menu	—	Menu to shift to the parameters of RS-485 communication	—
St-no	Station number	Integral numeric value	1 to 99	1
Co nn	Protocol	Selection	PC link without checksum PCLK1 PC link with checksum PCLK2 Modbus/ASCII n ASC Modbus/RTU n rtu Modbus/TCP (*1) n tcp PR201 original Pr201	PC link with checksum
b-rt	Baud rate	Selection	2400 bps 2400 9600 bps 9600 19200 bps 19200	9600 bps
Pr1	Parity(*3)	Selection	NONE none EVEN EEn ODD odd	NONE
StP	Stop bit(*3)	Selection	1 bit 1 2 bits 2	1
dLn	Data length(*2)(*3)	Selection	8 bits 8 7 bits 7	8

*1 Modbus/TCP can be selected for a PR300 with the Ethernet communication function only.

*2 When Modbus/RTU is selected for the protocol, select 8 for the data length.

*3 When PR201 original is selected for the protocol, select NONE for the parity, 1 for the stop bit and 8 for the data length.

3.5 Setting Ethernet Communication Conditions

This section explains how to set Ethernet communication conditions by taking as an example the case when the IP address is changed from the initial value to "192.168.1.2". (Ethernet communication conditions can be set only when the protocol is set to Modbus/TCP. Refer to section 3.4.)

Operation

Measured Value screen

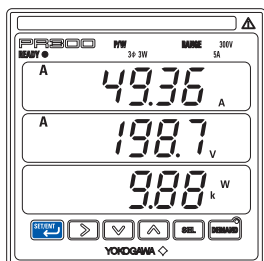

1 Hold down **SET/ENT** for at least 3 seconds.

VT Ratio screen

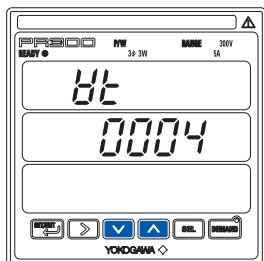

The parameter **Vt** (VT ratio) appears.

2 Using **▲** or **▼**, show **Ethr**.

Ethernet Communication Menu screen

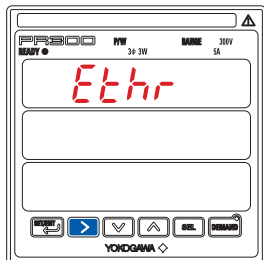

Ethernet Communication Menu screen appears only when the protocol is set to Modbus/TCP.

3 Press **▶** once.

IP Address-1 screen

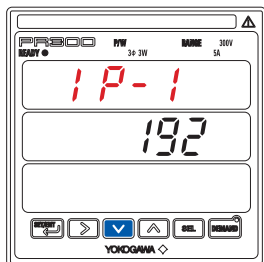

The parameter **IP-1** (IP address-1) appears.

4 Press **▼** three times.

IP Address-4 screen

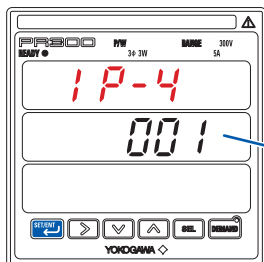

The parameter **IP-4** (IP address-4) appears.

The parameter options change as shown below.

IP-2 → **IP-3** → **IP-4**

Current value

5 Press **SET/ENT** once.

IP Address-4 Setting screen

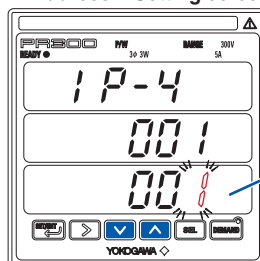

The screen changes to the one for setting the parameter **IP-4**.

Parameter **IP-1** **IP-2** **IP-3** **IP-4**
IP address 192.168.1.2

Setpoint

6 Using **▼** or **▲**, change the setpoint.

IP Address-4 Setting screen

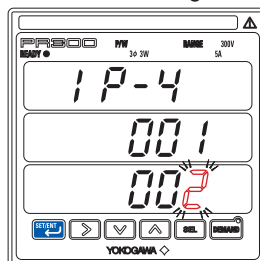

To move to the digit to be changed, use the following keys:

SEL **▶**
To the left To the right

7 Press **SET/ENT** once to blink the setpoint.

IP Address-4 Setting screen

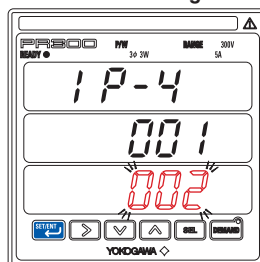

To re-set the parameter: Press any key other than **SET/ENT** while all digits of the setpoint are blinking. The PR300 returns to the initial setting screen.

8 Press **SET/ENT** once while the setpoint is blinking.

IP Address-4 screen

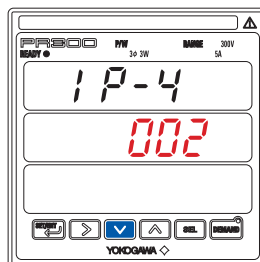

IP address setting completed.

To enable the parameter setting, execute step 9 on the next page.

Each press of **▼** cycles through the parameter options, as shown below.

Refer to "Parameter Setting Types and Ranges" on the next page to set other parameters in the same manner.

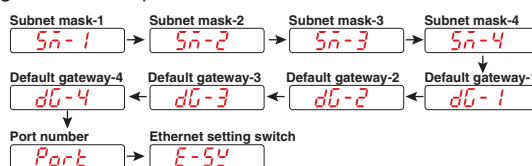

Ethernet setting switch

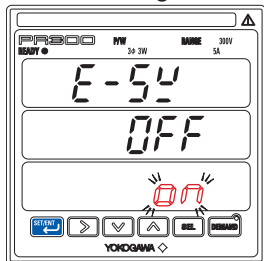

Set the Ethernet setting switch to ON to enable the new settings. When the settings have been updated, the switch is automatically set back to OFF.

Set the settings of parameter **E-54** to ON and press **SET/ENT** twice.

9

The parameter settings have been updated.

Ethernet setting switch

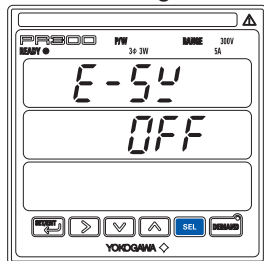

To return to the Ethernet Communication Menu screen, press **SEL**.

To return to the Measured Value screen, hold down **SET/ENT**.

If you do not operate any key for more than 5 minutes on the Parameter screen, the PR300 automatically returns to the Measured Value screen.



NOTE

- When using Ethernet communication, set the RS-485 communication protocol to Modbus/TCP (see Section 3.4).
- To be able to update the Ethernet parameter settings, the Ethernet setting switch must be set to ON.
- It takes about 20 seconds to update the setting. Ethernet communication cannot be used during this time.

Parameter Setting Types and Ranges

Parameter Symbol	Parameter Name	Setting Type	Setting Range (Details)	Initial Value (Factory-set Value)
<i>Ethr</i>	Ethernet communication menu	—	Menu to shift to the parameters of Ethernet communication	—
<i>IP-1</i>	IP address-1	Integral numeric value	0 to 255	192
<i>IP-2</i>	IP address-2		0 to 255	168
<i>IP-3</i>	IP address-3		0 to 255	1
<i>IP-4</i>	IP address-4		0 to 255	1
<i>Sn-1</i>	Subnet mask-1	Integral numeric value	0 to 255	255
<i>Sn-2</i>	Subnet mask-2		0 to 255	255
<i>Sn-3</i>	Subnet mask-3		0 to 255	255
<i>Sn-4</i>	Subnet mask-4		0 to 255	0
<i>dG-1</i>	Default gateway-1	Integral numeric value	0 to 255	0
<i>dG-2</i>	Default gateway-2		0 to 255	0
<i>dG-3</i>	Default gateway-3		0 to 255	0
<i>dG-4</i>	Default gateway-4		0 to 255	0
<i>Port</i>	Port number	Integral numeric value	502, 1024 to 65535	502
<i>E-54</i>	Ethernet setting switch	Selection	ON ----- OFF	—

3.6 Setting Pulse Output Conditions

This section explains how to set pulse output conditions by taking as an example the case when the ON pulse width is changed from the initial value to 100 ms.

Operation

Measured Value screen

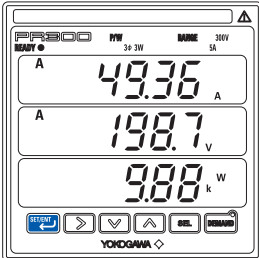

1 Hold down **SET/ENT** for at least 3 seconds.

VT Ratio screen

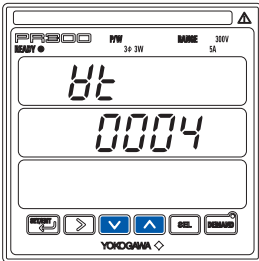

The parameter **VL** (VT ratio) appears.

2 Using **▲** or **▼**, show **PULSE**.

Pulse Output Menu screen

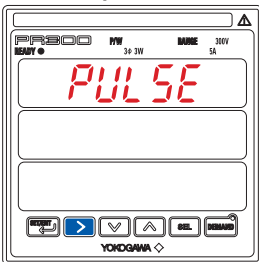

3 Press **▶** once.

Measurement Item for Pulse Output screen

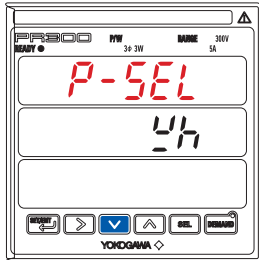

The parameter **P-SEL** (measurement item for pulse output) appears.

4 Press **▼** once.

Pulse Unit screen

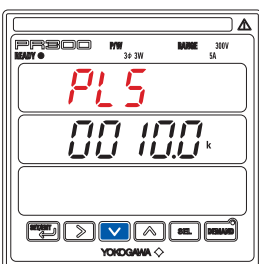

The parameter **PLS** (pulse unit) appears.

5 Press **▼** once.

ON Pulse Width screen

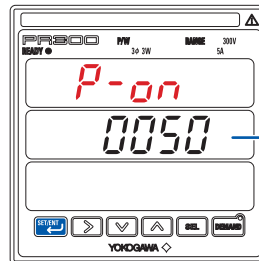

The parameter **P-on** (ON pulse width) appears.

Current value

6 Press **SET/ENT** once.

ON Pulse Width Setting screen

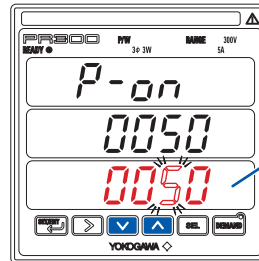

The screen changes to the one for setting the parameter **P-on** and the alterable digit blinks.

Setpoint

7 Using **▼** or **▲**, change the setpoint.

ON Pulse Width Setting screen

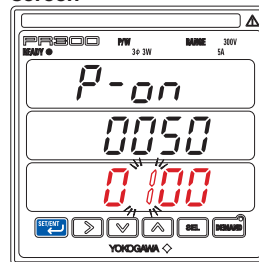

To move to the digit to be changed, use the following keys:



To the left To the right

8 Press **SET/ENT** once to blink the setpoint.

ON Pulse Width Setting screen

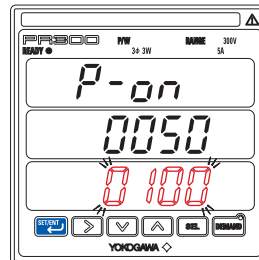

To re-set the parameter: Press any key other than **SET/ENT** while all digits of the setpoint are blinking. The PR300 returns to the initial setting screen.

9 Press **SET/ENT** once while the setpoint is blinking.

The setpoint is confirmed and the PR300 returns to the ON Pulse Width screen.

ON pulse width setting completed.

ON Pulse Width screen

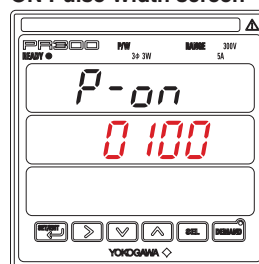

To return to the Pulse Output Menu screen, press **SEL**.

To return to the Measured Value screen, hold down **SET/ENT**.

If you do not operate any key for more than 5 minutes on the Parameter screen, the PR300 automatically returns to the Measured Value screen.



NOTE

If the pulse unit and ON pulse width do not satisfy the following conditional expression, the updated pulse unit setpoint or ON pulse width setpoint reverts to the value before change.

$$\text{ON pulse width [ms]} \leq \frac{\text{Pulse unit [kWh]} \times 3600 \times 1000^2}{\text{Primary rated power} \times 1.2 \times 2}$$

Parameter Setting Types and Ranges

Parameter Symbol	Parameter Name	Setting Type	Setting Range (Details)	Initial Value (Factory-set Value)
<i>PULSE</i>	Pulse output menu	—	Menu to shift to the parameters of pulse output	—
<i>P-SEL</i>	Measurement item for pulse output	Selection	Active energy <i>Wh</i>	Active energy
			Regenerative energy <i>-Wh</i>	
			LEAD reactive energy <i>-Varh</i>	
			LAG reactive energy <i>Varh</i>	
			Apparent energy <i>Varh</i>	
<i>PLS</i>	Pulse unit	Fixed-point numeric value	0.1 to 5000.0 k (/pulse)	1.0
<i>P-on</i>	ON pulse width	Integral numeric value	10 to 1270 (ms) (changeable in increments of 10 ms)	50

3.7 Setting Analog Output Conditions

This section explains how to set analog output conditions by taking as an example the case when the measurement item for analog output is changed to the current-1 and lower limit of scaling to 0% from their respective initial values.

Operation

Measured Value screen

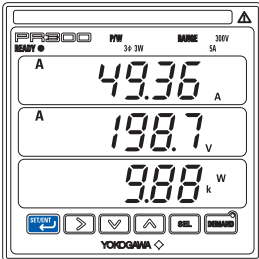

1 Hold down for at least 3 seconds.

VT Ratio screen

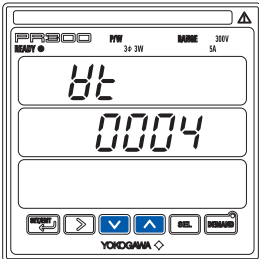

The parameter Vt (VT ratio) appears.

2 Using or , show $AnLoG$.

Analog Output Menu screen

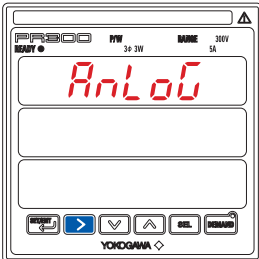

3 Press once.

Measurement Item for Analog Output screen

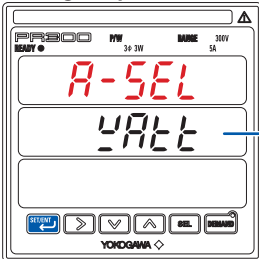

The parameter $A-SEL$ (measurement item for analog output) appears.

4 Press once.

Measurement Item for Analog Output Setting screen

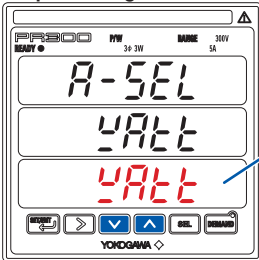

The screen changes to the one for setting the parameter $A-SEL$.

5 Using or , select the setpoint.

Measurement Item for Analog Output Setting screen

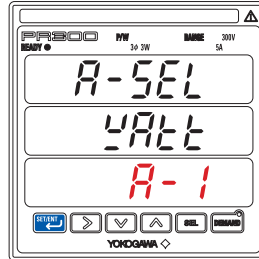

6 Press once to blink the setpoint.

Measurement Item for Analog Output Setting screen

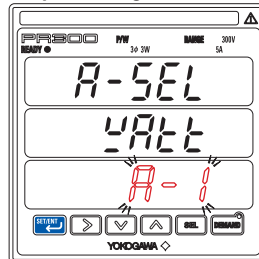

To re-set the parameter:
Press any key other than while all digits of the setpoint are blinking. The PR300 returns to the initial setting screen.

7 Press once while the setpoint is blinking.

The setpoint is confirmed and the PR300 returns to the Measurement Item for Analog Output screen.

Measurement item for analog output setting completed.

Measurement Item for Analog Output screen

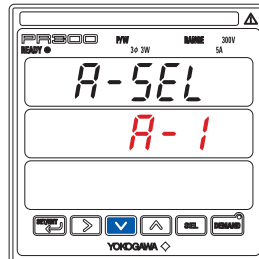

8 Press once.

Lower Limit of Scaling screen



The parameter $A-Lo$ (lower limit of scaling) appears.

9 Press once.

Lower Limit of Scaling Setting screen

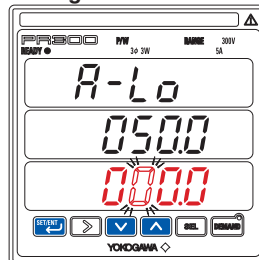

The screen changes to the one for setting the parameter $A-Lo$.

To move to the digit to be changed, use the following keys:

To the left To the right

10 Using or , change the setpoint. Press once.

Lower Limit of Scaling Setting screen



11 Press once while the setpoint is blinking.

The setpoint is confirmed and the PR300 returns to the Lower Limit of Scaling screen.

Lower Limit of Scaling screen

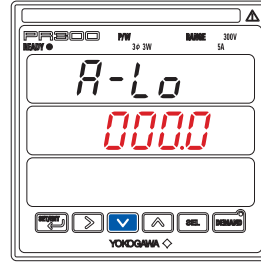

To change the upper limit of scaling, set a new limit using the parameter **A-HI** that follows.

Lower limit of scaling setting completed.

To return to the Analog Output Menu screen, press **SEL**.

To return to the Measured Value screen, hold down .

If you do not operate any key for more than 5 minutes on the Parameter screen, the PR300 automatically returns to the Measured Value screen.



NOTE

If the upper and lower limits of scaling do not satisfy the following conditional expression, the updated upper or lower limit of scaling setpoint will not be incorporated but revert to the value before change.

$$\text{Upper limit of scaling} - \text{Lower limit of scaling} \geq 50$$

Parameter Setting Types and Ranges

Parameter Symbol	Parameter Name	Setting Type	Setting Range (Details)	Initial Value (Factory-set Value)
AnLoG	Analog output menu	—	Menu to shift to the parameters of analog output	—
A-SEL	Measurement item for analog output	Selection	Active power WAr Reactive power VARr Apparent power VA Voltage-1 V-1 Voltage-2 V-2 Voltage-3 V-3 Current-1 A-1 Current-2 A-2 Current-3 A-3 Power factor PF Frequency FREQ	Active power
A-Lo	Lower limit of scaling	Fixed-point numeric value	0.0 to 50.0 (%)	50.0
A-HI	Upper limit of scaling	Fixed-point numeric value	50.0 to 100.0 (%)	100.0

Relationship between Scale Values and Measurement Inputs (Example)

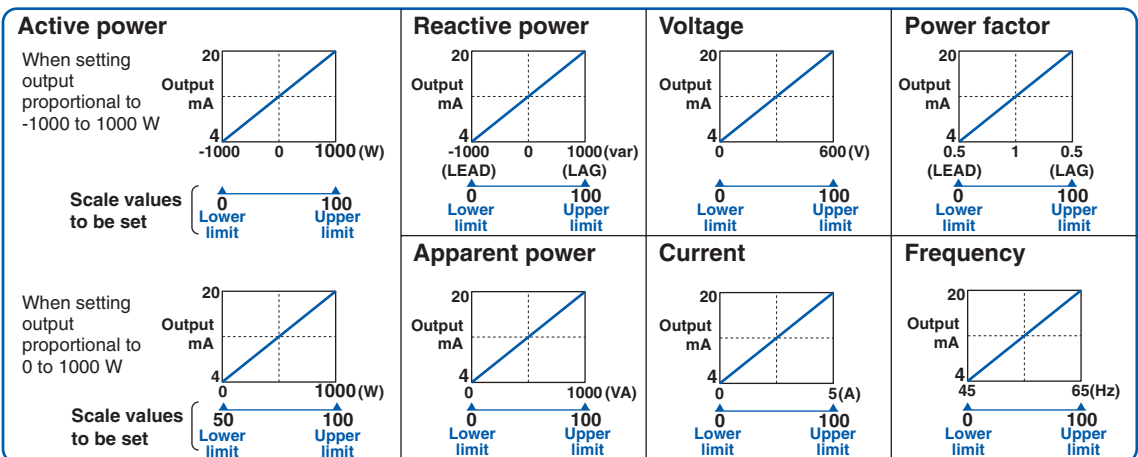

3.8 Setting Demand Measurement Conditions

This section explains how to set demand measurement conditions by taking as an example the case when the demand alarm point is changed to 300 kW and demand alarm release function to manual release, from their respective initial values.

Operation

Measured Value screen

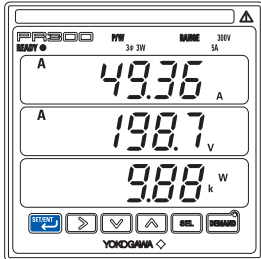

1 Hold down **SET/ENT** for at least 3 seconds.

VT Ratio screen

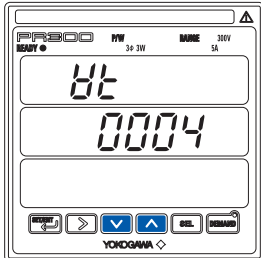

The parameter **vt** (VT ratio) appears.

2 Using **▲** or **▼**, show **dānd**.

Demand Measurement Menu screen



3 Press **▶** once.

Demand Power/Current screen

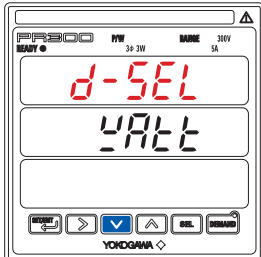

The parameter **d-SEL** (demand power/current) appears.

4 Press **▼** once.

Demand Period screen

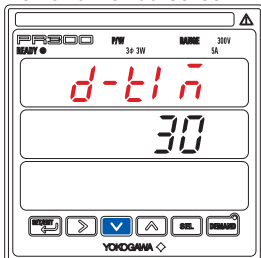

The parameter **d-tlā** (demand period) appears.

5 Press **▼** once.

Demand Alarm Mask Time screen

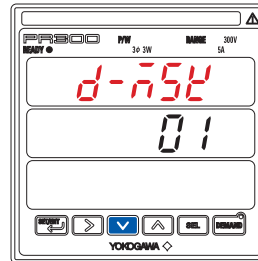

The parameter **d-āst** (demand alarm mask time) appears.

6 Press **▼** once.

Demand Alarm Point screen

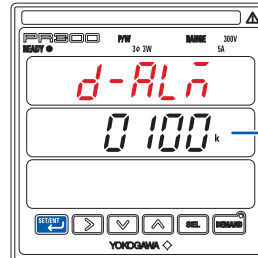

The parameter **d-ALā** (demand alarm point) appears.

Current value

7 Press **SET/ENT** once.

Demand Alarm Point Setting screen

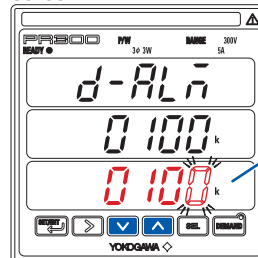

The screen changes to the one for setting the parameter **d-ALā**.

Setpoint

8 Using **▼** or **▲**, change the setpoint.

Demand Alarm Point Setting screen

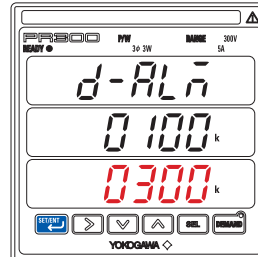

To move to the digit to be changed, use the following keys:
SEL To the left **▶** To the right

9 Press **SET/ENT** once to blink the setpoint.

Demand Alarm Point Setting screen

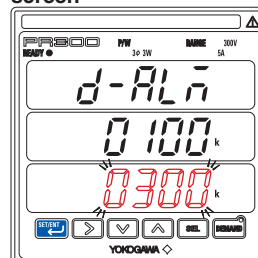

To re-set the parameter: Press any key other than **SET/ENT** while all digits of the setpoint are blinking. The PR300 returns to the initial setting screen.

10 Press **SET/ENT** once while the setpoint is blinking.

Demand Alarm Point screen

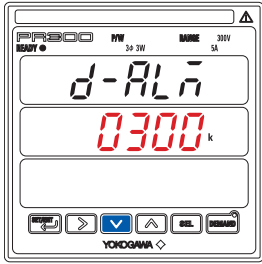

The setpoint is confirmed and the PR300 returns to the Demand Alarm Point screen.

Demand alarm point setting completed.

11 Press once.

Demand Alarm Release Function screen



The parameter $d-rSt$ (demand alarm release function) appears.

12 Press once.

Demand Alarm Release Function Setting screen

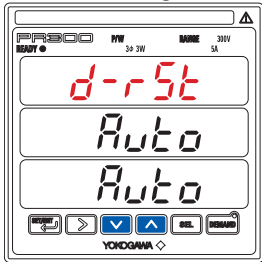

The screen changes to the one for setting the parameter $d-rSt$.

13 Using or , select the setpoint.

Demand Alarm Release Function Setting screen

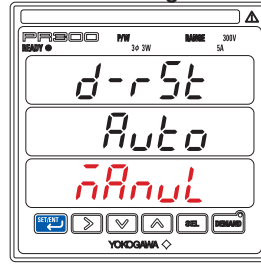

14 Press once to blink the setpoint.

Demand Alarm Release Function Setting screen

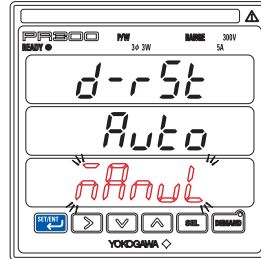

15 Press once while the setpoint is blinking.

The setpoint is confirmed and the PR300 returns to the Demand Alarm Release Function screen.

Demand alarm release function setting completed.

- To return to the Demand Measurement Menu screen, press .
- To return to the Measured Value screen, hold down .
- If you do not operate any key for more than 5 minutes on the Parameter screen, the PR300 automatically returns to the Measured Value screen.



NOTE

If the demand period and demand alarm mask time do not satisfy the following conditional expression, the updated demand period or demand alarm mask time will not be incorporated but revert to the value before change.

$$\text{Demand alarm mask time} \leq \text{Demand period}$$

Parameter Setting Types and Ranges

Parameter Symbol	Parameter Name	Setting Type	Setting Range (Details)	Initial Value (Factory-set Value)
$d\bar{n}nd$	Demand measurement menu	—	Menu to shift to the parameters of demand measurement	—
$d-SEL$	Demand power/current	Selection	Active power WAt Current A	Active power
$d-tln$	Demand period	Integral numeric value	1 to 60 (min) (Demand alarm mask time to 60) (min)	30
$d-nSt$	Demand alarm mask time	Integral numeric value	1 to 59 (min) (1 to demand period) (min)	1
$d-ALn$	Demand alarm point	Integral numeric value	1 to 1000 (kW): When active power is selected, or 1 to 1000 (A): When current is selected	100
$d-rSt$	Demand alarm release function	Selection	Automatic release $Auto$ Manual release $nAnul$	Automatic release

3.9 Setting the Measured Value Display Pattern

This section explains how to set the measured value display pattern by taking as an example the case when the number of display patterns is changed to 3 and the display pattern-1 upper display to maximum demand value, from their respective initial values.

Operation

Measured Value screen

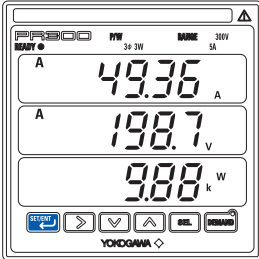

1 Hold down for at least 3 seconds.

VT Ratio screen

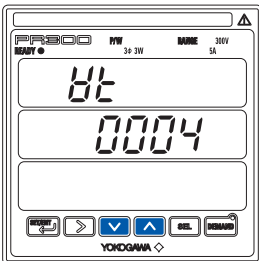

The parameter (VT ratio) appears.

2 Using or , show .

Display Setting Menu screen

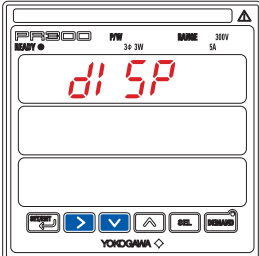

3 Press once.
Press twice.

Number of Display Patterns screen

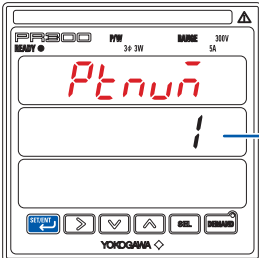

The parameter (number of display patterns) appears.

4 Press once.

Number of Display Patterns Setting screen

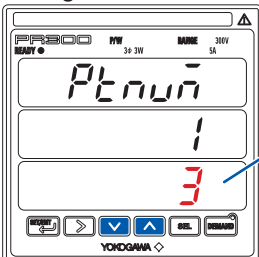

The screen changes to the one for setting the parameter .

5 Using or , select the setpoint.
Press once to blink the setpoint.

Number of Display Patterns Setting screen

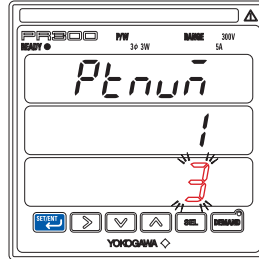

6 To re-set the parameter: Press any key other than while all digits of the setpoint are blinking. The PR300 returns to the initial setting screen.

6 Press once while the setpoint is blinking.

The setpoint is confirmed and the PR300 returns to the Number of Display Patterns screen.

Number of display patterns setting completed.

Number of Display Patterns screen

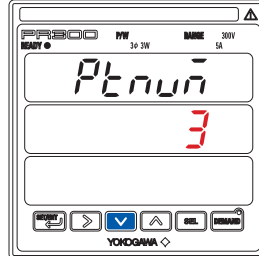

7 Press once.

Display Pattern-1 Upper Display screen

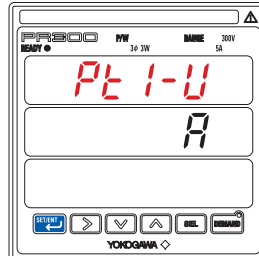

The parameter (display pattern-1 upper display) appears.

8 Press once.

Display Pattern-1 Upper Display Setting screen

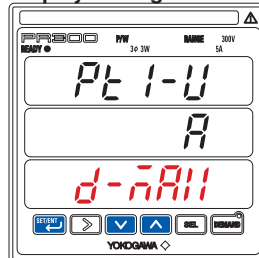

The screen changes to the one for setting the parameter .

9 Using or , select the setpoint.
Press once to blink the setpoint.

Display Pattern-1 Upper Display Setting screen

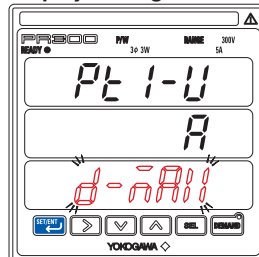

10 Press once while the setpoint is blinking.

Display Pattern-1 Upper Display screen

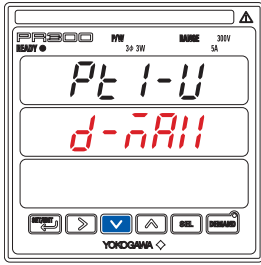

The setpoint is confirmed and the PR300 returns to the Display Pattern-1 Upper Display screen.

Display pattern-1 upper display setting completed.

11 Press once.

Display Pattern-1 Middle Display screen



The parameter *Pt 1-n* (display pattern-1 middle display) appears.

Refer to steps **8, 9** and **10** to also set other display patterns.

Display Pattern-1 Lower Display screen

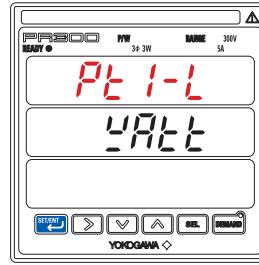

- To return to the Display Setting Menu screen, press .
- To return to the Measured Value screen, hold down .
- If you do not operate any key for more than 5 minutes on the Parameter screen, the PR300 automatically returns to the Measured Value screen.

Parameter Setting Types and Ranges

Parameter Symbol	Parameter Name	Setting Type	Setting Range (Details)	Initial Value (Factory-set Value)
<i>dI SP</i>	Display setting menu	—	Menu to shift to the parameters of display setting	—
<i>Pt n u n̄</i>	Number of display patterns	Integral numeric value	1 to 8	1
<i>Pt 1-U</i>	Display pattern-1 upper display	Selection	A measurement item can be selected from the following: None <i>none</i> Active energy <i>yh</i> Regenerative energy <i>-yh</i> LEAD reactive energy <i>-yArh</i> LAG reactive energy <i>yArh</i>	Current (phase switch indication)
<i>Pt 1-n̄</i>	Display pattern-1 middle display			Voltage (phase switch indication)
<i>Pt 1-L</i>	Display pattern-1 lower display			Active power
<i>Pt 2-U</i>	Display pattern-2 upper display			Selection
<i>Pt 2-n̄</i>	Display pattern-2 middle display	Reactive power		
<i>Pt 2-L</i>	Display pattern-2 lower display	Power factor		
<i>Pt 3-U</i>	Display pattern-3 upper display	Selection	Voltage-2 <i>h-2</i> Voltage-3 <i>h-3</i> Current (phase switch indication) <i>A</i> Current-1 <i>A-1</i> Current-2 <i>A-2</i> Current-3 <i>A-3</i>	Active energy
<i>Pt 3-n̄</i>	Display pattern-3 middle display			LEAD reactive energy
<i>Pt 3-L</i>	Display pattern-3 lower display			Apparent energy
<i>Pt 4-U</i>	Display pattern-4 upper display	Selection	Power factor <i>PF</i> Frequency <i>FrEQ</i> Optional active energy <i>yhoP</i> Demand value <i>d-nnd</i> Maximum demand value <i>d-nAll</i>	Current-1
<i>Pt 4-n̄</i>	Display pattern-4 middle display			Current-2
<i>Pt 4-L</i>	Display pattern-4 lower display			Current-3

- Continued to next page -

Parameter Setting Types and Ranges (Continued)

Parameter Symbol	Parameter Name	Setting Type	Setting Range (Details)	Initial Value (Factory-set Value)		
Pt5-U	Display pattern-5 upper display	Selection	A measurement item can be selected from the following:	Voltage-1		
	Pt5-M		Display pattern-5 middle display		None none	Voltage-2
			Pt5-L		Display pattern-5 lower display	
Pt6-U	Display pattern-6 upper display	Selection		Regenerative energy -Wh	Current (phase switch indication)	
	Pt6-M		Display pattern-6 middle display	LEAD reactive energy -VARh		Voltage (phase switch indication)
Pt6-L		Display pattern-6 lower display	Selection	LAG reactive energy VARh	Frequency	
	Pt7-U	Display pattern-7 upper display		Selection		Apparent energy VARh
Pt7-M		Display pattern-7 middle display	Active power WATT		Active power	
		Pt7-L	Display pattern-7 lower display			Reactive power VAR
Pt8-U	Display pattern-8 upper display		Selection	Apparent power VA	Active power	
	Pt8-M	Display pattern-8 middle display		Voltage (phase switch indication) V		Maximum demand value
		Pt8-L		Display pattern-8 lower display		
Pt7-M	Display pattern-7 middle display		Selection	Voltage-2 V-2	Active power	
		Pt7-L		Display pattern-7 lower display		Selection
Pt8-M	Display pattern-8 middle display		Selection		Current (phase switch indication) A	
		Pt8-L		Display pattern-8 lower display	Selection	Current-1 A-1
Pt8-M	Display pattern-8 middle display		Selection			Current-2 A-2
		Pt8-L		Display pattern-8 lower display	Selection	Current-3 A-3
Pt8-M	Display pattern-8 middle display		Selection			Power factor PF
		Pt8-L		Display pattern-8 lower display	Selection	Frequency FREQ
Pt8-M	Display pattern-8 middle display		Selection			Optional active energy WhoP
		Pt8-L		Display pattern-8 lower display	Selection	Demand value dAND
Pt8-M	Display pattern-8 middle display		Selection			Maximum demand value d-ALL
		Pt8-L		Display pattern-8 lower display	Selection	

Number of Display Patterns and Individual Display Patterns

Allocate desired measurement items to the upper, middle and lower displays of the PR300, respectively, to define the display view as a single display pattern. It is possible to define a maximum of 8 patterns. For the number of display patterns, specify how many of these defined display patterns the PR300 should show.



NOTE

- As shown in the table below, some measurement items cannot be measured depending on the type of phase and wire system. Measurement items that cannot be measured cannot be selected as options for a display pattern.
- In the case of a three-phase four-wire system, the initial values of Display patterns-1 to 8 can all be shown on the PR300. For phase and wire systems other than a three-phase four-wire system, measurement items that cannot be measured are shown as “none”.

Phase and wire system	Single-phase two-wire system	Single-phase three-wire system	Three-phase three-wire system	Three-phase four-wire system	Three-phase four-wire system (2.5 element)
Measurement item (phase switch indication)	-	✓	✓	✓	✓ *1
Current-1	✓	✓	✓	✓	✓ *1
Current-2	-	✓	-	✓	-
Current-3	-	-	✓	✓	✓ *1
Voltage-2	-	✓	-	✓	-
Voltage-3	-	-	✓	✓	✓

✓: Measurable. -: Not measurable.

*1 For a three-phase four-wire system (2.5 element), it is possible to set the following measurement items only when the current is in a state of equilibrium:
 Current (phase switch indication), Current-1, Current-3, Reactive power, Apparent power, Power factor, LEAD reactive energy, LAG reactive energy, and Apparent energy.

- The demand value and maximum demand value can only be selected for a PR300 with the demand measuring function. For a PR300 without the demand measuring function, the initial values of demand value and maximum demand value are shown as “none”.

3.10 Setting the “Indicator-out” Mode and Locking Parameters

Setting the Indicator-out Mode

This section explains how to set the indicator-out mode by taking as an example the case when the indicator-out mode is changed to ON and the indicator-out mode wait time to 5 min, from their respective initial values.

Operation

Measured Value screen

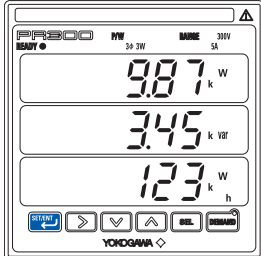

1 Hold down for at least 3 seconds.

VT Ratio screen

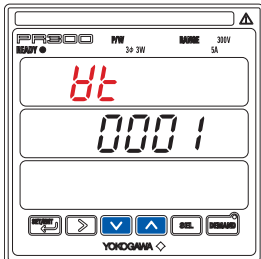

The parameter Vt (VT ratio) appears.

2 Using or , show $diSP$.

Display Setting Menu screen

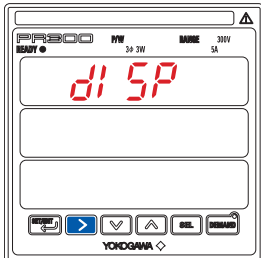

3 Press once.

Indicator-out Mode screen

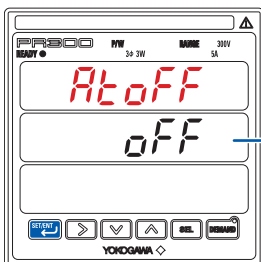

The parameter $AltoFF$ (Indicator-out mode) appears.

4 Press once.

Indicator-out Mode Setting screen

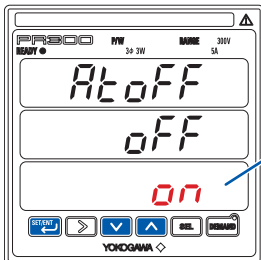

The screen changes to the one for setting the parameter $AltoFF$.

5 Using or , select the setpoint. Press once blink the setpoint.

Indicator-out Mode Setting screen

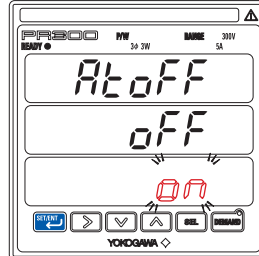

6 To re-set the parameter: Press any key other than while all digits of the setpoint are blinking. The PR300 returns to the initial setting screen.

6 Press once while the setpoint is blinking.

The setpoint is confirmed and the PR300 returns to the Indicator-out Mode screen.

Indicator-out mode setting completed.

Indicator-out Mode screen

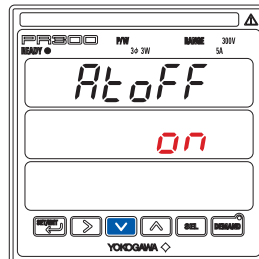

7 Press once.

Indicator-out Mode Wait Time screen

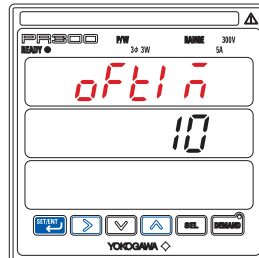

Parameter $offti n$ (indicator-out mode wait time) is displayed.

8 Press once.

Indicator-out Mode Wait Time Setting screen

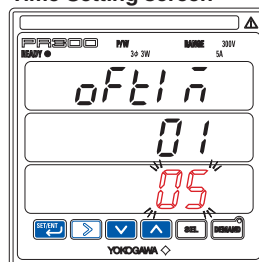

The screen changes into a screen for setting parameter $offti n$.

Using or , change the setpoint.

Press once to blink the setpoint.

9 Press once while the setpoint is blinking.

The setpoint is confirmed and the PR300 returns to the Indicator-out Mode Wait Time screen.

Indicator-out mode wait time setting completed.

To return to the Display Setting Menu screen, press .

To return to the Measured Value screen, hold down .

If you do not operate any key for more than 5 minutes on the Parameter screen, the PR300 automatically returns to the Measured Value screen.

Parameter Setting Types and Ranges

Parameter Symbol	Parameter Name	Setting Type	Setting Range (Details)	Initial Value (Factory-set Value)
<i>di SP</i>	Display setting menu	—	Menu to shift to the parameters of display setting	—
<i>AtOFF</i>	Indicator-out mode	Selection	ON <i>on</i> OFF <i>off</i>	OFF
<i>oftl n</i>	Indicator-out mode wait time	Integral numeric value	1 to 60 (min)	10 (min)

Indicator-out mode

The indicator-out mode is designed to turn off the PR300 display when no key operation is performed within the indicator-out mode wait time that has been set while measured values are on display. The PR300 switches to the Measured Value screen in about 5 minutes when no key operation is performed while the Parameter screen is on display. Then, the PR300 display turns off after the elapse of the indicator-out mode wait time from when the PR300 switched to the Measured Value screen. To turn on the PR300 display to show measured values during indicator-out mode, press any key.

Locking and Unlocking Parameters

Executing the following operations locks or unlocks all parameters. (A parameter cannot be locked or unlocked individually.) If a parameter is locked, it will be impossible to shift to the Parameter Setting screen. Use the Parameter screen showing the current value or the Menu screen to lock or unlock parameters. Operations used on an individual parameter setting screen or on the Measured Value screen in an attempt to lock parameters will have no effect.

Locking Parameters

Operation

Measured Value screen

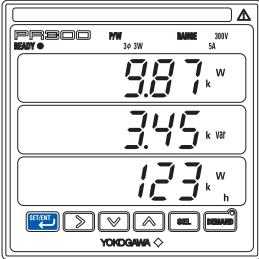

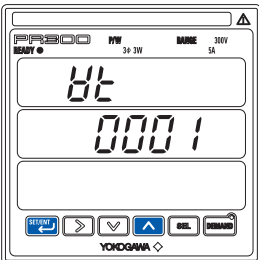

1 Hold down  for at least 3 seconds.

VT Ratio screen



The parameter *vt* (VT ratio) appears.

2 Simultaneously hold down  and  for at least 5 seconds.

The measured value display (middle display) first shows *Lock*, then returns to the Parameter screen.

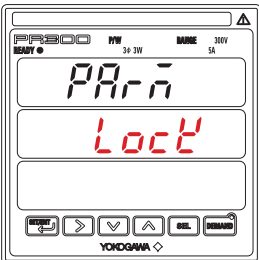



All parameters are locked now. Pressing  will no longer switch the display to any parameter setting screen.

Unlocking Parameters

Operation

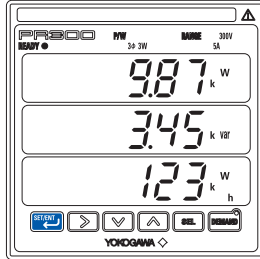
Measured Value screen



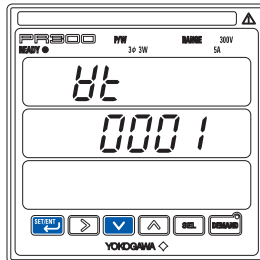

1 Hold down  for at least 3 seconds.

VT Ratio screen



The parameter *vt* (VT ratio) appears.

2 Simultaneously hold down  and  for at least 5 seconds.

The measured value display (middle display) first shows *Free*, then returns to the Parameter screen.



All parameters are unlocked now.

4.1 Measurement Items

✓ : Measurable, – : Not measurable

Measurement items			Single-phase two-wire system	Single-phase three-wire system	Three-phase three-wire system	Three-phase four-wire system	Three-phase four-wire system (2.5 element)	Unit and symbol
Active energy (+) *1			✓	✓	✓	✓	✓	kWh/MWh
Active energy (-) (regenerative energy) *1			✓	✓	✓	✓	✓	-kWh/-MWh
LEAD reactive energy (-) *1			✓	✓	✓	✓	✓	-kvarh/-Mvarh
LAG reactive energy (+) *1			✓	✓	✓	✓	✓	kvarh/Mvarh
Apparent energy *1			✓	✓	✓	✓	✓	kVAh/MVAh
Optional active energy *1			✓	✓	✓	✓	✓	Wh
Active power			✓	✓	✓	✓	✓	W/kW/MW
Instantaneous value	Maximum value	Minimum value						
Reactive power			✓	✓	✓	✓	✓	var/kvar/Mvar
Instantaneous value	Maximum value	Minimum value						
Apparent power			✓	✓	✓	✓	✓	VA/kVA/MVA
Instantaneous value	Maximum value	Minimum value						
Voltage-1			✓	✓	✓	✓	✓	V/kV
Instantaneous value	Maximum value	Minimum value						
Voltage-2			–	✓	–	✓	–	
Instantaneous value	Maximum value	Minimum value						
Voltage-3			–	–	✓	✓	✓	
Instantaneous value	Maximum value	Minimum value						
Current-1			✓	✓	✓	✓	✓	A/kA
Instantaneous value	Maximum value							
Current-2			–	✓	–	✓	–	
Instantaneous value	Maximum value							
Current-3			–	–	✓	✓	✓	
Instantaneous value	Maximum value							
Frequency			✓	✓	✓	✓	✓	Hz
Instantaneous value	Maximum value	Minimum value						
Power factor			✓	✓	✓	✓	✓	COS ϕ
Instantaneous value	Maximum value	Minimum value						
Demand power *2			✓	✓	✓	✓	✓	W/kW/MW
Demand current-1 *2			✓	✓	✓	✓	✓	A/kA
Demand current-2 *2			–	✓	–	✓	–	
Demand current-3 *2			–	–	✓	✓	✓	

*1: An integrated low-cut power can be set to the energy parameters listed in the table (refer to Section 3.3).
 *2: Either the demand power or demand current can be set as a measurement item.



NOTE

When the current is in a state of equilibrium, the three-phase four-wire system (2.5 element) can measure the following items: LEAD reactive energy, LAG reactive energy, Apparent energy, Reactive power, Apparent power, Current-1, Current-3, Power factor, Demand current-1, and Demand current-3.

4.2 Switching Display Pattern

According to Display patterns-1 to 8, the PR300 can change the measurement items to be assigned to the upper, middle, and lower displays (refer to Section 3.9, "Setting the Measured Value Display Pattern"). The procedure to change the display pattern and initial values are explained below.

Switching Display Pattern

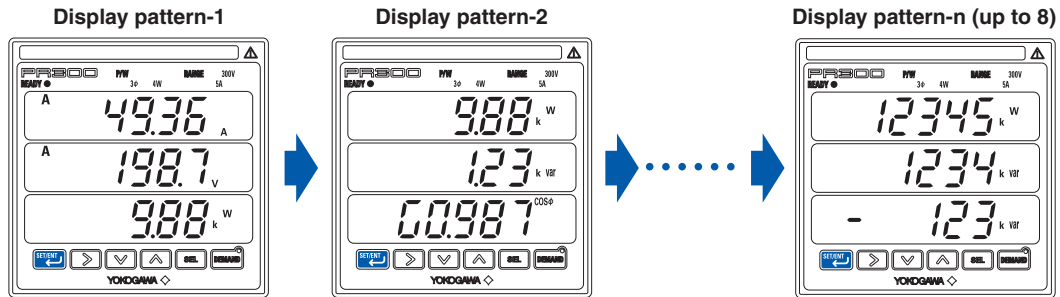

The initial value is "Display pattern-1," and the display pattern number will be incremented by 1 every time  is pressed. After the number reaches n, it will return to 1.

Initial Values and Example Display Patterns

Initial value of the number of display patterns: 1 (Only display pattern-1 appears.)

Initial value of each display pattern:

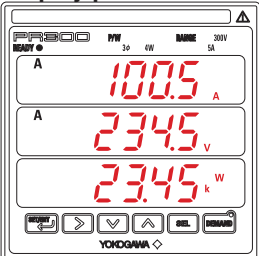
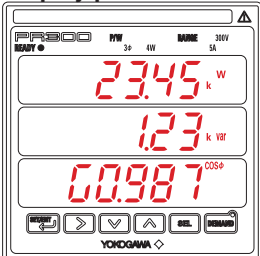
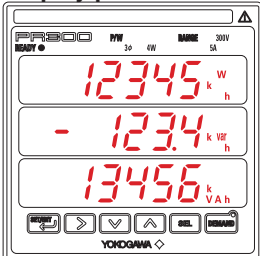
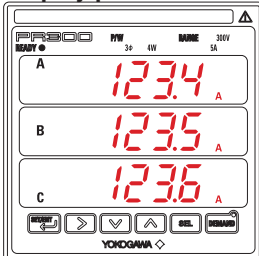
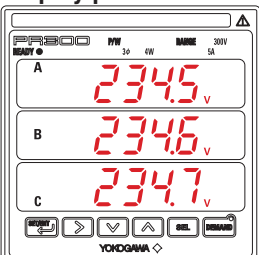
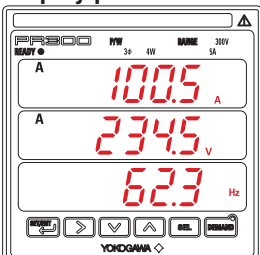
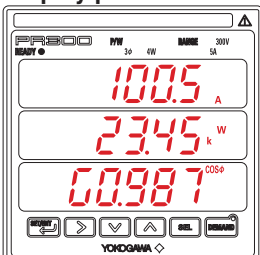
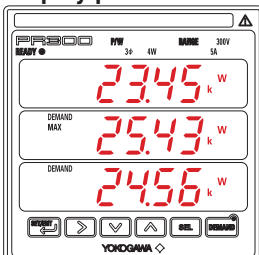
 <table border="1"> <tr><td>Upper display</td><td>Current (phase switch indication)</td></tr> <tr><td>Middle display</td><td>Voltage (phase switch indication)</td></tr> <tr><td>Lower display</td><td>Active power</td></tr> </table>	Upper display	Current (phase switch indication)	Middle display	Voltage (phase switch indication)	Lower display	Active power	 <table border="1"> <tr><td>Upper display</td><td>Active power</td></tr> <tr><td>Middle display</td><td>Reactive power</td></tr> <tr><td>Lower display</td><td>Power factor</td></tr> </table>	Upper display	Active power	Middle display	Reactive power	Lower display	Power factor	 <table border="1"> <tr><td>Upper display</td><td>Active energy</td></tr> <tr><td>Middle display</td><td>LEAD reactive energy</td></tr> <tr><td>Lower display</td><td>Apparent energy</td></tr> </table>	Upper display	Active energy	Middle display	LEAD reactive energy	Lower display	Apparent energy	 <table border="1"> <tr><td>Upper display</td><td>Current-1</td></tr> <tr><td>Middle display</td><td>Current-2</td></tr> <tr><td>Lower display</td><td>Current-3</td></tr> </table>	Upper display	Current-1	Middle display	Current-2	Lower display	Current-3
Upper display	Current (phase switch indication)																										
Middle display	Voltage (phase switch indication)																										
Lower display	Active power																										
Upper display	Active power																										
Middle display	Reactive power																										
Lower display	Power factor																										
Upper display	Active energy																										
Middle display	LEAD reactive energy																										
Lower display	Apparent energy																										
Upper display	Current-1																										
Middle display	Current-2																										
Lower display	Current-3																										
 <table border="1"> <tr><td>Upper display</td><td>Voltage-1</td></tr> <tr><td>Middle display</td><td>Voltage-2</td></tr> <tr><td>Lower display</td><td>Voltage-3</td></tr> </table>	Upper display	Voltage-1	Middle display	Voltage-2	Lower display	Voltage-3	 <table border="1"> <tr><td>Upper display</td><td>Current (phase switch indication)</td></tr> <tr><td>Middle display</td><td>Voltage (phase switch indication)</td></tr> <tr><td>Lower display</td><td>Frequency</td></tr> </table>	Upper display	Current (phase switch indication)	Middle display	Voltage (phase switch indication)	Lower display	Frequency	 <table border="1"> <tr><td>Upper display</td><td>Current (phase switch indication)</td></tr> <tr><td>Middle display</td><td>Active power</td></tr> <tr><td>Lower display</td><td>Power factor</td></tr> </table>	Upper display	Current (phase switch indication)	Middle display	Active power	Lower display	Power factor	 <table border="1"> <tr><td>Upper display</td><td>Active power</td></tr> <tr><td>Middle display</td><td>Maximum demand value</td></tr> <tr><td>Lower display</td><td>Demand value</td></tr> </table>	Upper display	Active power	Middle display	Maximum demand value	Lower display	Demand value
Upper display	Voltage-1																										
Middle display	Voltage-2																										
Lower display	Voltage-3																										
Upper display	Current (phase switch indication)																										
Middle display	Voltage (phase switch indication)																										
Lower display	Frequency																										
Upper display	Current (phase switch indication)																										
Middle display	Active power																										
Lower display	Power factor																										
Upper display	Active power																										
Middle display	Maximum demand value																										
Lower display	Demand value																										

As below, "NONE" appears in the display of a measurement item whose value cannot be displayed due to the specifications of the PR300.

none

4.3 Displaying Measured, Instantaneous, and Maximum/Minimum Values

Example Display and Measuring Ranges of Active Power (Regenerative Power)

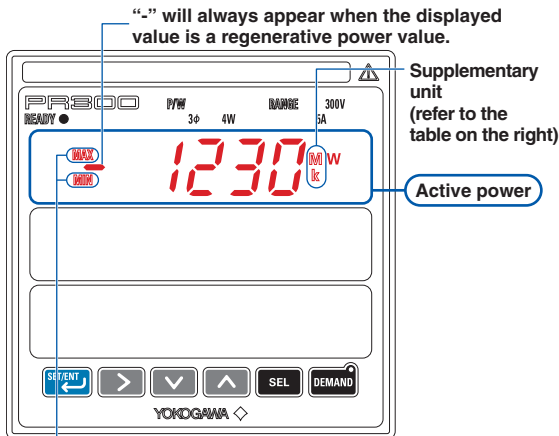

Secondary rated power × 1.2 × VT ratio × CT ratio	Measuring range
6 W to less than 100 W	0.00 to 99.99 W
100 W to less than 1 kW	0.0 to 999.9 W
1 kW to less than 10 kW	0 to 9999 W
10 kW to less than 100 kW	0.00 to 99.99 kW
100 kW to less than 1 MW	0.0 to 999.9 kW
1 MW to less than 10 MW	0 to 9999 kW
10 MW to less than 100 MW	0.00 to 99.99 MW
100 MW to less than 1 GW	0.0 to 999.9 MW
1 GW or greater	0 to 9999 MW

MAX: Turns on while the maximum value is displayed.
 MIN: Turns on while the minimum value is displayed.

The following will appear when the input value is [secondary rated power × 1.2 × VT ratio × CT ratio] or more. and the measured value blink alternately.

Example Display and Measuring Ranges of Reactive Power

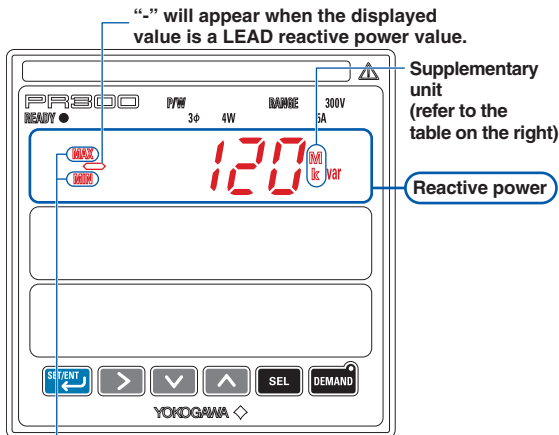

Secondary rated power × 1.2 × VT ratio × CT ratio	Measuring range
6 W to less than 100 W	0.00 to 99.99 var
100 W to less than 1 kW	0.0 to 999.9 var
1 kW to less than 10 kW	0 to 9999 var
10 kW to less than 100 kW	0.00 to 99.99 kvar
100 kW to less than 1 MW	0.0 to 999.9 kvar
1 MW to less than 10 MW	0 to 9999 kvar
10 MW to less than 100 MW	0.00 to 99.99 Mvar
100 MW to less than 1 GW	0.0 to 999.9 Mvar
1 GW or greater	0 to 9999 Mvar

MAX: Turns on while the maximum value is displayed.
 MIN: Turns on while the minimum value is displayed.

The following will appear when the input value is [secondary rated power × 1.2 × VT ratio × CT ratio] or more. and the measured value blink alternately.

Example Display and Measuring Ranges of Apparent Power

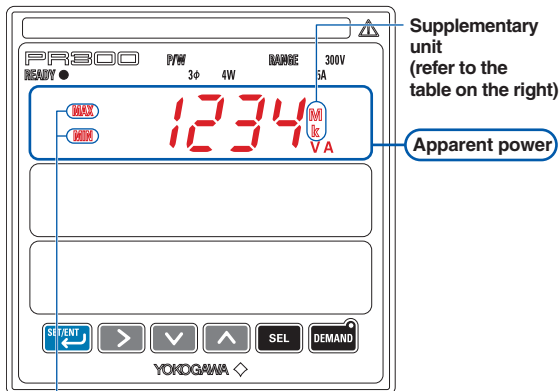

Secondary rated power × 1.2 × VT ratio × CT ratio	Measuring range
6 W to less than 100 W	0.00 to 99.99 VA
100 W to less than 1 kW	0.0 to 999.9 VA
1 kW to less than 10 kW	0 to 9999 VA
10 kW to less than 100 kW	0.00 to 99.99 kVA
100 kW to less than 1 MW	0.0 to 999.9 kVA
1 MW to less than 10 MW	0 to 9999 kVA
10 MW to less than 100 MW	0.00 to 99.99 MVA
100 MW to less than 1 GW	0.0 to 999.9 MVA
1 GW or greater	0 to 9999 MVA

MAX: Turns on while the maximum value is displayed.
 MIN: Turns on while the minimum value is displayed.

The following will appear when the input value is [secondary rated power × 1.2 × VT ratio × CT ratio] or more. and the measured value blink alternately.

Example Display and Measuring Ranges of Voltage

Voltage range × 1.2 × VT ratio	Measuring range
100 V to less than 1 kV	0.0 to 999.9 V
1 kV to less than 10 kV	0 to 9999 V
10 kV to less than 100 kV	0.00 to 99.99 kV
100 kV to less than 1 MV	0.0 to 999.9 kV
1 MV to less than 10 MV	0 to 9999 kV

The following will appear when the input value is less than [voltage range × 0.1 × VT ratio] or [voltage range × 1.2 × VT ratio] or more.

r-out and the measured value blink alternately.

MAX: Turns on while the maximum value is displayed.
MIN: Turns on while the minimum value is displayed.

Example Display and Measuring Ranges of Current

Current range × 1.2 × CT ratio	Measuring range
0.06 A to less than 10 A	0.000 to 9.999 A
10 A to less than 100 A	0.00 to 99.99 A
100 A to less than 1 kA	0.0 to 999.9 A
1 kA to less than 10 kA	0 to 9999 A
10 kA to less than 100 kA	0.00 to 99.99 kA
100 kA to less than 1 MA	0.0 to 999.9 kA

The following will appear when the input value is [current range × 1.2 × CT ratio] or more.

r-out and the measured value blink alternately.

MAX: Turns on while the maximum value is displayed.

Example Display and Measuring Ranges of Power Factor

Symbol indicated when the value is LAG power factor.

Symbol indicated when the value is LEAD power factor.

MAX: Turns on while the maximum value is displayed.
MIN: Turns on while the minimum value is displayed.

The following will appear when the measurement is out of range:

r-out and the measured value blink alternately.

Measuring range: (LEAD) 0.500 to 1 to 0.500 (LAG)

* When the power factor is 1, the symbols indicating LEAD and LAG power factors are not displayed.

Example Display and Measuring Ranges of Frequency

The frequency of Voltage-1 is displayed.

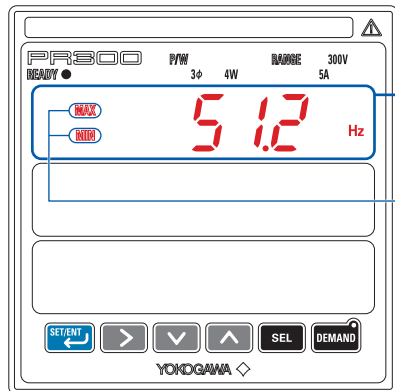

Frequency

MAX: Turns on while the maximum value is displayed.
MIN: Turns on while the minimum value is displayed.

The following will appear when the measurement is out of range:



Measuring range: 45.0 to 65.0 Hz

How to Switch between Instantaneous Value, Maximum Value, and Minimum Value

- For active power (regenerative power), reactive power, apparent power, voltage, power factor, and frequency, the instantaneous value, the maximum value, and the minimum value can be switched for display using the operation keys (↓ or ↑).
- For current, the instantaneous value and the maximum value can be switched for display also using operation keys.
- The maximum and minimum values being displayed are those after resetting the maximum/minimum value or after turning on the power.

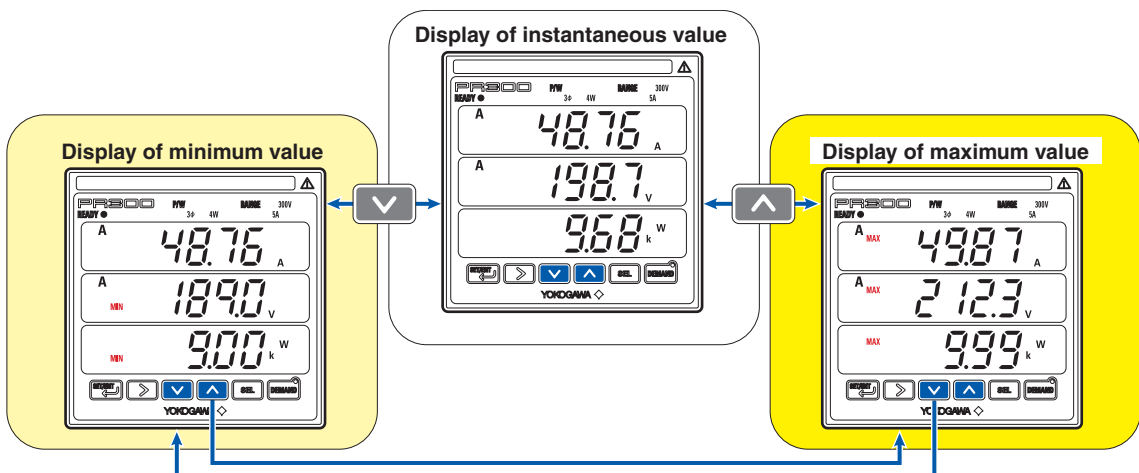

Minimum value		Instantaneous value		Maximum value	
↓	↑	↓	↑	↓	↑
Instantaneous value	Maximum value	Minimum value	Maximum value	Minimum value	Instantaneous value



NOTE

Turn the PR300 off/on by the power supply or perform remote resetting via communication in order to reset the instantaneous, maximum, and minimum values of measurements.

4.4 Phase Switching for Voltage and Current

Using an operation key (SEL) of the PR300, the user can switch the phase of voltage, current, and demand current (*1) for display.

- For this phase switching, “Voltage (phase switch indication),” “Current (phase switch indication),” and “Demand current (*1)” must be set to the display pattern, and those settings seen on the Measured Value screen.

*1 Only the PR300 with the demand measuring function can handle demand current.

How to Switch the Phase for Single-phase Three-wire, Three-phase Three-wire and Three-phase Four-wire (2.5 element) Systems

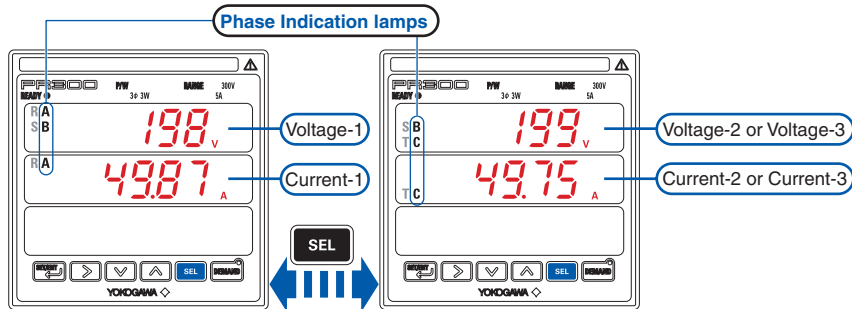

How to Switch the Phase for Three-phase Four-wire System

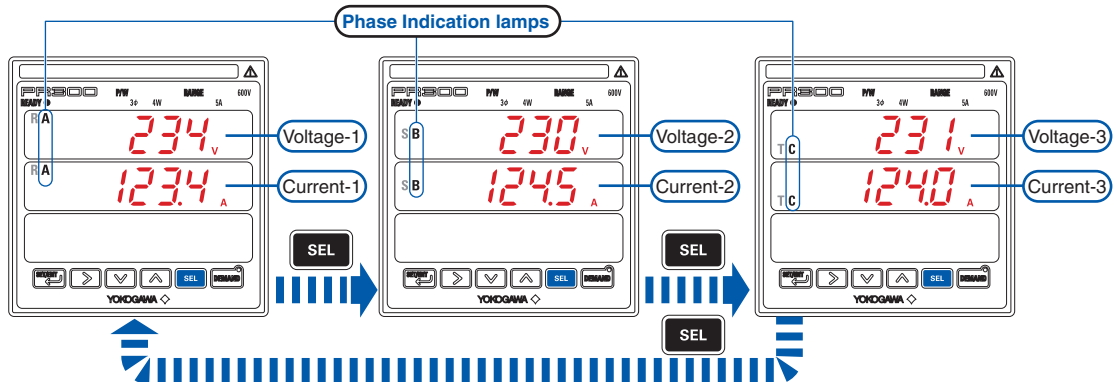

How to Read the Phase Indication Lamp

Phase and wire system	Voltage	Phase indication lamp turning on		Current	Phase indication lamp turning on	
		A,B,C	R,S,T		A,B,C	R,S,T
Single-phase two-wire system	Voltage-1	A	R	Current-1	A	R
Single-phase three-wire system	Voltage-1	A, B	R, S	Current-1	A	R
	Voltage-2	B, C	S, T	Current-2	C	T
Three-phase three-wire system	Voltage-1	A, B	R, S	Current-1	A	R
	Voltage-3	B, C	S, T	Current-3	C	T
Three-phase four-wire system	Voltage-1	A	R	Current-1	A	R
	Voltage-2	B	S	Current-2	B	S
	Voltage-3	C	T	Current-3	C	T
Three-phase four-wire system (2.5 element)	Voltage-1	A	R	Current-1	A	R
	Voltage-2	B	S	Current-2	B	S
	Voltage-3	C	T	Current-3	C	T



NOTE

- The phase indication lamps (“A,B,C” or “R,S,T”) chosen at the time of ordering are turned on. This setting cannot be changed after delivery.
- In the single-phase two-wire system, phase indication lamp “A” or “R” turns on. This setting cannot be changed.
- In the three-phase four-wire system (2.5 element), the current can be measured only when it is in a state of equilibrium.

4.5 Displaying Energy Values

This section explains the measuring range and display method of active energy, regenerative energy, LEAD reactive energy, LAG reactive energy, and apparent energy.

Example Display and Measuring Ranges of Active Energy and Regenerative Energy

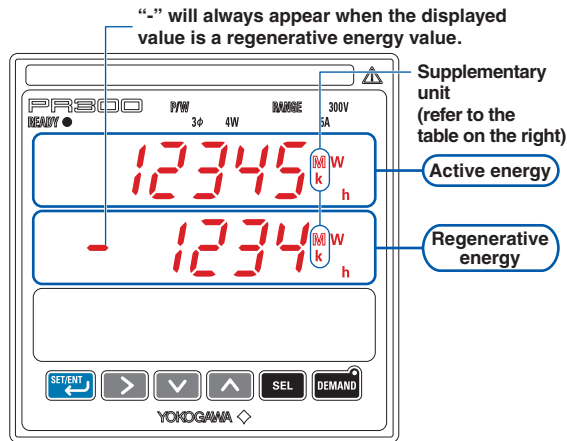

Type	Secondary rated power × VT ratio × CT ratio	Measuring range
A	Less than 100 kW	0 to 99999 kWh
B	100 kW to less than 1 MW	0.00 to 999.99 MWh
C	1 MW to less than 10 MW	0.0 to 9999.9 MWh
D	10 MW or greater	0 to 99999 MWh

* For all the four types in the table, decimal places that are not appearing can be displayed by key operation (refer to "Operation for Energy Value Display" on the next page).

Example Display and Measuring Ranges of LEAD Reactive Energy and LAG Reactive Energy

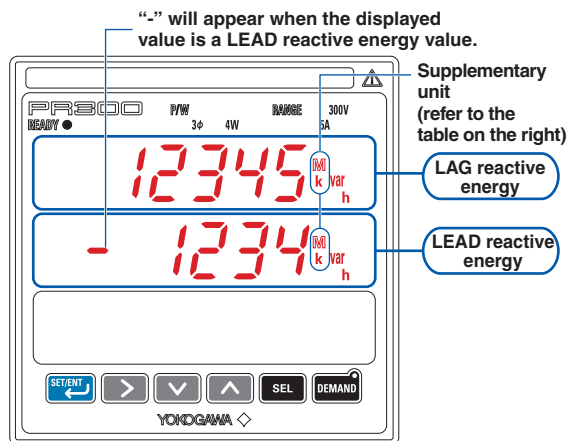

Type	Secondary rated power × VT ratio × CT ratio	Measuring range
A	Less than 100 kW	0 to 99999 kVarh
B	100 kW to less than 1 MW	0.00 to 999.99 Mvarh
C	1 MW to less than 10 MW	0.0 to 9999.9 Mvarh
D	10 MW or greater	0 to 99999 Mvarh

* For all the four types in the table, decimal places that are not appearing can be displayed by key operation (refer to "Operation for Energy Value Display" on the next page).

Example Display and Measuring Ranges of Apparent Energy

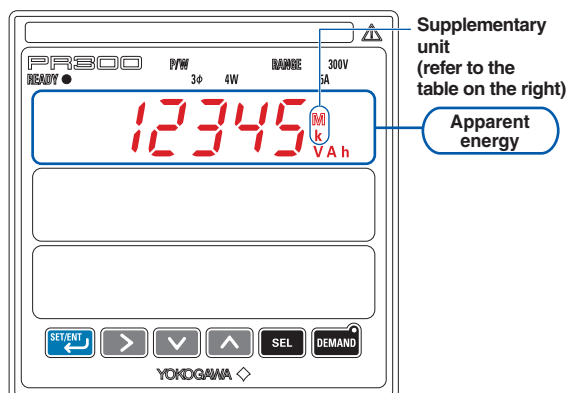

Type	Secondary rated power × VT ratio × CT ratio	Measuring range
A	Less than 100 kW	0 to 99999 kVAh
B	100 kW to less than 1 MW	0.00 to 999.99 MVAh
C	1 MW to less than 10 MW	0.0 to 9999.9 MVAh
D	10 MW or greater	0 to 99999 MVAh

* For all the four types in the table, decimal places that are not appearing can be displayed by key operation (refer to "Operation for Energy Value Display" on the next page).



NOTE

When the power is below the integrated low-cut power, it is not integrated as energy.

Operation for Energy Value Display

For all measurement ranges of active energy, regenerative energy, LEAD reactive energy, LAG reactive energy, and apparent energy, decimal places that are not appearing can be displayed by key operation.

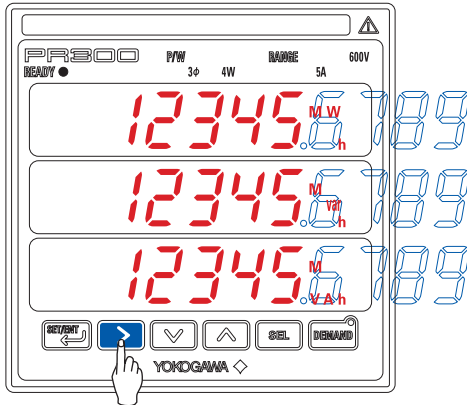

- The digits being displayed are in in the table below. The figures that are not highlighted are not displayed and not visible.
- Every time ▶ is pressed, the display order is incremented by 1. If ▶ is pressed when the smallest digit is appearing, the display will return to the initial value (the display order returns to 1).
- If there is no key entry for 60 minutes after shifting the displayed digits, the display will automatically return to the initial value (the display order returns to 1).

Display order	Type A	Display order	Type B
1	12345.6 7 8 9	1	12345.67 8 9
2	1 2345.6 7 8 9	2	1 2345.67 8 9
		3	1 2 345.67 8 9
Display order	Type C	Display order	Type D
1	12345.678 9	1	12345.6789
2	1 2345.678 9	2	1 2345.6789
3	1 2 345.678 9	3	1 2 345.6789
4	1 2 3 45.678 9	4	1 2 3 45.6789
		5	1 2 3 4 5.6789

As can be seen in the figures below, the energy value returns to 0 after reaching the maximum energy value.

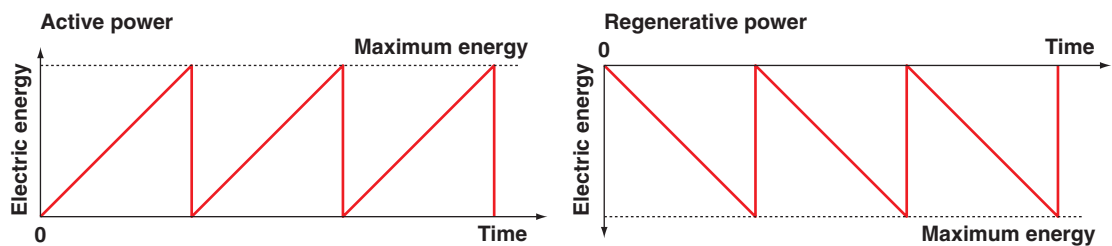

Optional Integrating Function

The optional integrating function integrates the active power while the control signal for optional integration is activated (ON for activating and OFF for deactivating). The operation for this signal can be performed via communication or by digital input.



NOTE

- The control signal for optional integration of the PR300 with the demand measuring function can be controlled only via communication. It is not possible by digital input.
- The active power below the integrated low-cut power cannot be integrated.
- Once the control signal for optional integration is controlled via communication, communication is the only means for controlling that signal until system reset* is performed. The same applies to control by digital input.
 - * System reset can be performed by turning off/on the power supply for the PR300 or by executing remote reset via communication.
- When the system is reset, the optional integrated value is reset to 0.
- If power failure occurs during integration, an optional integrated value is reset to 0.

Example operation of the control signal for optional integration via communication

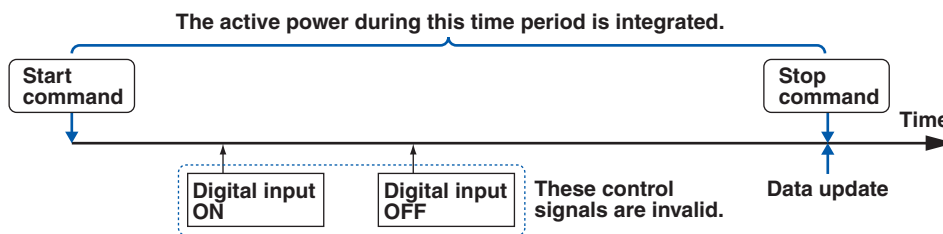

Example operation of the control signal for optional integration by digital input

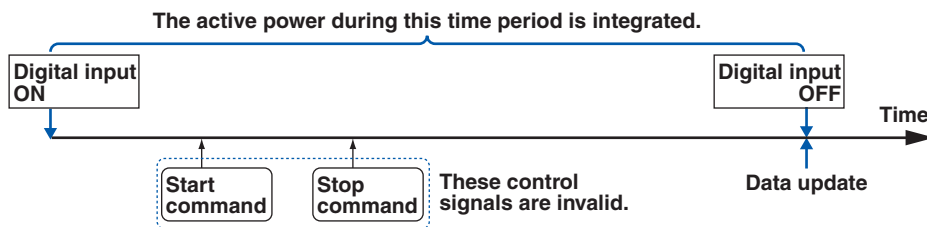

Digital input

Number of inputs: 1

Input signal: ON signal 4.5 to 25 V DC, OFF signal within ± 1 V DC

Maximum integrated value

99999 Wh (After the integrated value reaches this maximum value, it returns to "0.")

Data update

When the control signal for optional integration is turned off and then turned on:

The displayed measured value is reset to 0, and integration starts. The integrated value before resetting (previous value) can be confirmed via communication.

When the control signal for optional integration is turned on for a while and turned off later:

The displayed measured value is the integrated value. This value display is retained until the control signal for optional integration is turned on again.

4.6 Resetting Measured Values

Resetting Maximum and Minimum Values

Operation

Measured Value screen

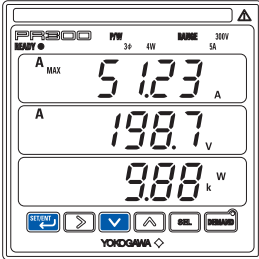

1 Simultaneously hold down **SET/ENT** and **↓** for at least 5 seconds.

Reset Item Selection screen

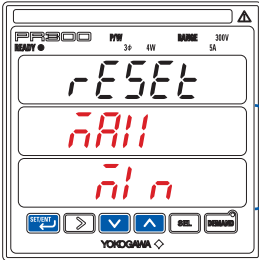

The Reset Item Selection screen appears.

2 Display the reset items on the screen (refer to the figure on the left) using **↓** or **↑** and press **SET/ENT** once.

Reset Item Confirmation screen

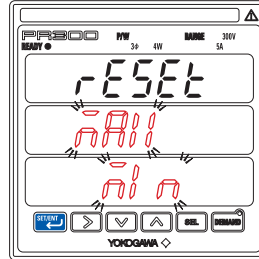

The Reset Item Confirmation screen appears, and the reset items blink.

3 **To stop resetting**
To change the reset items
Press any key other than **SET/ENT** while the reset items are blinking. The PR300 returns to the Reset Item Selection screen.

Press **SET/ENT** once.

Measured Value screen

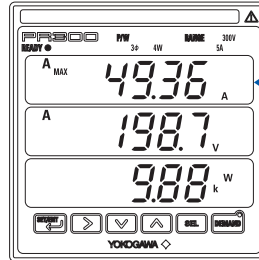

The maximum and minimum values are reset, and the PR300 returns to the Measured Value screen.

“RESET” appears for about 1 second, then a measured value appears.

(“RESET” will not appear if returning to the screen not showing the maximum or minimum value after resetting.)

To return to the Measured Value screen without resetting, refer to “Canceling Reset Item Selection” on the next page.

Resetting Energy Value

Operation

Measured Value screen

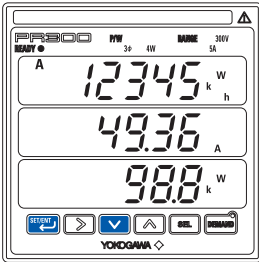

1 Simultaneously hold down **SET/ENT** and **↓** for at least 5 seconds.

Reset Item Selection screen

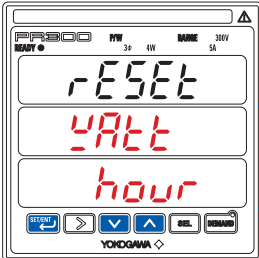

The Reset Item Selection screen appears.

2 Display the reset items on the screen (refer to the figure on the left) using **↓** or **↑** and press **SET/ENT** once.

Reset Item Confirmation screen

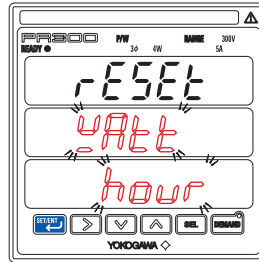

The Reset Item Confirmation screen appears, and the reset items blink.

3 **To stop resetting**
To change the reset items
Press any key other than **SET/ENT** while the reset items are blinking. The PR300 returns to the Reset Item Selection screen.

Press **SET/ENT** once.

Measured Value screen

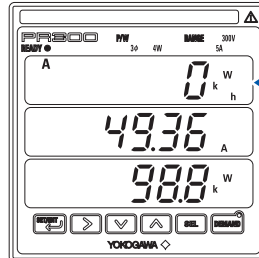

The energy value is reset, and the PR300 returns to the Measured Value screen.

“RESET” appears for about 1 second, then a measured value appears.

(“RESET” will not appear if returning to the screen not showing the energy value after resetting.)

To return to the Measured Value screen without resetting, refer to “Canceling Reset Item Selection” on the next page.

Canceling Reset Item Selection (Returning to the Measured Value screen without resetting)

When the screen moves to the Reset Item Selection screen from the Measured Value screen, in order to return to the Measured Value screen without resetting a measured value, carry out the following operations.

Operation

Reset Item Selection screen

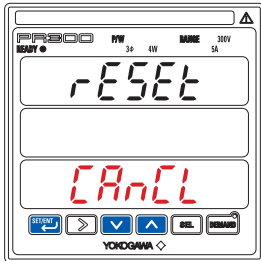

1

On the Reset Item Selection screen, press or to bring up **CAncL** and press once.

Measured Value screen

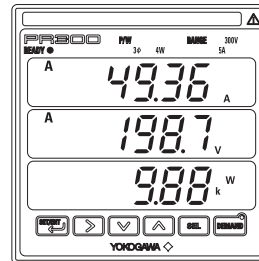

The measured value is not reset, and the PR300 returns to the Measured Value screen.

Reset Item Confirmation screen

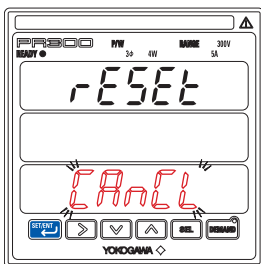

2

The Reset Item Confirmation screen appears, and the reset item blinks.

Press once.

Reset Items and Details

Reset Item Symbol	Reset Item Names	Details
 	Maximum/minimum value reset	The maximum/minimum values of active power, regenerative power, reactive power, apparent power, voltage, power factor, and frequency are reset to the current value. The maximum value of current is reset to the current value.
 	Energy value reset	The values of active energy, regenerative energy, LEAD reactive energy, LAG reactive energy, and apparent energy are reset to "0."
	Cancellation	Resetting is not performed. The PR300 returns to the Measured Value screen from the Reset Item Selection screen.

4.7 Demand Measurement (Optional Measuring Function)

The PR300 (with the demand measuring function) can measure the average power or current during the set demand period.

This section explains the example display of measured value, measuring range, measurement operation, and example measurement. For setting conditions related to the demand measurement such as demand period, refer to Section 3.8, "Setting Demand Measurement Conditions."

Example Demand Display and Measuring Ranges

Demand power

Secondary rated power × 1.2 × VT ratio × CT ratio	Measuring range
6 W to less than 100 W	0.00 to 99.99 W
100 W to less than 1 kW	0.0 to 999.9 W
1 kW to less than 10 kW	0 to 9999 W
10 kW to less than 100 kW	0.00 to 99.99 kW
100 kW to less than 1 MW	0.0 to 999.9 kW
1 MW to less than 10 MW	0 to 9999 kW
10 MW to less than 100 MW	0.00 to 99.99 MW
100 MW to less than 1 GW	0.0 to 999.9 MW
1 GW or greater	0 to 9999 MW

Demand current

Current range × 1.2 × CT ratio	Measuring range
0.06 A to less than 10 A	0.000 to 9.999 A
10 A to less than 100 A	0.00 to 99.99 A
100 A to less than 1 kA	0.0 to 999.9 A
1 kA to less than 10 kA	0 to 9999 A
10 kA to less than 100 kA	0.00 to 99.99 kA
100 kA to less than 1 MA	0.0 to 999.9 kA

Demand Measurement Procedure

Equation: $(P_t - P_s) \times (60 \text{ minutes} \times 60 \text{ seconds} \div t)$
 Pt: Current integrated value
 Ps: Integrated value at the beginning of the demand period
 t: Demand elapsed time (data update period: 10 seconds)

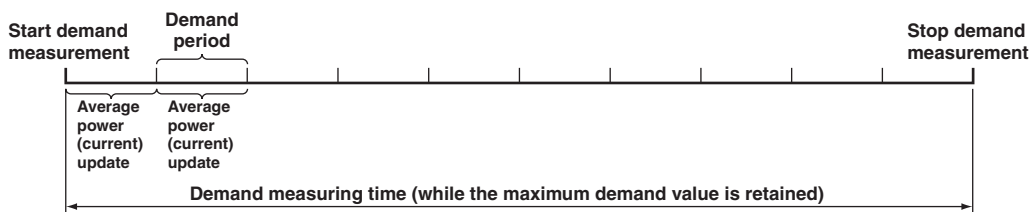

Operation for Demand Measurement

Demand measurement can be started and stopped by the operation key (DEMAND) or via communication. This section only explains control by the operation key (for operation via communication, refer to the PR300 Communication Interface User's Manual: IM77C01E01-10E). In the demand measurement mode, either the demand power or the demand current can be measured. To set either of these, refer to Section 3.8, "Setting Demand Measurement Conditions."

Start demand measurement

Operation

Measured Value screen

Maximum demand value
Demand value

Hold down DEMAND for at least 3 seconds.

Measured Value screen

Demand measurement starts.

Turns on during demand measurement.

The measured value is updated every ten seconds.

Stop demand measurement

Operation

Measured Value screen

During demand power or current measurement

Hold down DEMAND for at least 3 seconds.

Measured Value screen

Demand measurement stops.

Does not turn on when demand is not measured.



NOTE

- Once the operation key is used for control to start and stop demand measurement, it is the only means for controlling until system reset* is performed. The same applies to control via communication.
 - * System reset can be performed by turning off/on the power supply for the PR300 or by executing remote reset via communication.
- When the system is reset, the measured values of demand, maximum demand, and demand alarm status are reset to 0.
- If power failure occurs during measurement, the measured values of demand, maximum demand, and demand alarm status are reset to 0.

Example operation to start/stop demand measurement

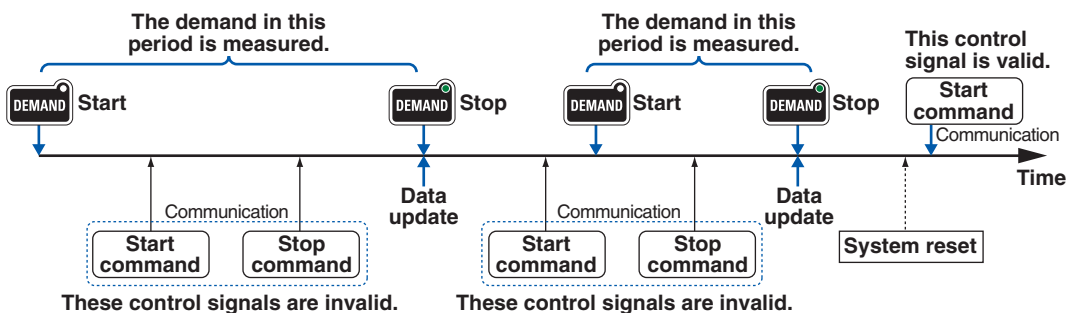

Demand Alarm

Demand alarm output

Function: When the set demand alarm point is exceeded, an alarm is output.
 Output signal: Open collector
 Output capacity: 30 V DC, 200 mA

Demand alarm release function

Automatic release: When the demand value falls below the demand alarm point, the alarm is canceled.
 Manual release: The state of the alarm is maintained even if the demand value falls below the demand alarm point. It is canceled via communication or by digital input or the operation key.

Digital input Number of inputs: 1
 ON signal: 4.5 to 25 V DC
 OFF signal: within ±1 V DC

Demand alarm mask time

The demand alarm mask time is the time between the beginning of the demand period and the set time, during which a demand alarm is not recognized.

Example Demand Measurement

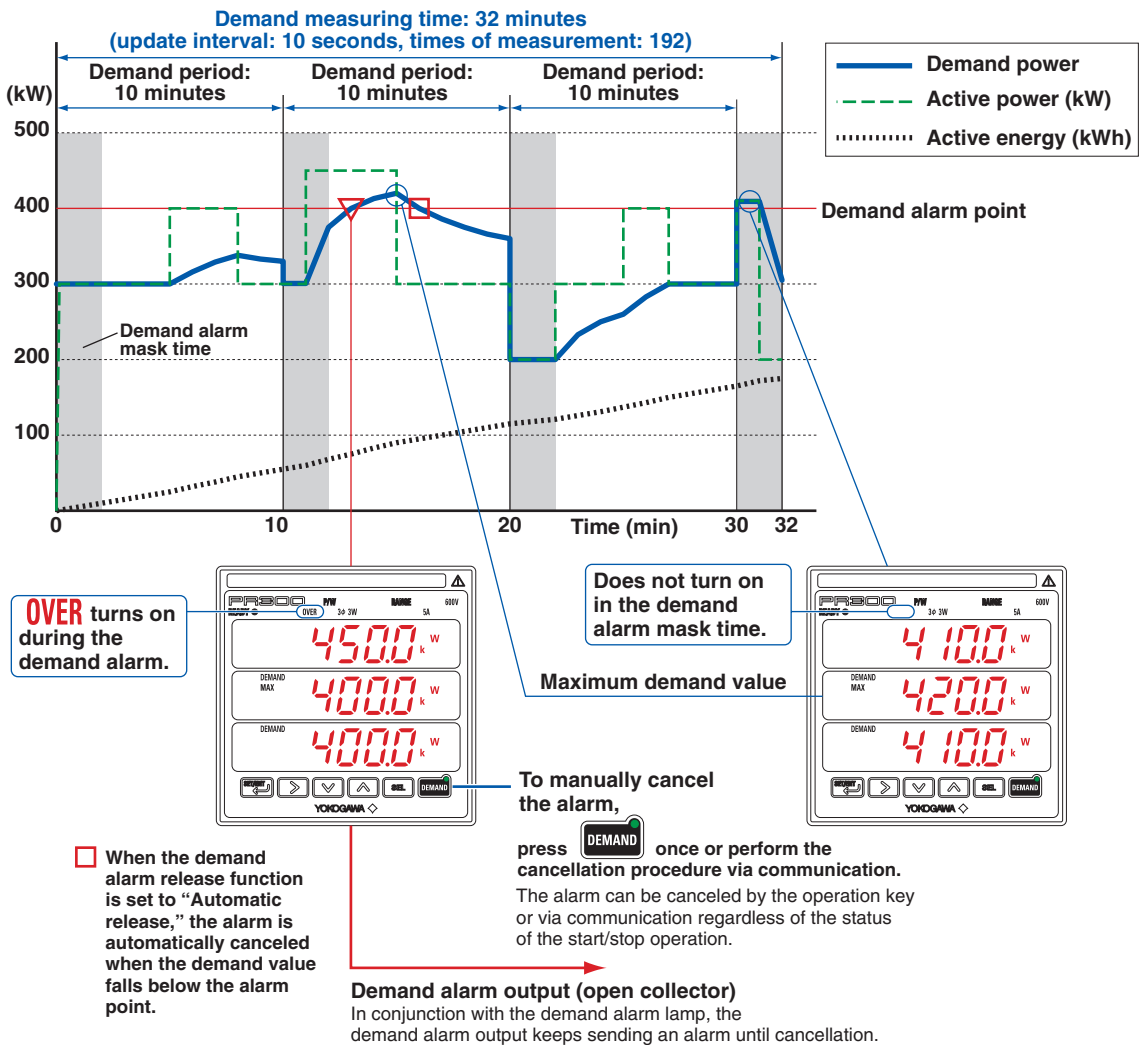

Maximum demand value

The maximum demand value is the maximum value in the demand measuring time. This value is retained until system reset or start of the next demand measurement.

5.1 Error Display and Recommended Response

Failure at the Time of Turning on the Power and during Operation

Error display					Type of fault	Status					Recommended response
Upper display of measured value display	Power lamp	Phase and wire system lamp	Communication lamp	Pulse lamp		Power calculation	Communication	Pulse output (contact point)	Analog output	Demand alarm	
E000	Unstable	Off	Off	Off	RAM error	Disabled	Disabled	Disabled	Disabled	Disabled	Request repair.
E001					ROM error						
E002	Off	Normal action	Normal action		System data fault	Normal action	Normal action	Normal action	Normal action	Normal action	
E003					Calibration data fault						
E004					Parameter fault						
E005					Backup fault						
E006					Normal action						
E007	Off	ADC error	Disabled		Disabled	Disabled	Disabled				

Errors during Operation

Error display					Type of fault	Status					Recommended response
Upper display of measured value display	Power lamp	Phase and wire system lamp	Communication lamp	Pulse lamp		Power calculation	Communication	Pulse output (contact point)	Analog output	Demand alarm	
r-out blinking	On	Normal action	Normal action	Normal action	Measured input error	Normal action	Normal action	Normal action	Normal action	Normal action	Confirm the input.
Normal action					Blinks at intervals of 125 milliseconds.						Communication error

Errors at the Measured input error

Measurement items	Measured input error conditions	Error display	Recommended response
Active power	120% or more of "secondary rated power × VT ratio × CT ratio"	r-out and the measured value blink alternately	The error is cleared by inputting a measured value less than 120%.
Reactive power			
Apparent power			
Voltage	120% or more of "voltage range × VT ratio" Less than 10% of "voltage range × VT ratio"		The error is cleared by inputting a measured value 10% or more.
Current	120% or more of "current range × CT ratio"		The error is cleared by inputting a measured value less than 120%.
Power factor	Out of the measuring range (LEAD 0.5 to 1 to LAG 0.5)		The error is cleared by inputting a measured value within the measuring range.
Frequency	Out of the measuring range (45 to 65 Hz)		

Errors at the Time of Setting Parameters

Example	Error display	Recommended response
The setpoint is out of the range.	r-out and the setpoint blink alternately on the display.	The error is cleared by setting a value within the range.

5.2 Maintenance

Cleaning

The front panel and operation keys should be gently wiped with a dry cloth.



NOTE

Do not use alcohol, benzene, or any other solvents.

Request for Repair in the Case of a Failure

- In the case of a failure, the failed product is to be exchanged for a replacement. We will accept the request for repair for a period of seven years from the date of the purchase.
- The parameter settings set to the failed product cannot be restored for a replacement. (Record the parameter settings of the PR300 on MEMO column in Appendix 4, "Parameter List" of this manual.)
- Return the failed product with the accessories in the package supplied at delivery.

In the case of a failure, check the following and contact the sales representative from which you purchased the product.

1. Serial number (shown in "NO." on the nameplate)
2. Failed state and error display

Appendix 1 Specifications of PR300

Measuring Function

Active energy (regenerative energy)	The active power up to present is integrated, and the integrated value is output in units of kWh or MWh (only kWh in the communication mode). The sign of integrated values of regenerative power is “-,” and they are output as different data.
Reactive energy	LAG and LEAD reactive power up to present are integrated and output in units of kvarh or Mvarh (only kvarh in the communication mode). The signs of LAG reactive power and LEAD reactive power are “+” and “-,” respectively.
Apparent energy	Apparent power up to present is integrated and output in units of kVAh or MVAh (only kVAh in the communication mode).
Optional active energy	While the control signal for optional integration is turned on, the active power is integrated and output in units of Wh. The control signal for optional integration is turned on via communication or by digital input.
Active power (regenerative power)	The present active power is output in units of W, kW, or MW. The sign of the value of regenerative power is always “-.”
	Minimum resolution: 0.1 W (The minimum display resolution is the least significant value of $[\text{primary rated power}^{(*)} \times 0.001]$)
	Maximum/minimum values They are calculated in the range of $[- \text{primary rated power}^{(*)} \times 1.2]$ to $[\text{primary rated power}^{(*)} \times 1.2]$.
Apparent power	The present apparent power is output in units of VA, kVA, or MVA.
	Minimum resolution 0.1 VA (The minimum display resolution is the least significant digit of $[(\text{primary rated power}^{(*)} \times 0.001)]$.)
	Maximum/minimum values They are calculated in the range of 0 to $[(\text{primary rated power}^{(*)} \times 1.2)]$.
Reactive power	The present reactive power is output in units of var, kvar, or Mvar. The value of LEAD reactive power is output with a “-” sign. The value of LAG reactive power is output without a positive sign. (The signs of LEAD/LAG calculates according to the phase difference between V1 and I1.)
	Minimum resolution 0.1 var
	Maximum value It is calculated in the range between 0 and $[(\text{primary rated power}^{(*)} \times 1.2)]$ (whichever is larger of the LEAD or LAG value).
	Minimum value It is calculated in the range between 0 and $[(\text{primary rated power}^{(*)} \times 1.2)]$ (whichever is smaller of the LEAD or LAG value).
Power factor	The present LEAD power factor is output as a value with a “-” sign. The present LAG power factor is output as a value without a positive sign (a power factor is an rms value. The signs of LEAD/LAG calculates according to the phase difference between V1 and I1.).
	Minimum resolution 0.001
	Maximum value It is calculated in the range between 0 and $[(\text{rated value}) \times 1.2]$ (whichever is larger of the LEAD or LAG value).
	Minimum value It is calculated in the range between 0 and $[(\text{rated value}) \times 1.2]$ (whichever is smaller of the LEAD or LAG value).
Frequency	The frequency of the voltage line input to Voltage-1 is output in units of Hz.
	Minimum resolution 0.1 Hz
Demand	The average power or the average current in the set demand period is measured (refer to “3.8 Setting Demand Measurement Conditions” and “4.7 Demand Measurement”).
	* Primary rated power= secondary rated power \times VT ratio \times CT ratio (Secondary rated power is the rated power of PR300.)

Power Items and Equations

(V and A are rms values.)

Phase and wire system	Apparent Power	Reactive Power (without using reactive power meter method)	Power Factor
Single-phase two-wire system	$VA = V \times A$	$Q = \sqrt{((VA)^2 - P^2)}$	
Single-phase three-wire system	$VA_i = V_i \times A_i$ $i = 1, 2 \quad \Sigma VA = VA_1 + VA_2$	$Q_i = \sqrt{((VA_i)^2 - P_i^2)}$ $i = 1, 2 \quad \Sigma Q = Q_1 + Q_2$	$\Sigma P / \Sigma VA$ (without using reactive power meter method)
Three-phase three-wire system	$VA_i = V_i \times A_i$ $i = 1, 3 \quad \Sigma VA = \sqrt{3}/2 (VA_1 + VA_3)$	$Q_i = \sqrt{((VA_i)^2 - P_i^2)}$ $i = 1, 3 \quad \Sigma Q = Q_1 + Q_3$	
Three-phase four-wire system	$VA_i = V_i \times A_i$ $i = 1, 2, 3 \quad \Sigma VA = VA_1 + VA_2 + VA_3$	$Q_i = \sqrt{((VA_i)^2 - P_i^2)}$ $i = 1, 2, 3 \quad \Sigma Q = Q_1 + Q_2 + Q_3$	
Three-phase four-wire system (2.5 element)	$VA_i = V_i \times A_i$ $i = 1, 3 \quad \Sigma VA = \sqrt{3}/2 (VA_1 + VA_3)$	$Q_i = \sqrt{(\sqrt{3}/2 (VA_i)^2 - P_i^2)}$ $i = 1, 3 \quad \Sigma Q = Q_1 + Q_3$	

* For distorted wave input, there may be differences between the PR300 and a measuring instrument that uses a different measurement principle.

Input Specifications

Phase and wire system	Universal three-phase three-wire system (switch the setting from single-phase two-wire system, single-phase three-wire system, or three-phase three-wire system) Universal three-phase four-wire system (switch the setting from single-phase two-wire system, single-phase three-wire system, three-phase three-wire system, or three-phase four-wire system) Three-phase four-wire system (2.5 element)		
Frequency	45 to 65Hz		
Rated input voltage	120 V; voltage range: 150 V (*): 900kV (**) 240 V; voltage range: 300 V (*): 1800kV (**) 480 V; voltage range: 600 V (*): 3600kV (**) *: The setting of the voltage range can be changed. **: The primary voltage of VT.		
Allowable input voltage	Within the voltage range		
Rated input current	1 A; current range: 1 A (fixed): 32kA (***) 5 A; current range: 5 A (fixed): 160kA (***) ***: The primary current of CT.		
Allowable input current	1.2 times the current range (continuous); twice the current range (10 seconds); 10 times the current range (3 seconds)		
Rated input power and measuring range (when VT and CT are used, their respective secondary values)			

Single-phase two-wire system

Input (AC)	Rated power	Input measuring range	Approximate consumed VA	
			Voltage	Current
120V/1A	100W	-120 to 120W	0.2VA	0.2VA
120V/5A	500W	-600 to 600W		
240V/1A	200W	-240 to 240W	0.4VA	
240V/5A	1000W	-1200 to 1200W		
480V/1A	400W	-480 to 480W	0.8VA	
480V/5A	2000W	-2400 to 2400W		

Single-phase three-wire system

Input (AC)	Rated power	Input measuring range	Approximate consumed VA	
			Voltage	Current
240V/1A	200W	-240 to 240W	0.2VA/phase	0.2VA/phase
240V/5A	1000W	-1200 to 1200W		

Three-phase three-wire system

Input (AC)	Rated power	Input measuring range	Approximate consumed VA	
			Voltage	Current
120V/1A	200W	-240 to 240W	0.2VA/phase	0.2VA/phase
120V/5A	1000W	-1200 to 1200W		
240V/1A	400W	-480 to 480W	0.4VA/phase	
240V/5A	2000W	-2400 to 2400W		
480V/1A	800W	-960 to 960W	0.8VA/phase	
480V/5A	4000W	-4800 to 4800W		

Three-phase four-wire system

Input (AC)	Rated power	Input measuring range	Approximate consumed VA	
			Voltage	Current
* 120V/1A	300W	-360 to 360W	0.2VA/phase	0.2VA/phase
120V/5A	1500W	-1800 to 1800W		
* 240V/1A	600W	-720 to 720W	0.4VA/phase	
240V/5A	3000W	-3600 to 3600W		
* 480V/1A	1200W	-1440 to 1440W	0.8VA/phase	
480V/5A	6000W	-7200 to 7200W		

* Input specification of 1A AC is not available for 2.5 element.

When VT and CT are used, the input measuring range of the primary input power is smaller than 10 GW, and the value calculated by the following equation is within the input measuring range above.

$$\text{Input measuring range (W)} = \frac{\text{Primary input power (W)}}{\text{VT ratio} \times \text{CT ratio}}$$

Digital Input Specifications

It is used for control signals for optional integration or demand alarm release.	
	Control signal for optional integration: Starts and stops measurement of optional active energy.
	Demand alarm release (with demand measuring function): Releases demand alarm.
Number of inputs	1
Input signal	Voltage signal; ON signal: 4.5 to 25 V DC; OFF signal: within ±1 V DC
Minimum ON time	50 ms
(Note 1)	The control signal for optional integration can be controlled via communication. Once it is controlled by digital input, it is the only means for controlling until the system is reset. System reset can be performed via communication or by turning off/on of the power of the PR300.
(Note 2)	In the PR300 with the demand measuring function, digital input can be used only to cancel the demand alarm and cannot be used for control signals for optional integration.

Analog Output Specifications (additional output function)

The measured value is converted into the direct current signal for outputting.	
Measurement item for output	One of active power, reactive power, apparent power, voltage-1, voltage-2, voltage-3, current-1, current-2, current-3, power factor, and frequency
Output signal	4 to 20 mA DC
Output accuracy	Measurement accuracy of measurement item for output +(±0.5% of F.S.)
Allowable load resistance	0 to 600 Ω
Response speed	2 seconds or less (until ±1% of the final value is reached)
Setting item	Selection of measurement item for output, and lower, and upper limits of scaling
Setting range of lower/upper limits of scaling according to measurement item for output	
Active power	–rated power (W) to rated power (W)
Reactive power	–rated power (var) to rated power (var)
Apparent power	0 to rated power (VA)
Voltage-1 to 3	0 to voltage range (V)
Current-1 to 3	0 to current range (A)
Power factor	(LEAD) 0.5 to 1 to (LAG) 0.5
Frequency	45 to 65 (Hz)

Pulse Output Specifications (additional output function)

The pulse proportional to the energy is output.	
Measurement item for output	One of active energy, regenerative energy, LEAD reactive energy, LAG reactive energy, and apparent energy
Number of outputs	1
Output signal	Open collector
Contact capacity	30 V DC, 200 mA
Pulse unit	0.1 to 5000.0 kWh/pulse (changeable in increments of 100 Wh)
Setting item	Measurement items for output, pulse unit, and ON pulse width
ON pulse width	The ON time of the output pulse is shown. Setting range: 10 to 1270 ms (changeable in increments of 10 ms) Setting should be made not to exceed the value of the maximum ON pulse width calculated by the following equation: Maximum ON pulse width (ms) = $\frac{\text{Pulse unit [kWh/pulse]} \times 3600 \times 1000^2}{\text{Secondary rated power [W]} \times \text{VT ratio} \times \text{CT ratio} \times 1.2 \times 2}$ The pulse unit of reactive energy is kvarh/pulse, and that of apparent energy is kVAh/pulse.

Demand Alarm Output Specifications (optional measuring function)

When the demand measurement value exceeds the set demand alarm point, an alarm is triggered.	
Output signal	Open collector
Contact capacity	30 V DC, 200 mA
Set alarm range	1 to 1000 kW (during demand power measurement); 1 to 1000 A (during demand current measurement)
Alarm release function	<p>Automatic release: When the measured value falls below the demand alarm point during alarm output, the alarm is canceled.</p> <p>Manual release: Used to keep the alarm turned on or to cancel it by digital input or the operation key, or via communication.</p>
* The demand alarm mask time can be set for the PR300.	
The demand alarm mask time is the time between the beginning of the demand period and the set time, during which an alarm is not recognized.	
Allowable range of set time: 1 minute to demand period	

Communication Specifications

RS-485 communication

Via RS-485 communication, various measured values are read, and values are written to various parameters using the command/response method.

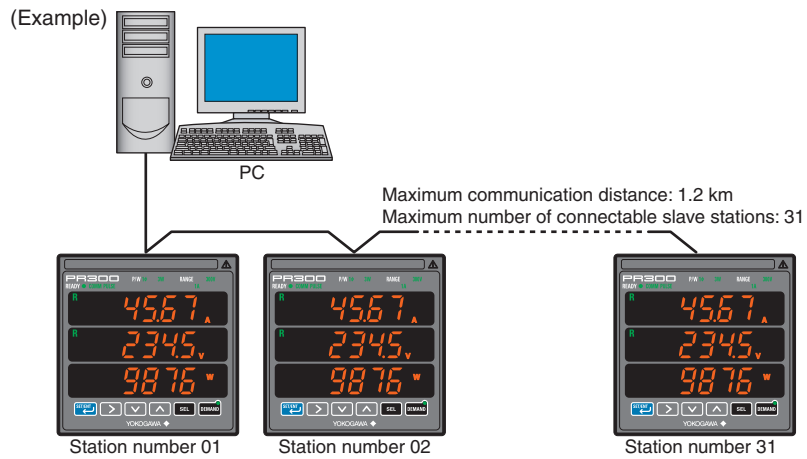

Protocol	PC link (without checksum), PC link (with checksum), Modbus/ASCII, and Modbus/RTU	
Transmission distance	Approximately 1.2 km maximum (with 24AWG twisted-pair cable(s))	
Connection method	Multi-drop connection (a maximum of 32 units including a higher-level device)	
Station number	01 to 99 (maximum number of units to be connected: 31 [number of units that can be connected to a PC etc.]) (recommended value: 01 to 31)	
Transmission method	Half-duplex communication	
Synchronization	Start-stop synchronization	
Baud rate	19200/9600/2400 bps	
Xon/Xoff control	None	
Data format	Data length	8 bits, 7 bits
	Parity	None, even, odd
	Stop bit	1 bit, 2 bits

Example of connection diagram

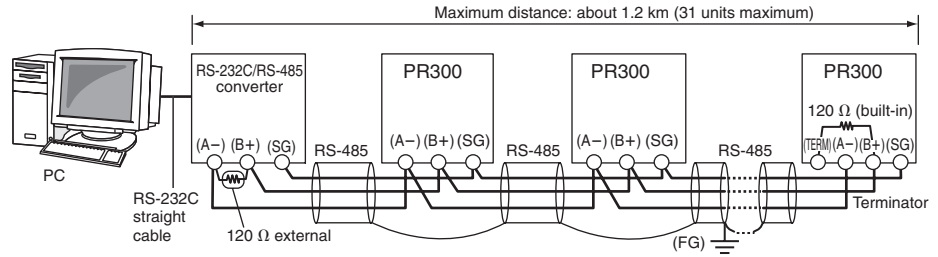

<Note>

For RS-485 communication, the PR300 employs the two-wire system.

SG: Connection to Terminal SG is made to adjust the signal level of the RS-485 communication line.

FG: For noise protection, a shield line must be connected to all wires in the RS-485 communication line and grounded at one location.

Use UL Listed RS-232C/RS-485 converter if the converter has AC/DC power supply input; this is optional for converters supplied by a Limited Power Source with input voltages less than 30 V AC or 60 V DC and which are separated from mains by double or reinforced insulation.

Ethernet communication

Via Ethernet communication, various measured values are read, and values are written to various parameters using the command/response method.

(Example)

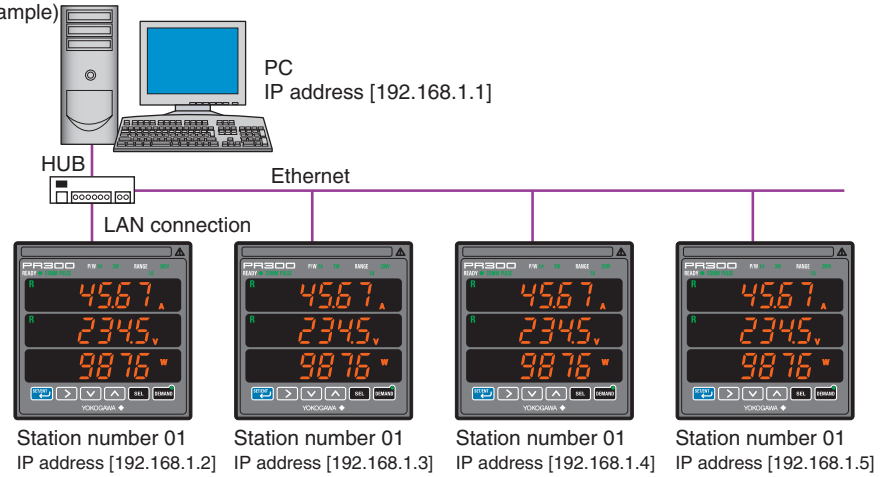

Connectable to an IEEE802.3-compliant network (10BASE-T/100BASE-TX).

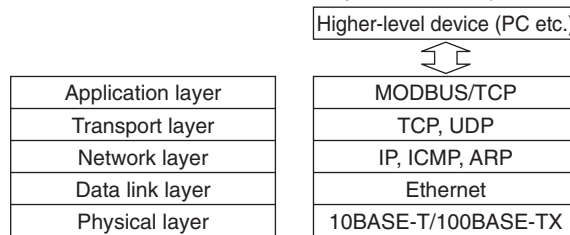

Communication specifications

Protocol	Modbus/TCP
Access control	CSMA/CD
Baud rate	10Mbps/100Mbps
Maximum segment length	100m (between HUB and module)
Maximum connection configuration	
Cascade	4 segments maximum (10BASE-T) 2 segments maximum (100BASE-TX) (number of HUBs that can be cascade connected)
IP address	The IP address can be set using the operation keys on the front side of the PR300.

Modbus/TCP function

Code	Function	Description
03	Reads data from multiple D registers	Capable of reading data from up to 64 registers continuously.
06	Writes data into D register	Capable of writing data into one resiter.
08	Performs loopback test	Capable of performing a communication test.
16	Writes data into multiple D registers	Capable of writing data into up to 32 registers continuously.

Overview of Modbus/TCP protocol

The structure of the Modbus/TCP protocol is as follows:

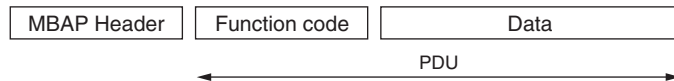

The Simple Protocol Data Unit (PDU) is the same as Modbus/RTU (Modbus protocol via serial communication).

The Modbus Application Protocol Header (MBAP Header) is made of the following seven bytes:

Byte No	0	1	2	3	4	5	6
Description	Transaction ID	Protocol ID	Number of bytes	Unit ID			

Ethernet - Serial gateway function

Equipped with an Ethernet communication connector and an RS-485 communication terminal, the PR300 receives a Modbus/TCP command from Ethernet and relays it to the RS-485 communication terminal. The PR300 allows connection to RS-485 serial communication devices (Modbus/RTU protocol) via the network.

RS-485 communication	
Protocol	Modbus/RTU
Baud rate	9600bps
Parity	None, even, odd
Stop bit	1 bit
Data length	8 bits

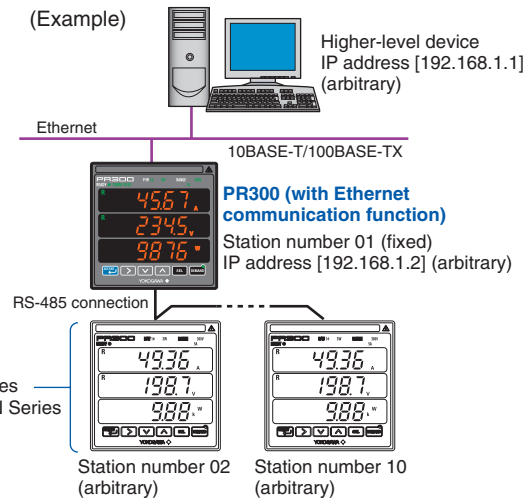

RS-485 serial communication device
Power monitor of POWERCERT Series
Digital indicating controller of GREEN Series
Signal conditioner of JUXTA Series

(Note) If Ethernet communication is used, the RS-485 communication interface is used specifically for the Ethernet-serial gateway function. Therefore, it is not possible for a higher-level device such as a PC to access the PR300 via the RS-485 communication interface.

Standard Performance

Accuracy rating	Active energy/optional active energy (Wh)	±0.5% (EN60687 accuracy: Class 0.5 or equivalent)
	Active power (W)	±0.5% of F.S.
	Voltage (V)	±0.25% of F.S. (voltage rms)
	Current (A)	±0.25% of F.S. (current rms)
	Frequency (Hz)	±0.5Hz
	Demand	±0.5%
Calculation accuracy	The value is calculated to ±1 digit from the measured value for reactive energy, apparent energy, reactive power, apparent power, power factor, or current.* * Current is only for the 2.5-element measurement.	
Backup upon power failure	The last integrated values obtained immediately before the power failure are held for active energy, regenerative energy, reactive energy, and apparent energy.	

Insulation resistance	Between each of the voltage input, current input, power, ground, digital input, pulse output, analog output, RS-485 communication output, Ethernet communication output, and alarm output terminals: 100 MΩ minimum (at 500 V DC)
Withstand voltage	Between each of the voltage input, current input, power, and ground terminals: 2500 V AC for 1 minute
	Between (the voltage input, current input, power, and ground terminals) and the digital input, pulse output, analog output, alarm output, RS-485 communication output, and Ethernet communication output terminals: 2500 V AC for 1 minute
	Between each of the digital input, pulse output, analog output, alarm output, and (RS-485 communication output, Ethernet communication output) terminals: 1000 V AC for 1 minute
	Between the RS-485 communication output and Ethernet communication output terminals: 500 V AC for 1 minute
Impulse withstand voltage	Between all of the voltage input, current input, and power terminals and the ground terminal Between all of the output and ground terminals and all of the voltage and current input terminals: 6 kV (1.2/50 μs), 10 times for positive and negative
Effects of magnetic field	400 A/m or less Active power: ±0.5% of F.S., Voltage: ±0.25% of F.S.
Effects of changes in ambient temperature	±0.03%/°C for a temperature change rate of 10°C/h or less (when $0.05I_n \leq I \leq I_{max}$ and power factor = 1) ±0.05%/°C for a temperature change rate of 10°C/h or less (when $0.1I_n \leq I \leq I_{max}$ and power factor = LAG0.5) In: rated current; I: present current input
Effects of power supply voltage variations	Active power: ±0.25%, Voltage/Current: ±0.125% (for variations within the power supply operating range (when $0.01I_n$ and power factor = 1)) In: rated current
Effects of input frequency	Active power: ±0.25%, Voltage/Current: ±0.125% (for variations of 45 to 65 Hz)
Power supply	100 - 240 V AC ±10% (50/60 Hz) or 130 - 300 V DC ±15%
Power consumption	AC drive 10 VA maximum
	DC drive 5 W maximum

Safety and EMC Standards

Safety standards	Compliant with UL61010-1 CAN/CSA C22.2 No.61010-1-04 (C-UL Listed)															
	Measurement category: 600V CAT.III															
	<table border="1"> <thead> <tr> <th>Measurement category</th> <th>Descriptions</th> <th>Remarks</th> </tr> </thead> <tbody> <tr> <td>CAT . I</td> <td>Circuits not directly connected to the main power supply</td> <td></td> </tr> <tr> <td>CAT . II</td> <td>Circuits directly connected to low-voltage facility</td> <td>House-use equipment, portable tools, etc.</td> </tr> <tr> <td>CAT . III</td> <td>Circuits in building facility</td> <td>Switchboards, circuit breakers, etc.</td> </tr> <tr> <td>CAT . IV</td> <td>Power sources for low-voltage facility</td> <td>Overhead lines, cable systems, etc.</td> </tr> </tbody> </table>	Measurement category	Descriptions	Remarks	CAT . I	Circuits not directly connected to the main power supply		CAT . II	Circuits directly connected to low-voltage facility	House-use equipment, portable tools, etc.	CAT . III	Circuits in building facility	Switchboards, circuit breakers, etc.	CAT . IV	Power sources for low-voltage facility	Overhead lines, cable systems, etc.
Measurement category	Descriptions	Remarks														
CAT . I	Circuits not directly connected to the main power supply															
CAT . II	Circuits directly connected to low-voltage facility	House-use equipment, portable tools, etc.														
CAT . III	Circuits in building facility	Switchboards, circuit breakers, etc.														
CAT . IV	Power sources for low-voltage facility	Overhead lines, cable systems, etc.														
	Mains supply installation category: CAT.II Pollution degree: 2															
	Rated measurement input Voltage input: 600 V AC (between terminals) Current input: 600 V AC (across ground)															
EMC-compliant standard	KC marking: Electromagnetic wave interference prevention standard, electromagnetic wave protection standard compliance															

Environmental Conditions

Normal operating conditions	
Warm-up time	At least 30 minutes
Ambient temperature	0 to 50°C (reference temperature: 23±2°C)
Temperature change	10°C/h or less
Ambient humidity	20 to 90% RH (no condensation)
Magnetic field	400A/m or less
Continuous vibration	10 to 60 Hz, 0.035 mm, 75 minutes; 60 to 150 Hz, 4.9 m/s ² , 75 minutes
Short-time vibration	14.7 m/s ² for 15 seconds or less
Shock	98 m/s ² or less (for shock time of 11 ms)
Installation	Indoor installation only
Mounting position	Vertical surface mounting only
Installation altitude	2000 m or less
Effect on operating conditions	
Effects of ambient temperature	Analog output: ±0.05% of F.S./°C or less
Effects on power supply voltage variations	Analog output: ±0.05% of F.S./°C or less
Transport and storage conditions	
Temperature	-20 to 70°C
Humidity	5 to 95% RH (no condensation)
Shock and dropping of package	90 cm (provided that an external packing box is used)

Mounting and Shape

Materials	Casing	Polycarbonate resin (PC), UL94 V-0
	Terminal block	Polybutylene terephthalate (PBT), UL94 V-0
	Terminal cover	Polyamide resin (PA6), UL94 V-2
Mounting method	Panel mounting	
Connection Method	M3 screws for terminal connections (analog output, pulse output, demand alarm output, digital input, and RS-485 communication)	
	M4 screws for terminal connections (voltage/current input and power supply)	
	RJ45 connection (Ethernet communication, when the Ethernet communication function is specified)	
External Dimensions (including a terminal cover)	110 × 110 × 128 mm (H × W × D)	
	96 × 96 × 126 mm (H × W × D)	
	Approx. 600 g (when accessories such as mounting bracket are attached)	
Weight	Approx. 600 g (when accessories such as mounting bracket are attached)	

Appendix 2 System Reset

There are two methods of performing system reset:

- Turn off the power of the PR300 and then turn it on again.
- Execute remote reset via communication (for remote reset, refer to the PR300 Power and Energy Meter Communication Interface User's Manual: IM 77C01E01-10E)

Measured values to be reset

If system reset is executed, the following measured values will be reset.

- Maximum value, minimum value, and instantaneous value of voltage
- Maximum value and instantaneous value of current
- Optional active energy value

The values of active energy (regenerative energy), reactive energy, and apparent energy, as well as the settings set to parameters are not reset and are saved.

Actions after reset

The PR300 displays the Startup screen (where the station number can be seen) for about 5 seconds and then the Measured Value screen.

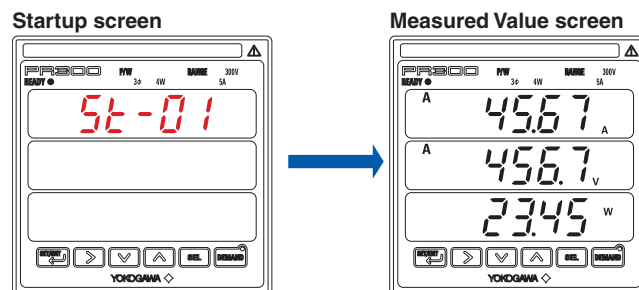

Appendix 3 Parameter Map

Some of the following parameters cannot be displayed due to the specifications of the PR300.

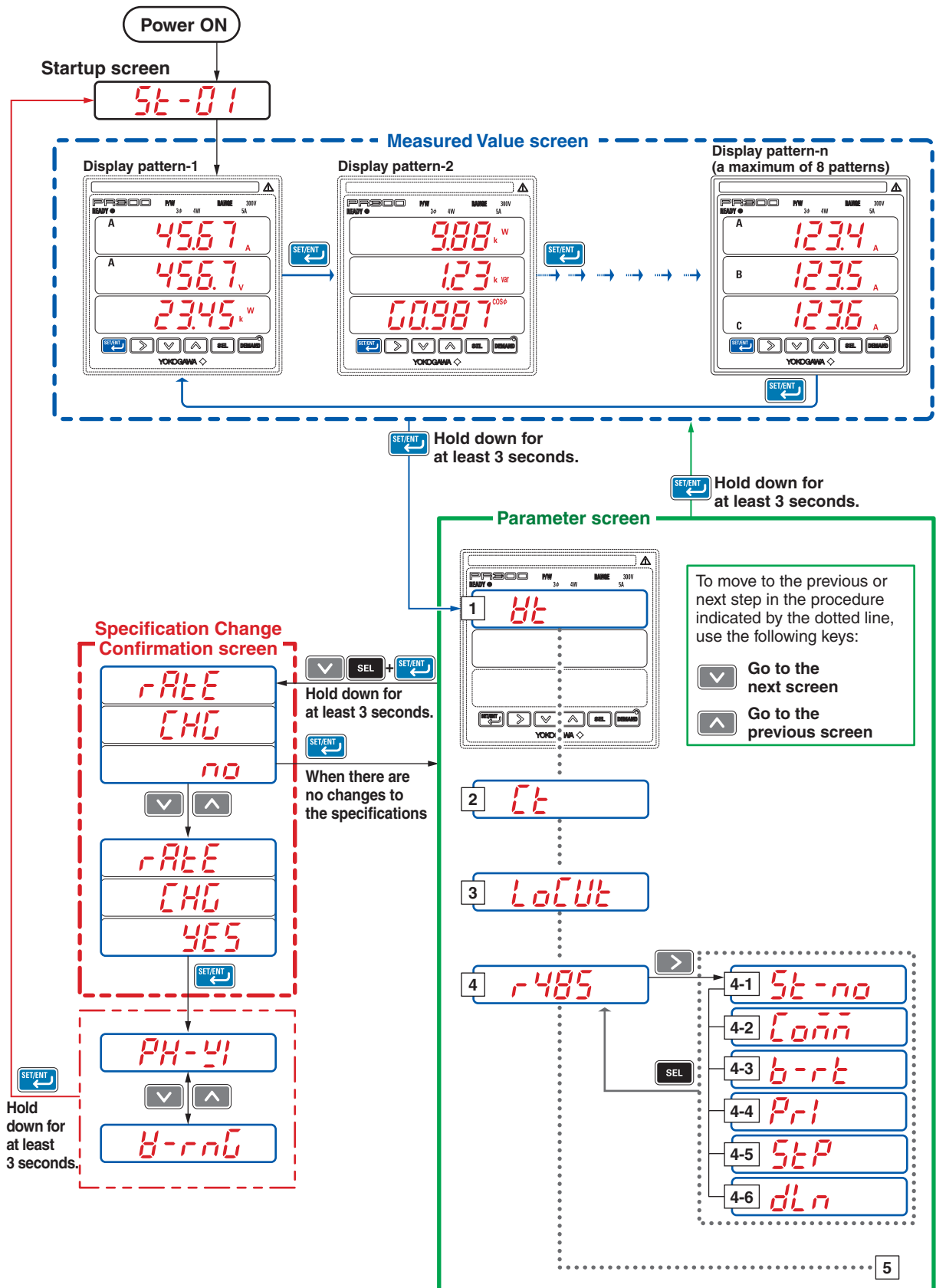

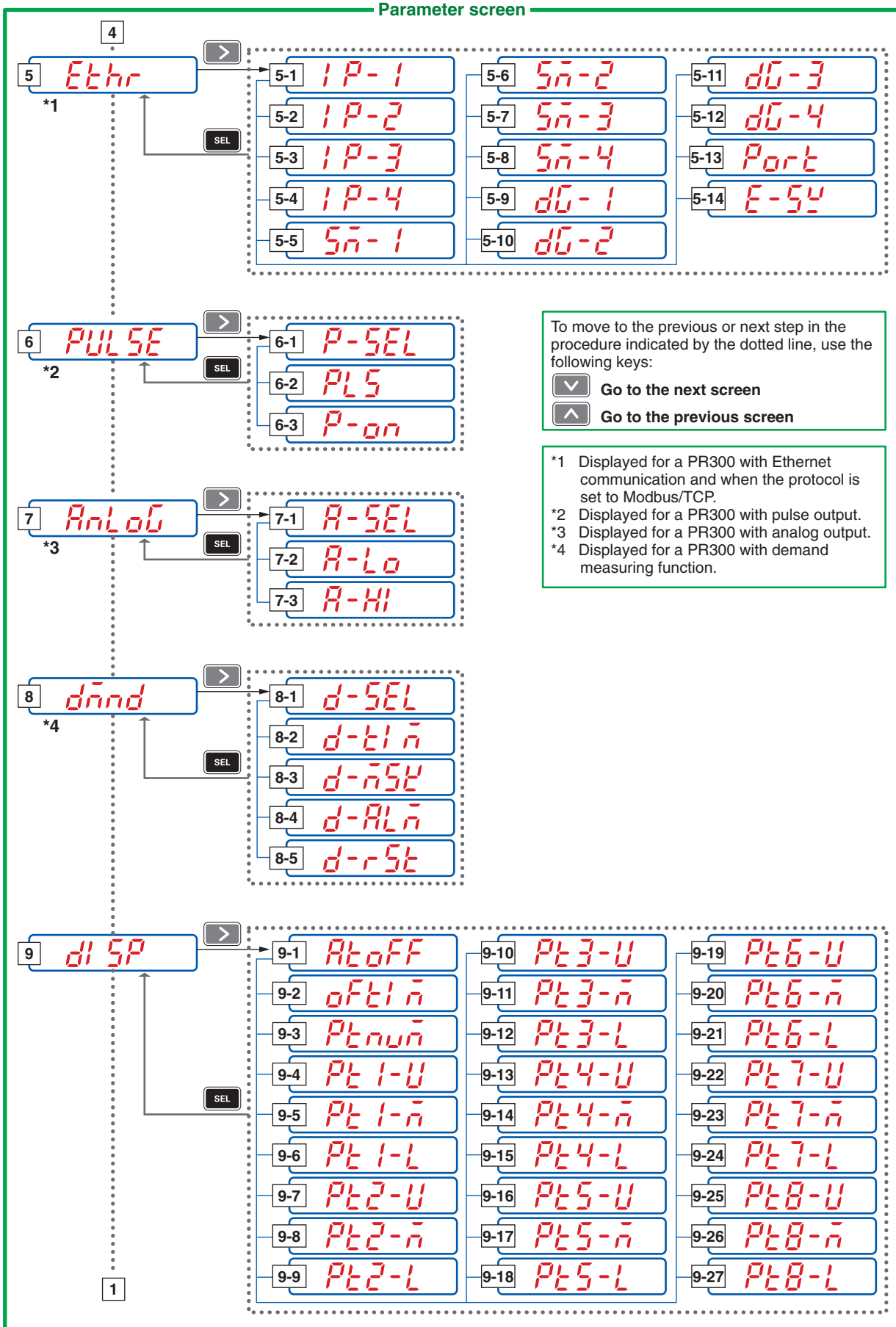

Appendix 4 Parameter List

Display Order	Parameter Symbol	Parameter Name	Setting Type	Setting Range (Details)	Initial Value (Factory-set Value)	MEMO
1	<i>vt</i>	VT ratio	Integral numeric value	1 to 6000	1	
2	<i>ct</i>	CT ratio	Floating-point numeric value	0.05 to 32000	1.00	
3	<i>LoCut</i>	Integrated low-cut power	Fixed-point numeric value	0.05 to 20.00 (%)	0.05	
4	<i>r485</i>	RS-485 communication menu	—	Menu to shift to the parameters of RS-485 communication	—	
4-1	<i>St-no</i>	Station number	Integral numeric value	1 to 99	1	
4-2	<i>Co\bar{n}n</i>	Protocol	Selection	PC link without checksum <i>PCLk1</i> PC link with checksum <i>PCLk2</i> Modbus/ASCII <i>n ASC</i> Modbus/RTU <i>n rtu</i> Modbus/TCP (*1) <i>n TCP</i> PR201 original <i>Pr201</i>	PC link with checksum	
4-3	<i>b-rt</i>	Baud rate	Selection	2400 bps <i>2400</i> 9600 bps <i>9600</i> 19200 bps <i>19200</i>	9600 bps	
4-4	<i>Pr1</i>	Parity (*3)	Selection	NONE <i>none</i> EVEN <i>even</i> ODD <i>odd</i>	NONE	
4-5	<i>StP</i>	Stop bit (*3)	Selection	1 bit <i>1</i> 2 bits <i>2</i>	1	
4-6	<i>dLn</i>	Data length (*2) (*3)	Selection	8 bits <i>8</i> 7 bits <i>7</i>	8	
*1 Only the PR300 with the Ethernet communication function can be selected. *2 Select "8" if you selected Modbus/RTU for the protocol. *3 Select NONE for Parity, 1 bit for Stop bit, and 8 bits for Data length if you have selected PR201 original for the protocol option.						
5	<i>Ethr</i>	Ethernet communication menu (Displayed only for a PR300 with the Ethernet communication function.)	—	Menu to shift to the parameters of Ethernet communication	—	
5-1	<i>IP-1</i>	IP address-1	Integral numeric value	0 to 255	192	
5-2	<i>IP-2</i>	IP address-2		0 to 255	168	
5-3	<i>IP-3</i>	IP address-3		0 to 255	1	
5-4	<i>IP-4</i>	IP address-4		0 to 255	1	
5-5	<i>Sn-1</i>	Subnet mask-1	Integral numeric value	0 to 255	255	
5-6	<i>Sn-2</i>	Subnet mask-2		0 to 255	255	
5-7	<i>Sn-3</i>	Subnet mask-3		0 to 255	255	

Display Order	Parameter Symbol	Parameter Name	Setting Type	Setting Range (Details)	Initial Value (Factory-set Value)	MEMO
5-8	Sn-4	Subnet mask-4	Integral numeric value	0 to 255	0	
5-9	dG-1	Default gateway-1	Integral numeric value	0 to 255	0	
5-10	dG-2	Default gateway-2		0 to 255	0	
5-11	dG-3	Default gateway-3		0 to 255	0	
5-12	dG-4	Default gateway-4		0 to 255	0	
5-13	Port	Port number	Integral numeric value	502, 1024 to 65535	502	
5-14	E-SW	Ethernet setting switch	Selection	ON OFF	—	
6	PULSE	Pulse output menu (Displayed only for a PR300 with pulse output.)	—	Menu to shift to the parameters of pulse output	—	
6-1	P-SEL	Measurement item for pulse output	Selection	Active energy Regenerative energy LEAD reactive energy LAG reactive energy Apparent energy	Active energy	
6-2	PLS	Pulse unit	Fixed-point numeric value	0.1 to 5000.0 (k)	1.0	
6-3	P-on	ON pulse width	Integral numeric value	10 to 1270 (ms)	50	
7	AnLoG	Analog output menu (Displayed only for a PR300 with analog output.)	—	Menu to shift to the parameters of analog output	—	
7-1	A-SEL	Measurement item for analog output	Selection	Active power Reactive power Apparent power Voltage-1 Voltage-2 Voltage-3 Current-1 Current-2 Current-3 Power factor Frequency	Active power	
7-2	A-Lo	Lower limit of scaling	Fixed-point numeric value	0.0 to 50.0 (%)	50.0	
7-3	A-HI	Upper limit of scaling	Fixed-point numeric value	50.0 to 100.0 (%)	100.0	
8	dand	Demand measurement menu (Displayed only for a PR300 with demand measuring function.)	—	Menu to shift to the parameters of demand measurement	—	
8-1	d-SEL	Demand power/current	Selection	Active power Current	Active power	

Appendix 4 Parameter List

Display Order	Parameter Symbol	Parameter Name	Setting Type	Setting Range (Details)	Initial Value (Factory-set Value)	MEMO
8-2	d-tlā	Demand period	Integral numeric value	1 to 60 (min) (Demand alarm mask time to 60) (min)	30	
8-3	d-ā5t	Demand alarm mask time	Integral numeric value	1 to 59 (min) (1 to demand period) (min)	1	
8-4	d-ALā	Demand alarm point	Integral numeric value	1 to 1000 (kW) or 1 to 1000 (A)	100	
8-5	d-r5t	Demand alarm release function	Selection	Automatic release <i>Auto</i> Manual release <i>ānānūL</i>	Automatic release	
9	di5P	Display setting menu	—	Menu to shift to the parameters of display setting	—	
9-1	AtōFF	Indicator-out mode	Selection	ON <i>on</i> OFF <i>ōFF</i>	OFF	
9-2	ōftlā	Indicator-out mode wait time	Integral numeric value	1 to 60 (min)	10 (min)	
9-3	Ptānūā	Number of display patterns	Integral numeric value	1 to 8	1	
9-4	Pt1-U	Display pattern-1 upper display	Selection	A measurement item can be selected from the following: None <i>nōnē</i> Active energy <i>Wh</i> Regenerative energy <i>-Wh</i> LEAD reactive energy <i>-Whr-h</i> LAG reactive energy <i>Whr-h</i> Apparent energy <i>Whh</i> Active power <i>WAtt</i> Reactive power <i>Whr</i> Apparent power <i>Wh</i> Voltage (phase switch indication) <i>V</i> Voltage-1 <i>V-1</i> Voltage-2 <i>V-2</i> Voltage-3 <i>V-3</i> Current (phase switch indication) <i>A</i> Current-1 <i>A-1</i> Current-2 <i>A-2</i> Current-3 <i>A-3</i> Power factor <i>PF</i> Frequency <i>Freq</i> Optional active energy <i>WhoP</i> Demand value <i>dānd</i> Maximum demand value <i>d-ānāll</i>	Current (phase switch indication)	
9-5	Pt1-ā	Display pattern-1 middle display			Voltage (phase switch indication)	
9-6	Pt1-L	Display pattern-1 lower display			Active power	
9-7	Pt2-U	Display pattern-2 upper display			Active power	
9-8	Pt2-ā	Display pattern-2 middle display			Reactive power	
9-9	Pt2-L	Display pattern-2 lower display			Power factor	
9-10	Pt3-U	Display pattern-3 upper display			Active energy	
9-11	Pt3-ā	Display pattern-3 middle display			LEAD reactive energy	
9-12	Pt3-L	Display pattern-3 lower display			Apparent energy	
9-13	Pt4-U	Display pattern-4 upper display			Current-1	
9-14	Pt4-ā	Display pattern-4 middle display			Current-2	
9-15	Pt4-L	Display pattern-4 lower display			Current-3	
9-16	Pt5-U	Display pattern-5 upper display			Voltage-1	
9-17	Pt5-ā	Display pattern-5 middle display			Voltage-2	
9-18	Pt5-L	Display pattern-5 lower display			Voltage-3	

Display Order	Parameter Symbol	Parameter Name	Setting Type	Setting Range (Details)	Initial Value (Factory-set Value)	MEMO
9-19	<i>PL6-U</i>	Display pattern-6 upper display	Selection	Refer to the previous page.	Current (phase switch indication)	
9-20	<i>PL6-n</i>	Display pattern-6 middle display			Voltage (phase switch indication)	
9-21	<i>PL6-L</i>	Display pattern-6 lower display			Frequency	
9-22	<i>PL7-U</i>	Display pattern-7 upper display			Current (phase switch indication)	
9-23	<i>PL7-n</i>	Display pattern-7 middle display			Active power	
9-24	<i>PL7-L</i>	Display pattern-7 lower display			Power factor	
9-25	<i>PL8-U</i>	Display pattern-8 upper display			Active power	
9-26	<i>PL8-n</i>	Display pattern-8 middle display			Maximum demand value	
9-27	<i>PL8-L</i>	Display pattern-8 lower display			Demand value	

Range of Phase and Wire System Options and Voltage Range Options

Phase and Wire System

Parameter Symbol	Parameter Name	Setting Type	Setting Range (Details)		Initial Value (Factory-set Value)	MEMO		
			Model and Suffix Codes					
<i>PH-YI</i>	Phase and wire system	Selection	PR300-3□□□□-6□-0	Single-phase two-wire system	<i>1P2Y</i>	Three-phase three-wire system		
				Single-phase three-wire system	<i>1P3Y</i>			
				Three-phase three-wire system	<i>3P3Y</i>			
				PR300-4□□□□-6□-0	Single-phase two-wire system		<i>1P2Y</i>	Three-phase four-wire system
					Single-phase three-wire system		<i>1P3Y</i>	
					Three-phase three-wire system		<i>3P3Y</i>	
			PR300-5□□□□-6□-0	Three-phase four-wire system	<i>3P4Y</i>	Three-phase four-wire system (2.5 element)		
				Three-phase four-wire system (2.5 element)	<i>2.5E</i>			

Voltage Range

Parameter Symbol	Parameter Name	Setting Type	Setting Range (Details)	Initial Value (Factory-set Value)	MEMO
<i>V-rnV</i>	Voltage range	Selection	150V	<i>150V</i>	300V
			300V	<i>300V</i>	
			600V	<i>600V</i>	

Appendix 5 Alphanumeric Characters Table for 7-segment LED

The PR300 uses a 7-segment LED as its display. It displays alphanumeric characters according to the table below (however, the table also contains characters that are not used by the PR300).

	0		A		J		T
	1		B		K		U
	2		C		L		u
	3		D		M		V
	4		E		N		W
	5		F		O		X
	6		G		P		Y
	7		H		Q		Z
	8		h		R		
	9		I		S		



NOTE

The PR300 displays H and U in two different forms (uppercase and lowercase) for easy viewing.

Index

A

Analog output conditions setting 3-12

C

Component names and functions 2-1

CT ratio setting 3-3

D

Demand 4-12

 Demand alarm 4-14

 Demand alarm mask time 4-14

 Demand alarm release function 4-14

 Demand measurement conditions setting 3-14

 Measurement example 4-14

 Measuring operation 4-13

 Measuring range 4-12

Display pattern 4-2

Dust cover 1-9

E

Energy value display operation 4-8

Error display and recommended response 5-1

Ethernet communication conditions setting 3-8

External Dimensions

 ANSI 4-inch round form size 1-1

 DIN 96-square instrument size 1-3

H

How to switch between instantaneous value, maximum 4-5

I

Indicator-out mode setting 3-19

Integrated low-cut power 3-5

Integrated low-cut power setting 3-4

M

Measured value display pattern setting 3-16

Measured value reset 4-10

Measurement items 4-1

Measuring range

 Active energy 4-7

 Active power 4-3

 Apparent energy 4-7

 Apparent power 4-3

 Current 4-4

 Frequency 4-5

 Power factor 4-4

 Reactive energy 4-7

 Reactive power 4-3

 Regenerative energy 4-7

 Regenerative power 4-3

 Voltage 4-4

Mounting method

 ANSI 4-inch round form size 1-2

 DIN 96-square instrument size 1-4

O

Optional integrating function 4-9

P

Panel cutout dimensions

 ANSI 1-1

 DIN 1-3

Parameter list A-12

Parameter lock and Unlock 3-20

Parameter map A-10

Parameter setting

 Analog output conditions 3-12

 CT ratio 3-3

 Demand measurement conditions 3-14

 Ethernet communication conditions 3-8

 Indicator-out mode 3-19

 Integrated low-cut power 3-4

 Measured value display pattern 3-16

 Phase and wire system 2-2

 Pulse output conditions 3-10

 RS-485 Communication Conditions 3-6

 Voltage range 2-4

 VT ratio 3-2

Phase and wire system setting 2-2

Phase switching 4-6

Pulse output conditions setting 3-10

R

RS-485 communication conditions setting 3-6

S

Specifications

 Analog output specifications A-3

 Communication specifications A-4

 Compliance with safety and EMC standards A-7

 Demand alarm Output specifications A-4

 Digital input specifications A-3

 Environmental Conditions A-8

 Input specifications A-2

 Measuring function A-1

 Mounting and Shape A-8

 Pulse output specifications A-3

 Standard performance A-6

System reset A-9

T

Terminal cover 1-9

V

Voltage range setting 2-4

VT ratio setting 3-2

W

Wiring diagram

Single-phase two-wire system	1-6
Single-phase three-wire system	1-6
Three-phase three-wire system	1-6
Three-phase four-wire system	1-7
Three-phase four-wire system (2.5 element)	1-7
Analog output	1-8
Demand alarm output	1-8
Demand alarm release	1-8
Ethernet communication	1-8
Integration control signal	1-8
Pulse output	1-8
RS-485 communication	1-8



YOKOGAWA ELECTRIC CORPORATION

Headquarters

9-32, Nakacho, 2-chome, Musashino-shi, Tokyo, 180-8750 JAPAN
Phone : 81-422-52-5555

Branch Sales Offices

Osaka, Nagoya, Hiroshima, Kurashiki, Fukuoka, Kitakyusyu

YOKOGAWA CORPORATION OF AMERICA

Head Office

12530 West Airport Blvd, Sugar Land, Texas 77478, USA
Phone : 1-281-340-3800 Fax : 1-281-340-3838

Georgia Office

2 Dart Road, Newnan, Georgia 30265, USA
Phone : 1-800-888-6400 Fax : 1-770-254-0928

YOKOGAWA AMERICA DO SUL LTDA.

Praca Acapulco, 31 - Santo Amaro, São Paulo/SP, BRAZIL, CEP-04675-190
Phone : 55-11-5681-2400 Fax : 55-11-5681-4434

YOKOGAWA EUROPE B. V.

Euroweg 2, 3825 HD Amersfoort, THE NETHERLANDS
Phone : 31-88-4641000 Fax : 31-88-4641111

YOKOGAWA ELECTRIC CIS LTD.

Grokholsky per 13 Building 2, 4th Floor 129090, Moscow, RUSSIA
Phone : 7-495-737-7868 Fax : 7-495-737-7869

YOKOGAWA CHINA CO., LTD.

3F Tower D Cartelo Crocodile Building, No.568 West Tianshan Road,
Shanghai 200335, CHINA
Phone : 86-21-62396262 Fax : 86-21-62387866

YOKOGAWA ELECTRIC KOREA CO., LTD.

(Yokogawa B/D, Yangpyeong-dong 4-Ga), 21, Seonyu-ro 45-gil, Yeongdeungpo-gu,
Seoul, 07209, KOREA
Phone : 82-2-2628-6000 Fax : 82-2-2628-6400

YOKOGAWA ENGINEERING ASIA PTE. LTD.

5 Bedok South Road, Singapore 469270, SINGAPORE
Phone : 65-6241-9933 Fax : 65-6241-2606

YOKOGAWA INDIA LTD.

Plot No.96, Electronic City Complex, Hosur Road, Bangalore - 560 100, INDIA
Phone : 91-80-4158-6000 Fax : 91-80-2852-0625

YOKOGAWA AUSTRALIA PTY. LTD.

Tower A, 112-118 Talavera Road, Macquarie Park NSW 2113, AUSTRALIA
Phone : 61-2-8870-1100 Fax : 61-2-8870-1111

YOKOGAWA MIDDLE EAST & AFRICA B.S.C.(C)

P.O. Box 10070, Manama, Building 577, Road 2516, Busaiten 225, Muharraq,
BAHRAIN
Phone : 973-17-358100 Fax : 973-17-336100