



Muting Module MM2-TA-12B

(Category 2 per EN 954-1)

Instruction Manual

Muting Module Features

- Compact housing meets IP65 requirements; can be mounted inside or outside a control panel, near the point of safeguarding.
- For use with EZ-SCREEN® Type 2 Output Signal Switching Device (OSSD) outputs, 24V dc signals or other safety devices with hard relay contact safety output(s).
- Monitors two or four inputs to automatically suspend the safety function of a safeguarding device or system.
- Safety stop interface (SSI) for connection of supplemental safeguarding devices or E-stops.
- Selectable external device monitoring (EDM).
- Selectable Automatic or Monitored Manual Reset provides flexibility for point-of-operation or perimeter guarding.
- Diverse-redundant solid-state safety outputs.
- Status LEDs and two-digit Diagnostic Display indicate module status.
- Eight Euro-style quick-disconnect I/O ports for mute device inputs, mute lamp output, override, SSI, and reset. Molded or field-wireable cable QDs are available.
- Two Mini-style quick-disconnects for interfacing with the safety system and machine control.
- Easy configuration for:
 - Auto/manual reset
 - One-/two-channel EDM
 - One-/two-direction muting
 - Selectable mute enable
 - Monitored/non-monitored mute lamp
 - Selectable backdoor timer
 - Selectable mute on power-up



Section Contents

Section 1	Introduction	Page 1
Section 2	Specifications	Page 8
Section 3	System Installation	Page 14
Section 4	Operating Instructions	Page 36
Section 5	Troubleshooting and Maintenance	Page 37
Section 6	Checkout Procedures	Page 39
	Appendix	Page 42

Important ... read this before proceeding!

In the United States, the functions that the Banner MM2-TA-12B Muting Module is intended to perform are regulated by the Occupational Safety and Health Administration (OSHA). Outside of the United States, these functions are regulated by a variety of agencies, organizations, and governments. Whether or not any particular MM2-TA-12B Muting Module installation meets all applicable requirements depends upon factors that are beyond the control of Banner Engineering Corp. These factors include the details of how the MM2-TA-12B Muting Module is applied, installed, wired, operated, and maintained. **It is the responsibility of the installer and user to apply this MM2-TA-12B Muting Module in full compliance with all applicable regulations and standards.**

The Banner MM2-TA-12B Muting Module can guard against accidents only when it is properly installed and integrated into the machine, properly operated, and properly maintained. Banner Engineering Corp. has attempted to provide complete application, installation, operation, and maintenance instructions. In addition, we suggest that any questions regarding application or use of the MM2-TA-12B Muting Module be directed to the factory applications department at the telephone number or addresses shown on the back cover.

In addition to OSHA regulations, several other organizations provide informational material on the use of safeguarding devices. The user is referred to the American National Standards Institute (ANSI), the Robotics Industries Association (RIA), the Association for Manufacturing Technology (AMT), and others. Banner Engineering Corp. makes no claim regarding a specific recommendation of any organization, the accuracy or effectiveness of any information provided, or the appropriateness of the provided information for a specific application. **See Appendix C for information pertaining to applicable U.S., European, and International standards and where to acquire copies.**

The user has the responsibility to ensure that all local, state, and national laws, rules, codes, and regulations relating to the use of this safeguarding system in any particular application are satisfied. Extreme care is urged to ensure that all legal requirements have been met and that all installation and maintenance instructions contained in this manual are followed.

1. Introduction	page 1
1.1 Overview	page 1
1.2 Operating Status LEDs and Diagnostic Display	page 2
1.3 Automatic or Monitored Manual Reset Select	page 2
1.4 Lockout Conditions	page 3
1.5 Control Reliability and “Safety” Categories	page 3
1.6 Muteable Safety Stop Interface (MSSI)	page 3
1.7 Safety Stop Interface (SSI)	page 4
1.8 OSSD Outputs	page 4
1.9 Auxiliary Output (Aux)	page 4
1.10 External Device Monitoring (EDM)	page 4
1.11 Mute Devices and Mute Inputs (M1-M4)	page 5
1.12 Mute Enable (ME)	page 5
1.13 Mute Lamp Output (ML)	page 6
1.14 Backdoor Timer	page 6
1.15 Mute on Power-Up	page 6
1.16 Override	page 7
1.17 One-Way/Two-Way Muting	page 7
1.18 Designated and Qualified Persons	page 7
2. Specifications	page 8
2.1 Accessory Cordset Selection	page 10
2.2 Accessories	page 13
3. System Installation	page 14
3.1 Applications and Limitations	page 14
3.2 Installing the Module	page 17
3.3 Muting Module Configuration	page 17
3.4 Connector Pinouts and Functions	page 18
3.5 Installing Input Devices	page 19
3.6 Machine Interface – Initial Hookup and Checkout	page 28
3.7 Permanent Hookup	page 30
3.8 Commissioning Checkout	page 32
4. Operating Instructions	page 36
4.1 Security Protocol	page 36
4.2 Periodic Checkout Requirements	page 36
4.3 Normal Operation	page 36
5. Troubleshooting and Maintenance	page 37
5.1 Troubleshooting Lockout Conditions	page 37
5.2 Diagnostic Display	page 37
5.3 Effects of Electrical Noise	page 37
5.4 Repairs	page 37
6. Periodic Checkout Procedures	page 39
6.1 Schedule of Checkouts	page 39
6.2 Commissioning Checkout	page 39
6.3 Daily Checkout	page 41
6.4 Semi-Annual Checkout	page 41

Appendix

Appendix A, Mute Timing Sequences	page 42
Appendix B, Typical Muting Applications	page 43

1. Introduction

1.1 Overview

The Banner MM2-TA-12B Muting Module is an accessory component of a safeguarding system, which may incorporate such primary safeguards as safety light screens, safety interlocked gates/guards, or other presence-sensing safeguarding devices (PSSDs). The Module allows the machine to mute the primary safeguard by monitoring redundant inputs (two or four) and automatically suspend the safeguarding function of a safeguarding device during the non-hazardous portion of the machine cycle.

In this manual, the term “muting” refers to the automatic suspension of the safeguarding function of the primary safety device during a non-hazardous portion of the machine cycle. (During the non-hazardous portion of the machine cycle, personnel are not exposed to harm.)

The muting function allows material to be manually or automatically fed into or removed from a machine process, without tripping the primary safeguard.

Individual features discussed in the following sections are:

- Operating Status LEDs and Diagnostic Display
- Auto/manual reset
- Lockout conditions
- Control reliability
- Mutable Safety Stop Interface (MSSI)
- Safety Stop Interface (SSI)
- Output Signal Switching Device (OSSD) outputs
- Auxiliary (AUX) output
- External device monitoring (EDM)
- Mute devices and mute inputs (M1- M4)
- Mute enable input (ME)
- Mute lamp output (ML)
- Backdoor timer
- Mute on power-up
- Override
- One-way/two-way muting

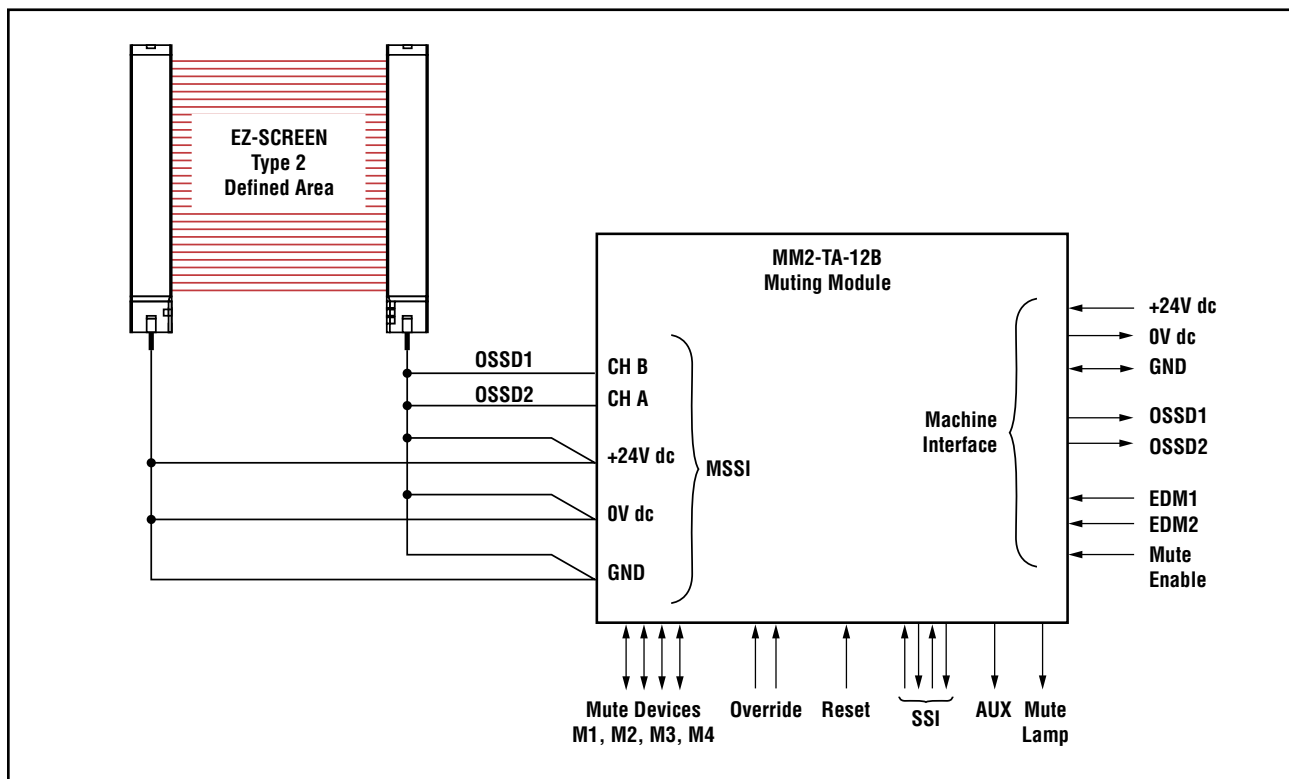

Figure 1-1. Block diagram of a safeguarding system employing the MM2-TA-12B Muting Module and a safety light screen (user-supplied) as a primary safety device

1.2 Operating Status LEDs and Diagnostic Display

The Module has three Operating Status LEDs (one each red, yellow and green), plus a 2-digit Diagnostic Display, visible through a window in the front panel. The individual LEDs provide constant, ongoing system status information at a glance. The Diagnostic Display provides error codes that correspond to the cause of a fault or configuration error which results in a lockout, and other more detailed conditions. See Sections 4 and 5 for further information.

1.3 Automatic or Monitored Manual Reset Select

The selectable Automatic or Monitored Manual Reset provides flexibility for the user that has applications in which the operator is continually sensed, or in applications where the operator can pass through and become clear of the sensing field. See Section 3.1.4, "Pass-through hazards."

The configuration is selected via two banks of DIP switches located inside the Module's configuration port (see Figures 1-2 and 3-2).

Monitored Manual Reset

Manual Reset is typically used in situations where an individual can pass through a sensing field and become clear of a safeguarding device, such that the device can no longer prevent hazardous motion (e.g., perimeter guarding). The Module "monitors" the input for two transitions: from open-to-closed, and from closed-to-open within a certain time period. This prevents the reset button from being tied down or failing in a closed condition, and causing an unintended or automatic reset.

Upon power-up, when the Module has been configured for manual reset, for the OSSD outputs to turn ON, both the MSSSI and the SSI must both be active (closed) and a monitored manual reset must be accomplished. The reset is accomplished by closing the RESET input for a minimum of 1/4 second, but not longer than 2 seconds and then re-opening the input. The OSSD outputs will turn ON once the open-closed-open action occurs.

In this configuration, the MM2-TA-12B Muting Module must be manually reset after power-up, lockouts, and after the cycling of either the MSSSI (not muted) or the SSI. The location for the manual reset device (e.g., a normally open key switch) must comply with the warning in Section 3.5.1 and refer to that section for further information on key resets.

Automatic Reset

Upon power-up, when the Module is configured for automatic reset, the OSSD outputs will automatically turn ON once power is applied, the self-test is accomplished, and the MSSSI and the SSI are active (closed). The OSSD outputs will also turn ON after either interface is opened and then re-closed. In either case, no external input or reset is required.

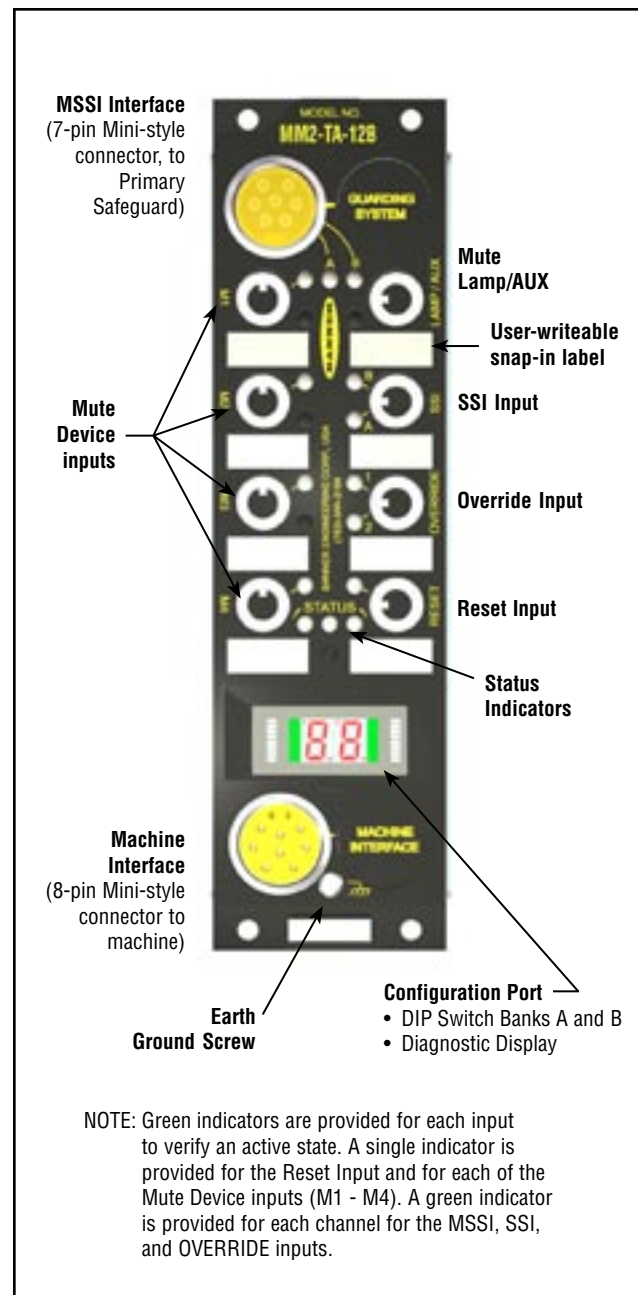

Figure 1-2. Muting Module features

Automatic reset is typically used in situations where an individual is continually sensed by the defined area or in situations where supplemental safeguards prevent the initiation of hazardous motion while an individual is within the safeguarded space (e.g. point-of-operation guarding).

In either case, a manual reset must be performed to recover from a lockout condition.

1.4 Lockout Conditions

A lockout condition of the Module will cause both OSSD outputs to go OFF and the Aux output to open. A lockout condition is indicated by a flashing Red status indicator and an error number displayed on the Diagnostic Display.

A description of possible lockouts, their causes, troubleshooting hints, and a Manual Reset routine are listed in Section 5.

1.5 Control Reliability and “Safety” Categories

To summarize the expected safety circuit performance in high-risk situations, requirements of Control Reliability (OSHA 29CFR1910.217, ANSI B11, and ANSI/RIA R15.06) and Categories 3 and 4 (EN 954-1) demand that a reasonably foreseeable, single failure does not lead to the loss of the safety function, and does not prevent a normal or immediate stop from occurring. The failure or the fault must be detected at or before the next demand of safety (e.g., at the beginning or end of a cycle, or when a safeguard is actuated). The safety-related part of the control system then must issue an immediate stop command, or prevent the next machine cycle or hazardous situation until the failure or fault is corrected.

The effect of ANSI/RIA R15.06, ANSI B11, and EN 954-1 is to set a baseline for situations in which a minimum level of performance has been mandated or in cases where a risk assessment has determined a need for Control Reliability, Category 3 or Category 4 level of performance.

In lower-risk safety applications, safeguards and safety circuits do not require the level of performance and fault tolerance described by Control Reliability, Category 3 or Category 4. Applications involving situations that could result in a slight or normally reversible injury (e.g., only requiring first aid, as defined by OSHA 29CFR1904) can be solved by EN 954-1 Category 2.

EN 954-1 Category 2 does not require the same level of performance and fault tolerance as required by Control Reliability, Category 3 or Category 4. Safety-related parts of control systems designed to Category 2 “shall be designed so that their function(s) are checked at suitable intervals by the machine control system.” This allows a single fault to lead to the loss of the safety function between the check [test] of the system, but the loss of safety function is detected by the check. By comparison, in a system designed to EN 954-1 Category 4, a single fault or an accumulation of faults will not lead to a loss of the safety function.

“Category” describes differing requirements to ensure that appropriate safety-related performance is achieved. The appropriate category is dependent on the overall degree of risk reduction, as determined by the machine’s Risk Assessment (see ISO 14121, ANSI B11.TR3, ANSI/RIA R15.06).

The Module is designed to be continuously self-checking. A component failure detected by or within the self-checking system causes a “stop” signal to be sent to the guarded machine and puts the Module into a lockout condition.

Recovery from this type of lockout condition requires replacement of the failed component and the appropriate reset procedure (see Section 3.5.1). Possible causes are listed in Section 5. The Diagnostic Display is used to diagnose causes of a lockout condition (Section 5.1).

1.6 Muteable Safety Stop Interface (MSSI)

The Muteable Safety Stop Interface (MSSI) input is a specialized SSI that can be muted during the non-hazardous portion of the machine cycle and provides +24V dc supply power to the primary safety device that is to be muted.

The Module requires redundant input signals from the external primary safeguard which is to be muted. These inputs typically are either two Banner solid-state safety outputs from the EZ-SCREEN Type 2 light screen, two 24V dc signals, or two hard/relay contact outputs (e.g., FSDs) from an appropriate safety device. See Section 2, Specifications, and Section 3.5.5 for complete information.



WARNING . . . Emergency Stop Functions

Do not interface an Emergency Stop Button, a Rope/Cable Pull, or other actuator with the MSSI. ANSI/NFPA 79 and ISO 60204-1 require that the Emergency Stop function remain active at all times. **Muting will render the Emergency Stop function ineffective.**

1.7 Safety Stop Interface (SSI)

The Module has a provision for an additional Safety Stop Interface to connect an optional device, such as a supplemental safeguard, E-stop button, or safety switch(es), to issue a stop command. This dual-channel interface is similar to the MSSl, but is always functional, even when the primary safety device is being muted. See Sections 2, Specifications, and 3.5.5 for complete information.

1.8 OSSD Outputs

The Module has two solid-state safety outputs, labeled "OSSD1" and "OSSD2" (see Figure 1-1). These safety outputs are actively monitored to detect short circuits to the supply voltage, to each other, and to other sources of electrical energy. If a failure is detected, the outputs will switch to an OFF-state. For circuits requiring the highest level of safety and reliability, either OSSD must be capable of stopping the motion of the guarded machine in an emergency.

During the muted portion of the machine cycle, the MSSl inputs will be ignored and OSSD1 and OSSD2 will remain ON. During other portions (not muted) of the cycle, if the MSSl either open or go OFF, OSSD1 and OSSD2 will go OFF.

In any case, if the SSI interface opens, OSSD1 and OSSD2 will go OFF. See Appendix A for timing diagrams.

1.9 Auxiliary Output (Aux)

The Auxiliary (Aux) monitoring PNP output is intended for non-safety related purposes. The status of this auxiliary output is indicated by the green status LED. See Section 3.5.3 for more information.

1.10 External Device Monitoring (EDM)

Two inputs are provided (see Figure 1.1) for monitoring the state of external devices, such as MPCEs. These terminals are labeled "EDM1" and "EDM2" at the Machine Interface connection. The Module's EDM inputs can be configured in three ways: one-channel, two-channel, or no monitoring (see Figure 3-2 for DIP switch settings and Section 3.7.2 for external hookup). One- and two-channel EDM is used when the OSSD outputs directly control the de-energizing of the MPCEs or external devices.

- **One-Channel Monitoring:** a series connection of closed monitor contacts that are forced-guided (or captive contact) from each device controlled by the Muting Module. The monitor contacts should open within 200 milliseconds of the OSSD outputs going ON (a GO condition) and should close within 200 milliseconds of the OSSD outputs going OFF and remain closed (a STOP condition), or a lockout will occur (see Diagnostic Display, Section 5.2).
- **Two-Channel Monitoring:** an independent connection of closed monitor contacts that are forced-guided (or captive contact) from each device controlled by the Muting Module. While the OSSDs are ON, the inputs may change state (either both open, or both closed). If the inputs remain in opposite states for more than 200 milliseconds, a lockout will occur. Additionally, both inputs must be closed 200 ms after the OSSD outputs go OFF or a lockout will occur (see Diagnostic Display, Section 5.2).
- **No Monitoring:** uses the "EDM Disable" configuration with inputs EDM1 and EDM2 left open (not connected). If the Module is set for No Monitoring, the user must ensure that any single failure of the external devices does not result in a hazardous condition and a successive machine cycle will be prevented (see Section 1.5, Control Reliability).

1.11 Mute Devices and Mute Inputs (M1 – M4)

Application of the Muting Function

To mute the primary safeguard appropriately, the design of a muting system must:

- 1) Identify the non-hazardous portion of the machine cycle,
- 2) Involve the selection of the proper muting devices, and
- 3) Include proper mounting and installation of those devices.

The Module can monitor and respond to redundant signals that initiate the mute. The mute then suspends the safeguarding function by ignoring the state of the MSS; this allows an object or person to pass through the defined area without generating a stop command. (This should not be confused with blanking, which disables one or more beams in a safety light screen, resulting in larger minimum object sensitivity.) See Appendix A for example mute timing sequences.

The mute may be triggered by a variety of external devices. This feature provides a variety of options (see Sections 3.5.2 - 3.5.3) to tailor the System to the requirements of a specific application.

A pair of muting devices must be triggered simultaneously (within 3 seconds of one another). This reduces the chance of common mode failures or defeat.



WARNING . . . Muting Limitations

Muting is allowed only during the non-hazardous portion of the machine cycle.

A muting application must be designed so that no single component failure can prevent the stop command or allow subsequent machine cycles until the failure is corrected.

Mute Devices

The beginning and end of a mute cycle must be triggered by outputs from either pair of muting devices, depending on the application. The mute device pairs both must have normally open contacts, or have one device with a PNP output and one device with a NPN output, both of which fulfill the “muting device requirements” in Section 2. These contacts must close (conducting) when the switch is actuated to initiate the mute, and must open (non-conducting) when the switch is not actuated and in a power-OFF condition.

The Module monitors the mute devices to verify that their outputs turn ON within 3 seconds of each other. If the inputs do not meet this simultaneity requirement, a mute condition can not occur.

Several types and combinations of mute devices can be used, including, but not limited to: limit switches, photoelectric sensors, positive-drive safety switches, inductive proximity sensors, and “whisker” switches. (See Muting Device Requirements, Section 3.5.2.1.)



WARNING . . . Mute Inputs Must Be Redundant

It is not acceptable to use a single switch, device, or relay with two N.O. contacts for the mute inputs. This single device, with multiple outputs, may fail so that the System is muted at an inappropriate time. **This may result in a hazardous situation.**

1.12 Mute Enable (ME)

The Mute Enable input is a non-safety-rated input. When the input is closed, the Module will allow a mute condition to occur; opening this input while the System is muted will have no effect. If the application does not require Mute Enable, the input must be left open and the DIP switches configured for “ME Disable = ON”.

Typical uses for Mute Enable include:

- To allow the machine control logic to create a “window” for muting to begin;
- To inhibit muting from occurring; or
- To reduce the chance of unauthorized or unintended bypassing or defeat of the safety system.

Simultaneity Timer Reset Function

The Mute Enable input can also be used to reset the simultaneity timer of the mute inputs. If one input is active for longer than three seconds before the second input becomes active, the simultaneity timer will prevent a mute cycle from occurring. This could be due to a normal stoppage of an assembly line that may result in blocking one mute device and the simultaneity time running out.

If the ME input is cycled (closed-open-closed) while one mute input is active, the simultaneity timer is reset, and if the second mute input becomes active within three seconds, a normal mute cycle begins. The timing requirement for the closed-open-closed is similar to the manual reset function. Initially, the input needs to be active (closed) for longer than 1/4 second, then open for longer than 1/4 second, but not longer than 2 seconds, and then must reclose to reset the simultaneity timer. The function can reset the timer only once per mute cycle (i.e., all mute inputs M1-M4 must open before another reset can occur).

1.13 Mute Lamp Output (ML)

Most applications require that a lamp (or other means) be used to indicate when the primary safety device (e.g., light screen) is muted; the control box provides for this (see WARNING at left). This indication is selectable between a monitored or a non-monitored output signal (NPN sinking). The monitored output will prevent the initiation of a mute after an indicator failure is detected (current draw falls below 10 mA or goes above 360 mA). If the muting function is to be used in a country governed by EN regulation (requiring the CE mark), Lamp Monitoring might be required and the lamp used must meet applicable requirements (see Section 3.5.3).



WARNING . . . Mute Status Must Be Readily Observable

Indication that the safety device is muted must be provided and must be readily observable.

Failure of this indication should be detectable and prevent the next mute, or the operation of the indicator should be verified at suitable intervals.

Lamp Monitoring might be required if the System is to be used in a country governed by EN regulation (i.e., requiring the CE marking).

1.15 Mute on Power-Up

The Backdoor Timer DIP switch settings also enable or disable the Mute on Power-Up function (see Figure 3-2). Mute Enable must be configured “functional” and be closed to allow Mute on Power-Up. (See WARNING at left.) If selected, the Mute on Power-Up function will initiate a mute when power is applied, the Mute Enable input is closed, the MSSI inputs are active (closed), and either M1-M2 or M3-M4 (but not all four) are closed.

If Auto Reset is configured, the Module allows 10 seconds for the MSSI and SSI to become active (closed), to accommodate systems that may not be immediately active at power-up.

If Manual Reset is configured, the first valid reset after the MSSI and SSI are active (closed) will result in a mute cycle if all other conditions are satisfied.



WARNING . . . Mute on Power-Up

The Mute on Power-Up function should be used only in applications where:

- Muting the System (M1 and M2 closed) when power is applied is required, and
- Using it can not, in any situation, expose personnel to any hazard.

1.14 Backdoor Timer

The Backdoor Timer allows the user to select a maximum period of time that muting is allowed to occur. This feature hinders the intentional defeat of the muting devices to initiate an inappropriate mute. It is also useful for detecting a common mode failure that would affect all mute devices in the application.

The timer begins when the second muting device makes the simultaneity requirement (within 3 seconds of the first device), and will allow a mute to continue for the predetermined time. After the timer expires, the mute ends – no matter what the signals from the mute devices indicate. If the MSSI is open, the OSSD outputs will turn OFF and must be manually reset (if Module is configured for Manual Reset). The Override function can be activated (see Section 1.16) to force the OSSDs ON in order to clear the obstruction.

If the Backdoor Timer expires, error code #50 will be displayed until all mute device inputs are open and the MSSI is active/closed.

The Backdoor Timer can be disabled (i.e., set for infinite time). See Figure 3-2 and configure DIP switches #7 and #8 for Backdoor Time-Out OFF.

1.16 Override

The Override function allows the user to manually force the OSSD outputs ON for 10 seconds in a situation such as an object becoming “stuck” in the defined area of a safety light screen after the mute ends (e.g., a car body on a transfer line entering a work cell). The feature is intended to allow the user to “jog” the part out of the defined area.

This input requires two normally open switches, both of which must be closed within 3 seconds of each other. The Override cycle will last a maximum of 10 seconds, after which the Override input must be released for at least 3 seconds prior to the next Override cycle. An Override can be initiated only after tripping of the MSSl inputs causes the Module to latch its OSSDs OFF.

NOTE: A stop command issued by the SSl cannot be overridden.

When Override is used, the following precautions must be taken:

- Prevent exposure to any hazard during an Override cycle,
- Provide a readily observable indication of an Override, and
- Provide supplemental safeguarding, per NFPA 79 and IEC/EN 60204-1.

The Override switches must be supervised and must prevent automatic operation. Also, one or more of the following must be true:

- Motion is initiated by a hold-to-run or similar device,
- If a portable control station (e.g., an enabling device) with an emergency stop device is used, motion may be initiated only from that station,
- Motion, speed, or power of the machine is limited, or
- The machine’s range of motion is limited.



WARNING . . . Limit Use of Override Function

The Override function is not for machine setup or production; it is to be used only to clear the primary safety device, such as if material becomes “stuck” in the defined area of a safety light screen.

When Override is used, it is the user’s responsibility to install and use it according to current standards (see Appendix C).

In addition, the requirements listed in standards NFPA 79 or IEC/EN 60204-1 must be satisfied.

1.17 One-Way/Two-Way Muting

One-way (directional) muting allows the safeguard to be muted only if mute devices are actuated in the order M1, M2, (mute initiated), M3, and M4. This method allows for a single-direction material flow and reduces the possibility of intentional defeat of the muting devices.

Two-way (non-directional) muting allows the safeguard to be muted any time the actuation of M1-M2 *or* M3-M4 meets the 3-second simultaneity requirement. This allows the flow of material from either direction (two-way material flow).

NOTE: When using four mute devices (M1, M2, M3 and M4), in order to extend the mute until the light screen is clear, the object must activate all four of the devices at one time during the mute cycle.

1.18 Designated and Qualified Persons

For the purposes of this manual, the following definitions apply:

Designated Person: A person or persons identified and designated in writing, by the employer, as being appropriately trained and qualified to perform a specified checkout procedure.

Qualified Person: A person or persons who, by possession of a recognized degree or certificate of professional training, or who, by extensive knowledge, training, and experience, has successfully demonstrated the ability to solve problems relating to the implementation of this safety system.

2. Specifications

System Power Requirements	+24V dc $\pm 15\%$ @ 400 mA max (not including draw of the MSSSI power, AUX, ML, M1-M4 and OSSD connections); see Section 3.4 for total current draw calculation.								
Supply Protection Circuitry	All inputs and outputs are protected from short circuit to +24V dc or dc common.								
Response Time	Muteable Safety Stop Interfaces (MSSI) and the Safety Stop Interfaces (SSI) are less than or equal to 10 ms.								
Outputs (see Warning on page 29)	<p>Two diverse-redundant solid-state safety outputs: 24V dc, 0.5A sourcing OSSD (output signal switching device). Compatible with Banner "Safety Handshake" protocol.</p> <p>ON-State voltage: $\geq V_{in} - 1.5V$ dc Max. leakage current*: 1.2 mA</p> <p>OFF-State voltage: 1.2V dc max. Max. load capacitance: 0.1 μF</p> <p>*Inclusive of faults (including open 0V dc wire)</p> <p>OSSD Test pulse width: 100 to 300 μs</p> <p>OSSD Test pulse period: 12 ms</p> <p>Non-safety auxiliary output: PNP solid-state output, rated at +24V dc @ 250 mA.</p>								
MSSI Power Connections	+24V dc $\pm 15\%$ @ 2.5A max. output (dependent on System power input). Resettable 2.5A fuse								
Status Indicator LEDs	<p>3 Status Indicator LEDs (Red, Green and Yellow): indicate Power ON/OFF, operating mode, lockout, override, and OSSD status</p> <p>Green LEDs adjacent to individual inputs/interfaces indicate status (ON = active/closed)</p>								
Diagnostic Code Display	Diagnostic Display is a two-digit numeric display that indicates the cause of lockout conditions and the amount of time, in seconds, remaining for the backdoor timer.								
Muting Lamp Output	<p>A monitored or non-monitored (selectable) sinking output. If monitoring has been selected, the current draw must be 10 mA to 360 mA. Interconnect wire resistance < 30 ohms.</p> <p>Maximum Switching Voltage: 30V dc</p> <p>Maximum Switching Current: 360 mA</p> <p>Minimum Switching Current: 10 mA</p> <p>Saturation Voltage: $\leq 1.5V$ dc @ 10 mA; $\leq 5V$ dc @ 360 mA</p>								
Controls and Adjustments	<p>All configured on 2 redundant banks of DIP switches:</p> <table border="0"> <tr> <td>Manual/auto reset</td> <td>One-way/two-way muting</td> </tr> <tr> <td>Monitored/non-monitored mute lamp output</td> <td>One-channel/two-channel/no EDM</td> </tr> <tr> <td>Backdoor timer</td> <td>Mute on power-up enable</td> </tr> <tr> <td>Mute enable functional/disabled</td> <td></td> </tr> </table>	Manual/auto reset	One-way/two-way muting	Monitored/non-monitored mute lamp output	One-channel/two-channel/no EDM	Backdoor timer	Mute on power-up enable	Mute enable functional/disabled	
Manual/auto reset	One-way/two-way muting								
Monitored/non-monitored mute lamp output	One-channel/two-channel/no EDM								
Backdoor timer	Mute on power-up enable								
Mute enable functional/disabled									
Inputs	<p>The MSSSI and the SSI can be interfaced with external safety devices that have either hard contact outputs, Banner EZ-SCREEN Type 2/Type 4 OSSD safety outputs (see Section 3.5.5), or 24V dc signals.</p> <p>Maximum external resistance must not exceed 1000 Ω per channel.</p> <p>Operating Range for MSSSI and SSI Inputs – Relay outputs or hard contacts must be capable of switching:</p> <p>OFF State: 0-3V, 0-2 mA</p> <p>ON State: 12-30V, 10-50 mA</p> <p>Muteable Safety Stop Interface (MSSI) This input consists of two channels (MSSI-A and MSSI-B), and can be muted when the requirements for a mute cycle have been met. When muted, the OSSDs remain ON, independent of the MSSI status. If not muted, anytime either or both channels open, the OSSD outputs will go OFF. (See Section 3.5.5 for further information.)</p> <p>Safety Stop Interface (SSI) This input consists of two channels (SSI-A and SSI-B), and is always active. Any time either or both channels open, the OSSD Outputs will go OFF. (See Section 3.5.5 for further information.)</p>								

External Device Monitoring (EDM)	Two pairs of terminals are provided to monitor the state of external devices controlled by the OSSD outputs. Each device must be capable of switching 15-30V dc at 10-50 mA.
Muting Device Inputs	The muting devices work in pairs (M1 and M2, M3 and M4) and are required to be "closed" within 3 seconds of each other (simultaneity requirement) to initiate a mute (assuming all other conditions are met). Each muting device must be capable of switching 15-30V dc at 10-50 mA.
Mute Enable Input	When Mute Enable is selected (functional), this input must have +24V dc applied in order to start a mute; opening this input after mute has begun has no effect. If Mute Enable is disabled, this input will be ignored and a mute cycle can occur regardless of the state of the mute enable input. The switching device must be capable of switching 15-30V dc at 10-50 mA.
Override Inputs	The two-channel inputs must be closed within 3 seconds of each other (simultaneity requirement) and held closed during the 10-second Override. To initiate a subsequent Override, open both channels, wait 3 seconds, and then re-close both channels (within 3 seconds). The switching devices must be capable of switching 15-30V dc at 10-50 mA.
Reset Input	Terminals must be closed for a minimum of 0.25 seconds and not more than 2.0 seconds in order to guarantee a reset. The switching device must be capable of switching 15-30V dc at 10-50 mA.
Mounting	4 mounting holes, 5.5 mm dia. (0.19"); see Figure 3.1.
Vibration Resistance	<p>Vibration: Frequency range: 10 to 55 Hz Sweep rate: 1 octave/minute Amplitude: 0.35 mm (interpreted as 0.70 mm or 0.028" peak to peak) Number of sweeps: 20 sweeps (10 cycles) per axis, for 3 axes (no delay at resonance)</p> <p>Bump: Acceleration: 10 g Duration of pulse: 16 ms Number of bumps: 1000 +/- 10 for each axis, for 3 axes Time between bumps: 2 seconds</p>
Construction	<p>Size: See Figure 3.1 for dimensions Housing: Glass-filled Nylon (Black) Connectors: Nickel-plated brass All circuitry epoxy-encapsulated.</p>
Environmental Rating	NEMA 4, 13; IEC IP65
MM2-TA-12B Connections	<p>1 each 8-pin Mini-style male 1 each 7-pin Mini-style female 8 each 5-pin Euro-style female (4-pin, if earth ground connection is not used)</p>
Operating Conditions	<p>Temperature range: 0° to +50° C (+32° to 122° F) Max. Relative Humidity: 95% (non-condensing)</p>
Safety Category	Safety Category 2 per EN 954-1
Certifications	
Application Notes	<p>Mute Timing Sequences: see Appendix A Typical Muting Applications: see Appendix B Application Standards: see Appendix C</p>

2.1 Accessory Cordset Selection

Important Notes on Selecting Cordsets and Cables

1. In addition to this manual, refer to manuals for the safeguarding system(s) and associated device(s), such as the mute sensors.
2. It is helpful to draw out the application on paper. Include the complete safeguarding system(s) to be connected to the MSSJ and the SSI. See Figure 2-3 for a sample application.
3. If using sensors with 4-pin QD termination for the mute devices (i.e., M1 – M4), **you must verify pinout versus function.** Not all “off-the-shelf” sensors with standard 4-pin Euro-style connectors will properly interface with the M1 – M4 connections.

Such things as Light or Dark Operate, and PNP/NPN/relay output should be considered while specifying a system and choosing interconnect cabling; an FIC-M12M4 field-wireable connector or special QD wiring may be required. **It is recommended that a sensor with bipolar solid-state outputs be considered as a first option** (e.g., Banner MINI-BEAM or Q45).

4. In applications where two separate devices per input are required (e.g., opposed-mode sensors), it is recommended that all devices be supplied from a single power source. Bulk cable with a FIC-M12M4 field-wireable connector (or an MQDMC-4.. cordset) can be wired to a terminal strip, then to the receiver and emitter. Splitters (such as Banner MDCVB4T) or Y-cables (such as the TURCK VB2 series) also can be used for a QD solution.

NOTE: To prevent common mode failures that could result in unintended mute cycles, **supplying power to an opposed-mode emitter and its receiver from separate power sources is not recommended.**

5. Per U.S., International, and European safety standards, all muting applications require a “mute indicator.” See Section 2.2 for options.

2.1.1 Step #1 – Select Guarding System (MSSI) Cordset

One cable required; measure cable length from muting module to safeguarding device or to splitter cordset.

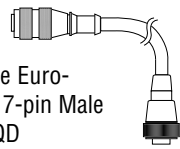
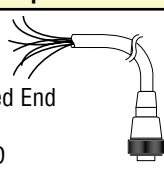
EZ-SCREEN Type 2 Receiver (To LS2..R30-..Q8 M12/Euro-style quick-disconnect or to CSB-M128.. splitter cordset)		
Model	Length	Description
DESE5-508D	2.4 m (8')	 8-pin Female Euro-Style QD to 7-pin Male Mini-Style QD
DESE5-515D	5 m (15')	
DESE5-525D	8 m (25')	
Safeguard with Hard-Wired Contacts/Terminals		
Model	Length	Description
QDS-715C	5 m (15')	 Nonterminated End to 7-pin Male Mini-Style QD
QDS-725C	8 m (25')	
QDS-750C	15 m (50')	

2.1.2 Step #2 – Select Machine Interface Cordset

One cable required; measure cable length from muting module to control panel.

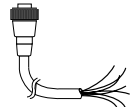
Machine Control Panel Interface Connection		
Model	Length	Description
QDS-815C	5 m (15')	 8-pin Female Mini-Style Single-Ended
QDS-825C	8 m (25')	
QDS-850C	15 m (50')	

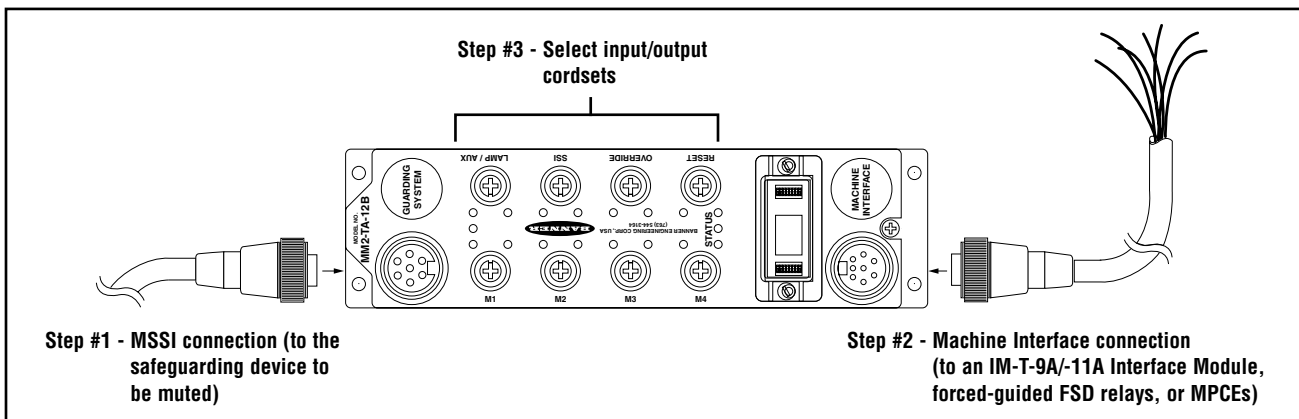



Figure 2-1. Initial cordset selections

2.1.3 Step #3 – Select Input/Output Cordsets

Typically, four to eight input and output Euro-style cordsets/connectors are required, depending on the application. Following are typical Euro-style cordset options.



CAUTION ... Verify pinout of cordset and sensor(s) vs. function before ordering:

- **M1 to M4 mute inputs** (one cordset per input used, typically 2 or 4), see Figure 2-2 and Section 3.4.
- **Mute Lamp and AUX output** (one cordset typically used)
- **Reset Input** (one cordset typically used)
- **SSI Input** (optional per application)
- **Override Input** (optional per application)

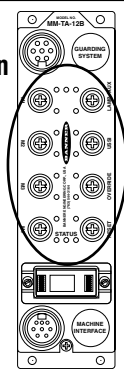

MQDEC-4.. (QD model sensor; double-ended cordset)
Typically used where sensor QD matches MM2-FM-12B pinout (see Figure 2-2), or MDCVB4T splitter is used.

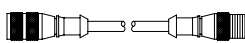
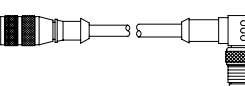
Model	Length	Description
MQDEC-403SS	1 m (3')	 4-pin Straight Male/ Straight Female, Euro-Style, Double-Ended
MQDEC-406SS	2 m (6')	
MQDEC-412SS	4 m (12')	
MQDEC-420SS	6 m (20')	
MQDEC-430SS	9 m (30')	
MQDEC-450SS	15 m (50')	
MQDEC-403RS	1 m (3')	 4-pin Right-Angle Male/ Straight Female, Euro-Style, Double-Ended
MQDEC-406RS	2 m (6')	
MQDEC-412RS	4 m (12')	
MQDEC-420RS	6 m (20')	
MQDEC-430RS	9 m (30')	
MQDEC-450RS	15 m (50')	

MQDMC-4.. (male QD cordset)
Typically used where connecting to terminals or hardwired contacts, or cable will be cut to length.

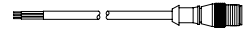
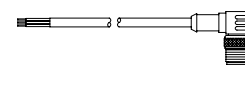
Model	Length	Description
MQDMC-406	2 m (6')	 4-pin Straight Male, Euro-Style, Single-Ended
MQDMC-415	5 m (15')	
MQDMC-430	9 m (30')	
MQDMC-450	15 m (50')	
MQDMC-406RA	2 m (6')	 4-pin Right-Angle Male, Euro-Style, Single-Ended
MQDMC-415RA	5 m (15')	
MQDMC-430RA	9 m (30')	
MQDMC-450RA	15 m (50')	

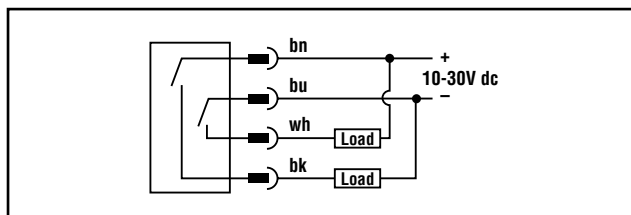
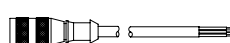
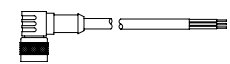
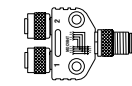
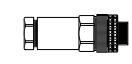
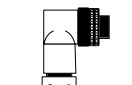

Figure 2-2. Typical 4-pin Euro-style bipolar (e.g. MINI-BEAM)

MQDC-4.. (female QD cordset for use with FIC-M12M4(A) field-wireable connector below)
Typically used where sensor QD does not match MM2-FM-12B pinout, or cable will be cut to length.

Model	Length	Description
MQDC-406	2 m (6')	 4-pin Straight Female, Euro-Style, Single-Ended
MQDC-415	5 m (15')	
MQDC-430	9 m (30')	
MQDC-450	15 m (50')	
Model	Length	Description
MQDC-406RA	2 m (6')	 4-pin Right-Angle Female, Euro-Style, Single-Ended
MQDC-415RA	5 m (15')	
MQDC-430RA	9 m (30')	
MQDC-450RA	15 m (50')	

2.1.4 Cordset Accessories

Model	Description
 MDCVB4T (Only one FIC-M12M4 connector can be used at trunk #1 or #2)	Splitter: 4-pin, one male/two female, Euro-style Typically used with three MQDEC-4.., or one MQDC-4.. and two MQDMC-4..
 FIC-M12M4	Field-Wireable Connector: 4-pin Straight Male, Euro-style Typically used with customer-supplied cable for connecting to terminals or hardwired contacts, or with MQDC-.. cables.
 FIC-M12M4A	Field-Wireable Connector: 4-pin Right-Angle, Euro-style Typically used with customer-supplied cable for connecting to terminals or hardwired contacts, or with MQDC-.. cables.

Sample Application

This “X” pattern entry/exit system employs a multiple-beam perimeter guarding safety system (muted) and a safety mat system (not muted). Cabling used to create the application at right is shown below. See Section 3.5.5.3 and Appendix B for more information.

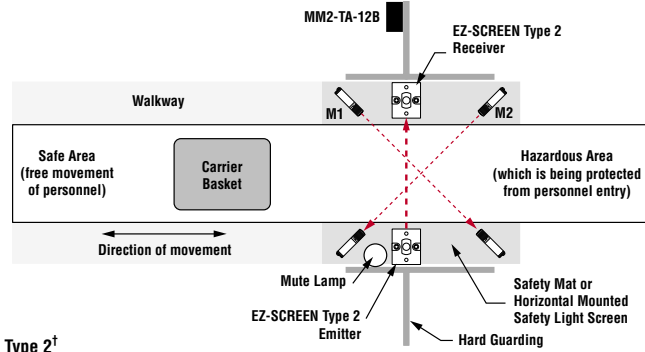

[†]NOTE: See EZ-SCREEN Type 2 manual (PN 122452) for information on QDE-8..D, DEE2R.., and CSB.. splitter cordsets.

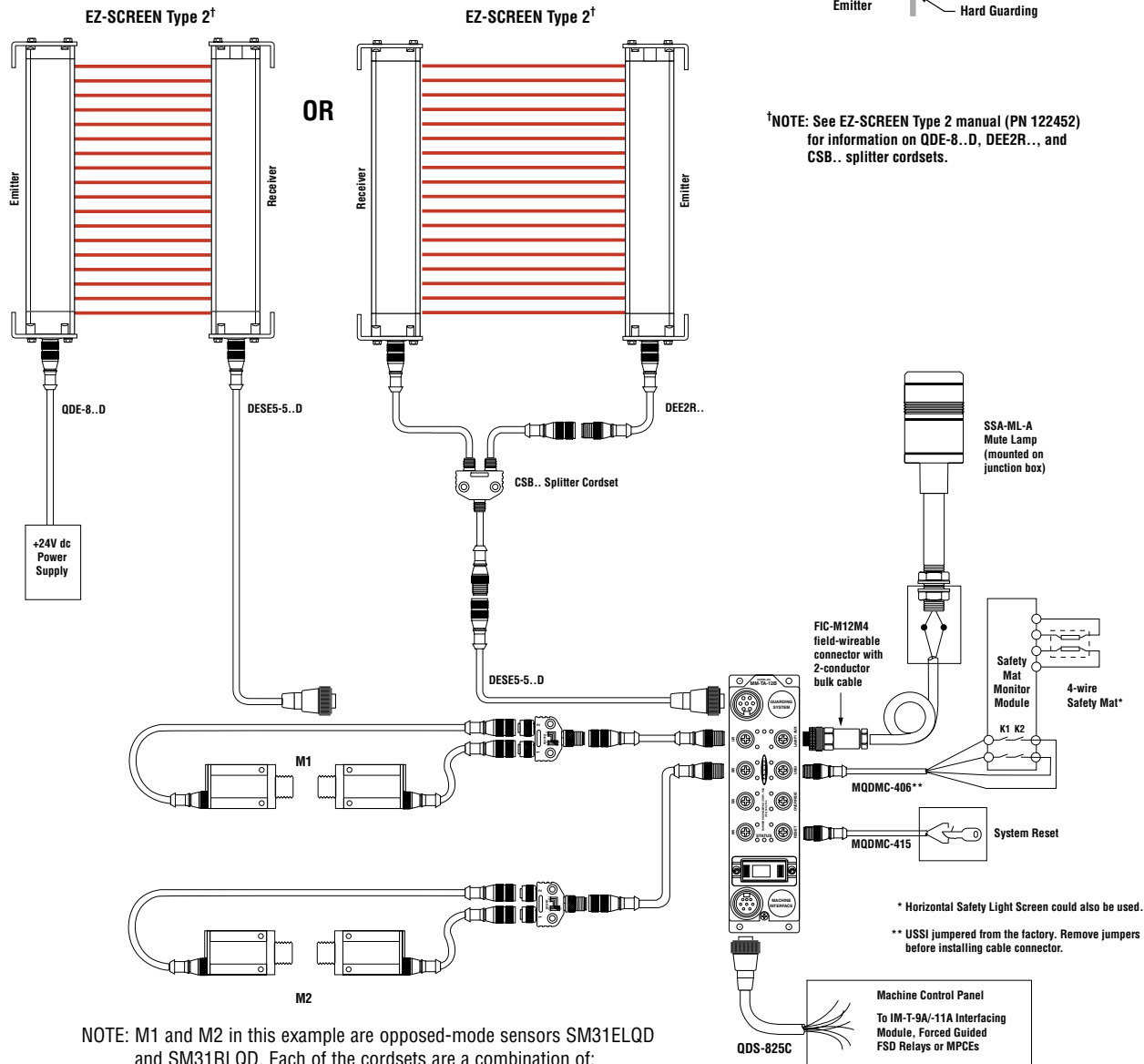

- NOTE: M1 and M2 in this example are opposed-mode sensors SM31ELQD and SM31RLQD. Each of the cordsets are a combination of:
- MDCVB4T Splitter (1)
 - MQDEC-430SS, 30' cable to the emitter (1)
 - MQDEC-412SS, 12' cable to the receiver (1)
 - MQDEC-406SS, 6' cable from the splitter to the MM2-TA-12B Module (1)

* Horizontal Safety Light Screen could also be used.
 ** USS1 jumpered from the factory. Remove jumpers before installing cable connector.

Figure 2-3. Sample muting application and its required cabling

2.2 Accessories

Additional interfacing solutions and accessories continue to be added; refer to www.bannerengineering.com for a current list.

Interface Modules

Provide forced-guided, mechanically-linked relay (safety) outputs for the EZ-SCREEN System. See Banner data sheet p/n 62822 for more information. See Figures 3-18 and 3-19.

Model	Description
IM-T-9A	Interface module (3 N/O redundant-output 6 amp contacts)
IM-T-11A	Interface module (2 N/O redundant-output 6 amp contacts, plus 1 N/C auxiliary contact)

Contactors

If used, two contactors per EZ-SCREEN System are required. See Figure 3-17.

Model	Description
11-BG00-31-D-024	10 amp positive-guided contactor 3 N/O, 1 NC
11-BF16C01-024	16 amp positive-guided contactor 3 N/O, 1 NC

Solid-State LED-Based Mute Lamp

Model	Description
SSA-ML-W	+24V dc, White lens
SSA-ML-A	+24V dc, Amber lens

3. System Installation

3.1 Applications and Limitations

The Banner MM2-TA-12B (the System) is intended for lower-risk machine guarding applications and other safeguarding applications, as determined by a risk assessment. It is the user's responsibility to verify whether the safeguarding is appropriate for the application and is installed, as instructed by this manual, by a Qualified Person (as defined in the Glossary).

Before installing the MM2-TA-12B, read this manual in its entirety, paying particular attention to all of Section 3. The System's ability to perform its safeguarding function depends upon the appropriateness of the application and upon its proper mechanical and electrical installation and interfacing to the guarded machine. **If all mounting, installation, interfacing, and checkout procedures are not followed properly, the System cannot provide the protection for which it was designed.**

MM2-TA-12B is typically used, but is not limited to, the following applications (dependent on machine risk assessment):

- Small assembly equipment
- Automated production equipment
- "Table-top" robotic work cells
- Component insertion / "pick-and-place" machines
- Small packaging machines
- Equipment and process protection (non-personnel safety)
- Applications that could result in only slight (normally reversible) injuries (such as a bump, bruise, knock-down, trapping but not crushing, minor cuts and abrasions, etc.)



WARNING . . . Stand-Alone Point-of-Operation Guarding

The Muting Module is not a stand-alone point-of-operation guarding device, as defined by OSHA regulations. It is necessary to install point-of-operation guarding devices, such as safety light screens and/or hard guards, to protect personnel from hazardous machinery.

Failure to properly install point-of-operation safeguarding on hazardous machinery, as instructed by the appropriate installation manuals, can result in a dangerous condition which could lead to serious injury or death.



WARNING . . . Read this Section Carefully Before Installing the System

The Banner MM2-TA-12B Muting Module is an accessory device that is typically used in conjunction with point-of-operation machine guarding device. **Its ability to perform this function depends upon the appropriateness of the application and upon the MM2-TA-12B Muting Module's proper mechanical and electrical installation and interfacing to the machine to be guarded.**

If all mounting, installation, interfacing, and checkout procedures are not followed properly, the MM2-TA-12B Muting Module cannot provide the protection for which it was designed. The user has the responsibility to ensure that all local, state, and national laws, rules, codes, or regulations relating to the installation and use of this control system in any particular application are satisfied. Extreme care should be taken to ensure that all legal requirements have been met and that all technical installation and maintenance instructions contained in this manual are followed. **Read all of Section 3 of this manual carefully before installing the System. Failure to follow these instructions could result in serious bodily injury or death.**

The user has the sole responsibility to ensure that the Banner MM2-TA-12B Muting Module is installed and interfaced to the guarded machine by Qualified Persons in accordance with this manual and applicable safety regulations. (See Section 1.18.)

MM2-TA-12B may NOT be used with the following machinery or unsuitable applications:

- Interfaced with a primary safeguard in frequently accessed hazardous situations that could result in serious injuries (normally irreversible, including death); see Caution below.
- In any case where Control Reliability, Category 3, Category 4, or Type 4 AOPD (active opto-electronic protective device) have been mandated. See EN 954-1, IEC 61496-1, or other appropriate standard.
- With any machine that cannot be stopped immediately after a stop signal is issued, such as single-stroke (or “full-revolution”) clutched machinery.
- With any machine with inadequate or inconsistent machine response time and stopping performance.
- With any machine that ejects materials or component parts through the defined area.
- In any environment that is likely to adversely affect the efficiency of the safeguard(s) or the MM2-TA-12B. For example, corrosive chemicals or fluids or unusually severe levels of smoke or dust, if not controlled, may degrade the efficiency of the System.

If there is any doubt about whether or not your machinery is compatible with the MM2-TA-12B Muting Module, contact Banner’s Application Engineers at the factory.

**CAUTION . . . Use of MM2-TA-12B**

MM2-TA-12B meets the Category 2 requirements of EN 954-1. **DO NOT use MM2-TA-12B unless it is installed, tested, and inspected in accordance with this manual. DO NOT use MM2-TA-12B where Control Reliability is required, or where Category 3, Category 4, or Type 4 AOPD (active opto-electronic protective device) have been mandated, or where a risk assessment has determined that frequent access by personnel to the hazard could result in an irreversible or serious injury (e.g., OSHA reportable injury).**

Typical use is for safeguarding in situations where the consequence of an accident will result in only slight (normally reversible) injuries that are typically treated by the normal healing processes and minor medical treatment (i.e., first aid, as defined by OSHA 29CFR1904.7).

Failure to follow these instructions could result in serious bodily injury or death.

**WARNING . . . Muting Limitations**

Muting is allowed only during the non-hazardous portion of the machine cycle (OSHA 1910.217(c)(3)(iii)(d), and ANSI B11.19).

**WARNING . . . User Is Responsible for Safe Application of this Product**

The muting application examples described in Appendix B depict generalized guarding situations. Every guarding application has a unique set of requirements.

Extreme care is urged to ensure that all legal requirements are met and that all installation instructions are followed. In addition, any questions regarding safeguarding should be directed to the factory applications department at the number or addresses listed on the back cover.

**WARNING . . . Guarding Multiple Areas**

DO NOT safeguard multiple areas, with mirrors or multiple sensing fields, if personnel can enter the hazardous area while the System is muted, and not be detected by supplemental safeguarding that will issue a stop command to the machine (see Section 3.1.4, Pass-Through Hazards).

3.1.1 Muting Application Design

Following are typical applications where muting is used. See Appendix B for more detailed information.

- **Entry/Exit Applications.** The muting devices are placed to allow the entry or exit of a pallet or cart of work materials to enter or exit a workstation without tripping the safety light screen, and without allowing the entrance of personnel into the hazardous area.
- **Home or Station Applications.** The muting devices must be placed to mute the safety light screen only when a hazard does not exist or is in another area — so that personnel are not exposed to any hazard.

3.1.2 Use of Corner Mirrors with Optical Safety Systems

Mirrors are typically used with safety light screens and single-/multiple-beam safety systems to guard multiple sides of a hazardous area. If the safety light screen is muted, the safeguarding function is suspended on all sides. It must not be possible for an individual to enter the guarded area without being detected and a stop command issued to the machine control. This supplemental safeguarding is normally provided by an additional device(s) that remains active while the Primary Safeguard is muted and could be interfaced with the USSI input. Therefore, mirrors are typically not allowed for muting applications.

3.1.3 Multiple Presence-Sensing Safety Devices (PSSDs)

Muting multiple PSSDs or a PSSD with multiple sensing fields is not recommended unless it is not possible for an individual to enter the guarded area without being detected and a stop command issued to the machine control. As with the use of corner mirrors (see above), if multiple sensing fields are muted the possibility exists that personnel could move through a muted area or access point to enter the safeguarded area without being detected.

For example, in an entry/exit application where a pallet initiates the mute cycle by entering a cell, if both the entry and the exit PSSDs are muted, it may be possible for an individual to access the guarded area through the “exit” of the cell. An appropriate solution would be to mute the entry and the exit with separate safeguarding devices.

3.1.4 Pass-Through Hazards

A “pass-through hazard” is associated with applications where personnel may pass through a safeguard (at which point the hazard stops or is removed), and then may continue into the hazardous area. Subsequently, their presence is no longer detected, and the safeguard can not prevent the start or restart of the machine. The related danger is the unexpected start or restart of the machine while personnel are within the hazardous area.

In the use of safety light screens, a pass-through hazard typically results from large separation/safety distances calculated from long stopping times, large minimum object sensitivities, reach over, reach through, or other installation considerations. A pass-through hazard can be generated with as little as 75 mm (3") between the defined area and the machine frame or hard guarding.

Reducing or Eliminating Pass-Through Hazards

Measures must be taken to eliminate or reduce pass-through hazards. One solution is to ensure that personnel are continually sensed while within the hazardous area. This can be accomplished by using supplemental safeguarding, including: safety mats, area scanners, and horizontally mounted safety light screens. While it is recommended to eliminate the pass-through hazard altogether, this may not be possible due to cell or machine layout, machine capabilities, or other application considerations.

An alternate method is to ensure that once the safeguarding device is tripped it will latch, and require a deliberate manual action to reset. This type of supplemental safeguarding relies upon the location of the reset switch as well as safe work practices and procedures to prevent an unexpected start or restart of the guarded machine.

The reset switch or actuating control must be positioned outside the guarded area, and provide the switch operator with a full unobstructed view of the entire guarded area and any associated hazards as the reset is performed. The reset switch or actuating control must not be reachable from within the guarded area and must be protected (through the use of rings or guards) against unauthorized or inadvertent operation. A key-actuated reset switch provides some operator control, as it can be removed by the operator and taken into the guarded area. However, this does not prevent unauthorized or inadvertent resets due to spare keys in the possession of others, or additional personnel entering the safeguarded area unnoticed.

The reset of a safeguard must not initiate hazardous motion. Also, before each reset of the safeguard is performed, safe work procedures require that a start-up procedure be followed and that the individual performing the reset verify that the entire hazardous area is clear of all personnel. If any areas can not be observed from the reset switch location, additional supplemental safeguarding must be used: at a minimum, visual and audible warnings of machine start-up.



WARNING . . . Pass-Through Hazards, Presence-Sensing Safeguarding Devices, and Muting

If the presence-sensing safeguarding device (PSSD) is guarding an application in which personnel have access into the sensing area or field (for example, a machine operator at the point of operation) while the PSSD is muted, all pass-through hazards must be eliminated. The individual must be sensed continually while in the safeguarded area; this will prevent initiation of a machine cycle if the mute ends while the individual is within the hazardous area. See Appendix B for examples.

If the pass-through hazard cannot be eliminated, as in entry/exit applications, the individual must be detected entering the safeguarded area and the hazardous motion must stop immediately.

3.2 Installing the Module

The MM2-TA-12B Muting Module may be installed within a panel or in a IP 65 environment. It must be used with a properly installed and applied safeguard (e.g., safety light screen, interlocked barrier guard). The user must comply with all instructions contained within product manuals and relevant regulations.

Mount the Module in a convenient location that is free from heavy impulse force and high-amplitude vibration. The Module is designed to be mounted near the safeguarding device to be muted. It can be also mounted inside a panel, and in any orientation (see Specifications for environmental and operating conditions). See Figure 3-1 for mounting hole information.

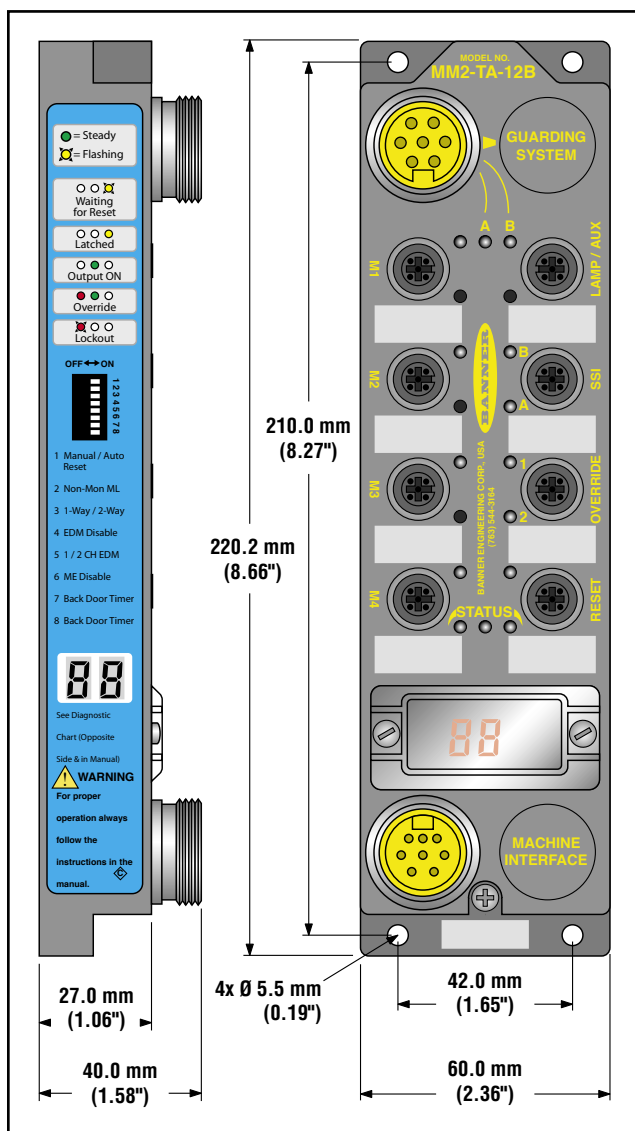
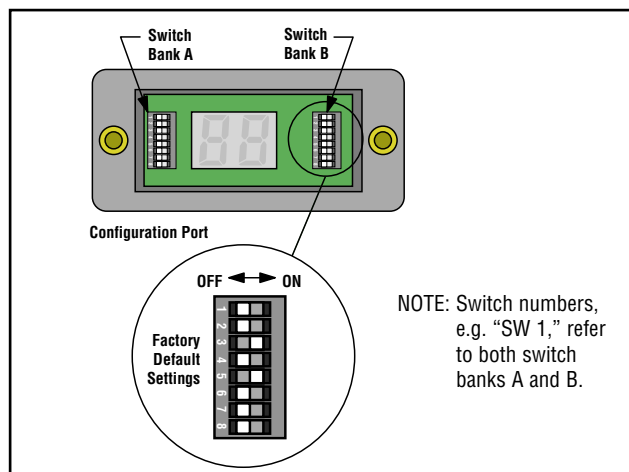

Figure 3-1. Model MM2-TA-12B Muting Module dimensions

3.3 Muting Module Configuration

The MM2-TA-12B Muting Module should be configured before initial checkout and use. Two banks of DIP switches are located under the access cover for the configuration port. To access the DIP switches, unscrew the two captive, round-head slot screws on either side of cover and carefully swing the cover open.

Because the MM2-TA-12B has redundant microprocessors, two DIP switch banks (Bank A and Bank B) must be set identically. Failure to set Bank A and Bank B identically will result in a lockout condition. Power must be OFF when changing DIP switch settings; changing settings while power is ON will cause a lockout condition. The parameters to be manually configured are shown in Figure 3-2.



Auto/Manual Reset (See Section 1.3)	SW1 ON = Auto Reset SW1 OFF = Manual Reset*																				
Non-Monitored Mute Lamp Output (See Section 1.13)	SW2 ON = Mute Lamp Output not monitored SW2 OFF = Monitored Mute Lamp Output*																				
One-Way or Two-Way Mute Initiate Sequence (See Section 1.17)	SW3 ON = Two-way muting* SW3 OFF = One-way muting																				
EDM Disable (See Section 1.10)	SW4 ON = EDM disabled SW4 OFF = EDM functional*																				
One-Channel or Two-Channel EDM (See Section 1.10)	SW5 ON = Two-Channel EDM* SW5 OFF = One-Channel EDM																				
Mute Enable Input (See Section 1.12)	SW6 ON = ME disabled SW6 OFF = ME functional*																				
Backdoor Time-Out (See Sections 1.14 and 1.15); combination of SW7 and SW8 settings	<table border="1"> <thead> <tr> <th>SW7</th> <th>SW8</th> <th>Time-Out</th> <th>Mute ON Power-Up</th> </tr> </thead> <tbody> <tr> <td>OFF*</td> <td>OFF*</td> <td>30 sec.*</td> <td>Disabled*</td> </tr> <tr> <td>OFF</td> <td>ON</td> <td>60 sec.</td> <td>Disabled</td> </tr> <tr> <td>ON</td> <td>OFF</td> <td>OFF</td> <td>Disabled</td> </tr> <tr> <td>ON</td> <td>ON</td> <td>OFF</td> <td>Enabled</td> </tr> </tbody> </table>	SW7	SW8	Time-Out	Mute ON Power-Up	OFF*	OFF*	30 sec.*	Disabled*	OFF	ON	60 sec.	Disabled	ON	OFF	OFF	Disabled	ON	ON	OFF	Enabled
	SW7	SW8	Time-Out	Mute ON Power-Up																	
	OFF*	OFF*	30 sec.*	Disabled*																	
	OFF	ON	60 sec.	Disabled																	
ON	OFF	OFF	Disabled																		
ON	ON	OFF	Enabled																		

* Factory default setting

Figure 3-2. Muting Module manual configuration parameters

3.4 Connector Pinouts and Functions

All electrical connections are made through either field-wireable or molded quick-disconnect plugs. (See Section 2 and Figure 3-3.)



WARNING . . . Proper Electrical Hookup

Electrical hookup must be made by Qualified Personnel and must comply with NEC (National Electrical Code) and local standards.

Make no connections to the System other than those described in Section 3 of this manual. **Doing so could result in serious injury or death.**

Total Current Draw Calculation

Total current draw at the machine interface connector is the sum of the draw of the Muting Module, the mute lamp, the AUX output and mute devices, and the safeguarding device connected to the MSSSI, if the power connections are used. To calculate the total current draw, add the following:

$$I_{TOTAL} = I_{MM} + I_{AUX} + I_{ML} + I_{MD} + I_{MSSI}$$

$I_{MM} = 400 \text{ mA}$ (MM-TA-12B supply current)

$I_{AUX} = X < 250 \text{ mA}$ (auxiliary device current)

$I_{ML} = X < 360 \text{ mA}$ (mute lamp current)

$I_{MD} = X < 500 \text{ mA}$ (M1-M4 supply current)

$I_{MSSI} = X < 2500 \text{ mA}$ (MSSI supply current)

Cable and wiring is low voltage; running these wires alongside power wires, motor/servo wires, or other high-voltage wiring can inject noise into the safeguarding system. It is good wiring practice (and may be required by code) to isolate wires from high-voltage wires.

Machine Interface

Pin	Color*	Function
1	Brown	+24V dc
2	Orange/Black	EDM#2
3	Orange	EDM#1
4	White	OSSD#2
5	Black	OSSD#1
6	Blue	0V dc
7	Green/Yellow	Earth Ground
8	Violet	Mute Enable

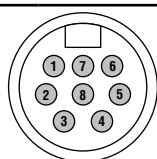

Male, Mini-Style

Machine Safety Stop Interface (MSSI)

Pin	Color*	Function
1	Gray/Black	MSSI b
2	White	MSSI c
3	Black	MSSI a
4	Blue	0V dc
5	Brown	+24V dc
6	Gray/White	MSSI d
7	Green/Yellow	Earth Ground

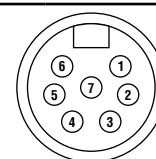

Female, Mini-Style

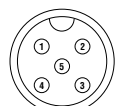

Female, Euro-Style

Pin	Color*	Function				
		Mute Inputs (M1 – M4)	Reset Input	Override Input (OVER)	Safety Stop Interface (SSI)	Mute Lamp Output (ML) and Auxiliary PNP Output (AUX)
1	Brown	+24V dc	+24V dc	+24V dc	SSI b	+24V dc
2	White	NPN Input for M2/M4 (not connected M1/M3)	(not connected)	OVER Input B	SSI c	Mute Lamp Output
3	Blue	0V dc	(not connected)	0V dc	SSI d	0V dc
4	Black	PNP Input for M1/M3 (not connected M2/M4)	Reset Input	OVER Input A	SSI a	AUX PNP Output
5	Shield**	Shield, Earth Ground	Shield, Earth Ground	Shield, Earth Ground	Shield, Earth Ground	Shield, Earth Ground

*Color code corresponds to Banner accessory QD cordsets listed in Section 2.1.

**Pin 5: optional shield ground for electrically noisy environments

Maximum cable length (ft) versus total current draw (It) at Machine Interface connector												
	0.5A	0.75A	1.0A	1.25A	1.5A	1.75A	2.0A	2.25A	2.5A	2.75A	3.0A	3.25A
12 AWG	1500	1000	750	594	500	438	375	344	313	281	250	219
14 AWG	960	640	480	380	320	280	240	220	200	180	160	140
16 AWG	600	400	300	238	200	175	150	138	125	113	100	88
18 AWG	375	250	188	148	125	109	94	88	78	70	63	55
20 AWG	240	160	120	95	80	70	60	55	50	45	40	35
22 AWG	150	100	75	59	50	44	38	n.a.	n.a.	n.a.	n.a.	n.a.

NOTE: Cable length includes power (+24V dc) and return (0V dc) wires at 25°C, and is intended to ensure that adequate power is available to the Module when the supply is operating at +24V dc-15%.

Figure 3-3. Connector pinouts (face views) for Module connectors

3.5 Installing Input Devices

3.5.1 Reset Switch Location

The reset switch must be mounted at a location that complies with the warning below.

A key-actuated reset switch provides some operator or supervisory control, as the key can be removed from the switch and taken into the guarded area. However, this does not prevent unauthorized or inadvertent resets due to spare keys in the possession of others, or additional personnel entering the guarded area unnoticed.

Resetting a safeguard must not initiate hazardous motion.

Safe work procedures require a start-up procedure to be followed and the individual performing the reset to verify that the entire hazardous area is clear of all personnel, before each reset of the safeguard is performed. If any area can not be observed from the reset switch location, additional supplemental safeguarding must be used: at a minimum, visual and audible warnings of machine start-up.



WARNING . . . Reset Switch Location All reset switches must be:

- Outside the guarded area,
- Located to allow the switch operator full, unobstructed view of the entire guarded area while the reset is performed,
- Out of reach from within the guarded area, and
- Protected against unauthorized or inadvertent operation (such as through the use of rings or guards).

If any areas within the guarded area are **not visible** from the reset switch, **additional safeguarding must be provided**, as described by the ANSI B11 series or other appropriate standards. **Failure to do so could result in an increased risk of harm.**

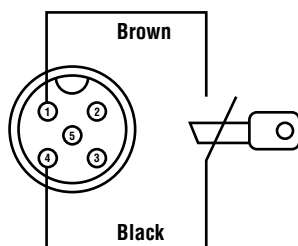

Reset Input, pin 4 (see Section 3.3)

Figure 3-4. Manual reset switch connections

3.5.2 Muting Devices

The user is required by OSHA and ANSI to arrange, install, and operate the safety system so as to protect personnel and minimize the possibility of defeating the safeguard.

Indication that the safeguard is muted must be provided and be readily observable. Failure of this indication should be detectable and prevent the Module from initiating a mute cycle. If this is not possible, the operation of the indicator should be verified at suitable intervals. Mute devices must meet a 3-second simultaneity requirement to activate muting; that is, devices in a pair must be activated within 3 seconds of one another.

3.5.2.1 General Muting Device Requirements

The muting devices (typically sensors or switches) must, at a minimum, comply with the following requirements:

1. There must be a minimum of two independent hard-wired muting devices.
2. The muting devices must either both have normally open contacts; or one device with a PNP output and one device with a NPN output, both of which must fulfill the input requirements listed in the Specifications (Section 2). These contacts must close when the switch is actuated, and must open (or not conduct) when the switch is not actuated or in a power OFF condition.
3. The activation of the inputs to the muting function must be from separate sources. These sources must be mounted separately in order to prevent an unsafe muting condition resulting from misadjustment, misalignment, or a single common mode failure. (For example, physical damage to the mounting surface could cause both muting devices to be knocked out of alignment, resulting in false muting input signals.) Only one of these sources may pass through, or be affected by, a programmable logic controller or similar device.
4. The muting devices must be installed so that they can not be easily defeated or bypassed.
5. The muting devices must be mounted so that their physical position and alignment can not be easily changed.
6. It must not be possible for environmental conditions to initiate a mute condition (e.g., extreme airborne contamination).
7. The muting devices must not be set to use any delay or other timing functions (unless such functions are accomplished so that no single component failure prevents the removal of the hazard, subsequent machine cycles are prevented until the failure is corrected, and no hazard is created by extending the muted period).

3.5.2.2 Examples of Muting Sensors and Switches

Photoelectric Sensors (Opposed Mode)

Opposed-mode sensors, which initiate the muted condition when the beam path is blocked, should be configured for dark operate and have open (non-conducting) output contacts in a power OFF condition.

Emitter/receiver pairs should be powered from the same sources of +24V dc to reduce the chance of a loss of power initiating an unintended mute cycle.

Photoelectric Sensors (Polarized Retroreflective Mode)

The user must ensure that false “proxing” (activation due to shiny or reflective surfaces) is not possible. Banner “LP” sensors with linear polarization can greatly reduce or eliminate this effect.

Configure sensors for Light Operate (LO or N.O.) if initiating a mute when the retroreflective target or tape is detected (e.g., home position). Configure sensors for Dark Operate (DO or N.C.) when a blocked beam path initiates the muted condition (e.g., entry/exit). Both situations must have open (non-conducting) output contacts in a power OFF condition.

Positive-Opening Safety Switches

Two (or four) independent switches, each with a minimum of one closed safety contact to initiate the mute cycle are typically used. An application using a single switch with a single actuator and two closed contacts could result in an unsafe situation.

Inductive Proximity Sensors

Typically, inductive proximity sensors are used to initiate a muted cycle when a metal surface is detected. Due to excessive leakage current causing false ON conditions, two-wire sensors are not to be used. Only three- or four-wire sensors that have discrete PNP, NPN, or hard-contact outputs that are separate from the input power can be used.



WARNING . . . Avoid Hazardous Installations

Two or four independent position switches (at M1-M2 or M3-M4) must be properly adjusted or positioned so that they close only after the hazard no longer exists, and open again when the cycle is complete or the hazard is again present. If improperly adjusted or positioned, injury or death could result.

The user has the responsibility to satisfy all local, state, and national laws, rules codes, and regulations relating to the use of safety equipment in any particular application. It is extremely important to be sure that all appropriate agency requirements have been met and that all installation and maintenance instructions contained in the appropriate manuals are followed.

3.5.2.3 Muting Device Hookup

The Module provides supply voltage, if required, and input connections for the muting devices. One or two pairs of muting devices (typically sensors or switches) must be used; these pairs are designated M1-M2 and M3-M4. The M1 and M3 inputs are PNP (sourcing). The M2 and M4 inputs are NPN (sinking). Also available are terminals to supply power (+24V dc) and "0V dc."

The current draw of all devices must not exceed 500 mA.

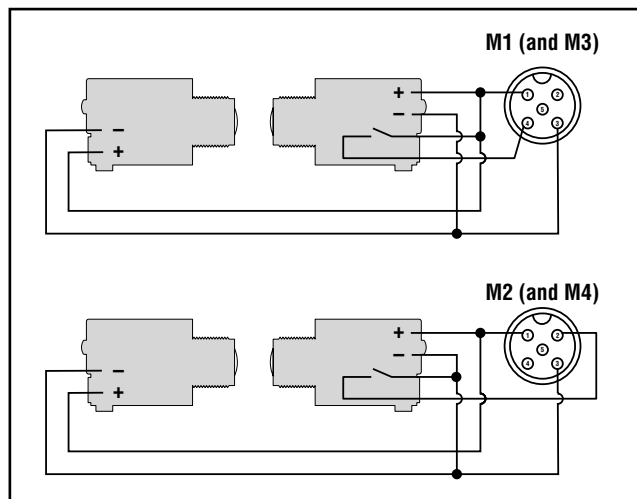

Figure 3-5. Two photoelectrics as M1 and M2 (or M3 and M4) using relay outputs

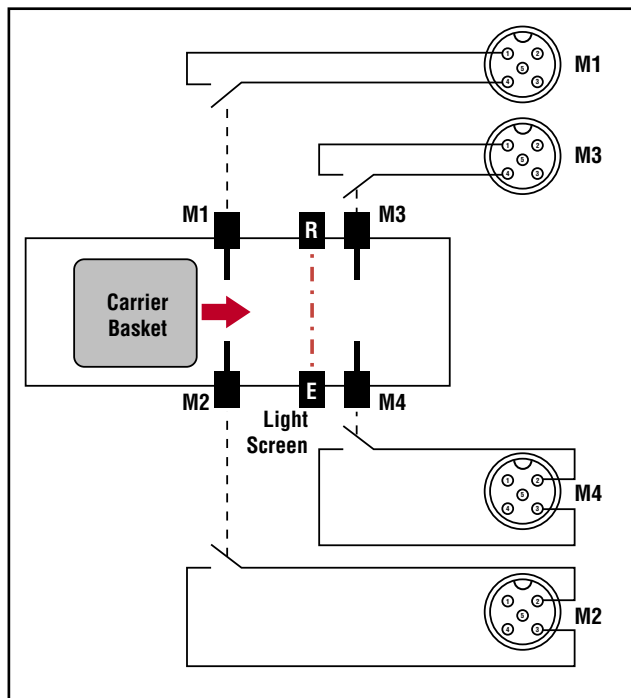

Figure 3-6. Four limit switches as M1, M2, M3 and M4

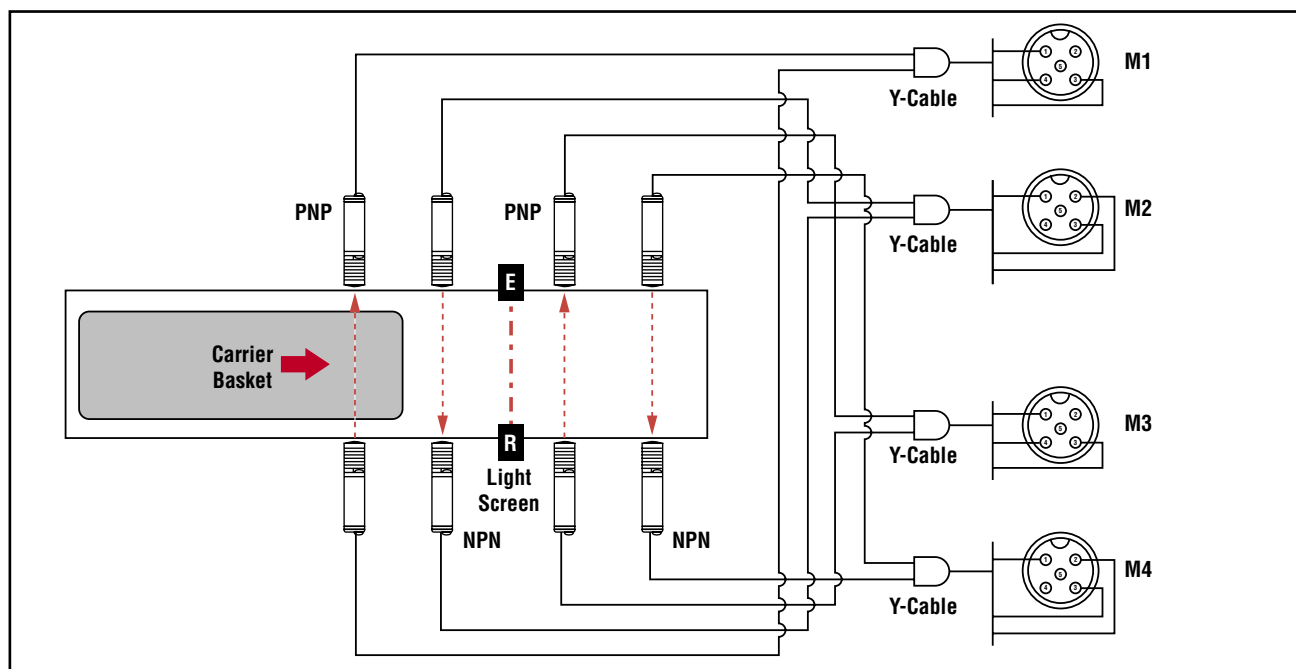

Figure 3-7. Four sensors as M1, M2, M3 and M4, using semiconductor outputs and power connections interfaced with Y-cables (or splitters)

3.5.3 Mute Lamp Output (ML) & Auxiliary PNP Output (AUX)

The Module provides connection terminals for the Mute Lamp (ML) output and an Auxiliary PNP output (AUX).

Mute Lamp Output (ML)

The Mute Lamp output provides for the visible indication that the safety device's safeguarding function is muted. This indication must be readily observable. Failure of this indication should be detectable and prevent the safeguard from being muted, or the operation of the indicator should be verified at suitable intervals (see Section 1.13).

The Module can be configured for a monitored or non-monitored mute lamp (see Figure 3-2). If the installation is governed by European (CE) regulations, the mute lamp must be monitored (SW2 = OFF, banks A and B). This output may also be used as an input to control logic (e.g., a PLC) if "non-monitored" is selected (SW2 = ON, banks A and B). The current draw of the mute lamp must not exceed 360 mA.

Auxiliary PNP Output (AUX)

A non-safety-related PNP output is available at pin number 4 of the ML/AUX connector. This monitoring output is for light-duty, non-safety-related control functions, such as an input to a programmable logic controller (PLC). This output follows the OSSD outputs and the Green status LED (see Figure 1-2). Maximum current draw of the AUX output is 250 mA.

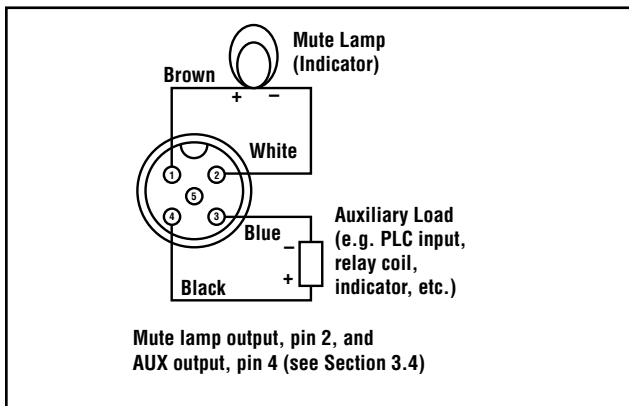

Figure 3-8. Mute lamp connections

3.5.4 Override Switch Hookup

The Module provides connection terminals for the Override switches (see Figure 3-9). See Section 1.16 and the warning below before connecting switches.

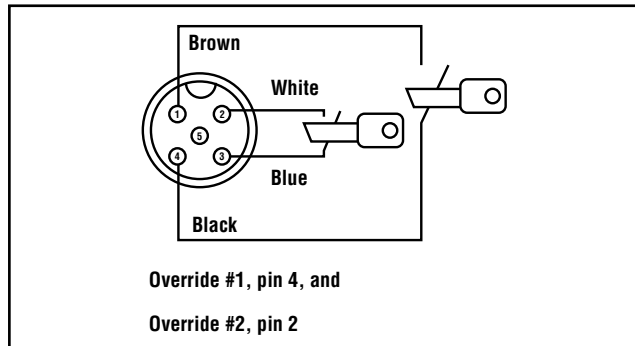



Figure 3-9. Override switch hookup



WARNING . . . Limit Use of Override Function

The Override function is not for machine setup or production; it is to be used only to clear the primary safeguard if material becomes "stuck," preventing its reset. When Override is used, it is the user's responsibility to install and use it according to current standards. In addition, the requirements listed in standards NFPA 79 and IEC 60204 must be satisfied.

3.5.5 SSI and MSSI Hookups

The Safety Stop Interface (SSI) provides for easy integration of safeguards. This interface consists of two input channels (A & B), which are compatible with the Banner EZ-SCREEN Type 2 solid-state OSSD outputs, with devices that have normally open hard contacts or relay outputs (voltage-free) and with 24V dc signals.

The Muteable Safety Stop Interface (MSSI) input is a specialized SSI that can be muted during the non-hazardous portion of the machine cycle and provides +24V dc supply power to the primary safety device that is to be muted.

The input channels (A & B) must meet a simultaneity requirement of 3.0 seconds upon closing and opening. A mismatch of more than 3.0 seconds will result in a lockout. A lockout that is due to a failure to meet simultaneity requirements can only be cleared by cycling the MSSI (or the SSI, depending on which failed) with simultaneity being met, and when the Module is configured for Manual Reset, then performing a reset routine.

The MSSI and the SSI can be interfaced with safety interlocking switches, E-stop buttons, rope/cable pull devices, and other machine control devices (see warning on page 3). To be interfaced with a safety mat, a safety mat controller must be connected between the mat and the interface.

Interposing safety relays or interfacing modules with hard contacts must be wired as shown in Figure 3-11.

These contacts may come from any of a variety of devices, including process control, emergency stop switches, gate switches, safety mat controls, and safety light screens.

NOTE: If the SSI is not to be used, pin 1 must be jumpered to pin 4, and pin 2 must be jumpered to pin 3 (factory default). Do not short Channel A to Channel B.

Although the MSSI, if hooked up to the EZ-SCREEN Type 2 Light screen OSSDs, is only Safety Category 2 per EN 954-1, the SSIs, if hooked up to safety switches or E-stop buttons with dry contacts, can be Safety Category 4 per EN 954-1 (see Figures 3-12 and 3-13).

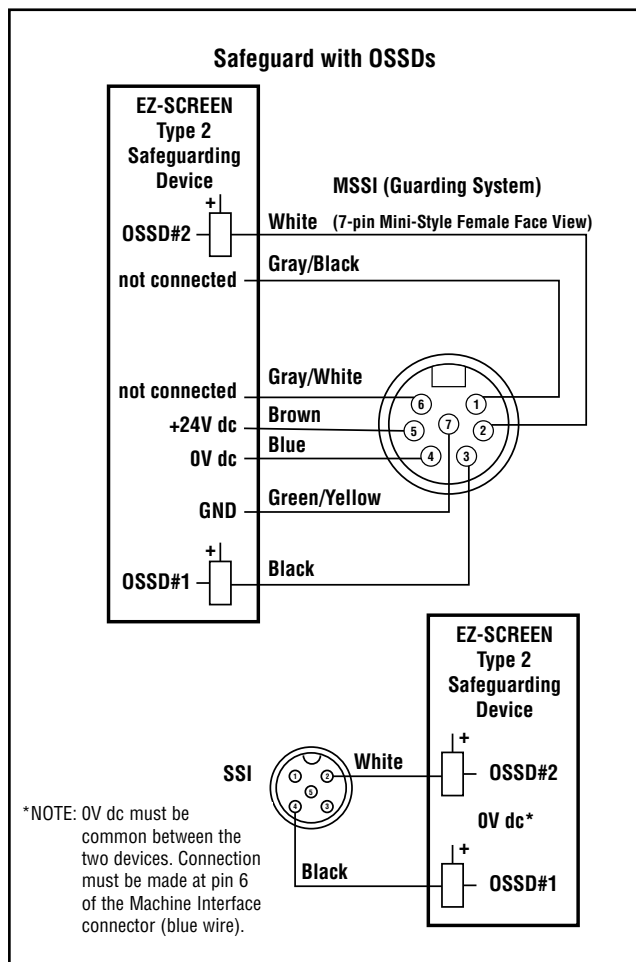

Figure 3-10. SSI and MSSI interfacing with Banner OSSDs

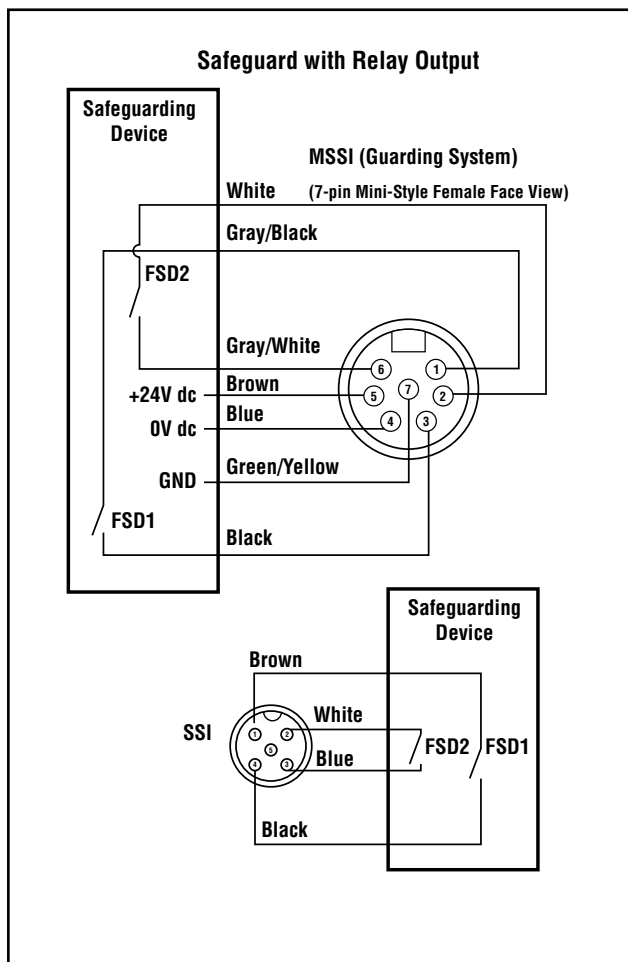



Figure 3-11. SSI and MSSI interfacing with hard contacts

3.5.5.1 SSI Emergency Stop Switch Hookup

As shown in Figure 3-12, the E-stop switch must provide two contacts which are closed when the switch is armed. Once activated, the E-stop switch must open all its contacts, and must be returned to the closed contact position only by means of a deliberate action (such as twisting, pulling, or unlocking). The switch should be a “positive-opening” type, as described by IEC947-5-1. A mechanical force applied to such a button (or switch) is transmitted directly to the contacts, forcing them open. This ensures that the switch contacts will open whenever the switch is activated. NFPA 79, Emergency Stop Devices, specifies the following additional switch (“stop control”) requirements:

- Emergency Stop push buttons shall be located at each operator control station and at other operating stations where emergency shutdown shall be required.
- Stop and Emergency Stop push buttons shall be continuously operable from all control and operating stations where located. Do not connect E-stop buttons to the MSSl.
- Actuators of Emergency Stop devices shall be colored Red. The background immediately around the device actuator shall be colored Yellow. The actuator of a push-button-operated device shall be of the palm or mushroom-head type.
- The Emergency Stop actuator shall be a self-latching type.

NOTE: Some applications may have additional requirements. The user must refer to all relevant regulations.



WARNING . . .
Emergency Stop Switch Wiring

Whenever two or more Emergency Stop switches are connected to the same Module:

- **Contacts of the corresponding pole of each switch must be connected together in series. Never connect the contacts of multiple Emergency Stop switches in parallel to one Module.** Such a parallel connection defeats the switch contact monitoring ability of the Module and creates an unsafe condition which could result in serious injury or death.
- **Each switch must be individually actuated (engaged), then re-armed and the Module reset.** This allows the controller to check each switch and its wiring to detect faults. **Failure to test each switch individually in this manner could result in undetected faults and create an unsafe condition which could result in serious injury or death.** This check must be performed during periodic checkouts (see Section 6).

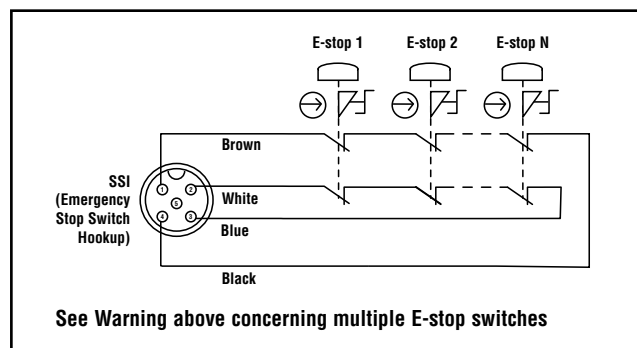

Figure 3-12. Emergency Stop switch hookup

3.5.5.2 SSI/MSSI Interlocked Safety Gate Hookup

The SSI (or MSSI) may be used to monitor interlock safety gates or guards.

Requirements vary widely for the level of control reliability or safety category per ISO 13849 (EN 954-1) in the application of interlocked guards. While Banner Engineering always recommends the highest level of safety in any application, it is the responsibility of the user to safely install, operate and maintain each safety system and comply with all relevant laws and regulations.

Safety Interlocking Switch Requirements

The following general requirements and considerations apply to the installation of interlocked gates and guards for the purpose of safeguarding. In addition, the user must refer to the relevant regulations to be sure to comply with all necessary requirements.

Hazards guarded by the interlocked guard must be prevented from operating until the guard is closed; a stop command must be issued to the guarded machine if the guard opens while the hazard is present. Closing the guard must not, by itself, initiate hazardous motion; a separate procedure must be required to initiate the motion. The safety switches must not be used as a mechanical or end-of-travel stop.

The guard must be located an adequate distance from the danger zone (so that the hazard has time to stop before the guard is opened sufficiently to provide access to the hazard), and it must open either laterally or away from the hazard, not into the safeguarded area. The guard also should not be able to close by itself and activate the interlocking circuitry. In addition, the installation must prevent personnel from reaching over, under, around or through the guard to the hazard (see OSHA 29CFR1910.217 Table O-10 or the appropriate standard). The guard must be strong enough and designed to protect personnel and contain hazards within the guarded area, which may be ejected, dropped or emitted by the machine.

The safety interlocking switches and actuators used with the MM2-TA-12B Muting Module must be designed and installed so that they cannot be easily defeated. They must be mounted securely, so that their physical position can not shift, using reliable fasteners that require a tool to remove them.



WARNING . . . Hard Guarding

It must not be possible for personnel to reach any hazard point through an opened guard (or any opening) before hazardous machine motion has completely stopped.

Please reference OSHA CFR 1910.217 and ANSI B11 standards for information on determining safety distances and safe opening sizes for your guarding devices.

Positive-Opening Safety Interlocking Switches

Safety interlock switches used with the MM2-TA-12B Muting Module must satisfy several requirements. Each switch must provide electrically isolated contacts: at minimum, two normally closed (NC) contacts from one or from two individually mounted switches.

The contacts must be of “positive-opening” design, with one or more normally closed contacts rated for safety. Positive-opening operation causes the switch to be forced open, without the use of springs, when the switch actuator is disengaged or moved from its home position (see the Banner Safety Catalog for examples). In addition, the switch(es) must be mounted in a “positive mode,” to move/disengage the actuator from its home position and open the normally closed contact, when the guard opens.

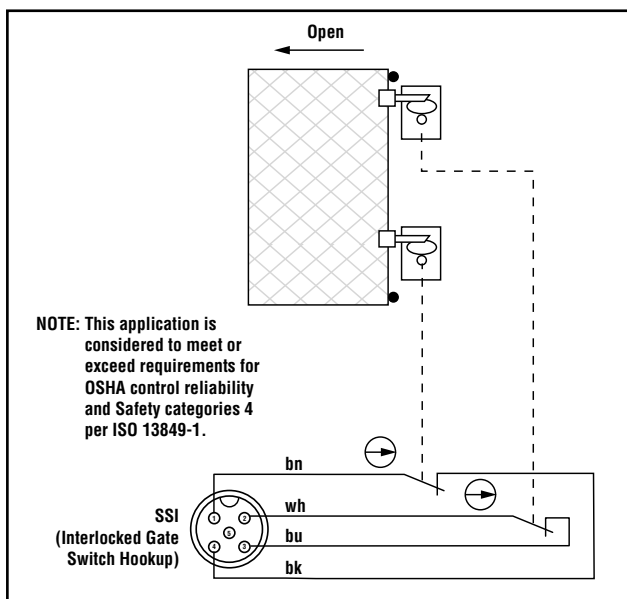

Figure 3-13. SSI monitoring two positive-opening safety interlocking switches

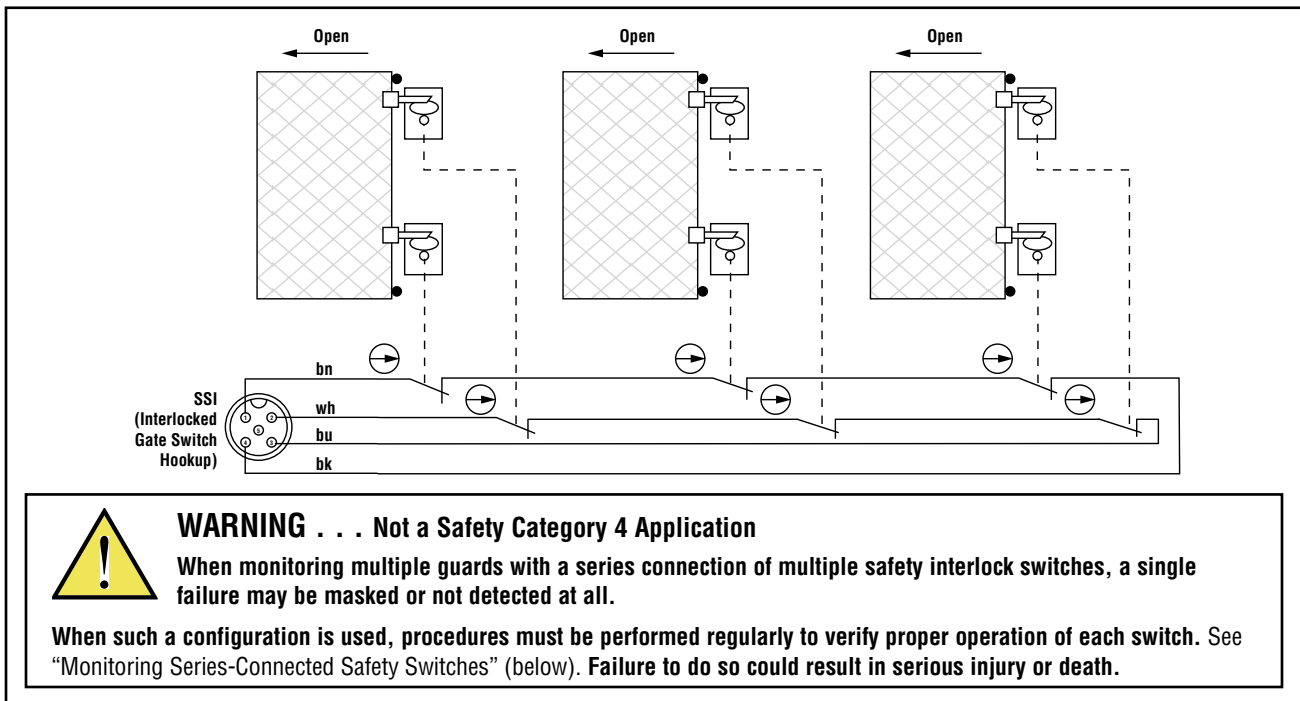

Figure 3-14. SSI monitoring positive-opening safety interlocking switches on multiple gates

Monitoring Series-Connected Safety Interlocking Switches

When monitoring two individually mounted safety switches (as shown in Figure 3-13), a faulty switch will be detected if it fails to switch as the guard opens. In this case, the Module will de-energize its output relays and disable its reset function until the input requirements are met (i.e., the faulty switch is replaced). However, when a series of safety interlocking switches is monitored by a single Module, the failure of one switch in the system may be masked or not detected at all (refer to Figure 3-14).

Series-connected interlock switch circuits may not meet OSHA Control Reliability or EN 954-1 Safety Category 4 requirements because of the potential of an inappropriate reset or a potential loss of the safety stop signal. A multiple connection of this type should not be used in applications where loss of the safety stop signal or an inappropriate reset can lead potentially to serious injury or death. The following two scenarios assume two positive-opening safety switches on each guard:

1. Masking of a failure. If a guard is opened but a switch fails to open, the redundant safety switch will open and cause the Module to de-energize its outputs. If the faulty guard is then closed, both Module input channels also close, but because one channel did not open, the Module will not reset. However, if the faulty switch is not replaced and a second “good” guard is cycled, opening and then closing both of the Module’s input channels, the Module considers the failure to be corrected. With the input requirements apparently satisfied, the Module allows a reset. This system is no longer redundant and, if the second switch fails, may result in an unsafe condition

(i.e., the accumulation of faults results in the loss of the safety function).

2. Nondetection of a failure. If a good guard is opened, the Safety Module de-energizes its outputs (a normal response). But, if a faulty guard is then opened and closed before the good guard is re-closed, the failure on the faulty guard is not detected. This system also is no longer redundant and may result in a loss of safety if the second safety switch fails to switch when needed.

The systems in either scenario do not inherently comply with the safety standard requirements of detecting single faults and preventing the next cycle. In multiple-guard systems using series-connected safety switches, it is important to periodically check the functional integrity of each interlocked guard individually. **Operators, maintenance personnel, and others associated with the operation of the machine must be trained to recognize such failures and be instructed to correct them immediately.**

Open and close each safeguard separately while verifying that the Module outputs operate correctly throughout the check procedure. Follow each safeguard closure with a manual reset, if needed. If a contact set fails, the Module will not enable its reset function. If the Module does not reset, a switch may have failed; that switch must be immediately replaced.

This check must be performed and all faults must be cleared, at a minimum, during periodic checkouts. **If the application can not exclude these types of failures and such a failure could result in serious injury or death, then the series connection of safety switches must not be used.**

3.5.5.3 SSI Supplemental Safety System Hookup

A variety of safety systems can be interfaced with the MSSSI and the SSI. Each safety application has a unique set of application requirements; the user is responsible to ensure proper installation, and use, and that all relevant standards and regulations are complied with. The following figure is a generic example of the flexibility of the SSI.

Entry/Exit Application with a Multiple Beam safety system (muted) and a safety mat system (see Appendix B for more information). This application is widely used in a variety

of situations, including manufacturing cell, robotic cells, palletizers, and de-stackers. One of the many requirements of this muting application is that it must not be possible for personnel to walk in front of, behind, or next to the muted object (e.g., the carrier basket) without being detected and stopping the hazardous motion.

Below is one example of how supplemental safeguarding (such as a safety mat system or horizontal safety light screen) can be interfaced to prevent personnel from entering the hazardous area during a mute condition.

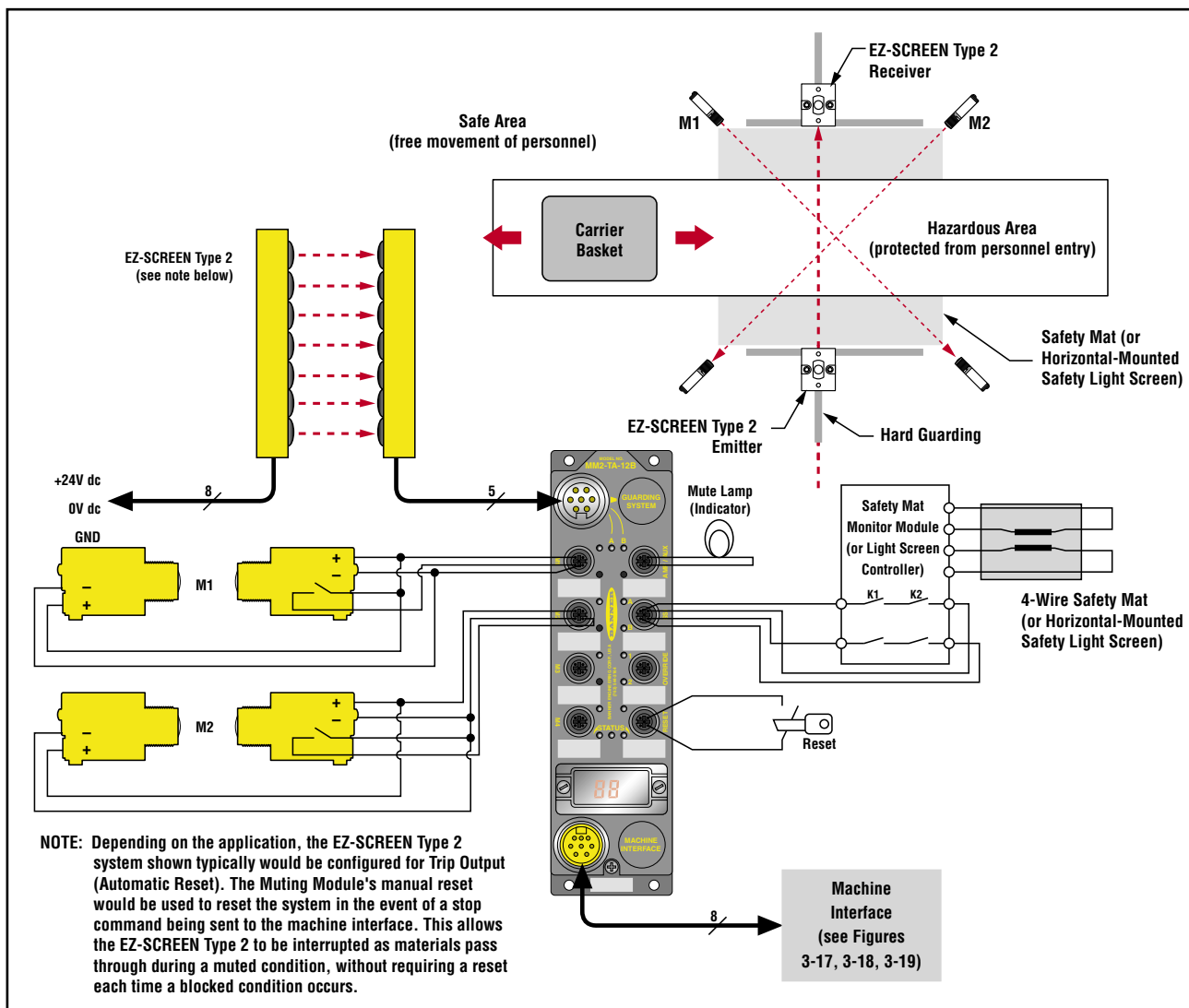

Figure 3-15. Interfacing supplemental safeguarding to prevent personnel from entering the hazardous area during the mute

3.6 Machine Interface – Initial Hookup and Checkout

The machine interface connector provides connection for supply power (+24V dc, 0V dc, and GND), mute enable (ME), external device monitoring (EDM #1 and EDM #2), and the safety outputs (OSSD #1 and OSSD #2).

Ensure that power has been removed from machine or ensure that power is not available to the machine controls or actuators, and ensure that the machine control (MPCEs) are not connected to or controlled by the OSSD safety outputs at this time. Permanent connections will be made after MM2-TA-12B Muting Module initial checkout (see Section 3.7).

Verifying System Operation

The initial checkout procedure must be performed by a Qualified Person (see WARNING, page 11). It must be performed only after configuring the MM2-TA-12B Muting Module and after properly installing and configuring the safety systems connected to its MSSSI and the SSI inputs (per Section 3).

The initial checkout procedure is performed on two occasions:

- To ensure proper installation when the System is first installed, and
- To ensure proper System function whenever any maintenance or modification is performed on the System or on the machinery being guarded by the System. (See Section 6.1 for a schedule of required checkouts.)

For the initial checkout, the MM2-TA-12B Muting Module and associated safety systems must be checked without power being available to the guarded machine. Final interface connections to the guarded machine cannot take place until these systems have been checked out.

Verify that:

- Power has been removed from (or is not available to) the guarded machine, its controls or actuators;
- The machine control circuit is not connected to the OSSD outputs at this time (permanent connections will be made following this initial checkout), and that the OSSD leads are isolated (i.e. not shorted together, not shorted to power or ground);
- EDM has been configured for No Monitoring (SW4 = ON, per Figure 3-2) and EDM#1 and EDM#2 are not connected (i.e., pins 2 and 3 left open);
- Depending on the application, it also may be necessary to temporarily disable Mute Enable (SW6 = ON, see Figure 3-2) to check out the muting function without the machine being operational;
- Other than EDM and Mute Enable, verify proper DIP switch configuration of MM2-TA-12B; and
- All input connections have been made per appropriate sections for the Mute Input Devices (M1 – M4), SSI, MSSSI, Manual Reset Switch, Mute Lamp, Aux Output, and Override Input.

This will allow the MM2-TA-12B Muting Module and the associated safety systems to be checked out, by themselves, before permanent connections are made to the guarded machine.

3.6.1 Temporary Power and Initial Checkout

1. Connection of system DC power is at pin 1 (+24V dc) and pin 6 (0V dc) of the machine interface connector (see Section 3.4 and Figure 3-3). All wiring must comply with NEC and local wiring codes. Do not operate the MM2-TA-12B Muting Module without a proper earth ground connection at pin 7 of the Machine Interface connector, or at the earth ground screw on the housing.
2. Leaving power to the guarded machine OFF, power up the MM2-TA-12B and the safety systems connected to the MSSl and the SSl inputs.
3. Perform system checkout procedures for the external safety systems connected to the MSSl and SSl inputs as described by the appropriate manuals. Do not proceed further until all checkout procedures are completed successfully and all problems have been corrected.
4. Verify that the external safety systems are providing a Green/GO signal to the MSSl and SSl inputs (i.e., Banner OSSD sourcing signal or a closed contact connected to the "Signal" pin of each interface). Verify that the green Channel indicators (two pairs of LEDs located near each connector) are ON.

NOTE: If the SSl is not to be used, pin 1 must be jumpered to pin 4, and pin 2 must be jumpered to pin 3 (factory default). Do not short Channel A to Channel B. See Section 3.5.5.

5. **Auto Reset Configuration:** Verify that the Green status LED is ON, indicating that the OSSD outputs are ON, and that a "—" appears on the Diagnostic Display. If not, or if the Red status indicator begins to flash at any time, refer to Section 5 for troubleshooting information.

Manual Reset Configuration: Verify that the Yellow status LED is flashing to indicate that a reset is being requested, and that a "—" appears on the Diagnostic Display. If not, or if the Red status indicator begins to flash at any time, refer to Section 5 for troubleshooting information.

Perform a manual reset by closing the Reset Input for at least 1/4 second, but not longer than 2 seconds, and then reopening the contact. Verify that the Green status Indicator comes on steady. The MM2-TA-12B OSSD outputs should be ON at this time.

6. Cycle the MSSl and the SSl (if used) individually and ensure that the Green status indicator goes OFF, and that a reset is possible after the Interface is closed.

If any of these checks fail, do not attempt to use the system until the reason for the failure(s) is identified and corrected.

If the Muting function is not used, proceed to Section 3.7.

During the initial checkout procedure of the Muting feature, if possible, verify that the power has been removed or is otherwise not available to the machine actuators responsible for hazardous motion. At all times ensure that personnel are not exposed to any hazard.

7. Mute the System by blocking (or activating) both mute devices (typically M1- M2) simultaneously (within 3 seconds).
8. Verify that the Mute indicator comes ON. If not, check the indicator and its wiring, and check the Diagnostic Display for error codes.
9. Generate a stop command from the safeguarding device connected to the MSSl (e.g., interrupt the defined area of a safety light screen). Verify that MSSl Channel A and B indicators go OFF, but the Green status indicator remains ON.

NOTE: If the 30- or 60-second Backdoor Timer feature has been selected, the Diagnostic Display will begin to count down; otherwise a flashing dash will appear on the display.

10. Clear the Stop command (before the Backdoor Timer expires) and verify that the MSSl Channel A and B indicators come ON. Clear (deactivate) the mute devices before the Backdoor Timer expires and verify the Mute indicator goes OFF. The Green status indicator should remain ON.
11. Verify that it is not possible for a single individual to initiate a mute condition by triggering the mute devices (for example, by blocking both photoelectric beams or actuating both switches) and being able to pass through the safeguard without being detected and without issuing a stop command to the machine. Do not expose any individual to hazard while attempting to mute the system.
12. Verify that it is not possible for personnel to pass in front of, behind, or next to the muted object without being detected and without issuing a stop command to the machine.
13. If one-way (directional) muting has been selected, verify that the system can not be muted by blocking (or activating) M3-M4 before M1-M2. Do not expose any individual to hazard while attempting to mute the system.

If all checks have been verified, proceed to Section 3.7. If any of these checks fail, do not attempt to use the system until the reason for the failure(s) is identified and corrected.

3.7 Permanent Hookup

OSSD and EDM Connections and Electrical Interface to the Guarded Machine

Supply power, the external reset switch, and other inputs (as required by each application) should be previously connected by this point. The final connections to be made are:

- Mute enable,
- EDM hookup,
- OSSD outputs,
- FSD interfacing, and
- MPCE connections.

3.7.1 Mute Enable Hookup

The Machine Interface connector provides connection for the Mute Enable input (ME) (see Section 1.12). Mute Enable gives the user the ability to “frame” or create a “window of opportunity” when a mute can occur. When configured, the Mute Enable input is a contact that must be closed before the safeguard can be muted. After the safeguard is muted, opening of the Mute Enable input has no effect, but it must be re-closed before the safeguard can be muted again.

If Mute Enable is not to be used, leave the connection open and configure DIP switch SW6 to “ON” (see Figure 3-2).



WARNING . . . Shock Hazard

Always disconnect power from the Safety System and the guarded machine before making any connections or replacing any component. Use extreme caution to avoid electrical shock at all times. Serious bodily injury or death could result.



WARNING . . . Proper Wiring

The generalized wiring configuration shown in Figures 3-17, 3-18, and 3-19 are provided only to illustrate the importance of proper installation. The proper wiring of the Safety system to any particular machine is the sole responsibility of the installer and end user.

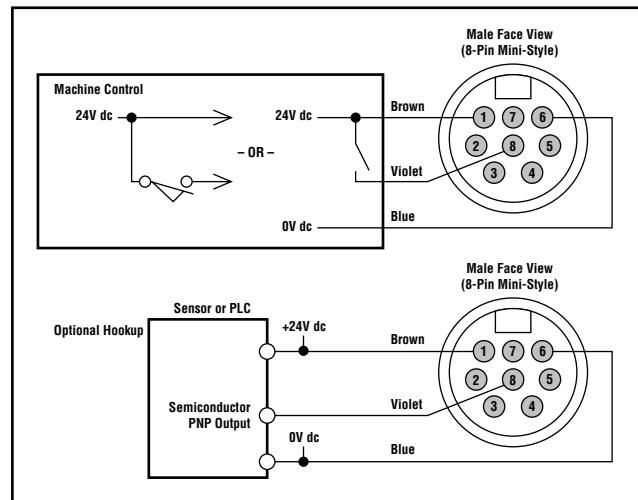

Figure 3-16. Mute Enable hookup

**CAUTION . . . EDM Configuration**

If the application does not require this function, the EDM#1 and EDM#2 inputs must be left open and "EDM Disable = ON" must be configured (see Section 3.2.2). It is the user's responsibility to ensure that this does not create a hazardous situation.

NOTICE Regarding External Device Monitoring Hookup

It is strongly recommended that one normally closed, forced-guided, monitoring contact of each MPCE or external device be wired in order to monitor the state of the MPCEs (as shown in Figures 3-17 to 3-19). If this is done, proper operation of the MPCEs will be verified. MPCE monitoring contacts must be used in order to detect improper functioning of the MPCEs.

**WARNING . . . OSSD Interfacing**

To ensure proper operation, the MM2-TA-12B output parameters and machine input parameters must be considered when interfacing the solid-state OSSD outputs to the machine inputs.

Machine control circuitry must be designed so that the maximum load resistance value is not exceeded and so that the maximum specified OSSD OFF-state voltage does not result in an ON condition.

Failure to properly interface the OSSD outputs to the guarded machine could result in an increased risk of harm.

3.7.2 External Device Monitoring (EDM) Hookup

The Machine Interface connector provides connection terminals for the External Device Monitoring input (EDM #1 and EDM #2). External Device Monitoring (EDM) must be wired in one of three configurations:

- **One-Channel Monitoring** — SW4 Bank A&B = OFF, (see Figure 3-19) SW5 Bank A&B = OFF

NOTE: EDM #2 input must be left open.

- **Two-Channel Monitoring** — SW4 Bank A&B = OFF, (see Figures 3-17, 3-18) SW5 Bank A&B = ON

- **No Monitoring** — SW4 Bank A&B = ON, SW5 Bank A&B = ON or OFF

NOTE: EDM #1 and EDM #2 inputs must be left open.

After the initial checkout has been successfully completed, the EDM configuration that disabled the monitoring function must be properly reconfigured. The External Device Monitoring inputs then must be properly connected to the closed monitoring contacts of the MPCEs (see Section 1.10). Refer to the NOTICE Regarding MPCE Monitoring Hookup, at left, and Figures 3-17, 3-18 and 3-19.

3.7.3 OSSD Output Connections

Both the output signal switching device (OSSD) outputs must be connected to the machine control such that the machine's safety related control system interrupts the circuit or power to the machine primary control element(s) (MPCE), resulting in a non-hazardous condition.

Final switching devices (FSDs) typically accomplish this when the OSSDs go to an OFF state. See Figure 3-17.

Refer to the output specifications (Section 2) and Warnings at left before making OSSD connections and interfacing the MM2-TA-12B Muting Module to the machine.

3.7.4 FSD Interfacing Connections

Final switching devices (FSDs) can take many forms, though the most common are captive contact, forced-guided relays or Interfacing Modules. The mechanical linkage between the contacts allow the device to be monitored by the external device monitoring circuit for certain failures.

Dependent on the application, the use of FSDs can facilitate controlling voltage and current that differs from the OSSD outputs of the Module. FSDs can also be used to control an additional number of hazards by creating multiple safety stop circuits.

Safety Stop Circuits

A safety stop allows for an orderly cessation of motion for safeguarding purposes, which results in a stop of motion and removal of power from the MPCEs (assuming this does not create additional hazards). A safety stop circuit typically comprises of a minimum of two normally open contacts from captive contact, forced-guided relays, which are monitored to detect certain failures such that the loss of the safety function does not occur (i.e. external device monitoring). Such a circuit can be described as a “safe switching point”.

Typically, safety stop circuits are either single channel (a series connection of at least two N.O. contacts); or dual channel (a parallel connection of two N.O. contacts). In either method, the safety function relies on the use of redundant contacts to control a single hazard, so that if one contact fails ON, the second contact will arrest the hazard and prevent the next cycle from occurring.

Interfacing safety stop circuits must be wired so that the safety function can not be suspended, overridden, or defeated, unless accomplished in a manner at the same or greater degree of safety as the machine’s safety-related control system that includes the Module.

The normally open outputs from an IM-T-9A or -11A interfacing module are a series connection of redundant contacts that form safety stop circuits and can be used in either single-channel or dual-channel control methods. (See Figures 3-18 and 3-19.)

Dual-Channel Control

Dual-channel (or two-channel) control has the ability to electrically extend the safe switching point beyond the FSD contacts. With proper monitoring (i.e., EDM), this method of interfacing is capable of detecting certain failures in the control wiring between the safety stop circuit and the MPCEs. These failures include a short-circuit of one channel to a secondary source of energy or voltage, or the loss of the switching action of one of the FSD outputs. The result could lead to the loss of redundancy or a complete loss of safety if not detected and corrected.

The possibility of a failure to the wiring increases as the physical distance between the FSD safety stop circuits and the MPCEs increase, as the length or the routing of the interconnecting wires increases, or if the FSD safety stop circuits and the MPCEs are located in different enclosures. Thus, dual-channel control with EDM monitoring should be used in any installation where the FSDs are located remotely from the MPCEs.

Single-Channel Control

Single-channel (or one-channel) control, as mentioned, uses a series connection of FSD contacts to form a safe switching point. After this point in the machine’s safety-related control system, failures can occur that would result in the loss of the safety function (e.g., a short-circuit to a secondary source of energy or voltage).

Thus, this method of interfacing should only be used in installations where FSD safety stop circuits and the MPCEs are physically located within the same control panel, adjacent to each other, and are directly connected to each other; or where the possibility of such a failure can be excluded. If this can not be achieved, then two-channel control should be used.

Methods to exclude the possibility of these failures include, but are not limited to:

- Physically separating interconnecting control wires from each other and from secondary sources of power.
- Routing interconnecting control wires in separate conduit, runs, or channels.
- Routing interconnecting control wires with low voltage or neutral that can not result in energizing the hazard.
- Locating all elements (modules, switches, devices under control, etc.) within the same control panel, adjacent to each other, and directly connected with short wires.
- Properly installing multi-conductor cabling and multiple wires that pass through strain-relief fittings. Over-tightening of a strain-relief can cause short-circuits at that point.
- Using positive-opening or direct-drive components installed and mounted in a positive mode.

3.8 Commissioning Checkout

After power is connected to the MM2-TA-12B Muting Module, the EDM has been properly configured, and the OSSD outputs have been connected to the machine to be guarded, the operation of the MM2-TA-12B Muting Module with the guarded machine must be verified before the combined System may be put into service. To do this, a Qualified Person must perform the Commissioning Checkout Procedure described in Section 6.2.

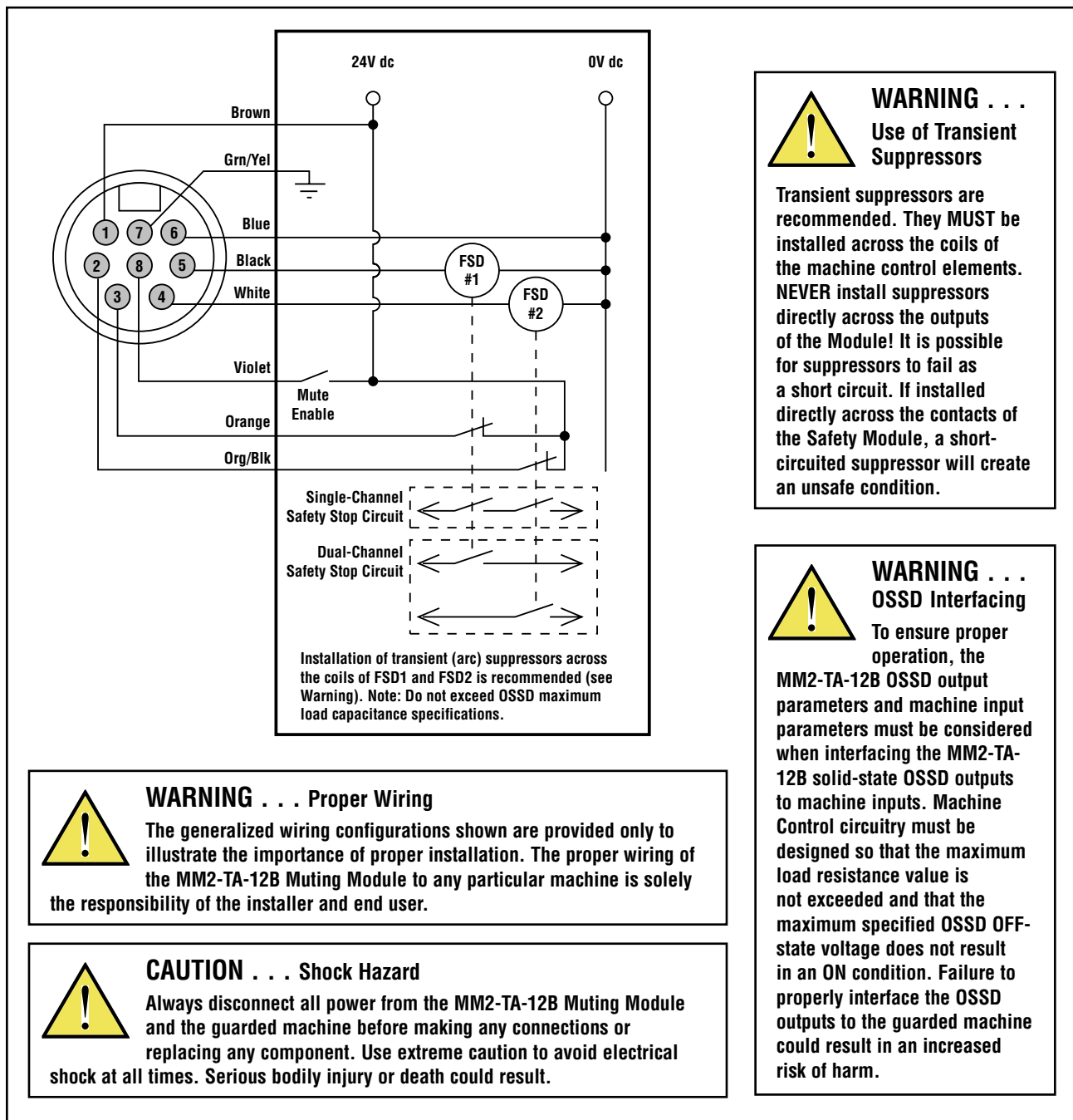

Figure 3-17. Generic hookup: FSD, two-channel EDM, Mute Enable

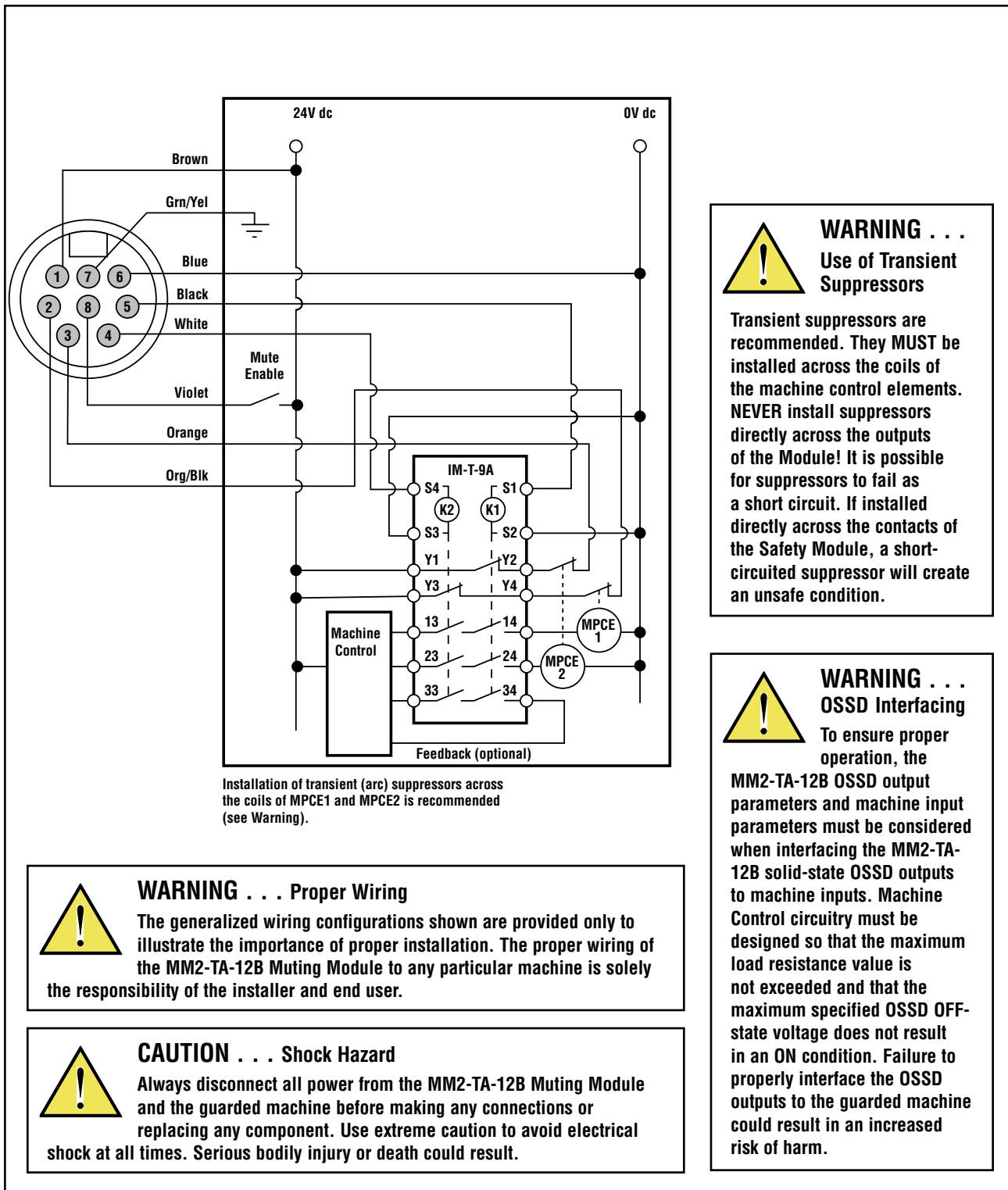

Figure 3-18. Generic hookup: interface module, two-channel EDM, Mute Enable

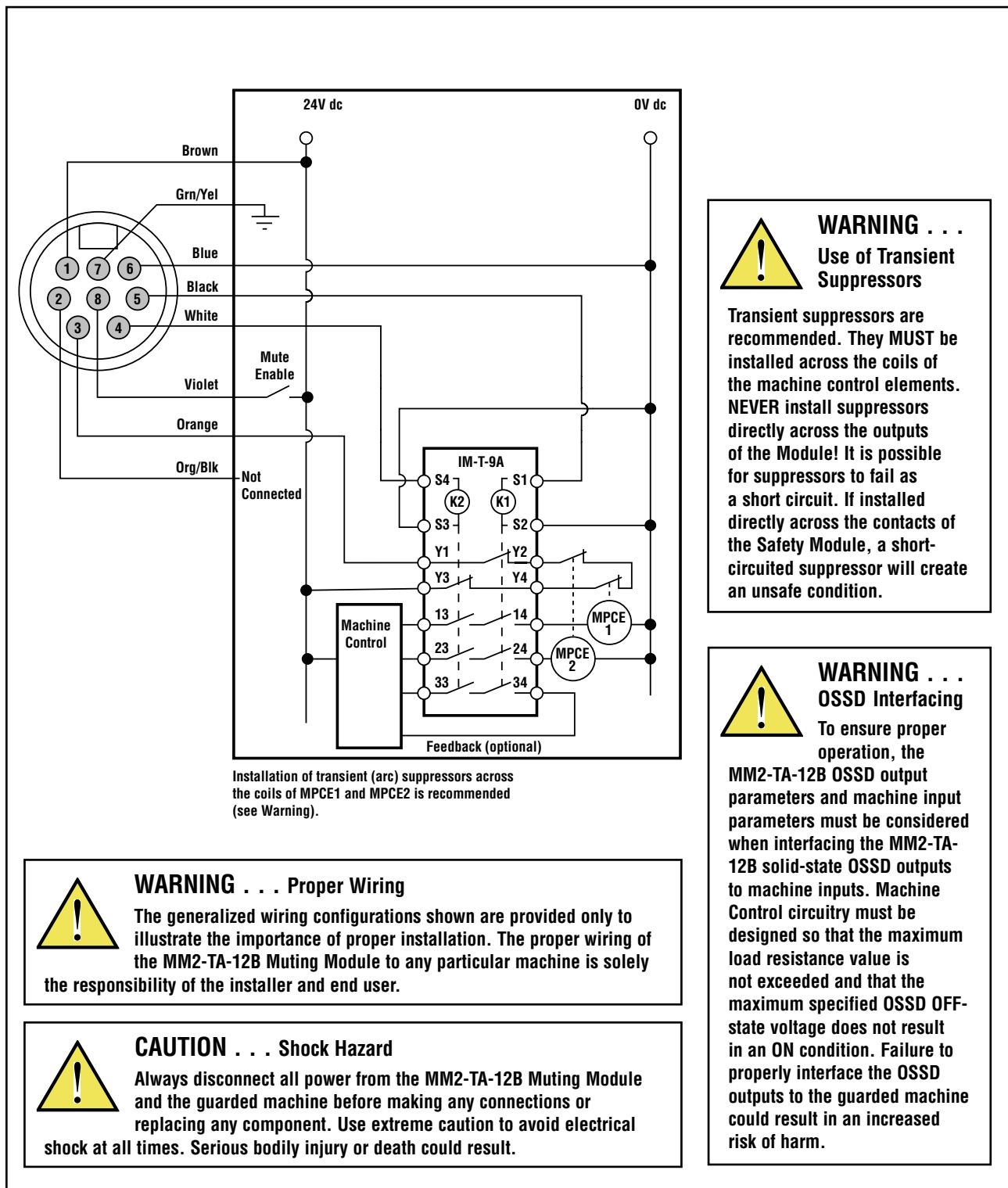

Figure 3-19. Generic hookup: interface module, one-channel EDM, Mute Enable

4. Operating Instructions

4.1 Security Protocol

The Module should be mounted inside a lockable enclosure in order to prevent access by unauthorized personnel, if required by applicable standards.

The key (or combination) to the enclosure should be kept in the possession of a Qualified Person and only they should have access to the configuration switches. A Qualified Person is defined as an individual who, by possession of a recognized degree or certificate of professional training, or who, by extensive knowledge, training, and experience, has successfully demonstrated the ability to solve problems relating to the subject matter and work.

4.2 Periodic Checkout Requirements

In addition to the checkouts that are performed by a Qualified Person or persons at the time that the Module is installed and put into service, the functioning of the safeguarding and the machine must be verified on a regular periodic basis to ensure proper operation. This is absolutely vital and necessary. Failure to ensure proper operation can lead to serious injury or death.

See Section 6 for checkout schedules and procedures.



WARNING . . . Verify Proper Operation

The MM2-TA-12B Muting Module and safety systems can do the job for which it was designed only if it and the machine it guards are operating properly, both separately and together. **It is the user's responsibility to verify proper operation, on a regular basis, as instructed in Section 6.**

If the MM2-TA-12B Muting Module, safety systems, and the guarded machine do not perform exactly as outlined in the checkout procedures, the cause of the problem must be found and corrected before the system is put back into service.

Failure to correct such problems can result in an increased risk of harm.

4.3 Normal Operation

During normal operation, the Module's three status indicators (red, green and yellow) are as shown in Figure 4-1. In addition, green indicators adjacent to each of the Module's inputs/interfaces come ON to verify an active state of that circuit.

During normal operation, the Diagnostic Display will read "—" (solid or, if during the mute cycle, flashing). Any number that appears in the Display signifies an error; see Section 5.2 for more information.

See Section 3.5.1 for information on the reset routine.

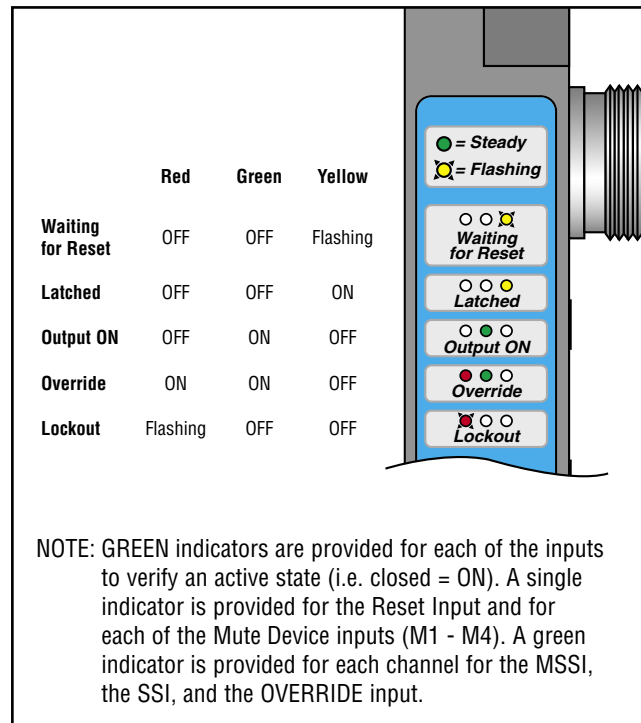

Figure 4-1. Muting Module Status Indicator conditions (see Figure 1-2)

5. Troubleshooting and Maintenance

5.1 Troubleshooting Lockout Conditions

A lockout condition causes the OSSD output to turn OFF, sending a stop signal to the guarded machine. A lockout condition is indicated by the Red status indicator flashing and an error code appearing in the Diagnostic Display. To clear a lockout condition, the failure must be corrected, the associated input must properly cycled (if fault was due to an input failure), or a reset routine must be performed.

To perform a reset, close the reset input, hold closed for at least 1/4 second, but no longer than 2 seconds, and then re-open the input.

5.2 Diagnostic Display

The Module's Diagnostic Display is useful for monitoring the safeguarding system and for quickly diagnosing problems. See Figure 5-1 for a list of status codes and their meanings, along with recommended corrective actions.

5.3 Effects of Electrical Noise

The Module is designed and manufactured to be highly resistant to electrical noise and to operate reliably in industrial settings. However, serious electrical noise may cause a random lockout condition.

Check the following if a noise-related error code is displayed and other remedies have not cleared the problem:

- Poor connection between the Module and earth ground. Use a short wire from the earth ground screw to the nearest location on a grounded metal mounting surface.
- Sensor wires or input/output wires routed too close to "noisy" wiring.

In extreme conditions, it may be necessary to use shielded cabling or relocate the Module, mute devices, and cabling away from the source of the noise. All connectors have an earth ground connection (e.g., pin 5 of the Euro-style connectors) to assist in shielding cables, if necessary.



WARNING . . . Power Failures

Power failures or other Module lockout conditions should always be investigated immediately by a Qualified Person. A lockout is a definite indication of a problem and should be investigated at once. Attempts to continue to operate machinery by bypassing the Module are dangerous and could result in an increased risk of harm.



WARNING . . . Shut Down Machinery Before Servicing

The machinery to which the EZ-SCREEN Type 2 is connected **must not be operating at any time during major service or maintenance**. This may require lockout/tagout procedures (refer to OSHA 1910.147, ANSI Z244-1, or the appropriate standard for controlling hazardous energy). **Servicing the EZ-SCREEN Type 2 while the hazardous machinery is operational could result in serious bodily injury or death.**

5.4 Repairs

NOTE: Do not attempt any repairs to the Module. It contains no field-replaceable components. Return the Module to the factory for warranty repair or replacement.

If it ever becomes necessary to return a Module to the factory, please do the following:

1. Contact the Banner applications engineering department at the numbers or address listed on the front cover. They will attempt to troubleshoot the system from your description of the problem. If they conclude that a component is defective, they will issue an RMA (Return Merchandise Authorization) number for your paperwork, and give you the proper shipping address.
2. Pack the Module carefully. Damage which occurs in shipping is not covered by warranty.

Status / Error Code	Condition / Error Type / Action	Status / Error Code	Condition / Error Type / Action
— (Solid)	System OK	39	EDM 2 Error - Check wiring - Check operation of Device(s) under control
— (Flashing)	Mute Cycle		- Check DIP switch settings - Switching transition > 200 ms - Excessive EMI/RFI noise
31	OSSD Output Error - One OSSD is shorted to power/ground - OSSDs are shorted together	40	2-Channel EDM Error - Check wiring - Check operation of Device(s) under control
32	Reset Input Error - Reset Input Shorted/Closed		- Failed Simultaneity between EDM1 & EDM2 (> 200 ms) - EDM open > 200 ms after OSSDs go OFF - Replace Module
33	Module Error - Excessive EMI/RFI noise - Internal failure, replace Module	45	Mute Enable Input Error - Excessive EMI/RFI noise
34	MSSI Error* - One or both channels shorted to power or ground - Input contacts shorted together - One channel did not open - Failed Simultaneity (> 3 sec) - Excessive EMI/RFI noise	50	Backdoor Timer Expired - Check muting device operation - Check muting device wiring - Check DIP switch settings - See manual Section 1.14
35	Override Error - Override Input closed at power-up - Check Override Input wiring and connector - Excessive EMI/RFI noise	51	Mute Timing (Simultaneity) Error - The second mute device of a pair (M1-M2 or M3-M4) did not actuate within 3 seconds of the first device. - Check muting device operation - Check wiring
36	Mute Lamp Error - Check/Replace Lamp (open or short) - Check wiring and connector - Check DIP switch settings	52	Mute Enable Open Error - ME input was open when a mute cycle was attempted - Check Mute Enable wiring - Check DIP switch settings
37	DIP switch Error - Check DIP switch settings - Replace Module	61	SSI Input Error** - One or both channels shorted to power or ground - Input contacts shorted together - One channel did not open - Failed Simultaneity (> 3 sec) - Excessive EMI/RFI noise
38	EDM 1 Error - Check wiring - Check operation of Device(s) under control - Check DIP switch settings - Switching transition > 200 ms - Excessive EMI/RFI noise - EDM open > 200 ms after OSSDs go OFF		

*Fault is cleared by cycling the input from closed-to-open-to-closed.
**Fault is cleared by cycling the input from closed-to-open.

Figure 5-1. Troubleshooting conditions, using the Module's Diagnostic Display

6. Periodic Checkout Procedures

Study each procedure from beginning to end before you start to make sure that you understand each step. Refer all questions to the Banner Applications Engineering Department at the address or numbers listed on the front cover of this manual. Checkouts must be performed as detailed in Section 6.1 below and results should be recorded and kept in the appropriate place (e.g., near the machine, and/or in a technical file).

6.1 Schedule of Checkouts

Initial Checkout: The procedure for initial checkout of the MM2-TA-12B System is described in Section 3.6. This procedure is performed at installation, and at any time the System, the guarded machine, or any part of the application is installed or altered. The procedure must be performed by a Qualified Person.

Commissioning Checkout: Should be performed after installation or whenever changes are made to the system (either a new configuration of the MM2-TA-12B System or changes to the machine). The procedure must be performed by a Qualified Person. See Section 6.2.

Daily Checkout: The procedure for “daily” checkout of the MM2-TA-12B System is to be performed at each shift change or machine setup change, whenever the System is powered up, at least daily. The procedure may be performed by a Designated Person or a Qualified Person. See Section 6.3.

Semi-Annual Checkout: The procedure for initial checkout of the MM2-TA-12B System is to be performed every six months, following installation of the System. The procedure must be performed by a Qualified Person. See Section 6.4.



WARNING . . . Do Not Use Machine Until System Is Working Properly

If all of these checks cannot be verified, do not attempt to use the MM2-TA-12B System/guarded machine until the defect or problem has been corrected (see Section 5).

Attempts to use the guarded machine under such conditions could result in serious bodily injury or death.



WARNING . . . Before Applying Power to the Machine

Verify that the guarded area is clear of personnel and unwanted materials (such as tools) before applying power to the guarded machine.

Failure to do so could result in serious bodily injury or death.

6.2 Commissioning Checkout

Perform this checkout procedure as part of Safeguarding System installation (after the System has been interfaced to the guarded machine as described in Sections 3.6 and 3.7), or whenever changes are made to the System (either a new configuration of the Module, devices connected to it, or changes to the machine). A Qualified Person (as defined in the Safety Glossary) must perform the procedure; checkout results should be recorded and kept on or near the guarded machine, per OSHA 1910.217(e)(1).

To prepare the MM2-TA-12B Module for this checkout, ensure the configuration is as it will be during machine operation.

Safeguarding Checkout

1. Examine the guarded machine to verify that it is of a type and design compatible with the safeguarding system that has been installed. See page 2.
2. Verify the system(s) checkout procedures for the external safety systems connected to the MSSl and the SSl inputs as described by the appropriate manuals. Do not proceed until all checkout procedures are completed successfully and all problems have been corrected.3).
3. Verify that
 - Access to any dangerous parts of the guarded machine is not possible from any direction not protected by the safeguarding system, hard guarding, or supplemental safeguarding, and that
 - Supplemental safeguarding and hard guarding, as described by the appropriate safety standards, are in place and functioning properly.
4. Verify that the Reset switch is mounted outside the guarded area, out of reach of anyone inside the guarded area, and that means of preventing inadvertent use is in place.
5. Examine the electrical wiring connections between the Module's OSSD outputs and the guarded machine's control elements to verify that the wiring meets the requirements stated in Section 3.7.

6. Apply power to the Module. Ensure that power to the guarded machine is OFF. Verify that the external safety systems are providing a Green/Go signal to the MSSSI and USSSI inputs, and that the Green channel indicators (two pairs of LEDs located near each connector) are ON. When configured for Manual Reset, the Yellow status indicator will be flashing. Perform a manual reset (close the Reset switch for 1/4 to 2 seconds, then open the switch). Verify that the Green status indicator is ON steady.

NOTE: A Red flashing status indicator signifies a lockout condition. Refer to Section 5 for information.

7. In a non-muted condition, generate a stop command from the safeguarding device connected to the MSSSI (e.g. interrupt the defined area of a safety light screen). Verify that MSSSI Channel A and B and the Green status indicators go OFF. In order, reset the safeguard and then the Module (in Manual Reset).
8. Generate a stop command from the safeguarding device connected to the SSI (e.g., actuate E-stop button). Verify that SSI Channel A and B and the Green status indicators go OFF. In order, reset the safeguard and then the MM2-TA-12B Module (in Manual Reset).
9. Apply power to the guarded machine and verify that the machine does not start up. Generate a stop command from the safeguarding device connected to the SSI and the MSSSI in a non-muted condition. Verify that it is not possible for the guarded machine to be put into motion while either stop commands are present. In order, reset the safeguard and then the MM2-TA-12B Module (in Manual Reset).
10. Initiate machine motion of the guarded machine and, while it is moving, as in step #9 above, generate a stop command from each safeguarding device. Do not attempt to insert anything into the dangerous parts of the machine. Upon issuing the stop command, the dangerous parts of the machine should come to a stop with no apparent delay. Upon reset of the safeguard and the MM2-TA-12B, verify that the machine does not automatically restart, and that the initiation devices must be engaged to restart the machine.
11. Remove electrical power to the MM2-TA-12B Module. All OSSD outputs should immediately turn OFF, and should not be capable of turning ON until power is re-applied and a reset is accomplished.
12. Test the machine stopping response time, using an instrument designed for that purpose, to verify that it is the same or less than the overall system response time specified by the machine manufacturer. (Banner's Applications Engineering Department may be able to recommend a suitable instrument.)

Do not continue operation until the entire checkout procedure is complete and all problems are corrected.

Muting Checkout

13. Verify that the MM2-TA-12B Module has been reset and the Green status indicator is ON. If the Yellow status indicator is flashing (indicating the MM2-TA-12B is waiting for a reset of a latched condition), perform a manual reset. At any time, if the Red status indicator begins to flash, a lockout condition exists. Refer to Section 5.1 to determine the cause of the lockout.

During this procedure, at all times ensure that personnel are not exposed to any hazard.

14. Mute the system by blocking (or activating) both mute devices (typically M1- M2) simultaneously (within 3 seconds).
15. Verify that the Mute indicator comes ON. If not, check the indicator and its wiring, verify that the mute enable input is closed, and check the Diagnostic Display for error codes.
16. Generate a stop command from the safeguarding device connected to the MSSSI; verify the green MSSSI channel indicators are OFF, and the Green status indicator is ON.

NOTE: If the 30- or 60-second Backdoor Timer feature has been selected, the Diagnostic Display will begin to count down; otherwise a flashing dash will appear on the display.

17. Clear or reset the safeguard (before the Backdoor Timer expires) and verify the green MSSSI channel indicators are ON. Clear (deactivate) the mute devices before the Backdoor Timer expires and verify the Mute indicator goes OFF. The Green status indicator should remain ON.
18. Verify that it is not possible for a single individual to initiate a mute condition by triggering the mute devices (for example, by blocking both photoelectric beams or actuating both switches) and access the hazard without being detected and issuing a stop command to the machine (where the green status indicator goes OFF, and a reset of the latch condition is required). Do not expose any individual to hazard while attempting to mute the system.
19. Verify that it is not possible for personnel to pass in front of, behind, or next to the muted object without being detected and without issuing a stop command to the machine.
20. If one-way (directional) muting has been selected, verify that the system can not be muted by blocking (or activating) M3-M4 before M1-M2. Do not expose any individual to hazard while attempting to mute the system.

If any of these checks fail, do not attempt to use the system until the reason for the failure(s) is identified and corrected.

6.3 Daily Checkout

Perform this checkout procedure at every shift change, power-up and machine set-up change. During continuous machine run periods, this checkout must be performed at intervals not to exceed 24 hours. A Designated Person or Qualified Person (as defined in Section 1.18) must perform the procedure; checkout results should be recorded and kept on or near the guarded machine, per OSHA 1910.217(e)(1).

1. Verify that access to the guarded area is not possible from any area not protected by the safeguards interfaced with the MM2-TA-12B system. Hard guarding, or supplemental presence-sensing devices must be installed, wherever needed, to prevent any person from reaching around the light grid or entering into the hazard area. Verify that all supplemental guarding devices and hard guarding are in place and operating properly.
2. Verify that the safeguards interfaced with the MM2-TA-12B system have been properly installed and maintained. See relevant instruction manuals or data sheets.
3. Verify that it is not possible for a person to access the hazard(s), undetected by the safeguards interfaced with the MM2-TA-12B system or by other supplemental guarding (as described in appropriate standards).
4. Verify the system(s) checkout procedures for the external safety systems connected to the MSSI and the SSI inputs as described by the appropriate manuals.
5. Initiate machine motion of the guarded machine and, during the cycle, generate a stop command from the safeguarding device. Do not attempt to insert anything into the dangerous parts of the machine. Upon issuing the stop command, the dangerous parts of the machine should come to a stop with no apparent delay. Upon reset of the safeguard and the MM2-TA-12B, verify that the machine does not automatically restart, and that the initiation devices must be engaged to restart the machine.
6. With the guarded machine at rest, generate a stop command from the safeguarding device(s) and verify that it is not possible for the guarded machine to be put into motion.
7. Check carefully for external signs of damage or changes to the MM2-TA-12B system, the interfaced safeguards, the guarded machine, and their electrical wiring. Any damage or changes found should be immediately reported to management.

If any of these checks fail, do not attempt to use the system until the reason for the failure(s) is identified and corrected.

6.4 Semi-Annual Checkout

Perform this checkout procedure every six months following System installation. A Qualified Person (as defined in Section 1.18) must perform the procedure; checkout results should be recorded and kept on or near the guarded machine, per OSHA 1910.217(e)(1).

1. Perform the commissioning checkout procedure (Section 6.2) If any decrease in machine braking ability has occurred, make the necessary clutch/brake repairs, readjust safeguard separation distance (Ds) appropriately, record the new Ds calculation, and re-perform the Daily Checkout procedure.
2. Examine and test the machine primary control elements (MPCEs) and any intermediary controls (such as interface modules) to verify that they are functioning correctly and are not in need of maintenance or replacement.
3. Inspect the guarded machine to verify that no other mechanical or structural problems could prevent the machine from stopping or assuming an otherwise safe condition when signalled to do so by the MM2-TA-12B system.
4. Examine and inspect the machine controls and connections to the MM2-TA-12B system to verify that no modifications have been made which adversely affect the System.

If any of these checks fail, do not attempt to use the system until the reason for the failure(s) is identified and corrected.

Appendix A. Mute Timing Sequences

Muting Sequence with Two Muting Devices

(For example, "X"-pattern Entry/Exit System, see Figure B-1)

DIP Switch Configuration*:

- Manual ResetSW1 = OFF
- Monitored Muting LampSW2 = OFF
- Two-Way MutingSW3 = ON
- EDM FunctionalSW4 = OFF
- One-Channel EDMSW5 = OFF
- ME FunctionalSW6 = OFF
- 30-Second Backdoor Timer ..SW7&8 = OFF

*Both DIP switch banks A and B.

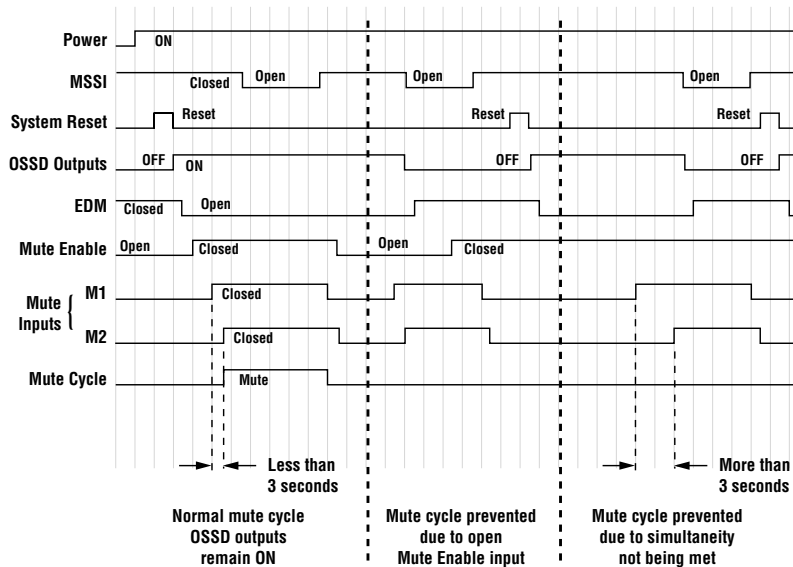

Muting Sequence with Four Muting Devices

(For example, an Entry/Exit System using four photoelectric devices; see Figure B-4)

DIP Switch Configuration*:

- Manual ResetSW1 = OFF
- Monitored Muting LampSW2 = OFF
- Two-Way MutingSW3 = ON
- EDM FunctionalSW4 = OFF
- One-Channel EDMSW5 = OFF
- ME FunctionalSW6 = OFF
- 30-Second Backdoor Timer ..SW7&8 = OFF

*Both DIP switch banks A and B.

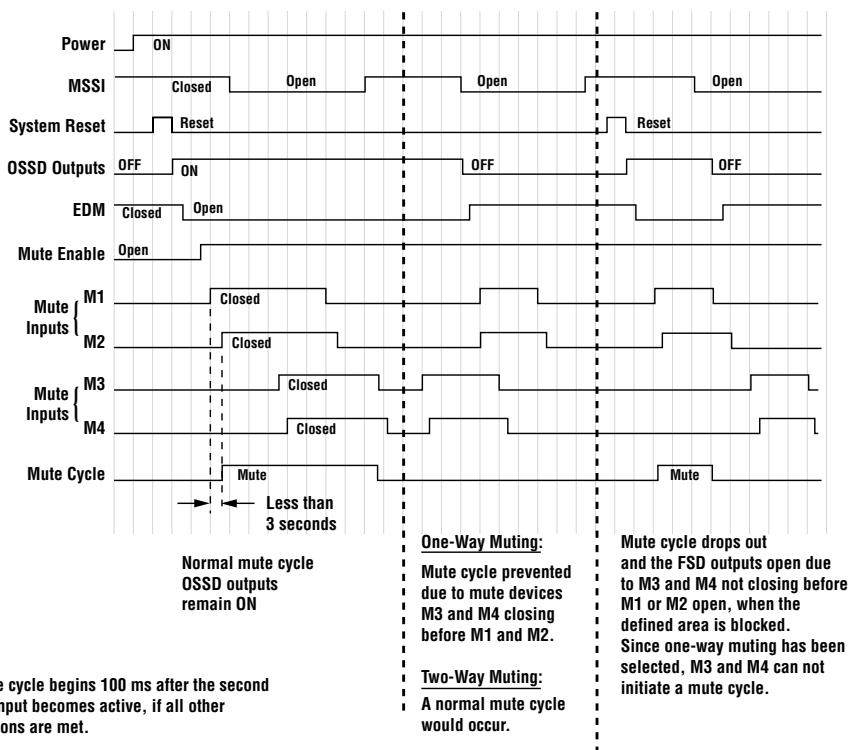

NOTE: A mute cycle begins 100 ms after the second mute input becomes active, if all other conditions are met.

Appendix B. Typical Muting Applications

Entry/Exit Applications

Muting devices must be placed to ensure that the points that trigger the mute's start and end are very close to the safety light screen's sensing field. This prevents personnel from following, or being pushed by, the object into the hazardous area without interrupting the safety light screen before the mute window opens or at the time the mute window closes.

When two pairs of opposed-mode photoelectrics are used as muting devices, as shown below, the crossing point of the two sensing paths must be on the hazardous side of the safety light screen. The safety light screen will be interrupted before any personnel would be able to block both beams and mute the system. The devices should detect the material and not the pallet or the transport in order to hinder an individual from riding into the hazardous area.

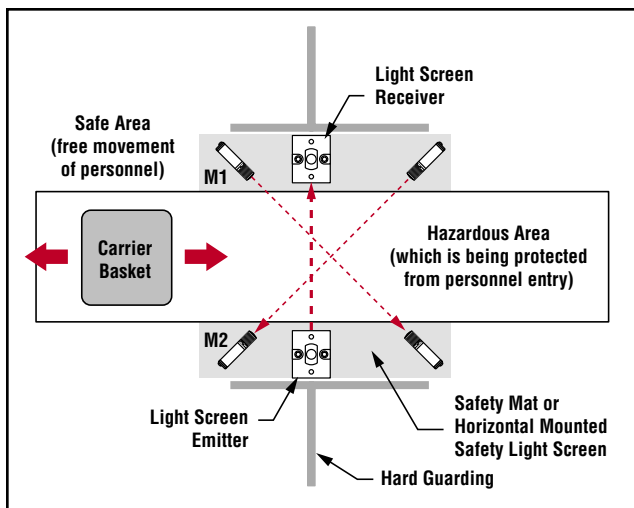

Figure B-1. "X"-Pattern Entry/Exit system using two pairs of opposed-mode photoelectric muting devices

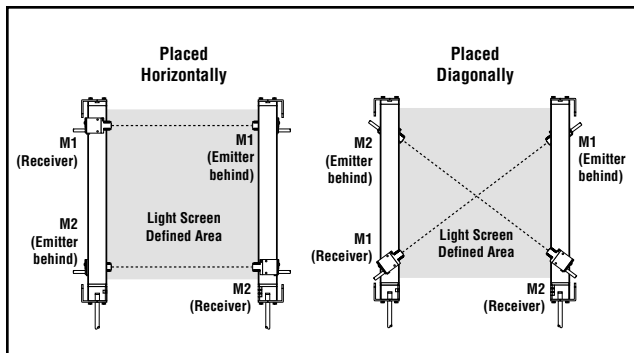

Figure B-2. Photoelectric muting device placement options



WARNING . . .

- It must not be possible for an individual to block both photoelectric beams (dashed diagonal lines in Figure B-1) and initiate a mute condition. Check the installation to verify that unintentional muting is not possible. The "crossing point" of the photoelectric beams must be located in the hazardous area and not be accessible to personnel (by reaching over, under, through, or around).
- It must not be possible for personnel to walk in front of, behind, or next to the muted object (e.g., the carrier basket) without being detected and stopping the hazardous motion. Supplemental safeguarding must be used to prevent personnel from entering the hazardous area during a mute condition.

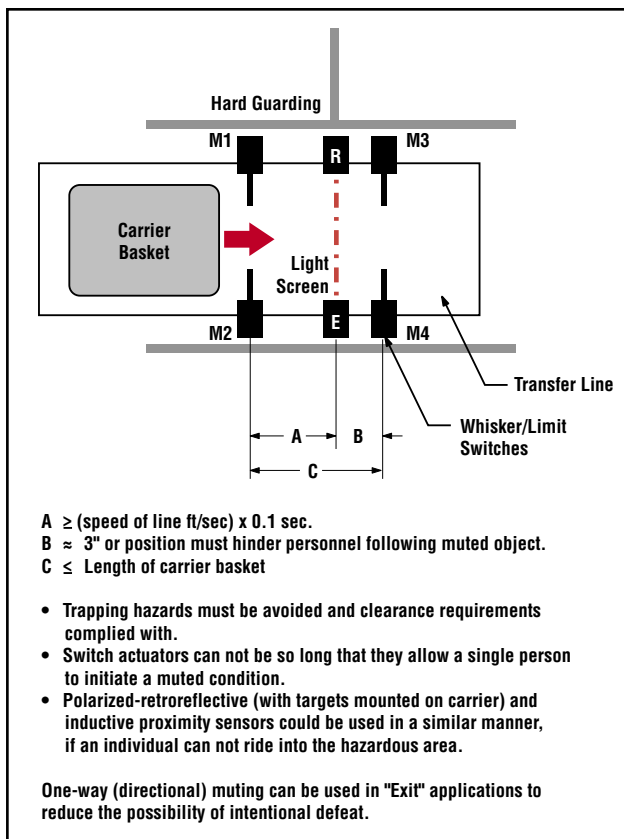

Figure B-3. Entry/exit system using 4 whisker/limit switches as muting devices

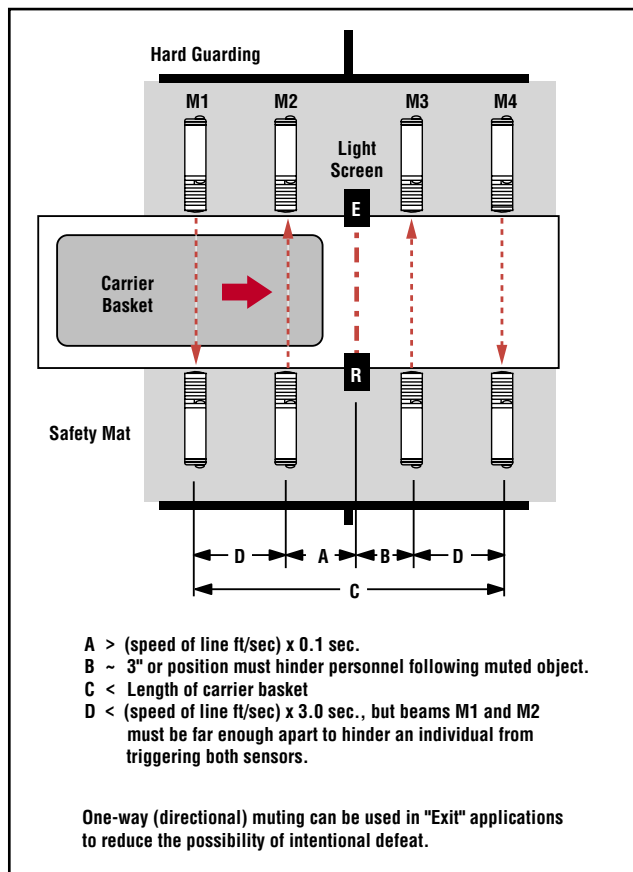

Figure B-4. An entry/exit system using four photoelectric sensors as M1, M2, M3, and M4

WARNING . . . User is Responsible for Safe Application of this Product

The muting application examples described in Appendix B depict generalized guarding situations. Every guarding application has a unique set of application requirements. **Extreme care is urged to ensure that all legal requirements are met and that all installation instructions are followed.**

In addition, any questions regarding safeguarding should be directed to the factory applications department at the telephone number or addresses listed on the back cover.

Home or Station Applications

The muting devices must be placed to ensure that the safety light screen is muted *only* when the hazard does not exist or is in another area so that personnel are not exposed. The muting devices must be placed so that if a hazard arises, or the hazard enters the safeguarded area, the mute will immediately end and the safeguard will be active once again.

In "home position" muting applications, the light screen is active only while motion is taking place or a hazard is present, such as the closing of an automated door. In this example, the door is interlocked and the machine can not start until the opening is completely closed. The hazard being guarded by the light screen is the pinch point caused by the door closing.

M3 and M4 could be two SI-QS75MC safety switches, each with a single safety contact used for the muting input. M1 and M2 could be SI-QS90MF safety switches, each with two safety contacts (one for muting and one for interlocking) and one monitoring contact for a logic input.

If the light screen is also guarding hazards within the enclosure when the door is open or preventing cycle initiation, then switches M3 and M4 would not be used. The door could also be "locked" by using locking style safety switches, such as the SI-QM100 or SI-LS42 as M1 and M2.

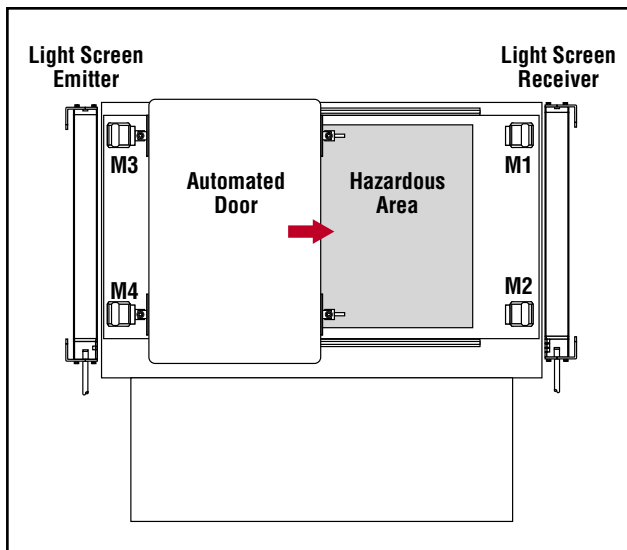

Figure B-5. A "home position" (door) muting application, using 4 safety switches as muting devices

SOURCES

OSHA Documents

Superintendent of Documents
Government Printing Office
P.O. Box 371954
Pittsburgh, PA 15250-7954
Tel: (202) 512-1800
<http://www.osha.gov>

ANSI Accredited Standards

American National Standards Institute (ANSI)
11 West 42nd Street
New York, NY 10036
Tel: (212) 642-4900
<http://www.ansi.org>

B11 Documents

Safety Director
The Association for Manufacturing Technology (AMT)
7901 Westpark Drive
McLean, VA 22102
Tel: (703) 893-2900
<http://www.mfgtech.org>

RIA Documents

Robotics Industries Association (RIA)
900 Victors Way, P.O. Box 3724
Ann Arbor, MI 48106
Tel: (734) 994-6088
<http://www.robotics.org>

NFPA Documents

National Fire Protection Association
1 Batterymarch Park
P.O. Box 9101
Quincy, MA 02269-9101
Tel: (800) 344-3555
<http://www.nfpa.org>

Alternate sources for these, plus ISO, IEC, EN, DIN, & BS Standards:

Global Engineering Documents
15 Inverness Way East
Englewood, CO 80112-5704
Tel: (800) 854-7179
<http://www.global.ihs.com>

National Standards Systems Network (NSSN)
25 West 43rd Street
New York, NY 10036
Tel: (212) 642-4980
<http://www.nssn.com>

Document Center, Inc.
111 Industrial Road, Suite 9
Belmont, CA 94002
Tel: (650) 591-7600
<http://www.document-center.com>

U.S. Application Standards

ANSI B11.1 Mechanical Power Presses

ANSI B11.2 Hydraulic Power Presses

ANSI B11.3 Power Press Brakes

ANSI B11.4 Shears

ANSI B11.5 Iron Workers

ANSI B11.6 Lathes

ANSI B11.7 Cold Headers and Cold Formers

ANSI B11.8 Drilling, Milling, and Boring

ANSI B11.9 Grinding Machines

ANSI B11.10 Metal Sawing Machines

ANSI B11.11 Gear Cutting Machines

ANSI B11.12 Roll Forming and Roll Bending Machines

ANSI B11.13 Single- and Multiple-Spindle Automatic Bar and Chucking Machines

ANSI B11.14 Coil Slitting Machines

ANSI B11.15 Pipe, Tube, and Shape Bending Machines

ANSI B11.16 Metal Powder Compacting Presses

ANSI B11.17 Horizontal Extrusion Presses

ANSI B11.18 Machinery and Machine Systems for the Processing of Coiled Strip, Sheet, and Plate

ANSI B11.19 Performance Criteria for Safeguarding

ANSI B11.20 Manufacturing Systems

ANSI B11.21 Machine Tools Using Lasers

ANSI B11.22 Numerically Controlled Turning Machines

ANSI B11.23 Machining Centers

ANSI B11.24 Transfer Machines

ANSI B11.TR3 Risk Assessment

ANSI/RIA R15.06 Safety Requirements for Industrial Robots and Robot Systems

NFPA 79 Electrical Standard for Industrial Machinery

OSHA Regulations

OSHA Documents listed are part of:
Code of Federal Regulations Title 29, Parts 1900 to 1910

OSHA 29 CFR 1910.212 General Requirements for (Guarding of) All Machines

OSHA 29 CFR 1910.147 The Control of Hazardous Energy (lockout/tagout)

OSHA 29 CFR 1910.217 (Guarding of) Mechanical Power Presses

International/European Standards

ISO/TR 12100-1 & -2 (EN 292-1 & -2) Safety of Machinery – Basic Concepts, General Principles for Design

ISO 13852 (EN 294) Safety Distances . . . Upper Limbs

ISO 13850 (EN 418) Emergency Stop Devices, Functional Aspects – Principles for Design

ISO/DIS 13851 (EN 574) Two-Hand Control Devices – Functional Aspects – Principles for Design

ISO 13853 (prEN 811) Safety Distances . . . Lower Limbs

ISO 13849 (EN 954-1) Safety-Related Parts of Control Systems

ISO/DIS 13855 (EN 999) The Positioning of Protective Equipment in Respect to Approach Speeds of Parts of the Human Body

ISO 14121 (EN 1050) Principles of Risk Assessment

ISO 14119 (EN 1088) Interlocking Devices Associated with Guards – Principles for Design and Selection

IEC/EN 60204-1 Electrical Equipment of Machines Part 1: General Requirements

IEC/EN 61496 Electro-sensitive Protection Equipment

IEC 60529 Degrees of Protection Provided by Enclosures

IEC/EN 60947-5-1 Low Voltage Switchgear – Electromechanical Control Circuit Devices

IEC/EN 60947-1 Low Voltage Switchgear – General Rules



WARRANTY: Banner Engineering Corp. warrants its products to be free from defects for one year. Banner Engineering Corp. will repair or replace, free of charge, any product of its manufacture found to be defective at the time it is returned to the factory during the warranty period. This warranty does not cover damage or liability for the improper application of Banner products. This warranty is in lieu of any other warranty either expressed or implied.

P/N 123894