



ADLINK
TECHNOLOGY INC.

MXE-5500 Series

MXE-5501/MXE-5502/MXE-5503

Fanless Embedded Computer

User's Manual



Manual Rev.: 2.00

Revision Date: Aug. 3, 2016

Part No: 50-1Z216-2000

Advance Technologies; Automate the World.

SICK DIMA500

Revision History

Revision	Release Date	Description of Change(s)
2.00	Aug. 3, 2016	Initial Release

Preface

Copyright 2016 ADLINK Technology, Inc.

This document contains proprietary information protected by copyright. All rights are reserved. No part of this manual may be reproduced by any mechanical, electronic, or other means in any form without prior written permission of the manufacturer.

Disclaimer

The information in this document is subject to change without prior notice in order to improve reliability, design, and function and does not represent a commitment on the part of the manufacturer.

In no event will the manufacturer be liable for direct, indirect, special, incidental, or consequential damages arising out of the use or inability to use the product or documentation, even if advised of the possibility of such damages.

Environmental Responsibility

ADLINK is committed to fulfill its social responsibility to global environmental preservation through compliance with the European Union's Restriction of Hazardous Substances (RoHS) directive and Waste Electrical and Electronic Equipment (WEEE) directive. Environmental protection is a top priority for ADLINK. We have enforced measures to ensure that our products, manufacturing processes, components, and raw materials have as little impact on the environment as possible. When products are at their end of life, our customers are encouraged to dispose of them in accordance with the product disposal and/or recovery programs prescribed by their nation or company.

Trademarks

Product names mentioned herein are used for identification purposes only and may be trademarks and/or registered trademarks of their respective companies.

Conventions

Take note of the following conventions used throughout this manual to make sure that users perform certain tasks and instructions properly.



NOTE:

Additional information, aids, and tips that help users perform tasks.



CAUTION:

Information to prevent **minor** physical injury, component damage, data loss, and/or program corruption when trying to complete a task.



WARNING:

Information to prevent **serious** physical injury, component damage, data loss, and/or program corruption when trying to complete a specific task.

Table of Contents

Revision History	ii
Preface	iii
List of Tables	ix
List of Figures	xi
1 Introduction	1
1.1 Features.....	2
1.2 Specifications.....	3
1.3 Unpacking Checklist	5
1.4 Mechanical Drawings.....	6
1.5 Front Panel I/O Connectors	8
1.5.1 Power Button	8
1.5.2 Power Button Header	9
1.5.3 Reset Button.....	9
1.5.4 LED Indicators	9
1.5.5 DisplayPort Connectors	10
1.5.6 Audio Connector.....	11
1.5.7 DVI-I Connector.....	12
1.5.8 Gigabit Ethernet Ports	13
1.5.9 COM Port Connectors	14
1.5.10 USB 3.0 Ports.....	15
1.5.11 USB 2.0 Ports.....	15
1.5.12 DC Power Connector.....	15
1.5.13 DB-26P Digital I/O Connector.....	16
1.6 Rear Panel.....	19
1.6.1 CFast Slot.....	19
1.6.2 HDD Fast Plug Trays.....	19
1.7 Internal I/O Connectors.....	20

1.7.1	Clearing CMOS Jumper.....	21
1.7.2	DC 5V and 3.3V Connectors for GPS Module.....	21
1.7.3	USIM Port	22
1.7.4	Extendable Power/Reset/LED	23
2	Getting Started	25
2.1	Unpacking Checklist	25
2.2	Installing a Hard Disk Drive.....	25
2.3	Installing a Mini-PCle Device	28
2.4	Installing a CFast Card	31
2.5	Connecting DC power.....	32
2.6	Wall-mounting the MXE-5500.....	33
2.7	Cooling Considerations.....	34
2.8	Driver Installation	35
A	Appendix: Watchdog Timer (WDT) & DI/O Function Libraries.....	37
A.1	WDT with API/Windows	37
A.2	DI/O with API/Windows.....	40
B	Appendix: BIOS Setup.....	43
B.1	Main	43
B.2	Advanced.....	45
B.2.1	CPU Configuration.....	46
B.2.2	Memory Configuration	48
B.2.3	System Agent (SA) Configuration.....	49
B.2.4	Graphics Configuration	50
B.2.5	Onboard Devices Configuration.....	51
B.2.6	Advanced Power Management.....	54
B.2.7	USB Configuration	55
B.2.8	SATA Configuration	57
B.2.9	CSM Configuration	58
B.2.10	AMT Configuration.....	59

B.2.11	TPM 1.2 Configuration.....	60
B.2.12	Network Stack Configuration	61
B.2.13	System Management.....	62
B.3	Security.....	69
B.4	Boot	70
B.4.1	Hard Drive BBS Priorities	72
B.5	Save & Exit	73
C	Appendix: SEMA Utility	75
C.1	System Overview Tab.....	75
C.1.1	Board Information	75
C.2	System Health Tab	76
C.2.1	Temperatures & Fan Speed	76
C.2.2	Power Consumption	77
C.2.3	Runtime Statistics.....	77
C.2.4	Flags.....	77
C.3	User Flash Memory Tab	78
C.3.1	Memory.....	79
C.3.2	Write Memory	79
C.4	Hardware Control Tab	81
C.4.1	Watchdog	81
C.4.2	Backlight Control	82
C.4.3	Smart Fan.....	82
C.5	Hardware Monitor Tab	84
C.6	I2C Bus Tab.....	85
C.7	GPIO Tab.....	87
C.7.1	GPIO information.....	88
C.7.2	IO Read	89
C.7.3	IO Write	89
C.7.4	IO XorAndXor	89
C.8	Status Bar	89

Important Safety Instructions..... 91

Getting Service 95

List of Tables

Table 1-1:	LED Indicator Legend.....	9
Table 1-2:	DisplayPort Pin Assignment	10
Table 1-3:	Multi-Display Configuration.....	11
Table 1-4:	DVI-I Connector Pin Assignment.....	12
Table 1-5:	Gigabit Ethernet Port LED Function	14
Table 1-6:	COM Port Pin Assignments.....	15
Table 1-7:	DC Power Supply Connector Signals.....	15
Table 1-8:	DB-26P Connector Pin Assignment	16
Table 1-9:	Digital I/O Specifications.....	17
Table 1-10:	Rear Panel I/O Connector Legend	19
Table 1-11:	Internal I/O Legend.....	21
Table 1-12:	DC 5V and 3.3V Connectors Pin Assignments	22
Table 1-13:	Extended Reset/LED Pin Assignments	23

This page intentionally left blank.

List of Figures

Figure 1-1: Functional Block Diagram.....	5
Figure 1-2: Top View.....	6
Figure 1-3: Front View.....	7
Figure 1-4: Rear View	7
Figure 1-5: (Left) Side View	7
Figure 1-6: Front Panel I/O	8
Figure 1-7: Isolated/Differential Digital Input Circuit.....	17
Figure 1-8: Isolated Digital Output Circuits	18
Figure 1-9: Isolated Digital Output Sample Application Circuit	18
Figure 1-10: Rear Panel I/O.....	19
Figure 1-11: Internal I/O.....	20
Figure 1-12: Clear CMOS Jumper Pin Settings	21
Figure 1-13: DC 5V and 3.3V Connectors Configuration	21
Figure 1-14: Extendable Reset/LED Configuration	23

This page intentionally left blank.

1 Introduction



ADLINK's new Matrix MXE-5500 series of rugged quad-core fanless computers features the latest generation of Intel® Core™ i7/i5/i3 processors, delivering outstanding performance with robust construction. The MXE-5500 series accommodates rich I/O capabilities in a compact system size, with two DisplayPort, one DVI-I (supporting both DVI and VGA signals), four GbE by Intel network interface controllers, four each USB 2.0 and USB 3.0, eight isolated DI/O, and six COM ports, four of which are BIOS-configurable among RS-232/422 and 485. In addition, with dual 2.5" SATA drive bays and one CFast port, a wider variety of storage options than ever is available.

Dual mini PCIe slots and USIM sockets empower the MXE-5500 as a communications hub for a variety of wireless connections, such as BT/WiFi and 3G. Leveraging proprietary mechanical engineering, the MXE-5500 series continues to offer all the popular features of the popular Matrix E series, including cable-free construction, wide operating temperature ranges, and 5 Grms vibration resistance, having undergone, like all ADLINK Matrix devices, rigorous testing for operational verification. Combining superior processor performance, wireless capability, and rich, scalable I/O in a compact and robust package, the ADLINK MXE-5500 is an ideal choice for a wide range of applications supporting intelligent transportation, in-vehicle multimedia & surveillance, and factory automation applications.

1.1 Features

- ▶ 6th Gen Intel® Core™ i7/i5/i3 Processors and QM170 chip-set
- ▶ Single-side I/O with two SATA drive bays for easy drive swapping
- ▶ 1x DVI-I, 2x DisplayPort, 4x USB 2.0, 4x USB 3.0, and 4x GbE ports,
- ▶ 6x COM ports, 8x isolated DI/O, 2x SATA-III (6.0 Gb/s) port, 2x mPCIe slots w/ USIM, and 1x M.2 2280
- ▶ Rugged construction delivering fanless -20°C to 60°C operability (w/industrial SSD)
- ▶ Built-in ADLINK SEMA® 3.0 management solution



NOTE:

Industrial SSD option guarantees cold system boot at -20°C and operation with 100% loading at 60°C when installed.

1.2 Specifications

	MXE-5501	MXE-5502	MXE-5503
System Core			
Processor	Intel® Core™ i7-6820EQ	Intel® Core™ i5-6440EQ	Intel® Core™ i3-6100E
Memory	DDR4 2133 4GB (up to 32 GB)		
Graphics			
Display Port	2x DisplayPort		
DVI/VGA	1x DVI-I		
I/O			
Ethernet	4x Intel GbE ports		
Serial Ports	6x COM (2x RS-232 + 4x RS-232/422/485)		
USB	4x USB 2.0 + 4x USB 3.0		
DIO	Isolated 8 DI + 8 DO		
Audio	Mic-in / Line-out		
Expansion			
Mini PCIe	2x PCIe mini card slot		
USIM	2x USIM Slot		
Manageability			
WDT	Watch Dog Timer support		
SEMA	SEMA support with BMC		
Power Supply			
DC Input	9-32Vdc		
AC Input	Optional 160W AC-DC adapter		
Storage			
SATA Storage	2x 2.5" SATA drive bays		
Compact Flash	1x CFast socket		
Internal Storage Slot	1x m.2 2280 (SATA)		
Physical			
Dimensions	230 (W) x 204 (D) x 90 (H) mm (9.06 x 8.07 x 3.5 in)		

	MXE-5501	MXE-5502	MXE-5503
Weight	4 kg (8.81 lb)		
Mounting	Wall-mount kit		
Environmental			
Operating Temperature*	Standard: 0°C to 50°C Extended Temperature Options: -20°C to 60°C for MXE-5501; -20°C to 70°C for MXE-5502/5503 (w/Ind. SSD or CFast)		
Storage Temperature	-40°C to 85°C (-40°F to 185°F)		
Humidity	Approx. 95% @40°C (non-condensing)		
Vibration	Operating 5Grms, 5-500 Hz, 3 axes w/ SSD Operating 0.5Grms, 5-500 Hz, 3 axes w/ HDD		
ESD	Contact +/- 4KV, Air +/- 8KV		
Shock	Operating 100G, half sine 11 ms duration w/ SDD; Operating 20G, half sine 11ms w/ HDD		
EMC	CE & FCC Class A		
Safety	CE/LVD, UL [by CB]		

Power Consumption		
Power off	3.9W	In shutdown mode with DC input and only USB keyboard/mouse
System Idle	20.3W	Under Windows Desktop with no application programs executed
Processor full load	52.8W	Under Windows with 100% CPU utilization and 2D/3D graphics load
System full load	92.8W	Under Windows with 100% CPU utilization and simultaneous access to all I/O devices.
Recommended power supply	160W	With consideration of voltage de-rating under high environmental temperature.

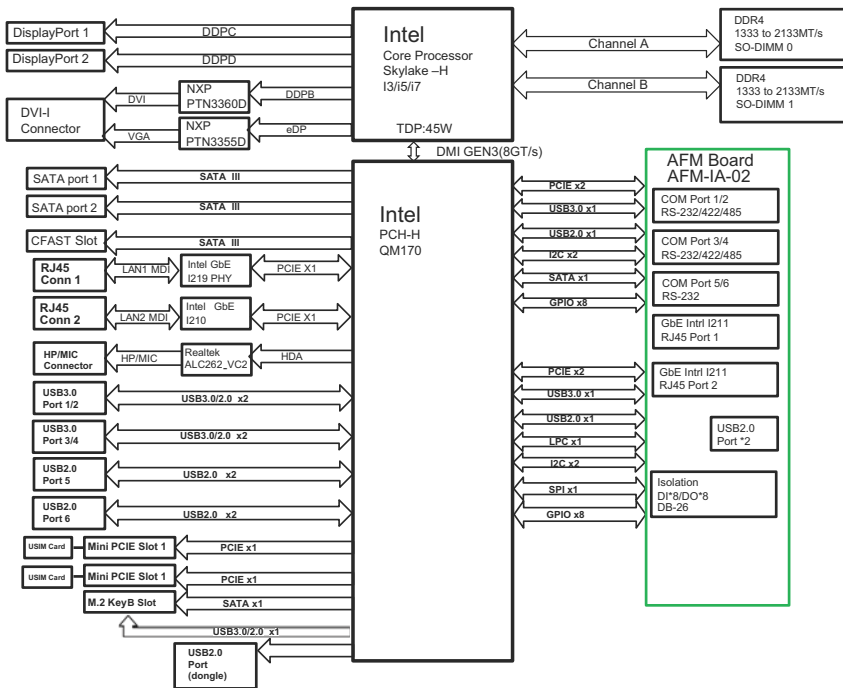

Figure 1-1: Functional Block Diagram

1.3 Unpacking Checklist

Before unpacking, check the shipping carton for any damage. If the shipping carton and/or contents are damaged, inform your dealer immediately. Retain the shipping carton and packing materials for inspection. Obtain authorization from your dealer before returning any product to ADLINK. Ensure that the following items are included in the package.

- ▶ MXE-5500 controller
- ▶ Wall-mount bracket (in Accessory Box)
- ▶ Screw pack for wall-mounting and HDD fixing (in Accessory Box)
- ▶ Quick Start Guide

1.4 Mechanical Drawings



NOTE:

All dimensions shown are in millimeters (mm) unless otherwise stated.

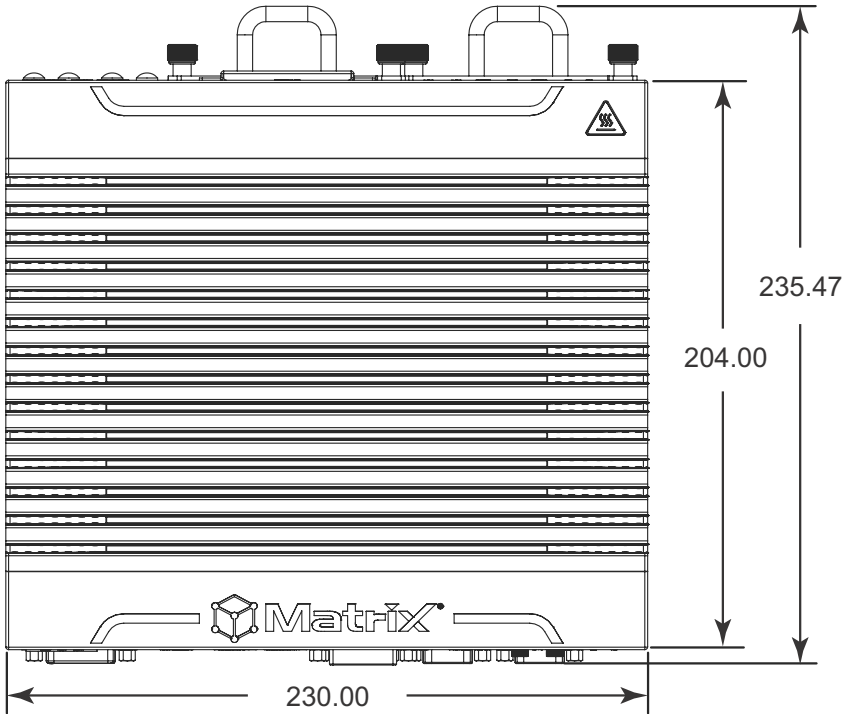

Figure 1-2: Top View

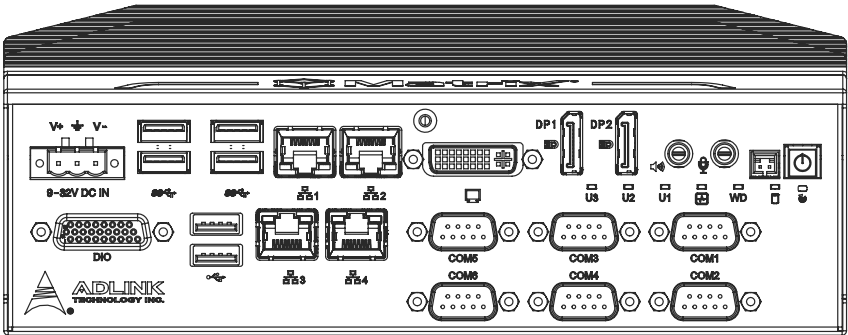

Figure 1-3: Front View

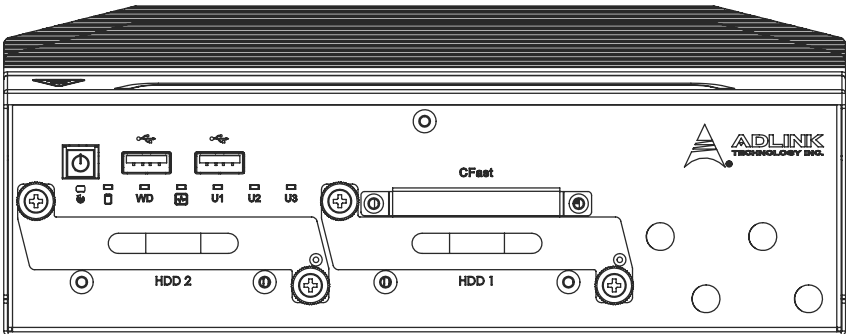

Figure 1-4: Rear View

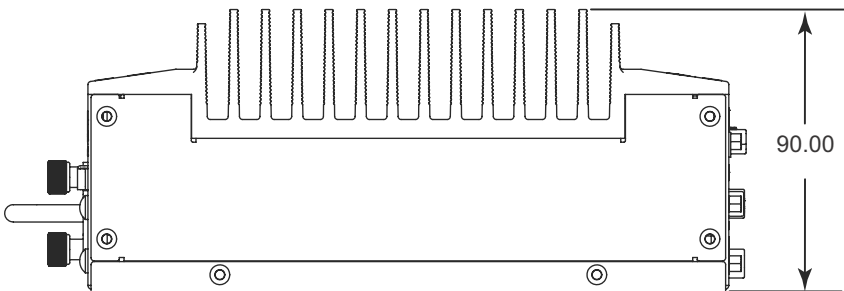

Figure 1-5: (Left) Side View

1.5 Front Panel I/O Connectors



Figure 1-6: Front Panel I/O

I/O connectors and controls on the MXE-5500 front panel, as labeled, are as follows

- ▶ Power
- ▶ Reset
- ▶ Power header
- ▶ LED indicators (x 6)
- ▶ Line-Out/Mic
- ▶ UART (x 6)
- ▶ DisplayPort (x 2)
- ▶ DVI-I
- ▶ Intel Gigabit Ethernet (x 4)
- ▶ USB 3.0 (x 4)
- ▶ USB 2.0 (x 2)
- ▶ DC power supply
- ▶ DB-26P digital I/O

1.5.1 Power Button

Non-latched push button with a blue LED indicator. System is turned on when button is pressed, and the power LED lit. If the system hangs, depressing the button for 5 seconds powers down the system.

1.5.2 Power Button Header

Allows connection of external power control cable.

1.5.3 Reset Button

Executes hard reset for the MXE-5500.

1.5.4 LED Indicators

In addition to the LED of the power button, LEDs on the front panel indicate the following operations.

LED	Color	Description	
Diagnostic (DG)	Green	Lit	No physical storage is connected
		Blinking	No memory is installed on either SO-DIMM socket.
Watchdog (WD)	Yellow	Flashes when watchdog timer starts	
Hard disk drive (HD)	Red	Blinking indicates SATA HDD is active	
User-defined (U1, U2, U3)	White	As set in GPIO	

Table 1-1: LED Indicator Legend

1.5.5 DisplayPort Connectors

Provide connection to VGA, DVI, HDMI monitor via DisplayPort 1.2 to VGA adapter cable, to DVI adapter cable, and to HDMI adapter cable.

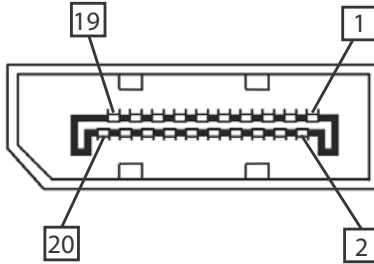

Pin	Signal	Pin	Signal
1	CN_DDPx0+	11	GND
2	GND	12	CN_DDPx3-
3	CN_DDPx0-	13	CN_DDPx_AUX_SEL
4	CN_DDPx1+	14	CN_DDPx_CONFIG2
5	GND	15	CN_DDPx_AUX+
6	CN_DDPx1-	16	GND
7	CN_DDPx2+	17	CN_DDPx_AUX-
8	GND	18	CN_DDPx_HPDP
9	CN_DDPx2-	19	GND
10	CN_DDPx3+	20	+V3.3_DDPx_PWR

Table 1-2: DisplayPort Pin Assignment

Multi-Display Option

With the computing and graphic performance enhancements of Intel HD Graphics Engine, the MXE-5500 supports three independent displays, configured as follows.

Display 1	DP	DP	DVI-D
	Max. Res 4096x2304 @60 Hz	Max. Res 4096x2304 @60 Hz	Max. Res 2048x1152 @60Hz
Display 2	DP	DP	VGA
	Max. Res 4096x2304 @60 Hz	Max. Res 4096x2304 @60 Hz	Max. Res 2048x1152 @60Hz
Display 3	DVI-D	VGA	DP
	Max. Res 2048x1152 @60Hz	Max. Res 2048x1152 @60Hz	Max. Res 4096x2304 @60 Hz

Table 1-3: Multi-Display Configuration

Optional Accessories for DP to VGA/DVI Adapters

Accessory	P/N
DisplayPort to DVI Active cable	30-01157-0000
DisplayPort to VGA cable	30-01121-0000
DisplayPort to DVI cable	30-01120-0000
DisplayPort to HDMI cable	30-01119-0000

1.5.6 Audio Connector

Provides connection of Mic and Headphone channels, as marked.

1.5.7 DVI-I Connector

For connection to external monitor, which can separate into individual VGA and DVI-D (single link) interfaces.

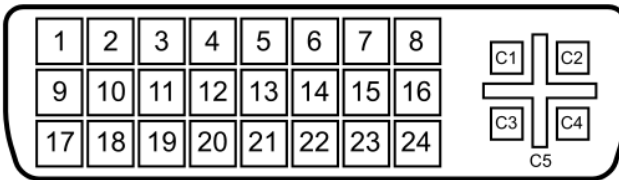

Pin	Signal	Pin	Signal	Pin	Signal
1	DVI_Data2-	11	GND	21	N/C
2	DVI_Data2+	12	N/C	22	GND
3	GND	13	N/C	23	DVI clock+
4	N/C	14	+5V	24	DVI clock-
5	N/C	15	GND		
6	DVI DDC clock	16	Hot plug detect	C1	Analog Red
7	DVI DDC data	17	DVI_Data0-	C2	Analog Green
8	Analog vertical sync	18	DVI_Data0+	C3	Analog Blue
9	DVI_Data1-	19	GND	C4	Analog / horizontal sync
10	DVI_Data1+	20	N/C	C5	Analog GND

Table 1-4: DVI-I Connector Pin Assignment

1.5.8 Gigabit Ethernet Ports

The four Gigabit Ethernet ports are based on Intel WGI219/WGI210/WGI211 GbE controllers.

Port1	I219
Port2	I210
Port3	I211
Port4	I211

The ports feature:

- ▶ IEEE 802.3az Energy Efficient Ethernet
- ▶ IEEE 1588/802.1AS precision time synchronization
- ▶ IEEE 802.3Qav traffic shaper
- ▶ Interrupt moderation, VLAN support, IP checksum offload
- ▶ PCIe OBFF (optimized buffer flush/fill) improves system power management
- ▶ Four transmit and four receive queues
- ▶ RSS and MSI-X to lower CPU utilization in multicore systems
- ▶ ECC (error correcting memory) in packet buffers
- ▶ Wake-On-LAN support
- ▶ NC-SI increases bandwidth passthrough
- ▶ Preboot eXecution Environment (PXE) flash interface support
- ▶ Jumbo frame support

LED	Color	Status	Description
Active/Link	Yellow	Unlit	Ethernet port is disconnected.
		Lit	Ethernet port is connected with no activity.
		Flashing	Ethernet port is connected and active.

LED	Color	Status	Description
Speed	Green/Yellow	Unlit	10Mbps
		Green	100 Mbps
		Yellow	1000 Mbps

Table 1-5: Gigabit Ethernet Port LED Function

1.5.9 COM Port Connectors

Of 6 COM ports through D-sub 9-pin connectors, COM1 to COM4 support RS-232/422/485 modes via BIOS setting, and COM5 and COM6 support only RS-232.

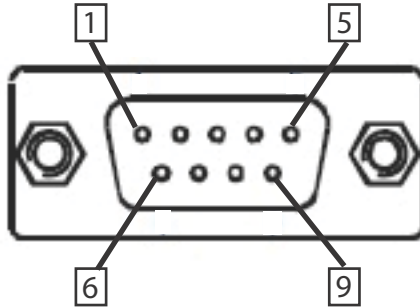

Pin	Signal		
	RS232	RS422	RS485
1	DCD#	TXD422-	485DATA-
2	RXD	TXD422+	485DATA+
3	TXD	RXD422+	N/S
4	DTR#	RXD422-	N/S
5	GND	N/S	N/S
6	DSR#	N/S	N/S
7	RTS#	N/S	N/S
8	CTS#	N/S	N/S

Pin	Signal		
9	RI#	N/S	N/S

Table 1-6: COM Port Pin Assignments

1.5.10 USB 3.0 Ports

USB 3.0 supporting Type A connection is compatible with Super-Speed, Hi-Speed, full-speed and low-speed USB devices, with support for multiple boot devices, including USB flash, USB external HDD, and USB CD-ROM drivers and boot priority and boot device configured in BIOS.



NOTE:

- ▶ When using USB CD-ROM via USB 3.0 port to re-install or repair the OS, cold boot should be utilized
- ▶ USB 3.0 port supports additional current up to 1600mA, positioned as shown in XXX

1.5.11 USB 2.0 Ports

4 Type A USB 2.0 ports support multiple boot devices, including USB flash, USB external HDD, and USB CD-ROM drivers, with Boot Priority and Device configured via BIOS.

1.5.12 DC Power Connector

The DC power supply connector consists of V+, chassis ground, and V- pins (from right to left), with V+ and V- pins accepting DC power input and chassis ground pin enhancing EMC compatibility. The DC power input accepts input from 9V DC to 32 VDC.

Pin	Signal
1	V+(DC_IN)
2	GND(CHGND)
3	V- (DGND)

Table 1-7: DC Power Supply Connector Signals

1.5.13 DB-26P Digital I/O Connector

8CH isolated digital input and 8CH isolated digital output are provided through the DB-26P connector. General purpose input/output application with isolation requirement is recommended.

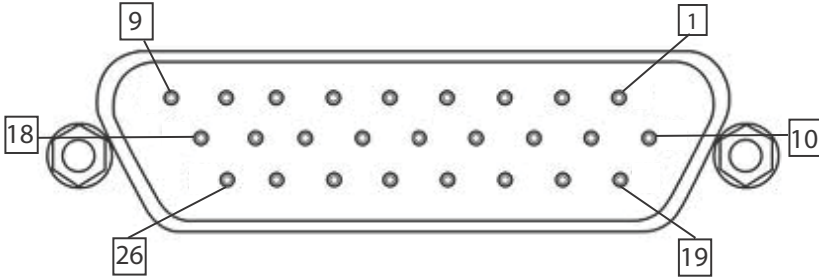

Pin	Signal Name	Pin	Signal Name
1	IDI_0L	14	IDI_4H
2	IDI_1L	15	IDI_5H
3	IDI_2L	16	IDI_6H
4	IDI_3L	17	IDI_7H
5	IDI_45L	18	EOGND
6	EOGND	19	IDO_0
7	IDI_67L	20	IDO_1
8	+VDD	21	IDO_2
9	+5DIO_CN_ISO	22	IDO_3
10	IDI_0H	23	IDO_4
11	IDI_1H	24	IDO_5
12	IDI_2H	25	IDO_6
13	IDI_3H	26	IDO_7

Table 1-8: DB-26P Connector Pin Assignment

8CH Isolated DI	8CH Isolated DO
Logic high: 5 to 24V	Output: Open Drain N- Channel Power MOSFET driver
Logic low: 0 to 1.5V	250mA for all channels @ 60°C, 100% duty
Input resistance: 2.4kΩ @ 0.5W	Supply voltage: 5 to 35 VDC
Interrupt source: DI	Isolation voltage: 1.5kVDC channel 0 to 7
Isolation voltage: 1.5kV DC channel 0 to 7	200mA for +V5DIO_ISO (max.)

Table 1-9: Digital I/O Specifications

Optional Accessories for DB-26P Digital I/O Connector

Accessory	P/N
DIN-37D-01 Terminal board with one 37-pin D-sub connector and DIN-rail mounting	91-14025-1020
DIO-to-DIN37 cable (26-pin to 37-pin)	30-01143-0000

Isolated Digital Input Circuits

The input can accept voltages up to 24V, with 2.4kΩ input resistors. Connections between outside signals are as follows.

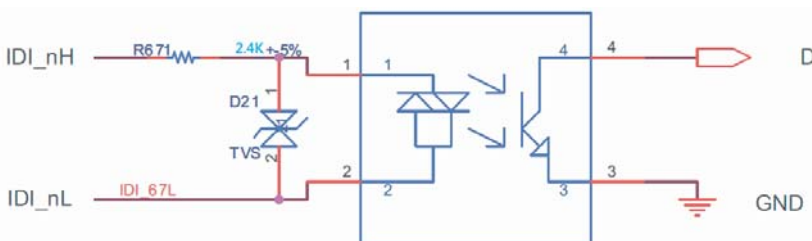

Figure 1-7: Isolated/Differential Digital Input Circuit

Isolated Digital Output Circuits

Each isolation digital output channel adopts a MOSFET transistor, capable of driving peak current up to 250mA (sustained current up to 100 mA) with voltage ranges from 5V to 35V. The VDD pin is connected in series with a flywheel diode to protect the driver during inductance loading, such as relay, motor, or solenoid. The VDD must connect to external power to form a flywheel current loop.

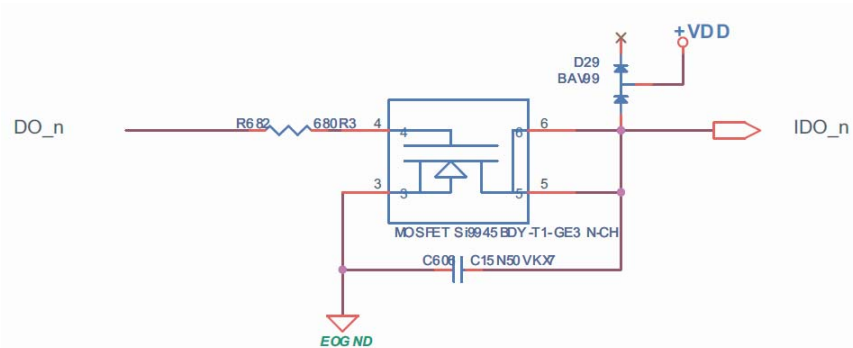

Figure 1-8: Isolated Digital Output Circuits

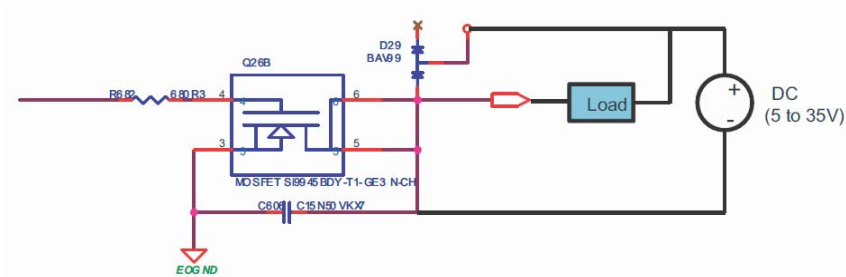

Figure 1-9: Isolated Digital Output Sample Application Circuit

1.6 Rear Panel

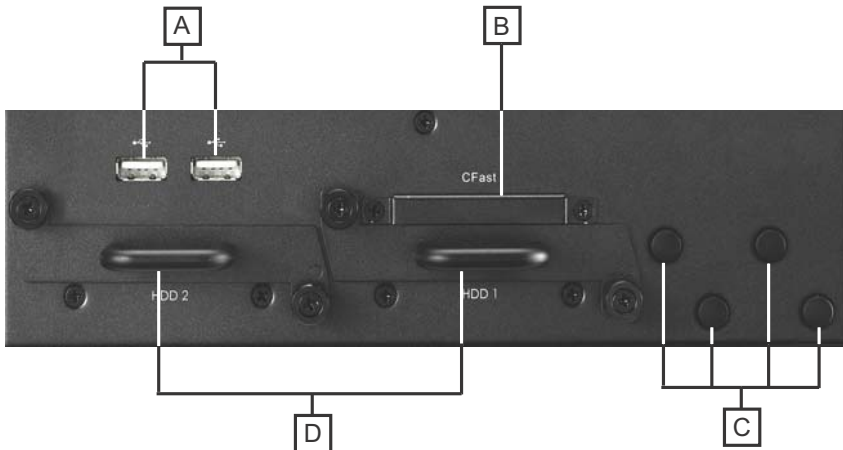

Figure 1-10: Rear Panel I/O

A	USB 2.0 (x 2)
B	CFast
C	Antenna connection plugs (x 4)
D	HDD/SDD Fast Plug (x 2)

Table 1-10: Rear Panel I/O Connector Legend

1.6.1 CFast Slot

The Type II push-push CFast host connector on the back panel connects to the host controller by SATA interface, supporting data transfer up to 6.0Gb/s (600MB/s)/3.0Gb/s (300MB/s)/1.5Gb/s (150MB/s).

1.6.2 HDD Fast Plug Trays

The Fast Plug host connector connecting to the host controller by SATA interface supports data transfer up to 6.0Gb/s (600MB/s)/ 3.0Gb/s (300MB/s)/1.5Gb/s (150MB/s).

1.7 Internal I/O Connectors



NOTE:

Mainboard is shown in default configuration, with stacked AFM board



Figure 1-11: Internal I/O

A	Power/Reset/LED
B	GPS module power header (+3.3V)
C	GPS module power header (+5V)
D	Mini-PCle slot 1 with USIM socket 1

E	Mini-PCIe slot 2 with USIM socket 2
F	M.2 slot
G	Clear CMOS jumper

Table 1-11: Internal I/O Legend

1.7.1 Clearing CMOS Jumper

Under conditions in which the MXE-5500 fails to boot, clearing the BIOS content stored in CMOS and restoring the default settings may be effective. To clear CMOS, short Pin #2 and Pin #3 of JP1/JP2 and remove the jumper, after which the CMOS will be restored to factory default settings.

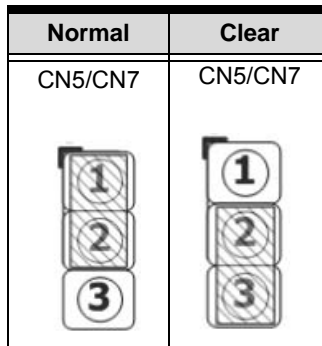

Figure 1-12: Clear CMOS Jumper Pin Settings

1.7.2 DC 5V and 3.3V Connectors for GPS Module

The two power connectors, for GPS module use, carry a maximum current rating of 1A each.

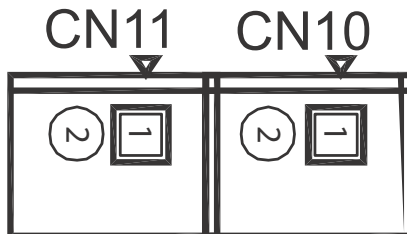

Figure 1-13: DC 5V and 3.3V Connectors Configuration

Pin	Description
CN10	
1	+5V
2	Gnd
CN11	
1	+3.3V
2	Gnd

Table 1-12: DC 5V and 3.3V Connectors Pin Assignments

1.7.3 USIM Port

Use of 3.5G mini-PCle module requires a SIM card for communication with a telecom operator. The MXE-5500 provides two USIM modules connected to the mini-PCle connector, with which SIM cards and 3.5G mini-PCle modules can be installed to facilitate 3.5G communication.

1.7.4 Extendable Power/Reset/LED

The MXE-5500 provides internal LED connectors powering indicators for the Power/Reset button (from CN27), and Power for external controllable devices (CN25), assigned as shown.

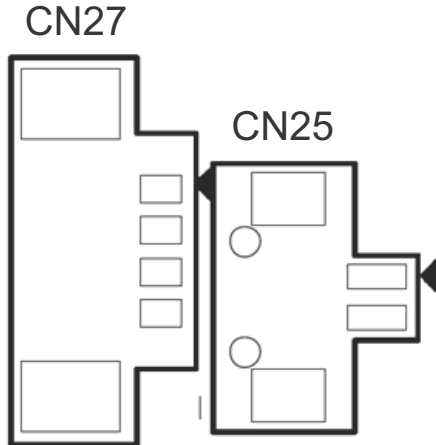

Figure 1-14: Extendable Reset/LED Configuration

Pin	Description
CN27	
1	Power Button signal
2	GND
3	GND
4	Reset Button signal
CN25	
1	+3.3VSB
2	Power LED signal

Table 1-13: Extended Reset/LED Pin Assignments

This page intentionally left blank.

2 Getting Started

This chapter discusses installation of hard disk drive, mini-PCIe module, and CFast card. In addition to connection and use of DIO and COM ports, wall-mount installation is also described.

2.1 Unpacking Checklist

Before unpacking, check the shipping carton for any damage. If the shipping carton and/or contents are damaged, inform your dealer immediately. Retain the shipping carton and packing materials for inspection. Obtain authorization from your dealer before returning any product to ADLINK. Ensure that the following items are included in the package.

- ▶ MXE-5500 controller
- ▶ Wall-mount bracket (in Accessory Box)
- ▶ Screw pack for wall-mounting and HDD fixing (in Accessory Box)
- ▶ Quick Start Guide

2.2 Installing a Hard Disk Drive

1. Remove the right side HDD rack thumbscrews by hand or screwdriver.



2. Withdraw the HDD rack.



3. Seat the HDD or SSD in the HDD rack.



4. Fix the HDD or SSD to the rack using the 4 included M3 screws.



5. Re-insert the rack and gently slide inward until the SATA connector is engaged.



6. Replace the 2 thumbscrews.
7. Repeat all steps for the left side HDD rack.

2.3 Installing a Mini-PCle Device

1. Remove the 6 fastening screws from the top cover.



2. Remove the 4 fastening screws from the top cover edges.

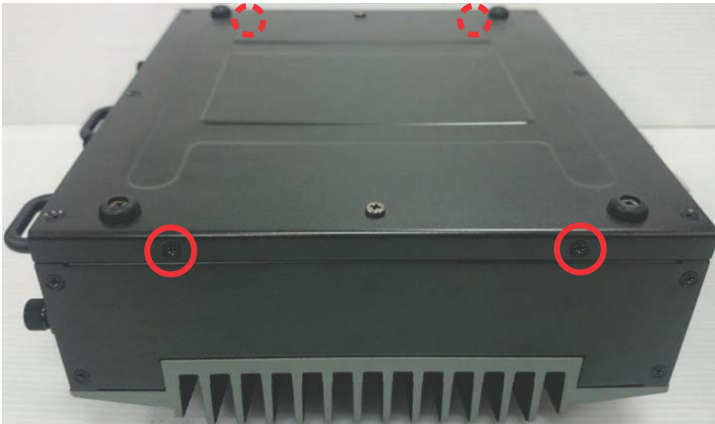

3. Remove the top cover



4. Insert the mini-PCI-E wireless module into the module slot at an angle.



5. Seat the mini-PCI-E wireless module and use the 4 included M2.5-P-head-L5 screws to fix.



6. Replace the top cover and the 10 fastening screws

2.4 Installing a CFast Card

The MXE-5500 series controller provides an external CFast socket to accommodate a CFast card.

1. Remove the 2 fastening screws from the CFast cover.



2. Align the CFast card with the socket guide.



3. Gently insert the CFast card until it is firmly seated.



4. Replace the cover and the 2 fastening screws.

2.5 Connecting DC power



Before introducing DC power to the MXE-5500, ensure the voltage and polarity provided are compatible with the DC input. Improper input voltage and/or polarity can be responsible for system damage.

The DC power input connector of the MXE-5500 utilizes V+, V-, and chassis ground pins, and accepts input voltage as shown previously.

1. Connect DC power.
2. Fix the DC connector using the 2 screws.

2.6 Wall-mounting the MXE-5500



All dimensions shown are in millimeters (mm) unless otherwise stated.

NOTE:



CAUTION:

To sustain structural integrity, the device should not be wall-mounted with the rear panel on the bottom.

1. Remove the 4 plastic pads and right and left side screws from the underside.



2. Use the 6 provided M4 screws to fix the 2 wall-mount brackets to the chassis according to the spacing of the screw holes and brackets, as shown.

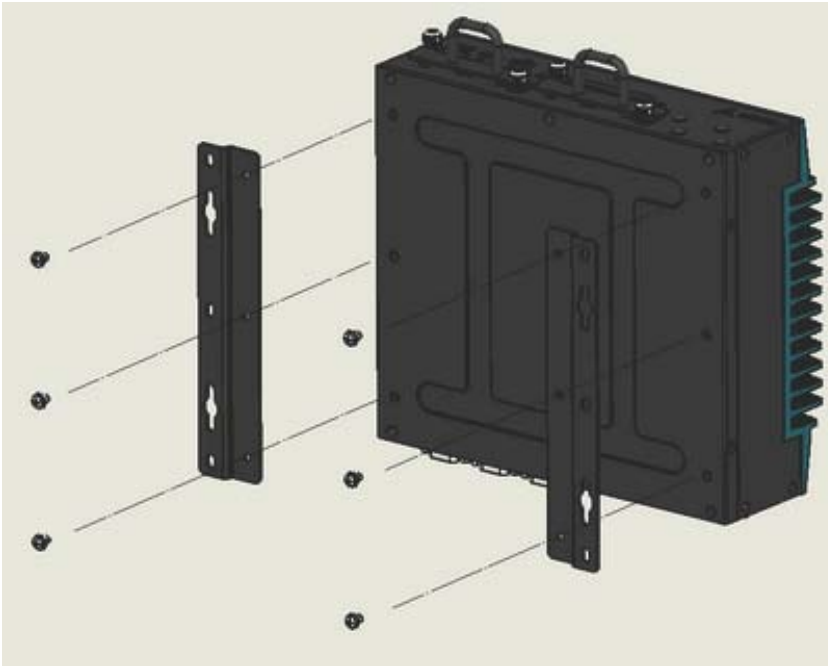

3. Once final assembly is complete, mount the MXE-5500 series controller on the wall via the screw holes.

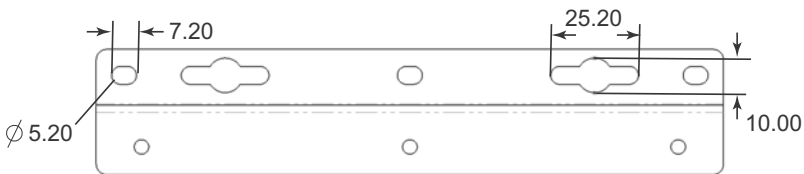

2.7 Cooling Considerations

Heat-generating components of the MXE-5500 (such as CPU and PCH) are all situated on the top of the system. These components directly contact the heat sink via thermal pads and dissipate heat generated by the components. To maximize efficiency of heat dis-

sipation, maintain a minimum of 2 inches (5cm) clearance on the top of the MXE-5500.

2.8 Driver Installation

Download requisite drivers, as follows, for your system from <http://www.adlinktech.com> and install.

- ▶ Audio
- ▶ Chipset
- ▶ Graphic
- ▶ IRST
- ▶ LAN
- ▶ ME
- ▶ USB3 XHCI

This page intentionally left blank.

Appendix A Watchdog Timer (WDT) & DI/O Function Libraries

This appendix describes use of the watchdog timer (WDT) function library for the MXE-5500.

The watchdog timer is a hardware mechanism provided to reset the system if the operating system or an application stalls. After starting, the watchdog timer in the application must be periodically reset before the timer expires. Once the watchdog timer expires, a hardware-generated signal is sent to reset the system.

DI/O provides input/output to support inter-device communications. Simple programming guides allow easy transmission of digital signals between the system and attached peripherals.

A.1 WDT with API/Windows

Matrix WDT API library files and a demo program (incl. source code) can be downloaded from http://www.adlinktech.com/PD/web/PD_detail.php?utm_source=&cKind=&pid=1631.

To use the WDT function library for MXE-5500 series, include the header file `matrix_wdt.h` and linkage library `matrix_wdt.lib` in the C++ project.

InitWDT

Initializes watchdog timer function of MXE-5500. `InitWDT` must be called before the invocation of any other WDT function.

@ Syntax

C/C++

```
BOOL InitWDT()
```

@ Parameters

None

@ Return code

TRUE if watchdog timer is successfully initialized.

FALSE if watchdog timer fails to initialize.

SetWDT

Sets the timeout value of the watchdog timer. There are two parameters for this function to indicate the timeout ticks and unit. ResetWDT or StopWDT should be called before the expiration of watchdog timer, or the system will reset.

@ Syntax

C/C++

```
BOOL SetWDT(BYTE tick, BYTE unit)
```

@ Parameters

tick

Specify the number of ticks for watchdog timer. A valid value is 1 - 255.

unit

Specify the timeout ticks of the watchdog timer.

Value	Description
0	The unit for one tick is one second. For example, when one tick is specified as 100 and the unit as 0, the timeout value is 100 seconds.
1	The unit for one tick is one minute. For example, when one tick is specified as 100 and the unit as 1, the timeout value is 100 minutes.

@ Return codes

TRUE if timeout value of watchdog timer is successfully set.

FALSE if timeout value of watchdog timer is failed to set.

StartWDT

Starts watchdog timer function. Once the StartWDT is invoked, the watchdog timer starts. ResetWDT or StopWDT should be

called before the expiration of watchdog timer, or the system will reset.

@ Syntax

C/C++

```
BOOL StartWDT()
```

@ Parameters

None

@ Return codes

TRUE if watchdog timer is successfully started.

FALSE if watchdog timer is failed to start.

ResetWDT

Resets the watchdog timer. The invocation of ResetWDT allows restoration of the watchdog timer to the initial timeout value specified in SetWDT function. ResetWDT or StopWDT should be called before the expiration of the watchdog timer, or the system will reset.

@ Syntax

C/C++

```
BOOL ResetWDT()
```

@ Parameters

None

@ Return codes

TRUE if watchdog timer is successfully reset.

FALSE if watchdog timer fails to reset.

StopWDT

Stops the watchdog timer.

@ Syntax

C/C++

```
BOOL StopWDT()
```

@ Parameters

None

@ Return codes

TRUE if watchdog timer is successfully stopped.

FALSE if watchdog timer fails to stop.

A.2 DI/O with API/Windows

Matrix DI/O API library files and a demo program (incl. source code) are located on the included driver CD or downloaded from <http://www.adlinktech.com>.

To use the DI/O function library for MXE-5500 series, include the header file `matrix_dio.h` and linkage library `matrix_dio.lib` in the C++ project.

DI/O functions are as follows.

GPIO_Init

Reserves system resources for digital input/output API service. It is necessary to call this function before using other MXE-5500 DI/O functions.

@ Syntax

C/C++

```
int GPIO_Init(void)
```

@ Parameters

None

@ Return code

NoError

ErrorOpenDriverFailed

ErrorDeviceIoctl

GPI_Read()

Reads the digital logic state of the digital input line..

@ Syntax

C/C++

```
I16 GPI_Read(U16 *pwState)
```

@ Parameters

pwState

Returns the digital logic state of MXE-5500 digital input channels 1 to 8 (bit 0 to 7)

@ Return code

```
NoError  
ErrorOpenDriverFailed  
ErrorDeviceIoctl
```

GPO_Write()

Sets the digital logic state of the digital output line.

@ Syntax

C/C++

```
I16 GPO_Write(U16 wState)
```

@ Parameters

State

Sets the digital logic state of MXE-5500 digital output channels 1 to 8 (bit 0 to 7) to 0 or 1.

@ Return code

```
NoError  
ErrorOpenDriverFailed  
ErrorDeviceIoctl
```

GPO_Read()

Reads the digital logic state of the digital output line.

@ Syntax

C/C++

```
I16 GPO_Read(U16 *pwState)
```

@ Parameters

pwState

Returns the digital logic state of MXE-5500 digital output channels 1 to 8 (bit 0 to 7).

@ Return code

NoError

ErrorOpenDriverFailed

ErrorDeviceIoctl

Appendix B BIOS Setup



NOTE:

BIOS options in the manual are for reference only, and are subject to configuration.

The Basic Input/Output System (BIOS) is a program that provides a basic level of communication between the processor and peripherals. In addition, the BIOS also contains codes for various advanced features applied to the MXE-5500. The BIOS setup program includes menus for configuring settings and enabling features of the MXE-5500 series. Most users do not need to use the BIOS setup program, as the MXE-5500 ships with default settings that work well for most configurations.



WARNING:

Changing BIOS settings may lead to incorrect controller behavior and possible inability to boot. In such a case, Section 1.7.1 on page 21 provides instruction on clearing the CMOS and restoring default settings

Enter BIOS setup by selecting DEL when the system is powered on the POST (Power On Self Test) message is displayed. The MXE-5500 controller supports one-time Boot Menu allowing selection of boot device. Enter the Boot Menu by selecting F7 at POST.



NOTE:

- ▶ BIOS options listed are for reference only.
 - ▶ Different configurations can affect BIOS behavior.
 - ▶ Displayed material may reflect only the BIOS version corresponding to initial release and may differ from that of the purchased motherboard.
-

B.1 Main

Contains basic system information for the MXE-5500.

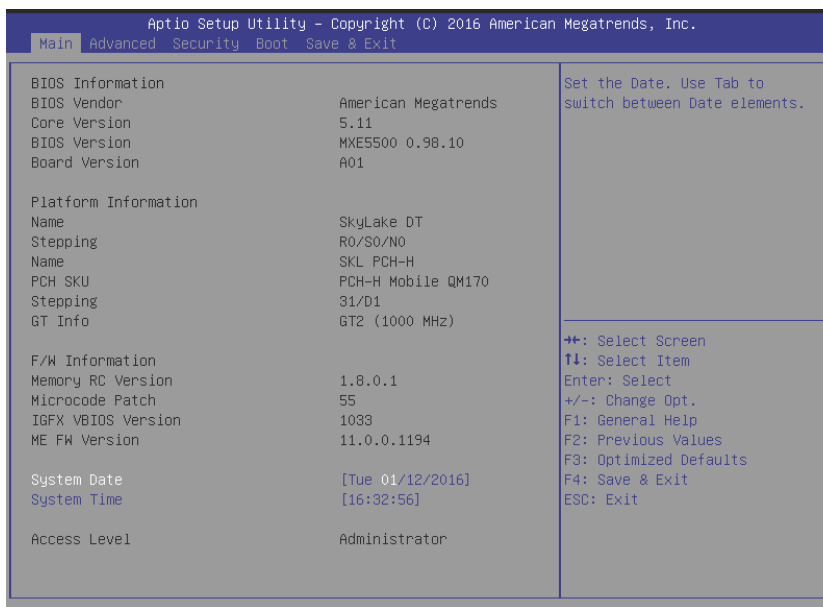

BIOS Information

Shows current system BIOS Vendor, Core Version, BIOS Version, Board Version and Product Name.

Platform Information

Shows current system Platform Name, CPU Stepping, PCH SKU, PCH Stepping and GT information.

FW Information

Shows current system Memory RC version, Microcode Path, IGFX VBIOS version and ME FW version.

System Time/System Date

Allows adjustment of system time and date, as follows.

1. Highlight System Time or System Date using the up and down <Arrow> keys
2. Enter new values using the keyboard and select <Enter>
3. Select < Tab > to move between fields.



NOTE:

- ▶ The date must be entered in MM/DD/YY format, and the time in HH:MM:SS.
- ▶ The time is in 24-hour format. For example, 5:30 A.M. appears as 05:30:00, and 5:30 P.M. as 17:30:00.

B.2 Advanced

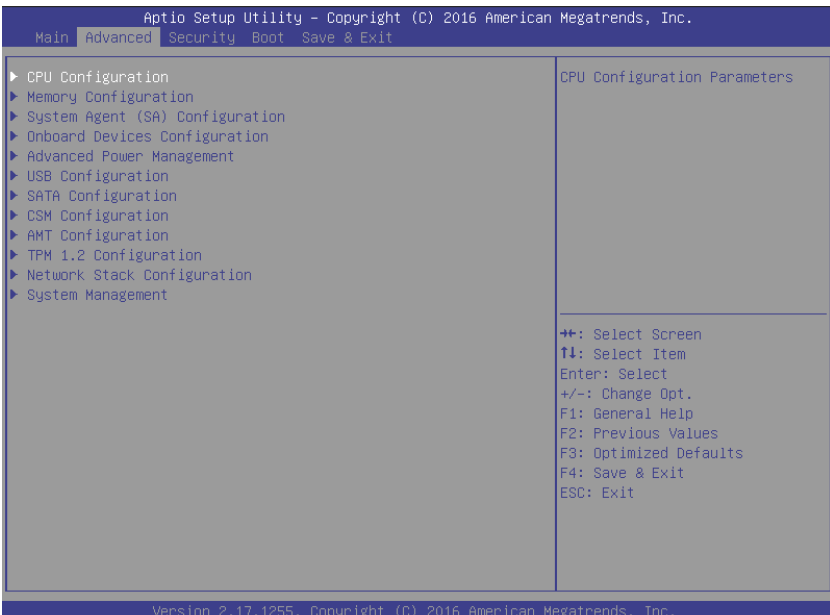

CAUTION:

Setting incorrect or conflicting values in Advanced BIOS Setup may cause system malfunction

Accesses advanced options of the MXE-5500.

B.2.1 CPU Configuration

Aptio Setup Utility - Copyright (C) 2016 American Megatrends, Inc.

Advanced

CPU Configuration	
Intel(R) Core(TM) i7-6820EQ CPU @ 2.80GHz	
CPU Signature	506E3
Microcode Patch	55
Max CPU Speed	2800 MHz
Min CPU Speed	800 MHz
CPU Speed	2800 MHz
Processor Cores	4
Hyper Threading Technology	Supported
Intel VT-x Technology	Supported
Intel SMX Technology	Supported
64-bit	Supported
EIST Technology	Supported
CPU C3 state	Supported
CPU C6 state	Supported
CPU C7 state	Supported
L1 Data Cache	32 KB x 4
L1 Code Cache	32 KB x 4
L2 Cache	256 KB x 4
L3 Cache	8 MB
L4 Cache	Not Present
Hyper-threading	[Enabled]

Enabled for Windows XP and Linux (OS optimized for Hyper-Threading Technology) and Disabled for other OS (OS not optimized for Hyper-Threading Technology). When Disabled only one thread per enabled core is enabled.

++: Select Screen
 ↑↓: Select Item
 Enter: Select
 +/-: Change Opt.
 F1: General Help
 F2: Previous Values
 F3: Optimized Defaults
 F4: Save & Exit
 ESC: Exit

Version 2.17.1255. Copyright (C) 2016 American Megatrends, Inc.

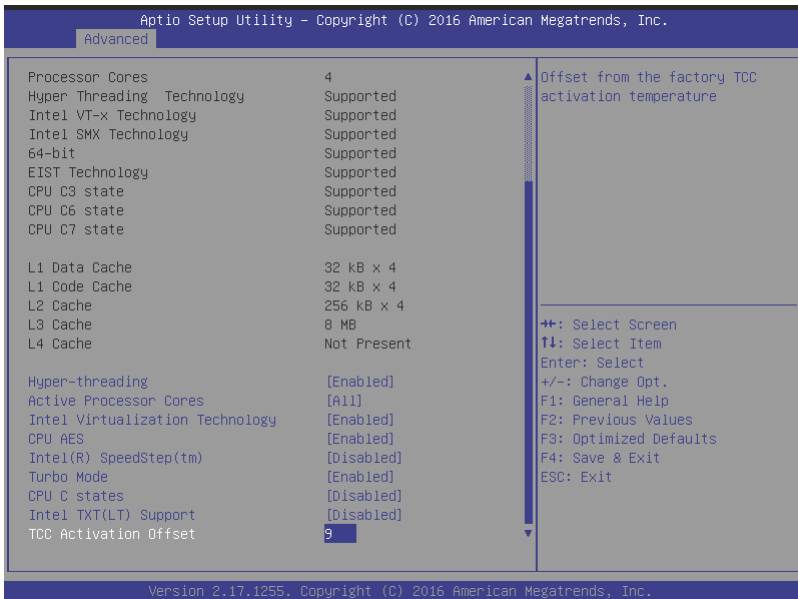

Hyper-Threading

Enabled for Windows XP and Linux (optimized for Hyper-Threading Technology) and Disabled for other OS (not optimized for Hyper-Threading Technology). When Disabled only one thread per enabled core is enabled.

Active Processor Cores

Number of cores to enable in each processor package.

Intel Virtualization Technology

When enabled, a VMM can utilize the additional hardware capabilities provided by Vanderpool Technology.

CPU AES

Enable/Disable CPU Advanced Encryption Standard instructions.

Intel(R) SpeedStep(tm)

Allows more than two frequency ranges to be supported.

CPU C States

Enable or disable CPU C states.

Intel TXT(LT) Support

Enables or Disables Intel(R) TXT(LT) support.

TCC Activation Offset

Offset from the factory TCC activation temperature.

B.2.2 Memory Configuration

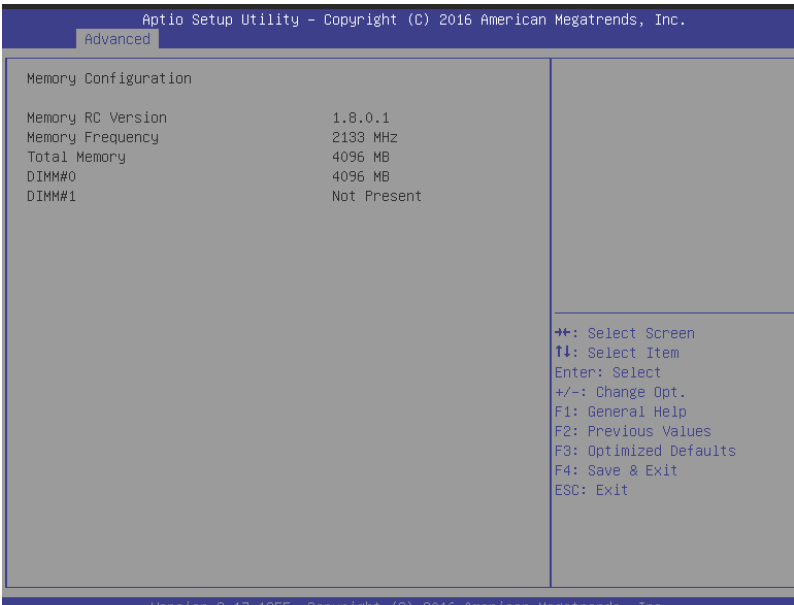

Shows current system Memory RC Version and values for memory frequency, total memory, DIMM#0, and DIMM#1.

B.2.3 System Agent (SA) Configuration

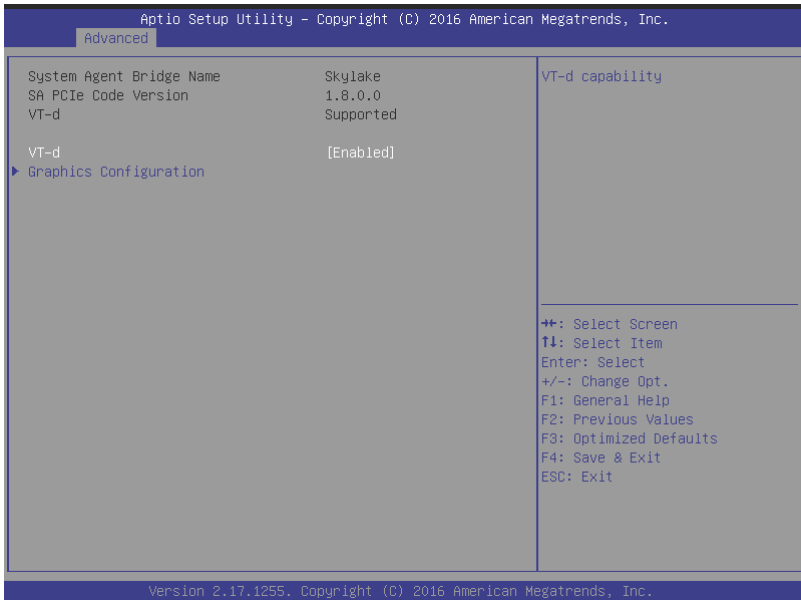

VT-d

Enables/disables VT-d capability.

B.2.4 Graphics Configuration

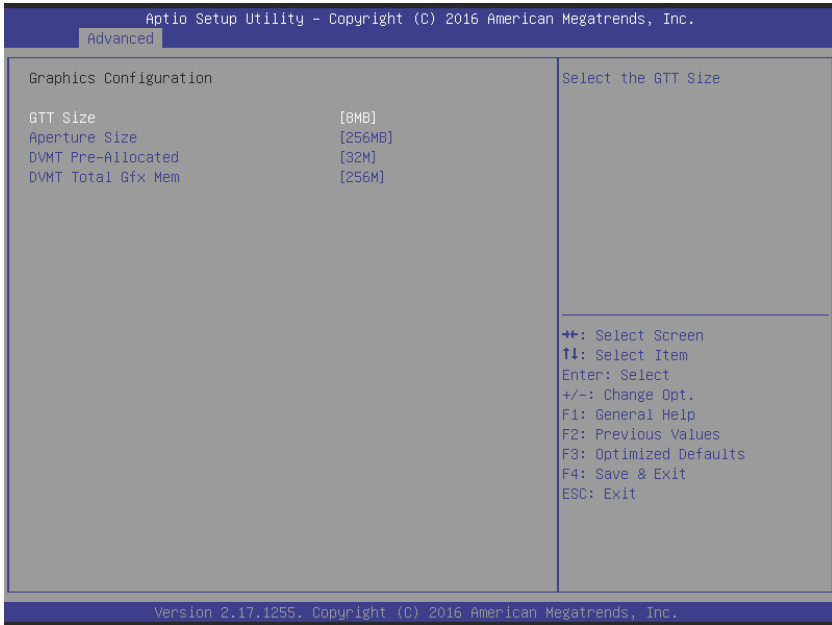

GTT Size

Sets GTT size.

Aperture Size

Sets aperture size, with MMIO BIOS assignment exceeding 4GB automatically enabled when 2048MB aperture is selected, available when CSM Support is disabled.

DVMT Pre-Allocated

Sets size of DVMT 5.0 pre-allocated (fixed) graphics memory used by the internal graphics device.

DVMT Total Gfx Mem

Sets size of DVMT5.0 total graphic memory used by the internal graphics device.

B.2.5 Onboard Devices Configuration

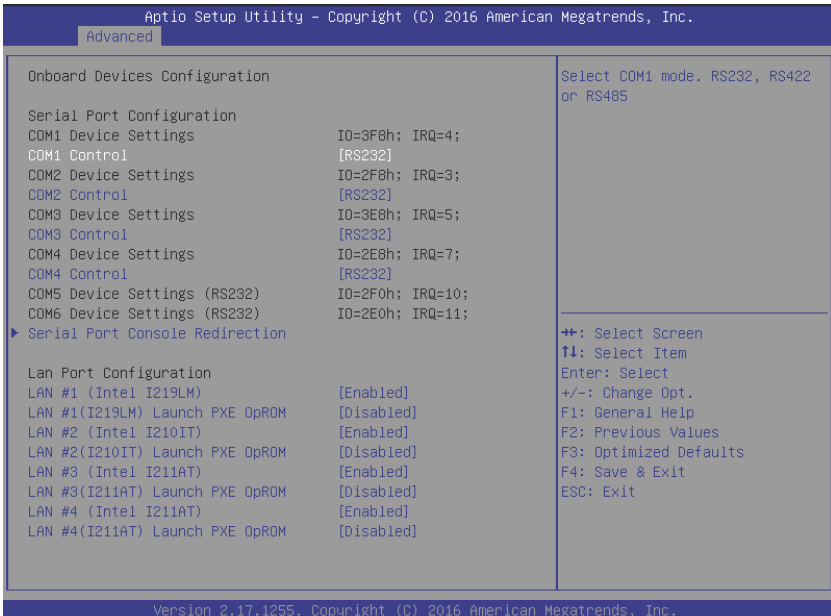

Serial Port 1 to 6 Configuration

Sets port type (RS-232/422/485) for Serial Ports 1 to 4.

LAN #1 (Intel I219LM)

Enables/Disables onboard Intel I219LM LAN controller.

LAN #1(Intel I219LM) Launch PXE OpROM

Enables or disables execution of LAN boot-rom to add boot option for legacy network devices.

LAN #2 (Intel I210IT)

Enables/Disables onboard Intel I210IT LAN controller.

LAN #2(I210IT) Launch PXE OpROM

Enables or disables execution of LAN boot-rom to add boot option for legacy network devices.

LAN #3 (Intel I211AT)

Enables/Disables onboard Intel I211AT LAN controller.

LAN #3(I211AT) Launch PXE OpROM

Enables or disables execution of LAN boot-rom to add boot option for legacy network devices.

LAN #4 (Intel I211AT)

Enables/Disables onboard Intel I211AT LAN controller.

LAN #4(I211AT) Launch PXE OpROM

Enables or disables execution of LAN boot-rom to add boot option for legacy network devices.

B.2.5.1 Serial Port Console Redirection



Console Redirection

Enables console redirection on COM 1, SOL, and EMS COM.

Console Redirection Settings

Sets miscellaneous parameters for COM Port 1, SOL, and EMS COM.

B.2.6 Advanced Power Management

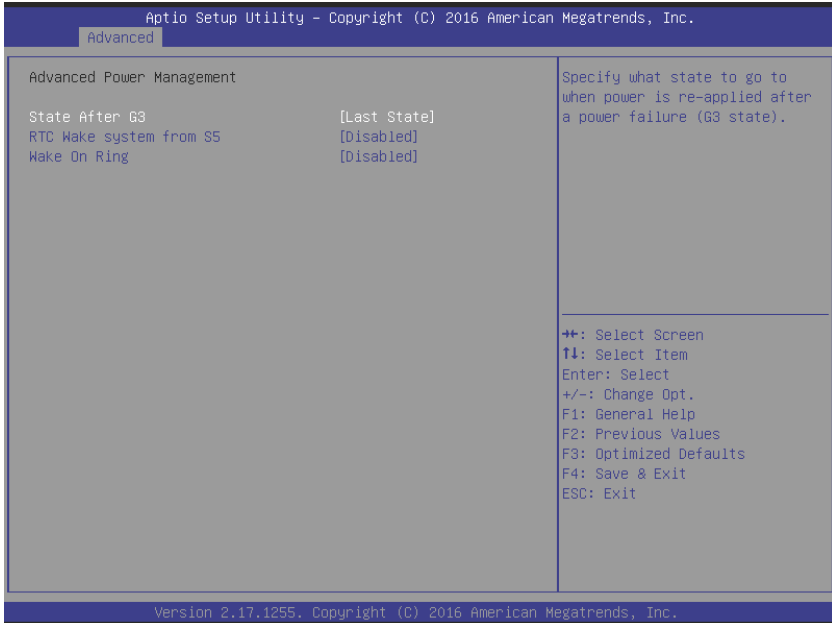

State After G3

Determines the state the computer enters when power is restored after power loss, from among Last State, Power On, and Power Off

Option	Description
Power Off	Retains system power off after power is restored
Power On	Powers the system up when power is restored
Last State	When power is restored, returns the system to the state in which power was interrupted

State After G3

Sets the state entered when power is re-applied after a power failure (G3 state).

RTC Wake system from S5

Enable or disable system wake on alarm event, with FixedTime waking the system at the hr/min/sec specified, and DynamicTime waking the system at the current time + Increase minute(s).

Wake On Ring

Disables/Enable RI ping for Wake On Ring function.

B.2.7 USB Configuration

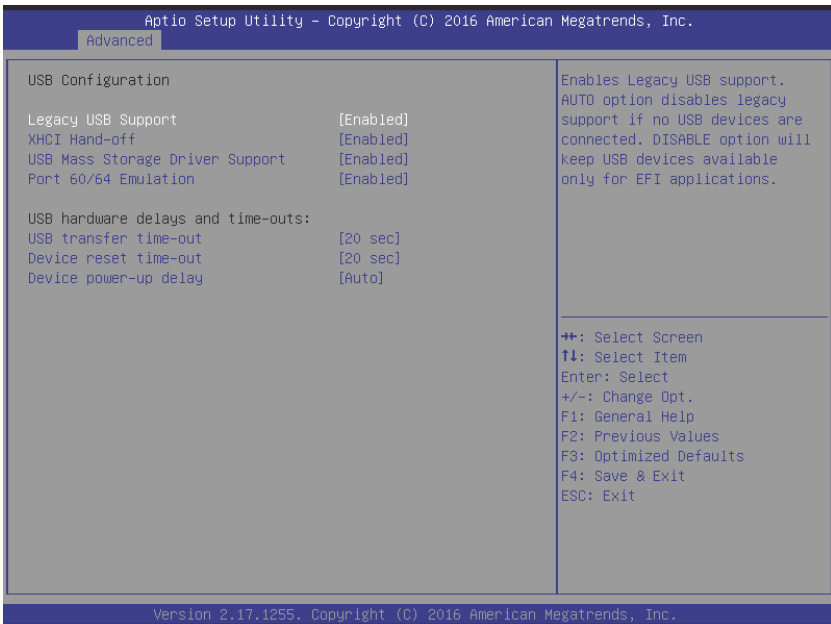

Legacy USB Support

With AUTO disabling legacy support if no USB devices are connected, and DISABLE keeping USB devices available only for EFI applications.

XHCI Hand-off

A workaround for OS without XHCI hand-off support, where XHCI ownership change should be claimed by the XHCI driver.

USB Mass Storage Driver Support

Enable/Disable USB mass storage driver support.

Port 60/64 Emulation

Enables I/O port 60h/64h emulation support, should be enabled for complete USB keyboard legacy support for OS not recognizing USB ports.

USB transfer time-out

Timeout value for Control, Bulk, and Interrupt transfers.

Device reset time-out

USB mass storage device Start Unit command timeout.

Device power-up delay

Maximum time taken before the device reports itself to the Host Controller, with Auto using a default value of 100 ms for a Root port, and for Hub port the delay is taken from the Hub descriptor.

B.2.8 SATA Configuration

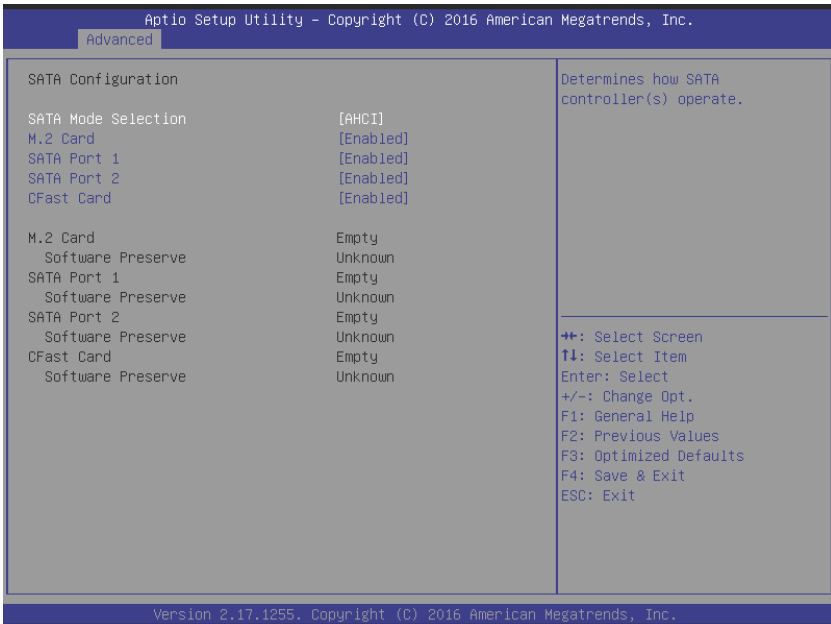

SATA Mode Selection

Sets SATA controller operation modes.

M.2 Card

Enables/disables M.2 card.

SATA Port 1~2

Enables/disables SATA ports 1 and 2.

CFast Card

Enables/disables CFast card.

B.2.9 CSM Configuration

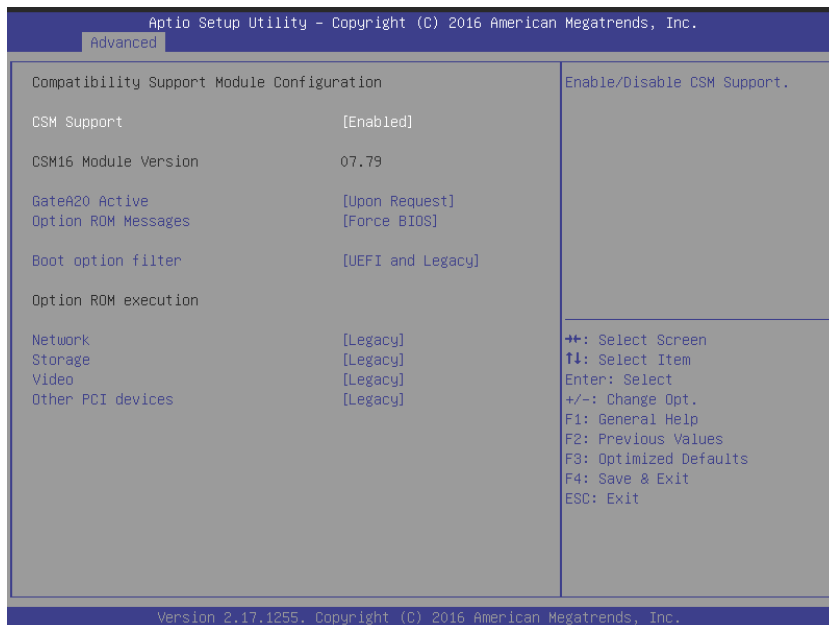

CSM Support

Enable or Disable CSM Support.

GateA20 Active

UPON REQUEST disables GA20 using BIOS services, and ALWAYS prevents GA20 from being disabled, useful when any RT code exceeding 1MB is executed.

Option ROM Messages

Sets display mode for Option ROM.

Boot option filter

Controls Legacy/UEFI ROM priority.

Network

Controls execution of UEFI and Legacy PXE OpROM.

Storage

Controls execution of UEFI and Legacy Storage OpROM.

Video

Controls execution of UEFI and Legacy Video OpROM.

Other PCI devices

Determines OpROM execution policy for devices other than Network, Storage, and Video.

B.2.10 AMT Configuration

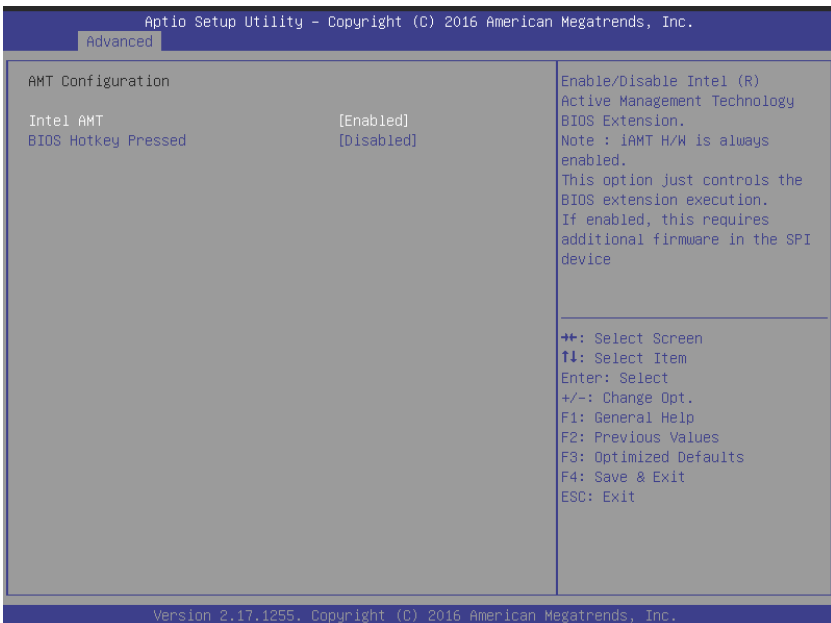

Intel AMT

Enables/disables Intel(R) Active Management Technology BIOS Extension. Note that iAMT H/W is always enabled. This option merely controls the BIOS extension execution. If enabled, additional firmware is required in the SPI device.

BIOS Hotkey Pressed

OEMFLag Bit 1: Enables/disables BIOS hotkey press.

B.2.11 TPM 1.2 Configuration



Security Device Support

Enables/disables BIOS support for security device, which the OS will not show. TCG EFI protocol and INT1A interface are not available when enabled.

TPM State

Enables/disables Security Device. Reboot occurs during restart in order to change device state.

Pending Operation

Schedules operation for the security device. Reboot occurs during restart in order to change device state.

B.2.12 Network Stack Configuration



Network Stack

Enables/disables UEFI Network Stack.

B.2.13 System Management

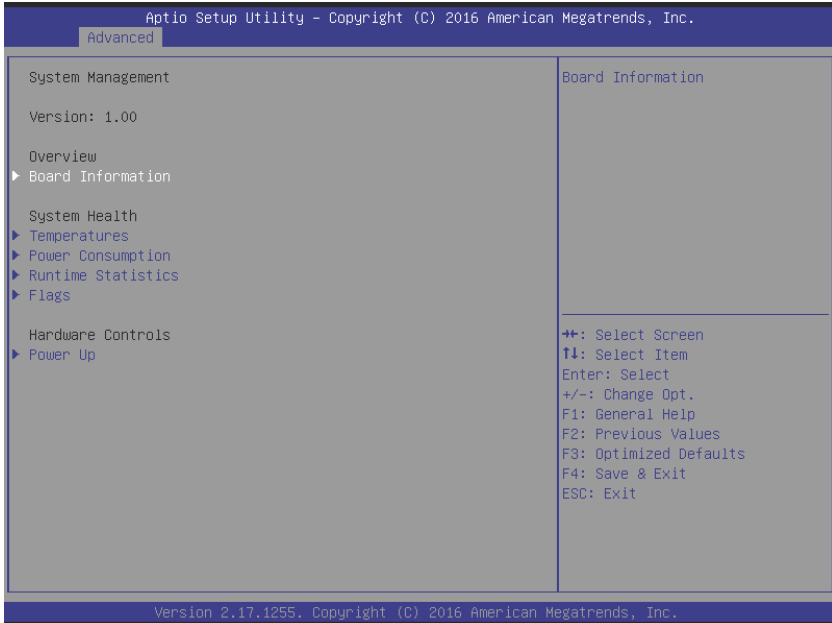

B.2.13.1 Board Information

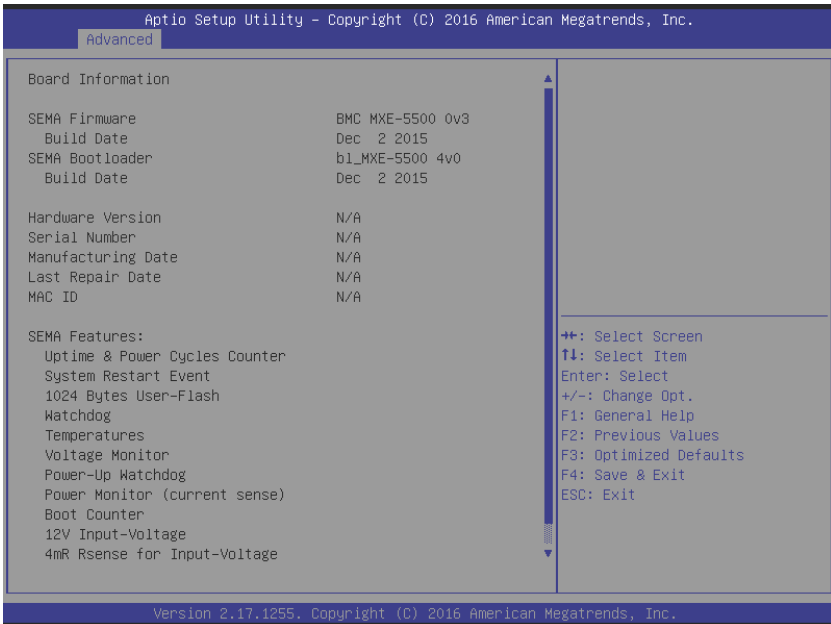

B.2.13.2 Temperatures and Fan Speed

Aptio Setup Utility - Copyright (C) 2016 American Megatrends, Inc.

Advanced

Temperatures	
CPU Temperature	
Current	66.0C
Startup	48C
Min	23C
Max	80C
Board Temperatures	
Current	43C
Startup	40C
Min	24C
Max	52C

++: Select Screen
↑↓: Select Item
Enter: Select
+/-: Change Opt.
F1: General Help
F2: Previous Values
F3: Optimized Defaults
F4: Save & Exit
ESC: Exit

Version 2.17.1255, Copyright (C) 2016 American Megatrends, Inc.

B.2.13.3 Power Consumption

Aptio Setup Utility - Copyright (C) 2016 American Megatrends, Inc.

Advanced

Hardware Monitor	
Current Input Current	0.500A
Current Input Power	6.090W
VCC_CORE	1.088V
VCC_GT	0.748V
1V0_A	0.980V
VDDQ	1.190V
VRTC	2.729V
V3P3S	3.232V
V3P3A	3.239V
V5_S	4.906V
VCCGTx	0.000V
0V95_VCCIO	0.941V
V1v5	1.483V
VCCSA	0.954V
1v8_VCCOPC	1.812V
V5VSB	4.894V
V12	11.961V

++: Select Screen
 ↑↓: Select Item
 Enter: Select
 +/-: Change Opt.
 F1: General Help
 F2: Previous Values
 F3: Optimized Defaults
 F4: Save & Exit
 ESC: Exit

Version 2.17.1255. Copyright (C) 2016 American Megatrends, Inc.

B.2.13.4 Runtime Statistics

Aptio Setup Utility - Copyright (C) 2016 American Megatrends, Inc.

Advanced

Runtime Statistics

Total Runtime	0h 25m
Current Runtime	0h 02m 56s
Power Cycles	12
Boot Cycles	26
Boot Reason	Software-reset

++: Select Screen
↑↓: Select Item
Enter: Select
+/-: Change Opt.
F1: General Help
F2: Previous Values
F3: Optimized Defaults
F4: Save & Exit
ESC: Exit

Version 2.17.1255, Copyright (C) 2016 American Megatrends, Inc.

B.2.13.5 Flags

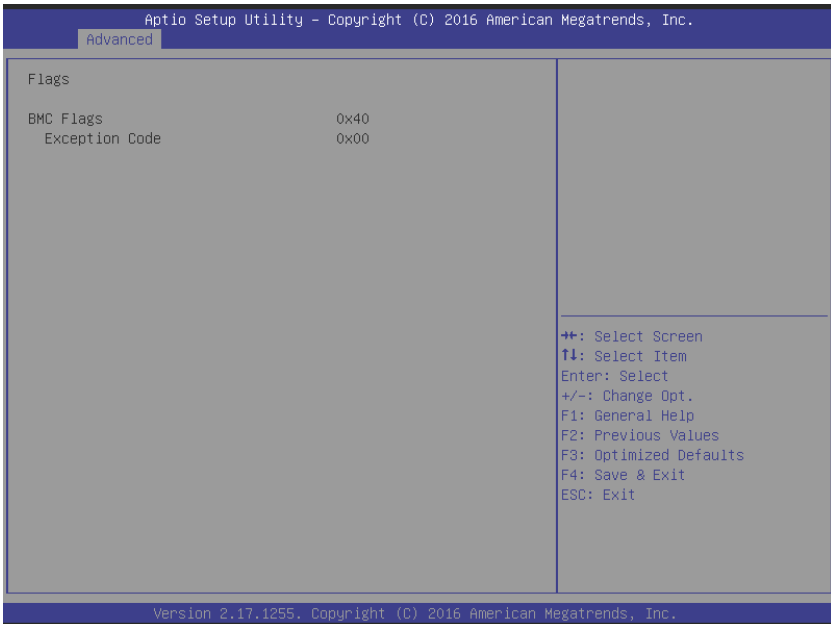

B.2.13.6 Power Up



Power-Up Watchdog

Resets the system a set amount of time after power up.

B.3 Security

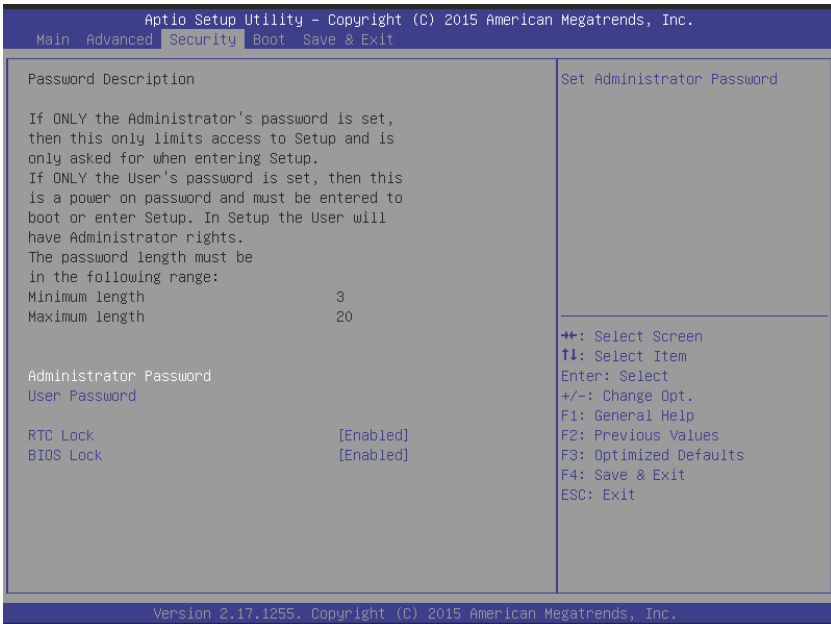

If only the Administrator password is set, access is limited and the password requested on Setup. If User password is set, it acts as a power-on password and must be entered to boot or enter setup. In Setup the user receives

Administrator Password

Sets Administrator Password.

User Password

Sets User Password.

RTC Lock

Enable locks bytes 38h-3Fh in the lower/upper 128-byte bank of RTC RAM.

BIOS Lock

Enable/Disable the PCH BIOS Lock (BLE bit).

B.4 Boot



Setup Prompt Timeout

Number of seconds before setup activation key is launched, with 65535(0xFFFF) setting indefinite waiting.

Bootup Num-Lock State

Sets keypad Number Lock status following boot.

Quiet Boot

Option	Description
Disabled	Directs BIOS to display POST messages
Enabled	Directs BIOS to display the OEM logo.

Fast Boot

Option	Description
Disabled	Directs BIOS to perform all POST tests.
Enabled	Directs BIOS to skip certain POST tests to boot faster.

While enabling Fast Boot can reduce system ready time, some prerequisites can reduce effectiveness

Boot Option Priorities

Specifies the priority of boot devices, all of which are detected during POST and displayed. Target Boot Option # and click to select the desired device

B.4.1 Hard Drive BBS Priorities

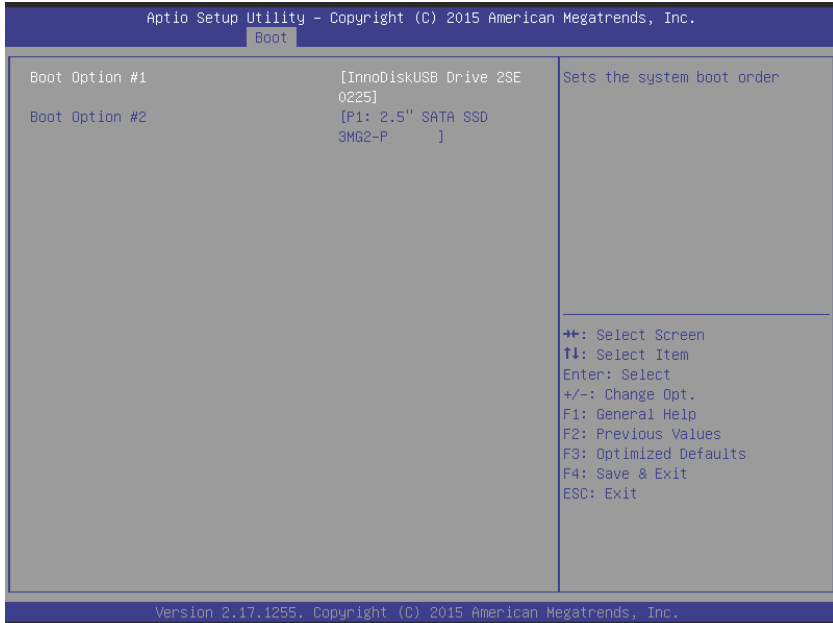

Specifies the priority of boot devices. All installed boot devices are detected during POST and displayed. Target Boot Option # and click to select the desired device.

B.5 Save & Exit

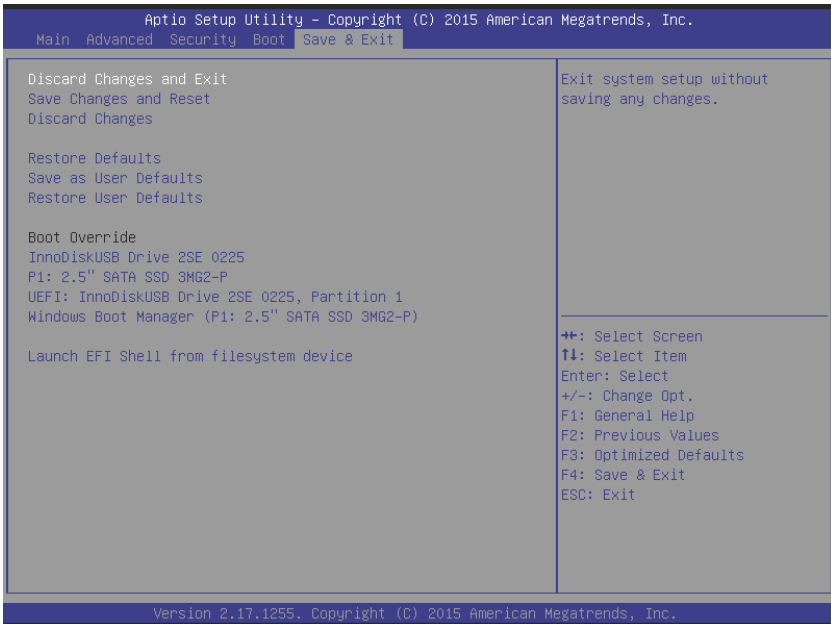

Discard Changes and Exit

Discards all changes and exits BIOS setup

Save Changes and Reset

Saves all changes and reboots the system, with new settings taking effect

Discard Changes

Resets system setup without saving any changes

Restore Defaults

Sets all BIOS options to default settings, designed for maximum system stability but less than maximum performance. Select

Restore Defaults if the computer encounters system configuration problems.

Save as User Defaults

Saves all changes to this point as user defaults

Restore User Defaults

Restores user defaults to all setup options

Launch EFI Shell from filesystem device

Attempts to launch EFI Shell application (Shell.efi) from one of the available filesystem devices

Appendix C SEMA Utility

The SEMA graphical interface is available for Windows operating systems. To get started in Windows, simply run SEMAGui.exe

C.1 System Overview Tab

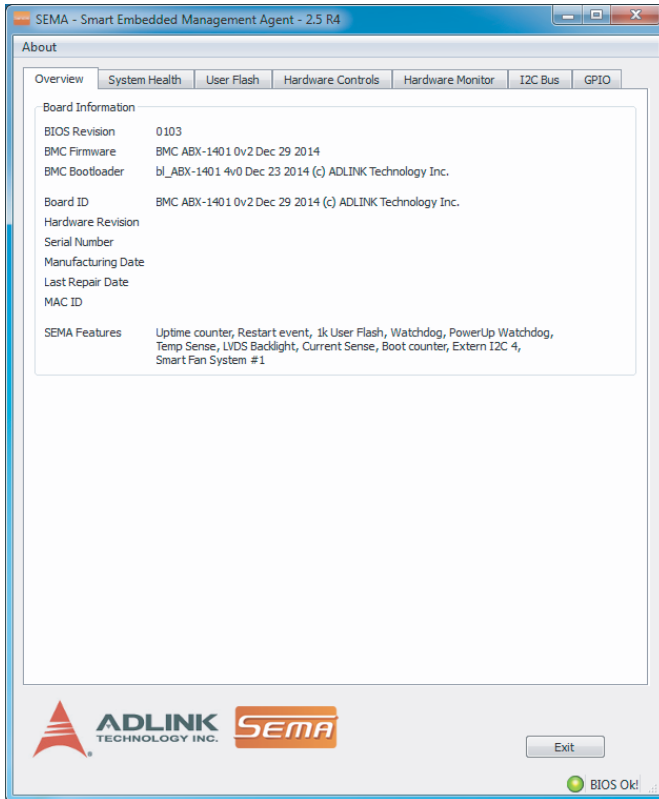

C.1.1 Board Information

This section shows general information about the board, BIOS Version and SEMA features supported. The first three lines show the firmware versions of the board. The BMC versions each con-

tain an ID-string and the respective build date. The next lines show the board ID, hardware revision, serial number, manufacturing/repair date and MAC ID of the board. The last line shows all supported SEMA features for this board.

C.2 System Health Tab

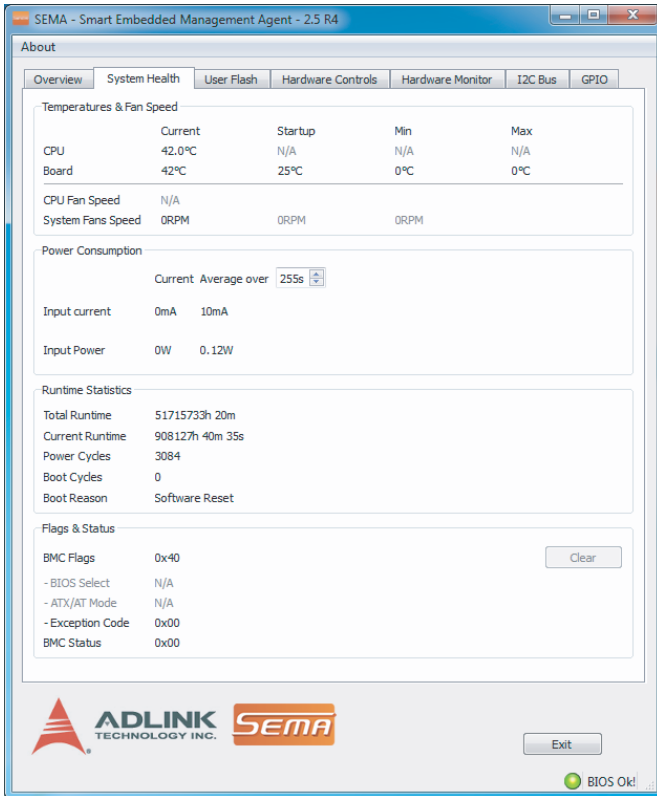

SEMA - Smart Embedded Management Agent - 2.5 R4

About

Overview System Health User Flash Hardware Controls Hardware Monitor I2C Bus GPIO

Temperatures & Fan Speed

	Current	Startup	Min	Max
CPU	42.0°C	N/A	N/A	N/A
Board	42°C	25°C	0°C	0°C

CPU Fan Speed N/A

System Fans Speed 0RPM 0RPM 0RPM

Power Consumption

Current Average over 255s

Input current 0mA 10mA

Input Power 0W 0.12W

Runtime Statistics

Total Runtime 51715733h 20m

Current Runtime 908127h 40m 35s

Power Cycles 3084

Boot Cycles 0

Boot Reason Software Reset

Flags & Status



BMC Flags 0x40

- BIOS Select N/A

- ATX/JAT Mode N/A

- Exception Code 0x00

BMC Status 0x00

BIOS Ok!

C.2.1 Temperatures & Fan Speed

This section displays the current, start-up, minimum and maximum temperatures of the CPU and environment (board). The data is displayed in °C and updated every second. Current CPU and

speeds of system fans 1 to 3 are also displayed in RPM. Note that not all platforms supply all information as shown, in which case N/A is displayed in lieu of the value.

C.2.2 Power Consumption

Displays information for the main power supply in mA for current and W for power consumption, and are updated every second. To filter out spikes and acquire average values over a certain interval of time, a second/sample value can be selected from 0 to 255. Averaging takes place within the graphical user interface rather than within the BMC itself. The application collects the selected number of samples and present an average thereof. Note that not all platforms may provide the necessary current sensors, in which case N/A is displayed and the section will grayed out.

C.2.3 Runtime Statistics

Total	Total system uptime in hours and minutes
Current	Uptime since last boot in hours, minutes and seconds
Power cycles	Number of power cycles
Boot cycles	Number of HW/SW-Resets and successful power-ups
Boot reason	Reason for the last reboots (e.g. power loss, power down, HW reset, etc.)

C.2.4 Flags

Display board-specific information about the internal status of the BMC. Please refer to the technical manual for the board, the chapter entitled “SEMA functions”. Also provided is information regarding the currently active BIOS, whether the system is in AT or ATX mode, and Exception Codes, if applicable.

C.3 User Flash Memory Tab



The Read/Write Raw Data Storage in SEMA Flash Memory function is reserved for advanced SEMA applications.

NOTE:

The Read/Write Raw Data Storage in SEMA Flash Memory function is reserved for advanced SEMA applications.

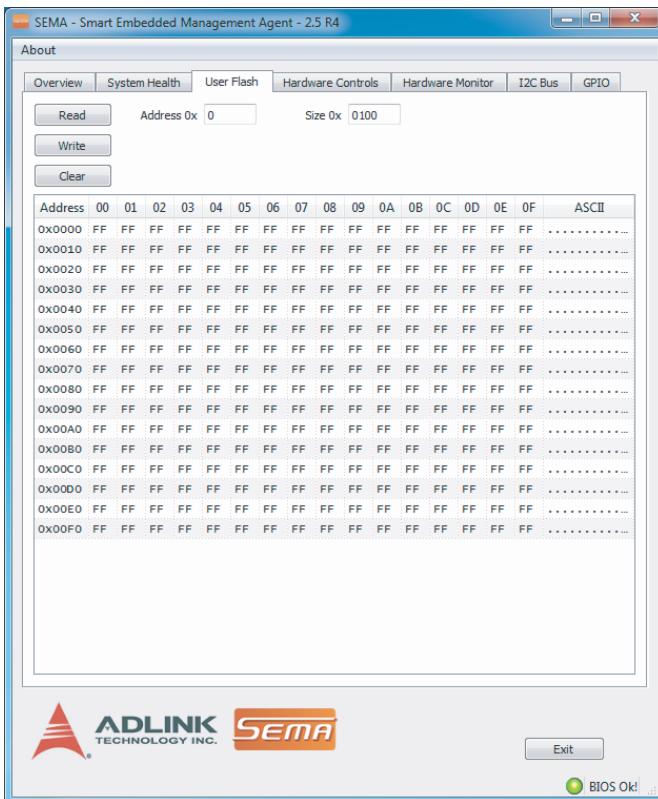

C.3.1 Memory

For Flash Memory organization, with address and size entered as hexadecimal values. Valid start addresses are multiples of 16 within the range: 0x0000-0x01F0 for 512 byte variants and 0x0000-0x03F0 for 1024 byte variants. Size can be any multiple of 16 bytes (up to the total memory size).

For example, to display the first 32 bytes from user flash memory, enter “0000” as address, “20” (hex 20 equals decimal 32) as size and press the [Read] button. Content is acquired from the BMC and displayed in the output window.

Each line contains the address of the first byte of this line, followed by 16 data bytes (displayed as hexadecimal values, with prefixes “0x” omitted for clarity) followed by the corresponding printable ASCII characters. The [Write] button opens the Write memory dialog box.

C.3.2 Write Memory

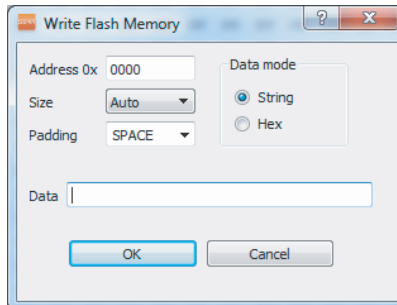

Address

The address is entered as hexadecimal value within the range of 0x0000..0x01FC (respectively 0x03FC for 1k board variants)

Size

Can be any multiple of four, up to 32 bytes or “Auto”. In Auto mode, the number of bytes to write is determined by the amount of data entered in the subsequent data field (max 32 bytes).

Padding

If the data length is not a multiple of four, the required number of pad (or fill) characters is appended. In String mode, a valid pad character can be any printable ASCII character or a pre-defined pad characters: - SPACE character (ASCII character 0x20) - NULL character (ASCII character 0x00) In Hex mode, any eight bit hex value (00..FF) is valid.

Data Mode

Currently supported modes are String mode, in which entered text (up to 32 characters) is converted to a byte stream, with no termination character appended, and Hex mode, in which up to 64 hex digits (0..9, A..F) can be entered, resulting in up to 32 bytes of data.

C.4 Hardware Control Tab

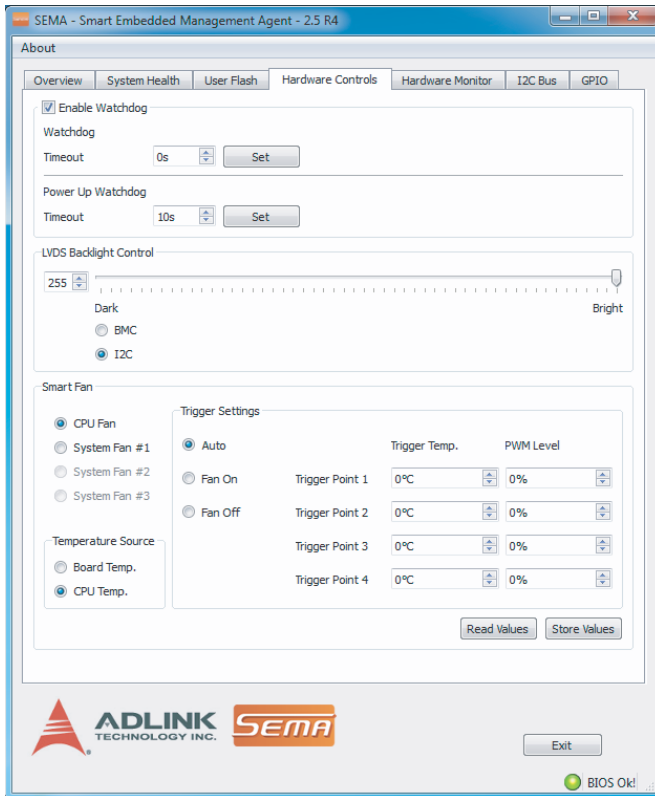

C.4.1 Watchdog

The watchdog timeout value is given in seconds and can be set at 1 to 65535 seconds, with a value of 0 seconds disabling the watchdog. When enabled, the watchdog should be triggered repeatedly within the timeout period to avoid system reset. Note that not all platforms support watchdog functionality, in which case the section is grayed out.



NOTE:

- ▶ When using the watchdog feature, all partitions must be mounted as read-only, to avoid file system corruption and data loss.
- ▶ It is not advisable to use the watchdog feature in a Windows environment, since Windows restart uses a safe shutdown procedure.

C.4.2 Backlight Control

Enables or disables the backlight of display connected via LVDS, with value adjusted by a slider or entered as a numerical, from 0 to 255. Note that not all platforms support the necessary circuitry, in which case the section is grayed out. Radio boxes allow selection of control by BMC or LVDS I2C interface.

C.4.3 Smart Fan

Provides control of either CPU or system fans (if applicable). The accessible system is also listed in SEMA Features in the System Overview Tab or via the "sema cap" command line

All fans can have a discrete independent temperature source defining the temperature sensor used for calculating speed.

Settings are as shown

Setting	Function
Auto	No other settings required
Off	Fan is disabled
On	Fan runs at maximum speed

Trigger Temp and PWM Level determine the characteristic curve of the fan control. Sample settings as shown result in fan function as follows.

Temperature	Fan PWM level
Falls below 15°C	Turns off
Between 15°C and 60°C	30%
Between 40°C and 70°C	40%
Between 48°C and 80°C	63%
Exceeds 55°C	100%



NOTE:

If the temperature drops below one of the trigger points, the lower PWM value is taken.

C.5 Hardware Monitor Tab

Shows Power Consumption and Temperatures information from the System Health Tab in a graphical format.



When logging is enabled, all values queried every second, such as temperatures and power consumption, are recorded to a log file.

At startup, logging is disabled by default.

To enable, check Enable Logging and select a file. New data is appended to the selected file, with existing data not overwritten.

Logging ceases when Enable Logging is unchecked or the program closed, and suspended during a File Open dialog.

Data is Recorded as simple ASCII text in tab-separated columns for easy import/export into any spreadsheet calculation program or other data processing tool. The first line written to the log file contains captions indicating the content and the respective unit of the data to be recorded. When any data is unavailable, such as when, for example, no sensor is detected, the corresponding column is skipped.

Currently available items are as follows

Caption	Content/Unit
Total[m]	Total uptime in minutes
PwrUp[s]	Uptime since last power up in seconds
Tcpu[°C]	CPU temperature in °C
Tbrd[°C]	Board temperature in °C
Tcpumin[°C]	Minimal CPU temperature in °C
Tcpumax[°C]	Maximal CPU temperature in °C
Tbrdmin[°C]	Minimal board temperature in °C
Tbrdmax[°C]	Maximal board temperature in °C
Imp[mA]	Main power current in mA
Pmp[W]	Power on main power current rail in W
n[1]	Number of samples used for filtering
Impf[mA]	Filtered main power current in mA
Pmpf[W]	Filtered power on main power current rail in W
FanSpdSys1-3[RPM]	CPU-Fan speed in RPM
FanSpdCPU[RPM]	System-Fan speed in RPM
'VoltageName'[V]	For each monitored voltage in V

C.6 I₂C Bus Tab

The board management controller (BMC) can access up to four external I₂C busses, with byte and block access for read and write

implemented. Both common bus speeds of 100 and 400kHz are supported.

To read data from or write data to the BMC an address (8-bit) must be given as well as the amount of data to be transferred (length) plus the register offset.

Data should then be handed over in hex values forming a hex string, as shown.

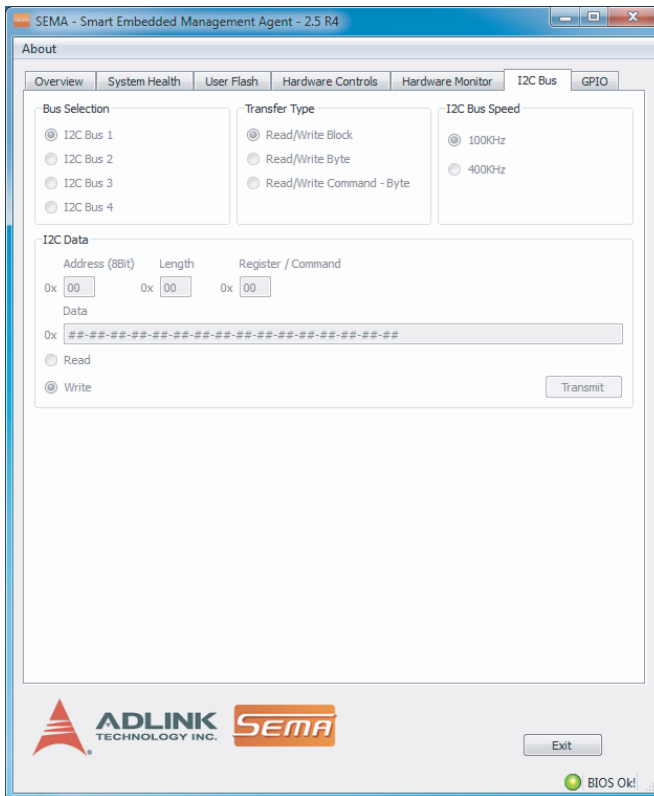

Transfer Types

Different transfer types will result in I₂C bus activity as follows.

Read/Write Block	Write	Start + Address/Write + Register /Command + Length + Data[1] + Data[2] + ... +Data[Length] + Stop
	Read	Start + Address/Write + Register /Command + Start + Address/Read + Length + Data[1] +Data[2] + ... + Data[Length] + Stop
Read/Write Byte	Write	Start + Address/Write + Data[1] + Stop
	Read	Start + Address/Read + Data[1] + Stop
Read/Write Command Byte	Write	Start + Address/Write + Register /Command + Data[1] + Stop
	Read	Start + Address/Read + Register /Command + Data[1] + Stop



I₂C Bus 3 does not support Read/Write Command Byte transfer.

C.7 GPIO Tab

Allows control of up to 16 GPIOs provided by the ADLINK board, with the actual number of usable GPIOs board-dependent.

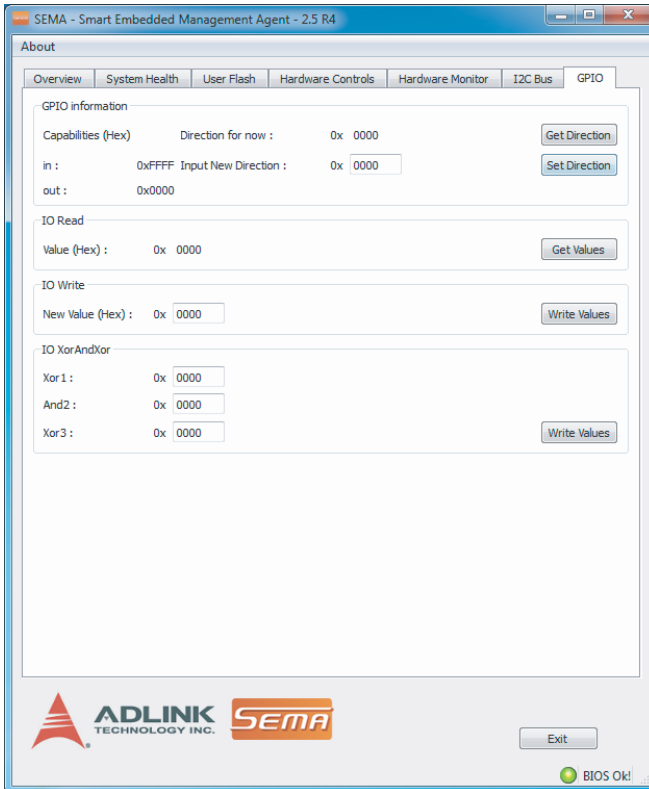

C.7.1 GPIO information

Controls GPIO direction, with each bit in the shown byte representing a GPIO.

To set a GPIO for output the bit must set to 0, and for input 1. Get Direction reads the current configuration and Set Direction sets the configuration to the value entered in the Input New Direction field.

C.7.2 IO Read

Shows the current input values for all GPIOs, with those configured as output showing current output value.

C.7.3 IO Write

Sets outputs, with GPIOs configured as input not affected.

C.7.4 IO XorAndXor

Reads the GPIO input and applies the logic operation in order of the input fields, with the result set as output value.

C.8 Status Bar

Displays a flashing red LED if the board has booted using the Failsafe BIOS, as may occur if the main BIOS has been corrupted.

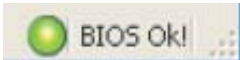
	Failsafe BIOS active
	Booted from default BIOS

This page intentionally left blank.

Important Safety Instructions

For user safety, please read and follow all instructions, Warnings, Cautions, and Notes marked in this manual and on the associated device before handling/operating the device, to avoid injury or damage.

S'il vous plaît prêter attention stricte à tous les avertissements et mises en garde figurant sur l'appareil , pour éviter des blessures ou des dommages.

- ▶ Read these safety instructions carefully
- ▶ Keep the User's Manual for future reference
- ▶ Read the Specifications section of this manual for detailed information on the recommended operating environment
- ▶ The device can be operated at an ambient temperature of 50°C
- ▶ When installing/mounting or uninstalling/removing device; or when removal of a chassis cover is required for user servicing (See "Getting Started" on page 25.):
 - ▷ Turn off power and unplug any power cords/cables
 - ▷ Reinstall all chassis covers before restoring power
- ▶ To avoid electrical shock and/or damage to device:
 - ▷ Keep device away from water or liquid sources
 - ▷ Keep device away from high heat or humidity
 - ▷ Keep device properly ventilated (do not block or cover ventilation openings)
 - ▷ Always use recommended voltage and power source settings
 - ▷ Always install and operate device near an easily accessible electrical outlet
 - ▷ Secure the power cord (do not place any object on/over the power cord)
 - ▷ Only install/attach and operate device on stable surfaces and/or recommended mountings
- ▶ If the device will not be used for long periods of time, turn off and unplug from its power source

- ▶ Never attempt to repair the device, which should only be serviced by qualified technical personnel using suitable tools
- ▶ A Lithium-type battery may be provided for uninterrupted backup or emergency power.



Risk of explosion if battery is replaced with one of an incorrect type; please dispose of used batteries appropriately.

Risque d'explosion si la pile est remplacée par une autre de type incorrect. Veuillez jeter les piles usagées de façon appropriée.

- ▶ The device must be serviced by authorized technicians when:
 - ▷ The power cord or plug is damaged
 - ▷ Liquid has entered the device interior
 - ▷ The device has been exposed to high humidity and/or moisture
 - ▷ The device is not functioning or does not function according to the User's Manual
 - ▷ The device has been dropped and/or damaged and/or shows obvious signs of breakage
- ▶ Disconnect the power supply cord before loosening the thumbscrews and always fasten the thumbscrews with a screwdriver before starting the system up
- ▶ It is recommended that the device be installed only in a server room or computer room where access is:
 - ▷ Restricted to qualified service personnel or users familiar with restrictions applied to the location, reasons therefor, and any precautions required
 - ▷ Only afforded by the use of a tool or lock and key, or other means of security, and controlled by the authority responsible for the location

	<p>BURN HAZARD</p> <p>Touching this surface could result in bodily injury. To reduce risk, allow the surface to cool before touching.</p> <p>RISQUE DE BRÛLURES</p> <p><i>Ne touchez pas cette surface, cela pourrait entraîner des blessures.</i></p> <p><i>Pour éviter tout danger, laissez la surface refroidir avant de la toucher.</i></p>
---	---

This page intentionally left blank.

Getting Service

Contact us should you require any service or assistance.

ADLINK Technology, Inc.

Address: 9F, No.166 Jian Yi Road, Zhonghe District
New Taipei City 235, Taiwan
新北市中和區建一路 166 號 9 樓
Tel: +886-2-8226-5877
Fax: +886-2-8226-5717
Email: service@adlinktech.com

Ampro ADLINK Technology, Inc.

Address: 5215 Hellyer Avenue, #110
San Jose, CA 95138, USA
Tel: +1-408-360-0200
Toll Free: +1-800-966-5200 (USA only)
Fax: +1-408-360-0222
Email: info@adlinktech.com

ADLINK Technology (China) Co., Ltd.

Address: 上海市浦东新区张江高科技园区芳春路 300 号 (201203)
300 Fang Chun Rd., Zhangjiang Hi-Tech Park
Pudong New Area, Shanghai, 201203 China
Tel: +86-21-5132-8988
Fax: +86-21-5132-3588
Email: market@adlinktech.com

ADLINK Technology Beijing

Address: 北京市海淀区上地东路 1 号盈创动力大厦 E 座 801 室(100085)
Rm. 801, Power Creative E, No. 1 Shang Di East Rd.
Beijing, 100085 China
Tel: +86-10-5885-8666
Fax: +86-10-5885-8626
Email: market@adlinktech.com

ADLINK Technology Shenzhen

Address: 深圳市南山区科技园南区高新南七道 数字技术园
A1 栋 2 楼 C 区 (518057)
2F, C Block, Bldg. A1, Cyber-Tech Zone, Gao Xin Ave. Sec. 7
High-Tech Industrial Park S., Shenzhen, 518054 China
Tel: +86-755-2643-4858
Fax: +86-755-2664-6353
Email: market@adlinktech.com

LiPPERT ADLINK Technology GmbH

Address: Hans-Thoma-Strasse 11, D-68163
Mannheim, Germany
Tel: +49-621-43214-0
Fax: +49-621 43214-30
Email: emea@adlinktech.com

ADLINK Technology, Inc. (French Liaison Office)

Address: 6 allée de Londres, Immeuble Ceylan
91940 Les Ulis, France
Tel: +33 (0) 1 60 12 35 66
Fax: +33 (0) 1 60 12 35 66
Email: france@adlinktech.com

ADLINK Technology Japan Corporation

Address: 〒101-0045 東京都千代田区神田鍛冶町 3-7-4
神田 374 ビル 4F
KANDA374 Bldg. 4F, 3-7-4 Kanda Kajicho,
Chiyoda-ku, Tokyo 101-0045, Japan
Tel: +81-3-4455-3722
Fax: +81-3-5209-6013
Email: japan@adlinktech.com

ADLINK Technology, Inc. (Korean Liaison Office)

Address: 137-881 서울시 서초구 서초대로 326, 802 (서초동, 모인터빌딩)
802, Mointer B/D, 326 Seocho-daero, Seocho-Gu,
Seoul 137-881, Korea
Tel: +82-2-2057-0565
Fax: +82-2-2057-0563
Email: korea@adlinktech.com

ADLINK Technology Singapore Pte. Ltd.

Address: 84 Genting Lane #07-02A, Cityneon Design Centre
Singapore 349584
Tel: +65-6844-2261
Fax: +65-6844-2263
Email: singapore@adlinktech.com

ADLINK Technology Singapore Pte. Ltd. (Indian Liaison Office)

Address: #50-56, First Floor, Spearhead Towers
Margosa Main Road (between 16th/17th Cross)
Malleswaram, Bangalore - 560 055, India
Tel: +91-80-65605817, +91-80-42246107
Fax: +91-80-23464606
Email: india@adlinktech.com

ADLINK Technology, Inc. (Israeli Liaison Office)

Address: 27 Maskit St., Corex Building
PO Box 12777
Herzliya 4673300, Israel
Tel: +972-54-632-5251
Fax: +972-77-208-0230
Email: israel@adlinktech.com

ADLINK Technology, Inc. (UK Liaison Office)

Tel: +44 774 010 59 65
Email: UK@adlinktech.com