

Instruction Manual

WX1□-PS (Voltage Input·Soft Variable Type)
 WX2□-PS (V/Contact Input·Soft Variable Type)
 WX3□-PS (mV Input·Soft Variable Type)
 WX4□-PS (mV/Contact Input·Soft Fixed Type)
Program Setter

JUXTA

1. INSPECTION

This instrument has been thoroughly tested at the factory before shipment. When you receive it, visually inspect it for damage and check the accessories.

1.1 Model number and specification check
 Check to see the model number and specifications on the nameplate attached to the front cover of the unit are as ordered.

1.2 Contents of the instruction manual
 This instruction manual provides instructions on mounting, external wiring and maintenance.

2. GENERAL

2.1 Soft variable type (WX1□, WX3□)
 This unit outputs isolated current or voltage signal according to Time Table when enter input of more than 75% into START/RESET instruction input. Time Table can be changed through Handy Terminal.

2.2 Soft variable type (WX2□)
 Soft fixed type (WX4□)
 This unit outputs isolated current or voltage signal according to Time Table when enter input of OFF (Open) into START/RESET instruction input.

Accessories:

Mounting block	2
Tag number and range label	1 each
Mounting screw M4	4

3. MOUNTING METHOD

JUXTA signal conditioners can be mounted on rack, wall or DIN rail.

3.1 Rack mounting
 Use panel (FRK-16) and install it on an angle as shown in Fig.1. This is a convenient method for high density mounting of the unit on 19-inch rack panel. (See Fig. 6)

3.2 Wall mounting
 Use panel (FRK-16) to mount the unit as shown in Fig. 2 or directly mount it on the wall (See Figs. 6 and 7 for mounting dimensions)

3.3 DIN rail mounting
 Insert DIN rail into the upper of DIN rail groove on the rear of the unit and fix the rail with the slidlock at the lower of the unit as shown in Fig. 3.

3.4 Angle mounting
 In case of single unit mounting, refer to Fig. 5 for its mounting.

3.5 Mounting block installation and removal
 Insert mounting block into the groove of the unit as shown in Fig. 4 and slide it until it is locked with the stopper. To remove it, lift up the mounting block stopper with screwdriver (-) and slide it along the groove.

4. EXTERNAL WIRING

Open the terminal cover of the unit.
 Wire should connect to M4 screw terminal. Flexible twisted wires and durable round crimp-on terminals (JIS C2805) are recommended to be used.

● Signal cable having more than 0.5mm² and power cable having more than 1.25mm² of nominal cross-sectional area of conductor are recommended.

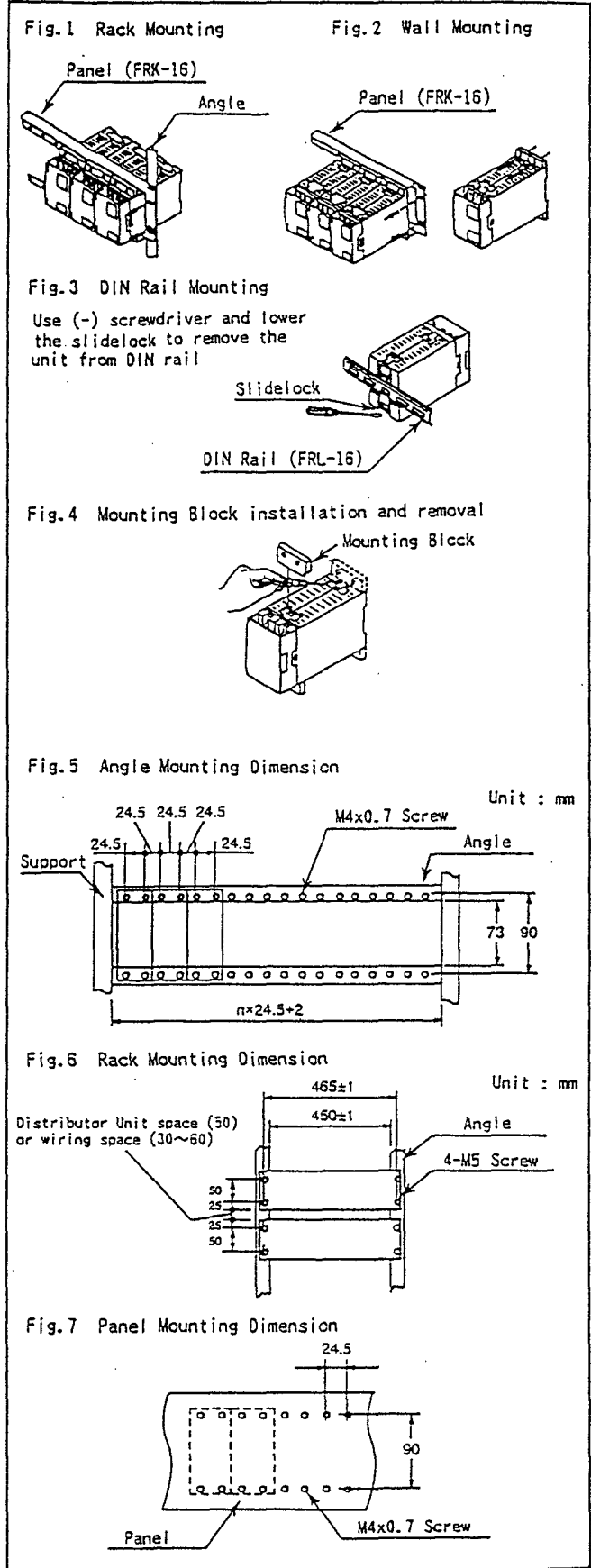

4.1 Wiring

- ① See Fig. 8 for terminal arrangement.
- ② As for soft variable type, connect input voltage signal cable to terminals 3(+) and 4(-).
As for soft fixed type, connect input contact signal cable to 3(+) and 4(-) of the unit.
(See Figs. 6 & 7)
- ③ Connect output signal cable of the unit to its terminals 11(+) and 12(-).
- ④ In case of use AC power, connect AC power cable to terminals 14(L), 15(N), 16(G).
In case of use DC power, connect DC power cable to terminals 14(+), 15(-)
(See Fig. 9 & 10)

5. ITEMS TO BE CHECKED BEFORE TURNING THE POWER SWITCH ON

- ① Make sure that 24V DC power cable of the unit is connected to the correct polarities (+), (-).
 - ② Confirm that the external wiring to the terminal board is correct.
 - ③ Check that the mounting, ambient temperature, humidity, dust and vibration are normal.
- Confirm the above items before turning the power on. The unit needs 5 minutes warmup to meet its specified accuracy level.

6. OPERATION CHECK

(Caution)

Carry out the following calibration after warming up the instruments for more than 5 minutes.

6.1 Calibration equipment

- Voltage/Current Generator (Yokogawa Model 7651 or equivalent) 1
- Voltmeter (Yokogawa Model 7551 or equivalent) 1

6.2 Check method

- ① Connect each equipment as shown in Figs. 11 and 12.
- ② Time Table check
Make START/RESET instruction input less than 25% (Fig. 11) or ON (Close) (Fig. 12). Starting value of Time Table is output and the value is maintained until entry of next START instruction.
Next, make START/RESET instruction input more than 75% (Fig. 11) or OFF (Open) (Fig. 12). Program starts and outputs signal according to Time Table. When program ends, end value of Time Table is output and the value is maintained until entry of next RESET instruction.
- If output signal is out of tolerance in case of ②, adjust it with Handy Terminal (JHT-100 or JHT200). For adjustment, refer Instruction Manuals of Handy Terminal.
(JHT200 : IM JF81-02E, JHT-100 : IM JF81-01E)

Fig. 8 Terminal Arrangement

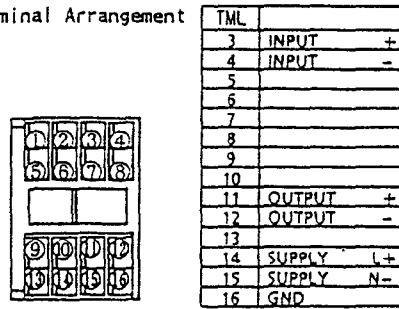

Fig. 9 Wiring Diagram (Soft Variable Type)

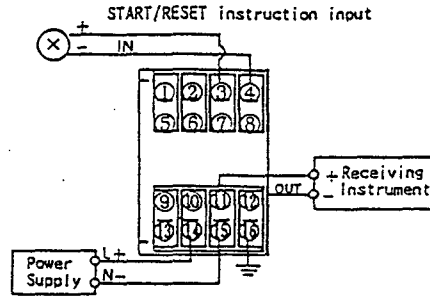

Fig. 10 Wiring Diagram (Soft Fixed Type)

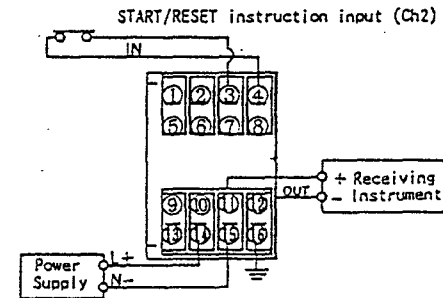

Fig. 11 Wiring of Calibration Equipment (Soft Variable Type)

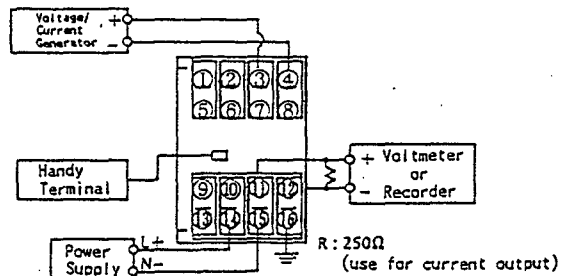

Fig. 12 Wiring of Calibration Equipment (Soft Fixed Type)

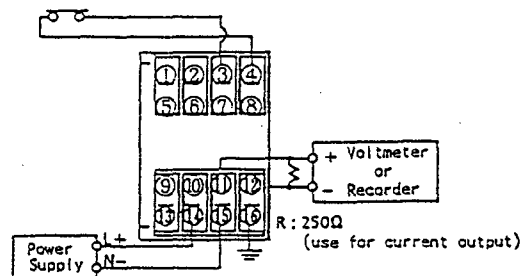
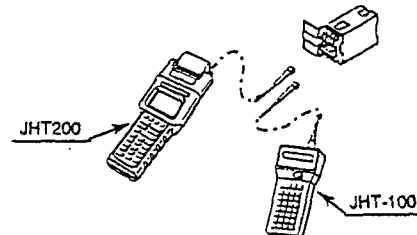

Fig. 13 Connection to Handy Terminal!



7. SET VALUE INPUT THROUGH HANDY TERMINAL

As for soft variable type, input range, Time Table can be changed through Handy Terminal.

There are 11 points in Time Table and provide relation of time vs. output.

Set X Axle (Time) at fixed constant C20~C30.

Set Y Axle (Output) at fixed constant C31~C41.

0~100.0% of C20~C30 corresponds 0~8000 seconds.

0~100.0% of C31~C41 corresponds 0~100.0% output.

Setup condition of Time Table :

0.0% \cong (C20~C30) \cong 99.8% (0~7984 seconds)

-10.0% \cong (C31~C41) \cong 110.0%

C20 < C21 < C22 < C23 < C24 < C25 < C26 < C27 < C28 < C29 < C30

Setup resolution :

Time : 8 seconds (0.1%)

Output : 0.1%

Input range is setup by ZERO, SPAN (B10, B11).

Set voltage corresponding 0% input on B10 and span voltage on B11.

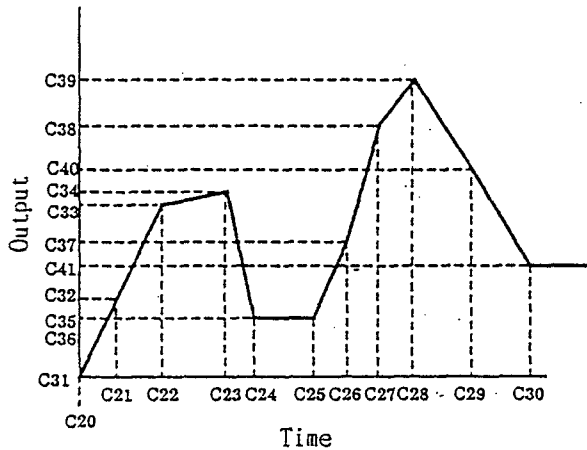

PARAMETER LIST

NO.	ITEM	TITLE DISPLAY	DATA DISPLAY
01	Model	MODEL	□□□□*□
02	Tag No.	TAG NO	16 Alphanumerics
03	Self Check	SELF CHK	Good or Error
A00	Display Item	DISPLAY	
A01	Input 1	INPUT 1	□□□□.□V/mV
A02	Output	OUTPUT	□□□.□%
A03	Status	STATUS	FF (Hexagonal 2 digits)
A04	Rev No.	REV NO	n.nnn (n : Rev No.)
A05	Load	LOAD	□□□.□%
A06	Input 2	INPUT 2	□□□□.□V/mV
A07	Buffer 1	BUFFER 1	□□□.□%
A08	Buffer 2	BUFFER 2	□□□.□%
A09	Buffer 3	BUFFER 3	□□□.□%
B00	Set Item	SET	
B01	Tag No.1	TAG NO.1	8 Alphanumerics (1st half 8 characters of Tag No.)
B02	Tag No.2	TAG NO.2	8 Alphanumerics (2nd half 8 characters of Tag No.)
B03	Comment 1	COMMENT 1	8 Alphanumerics
B04	Comment 2	COMMENT 2	8 Alphanumerics
B07	Input Type *1	INP TYPE	Select from LL/L/H/HH
B10	Zero Point	ZERO	Numeric Data
B11	Span	SPAN	Numeric Data
B12	Burnout *1	BURN	Select from OFF/ON
B13	Setup Error	SET ERR	GOOD/ERROR
B20	Program *2	PROGRAM	[Inter-company Setup Item]
B21	Program *2	PROGRAM	[Inter-company Setup Item]
≡	≡	≡	≡
B48	Program *2	PROGRAM	[Inter-company Setup Item]
B49	Program *2	PROGRAM	[Inter-company Setup Item]
C00	Adjust Item	ADJUST	
C01	0% Output Adjust	OUT 0%	Numeric Data (±10.00)
C02	100% Output Adjust	OUT 100%	Numeric Data (±10.00)
C03	Wiring Resistance Adjust *1	WIRING R	RESET/EXECUTE
C04	0% input Adjust *2	IN 0%	
C05	100% input Adjust *2	IN 100%	
C11	Fixed Constant	CONST	Numeric Data
C12	Fixed Constant	CONST	Numeric Data
≡	≡	≡	≡
C40	Fixed Constant	CONST	Numeric Data
C41	Fixed Constant	CONST	Numeric Data

*1 Display only WX3□-PS
 *2 Display only. Don't use
 (Note) C11~C15 are display only

Subject to change without notice for grade up quality and performance.