

---

**User's  
Manual**

**CA310 Volt mA Calibrator  
CA320 TC Calibrator  
CA330 RTD Calibrator  
Getting Started Guide**

---

Thank you for purchasing the CA310 Volt mA Calibrator, CA320 TC Calibrator, or CA330 RTD Calibrator. This operation guide focuses on the handling precautions, basic operations, and specifications of the CA310/CA320/CA330.

To ensure correct use, please read this manual thoroughly before beginning operation. Keep this manual in a safe place for quick reference in the event that a question arises.

## List of Manuals

The following five manuals, including this one, are provided as manuals for the CA310/CA320/CA330.

Please read all manuals.

Manual Title	Manual No.	Description
CA310 Volt mA Calibrator CA320 TC Calibrator CA330 RTD Calibrator Getting Started Guide	IM CA310-02EN	This guide. The guide explains the handling precautions and basic operations of the CA310/CA320/CA330 and provides a list of specifications.
CA310 Volt mA Calibrator User's Manual	IM 310-01Z2	This manual explains how to use CA310.
CA320 TC Calibrator User's Manual	IM 320-01Z2	This manual explains how to use CA320.
CA330 RTD Calibrator User's Manual	IM 330-01Z2	This manual explains how to use CA330.
CA310/CA320/CA330 User's Manual	IM CA310-92Z1	For China

Contact information of Yokogawa offices worldwide is provided on the following sheet.

Manual No.	Description
PIM113-01Z2	List of worldwide contacts

## Notes

- The contents of this manual are subject to change without prior notice as a result of continuing improvements to the instrument's performance and functionality. The figures given in this manual may differ from those that actually appear on your screen.
- Every effort has been made in the preparation of this manual to ensure the accuracy of its contents. However, should you have any questions or find any errors, please contact your nearest YOKOGAWA dealer.
- Copying or reproducing all or any part of the contents of this manual without the permission of YOKOGAWA is strictly prohibited.

## Trademarks

- Adobe, Acrobat, and PostScript are either registered trademarks or trademarks of Adobe Systems Incorporated.
- In this manual, the ® and TM symbols do not accompany their respective registered trademark or trademark names.
- Other company and product names are trademarks or registered trademarks of their respective companies.

## Revisions

November 2015	1st Edition
October 2016	2nd Edition
October 2017	3rd Edition

## Product Registration

---

Thank you for purchasing YOKOGAWA products.

YOKOGAWA provides registered users with a variety of information and services.

Please allow us to serve you best by completing the product registration form accessible from our homepage.

**<http://tmi.yokogawa.com/>**

## Checking the Contents of the Package

Unpack the box and check the contents before operating the instrument. If the wrong items have been delivered, if items are missing, or if there is a problem with the appearance of the items, contact your nearest YOKOGAWA dealer.

### CA310/CA320/CA330

Check that the product that you received is what you ordered by referring to the model name on the name plate on the rear panel of the main unit. For reference, the model name and specifications of the products are listed below.

Model	Suffix Code	Specifications
CA310		Volt mA Calibrator
CA320		TC Calibrator
CA330		RTD Calibrator

For products whose suffix code contains "Z," an exclusive manual may be included. Please read it along with the standard manual.

## Standard Accessories

The following accessories are included. Make sure that all accessories are present and undamaged.

Item	Model or Component Number	Quantity			Notes
		CA310	CA320	CA330	
Lead cable	98064	1	—	—	For the CA310 1 red, 1 black
Lead cable	98040	—	1	—	For the CA320 1 red, 1 black
Lead cable	98035	—	—	1	For the CA330 3 red, 1 black
Binding post (red-black pair)	99045	—	1	1	One short plate included
Binding post (red-red pair)	99046	—	—	1	One short plate included
Batteries	—	4	4	4	AA alkaline batteries (LR6)
Portable case	B9108NK	1	1	1	
Antiskid rubber	—	1	1	1	Antiskid rubber for the bottom panel
Manuals	IM CA310-02EN	1	1	1	Getting Started Guide For CA310, CA320, and CA330
	IM CA310-02JA	1	1	1	Japanese manual For CA310, CA320, and CA330
	IM CA310-02Z2	1	—	—	User's manual for the CA310
	IM CA320-02Z2	—	1	—	User's manual for the CA320
	IM CA330-02Z2	—	—	1	User's manual for the CA330
	IM CA310-92Z1	1	1	1	Document for China
	PIM 113-01Z2	1	1	1	List of contacts

\* Standard accessories are not covered by warranty of this instrument.

### Optional Accessories (Sold separately)

The following optional accessories are available for purchase separately. For information about ordering accessories, contact your nearest YOKOGAWA dealer.

Item	Model or Component Number	Applicable To			Notes
		CA310	CA320	CA330	
Rubber boots <sup>1</sup>	93060	✓	✓	✓	For protecting the main unit
AC adapter	94012	✓	✓	✓	Input:100 VAC Operating temperature range: -10°C to 40°C
	94013	✓	✓	✓	Input:120 VAC Operating temperature range: -10°C to 40°C
	94016	✓	✓	✓	Input: 220 VAC Operating temperature range: -10°C to 40°C
RJ sensor	90080	—	✓	—	PT100 JIS AA class or equivalent Thermometer operating temperature range: -10°C to 55°C 8-polar miniDin connector Shielded cable 1.5 m Y terminal (compatible with M3 terminal blocks)
TC mini plug set	90040	—	✓	—	10 types K/T/J/E/R(S)/G/C/D/N/B(U)
	90045	—	✓	—	4 types K/T/J/E
Grabber clip	98025	✓	✓ <sup>2</sup>	✓ <sup>2</sup>	Red-black pair, separate type (2 m)
Strap	97040	✓	✓	✓	For rubber boots
Accessory case	B9108XA	✓	✓	✓	

\* Optional accessories(sold separately) are not covered by warranty of this instrument.

1 When rubber boots are attached, the CA310/CA320/CA330 cannot be stored in the portable case.

2 Cannot be used simultaneously with the included binding post (99045/99046).

# Safety Precautions

This product is designed to be used by a person with specialized knowledge.

The general safety precautions described herein must be observed during all phases of operation. If the product is used in a manner not specified in this guide, the protection provided by the product may be impaired. YOKOGAWA assumes no liability for the customer's failure to comply with these requirements.

This manual is part of the product and contains important information. Store this manual in a safe place close to the instrument so that you can refer to it immediately. Keep this manual until you dispose of the instrument.

## The following symbols are used on this instrument.



Warning: handle with care. Refer to the user's manual or service manual. This symbol appears on dangerous locations on the meter which require special instructions for proper handling or use. The same symbol appears in the corresponding place in the manual to identify those instructions.

## French



Avertissement : À manipuler délicatement. Toujours se reporter aux manuels d'utilisation et d'entretien. Ce symbole a été apposé aux endroits dangereux de l'instrument pour lesquels des consignes spéciales d'utilisation ou de manipulation ont été émises. Le même symbole apparaît à l'endroit correspondant du manuel pour identifier les consignes qui s'y rapportent.

 Direct current

 Functional ground

 Courant direct

 Borne de terre fonctionnelle

## Failure to comply with the precautions below could lead to injury or death or damage to the instrument.

### WARNING

#### Use the Instrument Only for Its Intended Purpose

This instrument is a calibrator for the voltage/current measuring instrument (CA310), thermocouple/measuring instrument (CA320), and RTD/measuring instrument (CA330). Use this instrument only as a calibrator.

#### Check the Physical Appearance

Do not use the instrument if there is a problem with its physical appearance.



## **AC adapter**

Only use the dedicated AC adapter for the instrument.

## **Batteries**

- Do not mix new and old batteries or mix different brands or types of batteries. The batteries may leak, heat up, or burst due to their characteristic differences.
- Never replace the batteries while measurement is in progress.

## **Do Not Operate in an Explosive Atmosphere**

Do not use this instrument in the presence of flammable gases or vapors. Doing so is extremely dangerous.

## **Do Not Remove Covers or Disassemble or Alter the Instrument**

Only qualified YOKOGAWA personnel may remove the covers and disassemble or alter the instrument.

## **Measurement Category**

The measurement category of this instrument's signal input terminals is Other (O). Do not use it to measure the main power supply or for Measurement Categories II, III, and IV.

## **Install or Use the Instrument in Appropriate Locations**

- Do not install the instrument outdoors or in locations subject to rain or water. Or, use the instrument in such locations.
- Install the instrument so that you can immediately turn off the power if an abnormal or dangerous condition occurs.

## **Wiring**

- Be sure to use the included lead cables.
- The maximum voltage application between all I/O terminals and earth is 50 VDC (measurement terminal of CA310) or 42 VDC (other than the measurement terminal of CA310). Do not apply voltages that exceed 50 VDC or 42 VDC . Doing so may cause electric shock or burns or may damage the instrument.
- Always turn off the power of the device under measurement before connecting it. Connecting or disconnecting lead cables without turning off the device under measurement is extremely dangerous.
- Do not connect current circuits to the CA310 voltage input terminal. Likewise, do not connect voltage circuits to the current input terminal. Improper connection may cause electric shock or burns or may damage the device under measurement or the instrument.
- Do not apply currents that exceed the maximum allowable input current to the CA310 current input terminal.

---

## CAUTION

---

### Operating Environment Limitations

This product is a Class A (for industrial environment) product. Operation of this product in a residential area may cause radio interference in which case the user will be required to correct the interference.

---

## French

---

## AVERTISSEMENT

### Ne faites de cet équipement que l'utilisation pour laquelle il a été conçu

Cet équipement est un calibre pour l'équipement de mesure de tension/courant (CA310), pour l'équipement de thermocouple/mesure (CA320) et pour l'équipement de RTD/mesure (CA330). Utilisez cet équipement à des fins de calibrage uniquement.

### Inspecter l'apparence physique

Ne pas utiliser l'instrument si son intégrité physique semble être compromise.

### Adaptateur c.a.

Utiliser exclusivement l'adaptateur c.a. dédié pour l'instrument.

### Batteries

- Ne pas mélanger des batteries neuves et des batteries usagées, ni des batteries de marques ou de types différents. Les batteries risquent de fuir, de chauffer ou d'éclater en raison de leurs différentes caractéristiques.
- Ne jamais remplacer les batteries lorsque la mesure est en cours.

### Ne pas utiliser dans un environnement explosif

Ne pas utiliser l'instrument en présence de gaz ou de vapeurs inflammables. Cela pourrait être extrêmement dangereux.

### Ne pas retirer le capot, ni démonter ou modifier l'instrument

Seul le personnel YOKOGAWA qualifié est habilité à retirer le capot et à démonter ou modifier l'instrument.

### **Catégorie de mesure**

La catégorie de mesure des terminaux d'entrée de signal du CA310, CA320, CA330 est Autre(O). Ne pas l'utiliser pour mesurer l'alimentation électrique, ni pour les catégories de mesurell, III et IV.

### **Installer et utiliser l'instrument aux emplacements appropriés**

- Ne pas installer, ni utiliser l'instrument à l'extérieur ou dans des lieux exposés à la pluie ou à l'eau.
- Installer l'instrument de manière à pouvoir immédiatement le débrancher du secteur en cas de fonctionnement anormal ou dangereux.

### **Câblage**

- Veillez à utiliser tous les câbles fournis.
- La tension maximum autorisée entre toutes les bornes I/O et la terre est de 50 V c.c. (borne mesure du CA310) ou de 42 V c.c. (autre que la borne de mesure du CA310). N'appliquez pas de tension supérieure à 50 V c.c (CA310) ou à 42 V c.c (CA320/CA330). Le cas échéant vous vous exposeriez à des risques de choc électrique ou de brûlure ou vous risqueriez d'endommager l'équipement.
- Mettez toujours le dispositif à mesurer hors tension avant de le connecter à l'équipement. Il est extrêmement dangereux de brancher ou débrancher des câbles sans avoir préalablement mis le dispositif à mesurer hors tension.
- Ne branchez pas de circuits de courant sur la borne d'entrée de tension du CA310. Ne branchez pas non plus de circuits sous tension sur la borne d'entrée de courant. Un branchement incorrect vous exposerait à des risques de choc électrique ou de brûlure, ou risquerait d'endommager l'appareil à mesurer ou l'équipement.
- N'appliquez pas de courant supérieur au courant d'entrée maximum admissible à la borne d'entrée de courant du CA310.

---

---

## **ATTENTION**

### **Limitations relatives à l'environnement opérationnel**

Ce produit est un produit de classe A (pour environnements industriels). L'utilisation de ce produit dans un zone résidentielle peut entraîner une interférence radio que l'utilisateur sera tenu de rectifier.

---

## Conventions Used in This Guide

---

### Notes

The notes and cautions in this guide are categorized using the following symbols.



*Improper handling or use can lead to injury to the user or damage to the instrument.* This symbol appears on the instrument to indicate that the user must refer to the manual for special instructions. The same symbol appears in the corresponding place in the manual to identify those instructions. In the manual, the symbol is used in conjunction with the word “WARNING” or “CAUTION.”

### **WARNING**

Calls attention to actions or conditions that could cause serious or fatal injury to the user, and precautions that can be taken to prevent such occurrences.

### French

### **AVERTISSEMENT**

Attire l'attention sur des gestes ou des conditions susceptibles de provoquer des blessures graves (voire mortelles), et sur les précautions de sécurité pouvant prévenir de tels accidents.

---

### **CAUTION**

---

Calls attention to actions or conditions that could cause light injury to the user or damage to the instrument or user's data, and precautions that can be taken to prevent such occurrences.

### French

---

### **ATTENTION**

---

Attire l'attention sur des gestes ou des conditions susceptibles de provoquer des blessures légères ou d'endommager l'instrument ou les données de l'utilisateur, et sur les précautions de sécurité susceptibles de prévenir de tels accidents.

### **Note**

Calls attention to information that is important for the proper operation of the instrument.

## Waste Electrical and Electronic Equipment (WEEE), Directive

---



(This directive is valid only in the EU.)

This product complies with the WEEE directive marking requirement. This marking indicates that you must not discard this electrical/electronic product in domestic household waste.

### Product Category

With reference to the equipment types in the WEEE directive, this product is classified as a “Monitoring and control instruments” product. When disposing products in the EU, contact your local Yokogawa Europe B.V. office. Do not dispose in domestic household waste.

## EU Battery Directive

---



(This directive is valid only in the EU.)

Batteries are included in this product. This marking indicates they shall be sorted out and collected as ordained in the EU battery directive.

### Battery type:

Alkaline

When disposing of alkaline batteries, follow the domestic law concerning disposal. Take the proper action to dispose batteries in accordance with the established collection system in the European Economic Area. For the battery removal procedure, see page 26.

## Authorized Representative in the EEA

---

Yokogawa Europe B.V. is the authorized representative of Yokogawa Test & Measurement Corporation for this product in the EEA. To contact Yokogawa Europe B.V., see the separate list of worldwide contacts, PIM 113-01Z2.

# Contents

---

Product Registration.....	3	<b>Common Operations .....</b>	<b>29</b>
Checking the Contents of the Package.....	4	<b>Troubleshooting, Maintenance, and</b>	
Safety Precautions .....	7	<b>Inspection .....</b>	<b>32</b>
Conventions Used in This Guide.....	11	Troubleshooting .....	32
Waste Electrical and Electronic Equipment (WEEE),		Recommended Replacement Parts, Consumable Parts, and	
Directive .....	12	Calibration .....	33
EU Battery Directive.....	12	Disposing of the Instrument .....	33
Authorized Representative in the EEA.....	12	<b>Specifications.....</b>	<b>34</b>
<b>Names and Functions of Parts .....</b>	<b>14</b>	CA310 .....	34
Front Panel, Side Panel, and Rear Panel .....	14	CA320 .....	36
Keys .....	15	CA330 .....	46
Display .....	17	Common Specifications .....	49
<b>Making Preparations for Measurements.....</b>	<b>18</b>	External Dimensions .....	51
Handling Precautions .....	18		
Installing the Instrument.....	20		
Connecting Cables.....	23		
Using Thermocouple Mini Plugs (CA320 only) .....	25		
Installing and Removing Batteries.....	26		
Connecting the AC Adapter.....	27		
Turning the Power On and Off .....	28		

# Names and Functions of Parts

## Front Panel, Side Panel, and Rear Panel

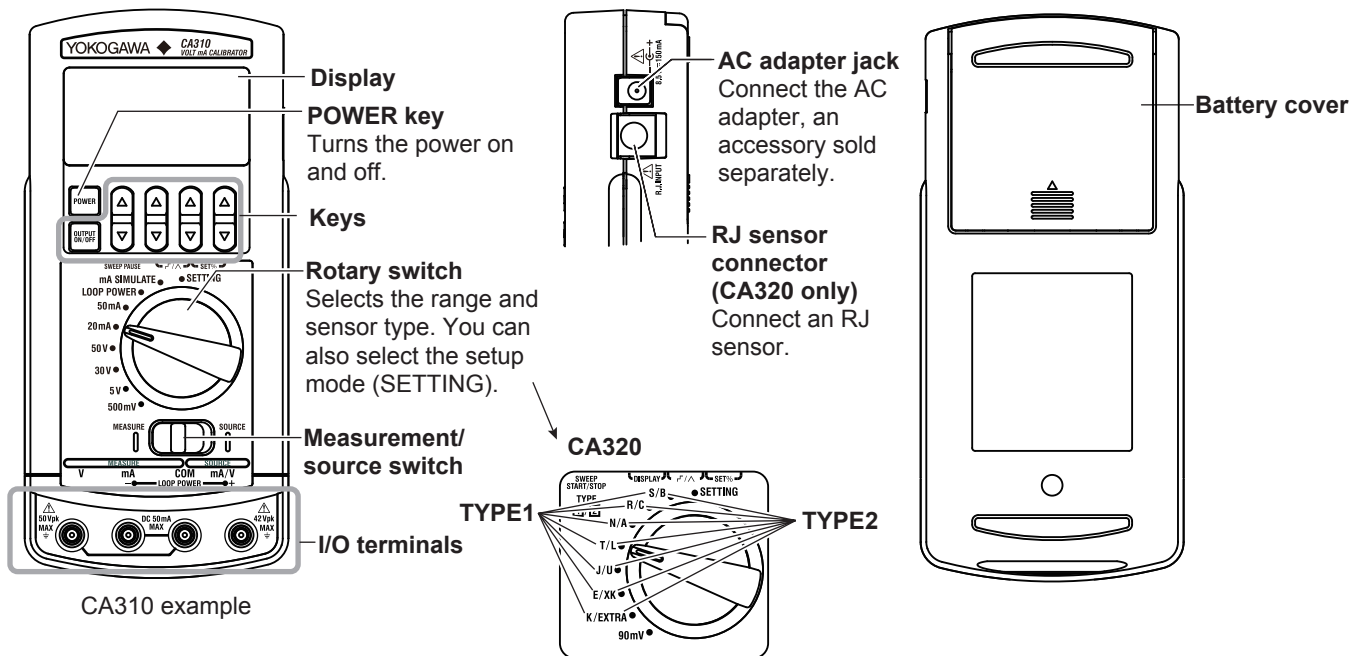

## Keys

## Source

## CA310

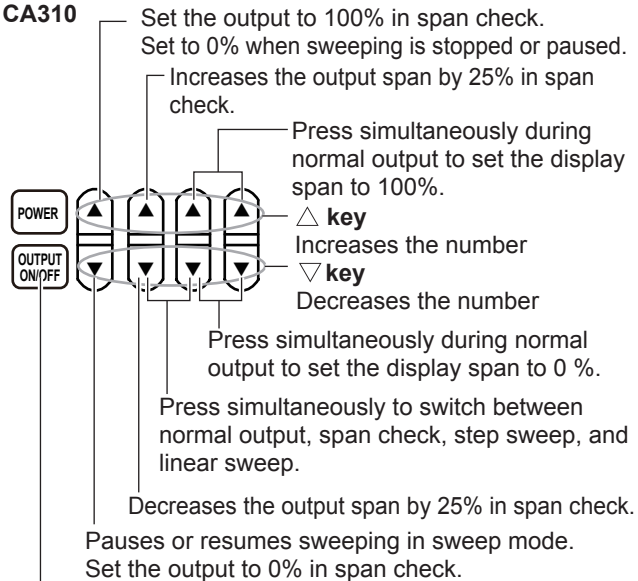
**OUTPUT ON/OFF key**

Turns the output on and off Starts or stops sweeping in sweep mode.

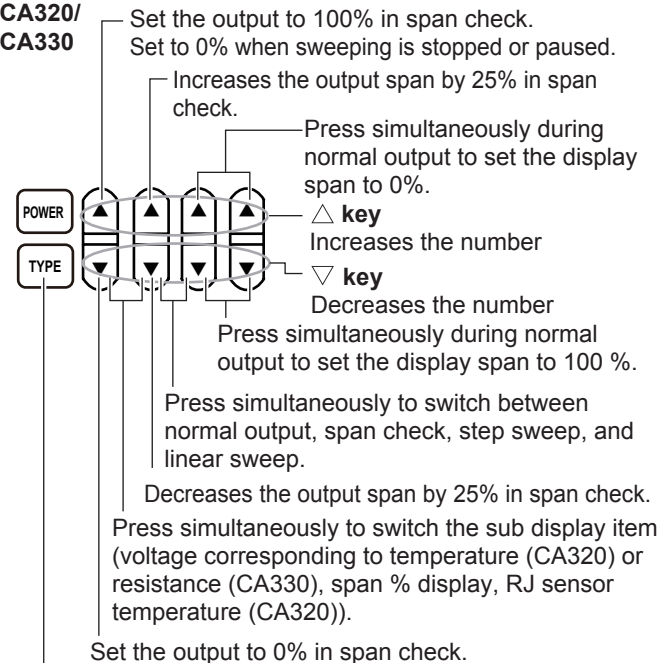
CA320/  
CA330**TYPE key**

Select the sensor.  
Stops or resumes sweeping in sweep mode.



Measurement

CA310

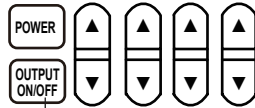

**OUTPUT ON/OFF key**

Turns LOOP POWER on and off if LOOP POWER is in use.

CA320/CA330

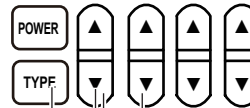

Press simultaneously to switch the sub display item (voltage corresponding to temperature, span % display, RJ sensor temperature (CA320)).

On the CA330, select the wiring system from 2W (two-wire), 3W (three-wire), and 4W (four-wire).

**TYPE key**

Select the sensor.

## Display

CA310

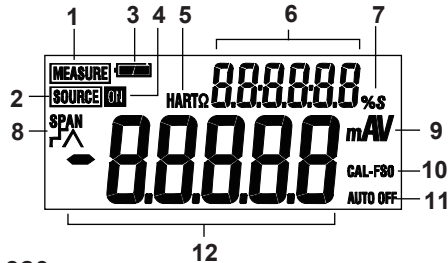

CA320

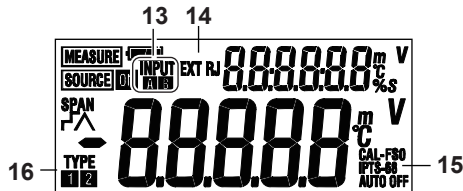

CA330

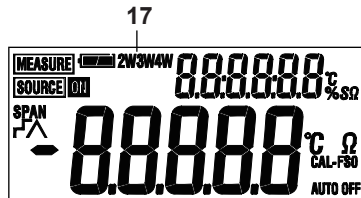

No.	Description
1	Appears in measurement mode
2	Appears in source mode
3	Battery level
4	Appears during sourcing (blinks when sweeping is paused)
5	Appears when the HART/BRAIN communication resistor is enabled*
6	Sub display. Displays options in setup mode.
7	Sub display unit
8	Output method Normal output (outputs the specified value): not displayed Span check (manual step): SPAN Step sweep: $\Gamma$ Linear sweep: $\wedge$
9	Main display unit
10	Calibration mode (not displayed normally)
11	Appears when auto power off is enabled
12	Main display
13	Selection status of the TC connection terminal When the thermocouple mini plug terminal is in use: A When the banana terminal is in use: B
14	RJ sensor setup mode RJ sensor off: not displayed When internal RJ sensor is set: RJ When external RJ sensor is set: EXT RJ
15	Appears when the temperature standard is set to IPTS-68
16	Sensor selection status based on the TYPE key
17	Wiring system. Two-wire: 2W, three-wire: 3W, four-wire: 4W

\* Appears only for LOOP POWER even when it is set to ON.

# Making Preparations for Measurements

## Handling Precautions

### Safety Precautions

If you are using this instrument for the first time, make sure to thoroughly read "Safety Precautions," on pages 7 to 10.

#### **Unplug If Abnormal Behavior Occurs**

If you notice smoke or unusual odors coming from the instrument, immediately turn off the power, remove the batteries if possible, and contact your nearest YOKOGAWA dealer.

### General Handling Precautions

#### **Do Not Place Objects on Top of the Instrument**

Never place objects such as other instruments or objects that contain water on top of the instrument. Doing so may damage the instrument.

#### **Do Not Subject the Inputs and Outputs to Mechanical Shock**

If the I/O connectors or adapters are subjected to mechanical shock, they may be damaged. The instrument may not perform measurements correctly due to damage or deformation that is not visible to the naked eye.

#### **Do Not Scratch the LCD**

Because the LCD can be easily scratched, do not allow any sharp objects near it. Also, do not apply vibration or shock to it. Furthermore, do not apply strong shock to the LCD or place objects on top of it.

#### **Remove the Batteries during Extended Non-Use**

Remove the batteries from the main unit. Remove the AC adapter power cord from the outlet.

#### **When Carrying the Instrument**

Remove the power cord and connecting cables.

#### **When Cleaning the Instrument**

When cleaning the case or the operation panel, gently wipe the outer surface using a damp, well-wrung, soft, clean cloth. The instrument can malfunction if water enters inside the instrument.

Do not use chemicals such as benzene or thinner. Doing so may cause discoloring and deformation.

### Other Precautions

- Keep electrically charged objects away from the input terminals. They may damage the internal circuitry.
- Do not cover the case or operation panel with a volatile material or leave rubber or vinyl products in contact with the case or operation panel for a long time.

### Storage Precautions

Avoid the following kinds of places for storing the instrument:

- Where the temperature falls outside the storage temperature and humidity ranges
- In direct sunlight or near heat sources
- In an environment with excessive amounts of soot, steam, dust, or corrosive gas
- In an environment subject to large levels of mechanical vibration
- On an unstable surface
- Where an excessive amount of soot, dust, salt, or iron is present

## Installing the Instrument

### **WARNING**

- Install the instrument so that you can immediately turn off the power if an abnormal or dangerous condition occurs.
- Do not use the instrument to measure locations that fall under Measurement Categories II, III, and IV.

### **CAUTION**

This instrument is equipped with voltage and current source and measurement features. Do not use the instrument when it is wet. Doing so may damage the instrument.

### French

### **AVERTISSEMENT**

- Installer l'instrument de manière à pouvoir immédiatement le débrancher du secteur en cas de fonctionnement anormal ou dangereux.
- N'utilisez pas cet équipement pour mesurer des points tombant sous les catégories de mesure II, III et IV.

### **ATTENTION**

Cet équipement est doté de fonctions de mesure et de source de courant et de tension. N'utilisez pas l'équipement lorsqu'il est mouillé. Le cas échéant, un endommagement de l'équipement risquerait de se produire.

## Installation Conditions

Install the instrument in a place that meets the following conditions.

- Operating Altitude and Ambient Temperature and Humidity
- Use the instrument in the following environment.
- Ambient temperature:  $-10^{\circ}\text{C}$  to  $55^{\circ}\text{C}$
- Ambient humidity: 20% RH to 80% RH; no condensation
- Operating altitude: 2000 m or less

### Note

---

- To ensure accurate use, operate the instrument within  $23^{\circ}\text{C} \pm 5^{\circ}\text{C}$ .
- When using the instrument in a place where the ambient humidity is 30% or less, take measures to prevent static electricity such as using an anti-static mat.
- Condensation may occur if the instrument is moved to another place where the ambient temperature or humidity is higher, or if the temperature changes rapidly.

In such cases, before you use the instrument, allow it to adjust to the surrounding temperature for at least an hour.

---

Do not install the instrument in the following places.

- In direct sunlight or near heat sources
- In an environment with excessive amounts of soot, steam, dust, or corrosive gas
- Near strong magnetic field sources
- Near noise sources, such as high-voltage equipment or power lines
- In an environment subject to large levels of mechanical vibration
- On an unstable surface
- In an environment where ignition or explosion may occur, such as in explosive gas

### Measurement Category

The measurement category of this instrument is Other (O).

Measurement Category	Description	Notes
O(None, Other)	Other circuits that are not directly connected to the mains.	Circuits that are not powered from the mains
CAT II	For measurements performed on circuits that are connected to low-voltage installations	Household appliances, portable tools, etc.
CAT III	For measuring facility circuits	Distribution boards, circuit breakers, etc.
CAT IV	For measurements performed on power source circuits	Entrance cables, cable systems, etc.

### Portable Case and Antiskid Rubber

#### How to Use the Portable Case

1. Unfasten the hook on the strap end and hooks on the sides of the case cover, and open the cover.
2. Rotate the case 180° around the hook on the company logo end of the case.

The hook on the company logo end cannot be unfastened.

3. Overlap the case cover over the bottom of the case, and fasten the hook on the strap end and hooks on the sides of the case cover.

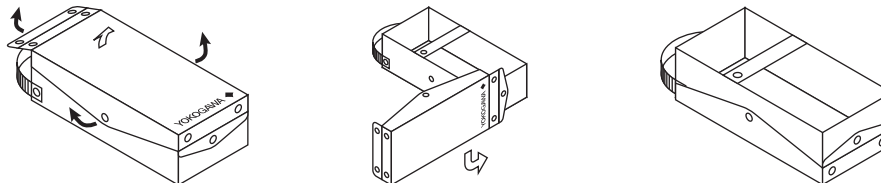

#### Antiskid rubber

Affix the included antiskid rubber to the location indicated in the following figure.

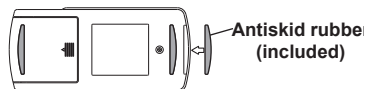

## Connecting Cables

To connect the CA310, use the included lead cable.  
**CA310 (measurement)**

500 mV, 5 V, 30 V, or 50 V range

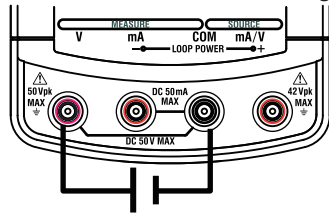

DC voltage source

20 mA or 50 mA range

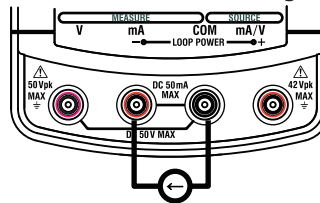

DC current source

LOOP POWER

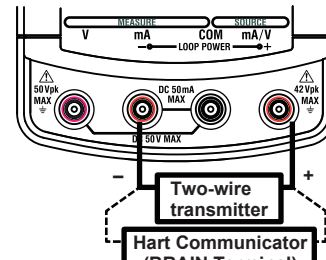

**CA310 (source)**

500 mV, 5 V, or 30 V range

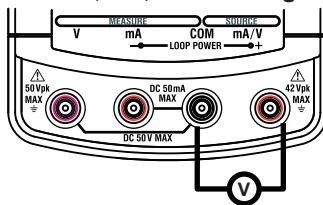

DC voltage measurement circuit

20 mA range

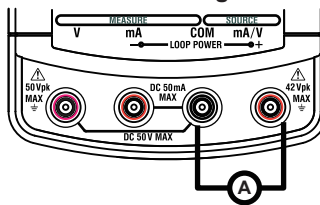

DC current measurement circuit

mA SIMULATE

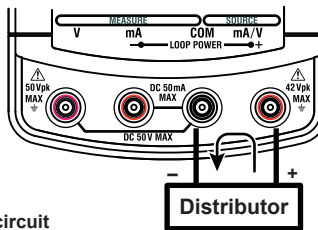

Distributor



## Making Preparations for Measurements

**CA320 (measurement)**  
Thermocouple mini plug terminal  
Banana terminal

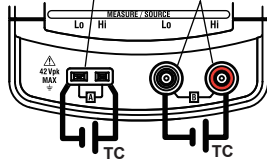

**CA320 (source)**  
Thermocouple mini plug terminal

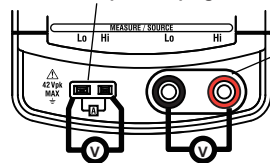

**Example of using a binding post\***  
Attach according to the terminal color.  
\*: Before using the binding post included with the CA320, remove the short bar from the binding post.

Thermocouple measurement circuit for temperature transmitter, temperature converter, etc.

\* The Lo banana terminal and the Lo thermocouple mini plug terminal are shorted internally.

**CA330 (measurement 4 W)**  
SENSE INPUT INPUT SEMSE  
(Hi) (Hi) (Lo) (Lo)

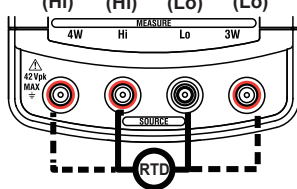

**CA330 (measurement 3 W)**  
SENSE INPUT INPUT SEMSE  
(Hi) (Hi) (Lo) (Lo)

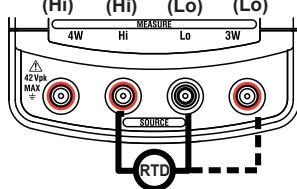

**CA330 (measurement 2 W)**  
SENSE INPUT INPUT SEMSE  
(Hi) (Hi) (Lo) (Lo)

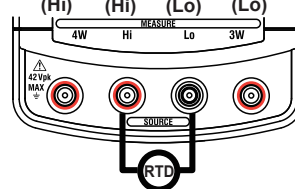

**CA330 (source)**

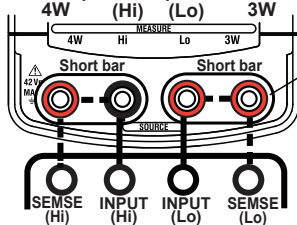

**Example of using a binding post**  
Attach according to the terminal color.

Resistance measurement terminal of temperature transmitter, temperature converter, etc.

## Using Thermocouple Mini Plugs (CA320 only)

The CA320's terminal A is a dedicated thermocouple mini plug terminal.

Using a thermocouple mini plug enables higher accuracy and more stable thermocouple measurement and sourcing than a banana terminal.

Use the same type of thermocouple mini plug as the plug on the item to be calibrated (thermocouple or range of the device to be calibrated).

(Use the thermocouple mini plug set 90040 or 90045 or a thermocouple mini plug that you prepared.)

To connect the plug and the item to be calibrated, use the same type of thermocouple or compensating lead wire as that used on the item to be calibrated. (Prepare your own thermocouple or compensating lead wires.)

When terminal A is in use, reference junction compensation based on the internal temperature sensor is applied.

## Installing and Removing Batteries



### WARNING

- Do not remove the batteries with the main unit turned on.
- Never replace the batteries while measurement is in progress.
- Insert batteries with the correct polarity. Otherwise, the batteries may leak, heat up, or burst.
- Do not mix new and old batteries or mix different brands or types of batteries. The batteries may leak, heat up, or burst due to their characteristic differences.
- When replacing batteries, be sure to remove the lead cables.

### French



### AVERTISSEMENT

- Ne retirez pas les piles lorsque le boîtier principal est en marche.
- Ne jamais remplacer les batteries lorsque la mesure est en cours.
- Insérer les batteries en observant la polarité correcte. A défaut, les batteries risquent de fuir, de chauffer ou d'éclater.
- Ne pas mélanger des batteries neuves et des batteries usagées, ni des batteries de marques ou de types différents. Les batteries risquent de fuir, de chauffer ou d'éclater en raison de leurs différentes caractéristiques.
- Lors du remplacement des batteries, veuillez à retirer les câbles de plomb.

1. Turn the power off.
2. Push the battery cover on the rear panel in the direction of the arrow, and open the cover.
3. Remove the old batteries, and insert new batteries with the correct polarities.
4. Attach the battery cover. Close the cover completely until you hear a click.

## Connecting the AC Adapter



### WARNING

- Do not connect or remove the AC adapter with the main unit turned on.
- Only use the dedicated AC adapter for the instrument.
- Do not place objects on top of the AC adapter or power cord, and keep them away from heat sources. When removing the plug from the power outlet, do not pull on the cord. Pull from the plug.
- For details on handling the AC adapter, follow the instruction manual of the AC adapter.

### French



### AVERTISSEMENT

- Ne branchez pas ni ne débranchez l'adaptateur c.a. lorsque le boîtier principal est en marche.
- Utiliser uniquement l'adaptateur de CA dédié et le câble d'alimentation de cet instrument.
- Ne posez pas d'objets sur l'adaptateur c.a. ni sur le cordon d'alimentation, et maintenez ces derniers à l'écart de toute source de chaleur. Ne tirez pas sur le cordon d'alimentation lorsque vous débranchez la prise de la source d'alimentation. Tirez sur la prise.
- Pour des détails sur l'utilisation de l'adaptateur c.a., consultez le mode d'emploi de l'adaptateur c.a.

1. Turn the power off.
2. Connect the AC adapter's DC cable to the AC adapter jack on the instrument's side panel.
3. Connect the AC adapter to an AC power supply.

### Turning the Power On and Off

#### Before Turning On the Power, Check That:

- The instrument is installed properly. See “Installing the Instrument.”
- The batteries are inserted properly. See “Installing and Removing Batteries.”

#### Turning the Power On

1. Hold down the **POWER** key on the front panel.

#### Power-On Operation

When the power is turned on, a memory check starts automatically.

If the instrument does not power on properly, turn the power off, and check that:

- The dry cells are inserted properly.
- New and old dry cells are not being used together.
- Batteries of different types or different brands are being used together.

If the instrument still does not work properly, contact your nearest YOKOGAWA dealer for repairs.

#### Turning the Power Off

1. Hold down the **POWER** key until OFF appears.

# Common Operations

## Selecting the Range and Sensor

Use the rotary switch to select the range and sensor.

On the CA320, use the **TYPE** key to select TYPE1 or TYPE2.

On the CA330, if you select PT100 and EXTRA, use the **TYPE** key to select the sensor type.

## Switching between MEASURE (Measurement mode) and SOURCE (Source Mode)

Use the measure/source switch to select MEASURE (measurement mode) or SOURCE (source mode).

### Note

- On the CA320 or CA330, if you select SOURCE, the display shows ON, and output starts.
- On the CA310, if you select SOURCE, use the **OUTPUT ON/OFF** key to turn the output on. The display shows ON, and voltage or current is output.

## Setting the Output Value

Set the output value in source mode.

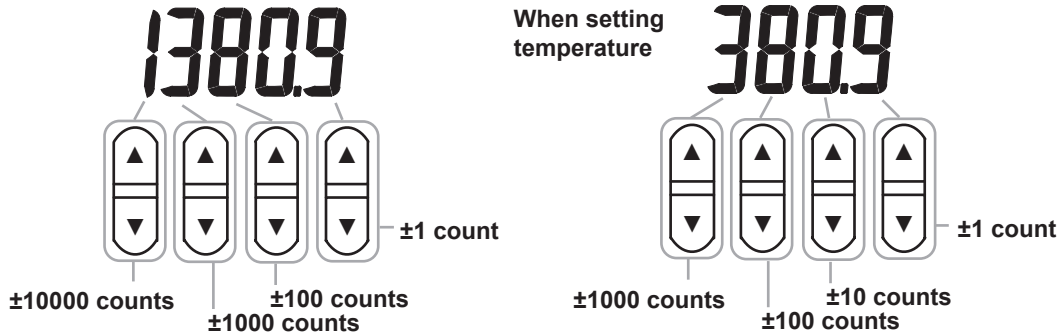

### Setting the Output Mode

There are four output modes: normal output, span check, step sweep, and linear sweep. Press the  $\nabla$  keys simultaneously in the following figure to select normal output (no display), **SPAN** (span check),  $\Gamma$  (step sweep),  $\wedge$  (linear sweep).

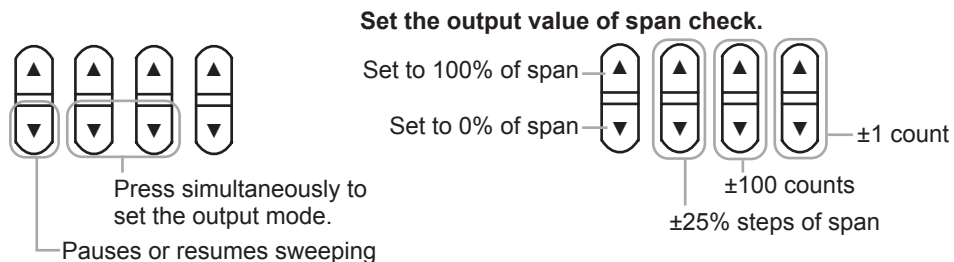

On the CA310, press the **OUTPUT ON/OFF** key to start or stop sweeping. On the CA320/CA330, press the **TYPE** key to do the same. When sweeping is stopped or paused, you can press the left-most  $\triangle$  key to set the output span to 0%.

### **CAUTION**

Be careful that the output value does not exceed the allowable input value of the target device.

### French

### **ATTENTION**

Veillez à éviter que la valeur de sortie ne dépasse la tolérance d'entrée de la cible de sortie.

## Configuring the Instrument

Use the rotary switch to select SETTING.

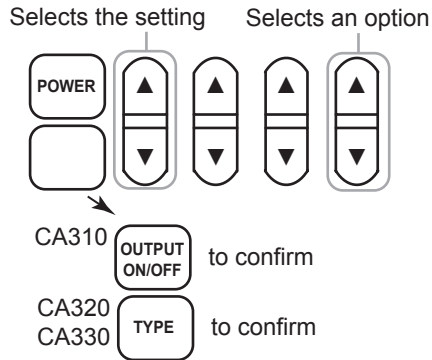

Disp.	Setting	Options	CA310	CA320	CA330
<b>A OFF</b>	Auto power-off	ON*/OFF	✓	✓	✓
<b>LIGHT</b>	Backlight	ON/OFF*/TIMER	✓	✓	✓
<b>SWEEP</b>	Sweep time	15s*/30s/45s/60s	✓	✓	✓
<b>HART</b>	HART BRAIN communication resistance	ON/OFF*	✓	—	—
<b>INPUT</b>	Temp. measurement/source terminal	A*/B	—	✓	—
<b>RJ45</b>	RJ sensor (banana terminal)	ON*/OFF	—	✓	—
<b>BOUL</b>	Burnout detection	ON*/OFF	—	✓	—
<b>TEMP</b>	Temperature reference	ITS-90*/IPTS-68	—	✓	—
<b>EXT</b>	Extended sensor	D*/G/PL2	—	✓	—
<b>SPAN</b>	Initializes the span setting	—	✓	✓	✓
<b>CONF</b>	Initializes the settings	—	✓	✓	✓

\*: Default value



# Troubleshooting, Maintenance, and Inspection

## Troubleshooting

### Faults and Corrective Actions

If servicing is necessary, or if the instrument does not operate properly even after you have attempted to deal with the problem according to the instructions in this section, contact your nearest YOKOGAWA dealer.

Problems and Solutions		Reference Page
The power does not turn on.	Check that the remaining battery power is sufficient.	17
	Check that the batteries are inserted correctly.	26
The power turns off.	Check that the remaining battery power is sufficient.	17
The screen is dark.	Turn the backlight on.	31
The screen turns off.	Set auto power-off to OFF.	31
The display is odd.	Confirm that the ambient temperature and humidity are within their specified ranges.	21
	Confirm that the display is not being affected by noise.	21
	Restart the instrument.	28
The measured or source value is odd.	Check that the remaining battery power is sufficient.	17
	Check that the measurement/source switch is set properly.	29
	Check that connections are correct.	23, 24
	Confirm that the ambient temperature and humidity are within their specified ranges.	21
	When using the included binding post on the CA320, check that the short bar has been removed.	24

Problems and Solutions		Reference Page
“Err60” appears at power-on.	This indicates that the settings have been initialized due to an error in the setting information stored in the CA310, CA320, or CA330. If the error appears every time at power-on, repair is necessary.	-
“Err61” and “Err63” appear at power-on.	There is an error in the calibration data stored in the CA310, CA320, or CA330. If the error appears every time at power-on, repair is necessary.	-
“Err30” appears when the span 0% or span 100% value is set.	If the span 0% value is set greater than or equal to the span 100% value, an error occurs. Set to a value less than the span 100% value. If the span 100% value is set less than or equal to the span 0% value, an error occurs. Set to a value greater than the span 0% value.	15

## Recommended Replacement Parts, Consumable Parts, and Calibration

### Recommended Replacement Parts, Consumable Parts, and Calibration

#### Recommended Replacement Parts and Consumable Parts

YOKOGAWA guarantees the instrument for the period and under the conditions of the product warranty.  
All parts of this instrument are covered by the one-year warranty.

#### Calibration

To ensure accurate measurement, we recommend periodic calibration.  
Recommended calibration period: 1 year

## Disposing of the Instrument

When disposing of the instrument, follow the laws and ordinances of your country or region.

# Specifications

## CA310

### Measurement Specifications

Function	Range	Measurement Range	Resolution	Accuracy (1 year)		Notes
				of Reading	Offset	
Voltage	500 mV	0.00 to $\pm 550.00$ mV	10 $\mu$ V	0.015%	50 $\mu$ V	Input resistance: Approx. 1 M $\Omega$
	5 V	0.0000 to $\pm 5.5000$ V	0.1 mV	0.015%	0.5 mV	Input resistance: Approx. 1 M $\Omega$
	30 V	0.000 to $\pm 33.000$ V	1 mV	0.015%	5 mV	Input resistance: Approx. 1 M $\Omega$
	50 V	0.000 to $\pm 55.000$ V	1 mV	0.015%	5 mV	Input resistance: Approx. 1 M $\Omega$
Current	20 mA	0.000 to $\pm 24.000$ mA	1 $\mu$ A	0.015%	3 $\mu$ A	Input resistance: 10 $\Omega$ or lower
	50 mA	0.000 to $\pm 60.000$ mA	1 $\mu$ A	0.015%	3 $\mu$ A	Input resistance: 10 $\Omega$ or lower
LOOP POWER	20 mA	0.000 to +24.000 mA	1 $\mu$ A	0.015%	3 $\mu$ A	
	Supply voltage: 24 V $\pm$ 1 V (when HART communication resistance is off. Maximum load current: 24 mA) 24 V $\pm$ 6 V (when HART communication resistance is on. Maximum load current: 20 mA)					

At the ambient temperature ( $T_a$ ) of +23°C $\pm$ 5°C.

For the accuracies of other ambient temperature ranges ( $T_a < 18^\circ\text{C}$ ,  $T_a > 28^\circ\text{C}$ ), add the temperature coefficient 0.005% of Range/ $^\circ\text{C}$ .

CMRR	Approx. 120 dB (50/60 Hz)
NMRR	Approx. 60 dB (50/60 Hz)
Measurement terminal maximum input	Voltage terminals 50 VDC Current terminals 50 mADC
Current terminal input protection	PTC protection
Measurement display update rate	Approx. 1 s
Measurement terminal voltage to ground	50 Vpeak

## Source Specifications

Function	Range	Source Range	Resolution	Accuracy (1 year)		Notes
				of Setting	Offset	
Voltage	500 mV	0.00 to +550.00 mV	10 $\mu$ V	0.015%	50 $\mu$ V	Maximum output current: 10 mA
	5 V	0.0000 to +5.5000 V	0.1 mV	0.015%	0.5 mV	Maximum output current: 10 mA
	30 V	0.000 to +33.000 V	1 mV	0.015%	5 mV	Maximum output current: 1 mA
Current	20 mA	0.000 to +24.000 mA	1 $\mu$ A	0.015%	3 $\mu$ A	Compliance voltage: +24 V
	20 mA SIMULATE	0.000 to +24.000 mA	1 $\mu$ A	0.015%	3 $\mu$ A	External power supply: +5 V to +28 V

At the ambient temperature ( $T_a$ ) of +23°C  $\pm$ 5°C.

For the accuracies of other ambient temperature ranges ( $T_a < 18^\circ\text{C}$ ,  $T_a > 28^\circ\text{C}$ ), add the temperature coefficient 0.005% of Range/ $^\circ\text{C}$ .

Source section voltage limiter	Approx. 36 V
Source section current limiter	Approx. 30 mA
Sweep function	Step (25%)/linear
Step time	15 s, 30 s, 45 s, 60 s
Maximum load	$C \leq 0.1 \mu\text{F}$ , $L \leq 10 \text{ mH}$
Output resistance	10 m $\Omega$ or less
Output response	300 ms or less
Source terminal voltage to ground	42 V <sub>peak</sub>

CA320

TC Source/Measurement Specifications

Using Terminal A (Thermocouple Plug Terminal), Reference Junction Compensation Based on Internal Temperature Sensor (t: measurement/source temperature)

Thermocouple	Accuracy (1 year)			Specification
	Temperature Range	Source Accuracy [°C]	Measurement Accuracy [°C]	
K	-200.0°C ≤ t < 0.0°C	0.5+ t  x 0.3%	0.5+ t  x 0.3%	IEC60584-1 JIS C1602
	0.0°C ≤ t < +500.0°C	0.5	0.5	
	+500.0°C ≤ t ≤ +1372.0°C	0.5+(t-500) x 0.03%	0.5+(t-500) x 0.02%	
E	-250.0°C ≤ t < -200.0°C	1.1+( t -200) x 2.0%	1.1+( t -200) x 2.0%	IEC60584-1
	-200.0°C ≤ t < 0.0°C	0.5+ t  x 0.3%	0.5+ t  x 0.3%	
	0.0°C ≤ t < +500.0°C	0.5	0.5	
J	+500.0°C ≤ t ≤ +1000.0°C	0.5+(t-500) x 0.02%	0.5+(t-500) x 0.02%	IEC60584-1
	-210.0°C ≤ t < 0.0°C	0.5+ t  x 0.3%	0.5+ t  x 0.3%	
	0.0°C ≤ t ≤ +1200.0°C	0.5+t x 0.02%	0.5+t x 0.02%	
T	-250.0°C ≤ t < -200.0°C	1.1+( t -200) x 2.5%	1.1+( t -200) x 2.5%	IEC60584-1
	-200.0°C ≤ t < 0.0°C	0.5+ t  x 0.3%	0.5+ t  x 0.3%	
	0.0°C ≤ t ≤ +400.0°C	0.5	0.5	
N	-200.0°C ≤ t < 0.0°C	0.6+ t  x 0.4%	0.6+ t  x 0.3%	IEC60584-1
	0.0°C ≤ t ≤ +1300.0°C	0.6	0.6	
L	-200.0°C ≤ t < 0.0°C	0.5+ t  x 0.15%	0.5+ t  x 0.15%	DIN 43710
	0.0°C ≤ t ≤ +900.0°C	0.5	0.5	
U	-200.0°C ≤ t < 0.0°C	0.5+ t  x 0.2%	0.5+ t  x 0.2%	DIN 43710
	0.0°C ≤ t ≤ +600.0°C	0.5	0.5	
R	-20.0°C ≤ t < 0.0°C	2.0	2.0	IEC60584-1
	0.0°C ≤ t < +100.0°C	2.0	1.4	
	+100.0°C ≤ t ≤ +1767.0°C	1.4	1.4	

Thermocouple		Accuracy (1 year)			Specification
		Temperature Range	Source Accuracy [°C]	Measurement Accuracy [°C]	
S		$-20.0^{\circ}\text{C} \leq t < 0.0^{\circ}\text{C}$	2.0	2.0	IEC60584-1
		$0.0^{\circ}\text{C} \leq t < +100.0^{\circ}\text{C}$	2.0	1.4	
		$+100.0^{\circ}\text{C} \leq t \leq +1768.0^{\circ}\text{C}$	1.4	1.4	
B		$+600.0^{\circ}\text{C} \leq t < +800.0^{\circ}\text{C}$	1.2	1.5	IEC60584-1
		$+800.0^{\circ}\text{C} \leq t < +1000.0^{\circ}\text{C}$	1.0	1.2	
		$+1000.0^{\circ}\text{C} \leq t \leq +1820.0^{\circ}\text{C}$	1.0	1.1	
C		$0.0^{\circ}\text{C} \leq t < +1000.0^{\circ}\text{C}$	0.8	0.8	IEC60584-1
		$+1000.0^{\circ}\text{C} \leq t \leq +2315.0^{\circ}\text{C}$	$0.8+(t-1000) \times 0.06\%$	$0.8+(t-1000) \times 0.06\%$	
XK		$-200.0^{\circ}\text{C} \leq t < 0.0^{\circ}\text{C}$	$0.4+ t  \times 0.2\%$	$0.4+ t  \times 0.2\%$	GOST R 8.585-2001
		$0.0^{\circ}\text{C} \leq t < +300.0^{\circ}\text{C}$	0.4	0.4	
		$+300.0^{\circ}\text{C} \leq t \leq +800.0^{\circ}\text{C}$	0.5	0.5	
A		$0.0^{\circ}\text{C} \leq t < +1000.0^{\circ}\text{C}$	1.0	1.0	IEC60584-1
		$+1000.0^{\circ}\text{C} \leq t \leq +2500.0^{\circ}\text{C}$	$1.0+(t-1000) \times 0.06\%$	$1.0+(t-1000) \times 0.06\%$	
Extra TC	D (W3Re/ W25Re)	$0.0^{\circ}\text{C} \leq t < +300.0^{\circ}\text{C}$	1.4	1.8	ASTM E1751/E1751M-09e1
		$+300.0^{\circ}\text{C} \leq t < +1500.0^{\circ}\text{C}$	1.2	1.2	
		$+1500.0^{\circ}\text{C} \leq t \leq +2315.0^{\circ}\text{C}$	1.8	2.2	
	G (W/W26Re)	$+100.0^{\circ}\text{C} \leq t < +300.0^{\circ}\text{C}$	1.4	1.8	ASTM E1751/E1751M-09e1
		$+300.0^{\circ}\text{C} \leq t < +1500.0^{\circ}\text{C}$	1.2	1.2	
		$+1500.0^{\circ}\text{C} \leq t \leq +2315.0^{\circ}\text{C}$	1.8	2.2	
	PLATINEL II	$0.0^{\circ}\text{C} \leq t < +100.0^{\circ}\text{C}$	0.6	1.8	ASTM E1751/E1751M-09e1
		$+100.0^{\circ}\text{C} \leq t < +1000.0^{\circ}\text{C}$	0.8	1.8	
		$+1000.0^{\circ}\text{C} \leq t \leq +1395.0^{\circ}\text{C}$	1.0	2.2	

These do not include thermocouple errors.

At an ambient temperature (Ta) of 23±5°C, using the internal reference junction compensation function. For the accuracies of other ambient temperatures (Ta<18°C, Ta>28°C), add the temperature coefficient 0.05°C/°C.

Source/measured value display resolution: 0.1°C

The temperature of the thermocouple plug is balanced with the ambient temperature.

**Using Terminal B (Banana Terminal), Reference Junction Compensation Based on Internal Temperature Sensor (t: measurement/source temperature)**

Thermocouple	Accuracy (1 year)			Specification
	Temperature Range	Source Accuracy [°C]	Measurement Accuracy [°C]	
K	-200.0°C ≤ t < 0.0°C	1.0+ t  x 0.75%	1.0+ t  x 0.75%	IEC60584-1 JIS C1602
	0.0°C ≤ t < +500.0°C	1.0	1.0	
	+500.0°C ≤ t ≤ +1372.0°C	1.0+(t-500) x 0.04%	1.0+(t-500) x 0.04%	
E	-250.0°C ≤ t < -200.0°C	2.0+( t -200) x 7.0%	2.0+( t -200) x 7.0%	IEC60584-1
	-200.0°C ≤ t < 0.0°C	1.0+ t  x 0.5%	1.0+ t  x 0.5%	
	0.0°C ≤ t < +500.0°C	1.0	1.0	
J	+500.0°C ≤ t ≤ +1000.0°C	1.0	1.0	IEC60584-1
	-210.0°C ≤ t < 0.0°C	1.0+ t  x 0.5%	1.0+ t  x 0.5%	
T	0.0°C ≤ t ≤ +1200.0°C	1.0+t x 0.02%	1.0+t x 0.02%	IEC60584-1
	-250.0°C ≤ t < -200.0°C	2.5+( t -200) x 7.0%	2.5+( t -200) x 7.0%	
N	-200.0°C ≤ t < 0.0°C	1+ t  x 0.75%	1+ t  x 0.75%	IEC60584-1
	0.0°C ≤ t ≤ +400.0°C	1.0	1.0	
L	-200.0°C ≤ t < 0.0°C	1.0+ t  x 0.75%	1.0+ t  x 0.75%	DIN 43710
	0.0°C ≤ t ≤ +900.0°C	1.0	1.0	
U	-200.0°C ≤ t < 0.0°C	1.0+ t  x 0.2%	1.0+ t  x 0.2%	DIN 43710
	0.0°C ≤ t ≤ +600.0°C	1.0	1.0	
R	-200.0°C ≤ t < 0.0°C	1.0+ t  x 0.3%	1.0+ t  x 0.3%	IEC60584-1
	0.0°C ≤ t < +100.0°C	1.6+ t-100  x 0.5%	1.6+ t-100  x 0.5%	
	+100.0°C ≤ t ≤ +1767.0°C	1.6	1.6	
S	-20.0°C ≤ t < 0.0°C	1.6+ t-100  x 0.5%	1.6+ t-100  x 0.5%	IEC60584-1
	0.0°C ≤ t < +100.0°C	1.6+ t-100  x 0.5%	1.6+ t-100  x 0.5%	
	+100.0°C ≤ t ≤ +1768.0°C	1.6	1.6	

Thermocouple		Accuracy (1 year)			Specification
		Temperature Range	Source Accuracy [°C]	Measurement Accuracy [°C]	
B		$+600.0^{\circ}\text{C} \leq t < +800.0^{\circ}\text{C}$	1.2	1.5	IEC60584-1
		$+800.0^{\circ}\text{C} \leq t < +1000.0^{\circ}\text{C}$	1.0	1.2	
		$+1000.0^{\circ}\text{C} \leq t \leq +1820.0^{\circ}\text{C}$	1.0	1.1	
C		$0.0^{\circ}\text{C} \leq t < +1000.0^{\circ}\text{C}$	1.3	1.3	IEC60584-1
		$+1000.0^{\circ}\text{C} \leq t \leq +2315.0^{\circ}\text{C}$	$1.3+(t-1000) \times 0.08\%$	$1.3+(t-1000) \times 0.08\%$	
XK		$-200.0^{\circ}\text{C} \leq t < 0.0^{\circ}\text{C}$	$1.0+ t  \times 0.5\%$	$1.0+ t  \times 0.5\%$	GOST R 8.585-2001
		$0.0^{\circ}\text{C} \leq t < +300.0^{\circ}\text{C}$	1.0	1.0	
		$+300.0^{\circ}\text{C} \leq t \leq +800.0^{\circ}\text{C}$	1.0	1.0	
A		$0.0^{\circ}\text{C} \leq t < +1000.0^{\circ}\text{C}$	1.5	1.5	IEC60584-1
		$+1000.0^{\circ}\text{C} \leq t \leq +2500.0^{\circ}\text{C}$	$1.5+(t-1000) \times 0.08\%$	$1.5+(t-1000) \times 0.08\%$	
Extra TC	D (W3Re/ W25Re)	$0.0^{\circ}\text{C} \leq t < +300.0^{\circ}\text{C}$	1.4	1.8	ASTM E1751/E1751M-09e1
		$+300.0^{\circ}\text{C} \leq t < +1500.0^{\circ}\text{C}$	1.2	1.2	
		$+1500.0^{\circ}\text{C} \leq t \leq +2315.0^{\circ}\text{C}$	1.8	2.2	
	G (W/W26Re)	$+100.0^{\circ}\text{C} \leq t < +300.0^{\circ}\text{C}$	1.4	1.8	ASTM E1751/E1751M-09e1
		$+300.0^{\circ}\text{C} \leq t < +1500.0^{\circ}\text{C}$	1.2	1.2	
		$+1500.0^{\circ}\text{C} \leq t \leq +2315.0^{\circ}\text{C}$	1.8	2.2	
	PLATINEL II	$0.0^{\circ}\text{C} \leq t < +100.0^{\circ}\text{C}$	1.0	1.8	ASTM E1751/E1751M-09e1
		$+100.0^{\circ}\text{C} \leq t < +1000.0^{\circ}\text{C}$	1.0	1.8	
		$+1000.0^{\circ}\text{C} \leq t \leq +1395.0^{\circ}\text{C}$	1.2	2.2	

These do not include thermocouple errors.

At an ambient temperature ( $T_a$ ) of  $23 \pm 5^{\circ}\text{C}$ , using the internal reference junction compensation function. For the accuracies of other ambient temperatures ( $T_a < 18^{\circ}\text{C}$ ,  $T_a > 28^{\circ}\text{C}$ ), add the temperature coefficient  $0.05^{\circ}\text{C}/^{\circ}\text{C}$ .

Source/measured value display resolution:  $0.1^{\circ}\text{C}$

The temperature of the terminals or binding post is balanced with the ambient temperature.



**Using Terminal B (Banana Terminal), Reference Junction Compensation Based on External RJ Sensor (sold separately)  
(t: measurement/source temperature)**

Thermocouple	Accuracy (1 year)			Specification
	Temperature Range	Source Accuracy [°C]	Measurement Accuracy [°C]	
K	$-200.0^{\circ}\text{C} \leq t < 0.0^{\circ}\text{C}$	$0.7+ t  \times 0.4\%$	$0.7+ t  \times 0.4\%$	IEC60584-1 JIS C1602
	$0.0^{\circ}\text{C} \leq t < +500.0^{\circ}\text{C}$	0.7	0.7	
	$+500.0^{\circ}\text{C} \leq t \leq +1372.0^{\circ}\text{C}$	$0.7+(t-500) \times 0.03\%$	$0.7+(t-500) \times 0.03\%$	
E	$-250.0^{\circ}\text{C} \leq t < -200.0^{\circ}\text{C}$	$1.3+( t -200) \times 5.0\%$	$1.3+( t -200) \times 5.0\%$	IEC60584-1
	$-200.0^{\circ}\text{C} \leq t < 0.0^{\circ}\text{C}$	$0.7+ t  \times 0.3\%$	$0.7+ t  \times 0.3\%$	
	$0.0^{\circ}\text{C} \leq t < +500.0^{\circ}\text{C}$	0.7	0.7	
	$+500.0^{\circ}\text{C} \leq t \leq +1000.0^{\circ}\text{C}$	$0.7+(t-500) \times 0.02\%$	$0.7+(t-500) \times 0.02\%$	
J	$-210.0^{\circ}\text{C} \leq t < 0.0^{\circ}\text{C}$	$0.7+ t  \times 0.3\%$	$0.7+ t  \times 0.3\%$	IEC60584-1
	$0.0^{\circ}\text{C} \leq t \leq +1200.0^{\circ}\text{C}$	$0.7+t \times 0.02\%$	$0.7+t \times 0.02\%$	
T	$-250.0^{\circ}\text{C} \leq t < -200.0^{\circ}\text{C}$	$1.7+( t -200) \times 5.0\%$	$1.7+( t -200) \times 5.0\%$	IEC60584-1
	$-200.0^{\circ}\text{C} \leq t < 0.0^{\circ}\text{C}$	$0.7+ t  \times 0.5\%$	$0.7+ t  \times 0.5\%$	
	$0.0^{\circ}\text{C} \leq t \leq +400.0^{\circ}\text{C}$	0.7	0.7	
N	$-200.0^{\circ}\text{C} \leq t < 0.0^{\circ}\text{C}$	$0.8+ t  \times 0.5\%$	$0.8+ t  \times 0.5\%$	IEC60584-1
	$0.0^{\circ}\text{C} \leq t \leq +1300.0^{\circ}\text{C}$	0.8	0.8	
L	$-200.0^{\circ}\text{C} \leq t < 0.0^{\circ}\text{C}$	$0.7+ t  \times 0.15\%$	$0.7+ t  \times 0.15\%$	DIN 43710
	$0.0^{\circ}\text{C} \leq t \leq +900.0^{\circ}\text{C}$	0.7	0.7	
U	$-200.0^{\circ}\text{C} \leq t < 0.0^{\circ}\text{C}$	$0.7+ t  \times 0.3\%$	$0.7+ t  \times 0.3\%$	DIN 43710
	$0.0^{\circ}\text{C} \leq t \leq +600.0^{\circ}\text{C}$	0.7	0.7	
R	$-20.0^{\circ}\text{C} \leq t < 0.0^{\circ}\text{C}$	$1.4+ t-100  \times 0.5\%$	$1.4+ t-100  \times 0.5\%$	IEC60584-1
	$0.0^{\circ}\text{C} \leq t < +100.0^{\circ}\text{C}$	$1.4+ t-100  \times 0.5\%$	$1.4+ t-100  \times 0.5\%$	
	$+100.0^{\circ}\text{C} \leq t \leq +1767.0^{\circ}\text{C}$	1.4	1.4	
S	$-20.0^{\circ}\text{C} \leq t < 0.0^{\circ}\text{C}$	$1.4+ t-100  \times 0.5\%$	$1.4+ t-100  \times 0.5\%$	IEC60584-1
	$0.0^{\circ}\text{C} \leq t < +100.0^{\circ}\text{C}$	$1.4+ t-100  \times 0.5\%$	$1.4+ t-100  \times 0.5\%$	
	$+100.0^{\circ}\text{C} \leq t \leq +1768.0^{\circ}\text{C}$	1.4	1.4	

Thermocouple		Accuracy (1 year)			Specification
		Temperature Range	Source Accuracy [°C]	Measurement Accuracy [°C]	
B		$+600.0^{\circ}\text{C} \leq t < +800.0^{\circ}\text{C}$	1.2	1.5	IEC60584-1
		$+800.0^{\circ}\text{C} \leq t < +1000.0^{\circ}\text{C}$	1.0	1.2	
		$+1000.0^{\circ}\text{C} \leq t \leq +1820.0^{\circ}\text{C}$	1.0	1.1	
C		$0.0^{\circ}\text{C} \leq t < +1000.0^{\circ}\text{C}$	1.0	1.0	IEC60584-1
		$+1000.0^{\circ}\text{C} \leq t \leq +2315.0^{\circ}\text{C}$	$1.0+(t-1000) \times 0.08\%$	$1.0+(t-1000) \times 0.08\%$	
XK		$-200.0^{\circ}\text{C} \leq t < 0.0^{\circ}\text{C}$	$0.6+ t  \times 0.3\%$	$0.6+ t  \times 0.3\%$	GOST R 8.585-2001
		$0.0^{\circ}\text{C} \leq t < +300.0^{\circ}\text{C}$	0.6	0.6	
		$+300.0^{\circ}\text{C} \leq t \leq +800.0^{\circ}\text{C}$	0.7	0.7	
A		$0.0^{\circ}\text{C} \leq t < +1000.0^{\circ}\text{C}$	1.2	1.2	IEC60584-1
		$+1000.0^{\circ}\text{C} \leq t \leq +2500.0^{\circ}\text{C}$	$1.2+(t-1000) \times 0.006\%$	$1.2+(t-1000) \times 0.006\%$	
Extra TC	D (W3Re/ W25Re)	$0.0^{\circ}\text{C} \leq t < +300.0^{\circ}\text{C}$	1.4	1.8	ASTM E1751/E1751M-09e1
		$+300.0^{\circ}\text{C} \leq t < +1500.0^{\circ}\text{C}$	1.2	1.2	
		$+1500.0^{\circ}\text{C} \leq t \leq +2315.0^{\circ}\text{C}$	1.8	2.2	
	G (W/W26Re)	$+100.0^{\circ}\text{C} \leq t < +300.0^{\circ}\text{C}$	1.4	1.8	ASTM E1751/E1751M-09e1
		$+300.0^{\circ}\text{C} \leq t < +1500.0^{\circ}\text{C}$	1.2	1.2	
		$+1500.0^{\circ}\text{C} \leq t \leq +2315.0^{\circ}\text{C}$	1.8	2.2	
	PLATINEL II	$0.0^{\circ}\text{C} \leq t < +100.0^{\circ}\text{C}$	0.6	1.8	ASTM E1751/E1751M-09e1
		$+100.0^{\circ}\text{C} \leq t < +1000.0^{\circ}\text{C}$	0.8	1.8	
		$+1000.0^{\circ}\text{C} \leq t \leq +1395.0^{\circ}\text{C}$	1.0	2.2	

These do not include thermocouple errors.

At an ambient temperature ( $T_a$ ) of  $23 \pm 5^{\circ}\text{C}$ , with an external RJ sensor (sold separately) connected, using the external reference junction compensation function.

For the accuracies of other ambient temperatures ( $T_a < 18^{\circ}\text{C}$ ,  $T_a > 28^{\circ}\text{C}$ ), add the temperature coefficient  $0.05^{\circ}\text{C}/^{\circ}\text{C}$ .

Source/measured value display resolution:  $0.1^{\circ}\text{C}$

Measured current: 1 mA or less (voltage application, current measurement)

The temperature of the reference junction or sensor is balanced with the ambient temperature.

## Specifications

---

### External RJ Sensor 90080 (sold separately) Specifications

Sensor used:	RTD Pt100 (four-wire system)
Standalone accuracy:	JIS AA class or equivalent
Specified current:	1 mA
Operating temperature range:	-10°C to 55°C
Y terminal:	M3 screw compatible

**Using Terminal B (Banana Terminal), with Reference Junction Compensation Set to Off (t: measurement/source temperature)**

Thermocouple	Accuracy (1 year)			Specification
	Temperature Range	Source Accuracy [°C]	Measurement Accuracy [°C]	
K	$-200.0^{\circ}\text{C} \leq t < 0.0^{\circ}\text{C}$	$0.3+ t  \times 0.2\%$	$0.3+ t  \times 0.2\%$	IEC60584-1 JIS C1602
	$0.0^{\circ}\text{C} \leq t < +500.0^{\circ}\text{C}$	0.3	0.3	
	$+500.0^{\circ}\text{C} \leq t \leq +1372.0^{\circ}\text{C}$	$0.3+(t-500) \times 0.02\%$	$0.3+(t-500) \times 0.02\%$	
E	$-250.0^{\circ}\text{C} \leq t < -200.0^{\circ}\text{C}$	$0.3+ t  \times 0.3\%$	$0.3+ t  \times 0.3\%$	IEC60584-1
	$-200.0^{\circ}\text{C} \leq t < 0.0^{\circ}\text{C}$	$0.3+ t  \times 0.3\%$	$0.3+ t  \times 0.3\%$	
	$0.0^{\circ}\text{C} \leq t < +500.0^{\circ}\text{C}$	0.3	0.3	
	$+500.0^{\circ}\text{C} \leq t \leq +1000.0^{\circ}\text{C}$	$0.3+(t-500) \times 0.02\%$	$0.3+(t-500) \times 0.02\%$	
J	$-210.0^{\circ}\text{C} \leq t < 0.0^{\circ}\text{C}$	$0.3+ t  \times 0.2\%$	$0.3+ t  \times 0.2\%$	IEC60584-1
	$0.0^{\circ}\text{C} \leq t \leq +1200.0^{\circ}\text{C}$	$0.3+t \times 0.02\%$	$0.3+t \times 0.02\%$	
T	$-250.0^{\circ}\text{C} \leq t < -200.0^{\circ}\text{C}$	$0.7+( t -200) \times 1.0\%$	$0.7+( t -200) \times 1.0\%$	IEC60584-1
	$-200.0^{\circ}\text{C} \leq t < 0.0^{\circ}\text{C}$	$0.3+ t  \times 0.2\%$	$0.3+ t  \times 0.2\%$	
	$0.0^{\circ}\text{C} \leq t \leq +400.0^{\circ}\text{C}$	0.3	0.3	
N	$-200.0^{\circ}\text{C} \leq t < 0.0^{\circ}\text{C}$	$0.5+ t  \times 0.2\%$	$0.5+ t  \times 0.2\%$	IEC60584-1
	$0.0^{\circ}\text{C} \leq t \leq +1300.0^{\circ}\text{C}$	0.5	0.5	
L	$-200.0^{\circ}\text{C} \leq t < 0.0^{\circ}\text{C}$	$0.3+ t  \times 0.1\%$	$0.3+ t  \times 0.1\%$	DIN 43710
	$0.0^{\circ}\text{C} \leq t \leq +900.0^{\circ}\text{C}$	0.3	0.3	
U	$-200.0^{\circ}\text{C} \leq t < 0.0^{\circ}\text{C}$	$0.3+ t  \times 0.1\%$	$0.3+ t  \times 0.1\%$	DIN 43710
	$0.0^{\circ}\text{C} \leq t \leq +600.0^{\circ}\text{C}$	0.3	0.3	
R	$-20.0^{\circ}\text{C} \leq t < 0.0^{\circ}\text{C}$	1.8	1.8	IEC60584-1
	$0.0^{\circ}\text{C} \leq t < +100.0^{\circ}\text{C}$	1.2	1.2	
	$+100.0^{\circ}\text{C} \leq t \leq +1767.0^{\circ}\text{C}$	1.2	1.2	
S	$-20.0^{\circ}\text{C} \leq t < 0.0^{\circ}\text{C}$	1.8	1.8	IEC60584-1
	$0.0^{\circ}\text{C} \leq t < +100.0^{\circ}\text{C}$	1.2	1.2	
	$+100.0^{\circ}\text{C} \leq t \leq +1768.0^{\circ}\text{C}$	1.2	1.2	

## Specifications

Thermocouple		Accuracy (1 year)			Specification
		Temperature Range	Source Accuracy [°C]	Measurement Accuracy [°C]	
B		$+600.0^{\circ}\text{C} \leq t < +800.0^{\circ}\text{C}$	1.1	1.3	IEC60584-1
		$+800.0^{\circ}\text{C} \leq t < +1000.0^{\circ}\text{C}$	0.9	1.0	
		$+1000.0^{\circ}\text{C} \leq t \leq +1820.0^{\circ}\text{C}$	0.9	0.9	
C		$0.0^{\circ}\text{C} \leq t < +1000.0^{\circ}\text{C}$	0.6	0.6	IEC60584-1
		$+1000.0^{\circ}\text{C} \leq t \leq +2315.0^{\circ}\text{C}$	$0.6+(t-1000) \times 0.06\%$	$0.6+(t-1000) \times 0.06\%$	
XK		$-200.0^{\circ}\text{C} \leq t < 0.0^{\circ}\text{C}$	$0.2+ t  \times 0.1\%$	$0.2+ t  \times 0.1\%$	GOST R 8.585-2001
		$0.0^{\circ}\text{C} \leq t < +300.0^{\circ}\text{C}$	0.2	0.2	
		$+300.0^{\circ}\text{C} \leq t \leq +800.0^{\circ}\text{C}$	0.3	0.3	
A		$0.0^{\circ}\text{C} \leq t < +1000.0^{\circ}\text{C}$	0.8	0.8	IEC60584-1
		$+1000.0^{\circ}\text{C} \leq t \leq +2500.0^{\circ}\text{C}$	$0.8+(t-1000) \times 0.06\%$	$0.8+(t-1000) \times 0.06\%$	
Extra TC	D (W3Re/ W25Re)	$0.0^{\circ}\text{C} \leq t < +300.0^{\circ}\text{C}$	1.2	1.6	ASTM E1751/E1751M-09e1
		$+300.0^{\circ}\text{C} \leq t < +1500.0^{\circ}\text{C}$	1.0	1.0	
		$+1500.0^{\circ}\text{C} \leq t \leq +2315.0^{\circ}\text{C}$	1.6	2.0	
	G (W/W26Re)	$+100.0^{\circ}\text{C} \leq t < +300.0^{\circ}\text{C}$	1.2	1.6	ASTM E1751/E1751M-09e1
		$+300.0^{\circ}\text{C} \leq t < +1500.0^{\circ}\text{C}$	1.0	1.0	
		$+1500.0^{\circ}\text{C} \leq t \leq +2315.0^{\circ}\text{C}$	1.6	2.0	
	PLATINEL II	$0.0^{\circ}\text{C} \leq t < +100.0^{\circ}\text{C}$	0.4	1.6	ASTM E1751/E1751M-09e1
		$+100.0^{\circ}\text{C} \leq t \leq +1000.0^{\circ}\text{C}$	0.6	1.6	
		$+1000.0^{\circ}\text{C} \leq t < +1395.0^{\circ}\text{C}$	0.8	2.0	

These do not include thermocouple errors.

At an ambient temperature ( $T_a$ ) of  $23 \pm 5^{\circ}\text{C}$ , without using the internal reference junction compensation function.

For the accuracies of other ambient temperatures ( $T_a < 18^{\circ}\text{C}$ ,  $T_a > 28^{\circ}\text{C}$ ), add the temperature coefficient  $0.05^{\circ}\text{C}/^{\circ}\text{C}$ .

### Voltage Source/Measurement Specifications

Range	Measurement and Source Range	Resolution	Accuracy (1 year)		Notes
			of Setting of Reading	Offset	
90 mV	-11.000 to +99.999 mV	1 $\mu$ V	0.015%	10 $\mu$ V	Maximum output current: 1 mA

At the ambient temperature ( $T_a$ ) of  $23 \pm 5^\circ\text{C}$ .

For the accuracies of other ambient temperature ranges ( $T_a < 18^\circ\text{C}$ ,  $T_a > 28^\circ\text{C}$ ), add the temperature coefficient 0.005% of Range/ $^\circ\text{C}$ .

### Common Measurement Section Specifications

Maximum input across terminals: 42 V<sub>peak</sub>

Maximum input to ground: 42 V<sub>peak</sub>

### Common Source Section Specifications

Output resistance: 40 m $\Omega$  or less

Output response: 300 ms or less

Maximum load:  $C \leq 0.1 \mu\text{F}$ ,  $L \leq 10 \text{ mH}$

Maximum input across terminals: 42 V<sub>peak</sub>

Maximum input to ground: 42 V<sub>peak</sub>

### Thermocouple Accuracy Equation

Accuracy with respect to the measurement or source temperature ( $t$ ) is expressed as constant or a linear equation of  $t$ .

Example: Accuracy for Thermocouple K (terminal A) measurement value of  $1000.0^\circ\text{C} = \pm(0.5 + (1000.0 - 500) \times 0.02\%)^\circ\text{C} = \pm 0.6^\circ\text{C}$

CA330

RTD Source/Measurement Specifications

RTD	Coefficient	Accuracy (1 year)			Excitation Current Input Range	Standard, Citation
		Temperature Range	Measurement Accuracy [°C]	Source Accuracy [°C]		
PT100	3851	$-200.0^{\circ}\text{C} \leq t < 0.0^{\circ}\text{C}$	0.3	0.3	0.1 to 3 mA	IEC60751 JIS C 1604
		$0.0^{\circ}\text{C} \leq t \leq +800.0^{\circ}\text{C}$	$0.3+t \times 0.033\%$	$0.3+t \times 0.033\%$		
	3850	$-200.0^{\circ}\text{C} \leq t < 0.0^{\circ}\text{C}$	0.3	0.3	0.1 to 3 mA	JIS C 1604 1989 (Pt100)
		$0.0^{\circ}\text{C} \leq t \leq +630.0^{\circ}\text{C}$	$0.3+t \times 0.033\%$	$0.3+t \times 0.033\%$		
	3916	$-200.0^{\circ}\text{C} \leq t < 0.0^{\circ}\text{C}$	0.3	0.3	0.1 to 3 mA	JIS C 1604 1989 (JPt100)
		$0.0^{\circ}\text{C} \leq t \leq +510.0^{\circ}\text{C}$	$0.3+t \times 0.033\%$	$0.3+t \times 0.033\%$		
3926	$-200.0^{\circ}\text{C} \leq t < 0.0^{\circ}\text{C}$	0.3	0.3	0.1 to 3 mA	Minco Application Aid #18	
	$0.0^{\circ}\text{C} \leq t \leq +630.0^{\circ}\text{C}$	$0.3+t \times 0.033\%$	$0.3+t \times 0.033\%$			
PT200	3851	$-200.0^{\circ}\text{C} \leq t < 0.0^{\circ}\text{C}$	0.3	0.3	0.05 to 0.8 mA	IEC60751
		$0.0^{\circ}\text{C} \leq t \leq +630.0^{\circ}\text{C}$	$0.3+t \times 0.050\%$	$0.3+t \times 0.050\%$		
PT500	3851	$-200.0^{\circ}\text{C} \leq t < 0.0^{\circ}\text{C}$	0.4	0.4	0.05 to 0.6 mA	IEC60751
		$0.0^{\circ}\text{C} \leq t \leq +630.0^{\circ}\text{C}$	$0.4+t \times 0.033\%$	$0.4+t \times 0.033\%$		
PT1000	3851	$-200.0^{\circ}\text{C} \leq t < 0.0^{\circ}\text{C}$	0.2	0.2	0.05 to 0.6 mA	IEC60751
		$0.0^{\circ}\text{C} \leq t \leq +630.0^{\circ}\text{C}$	$0.2+t \times 0.033\%$	$0.2+t \times 0.033\%$		
Cu10	427	$-100.0^{\circ}\text{C} \leq t < +260.0^{\circ}\text{C}$	1.5	1.5	0.1 to 3 mA	Minco Application Aid #18
Ni120	627	$-80.0^{\circ}\text{C} \leq t < +260.0^{\circ}\text{C}$	0.2	0.2	0.1 to 3 mA	Minco Application Aid #18

RTD		Coefficient	Accuracy (1 year)			Excitation Current Input Range	Standard, Citation
			Temperature Range	Measurement Accuracy [%]	Source Accuracy [%]		
Extra RTD	PT50	3851	-200.0°C ≤ t < 0.0°C	0.4	0.4	0.1 to 3 mA	IEC60751
			0.0°C ≤ t ≤ +630.0°C	0.4+t x 0.050%	0.4+t x 0.050%		
	PT50G	-	-200.0°C ≤ t < 0.0°C	0.4	0.4	0.1 to 3 mA	GOST R 8.625-2006
			0.0°C ≤ t ≤ +800.0°C	0.4+t x 0.050%	0.4+t x 0.050%		
	PT100G	-	-200.0°C ≤ t < 0.0°C	0.3	0.3	0.1 to 3 mA	GOST R 8.625-2006
			0.0°C ≤ t ≤ +630.0°C	0.3+t x 0.033%	0.3+t x 0.033%		
	Cu50M	-	-180.0°C ≤ t < 0.0°C	0.4	0.4	0.1 to 3 mA	GOST R 8.625-2006
			0.0°C ≤ t ≤ +200.0°C	0.4+t x 0.050%	0.4+t x 0.050%		
	Cu100M	-	-180.0°C ≤ t < 0.0°C	0.3	0.3	0.1 to 3 mA	GOST R 8.625-2006
			0.0°C ≤ t ≤ +200.0°C	0.3+t x 0.033%	0.3+t x 0.033%		

At the ambient temperature (Ta) of 23±5°C.

For the accuracies of other ambient temperatures (Ta<18°C, Ta>28°C), add the temperature coefficient 0.05°C/°C.

Source/measured value display resolution: 0.1°C

The above figures are accuracies through four-wire system measurement.

For accuracies through three-wire system measurement, add 1.0°C for Cu10, 0.6°C for Pt50, Pt50G, and Cu50M, and 0.3°C for other RTDs. However, this assumes that the resistances of all cables are the same.

Assume the accuracies through two-wire system measurement to be the same as those through three-wire system measurement. However, cable resistance are not taken into consideration.

The temperature of the terminals or binding post is balanced with the ambient temperature.

### How to View the RTD Accuracy

Accuracy with respect to the measurement or source temperature (t) is expressed as constant or a linear equation of t.

Example: Accuracy for PT100 measurement value of 100.0°C = ±(0.3 + 100.0x0.033%)°C = ±0.333°C



## Specifications

### Resistance Source/Measurement Specifications

Range	Measurement Range	Resolution	Accuracy (1 year)		Notes
			of Reading of Setting	Offset	
500 $\Omega$	0.00 to 550.00 $\Omega$	0.01 $\Omega$	0.025%	0.1 $\Omega$	Excitation current input range 0.1 to 3 mA
3000 $\Omega$	0.0 to 3300.0 $\Omega$	0.1 $\Omega$	0.025%	0.5 $\Omega$	Excitation current input range 0.05 to 0.6 mA

At the ambient temperature ( $T_a$ ) of  $23\pm 5^\circ\text{C}$ . For the accuracies of other ambient temperature ranges ( $T_a < 18^\circ\text{C}$ ,  $T_a > 28^\circ\text{C}$ ), add the temperature coefficient 0.005% of Range/ $^\circ\text{C}$ .

The above figures are accuracies through four-wire system measurement.

For accuracies through three-wire system measurement, add 0.05  $\Omega$  for the 500  $\Omega$  range and 0.2  $\Omega$  for the 3000  $\Omega$  range. However, this assumes that the resistances of all cables are the same.

Assume the accuracies through two-wire system measurement to be the same as those through three-wire system measurement.

However, cable resistance are not taken into consideration.

### Common Measurement Section Specifications

Excitation current:	Voltage application, current measurement method (Typical value: 0.78 mA@0 $\Omega$ , 0.6 mA@500 $\Omega$ , 0.27 mA@3000 $\Omega$ )
Burnout detection:	Detected based on Hi terminal open
Allowable signal cable resistance:	10 $\Omega$ or less
Maximum input across terminals:	42 V <sub>peak</sub>
Maximum input to ground:	42 V <sub>peak</sub>

### Common Source Section Specifications

Output response:	5 ms or less (3000 $\Omega$ range, excluding PT500 and PT1000)
Overcurrent input warning:	When the upper limit of excitation current is exceeded
Maximum load:	$C \leq 0.1 \mu\text{F}$ , $L \leq 10 \text{ mH}$
Sweep:	Step (25%/linear)
Step time:	15s/30s/45s/60s
Maximum input across terminals:	42 V <sub>peak</sub>
Maximum input to ground:	42 V <sub>peak</sub>

## Common Specifications

Item		Specifications
Operating environment	Ambient temperature	-10 to 55°C
	Ambient humidity	20 to 80%RH (no condensation)
	Elevation	2000 m or less
Storage environment	Ambient temperature	-20 to 60°C
	Ambient humidity	0 to 90%RH (no condensation)
Power supply		LR6 alkaline batteries ×4 or dedicated AC adapter (sold separately)
Battery life		CA310    Approx. 50 hours    (source: 5 V, load: 10 kΩ or higher) Approx. 25 hours    (source: 20 mA, load: 5 V or lower) CA320    Approx. 55 hours CA330    Approx. 55 hours (For all cases, backlight off)
Auto power-off		Approx. 20 minutes (disabled when the separately sold AC adapter is connected)
Measurement display update interval		Approx. 1 s
Display method		Segment LCD with backlight function
Maximum voltage application		Between each terminal and earth 50 VDC or less (CA310) Between each terminal and earth 42 VDC or less (CA320, CA330)
External dimensions		Approx. 90 (W) × 192 (H) × 42 (D) mm (excluding protrusions)
Weight		Approx. 440 g (excluding alkaline batteries)
Safety standard		EN 61010-1 Overvoltage Category I <sup>1</sup> Pollution degree 2 <sup>2</sup> EN 61010-2-030 No measurement category; O (Other)

## Specifications

Item		Specifications
EMC	Emissions	Compliant standards: EN 61326-1 Class A, EN 55011 Class A Group1 EMC standards of Australia and New Zealand EN55011 Class A, Group 1, Korea Electromagnetic Conformity Standard ( 한국 전자파적합성기준 ) This is a Class A product. Operation of this product in a residential area may cause electromagnetic interference in which case the user will be required to correct the interference.
	Immunity	Compliant standard: EN 61326-1 Table2 (for use in industrial locations) Influence in the immunity test environment: within $\pm 10\%$ of the range
Environmental standard		Compliant standard: EN50581 Monitoring and instruments

- 1 The overvoltage category (installation category) is a value used to define the transient overvoltage condition and includes the rated impulse withstand voltage. Overvoltage Category I applies to equipment that is connected to a circuit that has been designed to suppress overvoltage caused by transient phenomena to an adequately low level.
- 2 Pollution degree refers to the degree of adhesion of a solid, liquid, or gas which deteriorates withstand voltage or surface resistivity. Pollution degree 2 applies to normal indoor atmospheres (with only non-conductive pollution).

## External Dimensions

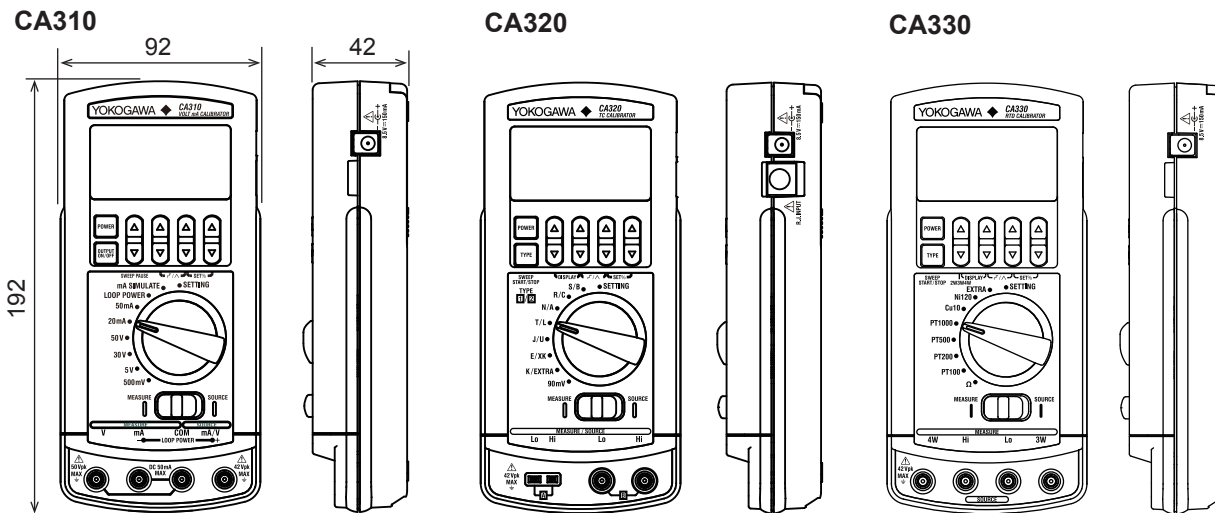

Unless otherwise specified, tolerances are  $\pm 3\%$   
 (however, tolerances are  $\pm 0.3$  mm when below 10 mm).

Unit: mm