

**ADMAG TI Series
AXW Magnetic Flowmeter
HART Communication Type**



IM 01E24A02-02EN

ADMAG TI Series

AXW Magnetic Flowmeter

HART Communication Type

IM 01E24A02-02EN 4th Edition

Contents

1.	Introduction.....	4
1.1	For Safe Use of Product	6
1.2	Warranty.....	7
2.	Basic Operating Procedures.....	8
2.1	Operation by Display unit	8
2.2	Display and Basic Configuration	8
2.2.1	Display	8
2.2.2	Basic Configuration for Display.....	9
2.3	Display Mode and Setting Mode.....	11
2.4	Parameter Setting from Display Panel	12
2.4.1	Setting example of Select type Data: Flow rate unit	12
2.4.2	Setting example of Numeric type Data: Flow rate span	12
2.4.3	Setting Example of Alphanumeric type Data: Tag No.	13
2.5	microSD Card Insertion/Removal	13
3.	Operation with HART Configuration Tool.....	14
3.1	Connecting the HART Configuration Tool	14
3.2	HART Configuration Tool and Device Revision	14
3.2.1	Device Description (DD) and Device Revision	14
3.2.2	Device Type Manager (DTM) and Device Revision	15
3.3	Basic Setup.....	15
3.4	Parameters Configuration	15
3.5	Data Renewing and Upload / Download Function	16
3.6	Specific Functions of HART Configuration Tool	18
3.6.1	Burst Mode.....	18
3.6.2	Event Notification	20
3.6.3	Multidrop Mode	21
4.	Functions	22
4.1	Basic Settings	23
4.1.1	Overview	23
4.1.2	PV Mapping of Process Value	24
4.1.3	Display of the Process Value	24

4.1.4	Engineering Unit Setting	25
4.1.5	Span Setting.....	25
4.1.6	Damping Time Constant Setting.....	26
4.1.7	Low-cut Function Setting	27
4.1.8	Sensor's Nominal Size Setting	28
4.1.9	Density Setting.....	28
4.1.10	Zero Adjustment.....	29
4.2	Totalization Function	30
4.2.1	Totalized Value and Unit Setting	30
4.2.2	Totalized-Value Display and Totalizer Function	30
4.2.3	Totalization Switch Function	31
4.2.4	Totalizer Operation at Alarm Occurrence.....	32
4.2.5	Totalization Function Start/Stop Setting.....	32
4.2.6	Totalization Direction Setting	32
4.2.7	Totalized Value Reset/Preset Function.....	33
4.3	Pulse Output, Frequency Output, and Status Output.....	34
4.3.1	Outputs of I/O2, and I/O4 Terminals	34
4.3.2	Pulse Output / Frequency Output Mapping	34
4.3.3	Pulse Width Setting.....	35
4.3.4	Active Direction Setting.....	35
4.3.5	Pulse Rate Setting	36
4.3.6	Frequency Output Range Setting	37
4.3.7	Status Output Function Setting.....	37
4.4	Status Input.....	38
4.4.1	Active Direction Setting for Status Input	38
4.4.2	Status Input Function Setting.....	39
4.5	Current Output	39
4.5.1	Current Output High/Low Limit Function	39
4.5.2	Absolute Range Function	40
4.5.3	Alarm Output Function.....	40
4.5.4	Current Output Priority	41
4.5.5	Current Value Adjustment Function	41
4.6	Multi Range Function	42
4.6.1	Multi Range Types	42
4.6.2	Multi Range Setting.....	42
4.6.3	Multi Range Operation.....	42
4.6.4	Forward/Reverse Range	43
4.6.5	Combination of Multi Range and Forward/Reverse Range	44
4.6.6	External Contact Range.....	45
4.7	Auxiliary Calculation Function.....	45
4.7.1	Fluid Flow Direction Setting	45
4.7.2	Rate Limit Function Setting.....	46

4.7.3	Pulsing Flow Support Function Setting	47
4.7.4	Power Frequency Synchronization Setting	47
4.8	Alarm	49
4.8.1	Errors and Countermeasures	49
4.8.2	Alarm Display Setting.....	54
4.8.3	Alarm History Function.....	55
4.8.4	Alarm Mask Function	55
4.9	Display.....	60
4.9.1	Language Setting.....	60
4.9.2	Display Item Setting	60
4.9.3	Decimal-Point Position Setting	61
4.9.4	Display Line Count and Scroll Settings.....	62
4.9.5	Trend Graph Setting	63
4.9.6	Other Setting	64
4.9.7	microSD Card Setting	65
4.10	Device Information.....	65
4.10.1	Order Information.....	65
4.10.2	Device Revision	66
4.10.3	Memo Function	66
4.11	Self-diagnostic Function.....	67
4.11.1	Types of Diagnosis Functions.....	67
4.11.2	Alarm High/Low Limit Function	67
4.11.3	Electrode Adhesion Detection	68
4.11.4	Sensor Empty Check.....	69
4.11.5	Wiring Connection Diagnosis	70
4.11.6	Verification (Device Health Diagnosis) Function	71
4.12	Test Mode.....	73
4.12.1	Test Mode Setting	73
4.12.2	Test Terminal and Value Setting.....	73
4.12.3	Test Mode Auto Reset.....	74
4.13	Event Management Function.....	74
4.13.1	Backup Function	74
4.13.2	Restore / Duplicate Function	76
4.13.3	Backup and Restore Parameters	79
4.13.4	Data Logging Function.....	87
4.14	Software Write Protection Function	88
5.	Parameters of Magnetic Flowmeter	90
5.1	Parameter Lists for Display and HART Communication.....	90
5.2	Menu Tree of Display	124
5.3	Menu Tree of HART Communication.....	130
	Revision Information	139

1. Introduction

This manual provides the basic guidelines for basic operation of ADMAG TI (Total Insight) Series AXW magnetic flowmeters with HART protocol.

For the items which are not covered in this manual, read the applicable user's manuals and general specifications as listed in Table 1.1. These documents can be downloaded from the website of YOKOGAWA. To ensure correct use of the instrument, read these manuals thoroughly and fully understand how to operate the instrument before operating it. For method of checking the model and specifications, read general specifications as listed in Table 1.1.

Website address: <http://www.yokogawa.com/fld/doc/>

These manuals can be downloaded from the website of YOKOGAWA or purchased from the YOKOGAWA representatives.

Table 1.1 Manual and General Specifications List

Model	Document Title	Document No.
AXW□□□ AXW□□□G AXW□□□W AXW4A AX01C	ADMAG TI Series AXG/AXW Magnetic Flowmeter Read Me First	IM 01E21A21-01Z1
	ADMAG TI Series AXG/AXW Magnetic Flowmeter Safety Manual	IM 01E21A21-02EN
	ADMAG TI Series AXW Magnetic Flowmeter [Size: 25 to 400 mm (1 to 16 in.)] Installation Manual	IM 01E24A01-01EN
	ADMAG TI Series AXW Magnetic Flowmeter [Size: 500 to 1800 mm (20 to 72 in.)] Installation Manual	IM 01E25A01-01EN
	ADMAG TI Series AXW Magnetic Flowmeter [Size: 25 to 1800 mm (1 to 72 in.)] Maintenance Manual	IM 01E24A01-02EN
	ADMAG TI Series AXW Magnetic Flowmeter BRAIN Communication Type	IM 01E24A02-01EN
	ADMAG TI Series AXW Magnetic Flowmeter HART Communication Type	IM 01E24A02-02EN (this manual)
	ADMAG TI Series AXW Magnetic Flowmeter [Size: 25 to 400 mm (1 to 16 in.)] General Specifications	GS 01E24A01-01EN
	ADMAG TI Series AXW Magnetic Flowmeter [Size: 500 to 1800 mm (20 to 72 in.)] General Specifications	GS 01E25D11-01EN
	AXFA11G	AXF Series Magnetic Flowmeter Read Me First
AXFA11G	AXFA11G Remote Converter [Hardware Edition/Software Edition]	IM 01E20C01-01E
AXFC	AXFA11G Remote Converter General Specifications	GS 01E20C01-01E



NOTE

When describing the model name like AXW□□□ in this manual, "□□□" means any of the following.

For AXW□□□:

025, 032, 040, 050, 065, 080, 100, 125, 150,
200, 250, 300, 350, 400

For AXW□□□G or AXW□□□W:

500, 600, 700, 800, 900, 10L, 11L, 12L, 13L,
14L, 15L, 16L, 18L

■ Precautions Related to the Protection, Safety, and Alteration of the Instrument

The following safety symbol marks are used in this manual and instrument.



WARNING

A WARNING sign denotes a hazard. It calls attention to procedure, practice, condition or the like, which, if not correctly performed or adhered to, could result in injury or death of personnel.



CAUTION

A CAUTION sign denotes a hazard. It calls attention to procedure, practice, condition or the like, which, if not correctly performed or adhered to, could result in damage to or destruction of part or all of the product.



IMPORTANT





An IMPORTANT sign denotes that attention is required to avoid damage to the instrument or system failure.



NOTE

A NOTE sign denotes information necessary for essential understanding of operation and features.

The following symbols are used in the Instrument and the manual to indicate the accompanying safety precautions:

	Protective grounding terminal
	Functional grounding terminal (This terminal should not be used as a protective grounding terminal.)
	Alternating current
	Direct current
	Caution This symbol indicates that the operator must refer to an explanation in the user's manual in order to avoid the risk of injury or death of personnel or damage to the instrument.

For the protection and safe use of the instrument and the system in which this instrument is incorporated, be sure to follow the instructions and precautions on safety that is stated in user's manual as listed in Table 1.1 whenever you handle the instrument. Take special note that if you handle the instrument in a manner that violated these instructions, the protection functionality of the instrument may be damaged or impaired. In such cases, YOKOGAWA does not guarantee the quality, performance, function, and safety of instrument.

■ Regarding This User's Manual

- This manual should be provided to the end user.
- The contents of this manual are subject to change without prior notice.
- All rights reserved. No part of this manual may be reproduced in any form without YOKOGAWA's written permission.
- YOKOGAWA makes no warranty of any kind with regard to this manual, including, but not limited to, implied warranty of merchantability and fitness for a particular purpose.
- If any question arises or errors are found, or if any information is missing from this manual, inform the nearest YOKOGAWA sales office.
- The specifications covered by this manual are limited to those for the standard type under the specified model number break-down and do not cover custom-made instruments.
- Note that changes in the specifications, construction, or component parts of the instrument may not immediately be reflected in this manual at the time of change, provided that postponement of revisions will not cause difficulty to the user from a functional or performance standpoint.
- This manual is intended for the following personnel;
 - Engineers responsible for installation and wiring of the instrument.
 - Personnel responsible for normal daily operation of the instrument.
- To ensure correct use, read this manual and the applicable manuals as listed in Table 1.1 thoroughly before starting operation. Read the general specifications as listed in Table 1.1 for its specification.

■ Trademarks:

- All the brands or names of Yokogawa Electric's products used in this manual are either trademarks or registered trademarks of Yokogawa Electric Corporation.
- All other company and product names mentioned in this manual are trade names, trademarks or registered trademarks of their respective companies.
- In this manual, trademarks or registered trademarks are not marked with TM or [®].

1.1 For Safe Use of Product

For the protection and safe use of the instrument and the system in which this instrument is incorporated, be sure to follow the instructions and precautions on safety that is stated in user's manual as listed in Table 1.1 whenever you handle the instrument. Take special note that if you handle the instrument in a manner that violated these instructions, the protection functionality of the instrument may be damaged or impaired. In such cases, YOKOGAWA shall not be liable for any indirect or consequential loss incurred by either using or not being able to use the Instrument.

(1) General



WARNING

- Do not open the cover in wet weather or humid environment. When the cover is open, stated enclosure protection is not applicable.
- When opening the cover, wait for more than 20 minutes after turning off the power. Only expert engineer or skilled personnel are permitted to open the cover.

(2) Operation



WARNING

Be sure to enable the write protect function to prevent the overwriting of parameters after finishing parameter setting.

In rare cases, the IR switches may respond unexpectedly to water drops or extraneous substances sticking on the surface of display panel, due to the operating principal. The possibility of malfunction arises after rain or cleaning operation near the place where the flowmeter is installed. Turning on and off the flashlight etc. towards the IR switch may also be a cause of malfunction.

Read the installation manual as listed in Table 1.1 for the hardware write protect function, and Section 4.14 for the software write protect function.

(3) Maintenance



WARNING

- If dirt, dust or other substances surfaces on the glass of display cover, wipe them clean with a soft dry cloth.
- Maintenance of this flowmeter should be implemented in a maintenance service shop where the necessity tools and environment condition are provided.
The necessity of this environmental condition is that ambient temperature is 5 to 40°C (the maximum relative humidity is 80 % for temperature 5 to 31°C, and decreasing linearly to 50 % relative humidity at 40°C).

(4) microSD Card



IMPORTANT

- Do not store or use the microSD card in places with static electricity, near electrically charged objects, or where electrical noise is present. Doing so can result in shock or damage.
- Do not disassemble or modify the microSD card.
- Do not physically shock, bend, or pinch the microSD card.
- During reading/writing of data, do not turn off the power, apply vibration or shock, or pull out the card. Data can corrupt or be permanently lost.
- Use only micro SD cards sold by YOKOGAWA. Operation cannot be guaranteed when other cards are used.
- When inserting the microSD card into the instrument, make sure to orient the microSD card correctly (face up or down) and insert it securely. If not inserted correctly, the microSD card will not be recognized by the instrument.
- Do not touch the microSD card with wet hands.
- Do not use the microSD card if it is dusty or dirty.
- The microSD card comes formatted. If you want to format the microSD card, use the instrument's Format function.
- YOKOGAWA provides no warranty for damage to, or loss of data recorded on the microSD card, regardless of the cause of such damage or loss.
We recommend making backup copies of your data.

1.2 Warranty

- The warranty shall cover the period noted on the quotation presented to the purchaser at the time of purchase. Problems occurred during the warranty period shall basically be repaired free of charge.
- In case of problems, the customer should contact the YOKOGAWA representative from which the instrument was purchased, or the nearest YOKOGAWA office.
- If a problem arises with this instrument, please inform us of the nature of the problem and the circumstances under which it developed, including the model specification and serial number. Any diagrams, data and other information you can include in your communication will also be helpful.
- Responsible party for repair cost for the problems shall be determined by YOKOGAWA based on our investigation.
- The Purchaser shall bear the responsibility for repair costs, even during the warranty period, if the malfunction is due to:
 - Improper and/or inadequate maintenance by the purchaser.
 - Failure or damage due to improper handling, use or storage which is out of design conditions.
 - Use of the product in question in a location not conforming to the standards specified by YOKOGAWA, or due to improper maintenance of the installation location.
 - Failure or damage due to modification or repair by any party except YOKOGAWA or an approved representative of YOKOGAWA.
 - Malfunction or damage from improper relocation of the product in question after delivery.
 - Reason of force majeure such as fires, earthquakes, storms/floods, thunder/lightening, or other natural disasters, or disturbances, riots, warfare, or radioactive contamination.

2. Basic Operating Procedures

2.1 Operation by Display unit

The parameter settings from display unit can be carried out using the three IR (infra-red) switches - namely, the [SET] [SHIFT] and [▼] switches. The IR switches enable the user to set parameters from the outside of the glass of the display cover.

This section provides descriptions of basic parameter configuration and operation procedures of IR switches. This instrument can be also operated using the dedicated handheld terminal or the FieldMate (Versatile Device Management Wizard). For operation in details, read Chapter 4 or the hardware/software edition (for AXFA11) as listed in Table 1.1.

WARNING

Be sure to enable the write protect function to prevent the overwriting of parameters after finishing parameter setting.

In rare cases, the IR switches may respond unexpectedly to water drops or extraneous substances sticking on the surface of display panel, due to the operating principal. The possibility of malfunction arises after rain or cleaning operation near the place where the flowmeter is installed. Turning on and off the flashlight etc. towards the IR switch may also be a cause of malfunction.

Read the installation manual as listed in Table 1.1 for the hardware write protect function, and Section 4.14 for the software write protect function.

IMPORTANT

Operate the display unit under the condition where direct sunlight, etc... do not shine to the IR switches directly when the parameter setting operation is carried out.

NOTE

- Always keep the cover closed and operate the setting switches from the outside of the glass window.
- If dirt, dust or other substances surfaces on the glass of display cover, wipe them clean with a soft dry cloth.
- The operation with dirty gloves may cause a switch response error.

NOTE

The language on the display is set to “English” as default at the factory shipment. Select the adequate language referring to Subsection 2.2.2 and Subsection 4.9.1. The menu pass of the display on this manual is selected to “English”.

2.2 Display and Basic Configuration

The display unit of AXW Integral Flowmeter and AXW4A Remote transmitter has various functions below.

2.2.1 Display

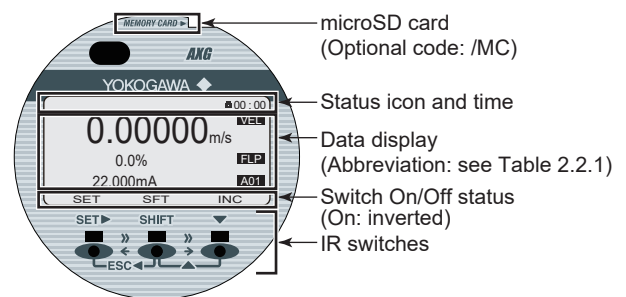

F0201.ai

(1) Basic operation of IR switches

The operation from display panel is done by using the three IR switches; [SET], [SHIFT] and [▼]. The combination of the two switches provides a different function, and the function is indicated on the display.

IR switch (Note 1)	Indicate of switch (Note 2)	Function
[SET▶]	SET	<ul style="list-style-type: none"> Apply parameter (Note 3) Enter data (Note 3) Move to next menu
[SHIFT]	SFT	<ul style="list-style-type: none"> Move cursor right (Numeric type parameter)
[▼]	INC	<ul style="list-style-type: none"> Move cursor down (Select type parameter) Increment value (Numeric type parameter) Change position of decimal point (Numeric type parameter)
[SHIFT] + [▼] (= [▲])	DEC	<ul style="list-style-type: none"> Move cursor up (Select type parameter) Decrement value (Numeric type parameter)
SHIFT + SET▶ (= [ESC◀])	ESC	<ul style="list-style-type: none"> Cancel Back to previous menu

- Note 1: [A] + [B] (= [C]): The function is changed to switch [C] when switch [B] is pushed while pushing switch [A].
- Note 2: [SET], [SFT], [INC], [DEC] and [ESC] indicate the assigned function in accordance with display mode at that time.
- Note 3: "Apply" and "Enter" are executed by pushing [SET] twice. If the execution does not work properly, release the finger from the display glass completely after the first push of [SET], and then make the second push.

(2) Status icons

Icon	Contents	Icon	Contents
	Write protect Invalid		Write protect Valid
	Device Busy		Device Fault
	Ready for microSD card		Accessing microSD card
	Disable to access microSD card		Uploading parameters
	Downloading parameters		Trend graph executing
	System alarm occurs		HART communication
	Process alarm occurs		Setting alarm occurs
	Warning occurs		Information occurs
	Display Damping Valid		Operation level: Operator
	Operation level: Maintenance		Operation level: Specialist

(3) Data indication part

The process values are available to select 8 items maximum on the display. It is possible to indicate 4 items maximum on the display at the same time, and the rest 4 items are able to show by scrolling.

Table 2.2.1 Abbreviation table of process values to be indicated on the display.

Abbreviation	Contents
FLP(*1)	Flow rate %
PRV(*1)	Process value
VEL(*1)	Flow velocity
VFL(*1)	Volumetric flow
MFL(*1)	Mass flow
FLB	Flow rate in % bar graph
TL1(*1)	Totalization value 1
TL2(*1)	Totalization value 2
TL3(*1)	Totalization value 3
TAG	Tag No.
LTG	Long Tag
COM	Communication protocol
ADH	Adhesion diagnostic Level (Alarm at Level 4)
AO1(*1)	Analog output value 1

*1: Available to display the online trend graph.



NOTE

The PRV (PV value), FLP (flow rate%), VEL (flow velocity), VFL (volume flow), and MFL (mass flow) are not affected by the low cut function for analog output. Their values are displayed as they are.

2.2.2 Basic Configuration for Display

For paramter setting from display panel, configurable parameters differ by the three operational levels specified in Table 2.2.2, and a passcode is needed to enter into Setting mode. No passcode requires for "Operator", and a passcode corresponding to each level requires for "Maintenance" or "Specialist". For parameter in details, read Section 4.9.

Table 2.2.2 Parameter setting from display panel and operation level

Operation Level	Reading parameters	Writing parameters
Operator	All parameters	Parameters related with basic display settings including display language.
Maintenance	All parameters	Parameters allowed for Operator level. Parameters related with Zero adjustment.
Specialist	All parameters	All Parameters

The following parameters are available to "Operator" level without passcode.

(5) Inverse Display Setting

Display Menu Path:
 Device setup ▶ Detailed setup ▶ Display set ▶ Optional config ▶ Inversion

Available to change from normal display to white/black reverse display.

Setting item	Contents
Normal	Characters in the display is Black.
Inverse	Outline characters

2.3 Display Mode and Setting Mode

The device runs in the Display Mode when the power is turned on. For check or change of parameters, the Setting Mode must be activated. The following procedure explains how to change to the Setting Mode. For the function of IR switches, read Subsection 2.2.1.

[Procedure]

- 1) Turn on the power and wait for several seconds to move to display mode.

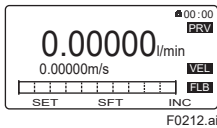

- 2) Keep touching [SET] switch for two seconds. The screen moves to the menu of Operation Level.

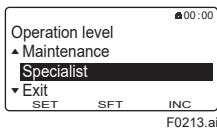

- 3) Select an appropriate operation level by moving the cursor with [INC] or [DEC] switch. Passcode is not necessary for "Operator". For "Maintenance" and "Specialist", passcode is necessary for each. For passcode setting, [SFT] is for position change, and [INC] is for number, then twice [SET] is for entry completion. The default passcode at the factory shipment is set to "0000".

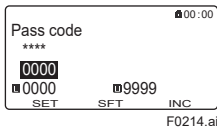

- 4) When the Operation Level is determined, the screen moves to "Device setup" as the Setting Mode where parameters can be configured.
- 5) After completing parameter setting, push [ESC] switch. The screen returns to the Display Mode.

[Passcode Confirmation and Change]

The confirmation and change of the passcode are allowed only by parameter setting from the display unit.

Display Menu Path:
 Device setup ▶ Detailed setup ▶ Access cfg ▶ Chg mainte
 Device setup ▶ Detailed setup ▶ Access cfg ▶ Chg special

- (1) Passcode for "Maintenance" operation level
 To change the passcode (Maintenance code), "Maintenance" or "Specialist" as the operational level is required.
- (2) Passcode for "Specialist" operation level
 To change the passcode (Specialist code), "Maintenance" or "Specialist" as the operational level is required.



IMPORTANT

Display Menu Path:
 Device setup ▶ Wizard

When parameters are changed in the Wizard of Easy setup, "Setting download" in the menu of each parameter must be executed after parameter is changed. Without the execution, any parameter changed is not stored into the device.



NOTE

If 10 minutes past without operation in the Setting Mode, the screen goes back to the Display Mode.

Parameter form

There are three types of parameter form below.

Type	Example of display	Contents
Select type	Unit m ³ l (liter) cm ³	Select the adequate data from among alternatives which are determined in advance.
Numeric type	Span +7200.00 +2200.00 +0.00001 +999999	Specify the data with a combination of number and a decimal point into each digit.
Alphanumeric type	Tag No FT-1234 FT-1234	Configure the data with a combination of alphanumeric characters. (Tag No., Special unit, etc...)

The alphanumeric type indicates alphanumeric characters in the following order.

0123456789ABCDEFGHIJKLMNQRSTUUVWXYZabcdefghijklmnopqrstuvwxyz!#\$%&'()*+,-./:;<=>?@[\\]^_`{|}~"space"

2.4 Parameter Setting from Display Panel

This section explains how to specify the parameters from display panel. Select “Specialist” at the Operation Level referring to Section 2.3. And select the parameters to be specified in the Setting Mode.



NOTE

For the device with the ordering information specified at ordering, the specified parameters (flow span and unit, tag number, etc.) are stored in the device at the factory shipment. Without the ordering information specified, parameter setting needs to be done by user.

2.4.1 Setting example of Select type Data: Flow rate unit

The following is the procedure of changing the flow rate unit as Select type parameter.

The flow rate unit needs to be specified with “Physical unit” and “Time unit” individually. When the flow rate unit needs to be set “l/min”, select “l (liter)” at the Physical unit and “/min” at the Time unit.

Display Menu Path:
 Device setup ▶ Detailed setup ▶ Pro var ▶ Volume ▶ Unit
 Device setup ▶ Detailed setup ▶ Pro var ▶ Volume ▶ Time Unit

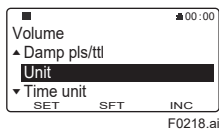

Specify the Physical unit for volumetric flow. Move cursor with [INC] and [DEC] according to the menu path above, and select the “unit” then push [SET].

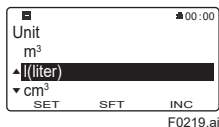

Move cursor with [INC] and [DEC], and select the “l(liter)” then push [SET]. As the selected unit is blinking, push [SET] to determin. The screen returns to the setting page.

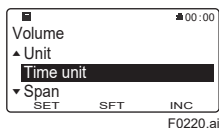

Specify the Time unit for volumetric flow. Move cursor with [INC] and [DEC] according to the menu path above, and select the “Time unit” then push [SET].

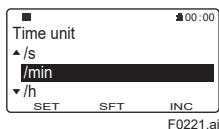

Move cursor with [INC] and [DEC], and select the “/min” then push [SET]. As the selected unit is blinking, push [SET] to determin. The screen returns to the setting page after the setting.

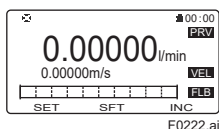

After completing the parameter setting, push [ESC] then the screen returns to the Display Mode.



NOTE

Be sure to set the Flow rate unit in the beginning when the Flow rate unit and Flow span value are changed at the same time.

When the unit is changed, the value of flow rate span is converted to related values automatically according to the unit change.

2.4.2 Setting example of Numeric type Data: Flow rate span

The following is the procedure of changing the Flow rate span as Numeric type parameter.

Display Menu Path:
 Device setup ▶ Detailed setup ▶ Pro var ▶ Volume ▶ Span



NOTE

Be sure to set the Flow rate unit in the beginning when the Flow rate unit and Flow span value are changed at the same time.

When the unit is changed, the value of flow rate span is converted to related values automatically according to the unit change.

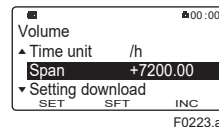

Specify the Flow rate span unit. Move cursor with [INC] and [DEC] according to the menu path above, and select the “Span” then push [SET].

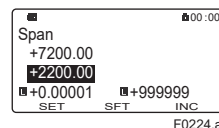

The switch's functionality of setting the Flow rate span is as below:
 Plus/minus and numeric change: [INC]
 Movement on digits: [SFT]
 Determination of parameter: [SET]
 [] : Minimum value
 [] : Maximum value
 Push [SET] to decide while the value of Flow rate span is blinking. The screen returns to the setting page after the setting.

2.4.3 Setting Example of Alphanumeric type Data: Tag No.

The following is the procedure of changing the Tag No. as Alphanumeric type parameter.

Display Menu Path:
Device setup ▶ Detailed setup ▶ Device info ▶ Order info ▶ Tag No.

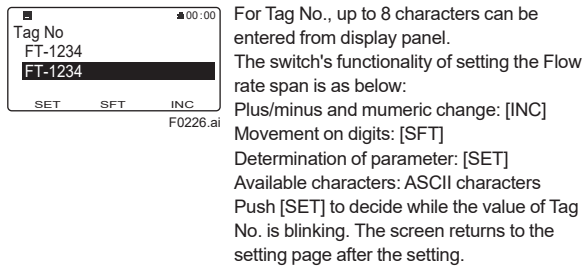
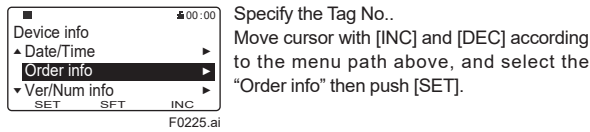

2.5 microSD Card Insertion/ Removal

For the device with optional code MC, by setting the dedicated microSD card into the slot on the display unit, the parameter setting can be stored into it. The stored data can be restored to the device. For the detailed function, read Chapter 4.



WARNING

Use only micro SD cards sold by YOKOGAWA. Operation cannot be guaranteed when other cards are used.

(1) microSD Card Insertion

Carefully insert the dedicated microSD card into the slot on the display unit until the slot holds the card. (see Figure 2.5).

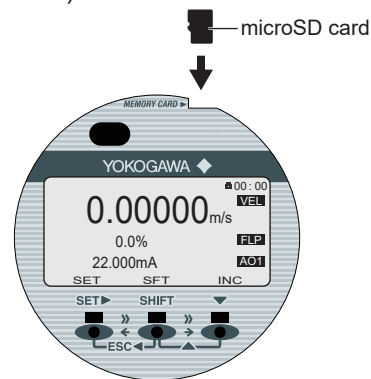

F0227.ai

Figure 2.5 microSD Card Insertion

(2) microSD Card Removal

The microSD is removed from the slot by pushing it. To prevent from losing the microSD card, be careful to handle the card.



IMPORTANT

If the microSD card is removed without execution of "Unmount" on parameter setting, it may result in the corruption of stored data and the abnormal operation of device.

Display Menu Path:
Device setup ▶ microSD ▶ Unmount

3. Operation with HART Configuration Tool

This chapter describes the connection of this instrument and HART configuration tool (FieldMate (Versatile Device Management Wizard)), and the operation using HART configuration tool. Read the user's manual of FieldMate (IM 01R01A01-01E) for details about the FieldMate.



NOTE

- For more details regarding the operations of the HART configuration tool, read the manual of HART configuration tool.
- When using FieldMate, be sure that the revision is R3.02.00 or later.



NOTE

Parameters on HART configuration tool are displayed in English only. Even if any language other than English is selected as “display language” from display panel, parameters are displayed in English on HART configuration tool.

3.1 Connecting the HART Configuration Tool

The HART configuration tool can interface with this device from the control room, this device site, or any other wiring termination point in the loop, provided there is a minimum load resistance of 230 Ω between the connection and the receiving instrument. To communicate, it must be connected in parallel with this device, and the connections must be non-polarized.

See Figure 3.1.

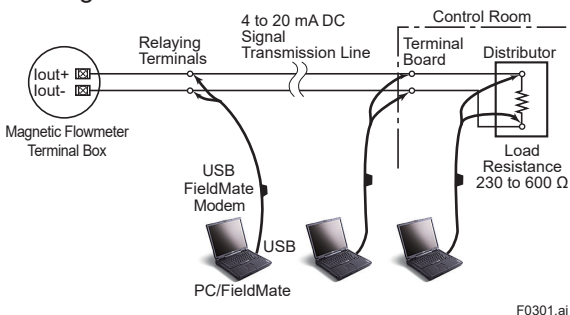

Figure 3.1 Connecting the HART Configuration Tool



IMPORTANT

Communication signal is superimposed on analog output signal. It is recommended to set a low-pass filter (approximately 0.1s) to the receiver in order to reduce the output effect from communication signal. Before online-communication, confirm that communication signal does not give effect on the upper system.

3.2 HART Configuration Tool and Device Revision



IMPORTANT

Protocol revision supported by HART configuration tool must be the same protocol revision or later than that of the device. If it is not, communication error occurs.

3.2.1 Device Description (DD) and Device Revision

Before using the HART configuration tool, confirm that the DD (Device Description) of this device is installed in the configuration tool. If correct DD is not installed to the configuration tool, install a correct DD from the HART official site, otherwise, contact the respective vendors of the configuration tool for its upgrade information.

The device revision is as follows.

DD Revision	1 or later
Device Type	AXW4A (0x371B)
Device Revision	1

• Confirmation of DD revision

- Turn on the power of the configuration tool under the standalone condition.
- Confirm the device revision from the installed DD file name according to the procedure provided for the configuration tool.

DD file name is four digits, upper two digits are device revision and lower two digits are DD revision.



NOTE

Device revision of DD file is given in hexadecimal.

• **Confirmation of Device revision**

Connect the configurator to this device and confirm the revision by the following parameter.

HART Communication Menu Path:	
Device root menu ▶	Detailed setup ▶
Device information ▶	HART setup ▶
	Fld dev rev

3.2.2 Device Type Manager (DTM) and Device Revision

When configure the parameters using FieldMate, use the DTM (Device Type Manager) reading the following table.

DTM Name	AXW HART 7 DTM
DTM Revision	5.6.4.0 or later *
Device Type	AXW4A (0x371B)
Device Revision	1

*: The DTM is included in Yokogawa DTM Library HART 6.5 or later.



NOTE

The DTM revision can be confirmed by “DTM setup”. Device Files is a Media included in FieldMate. The user registration site provides Device Files with the latest update programs. (URL: <https://voc.yokogawa.co.jp/PMK/>) In case update, following operation by “DTM setup” is required.

- Update DTM catalog
- Assign corresponding DTM to the device.

For details, read the user’s manual of FieldMate.

3.3 Basic Setup

If the dedicated parameters are specified at the time of ordering, this instrument is shipped with the tag number or device information configured. The tag number and device information can be checked as follows.

• **Menu path of the tag number and device information**

Item	HART Communication Menu Path
Tag, Long tag	Device root menu ▶ Detailed setup ▶ Device information ▶ Order information ▶ Tag, Long tag
Descriptor, Message, Date	Device root menu ▶ Detailed setup ▶ Device information ▶ HART setup ▶ Descriptor, Message, Date

• **Change of the tag number and device information**

Enter the information within the following limit number of characters.

Item	Limit number of characters
Tag	Up to 8 characters or numbers*1
Long Tag	Up to 32 characters or numbers*2
Descriptor	Up to 16 characters or numbers*1
Message	Up to 32 characters or numbers*1
Date	mm/dd/yyyy (DD) yyyy/mm/dd (DTM) - mm: month (2 digits) - dd: days (2 digits) - yyyy: years (4 digits)

*1: Symbols, characters and numbers enclosed by a thick line in the following table are available.

*2: All symbols, characters and numbers in the following table are available.

SP	!	"	#	\$	%	&	'	()	*	+	,	-	.	/
0	1	2	3	4	5	6	7	8	9	:	;	<	=	>	?
@	A	B	C	D	E	F	G	H	I	J	K	L	M	N	O
P	Q	R	S	T	U	V	W	X	Y	Z	[\]	^	_
`	a	b	c	d	e	f	g	h	i	j	k	l	m	n	o
p	q	r	s	t	u	v	w	x	y	z	{		}	~	

*: "SP" means a space.

3.4 Parameters Configuration

The parameter structure of the HART configuration tool is hierarchical.

For menu tree and parameter in details, read Chapter 4 and Chapter 5.

Note that some display parameters are different from those of HART configuration tools.



CAUTION

Note that parameter setting by the display unit is not available in the middle of communicating with HART configuration tool.

3.5 Data Renewing and Upload / Download Function

(1) Data Renewing

The data is automatically updated at 0.5 to 2 second cycles.

(2) Upload / Download Function

The upload function is used for copying the parameters of the instrument to a HART configuration tool. The download function is used for setting the copied parameters in the HART configuration tool into other instrument. The applicable parameters are the followings included in "Upload variables".

HART Communication Menu Path:

Upload variables▶ (see below)

Tag	Total2 fail opts	Suffix config 1	Electronic failure
Long tag	Total2 options	Suffix config 2	Device Configuration Locked
Descriptor	Total2 Start/Stop	Option 1	Status Simulation Active
Message	Total2 preset value	Option 2	Discrete Variables Simulation Active
Date	Total2 set point	Option 3	Event Notification Overflow
Final asmbly num	Total3 unit	Option 4	Secondary Analog Channel Saturated
Distributor	Total3 conv factor	Remote sensor basic model code	Tertiary Analog Channel Saturated
Model	Total3 low cut	Remote sensor suffix config 1	Quaternary Analog Channel Saturated
Dev id	Total3 fail opts	Remote sensor suffix config 2	Quinary Analog Channel Saturated
Poll addr	Total3 options	Remote sensor option 1	Subdevice list changed
PV is	Total3 Start/Stop	Remote sensor option 2	Duplicate master detected
SV is	Total3 preset value	Remote sensor option 3	Secondary Analog Channel Fixed
TV is	Total3 set point	Remote sensor option 4	Tertiary Analog Channel Fixed
QV is	Pulse1 output mode	Field device has malfunctioned due to a hardware error or failure	Quaternary Analog Channel Fixed
Alarm record mask 1	Frequency1 at 100%	10:Main board CPU failure	Quinary Analog Channel Fixed
Alarm record mask 2	Status output1 function	11:Reverse calculation failure	67:Pulse output 1 configuration error
Alarm record mask 3	Loop current mode	12:Main board EEPROM failure	68:Pulse output 2 configuration error
Alarm out mask 1	AO1 low cut*1	13:Main board EEPROM default	69:Nominal size configuration error
Alarm out mask 2	AO1 high limit	14:Sensor board failure	70:Adhesion configuration error
Alarm out mask 3	AO1 low limit	15:Sensor communication error	72:Data logging not started
Alarm out mask 4	AO1 alarm out	16:A/D1 failure[Signal]	80:Analog output 1 saturated
Low alarm*1	AO1 range mode	17:A/D2 failure[Exciter]	82:Pulse output 1 saturated
Low low alarm*1	Forward span 2*1	18:Coil open	83:Pulse output 2 saturated
High alarm*1	Reverse_span 1*1	19:Coil short	85:Cable misconnect

*1: This parameter cannot be displayed with FDT2.0 DTM. Possible with HART built-in DTM.

HART Communication Menu Path:

Upload variables ► (see below)

High high alarm*1	Auto range hyst	20:Exciter failure	86:Coil insulation warning
Hi/Lo alarm hysteresis	Bi direction hyst	21:PWM1 stop	131:Transmitter type mismatch
PV flow select	Flow direction	22:PWM2 stop	87:Adhesion over level 3
Velocity check	Display select1	23:Option board mismatch	92:Autozero warning
Velocity unit	Display select2	24:Option board EEPROM failure	93:Verification warning
Velocity span	Display select3	25:Option board A/D failure	95:Simulation active
Velocity damping AO/frequency	Display select4	26:Option board SPI failure	96:Analog output 1 fixed
Velocity damping pulse/total	Display select5	27:Parameter restore incomplete	98:Pulse output 1 fixed
Time unit	Display select6	28:Indicator board failure	99:Pulse output 2 fixed
Volume flow unit	Display select7	29:Indicator board EEPROM failure	101:Parameter restore running
Volume flow span	Display select8	30:LCD driver failure	102:Display over warning
Volume flow damping AO/frequency	Trend select 1	31:Indicator board mismatch	103:microSD size warning
Volume flow damping pulse/total	Trend select 2	32:Indicator communication error	104:Parameter backup incomplete
Mass flow unit	Trend select 3	33:microSD failure	105:microSD card mismatch
Mass flow span	Trend select 4	50:Signal overflow	106:microSD card removal procedure error
Mass flow damping AO/frequency	Display format PV	51:Empty pipe detection	120:Watchdog
Mass flow damping pulse/total	Display format total 1	52:H/L or HH/LL alarm	121:Power off
Density unit	Display format total 2	53:Adhesion over level 4	122:Instant power failure
Density fixed value	Display format total 3	60:Span configuration error	123:Parameter backup running
Nominal size unit	Display contrast	62:Analog output 1 4-20 mA limit error	124:Data logging running
Nominal size	Display line	64:Analog output 1 multi range error	130:Device ID not entered
User span select AO1	Display period	65:H/L HH/LL configuration error	
User unit AO1	Display NE107	66:Density configuration error	
User span AO1	Display alarm	Maintenance required	
Total1 unit	Display scroll	Device variable alert	
Total1 conv factor	Display damping	Critical Power Failure	
Total1 low cut*1	Display formate date	Failure	
Total1 fail opts	Display inversion	Out of Specification	
Total1 options	Language	Function Check	
Total1 Start/Stop	Display measure mode	Simulation Active	
Total1 preset value	Display installation	Non-Volatile Memory failure	
Total1 set point	Diagnostic output	Volatile Memory error	
Total2 unit	VF mode	Watchdog reset executed	
Total2 conv factor	VF No	Voltage conditions out of range	
Total2 low cut	Basic model code	Environmental conditions out of range	

*1: This parameter cannot be displayed with FDT2.0 DTM. Possible with HART built-in DTM.

3.6 Specific Functions of HART Configuration Tool

3.6.1 Burst Mode

(1) Applicable Parameter of Burst Mode

When the Burst Mode is enabled, the instrument continuously sends up to three data via HART communication. Also it is possible to send alarm signal continuously when change in parameter setting or self diagnosis is detected.



NOTE

When changing the setting of Burst Mode, set "Off" to the Burst mode. Default setting is "Off".

Command Parameter	Burst Command	Burst Message Trigger Mode	Burst Trigger Source	Burst Trigger Units
PV	Cmd1: PV	Continuous	---	---
		Window	PV	Depend on the assigned variable to PV
		Rising		
		Falling		
		On-change		
Loop Current and Percent Range	Cmd2: % range/current	Continuous	---	---
		Window	% range	%
		Rising		
		Falling		
		On-change		
PV, SV, TV, QV	Cmd3: Dyn vars/current	Continuous	---	---
		Window	PV	Depend on the assigned variable to PV
		Rising		
		Falling		
		On-change		
Device Variable with status	Cmd9: Device vars w/ status	Continuous	---	---
		Window	Process variable assigned to the top of Burst Device Variables	Depend on the assigned variable to Burst Device Variables
		Rising		
		Falling		
		On-change		
Device Variable	Cmd33: Device variables	Continuous	---	---
		Window	Process variable assigned to the top of Burst Device Variables	Depend on the assigned variable to Burst Device Variables
		Rising		
		Falling		
		On-change		
Additional Device Status	Cmd48: Read Additional Device Status	Continuous	---	---
		On-change	All status	---

(2) Burst Mode Setting

The Burst Mode can be specified in the Easy Burst Mode or the Detailed Burst Mode.

• **Setting of Easy Burst Mode**

The Easy Burst Mode can send one Burst Command continuously. The Easy Burst Mode can be configured with the following parameter.

HART Communication Menu Path:

- Device root menu ▶ Detailed setup ▶
- Device information ▶ HART setup ▶
- Burst setup ▶ Easy burst setup ▶ (see below)

set Easy Burst	Specify Easy Burst Mode. (BM0: Burst Message 0)
----------------	-------------------------------------------------



NOTE

When the Easy Burst Mode is used, the Event Notification can not be used.

• **Setting of Detailed Burst Mode**

The Detailed Burst Mode can send up to three Burst Commands continuously under various conditions. The Detailed Burst Mode can be configured with the following parameter.

HART Communication Menu Path:

- Device root menu ▶ Detailed setup ▶
- Device information ▶ HART setup ▶
- Burst setup ▶ Detailed burst setup ▶ (see below)

BM1 Setting ▶ set Detailed Burst	Specify Detailed Burst Mode. (BM1: Burst Message 1)
BM2 Setting ▶ set Detailed Burst	Specify Detailed Burst Mode. (BM2: Burst Message 2)
BM3 Setting ▶ set Detailed Burst	Specify Detailed Burst Mode. (BM3: Burst Message 3)

In accordance with the method, specify the followings.

- Burst Command
- Update Period/Max Update Period
- Burst Message Trigger Mode

(3) Burst Command Setting

Select the transmission data from the Burst Command.

Burst Command	Command Parameter
Cmd1:PV	PV
Cmd2:% range/ current	Loop Current and Percent Range
Cmd3:Dyn vars/ current	PV, SV, TV, QV
Cmd9: Device vars w/ status	Device Variable with status
Cmd33:Device Variables	Device Variable
Cmd48:Read Additional Device Status	Additional Device Status

(4) Burst Device Variables Setting

When "Cmd9: Device vars w/ status" or "Cmd33:Device Variables" is selected as Burst Command, it is required to specify the Burst Device Variables which up to six values can be specified for.

Dev Var Code	Burst Device Variables	Dev Var Code	Burst Device Variables
0	Velocity	3	Totalizer 1
1	Volume flow	4	Totalizer 2
2	Mass flow	5	Totalizer 3

(5) Update Period/Max Update Period Setting

Specify the Update Period/Max Update Period which is the update period of Burst Message Trigger Mode.

The Burst Trigger Source is checked with a period of Update Period, and if it fulfills the condition of Burst Message Trigger Mode, the data is updated. When it does not fulfill the condition of the Trigger Mode with a period of Update Period and reaches the Max Update Period, the data is updated forcibly.

The Update Period/Max Update Period needs to be selected from the followings.

Update Period/Max Update Period	
0.5 s	8 s
1 s	16 s
2 s	32 s
4 s	60 s to 3600 s (any value)



NOTE

To the Update Period, specify a value smaller than the Max Update Period.

(6) Burst Message Trigger Mode Setting

Specify Burst Message Trigger Mode. When "Window", "Rising" or "Falling" is selected, it is needed to specify the Burst Trigger Level.

Burst Message Trigger Mode	Description
Continuous	Burst Message is transmitted continuously.
Window	The trigger value must be a positive number and is the symmetric window around the last communicated value.
Rising	The Burst Message must be transmitted when the source value exceeds the threshold established by the trigger value.
Falling	The Burst Message must be transmitted when the source value fall below the threshold established by the trigger value.
On-change	The Burst Message must be transmitted when the source value on change established by the trigger value.

3.6.2 Event Notification

It is possible to send alarm signal continuously when change in configuration or self diagnosis is detected as Event. Up to five Event occurred can be stored as History. When Event Notification is used, it is needed to specify Detailed Burst Message and to enable Burst Message.



NOTE

Nate that the Event which is stored as History is deleted when the power is turned off.

(1) Event Notification Setting

The Event Notification can be configured with the following parameter.

HART Communication Menu Path:

Device root menu ▶ Detailed setup ▶
 Device information ▶ HART setup ▶
 Event setup ▶ (see below)

set Event	Specify Event Notification.*1
stop Event	Specify stopping Event Notification.

*1: From the table below, select configuration of the Event Notification.

Event Mask	Specify device status to detect Event. (Event Mask) (Cmd48: Read Additional Device Status)
Event Notification Retry Time	Specify period of Event Notification when Event is occurring.
Max Update Time	Specify period of Event Notification when Event does not be occurring.
Event Debounce Interval	Specify minimum time that Event is continuing.

(2) Event Acknowledgment

If a Event is occurring, it is required to acknowledge it. Acknowledgment of Event can be configured with the following parameter.

HART Communication Menu Path:

Device root menu ▶ Detailed setup ▶
 Device information ▶ HART setup ▶
 Event setup ▶ (see below)

acknowledge Event	Specify acknowledgment of Event.
-------------------	----------------------------------



NOTE

Acknowledgment can be done only to the Event which occurs firstly. When multiple Events occur, it is required to acknowledge all of them.

(3) Event Notification Flow

When the Event Notification is enabled, a status change caused by the self-diagnosis of the instrument will alarm Event1. Event1 is continuously transmitted at the Retry Time interval until Event1 is acknowledged.

If the other status change occurred before Event1 acknowledgment, Event2 is kept internal and Event1 is continuously transmitted until Event1 acknowledgment. When Event1 was acknowledged, Event1 disappears and Event2 is continuously transmitted until the acknowledgment. When Event2 was acknowledged, all Events were acknowledged and Event is continuously transmitted at a interval of the Max Update Time.

3.6.3 Multidrop Mode

When the multidrop mode possible to connect multiple devices is used, this instrument can connect up to 63 devices on a single communication transmission line. To activate the multidrop mode, a number from 1 to 63 must be assigned to the polling address. When the multidrop mode is activated, it is also needed to change a setting of the 4 to 20 mA analog output signal because all the data is transmitted in digital one. The multidrop mode can be configured by the following procedures.

(1) Polling Address Setting

Assign a number from 1 to 63 to the polling address.

HART Communication Menu Path:

Device root menu ► Detailed setup ►
Device information ► HART setup ► (see below)

Poll addr	Specify polling address.
-----------	--------------------------



NOTE

When the same polling address is set for two or more devices in the multidrop mode, communication with these devices is disabled.

(2) Analog Output Setting

Usually, fix an analog output signal of multidrop mode to 4 mA. In this case, however, it is impossible to use a burnout output. In the case of the application which receives and operates an analog output signal, one variable analog output signal can be used for one loop. The analog output of multidrop mode can be configured with the following parameter.

HART Communication Menu Path:

Device root menu ► Detailed setup ►
Device information ► HART setup ► (see below)

Loop current mode	Specify analog output.*1
-------------------	--------------------------

*1: From the table below, select an analog output of multidrop mode.

Disabled	Specify analog output to 4mA (fixed).
Enabled	Specify analog output to 4 to 20 mA (variable).



NOTE

The analog output signal which is fixed by multidrop mode is applied only to the output of I/O1 terminal.

(3) Enabling Multidrop Mode

Configure the settings of polling for a receiving instrument referring to the user's manual of each HART configuration tool.

(4) Communication in Multidrop Mode

- When a device and a HART configuration tool start the connection, the tool searches for the device set in the multidrop mode, the polling address and the tag will be displayed.
- After the desired device is selected, normal communication with the selected device is possible. However the communication speed will be slow.

(5) Release of Multidrop Mode

To release the multidrop mode, the parameter needs to be configured as below.

- Specify the polling address of (1) to "0".
- Specify the analog output of (2) to "Enabled".

4. Functions

This chapter describes each function of the instrument. The followings present an overview of each function.

- **Basic settings**

This instrument can measure the process values of the flow velocity, volumetric flow rate, and mass flow rate, simultaneously. In addition, the damping time constant for each process value can be specified.

For details about how to check the measurement result and the setting procedure, read Section 4.1.

- **Totalization function**

This instrument has three totalizers for the process values. In addition to the display with the totalized value, the totalizer function is provided to scale the totalized value with the conversion factor and count a specific flow rate. Also, it has a totalization switch function that compares the specified target value with the totalized value to output the result with the status output, and a totalization preset function that specifies the preset value.

For details about the totalization function and setting procedure, read Section 4.2.

- **Pulse output, frequency output, and status output**

The measurement result can be output with one of the pulse output, frequency output, or status output. When the pulse output is used, the pulse width or pulse rate can be selected. When the frequency output is used, an output at 0% or 100% for the span of the process value can be specified. When the status output is used, the device status can be output with the status output. Both pulse output and frequency output can be set their low cut value each.

For details about each output and the setting procedure, read Section 4.3.

- **Status input**

The status input terminal is provided to use the totalizer preset function or the zero-adjustment function depending on an external status input. For details about the setting procedure, read Section 4.4.

- **Current output**

These are the high/low limit function, forward/reverse flow rate function (reverse flow rate: 4 to 12 mA, forward flow rate: 12 to 20 mA), alarm output function, low cut function, and other functions. For details about the current output setting procedures, read Section 4.5.

- **Multi range function**

This function performs to make measurements while switching multiple ranges. It is possible to switch the range depending on the flow rate, flow rate direction, or status input.

For details about the multi range function, read Section 4.6.

- **Auxiliary calculation function**

For details about the auxiliary calculation function, read Section 4.7.

- **Alarm**

A detected error can be notified as an alarm or warning. This function shows its status based on NAMUR NE107 to suit parameter settings. It is also to record the previously detected alarms as a history and mask unnecessary alarms to disappear them from the display.

For details about the alarm contents and the setting procedure, read Section 4.8.

- **Display**

This display supports multiple languages to select the language to be used on the display. Also, this function shows a time change of the selected parameter as a trend graph on the display.

For details about the display settings, read Section 4.9.



NOTE

The default setting of the language is English upon shipment from the manufacturing plant. Change the language by referring to Subsection 2.2.2 or Subsection 4.9.1 if necessary.

This user's manual shows English at the menu pass of the display.

- **Device information**

This function is to check the parameters specified at the time of ordering, model code, and suffix code of this instrument on the display.

For details about how to check device information, read Section 4.10.

- **Diagnostic function**

There are many kinds of diagnostic functions, and it is possible to diagnose failure of the instrument or process status. For example, this function is useful to diagnose the health of the instrument using the electrode adhesion detecting function, sensor empty check function, or the verification function.

For details about various diagnostic functions, read Section 4.11.

- **Test mode**

This mode is arbitrarily to specify the process value or the value to be output from a connection terminal and test a response from the device.

For details about the test mode, read Section 4.12.

- **Backup, restore, and duplicate functions**

The backup function can be store the setting parameters into the built-in memory in the display. If the optional code MC is selected, the setting parameters are stored in the microSD card supplied with this instrument in addition to the built-in memory in the display.

The backup data can be used to restore settings in the instrument in which they were backed up, or duplicate settings to another instrument.

For details about the backup, restore, and duplicate functions, read Section 4.13.

- **Software write protection function**

The software write protection function for disabling a parameter change is provided separately from the hardware write protection.

For details about the software write protection function, read Chapter 4.14.

4.1 Basic Settings

4.1.1 Overview

This instrument can simultaneously measure the flow velocity, volumetric flow rate, and mass flow rate. The measurement result can be output as the current output, frequency output, pulse output, and/or status output.

The table below shows the communication / input-output codes, connection terminals, and input and output for each terminal.

Communication and I/O code		Connection Terminal			
HART		I/O1	I/O2	I/O3	I/O4
JA	E	Iout1 Active	P/Sout1 Passive	-	-
JE	J			Sin No-voltage	P/Sout2 Passive
JG	L			Sin No-voltage	P/Sout2 Active (Without resistor)

Iout1: Current output with HART communication

P/Sout1: Pulse output or status output

P/Sout2: Pulse output or status output

Sin: Status input

The position of Communication and I/O code:

Integral Type:

AXW□□□-□□□□□□□□□□□□□□-□□□□□

AXW□□□G-■□□□□□-□□□□-□□□□

Remote Transmitter:

AXW4A-□□□□□□□□■□□□



NOTE

The available functions vary depending on the connection terminal type selected at the time of ordering. Need to read above table carefully before use which terminal is applicable to allocate each function.

4.1.2 PV Mapping of Process Value

This function can allow you to map the flow velocity, volumetric flow rate, and mass flow rate as the primary variable (PV). The PV-mapped process value is output from the I/O1 terminal.

This setting can be configured with the following parameters.

Display menu path:

Device setup ► Detailed setup ► Pro var ► PV flow select ► (see below)

Velocity	Sets the flow velocity to the Primary Value.
Volume	Sets the volumetric flow rate to the Primary Value.
Mass	Sets the mass flow rate to the Primary Value.

HART communication:

Device root menu ► Detailed setup ► Process variables ► PV flow select ► (see below)

Velocity	Sets the flow velocity to the Primary Value.
Volume	Sets the volumetric flow rate to the Primary Value.
Mass	Sets the mass flow rate to the Primary Value.

Setting example: If the volumetric flow rate is set to PV, and the volumetric flow rate span is set to 100 m³/h for use, set the parameters as follows.

- PV flow select="Volume"
- Volume flow unit="m³"
- Time unit="/h"
- Volume flow span="100.000"

Setting example: If the mass flow rate is set to PV, with the mass flow rate span being set to 10,000 kg/h and the density to 1000 kg/m³ for use, set the parameters as follows.

- Density unit="kg/m³"
- Density fixed value="1000.000"
- PV flow select="Mass"
- Mass flow unit="kg"
- Time unit="/h"
- Mass flow span="10000.0"

4.1.3 Display of the Process Value

The flow velocity, volumetric flow rate, mass flow rate, and totalized value can be viewed with the following parameters.

Display menu path:

Device setup ► Process variables ► (see below)

Flow rate(%)	Displays the range rate for the process value set to the Primary Value.
Flow rate	Displays the process value set to the Primary Value.
Velocity	Displays the flow velocity.
Volume	Displays the volumetric flow rate.
Mass	Displays the mass flow rate.
Totalizer ► Totalizer 1	Displays the totalized value of totalizer 1.
Totalizer ► Totalizer 2	Displays the totalized value of totalizer 2.
Totalizer ► Totalizer 3	Displays the totalized value of totalizer 3.

HART communication:

Process variables root menu ► Dynamic variables ► (see below)

PV	Displays the process value set to the Primary Value.
PV % mge	Displays the range rate for the process value set to the Primary Value.

Process variables root menu ► Device variables ► (see below)

Velocity	Displays the flow velocity.
Volume flow	Displays the volumetric flow rate.
Mass flow	Displays the mass flow rate.
Totalizer1	Displays the totalized value of totalizer 1.
Totalizer2	Displays the totalized value of totalizer 2.
Totalizer3	Displays the totalized value of totalizer 3.

4.1.4 Engineering Unit Setting

The unit can be specified for the flow velocity, volumetric flow rate, and mass flow rate. Each parameter can be specified using the physical unit and time unit.

For example, when setting "m³/h" as the volumetric flow rate, specify "m³" (physical quantity) and "h" (time unit) individually.

However, the time unit is commonly set regardless of the kinds of fluid.

The time unit of the flow velocity is fixed to "/s", which do not require settings to be made by the user.

The setting can be configured with the following parameters.

Display menu path:

Physical unit
 Device setup ► Detailed setup ► Pro var ► (see below)

Velocity ► Unit	Specify the physical unit of the flow velocity.
Volume ► Unit	Specify the physical unit of the volumetric flow rate.
Mass ► Unit	Specify the physical unit of the mass flow rate.

Time unit

Device setup ► Detailed setup ► Pro var ► (see below)

Volume ► Time unit	Specify the time unit of the volumetric flow rate, or mass flow rate.
Mass ► Time unit	

HART communication:

Physical unit
 Device root menu ► Detailed setup ► Process variables ► (see below)

Velocity ► Velocity unit	Specify the physical unit of the flow velocity.
Volume flow ► Volume flow unit	Specify the physical unit of the volumetric flow rate.
Mass flow ► Mass flow unit	Specify the physical unit of the mass flow rate.

Time unit

Device root menu ► Detailed setup ► Process variables ► (see below)

Volume flow ► Time unit	Specify the time unit of the volumetric flow rate, or mass flow rate.
Mass flow ► Time unit	

4.1.5 Span Setting

The span can be specified for the flow velocity, volumetric flow rate, and mass flow rate. However, the span unit conforms to that specified in Subsection 4.1.4. If the unit is changed, the span value is changed to the corresponding value synchronously with the changed unit.

This setting can be configured with the following parameters.

Display menu path:

Device setup ► Detailed setup ► Pro var ► (see below)

Velocity ► Span	Specify the span of the flow velocity.
Volume ► Span	Specify the span of the volumetric flow rate.
Mass ► Span	Specify the span of the mass flow rate.

HART communication:

Device root menu ► Detailed setup ► Process variables ► (see below)

Velocity ► Velocity span	Specify the span of the flow velocity.
Volume flow ► Volume flow span	Specify the span of the volumetric flow rate.
Mass flow ► Mass flow span	Specify the span of the mass flow rate.



NOTE

Be sure to note the following points when specifying the flow rate span.

- For a line with a significant flow change, set the flow rate span to the maximum flow rate. If the flow rate exceeds the flow rate span, the flow rate error as its percentage increases.
- For a line with the stable flow rate, set the flow rate span to approximately 1.5 to 2.0 times toward the normal flow rate.
- Specify the flow rate for which the flow velocity is included within the range from 0.3 to 10 m/s. The flow velocity can be checked using the sizing data described in the general specifications as listed in Table 1.1. If the flow velocity is checked using the parameter, it displays the value obtained by converting the specified flow rate span to the flow velocity.



NOTE

Be sure to set the flow rate unit in the beginning when the span value and its flow rate unit are changed at the same time.

4.1.6 Damping Time Constant Setting

The damping time constant (63.2% response) can be specified for the flow velocity, volumetric flow rate, and mass flow rate. When reducing an output fluctuation or changing the response speed, change the damping time constant (default value as 3.0 seconds).

It is possible to measure the pulsing flow up to 1 Hz with the value of 0.1 second on this function in case of a piston pump, etc...

This function is applicable to specify each output of the process value (current output or frequency output, and pulse output or totalized value).

This setting can be configured with the following parameters.

Display menu path:

Current output / Frequency output

Device setup ► Detailed setup ► Pro var ► (see below)

Velocity ► Damp AO/F	Specify the damping time constant toward flow velocity.
Volume ► Damp AO/F	Specify the damping time constant of the volumetric flow rate.
Mass ► Damp AO/F	Specify the damping time constant of the mass flow rate.

Pulse output / Totalization

Device setup ► Detailed setup ► Pro var ► (see below)

Velocity ► Damp pls/ttl	Specify the damping time constant of the flow velocity.
Volume ► Damp pls/ttl	Specify the damping time constant of the volumetric flow rate.
Mass ► Damp pls/ttl	Specify the damping time constant of the mass flow rate.

HART communication:

Current output / Frequency output

Device root menu ► Detailed setup ►

Process variables ► (see below)

Velocity ► Velocity damping AO/frequency	Specify the damping time constant of the flow velocity.
Volume flow ► Volume flow damping AO/frequency	Specify the damping time constant of the volumetric flow rate.
Mass flow ► Mass flow damping AO/frequency	Specify the damping time constant of the mass flow rate.

Pulse output / Totalization

Device root menu ► Detailed setup ►

Process variables ► (see below)

Velocity ► Velocity damping pulse/total	Specify the damping time constant of the flow velocity.
Volume flow ► Volume flow damping pulse/total	Specify the damping time constant of the volumetric flow rate.
Mass flow ► Mass flow damping pulse/total	Specify the damping time constant of the mass flow rate.



NOTE

The output fluctuation increases when the damping time constant is set to lower value. Set the damping time constant to 5 seconds or longer for control processing application.

4.1.7 Low-cut Function Setting

The low-cut value can be specified for the current output, frequency output, pulse output, and totalizer. The fluctuation output at the flow rate "0" can be reduced when this function is used, because the output of the set value or less becomes "0" forcibly. However, the unit of low-cut value conforms to that specified in Subsection 4.1.4. If the unit is changed, the low-cut value is changed to the corresponding value synchronously with the changed unit. Set "0" to the low-cut value if it is unnecessary to use this function. This setting can be configured with the following parameters.

Display menu path:

Current output

Device setup ► Detailed setup ► Analog out/in ► (see below)

AO1 ► Low cut	Specify the low-cut value of current output 1.
---------------	------------------------------------------------

Frequency output / Pulse output

Device setup ► Detailed setup ►

Pulse/Status out ► (see below)

PO1/SO1 ► Low cut	Specify the low-cut value of frequency output 1 or pulse output 1.
PO2/SO2 ► Low cut	Specify the low-cut value of frequency output 2 or pulse output 2.

Totalization

Device setup ► Detailed setup ► Totalizer ► (see below)

Totalizer 1 ► Low cut	Specify the low-cut value of totalizer 1.
Totalizer 2 ► Low cut	Specify the low-cut value of totalizer 2.
Totalizer 3 ► Low cut	Specify the low-cut value of totalizer 3.

HART communication:

Current output

Device root menu ► Detailed setup ►

Analog output/input ► (see below)

Analog output 1 ► AO1 low cut	Specify the low-cut value of current output 1.
----------------------------------	------------------------------------------------

Frequency output / Pulse output

Device root menu ► Detailed setup ►

Pulse/Status ► (see below)

Pulse/Status output 1 ► Pulse1 low cut	Specify the low-cut value of frequency output 1 or pulse output 1.
Pulse/Status output 2 ► Pulse2 low cut	Specify the low-cut value of frequency output 2 or pulse output 2.

Totalization

Device root menu ► Detailed setup ►

Totalizer ► (see below)

Totalizer1 ► Total1 low cut	Specify the low-cut value of totalizer 1.
Totalizer2 ► Total2 low cut	Specify the low-cut value of totalizer 2.
Totalizer3 ► Total3 low cut	Specify the low-cut value of totalizer 3.

The hysteresis is set in each case in which the output is changed to "0" through the specified low-cut value and a case in which the output returns to measuring value through the specified low-cut value. The hysteresis in each case is obtained as shown below.

For details about the multi range function, read Section 4.6.

- (1) A value with the output changed to "0" through the specified low-cut value
= Low-cut value - (Minimum span specified in multi range x 0.5%)
- (2) A value with the output returned through the specified low-cut value
= Low-cut value + (Minimum span specified in multi range x 0.5%)

Example:

Span of volumetric flow rate = 10.0 m³/h,

Low-cut value = 1.0 m³/h

In this case, each value is obtained as shown below.

- (1) The value with output changed to "0" through the specified low-cut value
= 1.0 [m³/h] - (10.0 [m³/h] × 0.5 [%])
= 0.95 [m³/h]
- (2) The value with output returned through the specified low-cut value
= 1.0 [m³/h] + (10.0 [m³/h] × 0.5 [%])
= 1.05 [m³/h]

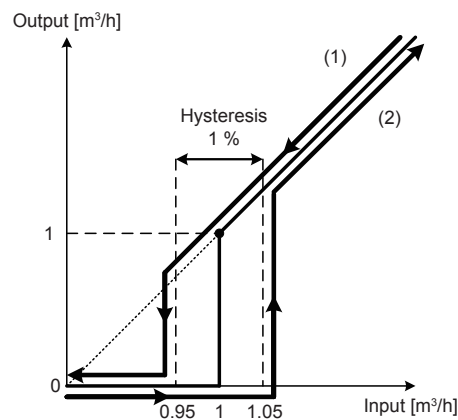

F0401.ai



NOTE

Note that, if the low-cut value is lower, the totalization might be counted due to an influence of output fluctuation near the output 0%. In particular, if the flow rate span, damping time constant, or conductivity is small or low, the totalization is easily counted when the flow rate is "0". In such a case, increase the flow rate span, damping time constant, or low-cut value.



NOTE

When the output process value is changed, specify the low-cut value again.

4.1.8 Sensor's Nominal Size Setting

To combine the remote transmitter with other remote sensor, the nominal size of the remote sensor must be specified. This setting can be configured with the following parameters.

Display menu path:

Device setup ► Detailed setup ► Sensor ► (see below)

Nominal size unit	Specify the unit of the nominal size.
Nominal size	Specify the nominal size.

HART communication:

Device root menu ► Detailed setup ► Sensor ► (see below)

Nominal size unit	Specify the unit of the nominal size.
Nominal size	Specify the nominal size.



NOTE

For the integral type, the nominal size and its unit have been set at the factory shipment. Do not change the these parameters.

4.1.9 Density Setting

The density setting is required to measure the mass flow rate.

It will result in a setting error that "0" is set to the density in the situation of mapping the mass flow to PV.

This setting can be configured with the following parameters.

Display menu path:

Device setup ► Detailed setup ► Pro var ► Density ► (see below)

Unit	Specify the unit of the density.
Fixed density	Specify the fixed density value.

HART communication:

Device root menu ► Detailed setup ► Process variables ► Density ► (see below)

Density unit	Specify the unit of the density.
Density fixed value	Specify the fixed density value.

4.1.10 Zero Adjustment

Zero adjustment is carried out to ensure that the output for zero flow is 0% (i.e., 4 mA). Although adjustment to zero is performed at the manufacturing plant prior to shipment, this procedure must be carried out once again following the installation of piping in order to match the magnetic flowmeter to its operating conditions. This subsection describes the zero adjustment procedure using the display unit. For AXFA11, read the applicable user's manual as listed in Table 1.1.



IMPORTANT

- Zero adjustment should be carried out before actual operation. Note that setting and update functions cannot be carried out during this procedure (i.e., for approximately 30 seconds).
- Zero adjustment should only be carried out when the sensor has been filled with measurement fluid and the fluid velocity is completely zero by closing the valve.
- Each time that the fluid being measured is changed, it will be necessary for zero adjustment to be carried out for the new fluid.

A procedure of executing zero adjustment is as follows;

Display Menu Path:
 Device setup ▶ Diag/Service ▶ Autozero ▶ Execute
 Device setup ▶ Diag/Service ▶ Autozero ▶ Result ▶ Zero value

Enter the Setting Mode. (Read Section 2.3)

• Execution of zero adjustment

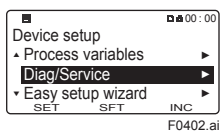

Select "Diag/Service" according to the menu path above.

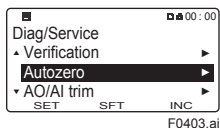

Select "Autozero".

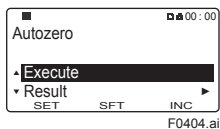

Select "Execute".

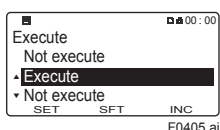

Select "Execute".

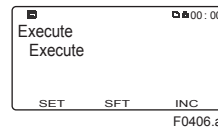

When "Execute" blinks, touch [SET] to execute.

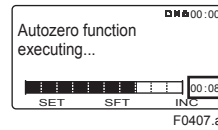

Autozero starts, and the progress is displayed with a remaining time and a bar graph. Wait for the completion.

← The time remaining until the end.

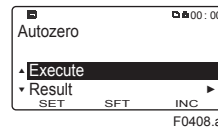

After Autozero finished, the display returns to "Autozero" menu.

• Confirmation of zero adjustment result

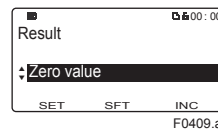

For the result of Autozero, select "Result" and then "Zero value".

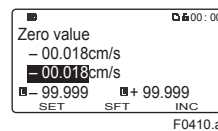

Result of Autozero is indicated as on the left.



NOTE

When the zero adjustment result exceeds defined value, the warning [092: AZ wam] is indicated.

Zero adjustment can be executed with the following parameter.

HART Communication Menu Path:
 Device root menu ▶ Basic setup ▶ Autozero ▶ Autozero Exe

4.2 Totalization Function

4.2.1 Totalized Value and Unit Setting

This function can totalize the volumetric flow rate, and mass flow rate. This instrument provides three totalizers, which can simultaneously operate them for process values.

Totalizer 1 is for the process value PV-mapped described in Subsection 4.1.2. Totalizers 2 and 3 are for the process value in the selected unit. This setting can be displayed and configured with the following parameters.

Display menu path:

Device setup ► Detailed setup ► Totalizer ► (see below)

Totalizer 1 ► Unit	Displays the unit of totalizer 1.
Totalizer 2 ► Unit	Specify the unit of totalizer 2.
Totalizer 3 ► Unit	Specify the unit of totalizer 3.

HART communication:

Device root menu ► Detailed setup ► Totalizer ► (see below)

Totalizer1 ► Total1 unit	Displays the unit of totalizer 1.
Totalizer2 ► Total2 unit	Specify the unit of totalizer 2.
Totalizer3 ► Total3 unit	Specify the unit of totalizer 3.



NOTE

The flow velocity cannot be totalized. If the flow velocity is selected as the Primary Value, totalizer 1 obtains the volumetric flow rate and unit based on "m³".

4.2.2 Totalized-Value Display and Totalizer Function

The totalization result can be checked with the totalized value or its value which is scaled with the conversion factor. When the totalized value is scaled with the conversion factor, the specified flow rate is totalized in 1-count increments, which can be used as a totalizer.

If the totalized value on the display exceeds ±99999999, the maximum value of the displayed digits, the displayed value is reset to 0.

The totalized value can be displayed and specified with the following parameters.

Display menu path:

Display of totalized value

Device setup ► Detailed setup ► Totalizer ► (see below)

Totalizer 1	Displays the totalized value of totalizer 1.
Totalizer 2	Displays the totalized value of totalizer 2.
Totalizer 3	Displays the totalized value of totalizer 3.

Setting of the conversion factor for scaling

Device setup ► Detailed setup ► Totalizer ► (see below)

Totalizer 1 ► Conv factor	Specify the conversion factor of totalizer 1.
Totalizer 2 ► Conv factor	Specify the conversion factor of totalizer 2.
Totalizer 3 ► Conv factor	Specify the conversion factor of totalizer 3.

Display of the totalized value that is scaled with the conversion factor

Device setup ► Detailed setup ► Totalizer ► (see below)

Totalizer 1 count	Displays the scaled totalized-value of totalizer 1.
Totalizer 2 count	Displays the scaled totalized-value of totalizer 2.
Totalizer 3 count	Displays the scaled totalized-value of totalizer 3.

HART communication:

Display of totalized value

Process variables root menu ►

Device variables ► (see below)

Totalizer1	Displays the totalized value of totalizer 1.
Totalizer2	Displays the totalized value of totalizer 2.
Totalizer3	Displays the totalized value of totalizer 3.

Setting of the conversion factor for scaling

Device root menu ► Detailed setup ►

Totalizer ► (see below)

Totalizer1 ► Total1 conv factor	Specify the conversion factor of totalizer 1.
Totalizer2 ► Total2 conv factor	Specify the conversion factor of totalizer 2.
Totalizer3 ► Total3 conv factor	Specify the conversion factor of totalizer 3.

Display of the totalized value that is scaled with the conversion factor

Process variables root menu ►

Totalizer count ► (see below)

Totalizer1 count	Displays the scaled totalized-value of totalizer 1.
Totalizer2 count	Displays the scaled totalized-value of totalizer 2.
Totalizer3 count	Displays the scaled totalized-value of totalizer 3.

Example:

Set the unit of totalizer 2 to "m³" and the conversion factor to "2".

→If the totalized value of totalizer 2 is set to "10.123 m³", the totalized value is scaled to "10.123÷2 = 5".



NOTE

If Main soft rev (Main board revision/Main soft rev) is R1.01.06 or earlier, or Ind soft rev (Indicator board revision/Ind soft rev) is R2.01.01 or earlier, the totalized value on the display is held at the upper limit if it exceeds ±99999999, the maximum value of the displayed digits. For details about how to check the device revision (Main soft rev and Ind soft rev), refer to Subsection 4.10.2.

4.2.3 Totalization Switch Function

The totalization switch function is available when the target value (set point) to be totalized is specified using the totalization function. The totalization switch function compares the specified target value with the totalized value to output the result with the status output.

The status output is active while the totalized value is out of the specified target value. Even if the totalized value exceeds the displayed digit limit and is reset to 0 under that state, the status output remains active.

For details about the output, active direction, and status output function setting for each terminal, read Section 4.3.

This setting can be configured with the following parameters.

Display menu path:

Device setup ► Detailed setup ► Totalizer ► (see below)

Totalizer 1 ► Set point	Specify the target value of totalizer 1.
Totalizer 2 ► Set point	Specify the target value of totalizer 2.
Totalizer 3 ► Set point	Specify the target value of totalizer 3.

HART communication:

Device root menu ► Detailed setup ►

Totalizer ► (see below)

Totalizer1 ► Total1 set point	Specify the target value of totalizer 1.
Totalizer2 ► Total2 set point	Specify the target value of totalizer 2.
Totalizer3 ► Total3 set point	Specify the target value of totalizer 3.

Example: Setting procedure to use the totalization switch function with the I/O2 terminal

Follow the steps below to set the status output of the I/O2 terminal to "On active" when the totalized value of totalizer 1 reaches the target value.

- (1) Set the output of the I/O2 terminal to "Status out", referring to Subsection 4.3.1.
- (2) Set the active direction of the I/O2 terminal to "On active", referring to Subsection 4.3.4.
- (3) Set the status output function to "Total limit 1", referring to Subsection 4.3.7.
- (4) Specify the target value of totalizer 1, referring to this subsection.

4.2.4 Totalizer Operation at Alarm Occurrence

The totalizer operation can be specified to deal with an alarm that affects the totalization function. This setting can be configured with the following parameters.

Display menu path:

Device setup ► Detailed setup ► Totalizer ► (see below)

Totalizer 1 ► Failure opts	Specify the totalizer 1 operation to be performed when an alarm has occurred.*1
Totalizer 2 ► Failure opts	Specify the totalizer 2 operation to be performed when an alarm has occurred.*1
Totalizer 3 ► Failure opts	Specify the totalizer 3 operation to be performed when an alarm has occurred.*1

HART communication:

Device root menu ► Detailed setup ► Totalizer ► (see below)

Totalizer1 ► Total1 fail opts	Specify the totalizer 1 operation to be performed when an alarm has occurred.*1
Totalizer2 ► Total2 fail opts	Specify the totalizer 2 operation to be performed when an alarm has occurred.*1
Totalizer3 ► Total3 fail opts	Specify the totalizer 3 operation to be performed when an alarm has occurred.*1

*1: From the table below, select the operation of the totalization function.

Run	Continues the totalization function after an alarm has occurred.
Hold	Stops the totalization function after an alarm has occurred.
Last valid	Continues the totalization function with the last valid value before an alarm occurs.

4.2.5 Totalization Function Start/Stop Setting

The totalization function can be set to Start/Stop mode.

This setting can be configured with the following parameters.

Display menu path:

Device setup ► Detailed setup ► Totalizer ► (see below)

Totalizer 1 ► Start/Stop	Sets Start/Stop to the totalization function of totalizer 1.
Totalizer 2 ► Start/Stop	Sets Start/Stop to the totalization function of totalizer 2.
Totalizer 3 ► Start/Stop	Sets Start/Stop to the totalization function of totalizer 3.

HART communication:

Device root menu ► Detailed setup ► Totalizer ► (see below)

Totalizer1 ► Total1 Start/Stop	Sets Start/Stop to the totalization function of totalizer 1.
Totalizer2 ► Total2 Start/Stop	Sets Start/Stop to the totalization function of totalizer 2.
Totalizer3 ► Total3 Start/Stop	Sets Start/Stop to the totalization function of totalizer 3.



NOTE

The totalization function is set to "Stop" upon shipment from the manufacturing plant. To start the totalization function, be sure to set it to "Start".

4.2.6 Totalization Direction Setting

The totalization direction can be specified to use the totalization function.

This setting can be configured with the following parameters.

Display menu path:

Device setup ► Detailed setup ► Totalizer ► (see below)

Totalizer 1 ► Options	Specify the totalization direction of totalizer 1.*1
Totalizer 2 ► Options	Specify the totalization direction of totalizer 2.*1
Totalizer 3 ► Options	Specify the totalization direction of totalizer 3.*1

HART communication:

Device root menu ► Detailed setup ► Totalizer ► (see below)

Totalizer1 ► Total1 options	Specify the totalization direction of totalizer 1.*1
Totalizer2 ► Total2 options	Specify the totalization direction of totalizer 2.*1
Totalizer3 ► Total3 options	Specify the totalization direction of totalizer 3.*1

*1: From the table below, select the totalization direction.

Balanced	Totalizes the differential flow rate between the forward and reverse directions.
Absolute	Totalizes the absolute value of the flow rate.
Only positive	Totalizes only the flow rate in the forward direction.
Only negative	Totalizes only the flow rate in the reverse direction.
Hold	Stops totalization processing (holds the current totalized-value).

4.2.7 Totalized Value Reset/Preset Function

The reset/preset function can be specified for the totalized value. Using the reset function resets the totalized value to "0". Using the preset function sets the totalized value in advance to the preset value. The preset function is available when starting counting of totalization with the specified value. This setting can be configured with the following parameters.



NOTE

The parameter returns to "Not execute" after the totalization value reset/preset function has been completed.

Display menu path:

Use of the reset/preset function

Device setup ► Detailed setup ► Totalizer ► (see below)

Totalizer 1 ► Reset/Preset	Uses the reset/preset function of totalizer 1.*1
Totalizer 2 ► Reset/Preset	Uses the reset/preset function of totalizer 2.*1
Totalizer 3 ► Reset/Preset	Uses the reset/preset function of totalizer 3.*1

Preset value setting

Device setup ► Detailed setup ► Totalizer ► (see below)

Totalizer 1 ► Preset value	Specify the preset value of totalizer 1.
Totalizer 2 ► Preset value	Specify the preset value of totalizer 2.
Totalizer 3 ► Preset value	Specify the preset value of totalizer 3.

HART communication:

Use of the reset/preset function

Device root menu ► Detailed setup ► Totalizer ► (see below)

Totalizer1 ► Total1 Reset/Preset	Uses the reset/preset function of totalizer 1.*1
Totalizer2 ► Total2 Reset/Preset	Uses the reset/preset function of totalizer 2.*1
Totalizer3 ► Total3 Reset/Preset	Uses the reset/preset function of totalizer 3.*1

Preset value setting

Device root menu ► Detailed setup ► Totalizer ► (see below)

Totalizer1 ► Total1 preset value	Specify the preset value of totalizer 1.
Totalizer2 ► Total2 preset value	Specify the preset value of totalizer 2.
Totalizer3 ► Total3 preset value	Specify the preset value of totalizer 3.

*1: From the table below, select the reset/preset function.

Not execute	Does not use the totalization value reset/preset function.
Reset	Uses the totalization value reset function.
Preset	Uses the totalization value preset function.

4.3 Pulse Output, Frequency Output, and Status Output

4.3.1 Outputs of I/O2, and I/O4 Terminals

The I/O2, and I/O4 terminals can be used as the pulse output, frequency output, and status output. This setting can be configured with the following parameters.

Display menu path:

Device setup ► Detailed setup ► Pulse/Status out ► (see below)

PO1/SO1 ► Output mode	Specify the output of the I/O2 terminal.*1
PO2/SO2 ► Output mode	Specify the output of the I/O4 terminal.*1

HART communication:

Device root menu ► Detailed setup ► Pulse/Status ► (see below)

Pulse/Status output1 ► Pulse1 output mode	Specify the output of the I/O2 terminal.*1
Pulse/Status output2 ► Pulse2 output mode	Specify the output of the I/O4 terminal.*1

*1: From the table below, select the output of each terminal.

No function	Does not use the terminal.
Fixed pulse output	Sets the output to the fixed pulse output.
Frequency output	Sets the output to the frequency output (Duty 50%).
Status output	Sets the output to the status output. For details about the status output, read Subsection 4.3.7.

4.3.2 Pulse Output / Frequency Output Mapping

The process value to be output can be selected to use the pulse output or frequency output.

When the I/O2 terminal is used for output, the process value PV-mapped in Subsection 4.1.2 is output.

When the I/O4 terminal is used for output, the process value to be output can be selected from the flow velocity, volumetric flow rate, and mass flow rate.

This setting can be configured with the following parameters.

Display menu path:

Device setup ► Detailed setup ► Pulse/Status out ► (see below)

PO2/SO2 ► Pulse select	Specify the output of the I/O4 terminal.*1
------------------------	--------------------------------------------

HART communication:

Device root menu ► Detailed setup ► Pulse/Status ► (see below)

Pulse/Status output2 ► Pulse2 select	Specify the output of the I/O4 terminal.*1
--------------------------------------	--------------------------------------------

*1: From the table below, select the output of the I/O terminal.

Non-Connect	No output
Velocity	Sets the flow velocity to the output.
Volume flow	Sets the volumetric flow rate to the output.
Mass flow	Sets the mass flow rate to the output.

4.3.3 Pulse Width Setting

The pulse width can be selected to use the pulse output.

This setting can be configured with the following parameters.

Display menu path:

Device setup ► Detailed setup ► Pulse/Status out ► (see below)

PO1/SO1 ► Fix width	Specify the pulse width of the I/O2 terminal.*1
PO2/SO2 ► Fix width	Specify the pulse width of the I/O4 terminal.*1

HART communication:

Device root menu ► Detailed setup ► Pulse/Status ► (see below)

Pulse/Status output1 ► Pulse1 fix width	Specify the pulse width of the I/O2 terminal.*1
Pulse/Status output2 ► Pulse2 fix width	Specify the pulse width of the I/O4 terminal.*1

*1: From the table below, select the pulse width.

Pulse width [ms]	Pulse rate Max. [pps]	Pulse width [ms]	Pulse rate Max. [pps]
0.05	10000	100	5
0.1	5000	200	2.5
0.5	1000	330	1.5
1	500	500	1.0
20	25	1000	0.5
33	15	2000	0.25
50	10		

4.3.4 Active Direction Setting

Whether the pulse signal is set on or off to enable the active mode can be specified when the pulse output or status output is used.

This setting can be configured with the following parameters.

Display menu path:

Device setup ► Detailed setup ► Pulse/Status out ► (see below)

PO1/SO1 ► Active mode	Specify the active direction for the pulse signal of the I/O2 terminal.*1
PO2/SO2 ► Active mode	Specify the active direction for the pulse signal of the I/O4 terminal.*1

HART communication:

Device root menu ► Detailed setup ► Pulse/Status ► (see below)

Pulse/Status output1 ► Pulse1 active mode	Specify the active direction for the pulse signal of the I/O2 terminal.*1
Pulse/Status output2 ► Pulse2 active mode	Specify the active direction for the pulse signal of the I/O4 terminal.*1

*1: From the table below, specify the active direction of the pulse signal.

Active: ON/On active	Sets to Active when the pulse signal is set on.
Active: OFF/Off active	Sets to Active when the pulse signal is set off.

Example:

If the fixed pulse output is specified and the pulse width is set to "1 ms", Active is set as shown below.

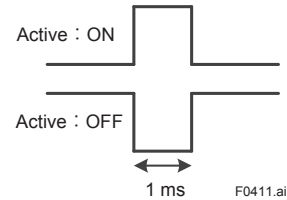

4.3.5 Pulse Rate Setting

The pulse rate per pulse and the pulse rate scaling can be specified to use the pulse output when this function is used.

When the I/O2 terminal is used for output, the unit of the pulse rate is set to that of the process value PV-mapped in Subsection 4.1.2.

In case of using the I/O4 terminal for output, the unit of the pulse rate is set to that of the process value mapped in Subsection 4.3.2.

This setting can be configured with the following parameters. If the pulse rate scaling is changed, the pulse rate value is also changed synchronously with the changed unit.

Display menu path:

Pulse rate value

Device setup ► Detailed setup ►

Pulse/Status out ► (see below)

PO1/SO1 ► Rate value	Specify the pulse rate value of the I/O2 terminal.
PO2/SO2 ► Rate value	Specify the pulse rate value of the I/O4 terminal.

Pulse rate scaling

Device setup ► Detailed setup ►

Pulse/Status out ► (see below)

PO1/SO1 ► Rate unit	Specify the pulse rate scaling of the I/O2 terminal.
PO2/SO2 ► Rate unit	Specify the pulse rate scaling of the I/O4 terminal.

HART communication:

Pulse rate value

Device root menu ► Detailed setup ►

Pulse/Status ► (see below)

Pulse/Status output1 ► Pulse1 rate value	Specify the pulse rate value of the I/O2 terminal.
Pulse/Status output2 ► Pulse2 rate value	Specify the pulse rate value of the I/O4 terminal.

Pulse rate scaling

Device root menu ► Detailed setup ►

Pulse/Status ► (see below)

Pulse/Status output1 ► Pulse1 rate unit	Specify the pulse rate scaling of the I/O2 terminal.
Pulse/Status output2 ► Pulse2 rate unit	Specify the pulse rate scaling of the I/O4 terminal.

Note: From the table below, select the pulse rate scaling.

n Unit/P	10 ⁹ × Unit per pulse
u Unit/P	10 ⁶ × Unit per pulse
m Unit/P	10 ³ × Unit per pulse
Unit/P	1 unit per pulse
k Unit/P	10 ³ × Unit per pulse
M Unit/P	10 ⁶ × Unit per pulse
n P/Unit	10 ⁹ × Pulse per unit
u P/Unit	10 ⁶ × Pulse per unit
m P/Unit	10 ³ × Pulse per unit
P/Unit	1 pulse per unit
k P/Unit	10 ³ × Pulse per unit
M P/Unit	10 ⁶ × Pulse per unit

* Unit: Indicates the unit of the process value to be output as the pulse output.



NOTE

The maximum pulse rate and pulse width must be specified so that the following conditions are satisfied.

$$\begin{aligned} &\text{Maximum pulse rate value [pps]} \\ &= \text{Flow rate span (Unit/s)} \times \text{Pulse rate [P/Unit]} \\ &\leq 10 \text{ [k pps]} \\ &\leq 1 / (\text{Pulse width} \times 2) \end{aligned}$$

Example:

When the pulse width is set to "0.1 ms", the maximum pulse rate value is set to "1 / (0.0001 × 2) = 5000 [pps]". If the specified pulse rate exceeds this value, it causes a setting error, and an alarm is displayed.

4.3.6 Frequency Output Range Setting

When the frequency output is used, the frequency at 0% and 100% can be specified for the span of the process value. The frequency output range can be set by specifying the frequency.

When the I/O2 terminal is used for output, specify the output frequency for the span of the process value PV-mapped described in Subsection 4.1.2. When the I/O4 terminal is used for output, specify the output frequency for the span of the process value mapped described in Subsection 4.3.2. This setting can be configured with the following parameters.

Display menu path:

Device setup ► Detailed setup ► Pulse/Status out ► (see below)

PO1/SO1 ► Frequency at 0%	Specify the frequency when 0% is set to the process value that is to be output with the frequency output through the I/O2 terminal.
PO1/SO1 ► Frequency at 100%	Specify the frequency when 100% is set to the process value that is to be output with the frequency output through the I/O2 terminal.
PO2/SO2 ► Frequency at 0%	Specify the frequency when 0% is set to the process value that is to be output with the frequency output through the I/O4 terminal.
PO2/SO2 ► Frequency at 100%	Specify the frequency when 100% is set to the process value that is to be output with the frequency output through the I/O4 terminal.

HART communication:

Device root menu ► Detailed setup ► Pulse/Status ► (see below)

Pulse/Status output1 ► Frequency1 at 0%	Specify the frequency when 0% is set to the process value that is to be output with the frequency output through the I/O2 terminal.
Pulse/Status output1 ► Frequency1 at 100%	Specify the frequency when 100% is set to the process value that is to be output with the frequency output through the I/O2 terminal.
Pulse/Status output2 ► Frequency2 at 0%	Specify the frequency when 0% is set to the process value that is to be output with the frequency output through the I/O4 terminal.
Pulse/Status output2 ► Frequency2 at 100%	Specify the frequency when 100% is set to the process value that is to be output with the frequency output through the I/O4 terminal.

4.3.7 Status Output Function Setting

The instrument status can be set as the contact output to use the status output.

This setting can be configured with the following parameters.

Display menu path:

Device setup ► Detailed setup ► Pulse/Status out ► (see below)

PO1/SO1 ► SO1 function	Specify the status output 1 function of the I/O2 terminal.*1
PO2/SO2 ► SO2 function	Specify the status output 2 function of the I/O4 terminal.*1

HART communication:

Device root menu ► Detailed setup ► Pulse/Status ► (see below)

Pulse/Status output 1 ► Status output1 function	Specify the status output 1 function of the I/O2 terminal.*1
Pulse/Status output 2 ► Status output2 function	Specify the status output 2 function of the I/O4 terminal.*1

*1: From the table below, select the status output function.

No function	The status output is not available because the status output function is not enabled.
Alarm output	The status output becomes active when an alarm occurs.
Warning output	The status output becomes active when a warning occurs.
Total limit 1	The status output is active while the totalized value of totalizer 1 is out of the specified target value. For details about the totalization switch function, read Subsection 4.2.3.
Total limit 2	The status output is active while the totalized value of totalizer 2 is out of the specified target value. For details about the totalization switch function, read Subsection 4.2.3.
Total limit 3	The status output is active while the totalized value of totalizer 3 is out of the specified target value. For details about the totalization switch function, read Subsection 4.2.3.
H/L alarm	The status output is active while the PV-mapped process value is out of the specified low limit value (L) or high limit value (H). For details about the PV mapping for the process value and alarm information, read Subsection 4.1.2, Section 4.8, and Subsection 4.11.2.
HH/LL alarm	The status output is active while the PV-mapped process value is out of the specified low-low limit value (LL) or high-high limit value (HH). For details about the PV mapping for the process value and alarm information, read Subsection 4.1.2, Section 4.8, and Subsection 4.11.2.
Fwd/Rev range	The status output is active while the fluid is flowing in the reverse direction. Used in the forward/reverse range. For details about the forward/reverse range, read Subsection 4.6.4.
Auto2 range	The status output is active while operation is being performed in range 2. Used in the multi range. For details about the multi range function, read Subsection 4.6.3.
Ext2 answer	Sets the status input function to the external contact range. The status output becomes active depending on the in-use range. Used for answer-back (range check) of an external contact range. For details about the status output function and the external contact range, read Subsection 4.4.2 and 4.6.6.

4.4 Status Input

4.4.1 Active Direction Setting for Status Input

Whether the status input is set on or off to enable the active mode can be specified when the I/O3 terminal is used for the status input.

This setting can be configured with the following parameters.

Display menu path:

Device setup ► Detailed setup ► Status in ► (see below)

SI3 ► Active mode	Specify the active direction of the status input.*1
-------------------	-----------------------------------------------------

HART communication:

Device root menu ► Detailed setup ► Pulse/Status ► (see below)

Status input 3 ► Status input3 active mode	Specify the active direction of the status input.*1
-----------------------------------------------	-----------------------------------------------------

*1: From the table below, select the active direction of the status input.

Active: ON/Short(On) act	Sets to Active when the status input is short-circuited.
Active: OFF/Open(Off) act	Sets to Active when the status input is opened.

4.4.2 Status Input Function Setting

The status input function is available when the I/O3 terminal is used for the status input. This setting can be configured with the following parameters.

Display menu path:

Device setup ► Detailed setup ► Status in ► (see below)

SI3 ► Function	Specify the status input function of the I/O3 terminal.*1
----------------	-----------------------------------------------------------

HART communication:

Device root menu ► Detailed setup ► Pulse/Status ► (see below)

Pulse/Status input3 ► Status input3 function	Specify the status input function of the I/O3 terminal.*1
-------------------------------------------------	-----------------------------------------------------------

*1: From the table below, select the status input function.

No function	The status input is not available because the status input function is not enabled.
0% Signal Lock	When the status input becomes active, the current output1 of the I/O1 terminal is fixed to 4 mA.
Ext auto zero	When the status input becomes active, the zero adjustment function is performed automatically. Note that the zero adjustment cannot be stopped even if the status input is changed while the zero adjustment function is running.
Total preset 1	When the status input becomes active, the preset value specified in Subsection 4.2.7 is set to totalizer 1, and totalization starts with the value.
Total preset 2	When the status input becomes active, the preset value specified in Subsection 4.2.7 is set to totalizer 2, and totalization starts with the value.
Total preset 3	When the status input becomes active, the preset value specified in Subsection 4.2.7 is set to totalizer 3, and totalization starts with the value.
Ext2 ranges	While the status input is active, the range of current output 1 is switched from range 1 to range 2. Used in the external contact range. For details about the external contact range, read Subsection 4.6.6.

4.5 Current Output

4.5.1 Current Output High/Low Limit Function

The high/low limit function is available to use the current output. Using the high/low limit function restricts the high limit of 4 to 20 mA current output and the low limit of the 4 to 20 mA current output. This setting can be configured with the following parameters.

Display menu path:

Device setup ► Detailed setup ► Analog out/in ► (see below)

AO1 ► High limit	Specify the high limit value to use the I/O1 terminal for the current output.
AO1 ► Low limit	Specify the low limit value to use the I/O1 terminal for the current output.

HART communication:

Device root menu ► Detailed setup ► Analog output/input ► (see below)

Analog output1 ► AO1 high limit	Specify the high limit value to use the I/O1 terminal for the current output.
Analog output1 ► AO1 low limit	Specify the low limit value to use the I/O1 terminal for the current output.

Example:

If the high limit value is set to 16 mA and the low limit value to 8 mA while the I/O1 terminal is used for the current output, the result is as shown below.

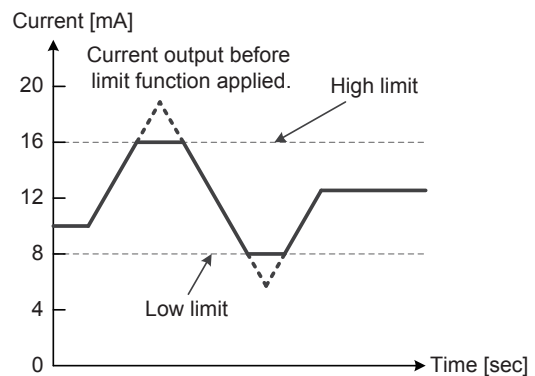

F0412.ai

4.5.2 Absolute Range Function

The current output function is available to use the current output. The current signal can be output both forward flow and reverse flow simultaneously toward the span when this function is used. The current output can be performed by setting the flow rate of 0% to 12 mA, the reverse flow rate to 4 to 12 mA, and the forward flow rate to 12 to 20 mA. However, this function is available only when the I/O1 terminal is used for the current output. The absolute range function and low cut function can be used simultaneously. For low cut function, read Subsection 4.1.7.

This setting can be configured with the following parameters.

Display menu path:

Device setup ► Detailed setup ► Analog out/in ► (see below)

AO1 ► Range mode	Specifies the use of the absolute range function to use the I/O1 terminal for the current output.*1
------------------	-----------------------------------------------------------------------------------------------------

HART communication:

Device root menu ► Detailed setup ► Analog output/input ► (see below)

Analog output1 ► AO1 range mode	Specifies the use of the absolute range function to use the I/O1 terminal for the current output.*1
---------------------------------	-----------------------------------------------------------------------------------------------------

*1: From the table below, select the use of the absolute range function.

Normal range	Does not use the absolute range function.
Abs range	Uses the absolute range function.

Example:

(1) Absolute range without low-cut

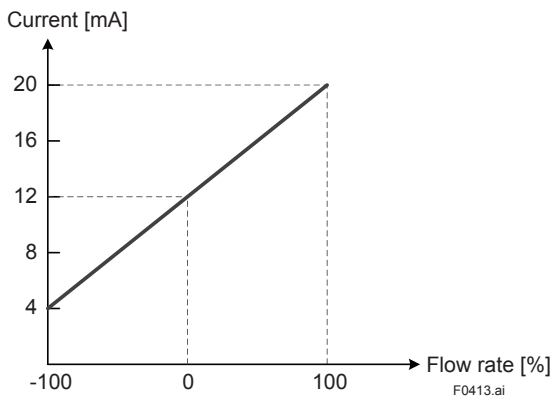

(2) Absolute range with low-cut

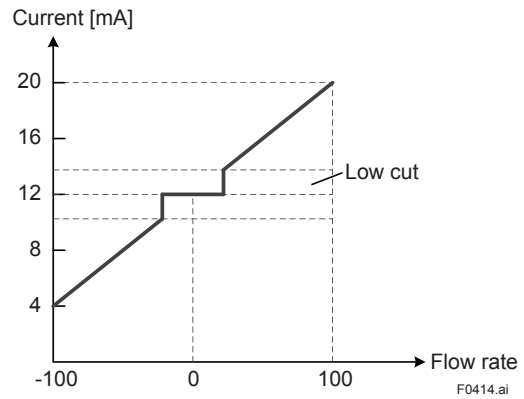

NOTE

The absolute range function and multi range function cannot be used simultaneously.

4.5.3 Alarm Output Function

The alarm output function is available to use the current output. The current signal can be output for an occurrence of alarm when this function is used. This setting can be configured with the following parameters.

Display menu path:

Device setup ► Detailed setup ► Analog out/in ► (see below)

AO1 ► Alarm out	Specify the alarm output function to use the I/O1 terminal for the current output.*1
-----------------	--------------------------------------------------------------------------------------

HART communication:

Device root menu ► Detailed setup ► Analog output/input ► (see below)

Analog output1 ► AO1 alarm out	Specify the alarm output function to use the I/O1 terminal for the current output.*1
--------------------------------	--------------------------------------------------------------------------------------

*1: From the table below, select the use of the alarm output function.

<2.4 mA	Outputs the lower current than 2.4 mA.
3.8 mA	Outputs the 3.8 mA current.
4 mA	Outputs the 4 mA current.
20.5 mA	Outputs the 20.5 mA current.
>21.6 mA	Outputs the higher current than 21.6 mA.
Measured value	Outputs the measured current (the current value is undefined due to an error).
Hold	Outputs the current that is applied when an alarm has occurred.

4.5.4 Current Output Priority

The priority of the current output functions varies depending on the setting of this instrument. The current output is operated based on the following priority level.

Priority level	Output mode
High ↑	HART multidrop mode, 4 mA fixed current output (For details, read Subsection 3.6.3.)
	Test mode (For details, read Section 4.12.)
	Status input function 0% signal lock output (For details, read Subsection 4.4.2.)
	Alarm output function (For details, read Subsection 4.5.3.)
	Verification function, Output during offline diagnosis (For details, read Subsection 4.11.6.)
Low ↓	Normal output

4.5.5 Current Value Adjustment Function

The current value adjustment function is available to use the current input or current output. The current output is adjustable when 4.0 mA for the 0% current value is not indicated, or 20.0 mA for the 100% current value is not indicated.

This setting can be configured with the following parameters.

Display menu path:

Current output
Device setup ► Diag/Service ► AO/AI trim ►
(see below)

AO1 trim 4 mA	Specify the adjustment value to use the I/O1 terminal for the 4 mA current output.
AO1 trim 20 mA	Specify the adjustment value to use the I/O1 terminal for the 20 mA current output.
AO1 trim clear	Clears the adjustment value to use the I/O1 terminal for the current output.

HART communication:

Current output
Maintenance root menu ► AO/AI trim ►
AO trim ► (see below)

AO1 trim	Specify the adjustment value to use the I/O1 terminal for the current output.
Clear D/A trim 1	Clears the adjustment value to use the I/O1 terminal for the current output.



IMPORTANT

If the output does not match the specified current value when the current value adjustment function is used, readjust the current value.

4.6 Multi Range Function

4.6.1 Multi Range Types

The multi range function is available when the current output is performed through the I/O1 terminal using the status input and status output. This function can be performed to measure the flow rate by switching the span of the process value PV-mapped in Subsection 4.1.2 in multiple ranges. The multi range function can be selected from the multi range, forward/reverse range, and external contact range.

Each range has the following feature.

Multi range	Makes measurements while switching multiple ranges depending on the flow rate, and outputs the range status as the status output.
Forward/reverse range	Makes measurements while switching multiple ranges depending on the flow direction of the flow rate, and outputs the range status as the status output.
External contact range	Makes measurements while switching multiple ranges depending on the status input.



NOTE

The multi range function cannot be used simultaneously with the absolute range function.

4.6.2 Multi Range Setting

The setting for each range is required to use the multi range function. For information about the unit setting, read Subsection 4.1.4.

This setting can be configured with the following parameters. For details about how to specify the span (forward range 1) without using the multi range function, read Subsection 4.1.5.

Display menu path:

Device setup ► Detailed setup ► Multi range ► (see below)

Forward span 2	Specify forward range 2.
Reverse span 1	Specify reverse range 1.
Reverse span 2	Specify reverse range 2.

HART communication:

Device setup ► Detailed setup ► Multi range ► (see below)

Forward span 2	Specify forward range 2.
Reverse span 1	Specify reverse range 1.
Reverse span 2	Specify reverse range 2.

4.6.3 Multi Range Operation

The multi range function performs to make measurements while automatically switching two ranges depending on the flow rate. If the measured flow rate is higher than the low-level range, it is automatically switched to the high-level range. If the measured flow rate is lower than the high-level range, it is automatically switched to the low-level range.

The in-use range can be output as the status output. The relationship between the ranges and status output is as follows.

Low-level range	The status output is not active.
High-level range	The status output is active.

When the range is switched from the high-level range to the low-level range, the hysteresis is set. The hysteresis specifies the ratio for the low-level range.

The multi range switching hysteresis can be specified with the following parameters.

Display menu path:

Device setup ► Detailed setup ► Multi range ► (see below)

Auto range hyst	Specify the multi range switching hysteresis.
-----------------	-----------------------------------------------

HART communication:

Device root menu ► Detailed setup ► Multi range ► (see below)

Auto range hyst	Specify the multi range switching hysteresis.
-----------------	-----------------------------------------------

The multi range can be configured by the following procedure.

- (1) Specify the process value of the Primary Value, referring to Subsection 4.1.2.
- (2) Specify the span (forward range 1), referring to Subsection 4.1.4 and 4.1.5.
- (3) Specify the multi range switching hysteresis.
- (4) Set the terminal output to "Status out", referring to Subsection 4.3.1.
- (5) Set the status output function to multi range, referring to Subsection 4.3.7.
- (6) Specify forward range 2, referring to Subsection 4.6.2.

Note that the forward range 2 must be set which is larger value than the forward range 1.

Example:

Primary Value = Volumetric flow rate,
 Flow rate span (range 1) = 50 m³/h,
 Range 2 = 100 m³/h,
 Hysteresis = 10%

In this case, the hysteresis value is obtained as shown below.

$$50 \text{ [m}^3\text{/h]} \times 10 \text{ [%]} = 5 \text{ [m}^3\text{/h]}$$

(1) When the range is switched from low-level range 1 to high-level range 2, the result is obtained as shown below.

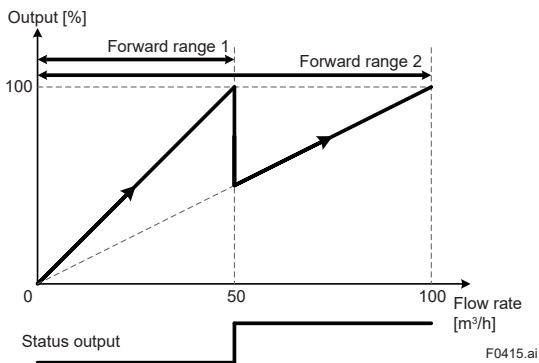

(2) When the range is switched from high-level range 2 to low-level range 1, the result is obtained as shown below (with the hysteresis).

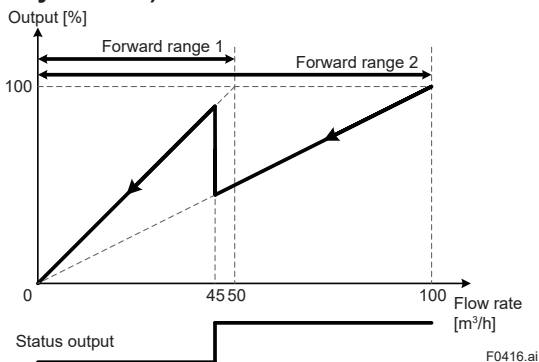

NOTE

Reconfigure the multi range setting when the process value of the Primary Value specified in Subsection 4.1.2 is changed.

4.6.4 Forward/Reverse Range

The forward/reverse range function can be performed to make measurements while automatically switching the forward and reverse ranges depending on the flow direction of the flow rate. The forward or reverse range can be specified for the range.

The in-use range can be output as the status output. The relationship between the ranges and status output is as follows.

Forward range	The status output is not active.
Reverse range	The status output is active.

When the range is switched between the forward and reverse ranges, the hysteresis is set. The hysteresis specifies the ratio for the forward or reverse range, whichever is lower. This setting can be configured with the following parameters.

Display menu path:

Device setup ► Detailed setup ► Multi range ► (see below)

Bi direction hyst	Specify the forward/reverse range switching hysteresis.
-------------------	---------------------------------------------------------

HART communication:

Device root menu ► Detailed setup ► Multi range ► (see below)

Bi direction hyst	Specify the forward/reverse range switching hysteresis.
-------------------	---------------------------------------------------------

The forward/reverse range can be specified by the following procedure.

- (1) Specify the process value of the Primary Value, referring to Subsection 4.1.2.
- (2) Specify the span (forward range 1), referring to Subsection 4.1.4 and 4.1.5.
- (3) Specify the forward/reverse range switching hysteresis.
- (4) Set the terminal output to "Status out", referring to Subsection 4.3.1.
- (5) Set the status output function to the forward/reverse range, referring to Subsection 4.3.7.
- (6) Specify reverse range 1, referring to Subsection 4.6.2.

Example:

Primary Value = Volumetric flow rate,
 Flow rate span (forward range 1) = 50 m³/h,
 Reverse range 1 = 100 m³/h,
 Hysteresis = 5%
 In this case, the forward range is smaller than the reverse range; therefore, the hysteresis value is obtained as shown below.
 $50 \text{ [m}^3\text{/h]} \times 5 \text{ [%]} = 2.5 \text{ [m}^3\text{/h]}$

(1) When the range is switched from the reverse range to the forward range, the result is obtained as shown below (with the hysteresis).

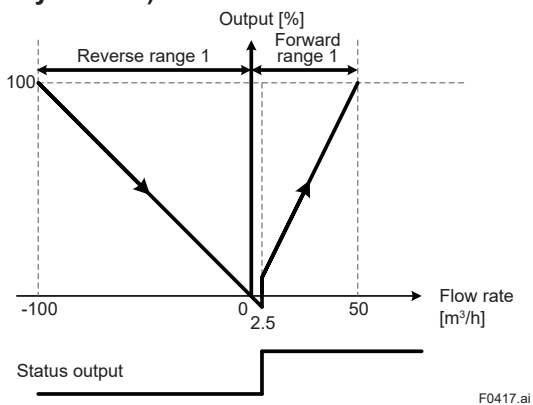

(2) When the range is switched from the forward range to the reverse range, the result is obtained as shown below (with the hysteresis).

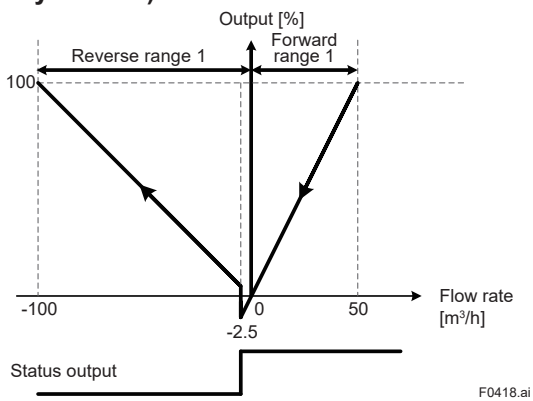

NOTE

Reconfigure the forward/reverse range setting when the process value of the Primary Value specified in Subsection 4.1.2 is changed.

4.6.5 Combination of Multi Range and Forward/Reverse Range

The multi range function can be combined with the forward/reverse range function when the status output 1 function of the I/O2 terminal and the status output 2 function of the I/O4 terminal are set to the multi range function and forward/reverse range function respectively. Two forward ranges and two reverse ranges, which are four ranges totally, can be assigned to each range.

The in-use range can be output as the status output. The relationship between the ranges and status output is as follows.

○: The status output is active.
 ×: The status output is not active.

	Multi range	Forward/reverse range
Forward range 1	×	×
Forward range 2	○	×
Reverse range 1	×	○
Reverse range 2	○	○

The multi range and forward/reverse range have the hysteresis respectively. For details about the hysteresis of the multi range and forward/reverse range, read Subsection 4.6.3 and 4.6.4.

The following steps are to combine the multi range with the forward/reverse range.

- (1) Specify the process value of the Primary Value, referring to Subsection 4.1.2.
- (2) Specify the span (forward range 1), referring to Subsection 4.1.4 and 4.1.5.
- (3) Specify the hysteresis for the multi range and forward/reverse range, referring to Subsection 4.6.3 and 4.6.4.
- (4) Set each terminal output to "Status out", referring to Subsection 4.3.1.
- (5) Set the status output function to multi range or forward/reverse range, referring to Subsection 4.3.7.
- (6) Specify the forward and reverse ranges, referring to Subsection 4.6.2.

4.6.6 External Contact Range

This instrument enables a use of an external contact range. This function can be measured while automatically switching two ranges depending on the status input.

The relationship between the ranges and status input is as follows.

The status input is not active.	Low-level range
The status input is active.	High-level range

The external contact range can be specified by the following procedure.

- (1) Specify the process value of the Primary Value, referring to Subsection 4.1.2.
- (2) Specify the span (forward range 1), referring to Subsection 4.1.4 and 4.1.5.
- (3) Set the status input function to the external contact range, referring to Subsection 4.4.2.
- (4) Set the status output function to the external contact range, referring to Subsection 4.3.7.
- (5) Specify forward range 2, referring to Subsection 4.6.2.

Example:

Primary Value = Volumetric flow rate,
 Flow rate span (forward range 1) = 50 m³/h,
 Forward range 2 = 100 m³/h

In this case, the result is obtained as shown below.

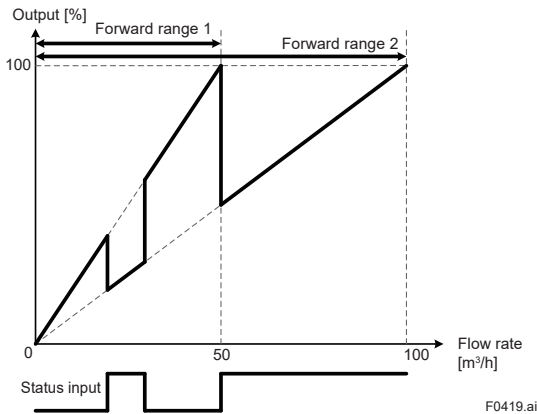

4.7 Auxiliary Calculation Function

4.7.1 Fluid Flow Direction Setting

The arrow shown on the surface of the sensor indicates the fluid flow direction. Upon shipment from the manufacturing plant, the flow rate is measured, assuming that the arrow direction is forward.

This instrument can be changed the parameter setting and measure the flow rate, assuming that the opposite direction of the arrow direction is forward.

This setting can be configured with the following parameters.

Display menu path:

Device setup ► Detailed setup ►
 AUX calculation ► (see below)

Flow direct	Specify the fluid flow direction.*1
-------------	-------------------------------------

HART communication:

Device root menu ► Detailed setup ►
 AUX calculation ► (see below)

Flow direction	Specify the fluid flow direction.*1
----------------	-------------------------------------

*1 From the table below, select the fluid flow direction.

Forward	The arrow direction of the sensor is forward.
Reverse	The opposite direction of the arrow direction of the sensor is forward.

4.7.2 Rate Limit Function Setting

The rate limit function can perform to reduce noises that cannot be all cleared by only lengthening the damping time constant. When a step signal or a sudden signal due to a slurry fluid is input, this function judges whether the signal is a flow rate signal or a noise signal. This judgment is made based on the high/low limit value (rate limit value) and the rate limit function continuation time (dead time), causing the noise signal over the rate limit value to be cut off.

The rate limit value is specified with the percentage (%) for the span of the process value PV-mapped in Subsection 4.1.2. Set "0" to the dead time if this function is unnecessary to use.

This setting can be configured with the following parameters.

Display menu path:

Device setup ► Detailed setup ► AUX calculation ► (see below)

Rate limit	Specify the rate limit value.
Dead time	Specify the dead time.
Noise filter	Specify the noise filter (rate limit value and dead time).*1

HART communication:

Device root menu ► Detailed setup ► AUX calculation ► (see below)

Rate limit	Specify the rate limit value.
Dead time	Specify the dead time.
Noise filter	Specify the noise filter (rate limit value and dead time).*1

*1: From the table below, select the noise filter (rate limit value and dead time).

	Rate limit value	Dead time
Manual	Optional	Optional
Level 1	0.5%	0.5s
Level 2	1.0%	1.0s
Level 3	5.0%	3.0s



NOTE

If either the rate limit value or the dead time is specified, the noise filter is set to "Manual".



NOTE

Determining the rate limit value and dead time

The Rate limit value:
Determine the level which should be cut the output fluctuation. For example, if its level is 2%, the noise of 2% or larger would be cut as shown in the following figure.

The Dead time (T₀):
Determine the value depending on the width of the output fluctuation. Choose the larger value when the noise which is over the dead time as shown in the following figure.

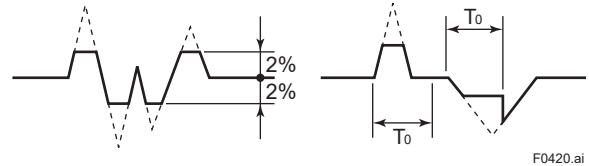

F0420.ai



NOTE

For the rate limit function, the dead time is set to "0" upon shipment from the manufacturing plant. Be sure to set the dead time when the rate limit function is used.

Signal processing for rate limit function

The instrument calculates to set the specific rate limit value to the primary delay response value of the previously sampled flow rate value. If the flow rate value sampled at this time exceeds the rate limit value above, its high or low limit value is set to the flow rate value at this time. Furthermore, if the sampling count occurs within the dead time while the signal over the high/low limit value is in the same direction, this signal is judged to be a flow rate signal.

Example:

(1) Input = 0 to 10%, Damping time constant = 5 seconds, Dead time = 3 seconds, Rate limit value = 1% In this case, the output for the step input is obtained as shown below.

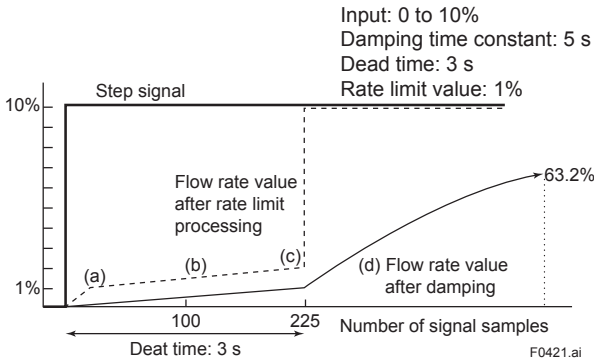

- In the condition above (a), the signal exceeds the rate limit value as compared with the previous value; therefore, the response is set to 1%.
The actual output, which is damped, is processed as indicated by the solid line.
- Then, the flow rate value in the dead time is set to the "flow rate after damping calculation + signal of rate limit value (1%)".
- The input signal does not return to the rate limit value or less within the dead time; therefore, it is judged to be a flow rate signal at the time of (c).
- The output signal starts following the step signal along the damping curve.

The figure below shows an output example when a slurry noise has occurred.

(2) Input = 0 to 10%, Damping time constant = 1 second, Dead time = 1 seconds, Rate limit value = 1% In this case, the output for a slurry noise is obtained as shown below.

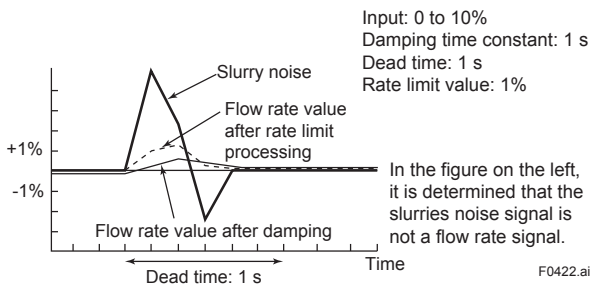

4.7.3 Pulsing Flow Support Function Setting

Using a pump, etc. may cause an error in the average of the flow rate due to the pulsing flow. If the pulsing flow support function is used, an error due to a pulsing flow can be reduced by following a flow change while controlling the flow rate calculation.

This setting can be configured with the following parameters.

Display menu path:

Device setup ▶ Detailed setup ▶ AUX calculation ▶ (see below)

Pulsing flow	Specify the use of the pulsing flow support function.*1
--------------	---------------------------------------------------------

HART communication:

Device root menu ▶ Detailed setup ▶ AUX calculation ▶ (see below)

Pulsing flow	Specify the use of the pulsing flow support function.*1
--------------	---------------------------------------------------------

*1: Select the use of the pulsing flow support function from the table below.

No	Do not use the pulsing flow support function.
Yes	Use the pulsing flow support function.

4.7.4 Power Frequency Synchronization Setting

This function can be specified whether the excitation frequency (internal signal processing frequency) and power frequency are synchronous or asynchronous.

When making the excitation frequency and power frequency asynchronous, the excitation frequency is determined by the set value of the power frequency.

The power frequency synchronous/asynchronous mode and the power frequency can be configured with the following parameters.

Display menu path:

Device setup ► Detailed setup ►

AUX calculation ► (see below)

Power sync	Makes the excitation frequency and power frequency synchronous.*1
Set power freq	Sets the power frequency when the excitation frequency and power frequency are asynchronous.

HART communication:

Device root menu ► Detailed setup ►

AUX calculation ► (see below)

Power synchronize	Makes the excitation frequency and power frequency synchronous.*1
Set power frequency	Sets the power frequency when the excitation frequency and power frequency are asynchronous.

*1: From the table below, select the power frequency synchronous/asynchronous mode.

No	Makes the excitation frequency and power frequency asynchronous.
Yes	Makes the excitation frequency and power frequency synchronous.



IMPORTANT

When using the DC power as the transmitter power, set the commercially available power frequency of the place where to use the transmitter.

Set "Power sync" to Off and specify "Set power freq".

The excitation frequency and power frequency can be checked with the following parameters.

Display menu path:

Device setup ► Detailed setup ►

AUX calculation ► (see below)

Iex power frequency	Displays the power frequency (synchronous with the excitation frequency).
Meas power freq	Displays the measured power frequency.

HART communication:

Device root menu ► Detailed setup ►

AUX calculation ► (see below)

Iex power frequency	Displays the power frequency (synchronous with the excitation frequency).
Measured power frequency	Displays the measured power frequency.

4.8 Alarm

4.8.1 Errors and Countermeasures

The error messages are following table. For AXFA11, read the applicable user's manual as listed in Table 1.1.

Alarm Item	Description
System Alarm	Device breaks down and causes abnormal measurement. Device replacement is needed.
Process Alarm	The device works normally and some issue of process causes abnormal measurement. Maintenance work is needed.
Setting Alarm	The device works normally but parameter setting error occurs. Parameter setting is needed.
Warning	The device works normally and measurement is also normal but warning occurs.
Information	The device works normally and measurement is also normal. Just reference information.

NE107 Status		Status of the Device
F	Failure	Device malfunction, Parts malfunction
C	Function Check	The output signal is temporarily invalid for the local operation or manual operation.
S	Out of Specification	The device works in out of specification. The output signal is uncertain for the process or the ambience.
M	Maintenance Required	The maintenance is required in the near future.
N	No Effect	Other issue

Alarm Item	NE107 Status	Error Message		Error Description	Countermeasure Message		Countermeasure	Operation at the time of error						
		Display	HART		Display			Output						
								Alarm	Warning	Current	Pulse / Status	Total	Process Value	Display
System Alarm	F	010: Main CPU FAIL	Main board CPU failure	CPU (Main board) failure was detected.	Contact Yokogawa service center.	Contact Yokogawa service center.	Contact Yokogawa service center.	Active	Non-Active	Burnout	Stop	Stop	Not defined	
	F	011: Rev calc FAIL	Reverse calculation failure	Failure of reverse calculation was detected.	Contact Yokogawa service center.	Contact Yokogawa service center.	Contact Yokogawa service center.	Active	Non-Active	Alarm Out	Alarm Out	Based on "FailOpts"	Normal Operation	Alarm
	F	012: Main EEP FAIL	Main board EEPROM failure	Failure of EEPROM (Main board) was detected.	Contact Yokogawa service center.	Contact Yokogawa service center.	Turn on the power again within the temperature range. If the problem does not improve, contact Yokogawa service center.	Active	Non-Active	Alarm Out	Alarm Out	Based on "FailOpts"	Normal Operation	Alarm
	F	013: Main EEP dft	Main board EEPROM default	EEPROM (Main board) was reset to default values.	Contact Yokogawa service center.	Contact Yokogawa service center.	Contact Yokogawa service center.	Active	Non-Active	Alarm Out	Alarm Out	Based on "FailOpts"	Normal Operation	Alarm
	F	014: Snr bd FAIL	Sensor board failure	Failure of sensor board was detected.	Contact Yokogawa service center.	Contact Yokogawa service center.	Contact Yokogawa service center.	Active	Non-Active	Alarm Out	Alarm Out	Based on "FailOpts"	Hold prior setting	Alarm
	F	015: Snr comm ERR	Sensor communication error	Communication error of sensor was detected.	Contact Yokogawa service center.	Contact Yokogawa service center.	Contact Yokogawa service center.	Active	Non-Active	Burnout	Alarm Out	Based on "FailOpts"	Hold prior setting	Alarm
	F	016: AD 1 FAIL[Sg]	A/D1 failure[Signal]	Failure of A/D transmitter 1 [flow velocity signal] was detected.	Contact Yokogawa service center.	Contact Yokogawa service center.	Contact Yokogawa service center.	Active	Non-Active	Alarm Out	Alarm Out	Based on "FailOpts"	Hold prior setting	Alarm
	F	017: AD 2 FAIL[Excit]	A/D2 failure[Exciter]	Failure of A/D transmitter 2 [Exciting current] was detected.	Contact Yokogawa service center.	Contact Yokogawa service center.	Contact Yokogawa service center.	Active	Non-Active	Alarm Out	Alarm Out	Based on "FailOpts"	Hold prior setting	Alarm

Alarm Item	NE107 Status	Error Message		Error Description	Countermeasure Message		Countermeasure	Operation at the time of error					Process Value	Display
		Display	HART		Display	Alarm		Warning	Current	Pulse / Status	Total			
												Alarm		
System Alarm	F	018: Coil open	18	Coil open	Coil of sensor was disconnected.	Cut the power and check coil & EX cable.	Turn the power, check coil of sensor and excitation cable.	Active	Non-Active	Alarm Out	Alarm Out	Based on "FailOpts"	Hold prior setting	Alarm
	F	019: Coil short	19	Coil short	Coil of sensor was shorted.	Contact Yokogawa service center.	Contact Yokogawa service center.	Active	Non-Active	Alarm Out	Alarm Out	Based on "FailOpts"	Hold prior setting	Alarm
	F	020: Exciter FAIL	20	Exciter failure	Failure of excitation circuit was detected.	Contact Yokogawa service center.	Contact Yokogawa service center.	Active	Non-Active	Alarm Out	Alarm Out	Based on "FailOpts"	Normal Operation	Alarm
	F	021: PWM 1 stop	21	PWM1 stop	Error of pulse width modulation 1 was detected.	Contact Yokogawa service center.	Contact Yokogawa service center.	Active	Non-Active	Alarm Out	Alarm Out	Based on "FailOpts"	Normal Operation	Alarm
	F	022: PWM 2 stop	22	PWM2 stop	Error of pulse width modulation 2 was detected.	Contact Yokogawa service center.	Contact Yokogawa service center.	Active	Non-Active	Alarm Out	Alarm Out	Based on "FailOpts"	Normal Operation	Alarm
	F	023: Opt bd mismatch	23	Option board mismatch	Mismatch of option board was detected.	Contact Yokogawa service center.	Contact Yokogawa service center.	Active	Non-Active	Alarm Out	Alarm Out	Based on "FailOpts"	Normal Operation	Alarm
	F	024: Opt bd EEP FAIL	24	Option board EEPROM failure	Failure of EEPROM (option board) was detected.	Contact Yokogawa service center.	Contact Yokogawa service center.	Active	Non-Active	Alarm Out	Alarm Out	Based on "FailOpts"	Normal Operation	Alarm
	F	025: Opt bd A/D FAIL	25	Option board A/D failure	Failure of A/D (option board) was detected.	Contact Yokogawa service center.	Contact Yokogawa service center.	Active	Non-Active	Alarm Out	Alarm Out	Based on "FailOpts"	Normal Operation	Alarm
	F	026: Opt bd SPI FAIL	26	Option board SPI failure	Failure of SPI (option board) was detected.	Contact Yokogawa service center.	Contact Yokogawa service center.	Active	Non-Active	Alarm Out	Alarm Out	Based on "FailOpts"	Normal Operation	Alarm
	F	027: Restore FAIL	27	Parameter restore incomplete	Restore of parameters was failed.	Retry parameter restoration.	Retry parameter restoration.	Active	Non-Active	Alarm Out	Alarm Out	Based on "FailOpts"	Normal Operation	Alarm
	F	028: Ind bd FAIL	28	Indicator board failure	Failure of indicator board was detected.	Contact Yokogawa service center.	Check the ambient temperature of display is within the range. If the problem does not improve, contact Yokogawa service center.	Active	Non-Active	Alarm Out	Alarm Out	Based on "FailOpts"	Normal Operation	Alarm
	F	029: Ind bd EEP FAIL	29	Indicator board EEPROM failure	Failure of EEPROM (indicator board) was detected.	Contact Yokogawa service center.	Turn on the power again within the temperature range. If the problem does not improve, contact Yokogawa service center.	Active	Non-Active	Alarm Out	Alarm Out	Based on "FailOpts"	Normal Operation	Alarm
	F	030: LCD drv FAIL	30	LCD driver failure	Failure of LCD driver was detected.	Contact Yokogawa service center.	Contact Yokogawa service center.	Active	Non-Active	Alarm Out	Alarm Out	Based on "FailOpts"	Normal Operation	Alarm
	F	031: Ind bd mismatch	31	Indicator board mismatch	Mismatch of indicator board was detected.	Contact Yokogawa service center.	Contact Yokogawa service center.	Active	Non-Active	Alarm Out	Alarm Out	Based on "FailOpts"	Normal Operation	Alarm
	F	032: Ind comm ERR	32	Indicator communication error	Communication error of indicator board was detected.	Check connection of indicator & main board.	Check connection of indicator & main board.	Active	Non-Active	Alarm Out	Alarm Out	Based on "FailOpts"	Normal Operation	Alarm
	F	033: microSD FAIL	33	microSD failure	Failure of microSD card was detected.	Change microSD card.	Change microSD card.	Active	Non-Active	Alarm Out	Alarm Out	Based on "FailOpts"	Normal Operation	Alarm

Alarm Item	NE107 Status	Error Message		Error Description	Countermeasure Message		Countermeasure	Operation at the time of error					Process Value	Display
		Display	HART		Display	Output								
						Alarm		Warning	Current	Pulse / Status	Total			
Process Alarm	S	050: Signal overflow	Signal overflow	Failure of input signal was detected.	Check signal cable and grounding.	Check signal cable and grounding.	Check signal cable and grounding.	Active	Non-Active	Alarm Out	Alarm Out	Based on "FailOpts"	Hold prior setting	Alarm
	S	051: Empty detect	Empty pipe detection	Empty inside of sensor was detected. (Empty pipe detection)	Fill flow tube with fluid.	Fill flow tube with fluid.	Fill flow tube with fluid.	Active	Non-Active	Alarm Out	Alarm Out	Based on "FailOpts"	Hold prior setting	Alarm
	N	052: H/L HH/LL alm	H/L or HH/LL alarm	Flow rate exceeded upper limit or lower limit.	Check flow rate and setting value.	Check flow rate and setting value.	Check flow rate and setting value.	Active	Non-Active	Normal	Normal	Continue	Normal Operation	Alarm
Setting Alarm	S	053: Adh over lv 4	Adhesion over level 4	The resistance value of the electrodes exceeded Level 4. (Adhesion detection of insulation to electrode)	Clean electrodes.	Clean electrodes.	Clean electrodes.	Active	Non-Active	Alarm Out	Alarm Out	Based on "FailOpts"	Normal Operation	Alarm
	S	060: Span cfg ERR	Span configuration error	Setting error of flow span was detected. (fulfill "0.05 m/s < Span < 16 m/s")	Change span parameter setting.	Change span parameter setting.	Change or change span parameter setting.	Active	Non-Active	Alarm Out	Alarm Out	Based on "FailOpts"	Normal Operation	Alarm
	S	062: AO 1 4-20 lmt	Analog output 1 4-20 mA limit error	Setting error of Current output 1 was detected. (fulfill "LRV < HRV")	Change Analog output 1 parameter setting.	Change Analog output 1 parameter setting.	Check or change Analog output 1 parameter setting.	Active	Non-Active	Normal	Normal	Continue	Normal Operation	Alarm
Setting Alarm	S	064: AO 1 mlt 64 rng	Analog output 1 multi range error	Setting error of Multi range function was detected. (fulfill "1st range <= 2nd range" and select "either multi range or absolute range".)	Change multi range parameter setting.	Change multi range parameter setting.	Check or change multi range parameter setting.	Active	Non-Active	Alarm Out	Normal	Based on "FailOpts"	Normal Operation	Alarm
	N	065: H/L cfg ERR	H/L HH/LL configuration error	Setting error of alarm high/low limit function was detected. (fulfill "Hi Alarm - Lo Alarm > H/L Hys" and "HH Alarm - LL Alarm > HH/LL Hys")	Change H/L, HH/LL parameter setting.	Change H/L, HH/LL parameter setting.	Check and change H/L, HH/LL parameter setting.	Active	Non-Active	Alarm Out	Normal	Based on "FailOpts"	Normal Operation	Alarm
	S	066: Density cfg ERR	Density configuration error	Setting error of density value was detected when PV was set to mass flow rate.	Change Density parameter setting.	Change Density parameter setting.	Check and change Density parameter setting.	Active	Non-Active	Alarm Out	Alarm Out	Based on "FailOpts"	Normal Operation	Alarm
Setting Alarm	S	067: Pls 1 cfg ERR	Pulse output 1 configuration error	Setting error of Pulse output 1 was detected.	Change Pulse output 1 parameter setting.	Change Pulse output 1 parameter setting.	Change Pulse output 1 parameter setting.	Active	Non-Active	Alarm Out	Alarm Out	Continue	Normal Operation	Alarm
	S	068: Pls 2 cfg ERR	Pulse output 2 configuration error	Setting error of Pulse output 2 was detected.	Change Pulse output 2 parameter setting.	Change Pulse output 2 parameter setting.	Check and change Pulse output 2 parameter setting.	Active	Non-Active	Alarm Out	Alarm Out	Continue	Normal Operation	Alarm
	C	069: Nomi size cfg	Nominal size configuration error	Configuration error of nominal size was detected. (fulfill "0.99 mm < nominal size < 3000.10 mm (0.01 inch < nominal size < 120.10 inch)")	Change nominal parameter setting.	Change nominal parameter setting.	Check and change nominal parameter setting.	Active	Non-Active	Alarm Out	Alarm Out	Based on "FailOpts"	Normal Operation	Alarm

Alarm Item	NE107 Status	Error Message		Error Description	Countermeasure Message		Operation at the time of error				Process Value	Display																																																																																	
		Display	HART		Display	Countermeasure	Alarm	Warning	Current	Pulse / Status			Total																																																																																
														Alarm	Warning	Current	Pulse / Status																																																																												
Setting Alarm	C	070: Adh cfg ERR	70	Adhesion configuration error	Setting error of electrode adhesion detection function was detected. (fulfill "Level1 < Level2 < Level3 < Level4")	Change adhesion parameter setting.	Check and change adhesion parameter setting.	Active	Non-Active	Normal	Continue	Normal Operation	Alarm																																																																																
														072: Log not start	72	Data logging failed to start.	Insert microSD card.	Active	Non-Active	Normal	Continue	Normal Operation	Alarm																																																																						
																								080: AO 1 saturate	80	Analog output 1 was saturated	Check process or parameter setting.	Non-Active	Active	Normal	Continue	Normal Operation	Warning																																																												
																																		082: Pls 1 saturate	82	Pulse output 1 was saturated	Check process or parameter setting.	Non-Active	Active	Normal	Continue	Normal Operation	Warning																																																		
																																												083: Pls 2 saturate	83	Pulse output 2 was saturated	Check process or parameter setting.	Non-Active	Active	Normal	Continue	Normal Operation	Warning																																								
																																																						085: Cable miscon	85	Cable mismatch	Check the signal/EX cable connection.	Non-Active	Active	Normal	Continue	Normal Operation	Warning																														
																																																																086: Coil insulation	86	Coil insulation warning	Coil insulation is detected.	Non-Active	Active	Normal	Continue	Normal Operation	Warning																				
																																																																										087: Adhesion lv 3	87	Adhesion over level 3	The resistance value of electrode exceeded Level 3. (Adhesion detection of insulation to electrode)	Non-Active	Active	Normal	Continue	Normal Operation	Warning										
																																																																																				092: AZ warn	92	Autozero warning	Result of Autozero adjustment (Mag Flow Zero) exceeded 10 cm/s.	Non-Active	Active	Normal	Continue	Normal Operation	Warning
095: Simulate active	95	Simulation active	Test mode was executed for any of Flow velocity, Volumetric flow rate, Mass flow rate, Current output, Pulse output, Status input, Status output.	Non-Active	Active	Normal	Continue	Normal Operation	Warning																																																																																				
										096: AO 1 fix	96	Analog output 1 fixed	It was detected that fixed value is set to Current output 1.	Non-Active	Active	Normal	Continue	Normal Operation	Warning																																																																										
																				Warning	M	087: Adhesion lv 3	The resistance value of electrode exceeded Level 3. (Adhesion detection of insulation to electrode)	Non-Active	Active	Normal	Continue	Normal Operation	Warning																																																																
																														C	092: AZ warn	Autozero warning	Result of Autozero adjustment (Mag Flow Zero) exceeded 10 cm/s.	Non-Active	Active	Normal	Continue	Normal Operation	Warning																																																						
																																								C	093: Verif warn	Verification warning	Interruption of verification function was detected.	Non-Active	Active	Normal	Continue	Normal Operation	Warning																																												
																																																		C	095: Simulate active	Simulation active	Test mode was executed for any of Flow velocity, Volumetric flow rate, Mass flow rate, Current output, Pulse output, Status input, Status output.	Non-Active	Active	Normal	Continue	Normal Operation	Warning																																		
																																																												S	096: AO 1 fix	Analog output 1 fixed	It was detected that fixed value is set to Current output 1.	Non-Active	Active	Normal	Continue	Normal Operation	Warning																								

Alarm Item	NE107 Status	Error Message		Error Description	Countermeasure Message		Countermeasure	Operation at the time of error				Process Value	Display
		Display	HART		Display	Display		Output			Total		
								Alarm	Warning	Current			
Warning	S	098: Pls 1 fix	98	Pulse output 1 fixed	It was detected that fixed value is set to Pulse output 1.	Please cancel the fixed output.	Check pulse output 1 is test mode or not.	Non-Active	Active	Normal	Continue	Normal Operation	Warning
	S	099: Pls 2 fix	99	Pulse output 2 fixed	It was detected that fixed value is set to Pulse output 2.	Please cancel the fixed output.	Check pulse output 2 is test mode or not.	Non-Active	Active	Normal	Continue	Normal Operation	Warning
	C	101: Param restore run	101	Parameter restore running	Restore function of parameter is running.	—	—	Non-Active	Active	Normal	Continue	Normal Operation	Execute
	N	102: Disp over	102	Display over warning	Number of digits available for display exceeded the limit.	Check Display format parameter.	Check Display format parameter.	Non-Active	Active	Normal	Continue	Normal Operation	Warning
	N	103: SD size warn	103	microSD card size warning	Free space of microSD card decreased to less than 10%.	microSD card may run out of memory space.	microSD card may run out of memory space.	Non-Active	Active	Normal	Continue	Normal Operation	Warning
	M	104: Bkup incmpt	104	Parameter backup incomplete	Parameter backup failed.	Retry parameter backup.	Retry parameter backup.	Non-Active	Active	Normal	Continue	Normal Operation	Warning
	S	105: SD mismatch	105	microSD card mismatch	Mismatch of microSD card was detected.	Change microSD card.	Change microSD card.	Non-Active	Active	Normal	Continue	Normal Operation	Warning
	M	106: SD removal ERR	106	microSD card removal procedure error	Removal of microSD card failed.	Remove microSD in appropriate procedure.	Remove microSD in appropriate procedure.	Non-Active	Active	Normal	Continue	Normal Operation	Warning
	N	131: Trans mismatch	131	Transmitter type mismatch	Mismatch of sensor and transmitter was detected.	Contact Yokogawa service center.	Contact Yokogawa service center.	Non-Active	Active	Normal	Continue	Normal Operation	Normal
	N	120: Watchdog	120	Watchdog	Error of Watchdog timer was detected.	—	Contact Yokogawa service center.	Non-Active	Active	Normal	Continue	Normal Operation	Normal
	N	121: Power off	121	Power off	Power-off was detected.	—	—	Non-Active	Active	Normal	Continue	Normal Operation	Normal
	N	122: Inst power FAIL	122	Instant power failure	Instantaneous power failure was detected.	—	—	Non-Active	Active	Normal	Continue	Normal Operation	Normal
	Information	N	123: Param bkup run	123	Parameter backup running	Parameter backup is running.	—	—	Non-Active	Active	Normal	Continue	Normal Operation
N		124: Data log run	124	Data logging running	Data log is running.	—	—	Non-Active	Active	Normal	Continue	Normal Operation	Icon
N		130: DeVID not enter	130	Device ID not entered	No data entry of Device ID was detected.	Contact Yokogawa service center.	Contact Yokogawa service center.	Non-Active	Active	Normal	Continue	Normal Operation	Normal

4.8.2 Alarm Display Setting

(1) Alarm display

If an error occurs on this instrument, an alarm appears on the display. The alarm display modes are classified into two types: mode to display the process value and alarm name, and mode to display the alarm name and action. If multiple errors occur on this instrument, the corresponding alarms are displayed in sequence on the display. This setting can be configured with the following parameters.

Display menu path:

Device setup ▶ Detailed setup ▶ Display set ▶ Optional config ▶ (see below)

Alarm display	Sets the alarm display.*1
---------------	---------------------------

HART communication:

Device root menu ▶ Detailed setup ▶ Display ▶ Display operation configuration ▶ (see below)

Display alarm	Sets the alarm display.*1
---------------	---------------------------

*1: From the table below, select the alarm display.

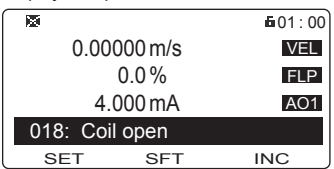
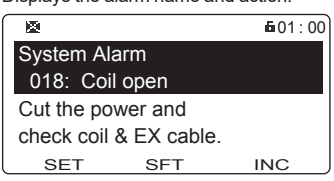
Normal	Displays the process value and alarm name. 
Detail	Displays the alarm name and action. 

(2) Alarm display based on NAMUR NE107

A prefix can be assigned to the alarm name based on NAMUR NE107. This setting can be configured with the following parameters.

Display menu path:

Device setup ▶ Detailed setup ▶ Display set ▶ Optional config ▶ (see below)

NE107 display	Sets the alarm display based on NAMUR NE107.*1
---------------	------------------------------------------------

HART communication:

Device root menu ▶ Detailed setup ▶ Display ▶ Display operation configuration ▶ (see below)

Display NE107	Sets the alarm display based on NAMUR NE107.*1
---------------	------------------------------------------------

*1: From the table below, select alarm display.

Normal	Sets to the normal alarm display.
NE107	Sets the alarm display based on NAMUR NE107.

4.8.3 Alarm History Function

The alarm history function records the previously detected alarms as a history.

This setting can be configured with the following parameters.

Display menu path:

Device setup ► Diag/Service ► Sts/Self test ► Alarm ► Alarm record ► (see below)

Record alarm 1	Displays the name of new alarm 1.
Record time 1	Displays the operating time at which new alarm 1 has occurred.
Record alarm 2	Displays the name of new alarm 2.
Record time 2	Displays the operating time at which new alarm 2 has occurred.
Record alarm 3	Displays the name of new alarm 3.
Record time 3	Displays the operating time at which new alarm 3 has occurred.
Record alarm 4	Displays the name of new alarm 4.
Record time 4	Displays the operating time at which new alarm 4 has occurred.

HART communication:

Diagnostic root menu ► Status/Self test ► Alarm ► Alarm record ► (see below)

Alarm record 1	Displays the name of new alarm 1.
Alarm record time 1	Displays the operating time at which new alarm 1 has occurred.
Alarm record 2	Displays the name of new alarm 2.
Alarm record time 2	Displays the operating time at which new alarm 2 has occurred.
Alarm record 3	Displays the name of new alarm 3.
Alarm record time 3	Displays the operating time at which new alarm 3 has occurred.
Alarm record 4	Displays the name of new alarm 4.
Alarm record time 4	Displays the operating time at which new alarm 4 has occurred.

The operating time at alarm occurrence is displayed in format, “ddddD hh:mm”. “ddddD” indicates the day, “hh” indicates the hour, and “mm” indicates the minute.

Example:

“00031D 12:34” is displayed.

This example shows that an alarm has occurred when the instrument has operated for 31 days, 12 hours, and 34 minutes.

4.8.4 Alarm Mask Function

The alarm mask function can mask the specified alarm, hide an alarm notification, and record no alarm history. This function can be set for each of the alarm notification and alarm history.

This setting can be configured with the following parameters.

■Alarm notification mask

If the alarm notification mask function is turned “On”, it disables alarm notification.

Setting example for alarm “Signal overflow”:

To disable the alarm notification, set “Signal overflow on” of Alarm out mask to “On”.

To enable the alarm notification, set “Signal overflow on” of Alarm out mask to “Off”.

Display menu path:

Device setup ► Diag/Service ► Sts/Self test ► Alarm ► Alarm out mask ► (see below)

Mask 1-1	Specifies the mask function for alarm notification 1-1.
Mask 1-2	Specifies the mask function for alarm notification 1-2.
Mask 2-1	Specifies the mask function for alarm notification 2-1.
Mask 2-2	Specifies the mask function for alarm notification 2-2.
Mask 3-1	Specifies the mask function for alarm notification 3-1.
Mask 3-2	Specifies the mask function for alarm notification 3-2.
Mask 4-1	Specifies the mask function for alarm notification 4-1.

HART communication:

Diagnostic root menu ► Status/Self test ► Alarm ► Alarm out mask ► (see below)

Alarm out mask 1	Specifies the mask function for alarm notification 1.
Alarm out mask 2	Specifies the mask function for alarm notification 2.
Alarm out mask 3	Specifies the mask function for alarm notification 3.
Alarm out mask 4	Specifies the mask function for alarm notification 4.

■Alarm record mask

If the alarm record mask function is turned “On”, it disables the alarm record.

Setting example for alarm “Empty pipe detection”:

To disable the alarm record, set “Empty pipe detection on” of Alarm out mask to “On”.

To enable the alarm record, set “Empty pipe detection on” of Alarm record mask to “Off”.

Display menu path:

Device setup ▶ Diag/Service ▶ Sts/Self test ▶

Alarm ▶ Alarm record mask ▶ (see below)

Mask 1-1	Specifies the mask function for alarm history 1-1.
Mask 1-2	Specifies the mask function for alarm history 1-2.
Mask 2-1	Specifies the mask function for alarm history 2-1.
Mask 2-2	Specifies the mask function for alarm history 2-2.
Mask 3-1	Specifies the mask function for alarm history 3-1.

HART communication:

Diagnostic root menu ▶ Status/Self test ▶

Alarm ▶ Alarm record mask ▶ (see below)

Alarm record mask 1	Specifies the mask function for alarm history 1.
Alarm record mask 2	Specifies the mask function for alarm history 2.
Alarm record mask 3	Specifies the mask function for alarm history 3.



NOTE

Note that the alarm masked by the alarm notification mask function is not recorded in the alarm history.

The alarm mask function setting is as follows.

Parameter name	Indicates the name of the mask setting parameter.
Alarm name	Indicates the alarm name.
Default value	Indicates the default value (upon shipment from the manufacturing plant). (○: Masked, -: Not masked)
Attribute	Indicates whether the mask setting is enabled or disabled. (○: Enabled, -: Disabled)

(1) Alarm notification mask function

Display				HART			
Parameter name	Alarm name	Default value	Attribute	Parameter name	Alarm name	Default value	Attribute
—	010: Main CPU FAIL	—	—	—	10 Main board CPU failure	—	—
—	011: Rev calc FAIL	—	—	—	11 Reverse calculation failure	—	—
—	012: Main EEP FAIL	—	—	—	12 Main board EEPROM failure	—	—
Mask 1-1	013: Main EEP dflt	—	○	Alarm out mask 1	13 Main board EEPROM default	—	○
—	014: Snsr bd FAIL	—	—	—	14 Sensor board failure	—	—
—	015: Snsr comm ERR	—	—	—	15 Sensor communication error	—	—
—	016: AD 1 FAIL[Sig]	—	—	—	16 A/D1 failure[Signal]	—	—
—	017: AD 2 FAIL[Excit]	—	—	—	17 A/D2 failure[Exciter]	—	—
—	018: Coil open	—	—	—	18 Coil open	—	—
—	019: Coil short	—	—	—	19 Coil short	—	—
—	020: Exciter FAIL	—	—	—	20 Exciter failure	—	—
Mask 1-2	021: PWM 1 stop	—	○	Alarm out mask 1	21 PWM1 stop	—	○
Mask 1-2	022: PWM 2 stop	—	○	Alarm out mask 1	22 PWM2 stop	—	○
Mask 1-2	023: Opt bd mismatch	—	○	Alarm out mask 1	23 Option board mismatch	—	○
Mask 1-2	024: Opt bd EEP FAIL	—	○	Alarm out mask 1	24 Option board EEPROM failure	—	○
Mask 1-2	025: Opt bd A/D FAIL	—	○	Alarm out mask 1	25 Option board A/D failure	—	○
Mask 1-2	026: Opt bd SPI FAIL	—	○	Alarm out mask 1	26 Option board SPI failure	—	○
—	027: Restore FAIL	—	—	—	27 Parameter restore incomplete	—	—
Mask 1-2	028: Ind bd FAIL	○	○	Alarm out mask 1	28 Indicator board failure	○	○
Mask 1-2	029: Ind bd EEP FAIL	—	○	Alarm out mask 1	29 Indicator board EEPROM failure	—	○
Mask 1-2	030: LCD drv FAIL	—	○	Alarm out mask 1	30 LCD driver failure	—	○
Mask 1-2	031: Ind bd mismatch	—	○	Alarm out mask 1	31 Indicator board mismatch	—	○
Mask 1-2	032: Ind comm ERR	—	○	Alarm out mask 1	32 Indicator communication error	—	○
Mask 1-2	033: microSD FAIL	—	○	Alarm out mask 1	33 microSD failure	—	○
Mask 2-1	050: Signal overflow	—	○	Alarm out mask 2	50 Signal overflow	—	○
Mask 2-1	051: Empty detect	—	○	Alarm out mask 2	51 Empty pipe detection	—	○
Mask 2-1	052: H/L HH/LL alm	○	○	Alarm out mask 2	52 H/L or HH/LL alarm	○	○
Mask 2-1	053: Adh over lv 4	○	○	Alarm out mask 2	53 Adhesion over level 4	○	○
Mask 2-1	060: Span cfg ERR	—	○	Alarm out mask 2	60 Span configuration error	—	○
Mask 2-1	062: AO 1 4-20 lmt	—	○	Alarm out mask 2	62 Analog output 1 4-20 mA limit error	—	○
Mask 2-1	064: AO 1 mlt rng	—	○	Alarm out mask 2	64 Analog output 1 multi range error	—	○
Mask 2-1	065: H/L cfg ERR	—	○	Alarm out mask 2	65 H/L HH/LL configuration error	—	○
Mask 2-1	066: Density cfg ERR	—	○	Alarm out mask 2	66 Density configuration error	—	○
Mask 2-2	067: Pls 1 cfg ERR	—	○	Alarm out mask 2	67 Pulse output 1 configuration error	—	○
Mask 2-2	068: Pls 2 cfg ERR	—	○	Alarm out mask 2	68 Pulse output 2 configuration error	—	○
Mask 2-2	069: Nomi size cfg	—	○	Alarm out mask 2	69 Nominal size configuration error	—	○
Mask 2-2	070: Adh cfg ERR	—	○	Alarm out mask 2	70 Adhesion configuration error	—	○
Mask 2-2	072: Log not start	—	○	Alarm out mask 2	72 Data logging not started	—	○
Mask 2-2	080: AO 1 saturate	○	○	Alarm out mask 2	80 Analog output 1 saturated	○	○
Mask 2-2	082: Pls 1 saturate	○	○	Alarm out mask 2	82 Pulse output 1 saturated	○	○
Mask 2-2	083: Pls 2 saturate	○	○	Alarm out mask 2	83 Pulse output 2 saturated	○	○
Mask 2-2	085: Cable miscon	—	○	Alarm out mask 2	85 Cable misconnect	—	○
Mask 2-2	086: Coil insulation	○	○	Alarm out mask 2	86 Coil insulation warning	○	○
Mask 2-2	131: Trans mismatch	—	○	Alarm out mask 2	131 Transmitter type mismatch	—	○
Mask 3-1	087: Adhesion lv 3	○	○	Alarm out mask 3	87 Adhesion over level 3	○	○
Mask 3-1	092: AZ warn	○	○	Alarm out mask 3	92 Autozero warning	○	○
Mask 3-1	093: Verif warn	○	○	Alarm out mask 3	93 Verification warning	○	○
Mask 3-1	095: Simulate active	—	○	Alarm out mask 3	95 Simulation active	—	○
Mask 3-1	096: AO 1 fix	—	○	Alarm out mask 3	96 Analog output 1 fixed	—	○
Mask 3-1	098: Pls 1 fix	—	○	Alarm out mask 3	98 Pulse output 1 fixed	—	○
Mask 3-1	099: Pls 2 fix	—	○	Alarm out mask 3	99 Pulse output 2 fixed	—	○
Mask 3-2	101: Param restore run	○	○	Alarm out mask 3	101 Parameter restore running	○	○
Mask 3-2	102: Disp over	○	○	Alarm out mask 3	102 Display over warning	○	○
Mask 3-2	103: SD size warn	○	○	Alarm out mask 3	103 microSD card size warning	○	○
Mask 3-2	104: Bkup incmplt	○	○	Alarm out mask 3	104 Parameter backup incomplete	○	○
Mask 3-2	105: SD mismatch	○	○	Alarm out mask 3	105 microSD card mismatch	○	○
Mask 3-2	106: SD removal ERR	○	○	Alarm out mask 3	106 microSD card removal procedure error	○	○

Display				HART			
Parameter name	Alarm name	Default value	Attribute	Parameter name	Alarm name	Default value	Attribute
Mask 3-2	120: Watchdog*1	○	○	Alarm out mask 3	120 Watchdog*1	○	○
Mask 3-2	121: Power off*1	○	○	Alarm out mask 3	121 Power off*1	○	○
Mask 3-2	122: Inst power FAIL*1	○	○	Alarm out mask 3	122 Instant power failure*1	○	○
Mask 3-2	123: Param bkup run	○	○	Alarm out mask 3	123 Parameter backup running	○	○
Mask 3-2	124: Data log run	○	○	Alarm out mask 3	124 Data logging running	○	○
Mask 4-1	130:DevID not enter	○	○	Alarm out mask 4	130 Device ID not entered	○	○

*1: Recorded in the alarm history regardless of the setting of the alarm notification mask function.

(2) Alarm history mask function

Display				HART			
Parameter name	Alarm name	Default value	Attribute	Parameter name	Alarm name	Default value	Attribute
—	010: Main CPU FAIL	—	—	—	10 Main board CPU failure	—	—
—	011: Rev calc FAIL	—	—	—	11 Reverse calculation failure	—	—
—	012: Main EEP FAIL	—	—	—	12 Main board EEPROM failure	—	—
Mask 1-1	013: Main EEP dftt	—	○	Alarm record mask 1	13 Main board EEPROM default	—	○
—	014: Snsr bd FAIL	—	—	—	14 Sensor board failure	—	—
—	015: Snsr comm ERR	—	—	—	15 Sensor communication error	—	—
—	016: AD 1 FAIL[Sig]	—	—	—	16 A/D1 failure[Signal]	—	—
—	017: AD 2 FAIL[Excit]	—	—	—	17 A/D2 failure[Exciter]	—	—
—	018: Coil open	—	—	—	18 Coil open	—	—
—	019: Coil short	—	—	—	19 Coil short	—	—
Mask 1-1	020: Exciter FAIL	—	○	Alarm record mask 1	20 Exciter failure	—	○
Mask 1-2	021: PWM 1 stop	—	○	Alarm record mask 1	21 PWM1 stop	—	○
Mask 1-2	022: PWM 2 stop	—	○	Alarm record mask 1	22 PWM2 stop	—	○
Mask 1-2	023: Opt bd mismatch	—	○	Alarm record mask 1	23 Option board mismatch	—	○
Mask 1-2	024: Opt bd EEP FAIL	—	○	Alarm record mask 1	24 Option board EEPROM failure	—	○
Mask 1-2	025: Opt bd A/D FAIL	—	○	Alarm record mask 1	25 Option board A/D failure	—	○
Mask 1-2	026: Opt bd SPI FAIL	—	○	Alarm record mask 1	26 Option board SPI failure	—	○
—	027: Restore FAIL	—	—	—	27 Parameter restore incomplete	—	—
Mask 1-2	028: Ind bd FAIL	—	○	Alarm record mask 1	28 Indicator board failure	—	○
Mask 1-2	029: Ind bd EEP FAIL	—	○	Alarm record mask 1	29 Indicator board EEPROM failure	—	○
Mask 1-2	030: LCD drv FAIL	—	○	Alarm record mask 1	30 LCD driver failure	—	○
Mask 1-2	031: Ind bd mismatch	—	○	Alarm record mask 1	31 Indicator board mismatch	—	○
Mask 1-2	032: Ind comm ERR	—	○	Alarm record mask 1	32 Indicator communication error	—	○
Mask 1-2	033: microSD FAIL	—	○	Alarm record mask 1	33 microSD failure	—	○
Mask 2-1	050: Signal overflow	—	○	Alarm record mask 2	50 Signal overflow	—	○
Mask 2-1	051: Empty detect	—	○	Alarm record mask 2	51 Empty pipe detection	—	○
Mask 2-1	052: H/L HH/LL alm	—	○	Alarm record mask 2	52 H/L or HH/LL alarm	—	○
Mask 2-1	053: Adh over lv 4	—	○	Alarm record mask 2	53 Adhesion over level 4	—	○
—	060: Span cfg ERR	○	—	—	60 Span configuration error	○	—
—	062: AO 1 4-20 lmt	○	—	—	62 Analog output 1 4-20 mA limit error	○	—
—	064: AO 1 mlt rng	○	—	—	64 Analog output 1 multi range error	○	—
—	065: H/L cfg ERR	○	—	—	65 H/L HH/LL configuration error	○	—
—	066: Density cfg ERR	○	—	—	66 Density configuration error	○	—
—	067: Pls 1 cfg ERR	○	—	—	67 Pulse output 1 configuration error	○	—
—	068: Pls 2 cfg ERR	○	—	—	68 Pulse output 2 configuration error	○	—
—	069: Nomi size cfg	○	—	—	69 Nominal size configuration error	○	—
—	070: Adh cfg ERR	○	—	—	70 Adhesion configuration error	○	—
—	072: Log not start	○	—	—	72 Data logging not started	○	—
—	080: AO 1 saturate	○	—	—	80 Analog output 1 saturated	○	—
—	082: Pls 1 saturate	○	—	—	82 Pulse output 1 saturated	○	—
—	083: Pls 2 saturate	○	—	—	83 Pulse output 2 saturated	○	—
Mask 2-2	085: Cable miscon	—	○	Alarm record mask 2	85 Cable misconnect	—	○
—	086: Coil insulation	○	—	—	86 Coil insulation warning	○	—
—	131: Trans mismatch	○	—	—	131 Transmitter type mismatch	○	—
—	087: Adhesion lv 3	○	—	—	87 Adhesion over level 3	○	—
—	092: AZ warn	○	—	—	92 Autozero warning	○	—
—	093: Verif warn	○	—	—	93 Verification warning	○	—
—	095: Simulate active	○	—	—	95 Simulation active	○	—
—	096: AO 1 fix	○	—	—	96 Analog output 1 fixed	○	—
—	098: Pls 1 fix	○	—	—	98 Pulse output 1 fixed	○	—
—	099: Pls 2 fix	○	—	—	99 Pulse output 2 fixed	○	—
—	101: Param restore run	○	—	—	101 Parameter restore running	○	—

Display				HART			
Parameter name	Alarm name	Default value	Attribute	Parameter name	Alarm name	Default value	Attribute
—	102: Disp over	○	—	—	102 Display over warning	○	—
—	103: SD size warn	○	—	—	103 microSD card size warning	○	—
—	104: Bkup incmplt	○	—	—	104 Parameter backup incomplete	○	—
—	105: SD mismatch	○	—	—	105 microSD card mismatch	○	—
—	106: SD removal ERR	○	—	—	106 microSD card removal procedure error	○	—
—	120: Watchdog*1	—	—	—	120 Watchdog*1	—	—
—	121: Power off*1	—	—	—	121 Power off*1	—	—
—	122: Inst power FAIL*1	—	—	—	122 Instant power failure*1	—	—
—	123: Param bkup run	○	—	—	123 Parameter backup running	○	—
—	124: Data log run	○	—	—	124 Data logging running	○	—
Mask 3-1	130:DevID not enter	○	○	Alarm record mask 3	130 Device ID not entered	○	○

*1: Recorded in the alarm history regardless of the setting of the alarm notification mask function.

4.9 Display

4.9.1 Language Setting

The language to be used on the display can be selected from nine types.

Select the desired display language from the languages that are included in the language package specified at the time of ordering.

This setting can be configured with the following parameters.

Display menu path:

Language selection:

Device setup ► (see below)

Language	Specify the language to be used on the display.*1
----------	---------------------------------------------------

Display of language package:

Device setup ► Detailed setup ► Display set ►

Optional config ► (see below)

Language package	Indicates the language package for the display.
------------------	-------------------------------------------------

HART communication:

Device root menu ► Detailed setup ► Display ►

Display operation configuration ► (see below)

Language	Specify the language to be used on the display.*1
Language package	Indicates the language package for the display.

The following languages are included in the language package.

Package 1	Japanese, English, French, German, Italian, Spanish, Portuguese, and Russian
Package 2	English and Chinese

*1: From the table below, select the language to be used on the display.

English	Displays parameters in English.
French	Displays parameters in French.
German	Displays parameters in German.
Italian	Displays parameters in Italian.
Spanish	Displays parameters in Spanish.
Portuguese	Displays parameters in Portuguese.
Russian	Displays parameters in Russian.
Chinese	Displays parameters in Chinese.
Japanese	Displays parameters in Japanese.

4.9.2 Display Item Setting

This instrument can be shown up to eight items on the display while scrolling the screen. Specify a display item in each of eight display lines.

This setting can be configured with the following parameters.

Display menu path:

Device setup ► Detailed setup ► Display set ►

Line select ► (see below)

Line 1	Specify item 1 to be shown on the display.
Line 2	Specify item 2 to be shown on the display.
Line 3	Specify item 3 to be shown on the display.
Line 4	Specify item 4 to be shown on the display.
Line 5	Specify item 5 to be shown on the display.
Line 6	Specify item 6 to be shown on the display.
Line 7	Specify item 7 to be shown on the display.
Line 8	Specify item 8 to be shown on the display.

HART communication:

Device root menu ► Detailed setup ► Display ►

Line select ► (see below)

Display select1	Specify item 1 to be shown on the display.
Display select2	Specify item 2 to be shown on the display.
Display select3	Specify item 3 to be shown on the display.
Display select4	Specify item 4 to be shown on the display.
Display select5	Specify item 5 to be shown on the display.
Display select6	Specify item 6 to be shown on the display.
Display select7	Specify item 7 to be shown on the display.
Display select8	Specify item 8 to be shown on the display.

*1: From the table below, select the items to be shown on the display.

None	Does not display items (item 1 is not selectable).
Flow rate(%)	Displays the flow rate for the span of the process value that is PV-mapped in Subsection 4.1.2.
PV	Displays the process value that is PV-mapped in Subsection 4.1.2.
Velocity	Displays the flow velocity.
Volume flow	Displays the volumetric flow rate.
Mass flow	Displays the mass flow rate.
Flow rate(%Bar)	Displays the flow rate for the span of the process value that is PV-mapped in Subsection 4.1.2, using a bar graph.
Totalizer 1 *1	Displays the totalized value of totalizer 1.
Totalizer 2 *1	Displays the totalized value of totalizer 2.
Totalizer 3 *1	Displays the totalized value of totalizer 3.
Tag number	Displays the tag number.
Long tag	Displays the long tag.
Commun protocol	Displays the communication protocol.
Adhesion	Displays the adhesion level of the electrode adhesion detecting function.
Analog out 1	Specify the current value of current output 1 for the I/O1 terminal.

*1: The upper/lower limits on the display are limited by the number of digits that can be displayed according to the settings of the decimal point. For example, if the decimal point position of Totalizer 3 is set to decimal point 2, the upper and lower limits of Totalizer 3 are +999999.99 and -999999.99. If the totalized value exceeds the upper and lower limits, it is reset to 0. For details about decimal-point position setting, refer to Subsection 4.9.3. If the totalized value is reset to 0, the totalized value on the display may be different from the totalized value in Subsection 4.2.2. This is because the number of digits that can be displayed is different for both values. When re-totalizing, use the reset/preset function for the totalized value.



NOTE

When Main soft rev (Main board revision/ Main soft rev) is R1.01.06 or earlier, or Ind soft rev (Indicator board revision/Ind soft rev) is R2.01.01 or earlier, the upper/lower limits on the display are limited by the number of digits that can be displayed according to the settings of the decimal point. For example, if the decimal point position of Totalizer 3 is set to decimal point 2, the upper and lower limits of Totalizer 3 are +999999.99 and -999999.99. For details about decimal-point position setting, refer to Subsection 4.9.3.

If the totalized value exceed these upper and lower limits, they are held at the upper limit or lower limit.

For details about how to check the device revision (Main soft rev and Ind soft rev), refer to Subsection 4.10.2.

4.9.3 Decimal-Point Position Setting

The number of decimal places can be set to the automatic adjustment or fix mode for the totalized value or process value PV-mapped in Subsection 4.1.2.

This setting can be configured with the following parameters.

Display menu path:

Device setup ► Detailed setup ► Display set ► Disp format ► (see below)

Format PV	Specify the decimal-point position for the process value that is PV-mapped in Subsection 4.1.2.*1
Format total 1	Specify the decimal-point position for the totalized value of totalizer 1.*1
Format total 2	Specify the decimal-point position for the totalized value of totalizer 2.*1
Format total 3	Specify the decimal-point position for the totalized value of totalizer 3.*1

HART communication:

Device root menu ► Detailed setup ► Display ► Display format ► (see below)

Display format PV	Specify the decimal-point position for the process value that is PV-mapped in Subsection 4.1.2.*1
Display format total 1	Specify the decimal-point position for the totalized value of totalizer 1.*1
Display format total 2	Specify the decimal-point position for the totalized value of totalizer 2.*1
Display format total 3	Specify the decimal-point position for the totalized value of totalizer 3.*1

*1: From the table below, select the position of the decimal point.
Process value

Auto	Automatically adjusts the number of decimal places.
0 digit	Fixes the number of decimal places to "0".
1 digit	Fixes the number of decimal places to "1".
2 digit	Fixes the number of decimal places to "2".
3 digit	Fixes the number of decimal places to "3".
4 digit	Fixes the number of decimal places to "4".
5 digit	Fixes the number of decimal places to "5".

Totalized value

Auto	Automatically adjusts the number of decimal places.
0 digit	Fixes the number of decimal places to "0".
0 digit	Fixes the number of decimal places to "1".
2 digit	Fixes the number of decimal places to "2".
3 digit	Fixes the number of decimal places to "3".
4 digit	Fixes the number of decimal places to "4".
5 digit	Fixes the number of decimal places to "5".
6 digit	Fixes the number of decimal places to "6".
7 digit	Fixes the number of decimal places to "7".

4.9.4 Display Line Count and Scroll Settings

This instrument can be shown up to four lines on the display while scrolling up to eight items. The scroll method can be selected from the automatic display switching and the display switching using the IR switch.

These settings can be configured with the following parameters.

Display menu path:

Device setup ▶ Detailed setup ▶ Display set ▶ Optional config ▶

Line mode	Specify the number of lines to be shown on the display.*1
Scroll mode	Specify the display scroll method.*2

HART communication:

Device root menu ▶ Detailed setup ▶ Display ▶ Display operation configuration ▶ (see below)

Display line	Specify the number of lines to be shown on the display.*1
Display scroll	Specify the display scroll method.*2

*1: From the table below, select the number of display lines from the table below.
The font size is automatically adjusted depending on the number of display lines.

<p>1 Line(Big) (1-line display without unit. The numeric value is displayed largely.)</p> <p>F0427.ai</p>
<p>1 Line (1-line display with an unit)</p> <p>F0428.ai</p>
<p>2 Line (2-line display with units)</p> <p>F0429.ai</p>
<p>3 Line (3-line display with units)</p> <p>F0430.ai</p>

4 Line (4-line display with units)

F0431.ai

*2: From the table below, select the scroll method.

Off	Does not scroll.
Manual	Sets to the scroll using the IR switch.
Auto(2 s)	Sets to the automatic scroll at 2-second intervals.
Auto(4 s)	Sets to the automatic scroll at 4-second intervals.
Auto(8 s)	Sets to the automatic scroll at 8-second intervals.



NOTE

The default value of the scroll method (Display scroll/Scroll mode) is “Off”.

If the value of the scroll method is set to “Off”, the 5th line and beyond cannot be checked on the display.

To display the 5th line and beyond, set an option other than “Off”.



NOTE

When Main soft rev (Main board revision/Main soft rev) is R1.01.06 or earlier, the default value of the scroll method (Display scroll/Scroll mode) is “Manual”.

If the value of the scroll method is set to “Manual”, the display line is scrolled each time the infrared switch [INC] reacts.

4.9.5 Trend Graph Setting

The trend graph display function displays a time change of the selected item as a trend graph. Up to four items can be shown in a trend graph. A trend graph is scaled automatically, and the time axis flows from the left to the right.

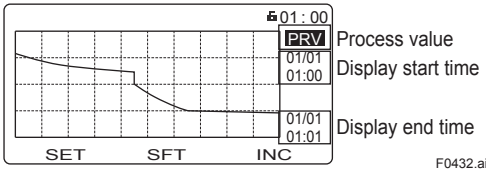

(1) Trend graph display setting

The table below shows the process values, low limit values, and high limit values that can be shown in a trend graph.

Process value	Display	Low limit value	High limit value
Flow rate (%)	FLP	0%	100%
PV	PRV	0	Span value specified in Subsection 4.1.5
Flow velocity	VEL		
Volumetric flow rate	VFL		
Mass flow rate	MFL		
Current output 1	AO1	4 mA	20 mA
Totalization 1	TL1	Preset value specified in Subsection 4.2.7	Target value of the totalizer specified in Subsection 4.2.3
Totalization 2	TL2		
Totalization 3	TL3		

This setting can be configured with the following parameters.

Display menu path:

Device setup ► Detailed setup ► Display set ► Optional config ► (see below)

Display mode	Specifies the display of a trend graph.*1
--------------	-------------------------------------------

HART communication:

Device root menu ► Detailed setup ► Display ► Display operation configuration ► (see below)

Display measure mode	Specifies the display of a trend graph.*1
----------------------	-------------------------------------------

*1: From the table below, select the trend graph display.

Normal	Does not display a trend graph (normal display).
Trend	Displays a trend graph.



NOTE

The trend graph display function is not synchronized with the multi range and forward/reverse range functions.

(2) Trend graph display item setting

This setting can be configured with the following parameters.

Display menu path:

Device setup ► Detailed setup ► Display set ► Trend select ► (see below)

Trend 1	Specify item 1 to be shown in a trend graph.*1
Trend 2	Specify item 2 to be shown in a trend graph.*1
Trend 3	Specify item 3 to be shown in a trend graph.*1
Trend 4	Specify item 4 to be shown in a trend graph.*1

HART communication:

Device root menu ► Detailed setup ► Display ► Trend select ► (see below)

Trend select 1	Specify item 1 to be shown in a trend graph.*1
Trend select 2	Specify item 2 to be shown in a trend graph.*1
Trend select 3	Specify item 3 to be shown in a trend graph.*1
Trend select 4	Specify item 4 to be shown in a trend graph.*1

*1: From the table below, select the display item of trend graph.

None	Does not set any items (item 1 is not selectable).
Flow rate (%)	Specify the flow rate for the span of the process value that is PV-mapped in Subsection 4.1.2.
PV	Specify the process value that is PV-mapped in Subsection 4.1.2.
Velocity	Specify the flow velocity.
Volume flow	Specify the volumetric flow rate.
Mass flow	Specify the mass flow rate.
Analog out1	Specify the current value of current output 1 for the I/O1 terminal.
Totalizer1	Specify the totalized value of totalizer 1.
Totalizer2	Specify the totalized value of totalizer 2.
Totalizer3	Specify the totalized value of totalizer 3.

(3) Update period setting

This setting can be configured with the following parameters.

Display menu path:

Device setup ► Detailed setup ► Display set ► Optional config ► (see below)

Period	Specify the trend graph update period on the display.*1
--------	---------------------------------------------------------

HART communication:

Device root menu ► Detailed setup ► Display ► Display operation configuration ► (see below)

Display period	Specify the trend graph update period on the display.*1
----------------	---------------------------------------------------------

*1: From the table below, select the trend graph update period.

0.2s	Sets the update period to 0.2 sec.
0.4s	Sets the update period to 0.4 sec.
1.0s	Sets the update period to 1 sec.
2.0s	Sets the update period to 2 sec.
4.0s	Sets the update period to 4 sec.
8.0s	Sets the update period to 8 sec.

4.9.6 Other Setting

(1) Display contrast setting

The display can be adjusted the contrast in 11 levels (+5 to -5). This setting can be configured with the following parameters.

Display menu path:

Device setup ► Detailed setup ► Display set ► Optional config ► (see below)

Contrast	Specify the contrast of the display.
----------	--------------------------------------

HART communication:

Device root menu ► Detailed setup ► Display ► Display operation configuration ► (see below)

Display contrast	Specify the contrast of the display.
------------------	--------------------------------------

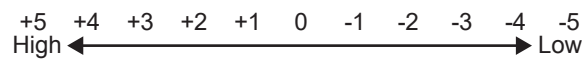

(2) Display damping time constant setting

This function enables to specify the damping time constant for the display independently of that specified in Subsection 4.1.6.

This setting can be configured with the following parameters.

Display menu path:

Device setup ► Detailed setup ► Display set ► Optional config ► (see below)

Damp	Specify the damping time constant of the display.
------	---------------------------------------------------

HART communication:

Device root menu ► Detailed setup ► Display ► Display operation configuration ► (see below)

Display damping	Specify the damping time constant of the display.
-----------------	---------------------------------------------------



NOTE

The damping time constant of the display is available only for the display. To specify the damping time constant for the output of the physical quantity, read Subsection 4.1.6.

(3) Date display format setting

The date display format can be specified.

This setting can be configured with the following parameters.

Display menu path:

Device setup ► Detailed setup ► Display set ► Optional config ► (see below)

Format date	Specify the date display format.*1
-------------	------------------------------------

HART communication:

Device root menu ► Detailed setup ► Display ► Display operation configuration ► (see below)

Display format date	Specify the date display format.*1
---------------------	------------------------------------

*1: From the table below, specify the date display format.

MM/DD/YYYY	Displays the date in "month/day/year".
DD/MM/YYYY	Displays the date in "day/month/year".
YYYY/MM/DD	Displays the date in "year/month/day".

(4) Display black/white inverse setting

The black/white inverse function is available for the display.

This setting can be configured with the following parameters.

Display menu path:

Device setup ► Detailed setup ► Display set ► Optional config ► (see below)

Inversion	Specify the display black/white inverse mode.*1
-----------	-------------------------------------------------

HART communication:

Device root menu ► Detailed setup ► Display ► Display operation configuration ► (see below)

Display inversion	Specify the display black/white inverse mode.*1
-------------------	-------------------------------------------------

*1: From the table below, select the display black/white inverse mode.

Normal	Does not set the display to the black/white inverse mode. (Character color: Black, Background color: White)
Invert	Sets the display to the black/white inverse mode. (Character color: White, Background color: Black)

(5) Display squawk setting

The backlight of the display can be squawked at 4-second intervals to identify the communicating instrument where are installed a number of same models.

This setting can be configured with the following parameters.

Display menu path:

Device setup ► Diag/Service ► Disp indicator ► (see below)

Squawk	Squawks the display.*1
--------	------------------------

HART communication:

Maintenance root menu ► Display indication ► (see below)

Squawk	Squawks the display.*1
--------	------------------------

*1: From the table below, select whether to squawk the display.

Off	Does not squawk the display.
On	Squawks the display (continuous).
Squawk Once	Squawks the display (once only).

4.9.7 microSD Card Setting

The dedicated microSD card performs to use the backup parameters and logging data by inserting into the display if the optional code MC is selected. For details about backing up parameters and logging data, read Section 4.13.

(1) Removing the microSD card



IMPORTANT

If the microSD card is removed without executing “Unmount” on software, it may cause the stored data to be erased or the device to operate abnormally.

The microSD card can be removed with the following parameters.

Display menu path:

Device setup ► microSD ► (see below)

Unmount	Specifies the removal of the microSD card.*1
---------	----------------------------------------------

*1: From the table below, select whether to remove the microSD card.

Cancel	Cancels the removal of the microSD card.
Execute	Applicable to remove the microSD card in safety.

(2) microSD card format



IMPORTANT

If the format function of this instrument is not used to format the microSD card, it may cause a device operation failure.

Formatting is possible with the following parameters.

Display menu path:

Device setup ► microSD ► (see below)

Format	Specify the format of the microSD card.*1
--------	-------------------------------------------

*1: From the table below, select whether to format the microSD card.

Cancel	Cancels formatting.
Execute	Executes formatting.

4.10 Device Information

4.10.1 Order Information

Order information can be specified for this instrument. If the dedicated parameters are specified at the time of ordering, this instrument is shipped with the parameters configured. Parameters unspecified at the time of ordering must be configured by the user. The model and suffix code are indicated in the following format.

Sensor:

AXW□□□ - □□□□□□□□□□□□□□□□ - □□□□□ /□
 (1) (2) (3)

Transmitter:

AXW□□A - □□□□□□□□□□□□□□□□ /□
 (1) (2) (3)

(1) Model code, (2) Suffix code, (3) Optional code

This setting can be configured with the following parameters.

Display menu path:

Device setup ► Detailed setup ► Device info ► Order info ► (see below)

Tag No	Specify the tag number. HART communication: Max. 8 characters.
Long tag	Specify the long tag. HART communication: Max. 32 characters.
MS code ► Model code	Specify the model code of the integral flowmeter or remote transmitter.
MS code ► Suffix config 1	Specify the suffix code of the integral flowmeter or remote transmitter.
MS code ► Suffix config 2	
MS code ► Option 1	Specify the optional code of the integral flowmeter or remote transmitter.
MS code ► Option 2	
MS code ► Option 3	
MS code ► Option 4	
RS MS code ► Model code	Specify the model code of the remote sensor.
RS MS code ► Suffix config 1	Specify the suffix code of the remote sensor.
RS MS code ► Suffix config 2	
RS MS code ► Option 1	Specify the optional code of the remote sensor.
RS MS code ► Option 2	
RS MS code ► Option 3	
RS MS code ► Option 4	

Device setup ► Detailed setup ► Device info ► Ver/Num info ► (see below)

Trans serial No	Displays the serial number (instrument number) of the transmitter.
Sensor serial No	Displays the serial number (instrument number) of the sensor.

HART communication:

Device root menu ► Detailed setup ► Device information ► Order information ► (see below)

Tag	Specify the tag number. HART communication: Max. 8 characters.
Long tag	Specify the long tag. HART communication: Max. 32 characters.
Basic model code	Specify the model code of the integral flowmeter or remote transmitter.
Suffix config 1	Specify the suffix code of the integral flowmeter or remote transmitter.
Suffix config 2	
Option 1	Specify the optional code of the integral flowmeter or remote transmitter.
Option 2	
Option 3	
Option 4	
Remote sensor basic model code	Specify the model code of the remote sensor.
Remote sensor suffix config 1	Specify the suffix code of the remote sensor.
Remote sensor suffix config 2	
Remote sensor option 1	Specify the optional code of the remote sensor.
Remote sensor option 2	
Remote sensor option 3	
Remote sensor option 4	

Device root menu ► Detailed setup ► Device information ► Version/Number information ► (see below)

Transmitter serial No	Displays the serial number (instrument number) of the transmitter.
Sensor serial No	Displays the serial number (instrument number) of the sensor.



NOTE

Be careful of changing any parameters related to order information defined upon shipment from the manufacturing plant because it cannot be referred.

Recommended to make a backup referring to Section 4.13 for storing the order information defined upon shipment from the manufacturing plant.

4.10.2 Device Revision

The device revision such as software which is used for this instrument can be checked.

This information can be viewed with the following parameters.

Display menu path:

Device setup ► Detailed setup ► Device info ► Ver/Num info ► (see below)

Transmitter type	Displays the type of the transmitter.
Option board ID	Displays the type of the option board.
Main soft rev	Displays the software revision of the main board.
Snsr soft rev	Displays the software revision of the sensor board.
Ind soft rev	Displays the software revision of the display board.
Hardware rev	Displays the hardware revision of the instrument.
Dev id	Displays the ID of the instrument.

HART communication:

Device root menu ► Detailed setup ► Device information ► Version/Number information ► (see below)

Transmitter type	Displays the type of the transmitter.
Option board ID	Displays the type of the option board.
Main board revision	Displays the software revision of the main board.
Sensor board revision	Displays the software revision of the sensor board.
Indicator board revision	Displays the software revision of the display board.
Hardware rev	Displays the hardware revision of the instrument.
Dev id	Displays the ID of the instrument.

4.10.3 Memo Function

Three parameters can be used as a memo function. The memo function can be set to up to 16 characters.

This setting can be configured with the following parameters.

Display menu path:

Device setup ► Detailed setup ► Device info ► Memo ►

Memo 1	Specifies memo 1.
Memo 2	Specifies memo 2.
Memo 3	Specifies memo 3.

HART communication:

Device root menu ► Detailed setup ► Device information ► Memo ► (see below)

Memo 1	Specifies memo 1.
Memo 2	Specifies memo 2.
Memo 3	Specifies memo 3.

4.11 Self-diagnostic Function

4.11.1 Types of Diagnosis Functions

This instrument has the self-diagnostic functions to diagnose a device failure or process status.

Followings are its diagnosis functions.

Alarm high/low limit function	Displays an alarm when the specified value is exceeded, and outputs it as the status output.
Electrode adhesion detection	Diagnoses an electrode adhesion from the resistance value of the electrode, and displays a warning or alarm if an adhesion is detected.
Sensor empty check	Checks whether the sensor is in the empty pipe state, and displays an alarm if the empty pipe state is detected.
Misconnection detection	Checks whether the transmitter signal line and the excitation line are correctly connected, and displays a warning if a misconnection is detected.
Verification (device health diagnosis) function	Diagnoses the health of the instrument, and displays its result.

4.11.2 Alarm High/Low Limit Function

The alarm high/low limit function displays an alarm when the physical quantity PV-mapped in Subsection 4.1.2 exceeds the specified value. This function also outputs an alarm occurrence as the status output.

For details about the status output, read Subsection 4.3.7.

The alarm judgment value can be specified using 4 types of values: high limit value, high-high limit value, low-limit value, and low-low limit value.

This setting can be configured with the following parameters.

Display menu path:

Device setup ► Diag/Service ► H/L alarm cfg ► (see below)

High alarm	Specify the high limit value to judge an alarm.
Low alarm	Specify the low limit value to judge an alarm.
HH alarm	Specify the high-high limit value to judge an alarm.
LL alarm	Specify the low-low limit value to judge an alarm.

HART communication:

Maintenance root menu ►

High/Low alarm configuration ► (see below)

High alarm	Specify the high limit value to judge an alarm.
Low alarm	Specify the low limit value to judge an alarm.
High high alarm	Specify the high-high limit value to judge an alarm.
Low low alarm	Specify the low-low limit value to judge an alarm.

When the high and low limit value alarms are reset, the hysteresis is set for each alarm. Specify the hysteresis width with the percentage (%) for the span of the physical quantity PV-mapped in Subsection 4.1.2. When using the multi range function, specify the hysteresis width with the percentage (%) for the maximum range specified in the multi range parameter. The hysteresis in each case can be specified by the following procedure. For details about the multi range function, read Section 4.6.

Display menu path:

Device setup ► Diag/Service ► H/L alarm cfg ► (see below)

H/L alarm hyst	Specify the hysteresis width for the alarm occurrence and resetting.
----------------	----------------------------------------------------------------------

HART communication:

Maintenance root menu ►

High/Low alarm configuration ► (see below)

Hi/Lo alarm hysteresis	Specify the hysteresis width for the alarm occurrence and resetting.
------------------------	----------------------------------------------------------------------

- (1) Hysteresis value
= Span or max. range x Hysteresis width [%]
- (2) Value that causes a high limit or high-high limit alarm to be reset
= Specified high limit or high-high limit value - Hysteresis value
- (3) Value that causes a low limit or low-low limit alarm to be reset
= Specified low limit or low-low limit value + Hysteresis value

Example:

Span of volumetric flow rate = 300 m³/h,
 High limit value = 250 m³/h, Low limit value = 50 m³/h,
 High-high limit value = 300 m³/h, Low-low limit value = 25 m³/h,
 Hysteresis width = 5 %
 In this case, each value is obtained as shown below.

- (1) Hysteresis value = 300 [m³/h] × 5 [%]
 = 15 [m³/h]
- (2-1) Value that causes a high-high limit alarm to be reset
 = 300 [m³/h] – 15 [m³/h]
 = 285 [m³/h]
- (2-2) Value that causes a high limit alarm to be reset
 = 250 [m³/h] – 15 [m³/h]
 = 235 [m³/h]
- (3-1) Value that causes a low limit alarm to be reset
 = 50 [m³/h] + 15 [m³/h]
 = 65 [m³/h]
- (3-2) Value that causes a low-low limit alarm to be reset
 = 25 [m³/h] + 15 [m³/h]
 = 40 [m³/h]

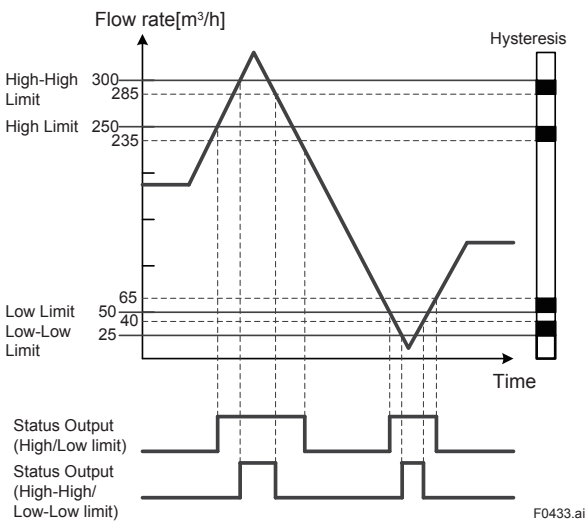

NOTE

When the physical quantity to be output is changed, respecify the alarm judgment value.

4.11.3 Electrode Adhesion Detection

The electrode adhesion detecting function diagnoses an electrode adhesion from the resistance value of the electrode, and displays a warning or alarm if an adhesion is detected. The electrode adhesion detection is displayed on the display in four levels: level 1 to level 4. Each level judgment value can be specified individually. If the level 3 value is exceeded, a warning is displayed. If the level 4 value is exceeded, an alarm is displayed. For details about alarms and warnings, read Subsection 4.8.1.



This setting can be configured with the following parameters.

Display menu path:

Device setup ▶ Diag/Service ▶ Diagnosis ▶ Adhesion ▶ (see below)

Function	Specifies the use of the electrode adhesion detecting function.*1
Threshold level 1	Specify the value to judge level 1.
Threshold level 2	Specify the value to judge level 2.
Threshold level 3	Specify the value to judge level 3.
Threshold level 4	Specify the value to judge level 4.
Result ▶ Value	Displays the resistance value of the electrode.
Result ▶ Status	Displays the electrode adhesion detection level.
Check cycle	Specify the data update cycle for electrode adhesion detection.

HART communication:

Diagnostic rootmenu ▶ Diagnosis ▶ Adhesion ▶ (see below)

Adhesion function	Specifies the use of the electrode adhesion detecting function.*1
Adhesion level 1	Specify the value to judge level 1.
Adhesion level 2	Specify the value to judge level 2.
Adhesion level 3	Specify the value to judge level 3.
Adhesion level 4	Specify the value to judge level 4.
Result ▶ Adhesion value	Displays the resistance value of the electrode.
Result ▶ Adhesion status	Displays the electrode adhesion detection level.
Adhesion check cycle	Specify the data update cycle for electrode adhesion detection.

*1: From the table below, select the use of the electrode adhesion detection function.

Disable	Does not use the electrode adhesion detecting function.
Enable	Uses the electrode adhesion detecting function.



NOTE

If the electrode adhesion detecting function is not used, the electrode resistance value and level are cleared.



NOTE

Before using the electrode adhesion detecting function, always make sure that the sensor is in the full pipe state. If the sensor is in the empty pipe state, this function may not run normally.



NOTE

The electrode adhesion detecting function has the fluid conductivity restricted. The recommended conductivity is as follows.

Meter size	Conductivity
25 to 400 mm (1 to 16 in.)	10 μS/cm or larger
500 mm (20 in.) or more	20 μS/cm or larger



NOTE

As the data update cycle for adhesion detection is shorter, an error of the electrode resistance value increases. Do not change the default value unless especially specified.

4.11.4 Sensor Empty Check

The sensor empty check function checks whether the sensor is in the empty pipe state, and displays an alarm if the empty pipe state is detected. For details about alarms and warnings, read Subsection 4.8.1.

This information can be viewed with the following parameters.

Display menu path:

Device setup ▶ Diag/Service ▶ Diagnosis ▶ (see below)

Empty status	Displays the result of the sensor empty check function.*1
--------------	-----------------------------------------------------------

HART communication:

Diagnostic root menu ▶ Diagnosis ▶ Empty ▶ Result ▶ (see below)

Empty status	Displays the result of the sensor empty check function.*1
--------------	-----------------------------------------------------------

*1: From the table below, check the result of the sensor empty check function.

Full	Indicates that the sensor is in the full pipe state.
Empty	Indicates that the sensor is in the empty pipe state.



IMPORTANT

- If the sensor is in the empty pipe state, output fluctuation or empty check alarm may occur. Be sure to use the magnetic flowmeter being filled with liquid fully.
- The empty check is determined by measuring the resistance between the electrode and the ground. For that reason, the empty pipe state may not be detected due to the piping condition, electrode condition, and environmental noise. In particular, note that the empty check function may not operate properly for high-viscosity fluids and adhesive fluids.
- It takes 10 to 15 minutes to diagnose the empty pipe state. Other process alarms may occur before the empty check alarm occurs after the pipe is in the empty pipe state.

4.11.5 Wiring Connection Diagnosis

The wiring connection diagnostic function performs to diagnose whether the signal line and the excitation line between remote type sensor and transmitter are correctly connected, and displays a warning if a misconnection is detected.

For example, if there are 2 sets of remote type sensors and transmitters, this function performs to check whether the signal line of a transmitter A is misconnected to the signal terminal of a sensor B, or the excitation line of a transmitter A is misconnected to the excitation terminal of a sensor B.

It takes approximately 10 seconds to finish this function.

For details about alarms and warnings, read Subsection 4.8.1.

This setting can be configured with the following parameters.

Display menu path:

Device setup ► Diag/Service ► Diagnosis ► (see below)

Diagnostic execute	Specifies the use of the wiring connection diagnostic function.*1
Diagnostic output	Specifies the output to use the wiring connection diagnostic function.*2

HART communication:

Diagnostic root menu ► Diagnosis ► (see below)

Diagnostic Exe	Specifies the use of the wiring connection diagnostic function.*1
Diagnostic output	Specifies the output to use the wiring connection diagnostic function.*2

*1: From the table below, select the use of the wiring connection diagnostic function.

Display:

Connect check exe	Starts the wiring connection diagnostic function.
-------------------	---------------------------------------------------

BRAIN communication:

Conn Chk exe	Starts the wiring connection diagnostic function.
--------------	---------------------------------------------------

*2: From the table below, select the output required to execute the wiring connection diagnostic function.

	Current output	Totalization	Pulse output	Frequency output
Zero	0% output	Input 0 (Output fixed)	0 pps	0% output
Measured value	Output of calculated value (Undefined)	Totalization of calculated value (Undefined)	Output of calculated value (Undefined)	Output of calculated value (Undefined)
Hold	Fixes the last valid value before the diagnosis starts.	Totalizes the last valid value before the diagnosis starts.	Fixes the last valid value before the diagnosis starts.	Fixes the last valid value before the diagnosis starts.



IMPORTANT

- Before using the wiring connection diagnostic function, be sure to disconnect this instrument from the control loop.
- While this function is used, the current output and pulse output are invalid.



NOTE

When using the wiring connection diagnostic function, the following conditions must be satisfied.

If the conditions are not satisfied, the magnetic flowmeter may not correctly diagnose the wiring connection status.

- The sensor is in the full pipe state.
- No influence of noise.
- The magnetic flowmeter transmitter and AM012 (calibrator) are not connected.

4.11.6 Verification (Device Health Diagnosis) Function

The verification function diagnoses the health of the instrument, and displays the diagnosis result. It takes approximately 15 minutes for the verification function to complete. The progress of the verification function can be monitored via the bar graph and the remaining time on the display.

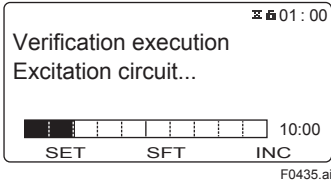

This function can perform to inspect each condition of the circuit, and acts the device health diagnosis of the instrument by detecting its internal alarms history along with its wiring misconnection. And this function evaluates their diagnosis result depending on the condition of the instrument by showing “Passed” as no problem or “Failed” as problems on the display.

The executing results are shown below.

- **“Passed” with no problem (as an example)**

VF check results	Passed
VF Operation time	00001D 10:01
Magnetic circuit result	Passed
Exciting circuit result	Passed
Calculation circuit result	Passed
Device status result	Passed
Connection status result	Passed

- **“Failed” with problems (as an example)**

VF check results	Failed
VF Operation time	00001D 10:01
Magnetic circuit result	Passed
Exciting circuit result	Passed
Calculation circuit result	Failed
Device status result	Passed
Connection status result	Passed

Contact Yokogawa service center when the “Failed” message appears from “Magnetic circuit result” to “Device status result” .

Confirm the wiring misconnection between sensor and transmitter (read Subsection 4.11.5 for detail), or whether its signal cable and excitation cable have no damage when the “Failed” message appears at “Connection status result”.

The verification function can be selected depending on whether or not the fluid is flowing.

The two diagnosis results (current and previous) are stored in the device memory, and they can be checked later.

The following results will be displayed after the verification function is used.

Total judgment result	Calculation circuit diagnosis result
Operating time of verification function	Device alarm diagnosis result
Magnetic circuit diagnosis result	Wiring connection diagnosis result
Excitation circuit diagnosis result	

This setting can be configured with the following parameters.

Display menu path:

Device setup ► Diag/Service ► Diagnosis ► (see below)

Diagnostic output	Specifies the output to execute the verification function.*1
-------------------	--------------------------------------------------------------

Device setup ► Diag/Service ► Verification ► (see below)

Mode	Specifies the fluid status to execute the verification function.*2
Execute	Specifies the execution of the verification function.*3
VF No	Specify the diagnosis result display time.*4
Result	Displays the diagnosis result.*5

HART communication:

Maintenance root menu ► Verification ► (see below)

Diagnostic output	Specifies the output to use the verification function.*1
VF mode	Specifies the fluid status to use the verification function.*2
Verification Exe	Specifies the use of the verification function.*3
VF No	Specify the diagnosis result display time.*4
Result	Displays the diagnosis result.*5

*1: From the table below, select the output to execute the verification function.

	Current output	Totalization	Pulse output	Frequency output
Zero	0% output	Input 0 (Output fixed)	0 pps	0% output
Measured value	Output of calculated value (Undefined)	Totalization of calculated value (Undefined)	Output of calculated value (Undefined)	Output of calculated value (Undefined)
Hold	Fixes the last valid value before the diagnosis starts.	Totalizes the last valid value before the diagnosis starts.	Fixes the last valid value before the diagnosis starts.	Fixes the last valid value before the diagnosis starts.

*2: From the table below, select the fluid status required to execute the verification function.

No flow	Executes the verification function with the fluid not flowing.
Flow	Executes the verification function with the fluid flowing.

*3: From the table below, select whether to execute the verification function.

Not execute	Does not execute the verification function.
Execute	Executes the verification function.

*4: From the table below, select the execution result of the verification function.

Factory	Displays the result obtained upon shipment from the manufacturing plant.
Previous	Displays the previous result.
Present	Displays the result at this time.

*5: The diagnosis result is displayed as shown below.

Display menu path:

Device setup ► Diag/Service ► Result ► (see below)

Failed/Passed	Execution result
VF operate time	Operating time of verification function when started
Magnetic circuit	Magnetic circuit diagnosis result
Excite circuit	Excitation circuit diagnosis result
Calc circuit	Calculation circuit diagnosis result
Device status	Device alarm diagnosis result
Connect status	Wiring misconnection check result

HART communication:

Maintenance root menu ► Verification ► (see below)

VF check result	Execution result
VF operation time	Operating time of verification function when started
Magnetic circuit result	Magnetic circuit diagnosis result
Excitation circuit result	Excitation circuit diagnosis result
Calculation circuit result	Calculation circuit diagnosis result
VF device status result	Device alarm diagnosis result
Connection status result	Wiring misconnection check result

The diagnosis result is judged as shown below.

Passed	There are no problems concerning the diagnosis result.
Failed	There is a problem concerning the diagnosis result.
Canceled	Cancel the diagnosis.
No Data	No diagnosis result data (The verification function is not used.)
Unknown	Cannot perform a diagnosis.



IMPORTANT

- Before using the verification function, be sure to disconnect this instrument from the control loop.
- While this function is used, the current output and pulse output are invalid.
- Note that parameters cannot be changed when the verification function is executed.



NOTE

- Before using the verification function, always make sure that the sensor is in the full pipe state. If the sensor is in the empty pipe state, this function may not run normally.
- When using the verification function, correctly specify the fluid status with the parameter.
- If there is a problem with the verification result, read the maintenance manual as listed in Table 1.1.

4.12 Test Mode

4.12.1 Test Mode Setting

The test mode can be executed to arbitrarily specify the process value or the value to be output from a connection terminal and test a response from the device.

However, a warning is displayed to indicate that the test mode is in use while this test mode is used.

The use of the test mode can be specified with the following parameters.

Display menu path:

Device setup ► Diag/Service ► Test ► (see below)

Input test ► Test mode	Specifies the use of the test mode (input).*1
Output test ► Test mode	Specifies the use of the test mode (output).*1

HART communication:

Maintenance root menu ► Test ► (see below)

Test mode	Specifies the use of the test mode (input/output).*1
-----------	------------------------------------------------------

*1: From the table below, select the test terminal and process value.

Display:

Velocity	Starts testing the flow velocity.
Volume	Starts testing the volumetric flow rate.
Mass	Starts testing the mass flow rate.
SI3	Starts testing the current input of the I/O3 terminal.
AO1	Starts testing current output 1 of the I/O1 terminal.
PO1	Starts testing pulse output or frequency output 1 of the I/O2 terminal.
PO2	Starts testing pulse output or frequency output 2 of the I/O4 terminal.
SO1	Starts testing status output 1 of the I/O2 terminal.
SO2	Starts testing current output 2 of the I/O4 terminal.

HART communication:

Velocity test on	Starts testing the flow velocity.
Volume flow test on	Starts testing the volumetric flow rate.
Mass flow test on	Starts testing the mass flow rate.
SI3 test on	Starts testing the current input of the I/O3 terminal.
AO1 test on	Starts testing current output 1 of the I/O1 terminal.
Pulse1 test on	Starts testing pulse output or frequency output 1 of the I/O2 terminal.
Pulse2 test on	Starts testing pulse output or frequency output 2 of the I/O4 terminal.
SO1 test on	Starts testing status output 1 of the I/O2 terminal.
SO2 test on	Starts testing current output 2 of the I/O4 terminal.

The value on the test mode is executed by turns of Flow velocity, Volumetric flow rate, and Mass flow rate. For example, the test values of Mass flow rate is decided based on the test value of the volumetric flow rate, when the volumetric flow rate is set as the test value. In this case, the test value of flow velocity is executed with the normal measurement value.



NOTE

To specify each terminal output, read Subsection 4.3.1. If the specified output is different from the test starting output, the test mode cannot be used.

For example, if the I/O2 terminal is assigned to the frequency output to start the status output test, the test cannot be started.

4.12.2 Test Terminal and Value Setting

Specify the test input value for the terminal and process value to be tested.

This setting can be configured with the following parameters.

However, the unit of the process value to be tested conforms to that specified in Subsection 4.1.4. If the unit is changed, the process value to be tested is also changed synchronously with the changed unit.

Display menu path:

Device setup ► Diag/Service ► Test ► (see below)

Input test ► Velocity	Specify the flow velocity.
Input test ► Volume	Specify the volumetric flow rate.
Input test ► Mass	Specify the mass flow rate.
Input test ► SI3	Specify the status of the status input for the I/O3 terminal.
Output test ► AO1	Specify the current value of current output 1 for the I/O1 terminal.
Output test ► PO1	Specify the frequency of pulse output or frequency output 1 for the I/O2 terminal.
Output test ► PO2	Specify the frequency of pulse output or frequency output 2 for the I/O4 terminal.
Output test ► SO1	Specify the status of status output 1 for the I/O2 terminal.
Output test ► SO2	Specify the status of status output 2 of the I/O4 terminal.

HART communication:

Maintenance root menu ► Test► (see below)

Input test ► Velocity	Specify the flow velocity.
Input test ► Volume flow	Specify the volumetric flow rate.
Input test ► Mass flow	Specify the mass flow rate.
Input test ► SI3	Specify the status of the status input for the I/O3 terminal.
Output test ► AO1	Specify the current value of current output 1 for the I/O1 terminal.
Output test ► Pulse1	Specify the frequency of pulse output or frequency output 1 for the I/O2 terminal.
Output test ► Pulse2	Specify the frequency of pulse output or frequency output 2 for the I/O4 terminal.
Output test ► SO1	Specify the status of status output 1 for the I/O2 terminal.
Output test ► SO2	Specify the status of status output 2 of the I/O4 terminal.

4.12.3 Test Mode Auto Reset

If the specified time lapses with no parameters changed while the test mode is enabled, the test mode is reset automatically. When any test mode parameter is changed, the test mode reset time is extended.

This setting can be configured with the following parameters.

Display menu path:

Device setup ► Diag/Service ► Test ► (see below)

Release time	Specify the time to automatically reset the test mode.*1
--------------	----------------------------------------------------------

HART communication:

Maintenance root menu ► Test► (see below)

Release time	Specify the time to automatically reset the test mode.*1
--------------	----------------------------------------------------------

*1: From the table below, select the test mode auto reset time.

10 min	Sets the reset time to 10 min.
30 min	Sets the reset time to 30 min.
1 h	Sets the reset time to 1 hour.
3 h	Sets the reset time to 3 hours.
12 h	Sets the reset time to 12 hours.

4.13 Event Management Function

4.13.1 Backup Function

The backup function enables to back up parameter settings in the display built-in memory or microSD card (with the optional code MC selected).

Restoring backup data can be used to duplicate parameter settings to another device. The display built-in memory can store backup data for three times and the microSD depends on available free space. There are three backup methods available: backup from the main board of this instrument to the memory on the display board, backup from the main board of the instrument to the microSD card, and backup from the memory on the display board to the microSD card. The file name, backup name, and date can be specified to use the backup function.

The data backed up in the microSD card is stored in the “YOKOGAWA” folder as a “.PAR” file.

The backup function can be configured with the following parameters.

For details about the backup parameters, read Subsection 4.13.3.

Display menu path:

Device setup ► Diag/Service ► Param bkup/restore ► (see below)

F backup name	Displays the backup name defined upon shipment from the manufacturing plant.
F backup date	Displays the backup date upon shipment from the manufacturing plant.
SD backup name	Specify the name of the file to be backed up to the microSD card.
Backup name 1	Specify backup name 1. Up to 16 characters
Backup date 1	Specify date 1.
Backup name 2	Specify backup name 2. Up to 16 characters
Backup date 2	Specify date 2.
Backup name 3	Specify backup name 3. Up to 16 characters
Backup date 3	Specify date 3.
Backup execute	Specifies the use of the backup function.*1

HART communication:

Maintenance root menu ►

Param bkup/restore► (see below)

Factory backup name	Displays the backup name defined upon shipment from the manufacturing plant.
Factory backup date	Displays the backup date upon shipment from the manufacturing plant.
SD backup name	Specify the name of the file to be backed up to the microSD card.
Backup name 1	Specify backup name 1. Up to 16 characters
Backup date 1	Specify date 1.
Backup name 2	Specify backup name 2. Up to 16 characters
Backup date 2	Specify date 2.
Backup name 3	Specify backup name 3. Up to 16 characters
Backup date 3	Specify date 3.
Backup Exe	Specifies the use of the backup function.*1

*1: From the table below, select how the backup function is to be used.

Not Execute	Does not execute the backup function.
Store Main to 1	Backs up parameter settings from the main board to memory 1 in the display built-in memory.
Store Main to 2	Backs up parameter settings from the main board to memory 2 in the display built-in memory.
Store Main to 3	Backs up parameter settings from the main board to memory 3 in the display built-in memory.
Store Main to SD	Backs up parameter settings from the main board to the microSD card.
Store EEP1 to SD	Backs up parameter settings from memory 1 in the display built-in memory to the microSD card.
Store EEP2 to SD	Backs up parameter settings from memory 2 in the display built-in memory to the microSD card.
Store EEP3 to SD	Backs up parameter settings from memory 3 in the display built-in memory to the microSD card.

There are some parameters which are not able to back up depending on the occurrence of the alarm. The table below shows the parameters that can be backed up when an alarm occurs.

○: Executable when alarm occurs.

—: Not executable when alarm occurs.

Alarm name			Backup
Display	HART communication		
010:Main CPU FAIL	10	Main board CPU failure	—
011:Rev calc FAIL	11	Reverse calculation failure	—
012:Main EEP FAIL	12	Main board EEPROM failure	—
013:Main EEP dfilt	13	Main board EEPROM default	—
014:Snsr bd FAIL	14	Sensor board failure	○
015:Snsr comm ERR	15	Sensor communication error	○
016:AD 1 FAIL[Sig]	16	A/D1 failure[Signal]	○
017:AD 2 FAIL[Excit]	17	A/D2 failure[Exciter]	○
018:Coil open	18	Coil open	○
019:Coil short	19	Coil short	○
020:Exciter FAIL	20	Exciter failure	○
021:PWM 1 stop	21	PWM1 stop	—
022:PWM 2 stop	22	PWM2 stop	—
023:Opt bd mismatch	23	Option board mismatch	—
024:Opt bd EEP FAIL	24	Option board EEPROM failure	—

Alarm name			Backup
Display	HART communication		
025:Opt bd A/D FAIL	25	Option board A/D failure	—
026:Opt bd SPI FAIL	26	Option board SPI failure	—
027:Restore FAIL	27	Parameter restore incomplete	○
028:Ind bd FAIL	28	Indicator board failure	—
029:Ind bd EEP FAIL	29	Indicator board EEPROM failure	—
030:LCD drv FAIL	30	LCD driver failure	—
031:Ind bd mismatch	31	Indicator board mismatch	—
032:Ind comm ERR	32	Indicator communication error	—
033:microSD FAIL	33	microSD failure	—
050:Signal overflow	50	Signal overflow	○
051:Empty detect	51	Empty pipe detection	○
052:H/L HH/LL alm	52	H/L or HH/LL alarm	○
053:Adh over lv 4	53	Adhesion over level 4	○
060:Span cfg ERR	60	Span configuration error	—
062:AO 1 4-20 lmt	62	Analog output 1 4-20 mA limit error	—
064:AO 1 mlt rng	64	Analog output 1 multi range error	—
065:H/L cfg ERR	65	H/L HH/LL configuration error	—
066:Density cfg ERR	66	Density configuration error	—
067:Pls 1 cfg ERR	67	Pulse output 1 configuration error	—
068:Pls 2 cfg ERR	68	Pulse output 2 configuration error	—
069:Nomi size cfg	69	Nominal size configuration error	—
070:Adh cfg ERR	70	Adhesion configuration error	—
072:Log not start	72	Data logging not started	—
080:AO 1 saturate	80	Analog output 1 saturated	○
082:Pls 1 saturate	82	Pulse output 1 saturated	○
083:Pls 2 saturate	83	Pulse output 2 saturated	○
085:Cable miscon	85	Cable misconnect	○
086:Coil insulation	86	Coil insulation warning	○
087:Adhesion lv 3	87	Adhesion over level 3	○
092:AZ warn	92	Autozero warning	○
093:Verif warn	93	Verification warning	○
095:Simulate active	95	Simulation active	○
096:AO 1 fix	96	Analog output 1 fixed	○
098:Pls 1 fix	98	Pulse output 1 fixed	○
099:Pls 2 fix	99	Pulse output 2 fixed	○
101:Param restore run	101	Parameter restore running	—
102:Disp over	102	Display over warning	—
103:SD size warn	103	microSD card size warning	—
104:Bkup incmplt	104	Parameter backup incomplete	○
105:SD mismatch	105	microSD card mismatch	—
106:SD removal ERR	106	microSD card removal procedure error	—
131:Trans mismatch	131	Transmitter type mismatch	—
120:Watchdog	120	Watchdog	○
121:Power off	121	Power off	○
122:Inst power FAIL	122	Instant power failure	○
123:Param bkup run	123	Parameter backup running	—
124:Data log run	124	Data logging running	○
130:DevID not enter	130	Device ID not entered	○



IMPORTANT

- Note that parameters cannot be changed when the backup function is executed. It takes approximately 20 seconds to complete backup processing.
- Take care not to duplicate the file name when backing up data to the microSD card.
- Note that, if the microSD card runs out of free space, the subsequent data will not be stored.



NOTE

The backup name and date do not affect the backup function. Use this as the memo column when performing the backup function.

4.13.2 Restore / Duplicate Function

The restore function can be restore parameter settings, which are backed up in the display built-in memory or microSD card (with the optional code MC selected), to the instrument. In addition, this function enables to return parameters to the default values defined upon shipment from the manufacturing plant. Also, it is possible to duplicate the backed-up parameters to other device based on the same specifications.



IMPORTANT

- For the remote type, it is necessary to set the device information of the remote sensor to the parameters of the remote transmitter.
- Before using the restore function, be sure to remove this product from piping line or stop the line.
- After executing the restore function, check that backup data is set for the target parameter.

The restore method can be selected from the following four types.

Duplicate Data	Restores the target parameter (excluding the service parameters related to the transmitter adjustment) from the instrument in which the parameter is backed up. Restore is also executable for other instrument.
Restore Data	Restores the target parameter (including the service parameters related to the transmitter adjustment) from the instrument in which the parameter is backed up. Restore is not executable for other instrument.
Compulsion Data	Restores the target parameter (specified upon shipment from the manufacturing plant) from the instrument in which the parameter is backed up. Restore is also executable for other instrument.
Restore Factory	Restores all the parameters (specified upon shipment from the manufacturing plant).

When using the restore function, always make sure that the backed-up device information matches the device information to be restored.

The table below shows the consistency of device information.

M:Items to be Matched.

Device Information	Duplicate Data	Restore Data	Compulsion Data
Option Board ID	M	M	
Transmitter Serial No		M	
Sensor Serial No		M	
Main Board Software Rev.	M	M	
Sensor Board Software Rev.	M	M	
Display Board Software Rev.	M	M	
Model (Note)	M	M	
Communication and I/O Code	M	M	

Note: Only between AXW type and AXW type can be duplicated or restored the data.

The restore function can be configured with the following parameters.

For details about the restorable parameters, read Subsection 4.13.3.

Display menu path:

Device setup ► Diag/Service ►

Param bkup/restore ► (see below)

Restore execute	Specifies the execution of the restore function.*1
Restore result	Displays the restore result.*2

HART communication:

Maintenance root menu ►

Param bkup/restore► (see below)

Restore Exe	Specifies the execution of the restore function.*1 Displays the restore result after execution of the restore function.*2
-------------	------------------------------------------------------------------------------------------------------------------------------

*1: From the table below, select the execution of the restore function.

Not execute	Does not restore data.
Duplicate Data1	Restores the parameter (Duplicate Data) setting from memory 1 on the display board to the main board of the instrument.
Duplicate Data2	Restores the parameter (Duplicate Data) setting from memory 2 on the display board to the main board of the instrument.
Duplicate Data3	Restores the parameter (Duplicate Data) setting from memory 3 on the display board to the main board of the instrument.
Duplicate SD	Restores the parameter (Duplicate Data) setting from the microSD card to the main board of the instrument.
Restore Data1	Restores the parameter (Restore Data) setting from memory 1 on the display board to the main board of the instrument.
Restore Data2	Restores the parameter (Restore Data) setting from memory 2 on the display board to the main board of the instrument.
Restore Data3	Restores the parameter (Restore Data) setting from memory 3 on the display board to the main board of the instrument.
Restore SD	Restores the parameter (Restore Data) setting from the microSD card to the main board of the instrument.
Compulsion Data1	Restores the parameter (Compulsion Data) setting from memory 1 on the display board to the main board of the instrument.
Compulsion Data2	Restores the parameter (Compulsion Data) setting from memory 2 on the display board to the main board of the instrument.
Compulsion Data3	Restores the parameter (Compulsion Data) setting from memory 3 on the display board to the main board of the instrument.
Compulsion SD	Restores the parameter (Compulsion Data) setting from the microSD card to the main board of the instrument.
Restore Factory	Restores to the status that is set upon shipment from the manufacturing plant.

*2: The result of the restore function is displayed as shown below.

Unexecuted	Does not restore data.
Success	Succeeded in restoration.
Failure	Failed in restoration.
Running	Parameter restore running

There are some parameters which are not able to back up depending on the occurrence of the alarm. The table below shows the parameters that can be backed up when an alarm occurs.

○: Executable when alarm occurs.
—: Not executable when alarm occurs.

Alarm name			
Display		HART communication	Restore
010:Main CPU FAIL	10	Main board CPU failure	—
011:Rev calc FAIL	11	Reverse calculation failure	—
012:Main EEP FAIL	12	Main board EEPROM failure	—
013:Main EEP dfit	13	Main board EEPROM default	—
014:Snsr bd FAIL	14	Sensor board failure	○
015:Snsr comm ERR	15	Sensor communication error	○
016:AD 1 FAIL[Sig]	16	A/D1 failure[Signal]	○
017:AD 2 FAIL[Excit]	17	A/D2 failure[Exciter]	○
018:Coil open	18	Coil open	○
019:Coil short	19	Coil short	○
020:Exciter FAIL	20	Exciter failure	○
021:PWM 1 stop	21	PWM1 stop	—
022:PWM 2 stop	22	PWM2 stop	—
023:Opt bd mismatch	23	Option board mismatch	—
024:Opt bd EEP FAIL	24	Option board EEPROM failure	—
025:Opt bd A/D FAIL	25	Option board A/D failure	—
026:Opt bd SPI FAIL	26	Option board SPI failure	—
027:Restore FAIL	27	Parameter restore incomplete	○
028:Ind bd FAIL	28	Indicator board failure	—
029:Ind bd EEP FAIL	29	Indicator board EEPROM failure	—
030:LCD drv FAIL	30	LCD driver failure	—
031:Ind bd mismatch	31	Indicator board mismatch	—
032:Ind comm ERR	32	Indicator communication error	—
033:microSD FAIL	33	microSD failure	—
050:Signal overflow	50	Signal overflow	○
051:Empty detect	51	Empty pipe detection	○
052:H/L HH/LL alm	52	H/L or HH/LL alarm	○
053:Adh over lv 4	53	Adhesion over level 4	○
060:Span cfg ERR	60	Span configuration error	—
062:AO 1 4-20 lmt	62	Analog output 1 4-20 mA limit error	—
064:AO 1 mlt rng	64	Analog output 1 multi range error	—
065:H/L cfg ERR	65	H/L HH/LL configuration error	—
066:Density cfg ERR	66	Density configuration error	—
067:Pls 1 cfg ERR	67	Pulse output 1 configuration error	—
068:Pls 2 cfg ERR	68	Pulse output 2 configuration error	—
069:Nomi size cfg	69	Nominal size configuration error	—
070:Adh cfg ERR	70	Adhesion configuration error	—
072:Log not start	72	Data logging not started	—
080:AO 1 saturate	80	Analog output 1 saturated	○
082:Pls 1 saturate	82	Pulse output 1 saturated	○
083:Pls 2 saturate	83	Pulse output 2 saturated	○
085:Cable miscon	85	Cable misconnect	○
086:Coil insulation	86	Coil insulation warning	○
087:Adhesion lv 3	87	Adhesion over level 3	○
092:AZ warn	92	Autozero warning	○
093:Verif warn	93	Verification warning	○
095:Simulate active	95	Simulation active	○
096:AO 1 fix	96	Analog output 1 fixed	○
098:Pls 1 fix	98	Pulse output 1 fixed	○
099:Pls 2 fix	99	Pulse output 2 fixed	○
101:Param restore run	101	Parameter restore running	—

Alarm name			Restore
Display		HART communication	
102:Disp over	102	Display over warning	—
103:SD size warn	103	microSD card size warning	—
104:Bkup incmplt	104	Parameter backup incomplete	○
105:SD mismatch	105	microSD card mismatch	—
106:SD removal ERR	106	microSD card removal procedure error	—
131:Trans mismatch	131	Transmitter type mismatch	—
120:Watchdog	120	Watchdog	○
121:Power off	121	Power off	○
122:Inst power FAIL	122	Instant power failure	○
123:Param bkup run	123	Parameter backup running	—
124:Data log run	124	Data logging running	○
130:DevID not enter	130	Device ID not entered	○



IMPORTANT

When using the restore function, be sure to prepare the backup file in memory or a microSD card. Note that the restore function is not executable if the backup file is not provided.

4.13.3 Backup and Restore Parameters

The list below shows the parameters that can be backed up or restored.

Alarm name		Backup	Restore			
HART communication	Display		Duplicate Data	Restore Data	Compulsion Data	Restore Factory
Device root menu ▶ Detailed setup ▶ Process variables ▶ Velocity ▶ Velocity damping AO/frequency	Device setup ▶ Detailed setup ▶ Pro var ▶ Velocity ▶ Damp AO/F	○	○	○	—	○
Device root menu ▶ Detailed setup ▶ Process variables ▶ Velocity ▶ Velocity damping pulse/total	Device setup ▶ Detailed setup ▶ Pro var ▶ Velocity ▶ Damp pls/ttl	○	○	○	—	○
Device root menu ▶ Detailed setup ▶ Process variables ▶ Volume flow ▶ Volume flow damping AO/frequency	Device setup ▶ Detailed setup ▶ Pro var ▶ Volume ▶ Damp AO/F	○	○	○	—	○
Device root menu ▶ Detailed setup ▶ Process variables ▶ Volume flow ▶ Volume flow damping pulse/total	Device setup ▶ Detailed setup ▶ Pro var ▶ Volume ▶ Damp pls/ttl	○	○	○	—	○
Device root menu ▶ Detailed setup ▶ Process variables ▶ Mass flow ▶ Mass flow damping AO/frequency	Device setup ▶ Detailed setup ▶ Pro var ▶ Mass ▶ Damp AO/F	○	○	○	—	○
Device root menu ▶ Detailed setup ▶ Process variables ▶ Mass flow ▶ Mass flow damping pulse/total	Device setup ▶ Detailed setup ▶ Pro var ▶ Mass ▶ Damp pls/ttl	○	○	○	—	○
Device root menu ▶ Detailed setup ▶ Sensor ▶ Low MF	Device setup ▶ Detailed setup ▶ Sensor ▶ Low MF	○	○	○	○	○
Device root menu ▶ Detailed setup ▶ Sensor ▶ High MF	Device setup ▶ Detailed setup ▶ Sensor ▶ High MF	○	○	○	○	○
Device root menu ▶ Detailed setup ▶ Sensor ▶ Flow sensor select	Device setup ▶ Detailed setup ▶ Sensor ▶ Flow sensor sel	○	○	○	—	○
Device root menu ▶ Detailed setup ▶ Sensor ▶ Nominal size unit	Device setup ▶ Detailed setup ▶ Sensor ▶ Nominal size unit	○	○	○	○	○
Device root menu ▶ Detailed setup ▶ Sensor ▶ Nominal size	Device setup ▶ Detailed setup ▶ Sensor ▶ Nominal size	○	○	○	○	○
Device root menu ▶ Detailed setup ▶ Process variables ▶ PV flow select	Device setup ▶ Detailed setup ▶ Pro var ▶ PV flow select	○	○	○	○	○
Device root menu ▶ Detailed setup ▶ Process variables ▶ Velocity ▶ Velocity unit	Device setup ▶ Detailed setup ▶ Pro var ▶ Velocity ▶ Unit	○	—	—	○	○
Device root menu ▶ Detailed setup ▶ Process variables ▶ Volume flow ▶ Volume flow unit	Device setup ▶ Detailed setup ▶ Pro var ▶ Volume ▶ Unit	○	—	—	○	○
Device root menu ▶ Detailed setup ▶ Process variables ▶ Mass flow ▶ Mass flow unit	Device setup ▶ Detailed setup ▶ Pro var ▶ Mass ▶ Unit	○	—	—	○	○

Alarm name		Backup	Restore			
HART communication	Display		Duplicate Data	Restore Data	Compulsion Data	Restore Factory
Device root menu ▶ Detailed setup ▶ Process variables ▶ Volume flow ▶ Time unit or Device root menu ▶ Detailed setup ▶ Process variables ▶ Mass flow ▶ Time unit	Device setup ▶ Detailed setup ▶ Pro var ▶ Volume ▶ Time unit or Device setup ▶ Detailed setup ▶ Pro var ▶ Mass ▶ Time unit	○	—	—	○	○
Device root menu ▶ Detailed setup ▶ Process variables ▶ Velocity ▶ Velocity span	Device setup ▶ Detailed setup ▶ Pro var ▶ Velocity ▶ Span	○	○	○	○	○
Device root menu ▶ Detailed setup ▶ Process variables ▶ Volume flow ▶ Volume flow span	Device setup ▶ Detailed setup ▶ Pro var ▶ Volume ▶ Span	○	○	○	○	○
Device root menu ▶ Detailed setup ▶ Process variables ▶ Mass flow ▶ Mass flow span	Device setup ▶ Detailed setup ▶ Pro var ▶ Mass ▶ Span	○	○	○	○	○
Maintenance root menu ▶ Autozero ▶ Result ▶ Zero value	Device setup ▶ Diag/Service ▶ Autozero ▶ Result ▶ Zero value	○	○	○	—	○
Device root menu ▶ Detailed setup ▶ Totalizer ▶ Totalizer1 ▶ Total1 conv factor	Device setup ▶ Detailed setup ▶ Totalizer ▶ Totalizer 1 ▶ Conv factor	○	—	—	○	○
Device root menu ▶ Detailed setup ▶ Totalizer ▶ Totalizer1 ▶ Total1 low cut	Device setup ▶ Detailed setup ▶ Totalizer ▶ Totalizer 1 ▶ Low cut	○	○	○	—	○
Device root menu ▶ Detailed setup ▶ Totalizer ▶ Totalizer1 ▶ Total1 fail opts	Device setup ▶ Detailed setup ▶ Totalizer ▶ Totalizer 1 ▶ Failure opts	○	○	○	—	○
Device root menu ▶ Detailed setup ▶ Totalizer ▶ Totalizer1 ▶ Total1 options	Device setup ▶ Detailed setup ▶ Totalizer ▶ Totalizer 1 ▶ Options	○	○	○	—	○
Device root menu ▶ Detailed setup ▶ Totalizer ▶ Totalizer1 ▶ Total1 Start/Stop	Device setup ▶ Detailed setup ▶ Totalizer ▶ Totalizer 1 ▶ Start/Stop	○	○	○	—	○
Device root menu ▶ Detailed setup ▶ Totalizer ▶ Totalizer1 ▶ Total1 Reset/Preset	Device setup ▶ Detailed setup ▶ Totalizer ▶ Totalizer 1 ▶ Reset/Preset	○	○	○	—	○
Device root menu ▶ Detailed setup ▶ Totalizer ▶ Totalizer1 ▶ Total1 preset value	Device setup ▶ Detailed setup ▶ Totalizer ▶ Totalizer 1 ▶ Preset value	○	○	○	—	○
Device root menu ▶ Detailed setup ▶ Totalizer ▶ Totalizer1 ▶ Total1 set point	Device setup ▶ Detailed setup ▶ Totalizer ▶ Totalizer 1 ▶ Set point	○	○	○	—	○
Device root menu ▶ Detailed setup ▶ Totalizer ▶ Totalizer2 ▶ Total2 low cut	Device setup ▶ Detailed setup ▶ Totalizer ▶ Totalizer 2 ▶ Low cut	○	○	○	—	○
Device root menu ▶ Detailed setup ▶ Totalizer ▶ Totalizer2 ▶ Total2 fail opts	Device setup ▶ Detailed setup ▶ Totalizer ▶ Totalizer 2 ▶ Failure opts	○	○	○	—	○
Device root menu ▶ Detailed setup ▶ Totalizer ▶ Totalizer2 ▶ Total2 options	Device setup ▶ Detailed setup ▶ Totalizer ▶ Totalizer 2 ▶ Options	○	○	○	—	○
Device root menu ▶ Detailed setup ▶ Totalizer ▶ Totalizer2 ▶ Total2 Start/Stop	Device setup ▶ Detailed setup ▶ Totalizer ▶ Totalizer 2 ▶ Start/Stop	○	○	○	—	○
Device root menu ▶ Detailed setup ▶ Totalizer ▶ Totalizer2 ▶ Total2 Reset/Preset	Device setup ▶ Detailed setup ▶ Totalizer ▶ Totalizer 2 ▶ Reset/Preset	○	○	○	—	○
Device root menu ▶ Detailed setup ▶ Totalizer ▶ Totalizer2 ▶ Total2 preset value	Device setup ▶ Detailed setup ▶ Totalizer ▶ Totalizer 2 ▶ Preset value	○	○	○	—	○

Alarm name		Backup	Restore			
HART communication	Display		Duplicate Data	Restore Data	Compulsion Data	Restore Factory
Device root menu ▶ Detailed setup ▶ Totalizer ▶ Totalizer2 ▶ Total2 set point	Device setup ▶ Detailed setup ▶ Totalizer ▶ Totalizer 2 ▶ Set point	○	○	○	—	○
Device root menu ▶ Detailed setup ▶ Totalizer ▶ Totalizer3 ▶ Total3 low cut	Device setup ▶ Detailed setup ▶ Totalizer ▶ Totalizer 3 ▶ Low cut	○	○	○	—	○
Device root menu ▶ Detailed setup ▶ Totalizer ▶ Totalizer3 ▶ Total3 fail opts	Device setup ▶ Detailed setup ▶ Totalizer ▶ Totalizer 3 ▶ Failure opts	○	○	○	—	○
Device root menu ▶ Detailed setup ▶ Totalizer ▶ Totalizer3 ▶ Total3 options	Device setup ▶ Detailed setup ▶ Totalizer ▶ Totalizer 3 ▶ Options	○	○	○	—	○
Device root menu ▶ Detailed setup ▶ Totalizer ▶ Totalizer3 ▶ Total3 Start/Stop	Device setup ▶ Detailed setup ▶ Totalizer ▶ Totalizer 3 ▶ Start/Stop	○	○	○	—	○
Device root menu ▶ Detailed setup ▶ Totalizer ▶ Totalizer3 ▶ Total3 Reset/Preset	Device setup ▶ Detailed setup ▶ Totalizer ▶ Totalizer 3 ▶ Reset/Preset	○	○	○	—	○
Device root menu ▶ Detailed setup ▶ Totalizer ▶ Totalizer3 ▶ Total3 preset value	Device setup ▶ Detailed setup ▶ Totalizer ▶ Totalizer 3 ▶ Preset value	○	○	○	—	○
Device root menu ▶ Detailed setup ▶ Totalizer ▶ Totalizer3 ▶ Total3 set point	Device setup ▶ Detailed setup ▶ Totalizer ▶ Totalizer 3 ▶ Set point	○	○	○	—	○
Device root menu ▶ Detailed setup ▶ Pulse/Status ▶ Pulse/Status output 1 ▶ Pulse1 output mode	Device setup ▶ Detailed setup ▶ Pulse/Status out ▶ PO1/SO1 ▶ Output mode	○	○	○	○	○
Device root menu ▶ Detailed setup ▶ Pulse/Status ▶ Pulse/Status output 1 ▶ Pulse1 active mode	Device setup ▶ Detailed setup ▶ Pulse/Status out ▶ PO1/SO1 ▶ Active mode	○	○	○	—	○
Device root menu ▶ Detailed setup ▶ Pulse/Status ▶ Pulse/Status output 1 ▶ Pulse1 fix width	Device setup ▶ Detailed setup ▶ Pulse/Status out ▶ PO1/SO1 ▶ Fix width	○	○	○	—	○
Device root menu ▶ Detailed setup ▶ Pulse/Status ▶ Pulse/Status output 1 ▶ Pulse1 rate unit	Device setup ▶ Detailed setup ▶ Pulse/Status out ▶ PO1/SO1 ▶ Rate unit	○	—	—	○	○
Device root menu ▶ Detailed setup ▶ Pulse/Status ▶ Pulse/Status output 1 ▶ Pulse1 rate value	Device setup ▶ Detailed setup ▶ Pulse/Status out ▶ PO1/SO1 ▶ Rate value	○	○	○	○	○
Device root menu ▶ Detailed setup ▶ Pulse/Status ▶ Pulse/Status output 1 ▶ Pulse1 low cut	Device setup ▶ Detailed setup ▶ Pulse/Status out ▶ PO1/SO1 ▶ Low cut	○	○	○	—	○
Device root menu ▶ Detailed setup ▶ Pulse/Status ▶ Pulse/Status output 1 ▶ Pulse1 alarm out	Device setup ▶ Detailed setup ▶ Pulse/Status out ▶ PO1/SO1 ▶ Alarm out	○	○	○	—	○
Device root menu ▶ Detailed setup ▶ Pulse/Status ▶ Pulse/Status output 1 ▶ Frequency1 at 0%	Device setup ▶ Detailed setup ▶ Pulse/Status out ▶ PO1/SO1 ▶ Frequency at 0%	○	○	○	○	○
Device root menu ▶ Detailed setup ▶ Pulse/Status ▶ Pulse/Status output 1 ▶ Frequency1 at 100%	Device setup ▶ Detailed setup ▶ Pulse/Status out ▶ PO1/SO1 ▶ Frequency at 100%	○	○	○	○	○
Device root menu ▶ Detailed setup ▶ Pulse/Status ▶ Pulse/Status output 1 ▶ Status output1 function	Device setup ▶ Detailed setup ▶ Pulse/Status out ▶ PO1/SO1 ▶ SO1 function	○	○	○	—	○

Alarm name		Backup	Restore			
HART communication	Display		Duplicate Data	Restore Data	Compulsion Data	Restore Factory
Device root menu ▶ Detailed setup ▶ Pulse/Status ▶ Pulse/Status output 2 ▶ Pulse2 active pulse	Device setup ▶ Detailed setup ▶ Pulse/Status out ▶ PO2/SO2 ▶ Active pulse	○	○	○	—	○
Device root menu ▶ Detailed setup ▶ Pulse/Status ▶ Pulse/Status output 2 ▶ Pulse2 output mode	Device setup ▶ Detailed setup ▶ Pulse/Status out ▶ PO2/SO2 ▶ Output mode	○	○	○	—	○
Device root menu ▶ Detailed setup ▶ Pulse/Status ▶ Pulse/Status output 2 ▶ Pulse2 select	Device setup ▶ Detailed setup ▶ Pulse/Status out ▶ PO2/SO2 ▶ Pulse select	○	○	○	—	○
Device root menu ▶ Detailed setup ▶ Pulse/Status ▶ Pulse/Status output 2 ▶ Pulse2 active mode	Device setup ▶ Detailed setup ▶ Pulse/Status out ▶ PO2/SO2 ▶ Active mode	○	○	○	—	○
Device root menu ▶ Detailed setup ▶ Pulse/Status ▶ Pulse/Status output 2 ▶ Pulse2 fix width	Device setup ▶ Detailed setup ▶ Pulse/Status out ▶ PO2/SO2 ▶ Fix width	○	○	○	—	○
Device root menu ▶ Detailed setup ▶ Pulse/Status ▶ Pulse/Status output 2 ▶ Pulse2 rate value	Device setup ▶ Detailed setup ▶ Pulse/Status out ▶ PO2/SO2 ▶ Rate value	○	○	○	—	○
Device root menu ▶ Detailed setup ▶ Pulse/Status ▶ Pulse/Status output 2 ▶ Pulse2 low cut	Device setup ▶ Detailed setup ▶ Pulse/Status out ▶ PO2/SO2 ▶ Low cut	○	○	○	—	○
Device root menu ▶ Detailed setup ▶ Pulse/Status ▶ Pulse/Status output 2 ▶ Pulse2 alarm out	Device setup ▶ Detailed setup ▶ Pulse/Status out ▶ PO2/SO2 ▶ Alarm out	○	○	○	—	○
Device root menu ▶ Detailed setup ▶ Pulse/Status ▶ Pulse/Status output 2 ▶ Frequency2 at 0%	Device setup ▶ Detailed setup ▶ Pulse/Status out ▶ PO2/SO2 ▶ Frequency at 0%	○	○	○	—	○
Device root menu ▶ Detailed setup ▶ Pulse/Status ▶ Pulse/Status output 2 ▶ Frequency2 at 100%	Device setup ▶ Detailed setup ▶ Pulse/Status out ▶ PO2/SO2 ▶ Frequency at 100%	○	○	○	—	○
Device root menu ▶ Detailed setup ▶ Pulse/Status ▶ Pulse/Status output 2 ▶ Status output2 function	Device setup ▶ Detailed setup ▶ Pulse/Status out ▶ PO2/SO2 ▶ SO2 function	○	○	○	—	○
Device root menu ▶ Detailed setup ▶ Pulse/Status ▶ Status input 3 ▶ Status input3 active mode	Device setup ▶ Detailed setup ▶ Status in ▶ SI3 ▶ Active mode	○	○	○	—	○
Device root menu ▶ Detailed setup ▶ Pulse/Status ▶ Status input 3 ▶ Status input3 function	Device setup ▶ Detailed setup ▶ Status in ▶ SI3 ▶ Function	○	○	○	—	○
Device root menu ▶ Detailed setup ▶ Multi range ▶ Forward span 2	Device setup ▶ Detailed setup ▶ Multi range ▶ Forward span 2	○	○	○	—	○
Device root menu ▶ Detailed setup ▶ Multi range ▶ Reverse span 1	Device setup ▶ Detailed setup ▶ Multi range ▶ Reverse span 1	○	○	○	—	○
Device root menu ▶ Detailed setup ▶ Multi range ▶ Reverse span 2	Device setup ▶ Detailed setup ▶ Multi range ▶ Reverse span 2	○	○	○	—	○
Device root menu ▶ Detailed setup ▶ Multi range ▶ Auto range hyst	Device setup ▶ Detailed setup ▶ Multi range ▶ Auto range hyst	○	○	○	—	○

Alarm name		Backup	Restore			
HART communication	Display		Duplicate Data	Restore Data	Compulsion Data	Restore Factory
Device root menu ▶ Detailed setup ▶ Multi range ▶ Bi direction hyst	Device setup ▶ Detailed setup ▶ Multi range ▶ Bi direction hyst	○	○	○	—	○
Device root menu ▶ Detailed setup ▶ Analog output/input ▶ Analog output 1 ▶ AO1 low cut	Device setup ▶ Detailed setup ▶ Analog out/in ▶ AO1 ▶ Low cut	○	○	○	—	○
Device root menu ▶ Detailed setup ▶ Analog output/input ▶ Analog output 1 ▶ AO1 high limit	Device setup ▶ Detailed setup ▶ Analog out/in ▶ AO1 ▶ High limit	○	○	○	—	○
Device root menu ▶ Detailed setup ▶ Analog output/input ▶ Analog output 1 ▶ AO1 low limit	Device setup ▶ Detailed setup ▶ Analog out/in ▶ AO1 ▶ Low limit	○	○	○	—	○
Device root menu ▶ Detailed setup ▶ Analog output/input ▶ Analog output 1 ▶ AO1 alarm out	Device setup ▶ Detailed setup ▶ Analog out/in ▶ AO1 ▶ Alarm out	○	○	○	○	○
Device root menu ▶ Detailed setup ▶ Analog output/input ▶ Analog output 1 ▶ AO1 range mode	Device setup ▶ Detailed setup ▶ Analog out/in ▶ AO1 ▶ Range mode	○	○	○	—	○
Maintenance root menu ▶ AO/Al trim ▶ AO trim ▶ AO1 Trim	Device setup ▶ Diag/Service ▶ AO/Al trim ▶ AO trim ▶ AO1 trim 4 mA	○	○	○	—	○
	Device setup ▶ Diag/Service ▶ AO/Al trim ▶ AO trim ▶ AO1 trim 20 mA	○	○	○	—	○
Device root menu ▶ Detailed setup ▶ AUX calculation ▶ Flow direction	Device setup ▶ Detailed setup ▶ AUX calculation ▶ Flow direct	○	○	○	—	○
Device root menu ▶ Detailed setup ▶ AUX calculation ▶ Rate limit	Device setup ▶ Detailed setup ▶ AUX calculation ▶ Rate limit	○	○	○	—	○
Device root menu ▶ Detailed setup ▶ AUX calculation ▶ Dead time	Device setup ▶ Detailed setup ▶ AUX calculation ▶ Dead time	○	○	○	—	○
Device root menu ▶ Detailed setup ▶ AUX calculation ▶ Noise filter	Device setup ▶ Detailed setup ▶ AUX calculation ▶ Noise filter	○	○	○	—	○
Device root menu ▶ Detailed setup ▶ AUX calculation ▶ Pulsing flow	Device setup ▶ Detailed setup ▶ AUX calculation ▶ Pulsing flow	○	○	○	—	○
Device root menu ▶ Detailed setup ▶ AUX calculation ▶ Power synchronize	Device setup ▶ Detailed setup ▶ AUX calculation ▶ Power sync	○	○	○	○	○
Device root menu ▶ Detailed setup ▶ AUX calculation ▶ Set power frequency	Device setup ▶ Detailed setup ▶ AUX calculation ▶ Set power freq	○	○	○	○	○
Device root menu ▶ Detailed setup ▶ Process variables ▶ Density ▶ Density fixed value	Device setup ▶ Detailed setup ▶ Pro var ▶ Density ▶ Fixed density	○	○	○	○	○
Maintenance root menu ▶ High/Low alarm configuration ▶ High alarm	Device setup ▶ Diag/Service ▶ H/L alarm cfg ▶ High alarm	○	○	○	—	○
Maintenance root menu ▶ High/Low alarm configuration ▶ Low alarm	Device setup ▶ Diag/Service ▶ H/L alarm cfg ▶ Low alarm	○	○	○	—	○

Alarm name		Backup	Restore			
HART communication	Display		Duplicate Data	Restore Data	Compulsion Data	Restore Factory
Maintenance root menu ► High/Low alarm configuration ► High high alarm	Device setup ► Diag/Service ► H/L alarm cfg ► HH alarm	○	○	○	—	○
Maintenance root menu ► High/Low alarm configuration ► Low low alarm	Device setup ► Diag/Service ► H/L alarm cfg ► LL alarm	○	○	○	—	○
Maintenance root menu ► High/Low alarm configuration ► Hi/Lo alarm hysteresis	Device setup ► Diag/Service ► H/L alarm cfg ► H/L alarm hyst	○	○	○	—	○
Device root menu ► Detailed setup ► Display ► Line select ► Display select1	Device setup ► Detailed setup ► Display set ► Line select ► Line 1	○	—	—	○	○
Device root menu ► Detailed setup ► Display ► Line select ► Display select2	Device setup ► Detailed setup ► Display set ► Line select ► Line 2	○	—	—	○	○
Device root menu ► Detailed setup ► Display ► Line select ► Display select3	Device setup ► Detailed setup ► Display set ► Line select ► Line 3	○	—	—	○	○
Device root menu ► Detailed setup ► Display ► Line select ► Display select4	Device setup ► Detailed setup ► Display set ► Line select ► Line 4	○	—	—	○	○
Device root menu ► Detailed setup ► Display ► Line select ► Display select5	Device setup ► Detailed setup ► Display set ► Line select ► Line 5	○	—	—	○	○
Device root menu ► Detailed setup ► Display ► Line select ► Display select6	Device setup ► Detailed setup ► Display set ► Line select ► Line 6	○	—	—	○	○
Device root menu ► Detailed setup ► Display ► Line select ► Display select7	Device setup ► Detailed setup ► Display set ► Line select ► Line 7	○	—	—	○	○
Device root menu ► Detailed setup ► Display ► Line select ► Display select8	Device setup ► Detailed setup ► Display set ► Line select ► Line 8	○	—	—	○	○
Device root menu ► Detailed setup ► Display ► Display format ► Display format PV	Device setup ► Detailed setup ► Display set ► Disp format ► Format PV	○	—	—	○	○
Device root menu ► Detailed setup ► Display ► Display operation configuration ► Display line	Device setup ► Detailed setup ► Display set ► Optional config ► Line mode	○	—	—	○	○
Device root menu ► Detailed setup ► Display ► Display operation configuration ► Display installation	Device setup ► Detailed setup ► Device info ► Order info ► Disp install	○	—	—	○	○
Device root menu ► Detailed setup ► Device information ► Order information ► Tag	Device setup ► Detailed setup ► Device info ► Order info ► Tag No	○	—	—	○	○
Device root menu ► Detailed setup ► Device information ► Order information ► Long tag	Device setup ► Detailed setup ► Device info ► Order info ► Long tag	○	—	—	○	○
Device root menu ► Detailed setup ► Device information ► Order information ► Electrode size	Device setup ► Detailed setup ► Device info ► Order info ► Electrode size	○	○	○	—	○
Device root menu ► Detailed setup ► Device information ► Order information ► Basic model code	Device setup ► Detailed setup ► Device info ► Order info ► MS code ► Model code	○	○	○	—	○

Alarm name		Backup	Restore			
HART communication	Display		Duplicate Data	Restore Data	Compulsion Data	Restore Factory
Device root menu ▶ Detailed setup ▶ Device information ▶ Order information ▶ Suffix config 1	Device setup ▶ Detailed setup ▶ Device info ▶ Order info ▶ MS code ▶ Suffix config 1	○	○	○	—	○
Device root menu ▶ Detailed setup ▶ Device information ▶ Order information ▶ Suffix config 2	Device setup ▶ Detailed setup ▶ Device info ▶ Order info ▶ MS code ▶ Suffix config 2	○	○	○	—	○
Device root menu ▶ Detailed setup ▶ Device information ▶ Order information ▶ Option 1	Device setup ▶ Detailed setup ▶ Device info ▶ Order info ▶ MS code ▶ Option 1	○	○	○	—	○
Device root menu ▶ Detailed setup ▶ Device information ▶ Order information ▶ Option 2	Device setup ▶ Detailed setup ▶ Device info ▶ Order info ▶ MS code ▶ Option 2	○	○	○	—	○
Device root menu ▶ Detailed setup ▶ Device information ▶ Order information ▶ Option 3	Device setup ▶ Detailed setup ▶ Device info ▶ Order info ▶ MS code ▶ Option 3	○	○	○	—	○
Device root menu ▶ Detailed setup ▶ Device information ▶ Order information ▶ Option 4	Device setup ▶ Detailed setup ▶ Device info ▶ Order info ▶ MS code ▶ Option 4	○	○	○	—	○
Device root menu ▶ Detailed setup ▶ Device information ▶ Order information ▶ Remote sensor basic model code	Device setup ▶ Detailed setup ▶ Device info ▶ Order info ▶ RS MS code ▶ Model code	○	○	○	—	○
Device root menu ▶ Detailed setup ▶ Device information ▶ Order information ▶ Remote sensor suffix config 1	Device setup ▶ Detailed setup ▶ Device info ▶ Order info ▶ RS MS code ▶ Suffix config 1	○	○	○	—	○
Device root menu ▶ Detailed setup ▶ Device information ▶ Order information ▶ Remote sensor suffix config 2	Device setup ▶ Detailed setup ▶ Device info ▶ Order info ▶ RS MS code ▶ Suffix config 2	○	○	○	—	○
Device root menu ▶ Detailed setup ▶ Device information ▶ Order information ▶ Remote sensor option 1	Device setup ▶ Detailed setup ▶ Device info ▶ Order info ▶ RS MS code ▶ Option 1	○	○	○	—	○
Device root menu ▶ Detailed setup ▶ Device information ▶ Order information ▶ Remote sensor option 2	Device setup ▶ Detailed setup ▶ Device info ▶ Order info ▶ RS MS code ▶ Option 2	○	○	○	—	○
Device root menu ▶ Detailed setup ▶ Device information ▶ Order information ▶ Remote sensor option 3	Device setup ▶ Detailed setup ▶ Device info ▶ Order info ▶ RS MS code ▶ Option 3	○	○	○	—	○
Device root menu ▶ Detailed setup ▶ Device information ▶ Order information ▶ Remote sensor option 4	Device setup ▶ Detailed setup ▶ Device info ▶ Order info ▶ RS MS code ▶ Option 4	○	○	○	—	○
Device root menu ▶ Detailed setup ▶ Device information ▶ Version/Number information ▶ Transmitter serial No	Device setup ▶ Detailed setup ▶ Device info ▶ Ver/Num info ▶ Trans serial No	○	○	○	—	○

Alarm name		Backup	Restore			
HART communication	Display		Duplicate Data	Restore Data	Compulsion Data	Restore Factory
Device root menu ▶ Detailed setup ▶ Device information ▶ Version/Number information ▶ Sensor serial No	Device setup ▶ Detailed setup ▶ Device info ▶ Ver/Num info ▶ Sensor serial No	○	○	○	—	○
Diagnostic root menu ▶ Diagnosis ▶ Adhesion ▶ Adhesion function	Device setup ▶ Diag/Service ▶ Diagnosis ▶ Adhesion ▶ Function	○	○	○	○	○
Diagnostic root menu ▶ Diagnosis ▶ Adhesion ▶ Adhesion level 1	Device setup ▶ Diag/Service ▶ Diagnosis ▶ Adhesion ▶ Threshold level 1	○	○	○	—	○
Diagnostic root menu ▶ Diagnosis ▶ Adhesion ▶ Adhesion level 2	Device setup ▶ Diag/Service ▶ Diagnosis ▶ Adhesion ▶ Threshold level 2	○	○	○	—	○
Diagnostic root menu ▶ Diagnosis ▶ Adhesion ▶ Adhesion level 3	Device setup ▶ Diag/Service ▶ Diagnosis ▶ Adhesion ▶ Threshold level 3	○	○	○	—	○
Diagnostic root menu ▶ Diagnosis ▶ Adhesion ▶ Adhesion level 4	Device setup ▶ Diag/Service ▶ Diagnosis ▶ Adhesion ▶ Threshold level 4	○	○	○	—	○
Diagnostic root menu ▶ Diagnosis ▶ Adhesion ▶ Adhesion check cycle	Device setup ▶ Diag/Service ▶ Diagnosis ▶ Adhesion ▶ Check cycle	○	○	○	—	○
Diagnostic root menu ▶ Diagnosis ▶ Coil insulation threshold	Device setup ▶ Diag/Service ▶ Diagnosis ▶ Coil insul threshold	○	○	○	—	○
Diagnostic root menu ▶ Diagnosis ▶ IEX compare	Device setup ▶ Diag/Service ▶ Diagnosis ▶ IEX compare	○	○	○	—	○
Diagnostic root menu ▶ Diagnosis ▶ Diagnostic output	Device setup ▶ Diag/Service ▶ Diagnosis ▶ Diagnostic output	○	○	○	—	○
Maintenance root menu ▶ Verification ▶ VF mode	Device setup ▶ Diag/Service ▶ Verification ▶ Mode	○	○	○	—	○
Maintenance root menu ▶ Verification ▶ VF No	Device setup ▶ Diag/Service ▶ Verification ▶ VF No	○	○	○	—	○
Maintenance root menu ▶ Test ▶ Release time	Device setup ▶ Diag/Service ▶ Test ▶ Release time	○	○	○	—	○

4.13.4 Data Logging Function

The data logging function can be stored up to four process values to the microSD card when the optional code MC (microSD card) is selected. When using this function, it is possible to specify the file name, data storage interval, and data logging function ending time.

The stored data is saved in the “YOKOGAWA” folder as a “.TRD” file.

The data logging function can be configured with the following parameters.

Display menu path:

Device setup ► Diag/Service ► Data log ► (see below)

File name	Specify the name of the file to be stored.
Interval time	Specify the data storage interval.*1
Start date	Displays the date to start the data logging function.
Start time	Displays the time to start the data logging function.
End time	Specify the time to end the data logging function.*2
Log 1	Specify process value 1 to be stored.*3
Log 2	Specify process value 2 to be stored.*3
Log 3	Specify process value 3 to be stored.*3
Log 4	Specify process value 4 to be stored.*3
Execute	Specifies the execution of the data logging function.*4

HART communication:

Maintenance root menu ► Data logging ► (see below)

File name	Specify the name of the file to be stored.
Interval time	Specify the data storage interval.*1
Start date	Displays the date to start the data logging function.
Start time	Displays the time to start the data logging function.
End time	Specify the time to end the data logging function.*2
Log1 select	Specify process value 1 to be stored.*3
Log2 select	Specify process value 2 to be stored.*3
Log3 select	Specify process value 3 to be stored.*3
Log4 select	Specify process value 4 to be stored.*3
Logging Exe	Specifies the execution of the data logging function.*4

*1: From the table below, select the data storage interval.

1 s	Sets the storage interval to 1 sec.
10 s	Sets the storage interval to 10 sec.
30 s	Sets the storage interval to 30 sec.
1 min	Sets the storage interval to 1 min.
5 min	Sets the storage interval to 5 min.
30 min	Sets the storage interval to 30 min.
1 h	Sets the storage interval to 1 hour.

*2: From the table below, select the data logging function ending time.

10 min	Sets the ending time to 10 minutes later.
30 min	Sets the ending time to 30 minutes later.
1 h	Sets the ending time to 1 hour later.
3 h	Sets the ending time to 3 hours later.
12 h	Sets the ending time to 12 hours later.
24 h	Sets the ending time to 24 hours (1 day) later.
72 h	Sets the ending time to 72 hours (3 days) later.
240 h	Sets the ending time to 240 hours (10 days) later.

*3: From the table below, select the process value to be stored.

PV	Stores the process value that is PV-mapped in Subsection 4.1.2.
Velocity	Stores the flow velocity.
Volume flow	Stores the volumetric flow rate.
Mass flow	Stores the mass flow rate.
Adhesion	Stores the resistance value of the electrode adhesion detection.

*4: From the table below, select the use of the data logging function.

Not Execute	Does not execute the data logging function.
Execute	Executes the data logging function.

Data is stored in the microSD card at the specified storage interval during the period from the start of the data logging function to the end. The file stored by the data logging function can be opened as a text file.

Example: If the storage interval is set to “1 min”, data is stored as shown below.

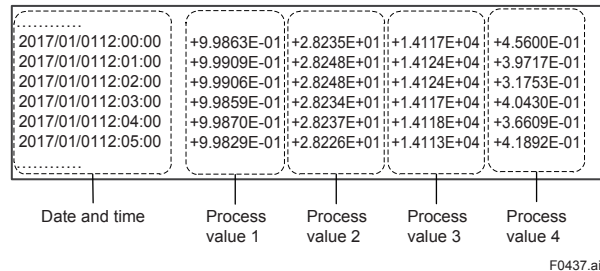

The access ongoing to the microSD card can be confirmed by the icon on the display. For example, the icons of “microSD card ready” and “Access to microSD card” are displayed alternately repeatedly while the instrument accesses to the microSD card periodically during its data logging.

The icon of “Error accessing microSD card” is displayed when the micorSD card cannot be accessed in such a case of removing it.

Insert the microSD card again when it is necessary to use this function again. And an alarm of “microSD failure” occurs when the microSD card has any problems.

	Ready for microSD card		Accessing microSD card
	Disable to access microSD card		



IMPORTANT

- When using the data logging function, be sure to specify the date and time information.
- Before using the data logging function, make sure that the microSD card is prepared. Approximately 1 minute is required until the instrument is ready to store data after it has been turned on.
- Note that the date and time information are reset if this instrument is turned off.
- Note that, if the microSD card runs out of free space, the subsequent data will not be stored.

4.14 Software Write Protection Function

The write protection can be changed by the hardware write protection switch or the parameter setting of the software write protection. When the write protection is enabled by any of them, data writing is forbidden. For details about the hardware write protection, see the Installation Manual as listed in Table 1.1.

To enable the software write protection function, specify “New password” (eight alphanumeric characters without lowercase letter) as a password to disable the write protection function. By entering the password in the menu of “Enable write”, it is possible to disable the write protection and change the parameters only for 10 minutes. The write protection is completely disabled if eight spaces are entered to “New password” in the state that the protection is disabled temporarily.

The write protection function can be configured by the following procedure.

Display menu path:

Device setup ► Detailed setup ► Protection ► (see below)

Write protect sts	Indicates the use of the write protection function.*1
Enable write	Cancels the write protection function only for 10 minutes.
New password	Specify a new password for the write protection function.

HART communication:

Device root menu ► Detailed setup ► Protection ► (see below)

Write protect	Indicates the use of the write protection function.*1
Enable write 10 min	Cancels the write protection function only for 10 minutes.
New password	Specify a new password for the write protection function.

*1: Display of the use status of the write protection function

No	The write protection function is disabled. (Parameters can be changed.)
Yes	The write protection function is enabled. (Parameters cannot be changed.)



NOTE

The use status of the write protection function can be viewed using the parameters or the icons shown on the display.

The following icons are displayed.

Icon	Contents
	Write protect Invalid (Parameter change is possible)
	Write protect Valid (Parameter change is impossible)



NOTE

When the write protection switch on the amplifier board is turned on, any parameter cannot be changed.

To change a parameter, cancel the write protection function using the pre-specified password, and specify a new password.

If the password had been forgotten, it is possible to use the Joker password to temporarily disable the software write protection function.

When the write protection function is disabled using the Joker password, “Break” is displayed as the parameter. Re-set a new password to use this function. When this function is disabled using a new password, the parameter returns to “Keep”. The use of the Joker password seal can be checked by the following procedure.

Display menu path:

Device setup ► Detailed setup ► Protection ► (see below)

Soft seal status	Check the use of the Joker password.
------------------	--------------------------------------

HART communication:

Device root menu ► Detailed setup ►

Protection ► (see below)

Software seal	Check the use of the Joker password.
---------------	--------------------------------------

Check the use of the Joker password depending on the following parameters.

Keep	Normal
Break	Disable the write protection function using the Joker password.



NOTE

If it is necessary to use the Joker password, contact Yokogawa sales office or representative.

5. Parameters of Magnetic Flowmeter

This chapter describes the display parameters, HART communication parameters.

The dedicated parameters are configured as specified at the time of ordering. Other parameters are set to default values; therefore, when changing any one of them, always read this chapter.



IMPORTANT

If the instrument is turned off within 30 seconds after parameter settings have been completed, the settings are reset. After settings, be sure to keep the power on for 30 seconds or more.



NOTE

To obtain the correct flow rate signal, specify the nominal size of the sensor, flow rate span, and meter factor. This instrument has the nominal size of the sensor and the meter factor specified upon shipment from the manufacturing plant, which does not require user's settings.

The dedicated parameters are configured before shipment only when they are specified at the time of ordering. Parameters that are not specified at the time of ordering must be configured by the user.



NOTE

The available functions and the displayed parameters vary depending on the connection terminal type selected at the time of ordering.

5.1 Parameter Lists for Display and HART Communication

Each parameter list consists of the following items.

No.	Indicates the parameter number.
Name	Indicates the parameter name.
Setting	Indicates the parameter that can be displayed and/or specified. R: Displayed only. RW: Displayed and specified. However, when changing a parameter on the display, note that the specifiable parameters vary depending on the operation level. Operator: Can only specify the language to be displayed on the display and the configuration parameters. Maintenance: Can only specify the "Operator" operation level and the zero-adjustment parameters. Specialist: Can specify all the parameters.
Range	For selection-type data, the range indicates options. For numeric-type data, the range indicates the setting range and the number of decimal places. For alphanumeric-type data, the range indicates the limited number of characters.
Default value	Indicates the default value upon shipment from the manufacturing plant. Symbol (*) indicates a parameter with the model and suffix code specified, or a parameter specified at the time of ordering.
Unit	Indicates the unit of the data range.
Description	Describes the contents of the parameter.

○: Parameter displayed

Terminal function	Description	Communication and I/O code		
		JA	JE	JG
		-E	-J	-L
Current output1	Parameters related to the Current output1 are displayed regardless of the code selection.	○	○	○
Pulse/Status output1	Parameters related to the Pulse/Status output1 are displayed regardless of the code selection.	○	○	○
Pulse/Status output2	Parameters related to the Pulse/Status output2 may not be displayed depending on the code selection. No.5-11 to 22, and 13-10 to 13-11		○	○
Status input	Parameters related to the Status input may not be displayed depending on the code selection. No.6-3 to 6-5, and 13-14		○	○

(1) Display parameters

This list shows the display parameters such as the flow rate and totalized value.

No.	Name		Setting	Range		Default value	Unit	Description
	HART communication	Display		HART communication	Display			
1-1	Process variables root menu► Dynamic variables► PV % mge	Device setup► Process variables► Flow rate %	R	-99999.9 to +99999.9 Number of decimal places: 3	-99999.9 to +99999.9 Number of decimal places: 1	-	%	Indicates the range rate for the process value that is PV-mapped in No. 3-14.
1-2	Process variables root menu► Dynamic variables► PV	Device setup► Process variables► Flow rate	R	-999999 to +999999 Number of decimal places: 0 to 5	-999999 to +999999 Number of decimal places: 0 to 5	-	Flow velocity: Specified in No. 3-15. Volumetric flow rate: Specified in No. 3-16 and No. 3-19. Mass flow rate: Specified in No. 3-17 and	Indicates the process value that is PV-mapped in No. 3-14.
1-3	Process variables root menu► View outputs► AO1 current	Device setup► Process variables► Analog out 1	R	0.000 to +99.999 Number of decimal places: 3	0.000 to +99.999 Number of decimal places: 3	-	mA	Used for I/O1 terminal. Indicates the current value of the current output.
1-4	Process variables root menu► Device variables► Totalizer1	Device setup► Process variables► Totalizer► Totalizer 1	R	-999999 to +999999 Number of decimal places: 0 to 5	-99999999 to +99999999 Number of decimal places: 0 to 5	-	Specified in No. 4-1.	Indicates the totalized value of totalizer 1.
1-5	Process variables root menu► Device variables► Totalizer2	Device setup► Process variables► Totalizer► Totalizer 2	R	-999999 to +999999 Number of decimal places: 0 to 5	-99999999 to +99999999 Number of decimal places: 0 to 5	-	Specified in No. 4-10.	Indicates the totalized value of totalizer 2.
1-6	Process variables root menu► Device variables► Totalizer3	Device setup► Process variables► Totalizer► Totalizer 3	R	-999999 to +999999 Number of decimal places: 0 to 5	-99999999 to +99999999 Number of decimal places: 0 to 5	-	Specified in No. 4-19.	Indicates the totalized value of totalizer 3.
1-7	Process variables root menu► Totalizer count► Totalizer1 count	Device setup► Process variables► Totalizer► Totalizer 1 count	R	-INF(**) to +INF(**) Number of decimal places: 0	-99999999 to +99999999 Number of decimal places: 0	-	-	Indicates the totalized value (totalizer value) scaled by totalizer 1.
1-8	Process variables root menu► Totalizer count► Totalizer2 count	Device setup► Process variables► Totalizer► Totalizer 2 count	R	-INF(**) to +INF(**) Number of decimal places: 0	-99999999 to +99999999 Number of decimal places: 0	-	-	Indicates the totalized value (totalizer value) scaled by totalizer 2.
1-9	Process variables root menu► Totalizer count► Totalizer3 count	Device setup►► Process variables► Totalizer► Totalizer 3 count	R	-INF(**) to +INF(**) Number of decimal places: 0	-99999999 to +99999999 Number of decimal places: 0	-	-	Indicates the totalized value (totalizer value) scaled by totalizer 3.
1-10	Process variables root menu► Device variables► Velocity	Device setup► Process variables► Velocity	R	-999999 to +999999 Number of decimal places: 0 to 5	-999999 to +999999 Number of decimal places: 0 to 5	-	Specified in No. 3-15.	Indicates the flow velocity.
1-11	Process variables root menu► Device variables► Volume flow	Device setup► Process variables► Volume	R	-999999 to +999999 Number of decimal places: 0 to 5	-999999 to +999999 Number of decimal places: 0 to 5	-	Specified in No. 3-16 and No. 3-19.	Indicates the volumetric flow rate.
1-12	Process variables root menu► Device variables► Mass flow	Device setup► Process variables► Mass	R	-999999 to +999999 Number of decimal places: 0 to 5	-999999 to +999999 Number of decimal places: 0 to 5	-	Specified in No. 3-17 and No. 3-19.	Indicates the mass flow rate.

(**): The range of single precision float (IEEE 754).

(2) Easy configuration parameters

This list shows the parameters for the frequently-used general functions.

No.	Name		Setting	Range		Default value	Unit	Description
	HART communication	Display		HART communication	Display			
2-1	Device root menu▶ Detailed setup▶ Display▶ Display operation configuration▶ Language	Device setup▶ Language	RW	English French German Italian Spanish Portuguese Russian Chinese Japanese	English French German Italian Spanish Portuguese Russian Chinese Japanese	English	-	Specify the language to be used on the display. Synchronized with No. 10-21.
2-2	Device root menu▶ Basic setup▶ Volume flow▶ Volume flow damping AO/frequency	Device setup▶ Easy setup wizard▶ Volume▶ Damp AO/F	RW	+0.1 to +200.0 Number of decimal places: 1	+0.1 to +200.0 Number of decimal places: 1	3.0	s	Used for current output or frequency output. Specify the damping time constant of the volumetric flow rate. Synchronized with No. 3-12.
2-3	Device root menu▶ Basic setup▶ Volume flow▶ Volume flow damping pulse/total	Device setup▶ Easy setup wizard▶ Volume▶ Damp pls/ttl	RW	+0.1 to +200.0 Number of decimal places: 1	+0.1 to +200.0 Number of decimal places: 1	3.0	s	Used for pulse output or totalization. Specify the damping time constant of the volumetric flow rate. Synchronized with No. 3-13.
2-4	Device root menu▶ Basic setup▶ Volume flow▶ Volume flow unit	Device setup▶ Easy setup wizard▶ Volume▶ Unit	RW	ML m3 kL l(liter) cm3 kcf cf mcf Mgal(US) kgal(US) gal(US) mgal(US) kbb(US Oil) bb(US Oil) mbb(US Oil) ubb(US Oil) kbb(US Beer) bb(US Beer) mbb(US Beer) ubb(US Beer)	Ml(Megaliter) m³ kl(kiloliter) l(liter) cm³ kcf cf mcf Mgal(US) kgal(US) gal(US) mgal(US) kbb(US Oil) bb(US Oil) mbb(US Oil) ubb(US Oil) kbb(US Beer) bb(US Beer) mbb(US Beer) ubb(US Beer)	m³ (*)	-	Specify the unit of the volumetric flow rate. Synchronized with No. 3-16.
2-5	Device root menu▶ Basic setup▶ Volume flow▶ Time unit	Device setup▶ Easy setup wizard▶ Volume▶ Time unit	RW	/s /min /h /d	/s /min /h /d	/h (*)	-	Specify the time unit of the volumetric flow rate, and mass flow rate. Synchronized with No. 3-19.
2-6	Device root menu▶ Basic setup▶ Volume flow▶ Volume flow span	Device setup▶ Easy setup wizard▶ Volume▶ Span	RW	+0.00001 to +INF(**) Number of decimal places: 1 to 5	+0.00001 to +999999 Number of decimal places: 0 to 5	1.00 (*)	Specified in No. 3-16 and No. 3-19.	Specify the span of the volumetric flow rate. Synchronized with No. 3-21.
2-7	Device root menu▶ Detailed setup▶ Pulse/Status▶ Pulse/Status output 1▶ Pulse1 rate unit	Device setup▶ Easy setup wizard▶ Pulse/Status out▶ P1 unit	RW	n unit/P u unit/P m unit/P Unit/P k unit/P M unit/P n P/unit u P/unit m P/unit P/unit k P/unit M P/unit	n unit/P u unit/P m unit/P Unit/P k unit/P M unit/P n P/unit u P/unit m P/unit P/unit k P/unit M P/unit	Unit/P (*)	-	Used for pulse output of the I/O2 terminal. Specify the pulse rate scaling. Synchronized with No. 5-4.
2-8	Device root menu▶ Detailed setup▶ Pulse/Status▶ Pulse/Status output 1▶ Pulse1 rate value	Device setup▶ Easy setup wizard▶ Pulse/Status out▶ P1 val	RW	0.00000 to +INF(**) Number of decimal places: 1 to 5	0.00000 to +999999 Number of decimal places: 0 to 5	0.0	Specified in No.5-4	Used for pulse output of the I/O2 terminal. Specify the pulse rate value. Synchronized with No. 5-5.
2-9	Device root menu▶ Detailed setup▶ Pulse/Status▶ Pulse/Status output 1▶ Frequency1 at 0%	Device setup▶ Easy setup wizard▶ Pulse/Status out▶ F1 at 0%	RW	0 to 12500 Number of decimal places: 0	0 to 12500 Number of decimal places: 0	0	Hz	Used for frequency output of the I/O2 terminal. Specify the frequency that is available when 0% is set to the process value PV-mapped in No. 3-14. Synchronized with No. 5-8.
2-10	Device root menu▶ Detailed setup▶ Pulse/Status▶ Pulse/Status output 1▶ Frequency1 at 100%	Device setup▶ Easy setup wizard▶ Pulse/Status out▶ F1 at 100%	RW	0 to 12500 Number of decimal places: 0	0 to 12500 Number of decimal places: 0	0	Hz	Used for frequency output of the I/O2 terminal. Specify the frequency that is available when 100% is set to the process value PV-mapped in No. 3-14. Synchronized with No. 5-9.

(*): Determined based on the information about specified items at the time of ordering and the sensor to be combined with.

(**): The range of single precision float (IEEE 754).

No.	Name		Setting	Range		Default value	Unit	Description
	HART communication	Display		HART communication	Display			
2-11	Device root menu▶ Detailed setup▶ Display▶ Line select▶ Display select1	Device setup▶ Easy setup wizard▶ Display set▶ Line 1	RW	Flow rate(%) PV Velocity Volume flow Mass flow Flow rate(%Bar) Totalizer1 Totalizer2 Totalizer3 Tag number Long tag Commun Protocol Adhesion Analog out1	Flow rate(%) PV Velocity Volume flow Mass flow Flow rate(%Bar) Totalizer1 Totalizer2 Totalizer3 Tag number Long tag Commun Protocol Adhesion Analog out1	PV	-	Specify item 1 to be shown on the display. Synchronized with No. 10-1.
2-12	Device root menu▶ Detailed setup▶ Display▶ Line select▶ Display select2	Device setup▶ Easy setup wizard▶ Display set▶ Line 2	RW	None Flow rate(%) PV Velocity Volume flow Mass flow Flow rate(%Bar) Totalizer1 Totalizer2 Totalizer3 Tag number Long tag Commun Protocol Adhesion Analog out1	None Flow rate(%) PV Velocity Volume flow Mass flow Flow rate(%Bar) Totalizer1 Totalizer2 Totalizer3 Tag number Long tag Commun Protocol Adhesion Analog out1	Flow rate(%)	-	Specify item 2 to be shown on the display. Synchronized with No. 10-2.
2-13	Device root menu▶ Detailed setup▶ Display▶ Line select▶ Display select3	Device setup▶ Easy setup wizard▶ Display set▶ Line 3	RW	Totalizer1 Totalizer2 Totalizer3 Tag number Long tag Commun Protocol Adhesion Analog out1	Totalizer1 Totalizer2 Totalizer3 Tag number Long tag Commun Protocol Adhesion Analog out1	Analog out1	-	Specify item 3 to be shown on the display. Synchronized with No. 10-3.
2-14	Device root menu▶ Basic setup▶ Autozero▶ Autozero Exe	Device setup▶ Easy setup wizard▶ Autozero exe	RW	Not execute Execute	Not execute Execute	Not execute	-	Specify whether to execute the zero adjustment function. Synchronized with No. 3-31.

(*): Determined based on the information about specified items at the time of ordering and the sensor to be combined with.

(**): The range of single precision float (IEEE 754).

(3) Basic configuration parameters

This list shows the parameters related to the basic settings for the sensor and other devices.

No.	Name		Setting	Range		Default value	Unit	Description
	HART communication	Display		HART communication	Display			
3-1	Device root menu ▶ Detailed setup ▶ Process variables ▶ Velocity ▶ Velocity damping AO/frequency	Device setup ▶ Detailed setup ▶ Pro var ▶ Velocity ▶ Damp AO/F	RW	+0.1 to +200.0 Number of decimal places: 1	+0.1 to +200.0 Number of decimal places: 1	3.0	s	Used for current output or frequency output. Specify the damping time constant of the flow velocity.
3-2	Device root menu ▶ Detailed setup ▶ Process variables ▶ Velocity ▶ Velocity damping pulse/total	Device setup ▶ Detailed setup ▶ Pro var ▶ Velocity ▶ Damp pls/ttl	RW	+0.1 to +200.0 Number of decimal places: 1	+0.1 to +200.0 Number of decimal places: 1	3.0	s	Used for pulse output or totalization. Specify the damping time constant of the flow velocity.
3-3	Device root menu ▶ Detailed setup ▶ Process variables ▶ Volume flow ▶ Volume flow damping AO/frequency	Device setup ▶ Detailed setup ▶ Pro var ▶ Volume ▶ Damp AO/F	RW	+0.1 to +200.0 Number of decimal places: 1	+0.1 to +200.0 Number of decimal places: 1	3.0	s	Used for current output or frequency output. Specify the damping time constant of the volumetric flow rate. Synchronized with No. 2-2.
3-4	Device root menu ▶ Detailed setup ▶ Process variables ▶ Volume flow ▶ Volume flow damping pulse/total	Device setup ▶ Detailed setup ▶ Pro var ▶ Volume ▶ Damp pls/ttl	RW	+0.1 to +200.0 Number of decimal places: 1	+0.1 to +200.0 Number of decimal places: 1	3.0	s	Used for pulse output or totalization. Specify the damping time constant of the volumetric flow rate. Synchronized with No. 2-3.
3-5	Device root menu ▶ Detailed setup ▶ Process variables ▶ Mass flow ▶ Mass flow damping AO/frequency	Device setup ▶ Detailed setup ▶ Pro var ▶ Mass ▶ Damp AO/F	RW	+0.1 to +200.0 Number of decimal places: 1	+0.1 to +200.0 Number of decimal places: 1	3.0	s	Used for current output or frequency output. Specify the damping time constant of the mass flow rate.
3-6	Device root menu ▶ Detailed setup ▶ Process variables ▶ Mass flow ▶ Mass flow damping pulse/total	Device setup ▶ Detailed setup ▶ Pro var ▶ Mass ▶ Damp pls/ttl	RW	+0.1 to +200.0 Number of decimal places: 1	+0.1 to +200.0 Number of decimal places: 1	3.0	s	Used for pulse output or totalization. Specify the damping time constant of the mass flow rate.
3-9	Device root menu ▶ Detailed setup ▶ Sensor ▶ Low MF	Device setup ▶ Detailed setup ▶ Sensor ▶ Low MF	RW	+0.0100 to +3.0000 Number of decimal places: 4	+0.0100 to +3.0000 Number of decimal places: 4	1.0000 (*)	-	Specify the low side frequency meter factor.
3-10	Device root menu ▶ Detailed setup ▶ Sensor ▶ High MF	Device setup ▶ Detailed setup ▶ Sensor ▶ High MF	RW	+0.0100 to +3.0000 Number of decimal places: 4	+0.0100 to +3.0000 Number of decimal places: 4	1.0000 (*)	-	Specify the high side frequency meter factor.
3-11	Device root menu ▶ Detailed setup ▶ Sensor ▶ Flow sensor select	Device setup ▶ Detailed setup ▶ Sensor ▶ Flow sensor sel	RW	ADMAG AXW Calibrator Other1 Other2	ADMAG AXW Calibrator Other1 Other2	ADMAG AXW (*)	-	Specify the sensor type.
3-12	Device root menu ▶ Detailed setup ▶ Sensor ▶ Nominal size unit	Device setup ▶ Detailed setup ▶ Sensor ▶ Nominal size unit	RW	mm inch	mm inch	mm	-	Specify the unit of the nominal size for the sensor.
3-13	Device root menu ▶ Detailed setup ▶ Sensor ▶ Nominal size	Device setup ▶ Detailed setup ▶ Sensor ▶ Nominal size	RW	+0.01000 to +3000.0 Number of decimal places: 0 to 5	+0.01000 to +3000.0 Number of decimal places: 0 to 5	100 (*)	Specified in No. 3-12.	Specify the nominal size of the sensor.
3-14	Device root menu ▶ Detailed setup ▶ Process variables ▶ PV flow select	Device setup ▶ Detailed setup ▶ Pro var ▶ PV flow select	RW	Velocity Volume Mass	Velocity Volume Mass	Volume (*)	-	Specify the process value to be PV-mapped. Velocity: Flow velocity Volume: Volumetric flow rate Mass: Mass flow rate
3-15	Device root menu ▶ Detailed setup ▶ Process variables ▶ Velocity ▶ Velocity unit	Device setup ▶ Detailed setup ▶ Pro var ▶ Velocity ▶ Unit	RW	m/s ft/s	m/s ft/s	m/s (*)	-	Specify the unit of the flow velocity.
3-16	Device root menu ▶ Detailed setup ▶ Process variables ▶ Volume flow ▶ Volume flow unit	Device setup ▶ Detailed setup ▶ Pro var ▶ Volume ▶ Unit	RW	ML m ³ kL l(liter) cm ³ kcf cf mcf Mgal(US) kgal(US) gal(US) mgal(US) kbb(US Oil) bb(US Oil) mbbl(US Oil) ubbl(US Oil) kbb(US Beer) bb(US Beer) mbbl(US Beer) ubbl(US Beer)	ML(Megaliter) m ³ k(kiloliter) l(liter) cm ³ kcf cf mcf Mgal(US) kgal(US) gal(US) mgal(US) kbb(US Oil) bb(US Oil) mbbl(US Oil) ubbl(US Oil) kbb(US Beer) bb(US Beer) mbbl(US Beer) ubbl(US Beer)	m ³ (*)	-	Specify the unit of the volumetric flow rate. Synchronized with No. 2-4.

(*): Determined based on the information about specified items at the time of ordering and the sensor to be combined with.

(**): The range of single precision float (IEEE 754).

No.	Name		Setting	Range		Default value	Unit	Description
	HART communication	Display		HART communication	Display			
3-17	Device root menu ▶ Detailed setup ▶ Process variables ▶ Mass flow ▶ Mass flow unit	Device setup ▶ Detailed setup ▶ Pro var ▶ Mass ▶ Unit	RW	t kg g klb lb	t kg g klb lb	kg (*)	-	Specify the unit of the mass flow rate.
3-19	Device root menu ▶ Detailed setup ▶ Process variables ▶ Volume flow ▶ Time unit or Device root menu ▶ Detailed setup ▶ Process variables ▶ Mass flow ▶ Time unit	Device setup ▶ Detailed setup ▶ Pro var ▶ Volume ▶ Time unit or Device setup ▶ Detailed setup ▶ Pro var ▶ Mass ▶ Time unit	RW	/s /min /h /d	/s /min /h /d	/h (*)	-	Specify the time unit of the volumetric flow rate, and mass flow rate. Synchronized with No. 2-5.
3-20	Device root menu ▶ Detailed setup ▶ Process variables ▶ Velocity ▶ Velocity span	Device setup ▶ Detailed setup ▶ Pro var ▶ Velocity ▶ Span	RW	+0.00001 to +INF(**) Number of decimal places: 0 to 5	+0.00001 to +999999 Number of decimal places: 0 to 5	1.00000 (*)	Specified in No. 3-15.	Specify the span of the flow velocity.
3-21	Device root menu ▶ Detailed setup ▶ Process variables ▶ Volume flow ▶ Volume flow span	Device setup ▶ Detailed setup ▶ Pro var ▶ Volume ▶ Span	RW	+0.00001 to +INF(**) Number of decimal places: 0 to 5	+0.00001 to +999999 Number of decimal places: 0 to 5	1.00000 (*)	Specified in No. 3-16 and No. 3-19.	Specify the span of the volumetric flow rate. Synchronized with No. 2-6. Specify the value equivalent to 1 m/s in case of no ordering information by user.
3-22	Device root menu ▶ Detailed setup ▶ Process variables ▶ Mass flow ▶ Mass flow span	Device setup ▶ Detailed setup ▶ Pro var ▶ Mass ▶ Span	RW	+0.00001 to +INF(**) Number of decimal places: 0 to 5	+0.00001 to +999999 Number of decimal places: 0 to 5	1.00000 (*)	Specified in No. 3-17 and No. 3-19. [kg/h]	Specify the span of the mass flow rate.
3-24	Device root menu ▶ Detailed setup ▶ Process variables ▶ Velocity check	Device setup ▶ Detailed setup ▶ Pro var ▶ Velocity check	R	-99.999 to +99.999 Number of decimal places: 3	-99.999 to +99.999 Number of decimal places: 3	-	m/s	Converts the process value PV-mapped in No. 3-14 to the span of the flow velocity, and displays the converted value.
3-25	Device root menu ▶ Detailed setup ▶ Userspan ▶ User span select AO1	Device setup ▶ Detailed setup ▶ UserSpan ▶ User span AO1 ▶ Select	RW	No Yes	No Yes	No	-	Used for current output of the I/O1 terminal. Specify whether the special unit can be set to the process value.
3-26	Device root menu ▶ Detailed setup ▶ Userspan ▶ UserunitAO1	Device setup ▶ Detailed setup ▶ UserSpan ▶ User span AO1 ▶ Unit	RW	ASCII 8 characters	ASCII 8 characters	All Space	-	Used for current output of the I/O1 terminal. Specify the special unit for the process value.
3-27	Device root menu ▶ Detailed setup ▶ Userspan ▶ UserspanAO1	Device setup ▶ Detailed setup ▶ UserSpan ▶ User span AO1 ▶ Span	RW	+0.00001 to +INF(**) Number of decimal places: 0 to 5	+0.00001 to +999999 Number of decimal places: 0 to 5	100.000	-	Used for current output of the I/O1 terminal. Specify the special unit span for the process value.
3-31	Device root menu ▶ Basic setup ▶ Autozero ▶ Autozero Exe	Device setup ▶ Diag/Service ▶ Autozero ▶ Execute	RW	Not execute Execute	Not execute Execute	Not execute	-	Specify whether to execute the zero adjustment function. Synchronized with No. 2-14.
3-32	Maintenance root menu ▶ Autozero ▶ Result ▶ Zero value	Device setup ▶ Diag/Service ▶ Autozero ▶ Result ▶ Zero value	RW	-99.999 to +99.999 Number of decimal places: 3	-99.999 to +99.999 Number of decimal places: 3	0.000	cm/s	Indicates the result of executing the zero adjustment function. Manual input is possible.

(*): Determined based on the information about specified items at the time of ordering and the sensor to be combined with.

(**): The range of single precision float (IEEE 754).

(4) Totalization configuration parameters

This list shows the parameters related to the totalization function.

No.	Name		Setting	Range		Default value	Unit	Description
	HART communication	Display		HART communication	Display			
4-1	Device root menu▶ Detailed setup▶ Totalizer▶ Totalizer1▶ Total1 unit	Device setup▶ Detailed setup▶ Totalizer▶ Totalizer 1▶ Unit	R	ML m ³ kL l(liter) cm ³ t kg g kcf cf mcf Mgal(US) kgal(US) gal(US) mgal(US) kbb(US Oil) bb(US Oil) mbbl(US Oil) ubbl(US Oil) kbb(US Beer) bb(US Beer) mbbl(US Beer) ubbl(US Beer) klb(US) lb(US)	MI(Megaliter) m ³ kl(kiloliter) l(liter) cm ³ t kg g kcf cf mcf Mgal(US) kgal(US) gal(US) mgal(US) kbb(US Oil) bb(US Oil) mbbl(US Oil) ubbl(US Oil) kbb(US Beer) bb(US Beer) mbbl(US Beer) ubbl(US Beer) klb(US) lb(US)	-	-	Indicates the unit of totalizer 1 (process value PV-mapped in No. 3-14).
4-2	Device root menu▶ Detailed setup▶ Totalizer▶ Totalizer1▶ Total1 conv factor	Device setup▶ Detailed setup▶ Totalizer▶ Totalizer 1▶ Conv factor	RW	0.00000 to +INF(**) Number of decimal places: 0 to 5	0.00000 to +999999 Number of decimal places: 0 to 5	1.00000 (*)	Synchronized with No. 4-1.	Specify the conversion factor for scaling totalizer 1.
4-3	Device root menu▶ Detailed setup▶ Totalizer▶ Totalizer1▶ Total1 low cut	Device setup▶ Detailed setup▶ Totalizer▶ Totalizer 1▶ Low cut	RW	0.00000 to +INF(**) Number of decimal places: 0 to 5	0.00000 to +999999 Number of decimal places: 0 to 5	0.00000 (*)	Volumetric flow rate: Specified in No. 3-16 and No. 3-19. Mass flow rate: Specified in No. 3-17 and No. 3-19.	Specify the low-cut value of totalizer 1.
4-4	Device root menu▶ Detailed setup▶ Totalizer▶ Totalizer1▶ Total1 fail opts	Device setup▶ Detailed setup▶ Totalizer▶ Totalizer 1▶ Failure opts	RW	Run Hold Last valid	Run Hold Last valid	Run	-	Specify the totalizer 1 operation to be performed when an alarm has activated. Run: Continues the totalization function after an alarm has activated. Hold: Stops the totalization function after an alarm has activated. Last valid: Continues the totalization function with the last valid value before an alarm activates.
4-5	Device root menu▶ Detailed setup▶ Totalizer▶ Totalizer1▶ Total1 options	Device setup▶ Detailed setup▶ Totalizer▶ Totalizer 1▶ Options	RW	Balanced Absolute Only positive Only negative Hold	Balanced Absolute Only positive Only negative Hold	Only positive	-	Specify the totalization direction of totalizer 1. Balanced: Totalizes the differential flow rate between the forward and reverse directions. Absolute: Totalizes the absolute value of the flow rate. Only positive: Totalizes only the flow rate in the forward direction. Only negative: Totalizes only the flow rate in the reverse direction. Hold: Stops totalization processing (holds the current totalized-value).
4-6	Device root menu▶ Detailed setup▶ Totalizer▶ Totalizer1▶ Total1 Start/Stop	Device setup▶ Detailed setup▶ Totalizer▶ Totalizer 1▶ Start/Stop	RW	Stop Start	Stop Start	Stop	-	Specify whether to execute the totalization function of totalizer 1.
4-7	Device root menu▶ Detailed setup▶ Totalizer▶ Totalizer1▶ Total1 Reset/Preset	Device setup▶ Detailed setup▶ Totalizer▶ Totalizer 1▶ Reset/Preset	RW	Not execute Reset Preset	Not execute Reset Preset	Not execute	-	Specify whether to execute the reset or preset function of totalizer 1.
4-8	Device root menu▶ Detailed setup▶ Totalizer▶ Totalizer1▶ Total1 preset value	Device setup▶ Detailed setup▶ Totalizer▶ Totalizer 1▶ Preset value	RW	-INF(**) to +INF(**) Number of decimal places: 0 to 5	-999999 to +999999 Number of decimal places: 0 to 5	0.00000	Volumetric flow rate: Specified in No. 3-16. Mass flow rate: Specified in No. 3-17.	Specify the preset value of totalizer 1.
4-9	Device root menu▶ Detailed setup▶ Totalizer▶ Totalizer1▶ Total1 set point	Device setup▶ Detailed setup▶ Totalizer▶ Totalizer 1▶ Set point	RW	0.00000 to +INF(**) Number of decimal places: 0 to 5	0.00000 to +999999 Number of decimal places: 0 to 5	0.00000	Volumetric flow rate: Specified in No. 3-16. Mass flow rate: Specified in No. 3-17.	Specify the target value at which the status output of totalizer 1 becomes active.

(*): Determined based on the information about specified items at the time of ordering and the sensor to be combined with.

(**): The range of single precision float (IEEE 754).

No.	Name		Setting	Range		Default value	Unit	Description
	HART communication	Display		HART communication	Display			
4-10	Device root menu ► Detailed setup ► Totalizer ► Totalizer2 ► Total2 unit	Device setup ► Detailed setup ► Totalizer ► Totalizer 2 ► Unit	RW	ML m ³ kL l(liter) cm ³ t kg g kcf cf mcf Mgal(US) kgal(US) gal(US) mgal(US) kbb(US Oil) bb(US Oil) mbb(US Oil) ubb(US Oil) kbb(US Beer) bb(US Beer) mbb(US Beer) ubb(US Beer) klb(US) lb(US)	l(Megaliter) m ³ kl(kiloliter) l(liter) cm ³ t kg g kcf cf mcf Mgal(US) kgal(US) gal(US) mgal(US) kbb(US Oil) bb(US Oil) mbb(US Oil) ubb(US Oil) kbb(US Beer) bb(US Beer) mbb(US Beer) ubb(US Beer) klb(US) lb(US)	m ³	-	Specify the unit of totalizer 2.
4-11	Device root menu ► Detailed setup ► Totalizer ► Totalizer2 ► Total2 conv factor	Device setup ► Detailed setup ► Totalizer ► Totalizer 2 ► Conv factor	RW	-INF(**) to +INF(**) Number of decimal places: 0 to 5	-999999 to +999999 Number of decimal places: 0 to 5	1.00000	Specified in No. 4-10.	Specify the conversion factor for scaling totalizer 2.
4-12	Device root menu ► Detailed setup ► Totalizer ► Totalizer2 ► Total2 low cut	Device setup ► Detailed setup ► Totalizer ► Totalizer 2 ► Low cut	RW	0.00000 to +INF(**) Number of decimal places: 0 to 5	0.00000 to +999999 Number of decimal places: 0 to 5	0.00000	Specified in No. 4-10 and No.3-19.	Specify the low-cut value of totalizer 2.
4-13	Device root menu ► Detailed setup ► Totalizer ► Totalizer2 ► Total2 fail opts	Device setup ► Detailed setup ► Totalizer ► Totalizer 2 ► Failure opts	RW	Run Hold Last valid	Run Hold Last valid	Run	-	Specify the totalizer 2 operation to be performed when an alarm has activated. Run: Continues the totalization function after an alarm has activated. Hold: Stops the totalization function after an alarm has activated. Last valid: Continues the totalization function with the last valid value before an alarm activates.
4-14	Device root menu ► Detailed setup ► Totalizer ► Totalizer2 ► Total2 options	Device setup ► Detailed setup ► Totalizer ► Totalizer 2 ► Options	RW	Balanced Absolute Only positive Only negative Hold	Balanced Absolute Only positive Only negative Hold	Only negative	-	Specify the totalization direction of totalizer 2. Balanced: Totalizes the differential flow rate between the forward and reverse directions. Absolute: Totalizes the absolute value of the flow rate. Only positive: Totalizes only the flow rate in the forward direction. Only negative: Totalizes only the flow rate in the reverse direction. Hold: Stops totalization processing (holds the current totalized-value).
4-15	Device root menu ► Detailed setup ► Totalizer ► Totalizer2 ► Total2 Start/Stop	Device setup ► Detailed setup ► Totalizer ► Totalizer 2 ► Start/Stop	RW	Stop Start	Stop Start	Stop	-	Specify whether to execute the totalization function of totalizer 2.
4-16	Device root menu ► Detailed setup ► Totalizer ► Totalizer2 ► Total2 Reset/Preset	Device setup ► Detailed setup ► Totalizer ► Totalizer 2 ► Reset/Preset	RW	Not execute Reset Preset	Not execute Reset Preset	Not execute	-	Specify whether to execute the reset or preset function of totalizer 2.
4-17	Device root menu ► Detailed setup ► Totalizer ► Totalizer2 ► Total2 preset value	Device setup ► Detailed setup ► Totalizer ► Totalizer 2 ► Preset value	RW	-INF(**) to +INF(**) Number of decimal places: 0 to 5	-999999 to +999999 Number of decimal places: 0 to 5	0.00000	Specified in No. 4-10.	Specify the preset value of totalizer 2.
4-18	Device root menu ► Detailed setup ► Totalizer ► Totalizer2 ► Total2 set point	Device setup ► Detailed setup ► Totalizer ► Totalizer 2 ► Set point	RW	0.00000 to +INF(**) Number of decimal places: 0 to 5	0.00000 to +999999 Number of decimal places: 0 to 5	0.00000	Specified in No. 4-10.	Specify the target value at which the status output of totalizer 2 becomes active.

(*): Determined based on the information about specified items at the time of ordering and the sensor to be combined with.

(**): The range of single precision float (IEEE 754).

No.	Name		Setting	Range		Default value	Unit	Description
	HART communication	Display		HART communication	Display			
4-19	Device root menu ► Detailed setup ► Totalizer ► Totalizer3 ► Total3 unit	Device setup ► Detailed setup ► Totalizer ► Totalizer 3 ► Unit	RW	ML m ³ kL l(liter) cm ³ t kg g kcf cf mcf Mgal(US) kgal(US) gal(US) mgal(US) kbb(US Oil) bb(US Oil) mbb(US Oil) ubbl(US Oil) kbb(US Beer) bb(US Beer) mbb(US Beer) ubbl(US Beer) klb(US) lb(US)	Ml(Megaliter) m ³ kl(kiloliter) l(liter) cm ³ t kg g kcf cf mcf Mgal(US) kgal(US) gal(US) mgal(US) kbb(US Oil) bb(US Oil) mbb(US Oil) ubbl(US Oil) kbb(US Beer) bb(US Beer) mbb(US Beer) ubbl(US Beer) klb(US) lb(US)	m ³	-	Specify the unit of totalizer 3.
4-20	Device root menu ► Detailed setup ► Totalizer ► Totalizer3 ► Total3 conv factor	Device setup ► Detailed setup ► Totalizer ► Totalizer 3 ► Conv factor	RW	-INF(**) to +INF(**) Number of decimal places: 0 to 5	-999999 to +999999 Number of decimal places: 0 to 5	1.00000	Specified in No. 4-19.	Specify the conversion factor for scaling totalizer 3.
4-21	Device root menu ► Detailed setup ► Totalizer ► Totalizer3 ► Total3 low cut	Device setup ► Detailed setup ► Totalizer ► Totalizer 3 ► Low cut	RW	0.00000 to +INF(**) Number of decimal places: 0 to 5	0.00000 to +999999 Number of decimal places: 0 to 5	0.00000	Specified in No. 4-19 and No.3-19.	Specify the low-cut value of totalizer 3.
4-22	Device root menu ► Detailed setup ► Totalizer ► Totalizer3 ► Total3 fail opts	Device setup ► Detailed setup ► Totalizer ► Totalizer 3 ► Failure opts	RW	Run Hold Last valid	Run Hold Last valid	Run	-	Specify the totalizer 3 operation to be performed when an alarm has activated. Run: Continues the totalization function after an alarm has activated. Hold: Stops the totalization function after an alarm has activated. Last valid: Continues the totalization function with the last valid value before an alarm activates.
4-23	Device root menu ► Detailed setup ► Totalizer ► Totalizer3 ► Total3 options	Device setup ► Detailed setup ► Totalizer ► Totalizer 3 ► Options	RW	Balanced Absolute Only positive Only negative Hold	Balanced Absolute Only positive Only negative Hold	Balanced	-	Specify the totalization direction of totalizer 3. Balanced: Totalizes the differential flow rate between the forward and reverse directions. Absolute: Totalizes the absolute value of the flow rate. Only positive: Totalizes only the flow rate in the forward direction. Only negative: Totalizes only the flow rate in the reverse direction. Hold: Stops totalization processing (holds the current totalized-value).
4-24	Device root menu ► Detailed setup ► Totalizer ► Totalizer3 ► Total3 Start/Stop	Device setup ► Detailed setup ► Totalizer ► Totalizer 3 ► Start/Stop	RW	Stop Start	Stop Start	Stop	-	Specify whether to execute the totalization function of totalizer 3.
4-25	Device root menu ► Detailed setup ► Totalizer ► Totalizer3 ► Total3 Reset/Preset	Device setup ► Detailed setup ► Totalizer ► Totalizer 3 ► Reset/Preset	RW	Not execute Reset Preset	Not execute Reset Preset	Not execute	-	Specify whether to execute the reset or preset function of totalizer 3.
4-26	Device root menu ► Detailed setup ► Totalizer ► Totalizer3 ► Total3 preset value	Device setup ► Detailed setup ► Totalizer ► Totalizer 3 ► Preset value	RW	-INF(**) to +INF(**) Number of decimal places: 0 to 5	-999999 to +999999 Number of decimal places: 0 to 5	0.00000	Specified in No. 4-19.	Specify the preset value of totalizer 3.
4-27	Device root menu ► Detailed setup ► Totalizer ► Totalizer3 ► Total3 set point	Device setup ► Detailed setup ► Totalizer ► Totalizer 3 ► Set point	RW	0.00000 to +INF(**) Number of decimal places: 0 to 5	0.00000 to +999999 Number of decimal places: 0 to 5	0.00000	Specified in No. 4-19.	Specify the target value at which the status output of totalizer 3 becomes active.

(*): Determined based on the information about specified items at the time of ordering and the sensor to be combined with.

(**): The range of single precision float (IEEE 754).

(5) Pulse output configuration parameters

This list shows the parameters related to the frequency output or pulse output of the I/O2 terminal, and I/O4 terminal.

No.	Name		Setting	Range		Default value	Unit	Description
	HART communication	Display		HART communication	Display			
5-1	Device root menu▶ Detailed setup▶ Pulse/Status▶ Pulse/Status output 1▶ Pulse1 output mode	Device setup▶ Detailed setup▶ Pulse/Status out▶ PO1/SO1▶ Output mode	RW	No function Fixed pulse Frequency output Status output	No function Fixed pulse output Frequency output Status output	Fixed pulse	-	Specify the output of the I/O2 terminal. No function: No output Fixed pulse: Fixed pulse output Frequency output: Frequency output (Duty 50%) Status output: Status output
5-2	Device root menu▶ Detailed setup▶ Pulse/Status▶ Pulse/Status output 1▶ Pulse1 active mode	Device setup▶ Detailed setup▶ Pulse/Status out▶ PO1/SO1▶ Active mode	RW	On active Off active	On active Off active	On active	-	Used for pulse output of the I/O2 terminal. Specify the active direction of the pulse signal.
5-3	Device root menu▶ Detailed setup▶ Pulse/Status▶ Pulse/Status output 1▶ Pulse1 fix width	Device setup▶ Detailed setup▶ Pulse/Status out▶ PO1/SO1▶ Fix width	RW	0.05 ms 0.1 ms 0.5 ms 1 ms 20 ms 33 ms 50 ms 100 ms 200 ms 330 ms 500 ms 1000 ms 2000 ms	0.05 ms 0.1 ms 0.5 ms 1 ms 20 ms 33 ms 50 ms 100 ms 200 ms 330 ms 500 ms 1000 ms 2000 ms	0.05 ms	-	Used for pulse output of the I/O2 terminal. Specify the pulse width.
5-4	Device root menu▶ Detailed setup▶ Pulse/Status▶ Pulse/Status output 1▶ Pulse1 rate unit	Device setup▶ Detailed setup▶ Pulse/Status out▶ PO1/SO1▶ Rate unit	RW	n unit/P u unit/P m unit/P Unit/P k unit/P M unit/P n P/unit u P/unit m P/unit P/unit k P/unit M P/unit	n unit/P u unit/P m unit/P Unit/P k unit/P M unit/P n P/unit u P/unit m P/unit P/unit k P/unit M P/unit	Unit/P (*)	-	Used for pulse output of the I/O2 terminal. Specify the pulse rate scaling. Synchronized with No. 2-7.
5-5	Device root menu▶ Detailed setup▶ Pulse/Status▶ Pulse/Status output 1▶ Pulse1 rate value	Device setup▶ Detailed setup▶ Pulse/Status out▶ PO1/SO1▶ Rate value	RW	0.00000 to +INF(**) Number of decimal places: 0 to 5	0.00000 to +999999 Number of decimal places: 0 to 5	0.0 (*)	Specified in No. 5-4.	Used for pulse output of the I/O2 terminal. Specify the pulse rate value. Synchronized with No. 2-8.
5-6	Device root menu▶ Detailed setup▶ Pulse/Status▶ Pulse/Status output 1▶ Pulse1 low cut	Device setup▶ Detailed setup▶ Pulse/Status out▶ PO1/SO1▶ Low cut	RW	0.00000 to +INF(**) Number of decimal places: 0 to 5	0.00000 to +999999 Number of decimal places: 0 to 5	0.0	Flow velocity: Specified in No. 3-15. Volumetric flow rate: Specified in No. 3-16 and No. 3-19. Mass flow rate: Specified in No. 3-17 and No. 3-19.	Used for frequency output or pulse output of the I/O2 terminal. Specify the low-cut value.
5-7	Device root menu▶ Detailed setup▶ Pulse/Status▶ Pulse/Status output 1▶ Pulse1 alarm out	Device setup▶ Detailed setup▶ Pulse/Status out▶ PO1/SO1▶ Alarm out	RW	0 pps Measured value Hold Max pps	0 pps Measured value Hold Max pps	0 pps	-	Used for frequency output or pulse output of the I/O2 terminal. Specify the output operation to be performed when an alarm has activated. 0 pps: No output Measured value: Outputs the frequency or pulse with the measured value. Hold: Outputs the frequency or pulse with the last valid value before an alarm activates. Max pps: Outputs the frequency or pulse at 12500 pps.
5-8	Device root menu▶ Detailed setup▶ Pulse/Status▶ Pulse/Status output 1▶ Frequency1 at 0%	Device setup▶ Detailed setup▶ Pulse/Status out▶ PO1/SO1▶ Frequency at 0%	RW	0 to 12500 Number of decimal places: 0	0 to 12500 Number of decimal places: 0	0	Hz	Used for frequency output of the I/O2 terminal. Specify the frequency that is available when 0% is set to the process value PV-mapped in No. 3-14. Synchronized with No. 2-9.
5-9	Device root menu▶ Detailed setup▶ Pulse/Status▶ Pulse/Status output 1▶ Frequency1 at 100%	Device setup▶ Detailed setup▶ Pulse/Status out▶ PO1/SO1▶ Frequency at 100%	RW	0 to 12500 Number of decimal places: 0	0 to 12500 Number of decimal places: 0	0	Hz	Used for frequency output of the I/O2 terminal. Specify the frequency that is available when 100% is set to the process value PV-mapped in No. 3-14. Synchronized with No. 2-10.

(*): Determined based on the information about specified items at the time of ordering and the sensor to be combined with.

(**): The range of single precision float (IEEE 754).

No.	Name		Setting	Range		Default value	Unit	Description
	HART communication	Display		HART communication	Display			
5-10	Device root menu ▶ Detailed setup ▶ Pulse/Status ▶ Pulse/Status output 1 ▶ Status output1 function	Device setup ▶ Detailed setup ▶ Pulse/Status out ▶ PO1/SO1 ▶ SO1 function	RW	No function Alarm output Warning output Total limit 1 Total limit 2 Total limit 3 H/L alarm HH/LL alarm Fwd/Rev range Auto2 range Ext2 answer	No function Alarm output Warning output Total limit 1 Total limit 2 Total limit 3 H/L alarm HH/LL alarm Fwd/Rev range Auto2 range Ext2 answer	No function	-	Specify the status output function of the I/O2 terminal. No function: No output Alarm output: The status output becomes active when an alarm activates. Warning output: The status output becomes active when a warning occurs. Total limit 1: The status output is active while the totalized value of totalizer 1 is exceeding the target value. Total limit 2: The status output is active while the totalized value of totalizer 2 is exceeding the target value. Total limit 3: The status output is active while the totalized value of totalizer 3 is exceeding the target value. H/L alarm: The status output is active while the process value PV-mapped in No. 3-14 is out of the low limit value or high limit value. HH/LL alarm: The status output is active while the process value PV-mapped in No. 3-14 is out of the low-low limit value or high-high limit value. Fwd/Rev range: The status output is active while the fluid is flowing in the reverse direction. Auto2 range: The status output is active while operation is being performed in range 2. Ext2 answer: The status output becomes active depending on the range used for the status input.
5-11	Device root menu ▶ Detailed setup ▶ Pulse/Status ▶ Pulse/Status output 2 ▶ Pulse2 active pulse	Device setup ▶ Detailed setup ▶ Pulse/Status out ▶ PO2/SO2 ▶ Active pulse	RW	Normal Magnetic counter	Normal For magnetic counter	Normal	-	Used for pulse output of the I/O4 terminal. Specify whether to enable or disable the output for the magnetic counter. Normal: Normal output Magnetic counter: Output for magnetic counter
5-12	Device root menu ▶ Detailed setup ▶ Pulse/Status ▶ Pulse/Status output 2 ▶ Pulse2 output mode	Device setup ▶ Detailed setup ▶ Pulse/Status out ▶ PO2/SO2 ▶ Output mode	RW	No function Fixed pulse Frequency output Status output	No function Fixed pulse output Frequency output Status output	No function	-	Specify the output of the I/O4 terminal. No function: No output Fixed pulse: Fixed pulse output Frequency output: Frequency output (Duty 50%) Status output: Status output
5-13	Device root menu ▶ Detailed setup ▶ Pulse/Status ▶ Pulse/Status output 2 ▶ Pulse2 select	Device setup ▶ Detailed setup ▶ Pulse/Status out ▶ PO2/SO2 ▶ Pulse select	RW	Non-Connect Velocity Volume flow Mass flow	Non-Connect Velocity Volume flow Mass flow	Non-Connect	-	Specify the process value to be output through the I/O4 terminal. Non-Connect: No output Velocity: Sets the flow velocity to the output. Volume flow: Sets the volumetric flow rate to the output. Mass flow: Sets the mass flow rate to the output.
5-14	Device root menu ▶ Detailed setup ▶ Pulse/Status ▶ Pulse/Status output 2 ▶ Pulse2 active mode	Device setup ▶ Detailed setup ▶ Pulse/Status out ▶ PO2/SO2 ▶ Active mode	RW	On active Off active	On active Off active	On active	-	Used for pulse output of the I/O4 terminal. Specify the active direction of the pulse signal.
5-15	Device root menu ▶ Detailed setup ▶ Pulse/Status ▶ Pulse/Status output 2 ▶ Pulse2 fix width	Device setup ▶ Detailed setup ▶ Pulse/Status out ▶ PO2/SO2 ▶ Fix width	RW	0.05 ms 0.1 ms 0.5 ms 1 ms 20 ms 33 ms 50 ms 100 ms 200 ms 330 ms 500 ms 1000 ms 2000 ms	0.05 ms 0.1 ms 0.5 ms 1 ms 20 ms 33 ms 50 ms 100 ms 200 ms 330 ms 500 ms 1000 ms 2000 ms	0.05 ms	-	Used for pulse output of the I/O4 terminal. Specify the pulse width.
5-16	Device root menu ▶ Detailed setup ▶ Pulse/Status ▶ Pulse/Status output 2 ▶ Pulse2 rate unit	Device setup ▶ Detailed setup ▶ Pulse/Status out ▶ PO2/SO2 ▶ Rate unit	RW	n unit/P u unit/P m unit/P Unit/P k unit/P M unit/P n P/unit u P/unit m P/unit P/unit k P/unit M P/unit	n unit/P u unit/P m unit/P Unit/P k unit/P M unit/P n P/unit u P/unit m P/unit P/unit k P/unit M P/unit	Unit/P	-	Used for pulse output of the I/O4 terminal. Specify the pulse rate scaling.
5-17	Device root menu ▶ Detailed setup ▶ Pulse/Status ▶ Pulse/Status output 2 ▶ Pulse2 rate value	Device setup ▶ Detailed setup ▶ Pulse/Status out ▶ PO2/SO2 ▶ Rate value	RW	0.00000 to +INF(**) Number of decimal places: 0 to 5	0.00000 to +999999 Number of decimal places: 0 to 5	0.0	Specified in No. 5-16.	Used for pulse output of the I/O4 terminal. Specify the pulse rate value.

(*): Determined based on the information about specified items at the time of ordering and the sensor to be combined with.

(**): The range of single precision float (IEEE 754).

No.	Name		Setting	Range		Default value	Unit	Description
	HART communication	Display		HART communication	Display			
5-18	Device root menu ▶ Detailed setup ▶ Pulse/Status ▶ Pulse/Status output 2 ▶ Pulse2 low cut	Device setup ▶ Detailed setup ▶ Pulse/Status out ▶ PO2/SO2 ▶ Low cut	RW	0.00000 to +INF(**) Number of decimal places: 0 to 5	0.00000 to +999999 Number of decimal places: 0 to 5	0.0	Flow velocity: Specified in No. 3-15. Volumetric flow rate: Specified in No. 3-16 and No. 3-19. Mass flow rate: Specified in No. 3-17 and No. 3-19.	Used for frequency output and pulse output of the I/O4 terminal. Specify the low-cut value.
5-19	Device root menu ▶ Detailed setup ▶ Pulse/Status ▶ Pulse/Status output 2 ▶ Pulse2 alarm out	Device setup ▶ Detailed setup ▶ Pulse/Status out ▶ PO2/SO2 ▶ Alarm out	RW	0 pps Measured value Hold Max pps	0 pps Measured value Hold Max pps	0 pps	-	Used for frequency output and pulse output of the I/O4 terminal. Specify the output operation to be performed when an alarm has activated. 0 pps: No output Measured value: Outputs the frequency or pulse with the measured value. Hold: Outputs the frequency or pulse with the last valid value before an alarm activates. Max pps: Outputs the frequency or pulse at 12500 pps.
5-20	Device root menu ▶ Detailed setup ▶ Pulse/Status ▶ Pulse/Status output 2 ▶ Frequency2 at 0%	Device setup ▶ Detailed setup ▶ Pulse/Status out ▶ PO2/SO2 ▶ Frequency at 0%	RW	0 to 12500 Number of decimal places: 0	0 to 12500 Number of decimal places: 0	0	Hz	Used for frequency output of the I/O4 terminal. Specify the frequency that is available when 0% is set to the process value mapped in No. 5-13.
5-21	Device root menu ▶ Detailed setup ▶ Pulse/Status ▶ Pulse/Status output 2 ▶ Frequency2 at 100%	Device setup ▶ Detailed setup ▶ Pulse/Status out ▶ PO2/SO2 ▶ Frequency at 100%	RW	0 to 12500 Number of decimal places: 0	0 to 12500 Number of decimal places: 0	0	Hz	Used for frequency output of the I/O4 terminal. Specify the frequency that is available when 100% is set to the process value mapped in No. 5-13.
5-22	Device root menu ▶ Detailed setup ▶ Pulse/Status ▶ Pulse/Status output 2 ▶ Status output2 function	Device setup ▶ Detailed setup ▶ Pulse/Status out ▶ PO2/SO2 ▶ SO2 function	RW	No function Alarm output Warning output Total limit 1 Total limit 2 Total limit 3 H/L alarm HH/LL alarm Fwd/Rev range Auto2 range Ext2 answer	No function Alarm output Warning output Total limit 1 Total limit 2 Total limit 3 H/L alarm HH/LL alarm Fwd/Rev range Auto2 range Ext2 answer	No function	-	Specify the status output function of the I/O4 terminal. No function: No output Alarm output: The status output becomes active when an alarm activates. Warning output: The status output becomes active when a warning occurs. Total limit 1: The status output is active while the totalized value of totalizer 1 is exceeding the target value. Total limit 2: The status output is active while the totalized value of totalizer 2 is exceeding the target value. Total limit 3: The status output is active while the totalized value of totalizer 3 is exceeding the target value. H/L alarm: The status output is active while the process value PV-mapped in No. 3-14 is out of the low limit value or high limit value. HH/LL alarm: The status output is active while the process value PV-mapped in No. 3-14 is out of the low-low limit value or high-high limit value. Fwd/Rev range: The status output is active while the fluid is flowing in the reverse direction. Auto2 range: The status output is active while operation is being performed in range 2. Ext2 answer: The status output becomes active depending on the range used for the status input.

(*): Determined based on the information about specified items at the time of ordering and the sensor to be combined with.

(**): The range of single precision float (IEEE 754).

(6) Status input configuration parameters

This list shows the parameters related to the status input of the I/O3 terminal, and multi range.

No.	Name		Setting	Range		Default value	Unit	Description
	HART communication	Display		HART communication	Display			
6-3	Device root menu ► Detailed setup ► Pulse/Status ► Statusinput3 ► Status input3 active mode	Device setup ► Detailed setup ► Status in ► SI3 ► Active mode	RW	Short(On) act Open(Off) act	Short(On) act Open(Off) act	Short(On) act	-	Used for status input of the I/O3 terminal. Specify the active direction of the target signal. Short(On) act: Active when short-circuited. Open(Off) act: Active when opened.
6-4	Device root menu ► Detailed setup ► Pulse/Status ► Status input 3 ► Status input3 function	Device setup ► Detailed setup ► Status in ► SI3 ► Function	RW	No function 0% Signal Lock Ext auto zero Total preset 1 Total preset 2 Total preset 3 Ext2 ranges	No function 0% Signal Lock Ext auto zero Total preset 1 Total preset 2 Total preset 3 Ext2 ranges	No function	-	Select the status input function of the I/O3 terminal. No function: No input 0% Signal Lock: When the status input becomes active, the current output of the I/O1 terminal is fixed to 4 mA. Ext auto zero: When the status input becomes active, the zero-adjustment function is performed. Total preset 1: When the status input becomes active, the preset value is set to totalizer 1, and totalization starts based on the value. Total preset 2: When the status input becomes active, the preset value is set to totalizer 2, and totalization starts based on the value. Total preset 3: When the status input becomes active, the preset value is set to totalizer 3, and totalization starts based on the value. Ext2 ranges: When the status input becomes active, the current output range is switched from range 1 to range 2.
6-5	Device root menu ► Detailed setup ► Pulse/Status ► Status input 3 ► Status input3 state	Device setup ► Detailed setup ► Status in ► SI3 ► Status	R	Open Short	Open Short	-	-	Used for status input of the I/O3 terminal. Indicates the terminal status.
6-6	Device root menu ► Detailed setup ► Multirange ► Forwardspan2	Device setup ► Detailed setup ► Multirange ► Forward span2	RW	0.00001 to +INF(**) Number of decimal places: 0 to 5	0.00001 to +999999 Number of decimal places: 0 to 5	1.0	Flow velocity: Specified in No. 3-15. Volumetric flow rate: Specified in No. 3-16 and No. 3-19. Mass flow rate: Specified in No. 3-17 and No. 3-19.	Used for multi range. Specify the value of forward range 2.
6-7	Device root menu ► Detailed setup ► Multirange ► Reversespan1	Device setup ► Detailed setup ► Multirange ► Reverse span 1	RW	0.00001 to +INF(**) Number of decimal places: 0 to 5	0.00001 to +999999 Number of decimal places: 0 to 5	1.0	Flow velocity: Specified in No. 3-15. Volumetric flow rate: Specified in No. 3-16 and No. 3-19. Mass flow rate: Specified in No. 3-17 and No. 3-19.	Used for multi range. Specify the value of reverse range 1.
6-8	Device root menu ► Detailed setup ► Multirange ► Reversespan2	Device setup ► Detailed setup ► Multirange ► Reverse span2	RW	0.00001 to +INF(**) Number of decimal places: 0 to 5	0.00001 to +999999 Number of decimal places: 0 to 5	1.0	Flow velocity: Specified in No. 3-15. Volumetric flow rate: Specified in No. 3-16 and No. 3-19. Mass flow rate: Specified in No. 3-17 and No. 3-19.	Used for multi range. Specify the value of reverse range 2.
6-9	Device root menu ► Detailed setup ► Multirange ► Autorangehyst	Device setup ► Detailed setup ► Multirange ► Auto range hyst	RW	0 to 15 Number of decimal places: 0	0 to 15 Number of decimal places: 0	10	%	Used for multi range. Specify the range switching hysteresis.
6-10	Device root menu ► Detailed setup ► Multirange ► Bidirectionhyst	Device setup ► Detailed setup ► Multirange ► Bi direction hyst	RW	0 to 8 Number of decimal places: 0	0 to 8 Number of decimal places: 0	2	%	Used for forward and reverse ranges. Specify the range switching hysteresis.

(**): The range of single precision float (IEEE 754).

(7) Display parameters

This list shows the parameters related to the current output of the I/O1 terminal.

No.	Name		Setting	Range		Default value	Unit	Description
	HART communication	Display		HART communication	Display			
7-1	Device root menu▶ Detailed setup▶ Analog output/input▶ Analog output 1▶ AO1 low cut	Device setup▶ Detailed setup▶ Analog out/in▶ AO1▶ Low cut	RW	0.00000 to +INF(**) Number of decimal places: 0 to 5	0.00000 to +999999 Number of decimal places: 0 to 5	0.0	Flow velocity: Specified in No. 3-15. Volumetric flow rate: Specified in No. 3-16 and No. 3-19. Mass flow rate: Specified in No. 3-17 and No. 3-19.	Used for current output of the I/O1 terminal. Specify the low-cut value.
7-2	Device root menu▶ Detailed setup▶ Analog output/input▶ Analog output 1▶ AO1 high limit	Device setup▶ Detailed setup▶ Analog out/in▶ AO1▶ High limit	RW	+4.0 to +21.6 Number of decimal places: 3	+4.000 to +21.600 Number of decimal places: 3	20.500	mA	Used for current output of the I/O1 terminal. Specify the high limit value of the current.
7-3	Device root menu▶ Detailed setup▶ Analog output/input▶ Analog output 1▶ AO1 low limit	Device setup▶ Detailed setup▶ Analog out/in▶ AO1▶ Low limit	RW	+2.4 to +20.0 Number of decimal places: 3	+2.400 to +20.000 Number of decimal places: 3	3.800	mA	Used for current output of the I/O1 terminal. Specify the low limit value of the current.
7-4	Device root menu▶ Detailed setup▶ Analog output/input▶ Analog output 1▶ AO1 alarm out	Device setup▶ Detailed setup▶ Analog out/in▶ AO1▶ Alarm out	RW	< 2.4 mA 3.8 mA 4 mA 20.5 mA > 21.6 mA Measured value Hold	< 2.4 mA 3.8 mA 4 mA 20.5 mA > 21.6 mA Measured value Hold	> 21.6 mA	-	Used for current output of the I/O1 terminal. Specify the current output that is available when an alarm has activated. < 2.4 mA: Outputs the lower current than 2.4 mA. 3.8 mA: Outputs the current of 3.8 mA. 4 mA: Outputs the current of 4 mA. 20.5 mA: Outputs the current of 20.5 mA. > 21.6 mA: Outputs the higher current than 21.6 mA. Measured value: Outputs the measured current value (indefinite). Hold: Outputs the current that is applied when an alarm has activated.
7-5	Device root menu▶ Detailed setup▶ Analog output/input▶ Analog output 1▶ AO1 range mode	Device setup▶ Detailed setup▶ Analog out/in▶ AO1▶ Range mode	RW	Normal range Abs range	Normal range Abs range	Normal range	-	Specify whether to execute the absolute range function. Normal range: Normal range Abs range: Absolute range
7-18	Maintenance root menu▶ AO/AI trim▶ AO trim▶ Clear D/A trim 1	Device setup▶ Diag/Service▶ AO/AI trim▶ AO trim▶ AO1 trim clear	RW	Not execute Execute	Not execute Execute	Not execute	-	Used for current output of the I/O1 terminal. Clears the adjustment value to output the current.
7-19	Maintenance root menu▶ AO/AI trim▶ AO trim▶ AO1 Trim	Device setup▶ Diag/Service▶ AO/AI trim▶ AO trim▶ AO1 trim 4 mA	RW	3.200 to 5.600 Number of decimal places: 3	3.200 to 5.600 Number of decimal places: 3	4.000	mA	Used for current output of the I/O1 terminal. Specify the adjustment value to output the current with 4 mA.
7-20		Device setup▶ Diag/Service▶ AO/AI trim▶ AO trim▶ AO1 trim 20 mA	RW	18.400 to 21.600 Number of decimal places: 3	18.400 to 21.600 Number of decimal places: 3	20.000	mA	Used for current output of the I/O1 terminal. Specify the adjustment value to output the current with 20 mA.

(**): The range of single precision float (IEEE 754).

(8) Auxiliary function configuration parameters

This list shows the parameters related to the flow rate direction, rate limit, and low-cut value.

No.	Name		Setting	Range		Default value	Unit	Description
	HART communication	Display		HART communication	Display			
8-1	Device root menu ▶ Detailed setup ▶ AUX calculation ▶ Flow direction	Device setup ▶ Detailed setup ▶ AUX calculation ▶ Flow direct	RW	Forward Reverse	Forward Reverse	Forward	-	Specify the fluid flow direction.
8-2	Device root menu ▶ Detailed setup ▶ AUX calculation ▶ Rate limit	Device setup ▶ Detailed setup ▶ AUX calculation ▶ Rate limit	RW	0.0 to 10.0 Number of decimal places: 1	0.0 to 10.0 Number of decimal places: 1	5.0	%	Specify the rate limit value.
8-3	Device root menu ▶ Detailed setup ▶ AUX calculation ▶ Dead time	Device setup ▶ Detailed setup ▶ AUX calculation ▶ Dead time	RW	0.0 to 15.0 Number of decimal places: 1	0.0 to 15.0 Number of decimal places: 1	0.0	s	Specify the dead time.
8-4	Device root menu ▶ Detailed setup ▶ AUX calculation ▶ Noise filter	Device setup ▶ Detailed setup ▶ AUX calculation ▶ Noise filter	RW	Manual Level1 Level2 Level3	Manual Level1 Level2 Level3	Manual	-	Specify the noise filter (rate limit value and dead time).
8-5	Device root menu ▶ Detailed setup ▶ AUX calculation ▶ Pulsing flow	Device setup ▶ Detailed setup ▶ AUX calculation ▶ Pulsing flow	RW	No Yes	No Yes	No	-	Specify whether to execute the pulsing flow support function.
8-6	Device root menu ▶ Detailed setup ▶ AUX calculation ▶ Power synchronize	Device setup ▶ Detailed setup ▶ AUX calculation ▶ Power sync	RW	No Yes	No Yes	Yes	-	Specify whether the excitation frequency and power frequency are synchronous or asynchronous.
8-7	Device root menu ▶ Detailed setup ▶ AUX calculation ▶ Set power frequency	Device setup ▶ Detailed setup ▶ AUX calculation ▶ Set power freq	RW	47.00 to 63.00 Number of decimal places: 2	47.00 to 63.00 Number of decimal places: 2	50.00	Hz	When the excitation frequency and power frequency are asynchronous, specify the power frequency that synchronizes with the excitation frequency. (The default value is set as 49.00 for 500 mm (16 in.) or larger sizes.)
8-8	Device root menu ▶ Detailed setup ▶ AUX calculation ▶ IEX power frequency	Device setup ▶ Detailed setup ▶ AUX calculation ▶ IEX power frequency	R	0.00 to 99.99 Number of decimal places: 2	0.00 to 99.99 Number of decimal places: 2	-	Hz	Indicates the power frequency that synchronizes with the excitation frequency.
8-9	Device root menu ▶ Detailed setup ▶ AUX calculation ▶ Mes power frequency	Device setup ▶ Detailed setup ▶ AUX calculation ▶ Mes power freq	R	0.00 to 99.99 Number of decimal places: 2	0.00 to 99.99 Number of decimal places: 2	-	Hz	Indicates the measured value of the power frequency. For the DC power, this parameter indicates "0.00 Hz".
8-11	Device root menu ▶ Detailed setup ▶ Process variables ▶ Density ▶ Density unit	Device setup ▶ Detailed setup ▶ Pro var ▶ Density ▶ Unit	RW	kg/m ³ lb/gal lb/cf	kg/m ³ lb/gal lb/cf	kg/m ³	-	Specify the unit of the density.
8-12	Device root menu ▶ Detailed setup ▶ Process variables ▶ Density ▶ Density fixed value	Device setup ▶ Detailed setup ▶ Pro var ▶ Density ▶ Fixed density	RW	0.00000 to 999999 Number of decimal places: 0 to 5	0.00000 to 999999 Number of decimal places: 0 to 5	0 (*)	Specified in No. 8-11.	Specify the density value.
8-22	Device root menu ▶ Detailed setup ▶ AUX calculation ▶ Set SIL	Device setup ▶ Detailed setup ▶ AUX calculation ▶ Set SIL	RW	No Yes	No Yes	No	-	Specify the current output for Safety Instrumented System application. Synchronized with No. 7-4.

(*): Determined based on the information about specified items at the time of ordering and the sensor to be combined with.

(9) Alarm configuration parameters

This list shows the parameters related to alarm output, burnout, and history.

No.	Name		Setting	Range		Default value	Unit	Description
	HART communication	Display		HART communication	Display			
9-1	Maintenance root menu ► High/Low alarm configuration ► High alarm	Device setup ► Diag/Service ► H/L alarm cfg ► High alarm	RW	-INF(**) to +INF(**) Number of decimal places: 1 to 5	-999999 to +999999 Number of decimal places: 1 to 5	300.000	Flow velocity: Specified in No. 3-15. Volumetric flow rate: Specified in No. 3-16 and No. 3-19. Mass flow rate: Specified in No. 3-17 and No. 3-19.	Specify the high limit value to judge an alarm.
9-2	Maintenance root menu ► High/Low alarm configuration ► Low alarm	Device setup ► Diag/Service ► H/L alarm cfg ► Low alarm	RW	-INF(**) to +INF(**) Number of decimal places: 1 to 5	-999999 to +999999 Number of decimal places: 1 to 5	-300.000	Flow velocity: Specified in No. 3-15. Volumetric flow rate: Specified in No. 3-16 and No. 3-19. Mass flow rate: Specified in No. 3-17 and No. 3-19.	Specify the high limit value to judge an alarm.
9-3	Maintenance root menu ► High/Low alarm configuration ► High high alarm	Device setup ► Diag/Service ► H/L alarm cfg ► HH alarm	RW	-INF(**) to +INF(**) Number of decimal places: 1 to 5	-999999 to +999999 Number of decimal places: 1 to 5	300.000	Flow velocity: Specified in No. 3-15. Volumetric flow rate: Specified in No. 3-16 and No. 3-19. Mass flow rate: Specified in No. 3-17 and No. 3-19.	Specify the high limit value to judge an alarm.
9-4	Maintenance root menu ► High/Low alarm configuration ► Low low alarm	Device setup ► Diag/Service ► H/L alarm cfg ► LL alarm	RW	-INF(**) to +INF(**) Number of decimal places: 1 to 5	-999999 to +999999 Number of decimal places: 1 to 5	-300.000	Flow velocity: Specified in No. 3-15. Volumetric flow rate: Specified in No. 3-16 and No. 3-19. Mass flow rate: Specified in No. 3-17 and No. 3-19.	Specify the high limit value to judge an alarm.
9-5	Maintenance root menu ► High/Low alarm configuration ► Hi/Lo alarm hysteresis	Device setup ► Diag/Service ► H/L alarm cfg ► H/L alarm hyst	RW	0 to 10 Number of decimal places: 0	0 to 10 Number of decimal places: 0	5	%	Specify the hysteresis width between the alarm occurrence and resetting.
9-6	Diagnostic root menu ► Status/Self test ► Alarm ► Burn out	Device setup ► Diag/Service ► H/L alarm cfg ► 4-20 burnout	R	High Low	High Low	-	-	Indicates the current output direction when burnout occurs.
9-7	Diagnostic root menu ► Status/Self test ► Alarm ► Alarm out mask ► Alarm out mask 1	Device setup ► Diag/Service ► Sts/Self test ► Alarm ► Alarm out mask ► Mask 1-1	RW	13: Main board EEPROM default on 21: PWM1 stop on 22: PWM2 stop on 23: Option board mismatch on 24: Option EEPROM failure on 25: Option board A/D failure on	013:EEPROM dflt	All Off	-	Specify the mask function for alarm notification 1-1.
		Device setup ► Diag/Service ► Sts/Self test ► Alarm ► Alarm out mask ► Mask 1-2	RW	26: Option board SPI failure on 28: Indicator board failure on 29: Ind EEP FAIL on 30: LCD driver failure on 31: Indicator board mismatch on 32: Indicator communication error on 33: microSD failure on	021:PWM1 stop 022:PWM2 stop 023:Opt bd mismatch 024: Opt bd EEP FAIL 025: Opt bd A/D FAIL 026: Opt bd SPI FAIL 028: Ind bd FAIL 029: Ind bd EEP FAIL 030: LCD drv FAIL 031: Ind bd mismatch 032: Ind comm ERR 033: microSD FAIL	028: Ind bd FAIL	-	Indicates the masked alarm for alarm notification 1-2.

(**): The range of single precision float (IEEE 754).

No.	Name		Setting	Range		Default value	Unit	Description
	HART communication	Display		HART communication	Display			
9-7	Diagnostic root menu ▶ Status/Self test ▶ Alarm ▶ Alarm out mask ▶ Alarm out mask 2	Device setup ▶ Diag/Service ▶ Sts/Self test ▶ Alarm ▶ Alarm out mask ▶ Mask 2-1	RW	50: Signal overflow on 51: Empty pipe detection on 52: H/L HH/LL alarm on 53: Adhesion over level 4 on 60: Span configuration error on 62: Analog output 1 4-20 mA limit error on 64: Analog output 1 multi range error on 65: H/L HH/LL configuration error on 66: Density configuration error on	050: Signal overflow 051: Empty detect 052: H/L HH/LL alm 053: Adh over lv 4 060: Span cfg ERR 062: AO 1 4-20 lmt 064: AO 1 mlt rng 065: H/L cfg ERR 066: Density cfg ERR	052: H/L HH/LL alm 053: Adh over lv 4	-	Specify the mask function for alarm notification 2-1.
		Device setup ▶ Diag/Service ▶ Sts/Self test ▶ Alarm ▶ Alarm out mask ▶ Mask 2-2	RW	67: Pulse output 1 configuration error on 68: Pulse output 2 configuration error on 69: Nominal size configuration error on 70: Adhesion configuration error on 72: Data logging not started on 80: Analog output 1 saturated on 82: Pulse output 1 saturated on 83: Pulse output 2 saturated on 85: Cable misconnect on 86: Coil insulation warning on 131: Transmitter type mismatch on	067: Pls 1 cfg ERR 068: Pls 2 cfg ERR 069: Nomi size cfg 070: Adh cfg ERR 072: Log not start 080: AO 1 saturate 082: Pls 1 saturate 083: Pls 2 saturate 085: Cable miscon 086: Coil insulation 131: Trans mismatch	080: AO 1 saturate 082: Pls 1 saturate 083: Pls 2 saturate 086: Coil insulation	-	Specify the mask function for alarm notification 2-2.
	Diagnostic root menu ▶ Status/Self test ▶ Alarm ▶ Alarm out mask ▶ Alarm out mask 3	Device setup ▶ Diag/Service ▶ Sts/Self test ▶ Alarm ▶ Alarm out mask ▶ Mask 3-1	RW	87: Adhesion over level 3 on 92: Autozero warning on 93: Verification warning on 95: Simulation active on 96: Analog output 1 fixed on 98: Pulse output 1 fixed on 99: Pulse output 2 fixed on	087: Adhesion lv 3 092: AZ warn 093: Verif warn 095: Simulate active 096: AO 1 fix 098: Pls 1 fix 099: Pls 2 fix	087: Adhesion lv 3 093: Verif warn	-	Specify the mask function for alarm notification 3-1.
	Diagnostic root menu ▶ Status/Self test ▶ Alarm ▶ Alarm out mask ▶ Alarm out mask 3	Device setup ▶ Diag/Service ▶ Sts/Self test ▶ Alarm ▶ Alarm out mask ▶ Mask 3-2	RW	101: Parameter restore running on 102: Display over warning on 103: microSD card size warning on 104: Parameter backup incomplete on 105: microSD card mismatch on 106: microSD card removal error on 120: Watchdog on 121: Power off on 122: Instant power failure on 123: Parameter backup running on 124: Data logging running on	101: Param restore run 102: Disp over 103: SD size warn 104: Bkup incmpl 105: SD mismatch 106: SD removal ERR 120: Watchdog 121: Power off 122: Inst power FAIL 123: Param bkup run 124: Data log run	101: Param restore run 102: Disp over 103: SD size warn 104: Bkup incmpl warn 105: SD mismatch 106: SD removal ERR 120: Watchdog mismatch 121: Power off 122: Inst power FAIL 123: Param bkup run 124: Data log run	-	Specify the mask function for alarm notification 3-2.
Diagnostic root menu ▶ Status/Self test ▶ Alarm ▶ Alarm out mask ▶ Alarm out mask 4	Device setup ▶ Diag/Service ▶ Sts/Self test ▶ Alarm ▶ Alarm out mask ▶ Mask 4-1	RW	130: Device ID not entered on	130: DevID not enter	All Space	-	Specify the mask function for alarm notification 4-1.	

(**): The range of single precision float (IEEE 754).

No.	Name		Setting	Range		Default value	Unit	Description
	HART communication	Display		HART communication	Display			
9-8	Diagnostic root menu ▶ Status/Self test ▶ Alarm ▶ Alarm record mask ▶ Alarm record mask 1	Device setup ▶ Diag/Service ▶ Sts/Self test ▶ Alarm ▶ Alarm record mask ▶ Mask 1-1	RW	13:Main board EEPROM default on 20:Exciter failure on 21:PWM1 stop on 22:PWM1 stop on 23:Option board mismatch on 24:Option EEPROM failure on	013:EEPROM dflt 020: Exciter FAIL	All Space	-	Specify the mask function for alarm history 1-1.
		Device setup ▶ Diag/Service ▶ Sts/Self test ▶ Alarm ▶ Alarm record mask ▶ Mask 1-2	RW	25:Option board A/D failure on 26:Option board SPI failure on 28:Indicator board failure on 29:Ind EEP FAIL on 30:LCD driver failure on 31:Indicator board mismatch on 32:Indicator communication error on 33:microSD failure on	021:PWM1 stop 022:PWM2 stop 023:Opt bd mismatch 024: Opt bd EEP FAIL 025: Opt bd A/D FAIL 026: Opt bd SPI FAIL 028: Ind bd FAIL 029: Ind bd EEP FAIL 030: LCD drv FAIL 031: Ind bd mismatch 032: Ind comm ERR 033: microSD FAIL	All Space	-	Specify the mask function for alarm history 1-2.
	Diagnostic root menu ▶ Status/Self test ▶ Alarm ▶ Alarm record mask ▶ Alarm record mask 2	Device setup ▶ Diag/Service ▶ Sts/Self test ▶ Alarm ▶ Alarm record mask ▶ Mask 2-1	RW	50: Signal overflow on 51: Empty pipe detection on 52: H/L HH/LL alarm on 53: Adhesion over level 4 on 85: Cable misconnect on	050: Signal overflow 051: Empty detect 052: H/L HH/LL alm 053: Adh over lv 4	All Space	-	Specify the mask function for alarm history 2-1.
		Device setup ▶ Diag/Service ▶ Sts/Self test ▶ Alarm ▶ Alarm record mask ▶ Mask 2-2	RW		085: Cable miscon	All Space	-	Specify the mask function for alarm history 2-2.
	Diagnostic root menu ▶ Status/Self test ▶ Alarm ▶ Alarm record mask ▶ Alarm record mask 3	Device setup ▶ Diag/Service ▶ Sts/Self test ▶ Alarm ▶ Alarm record mask ▶ Mask 3-1	RW	130: Device ID not entered on	130: DevID not enter	130: DevID not enter	-	Specify the mask function for alarm history 3-1.
9-9	Diagnostic root menu ▶ Status/Self test ▶ Alarm ▶ Alarm record ▶ Alarm record 1	Device setup ▶ Diag/Service ▶ Sts/Self test ▶ Alarm ▶ Alarm record ▶ Record alarm 1	R	All Space 10: Main board CPU failure 11: Reverse calculation failure 12: Main board EEPROM failure 13: Main board EEPROM default 14: Sensor board failure 15: Sensor communication error 16: A/D1 failure[Signal] 17: A/D2 failure[Exciter] 18: Coil open 19: Coil short 20: Exciter failure 21: PWM1 stop 22: PWM2 stop 23: Option board mismatch 24: Option board EEPROM failure 25: Option board A/D failure 26: Option board SPI failure 27: Parameter restore incomplete 28: Indicator board failure 29: Indicator board EEPROM failure 30: LCD driver failure 31: Indicator board mismatch 32: Indicator communication error 33: microSD failure 50: Signal overflow 51: Empty pipe detection 52: H/L or HH/LL alarm 53: Adhesion over level 4 85: Cable misconnect 130:Device ID not entered	All Space 010: Main CPU FAIL 011: Rev calc FAIL 012: Main EEP FAIL 013:EEPROM dflt 014: Snsr bd FAIL 015: Snsr comm ERR 016: AD 1 FAIL[Sig] 017: AD 2 FAIL[Excit] 018: Coil open 019: Coil short 020: Exciter FAIL 021:PWM1 stop 022:PWM2 stop 023:Opt bd mismatch 024: Opt bd EEP FAIL 025: Opt bd A/D FAIL 026: Opt bd SPI FAIL 027: Restore FAIL 028: Ind bd FAIL 029: Ind bd EEP FAIL 030: LCD drv FAIL 031: Ind bd mismatch 032: Ind comm ERR 033: microSD FAIL 050: Signal overflow 051: Empty detect 052: H/L HH/LL alm 053: Adh over lv 4 085: Cable miscon 130: DevID not enter	All Space	-	Indicates the name of new alarm 1.
9-10	Diagnostic root menu ▶ Status/Self test ▶ Alarm ▶ Alarm record ▶ Alarm record time 1	Device setup ▶ Diag/Service ▶ Sts/Self test ▶ Alarm ▶ Alarm record ▶ Record time 1	R	00000D 00: 00 to 99999D 23: 59	00000D 00: 00 to 99999D 23: 59	00000D 00: 00	-	Indicates the operating time at which new alarm 1 has occurred.

(**): The range of single precision float (IEEE 754).

No.	Name		Setting	Range		Default value	Unit	Description
	HART communication	Display		HART communication	Display			
9-11	Diagnostic root menu ▶ Status/Self test ▶ Alarm ▶ Alarm record ▶ Alarm record 2	Device setup ▶ Diag/Service ▶ Sts/Self test ▶ Alarm ▶ Alarm record ▶ Record alarm 2	R	All Space 10: Main board CPU failure 11: Reverse calculation failure 12: Main board EEPROM failure 13: Main board EEPROM default 14: Sensor board failure 15: Sensor communication error 16: A/D1 failure[Signal] 17: A/D2 failure[Exciter] 18: Coil open 19: Coil short 20: Exciter failure 21: PWM1 stop 22: PWM2 stop 23: Option board mismatch 24: Option board EEPROM failure 25: Option board A/D failure 26: Option board SPI failure 27: Parameter restore incomplete 28: Indicator board failure 29: Indicator board EEPROM failure 30: LCD driver failure 31: Indicator board mismatch 32: Indicator communication error 33: microSD failure 50: Signal overflow 51: Empty pipe detection 52: H/L or HH/LL alarm 53: Adhesion over level 4 85: Cable misconnect 130:Device ID not entered	All Space 010: Main CPU FAIL 011: Rev calc FAIL 012: Main EEP FAIL 013:EEPROM dflt 014: Snsr bd FAIL 015: Snsr comm ERR 016: AD 1 FAIL[Sig] 017: AD 2 FAIL[Excit] 018: Coil open 019: Coil short 020: Exciter FAIL 021:PWM1 stop 022:PWM2 stop 023:Opt bd mismatch 024: Opt bd EEP FAIL 025: Opt bd A/D FAIL 026: Opt bd SPI FAIL 027: Restore FAIL 028: Ind bd FAIL 029: Ind bd EEP FAIL 030: LCD drv FAIL 031: Ind bd mismatch 032: Ind comm ERR 033: microSD FAIL 050: Signal overflow 051: Empty detect 052: H/L HH/LL alm 053: Adh over lv 4 085: Cable miscon 130: DevID not enter	All Space	-	Indicates the name of new alarm 2.
9-12	Diagnostic root menu ▶ Status/Self test ▶ Alarm ▶ Alarm record ▶ Alarm record time 2	Device setup ▶ Diag/Service ▶ Sts/Self test ▶ Alarm ▶ Alarm record ▶ Record time 2	R	00000D 00: 00 to 99999D 23: 59	00000D 00: 00 to 99999D 23: 59	00000D 00: 00	-	Indicates the operating time at which new alarm 2 has occurred.
9-13	Diagnostic root menu ▶ Status/Self test ▶ Alarm ▶ Alarm record ▶ Alarm record 3	Device setup ▶ Diag/Service ▶ Sts/Self test ▶ Alarm ▶ Alarm record ▶ Record alarm 3	R	All Space 10: Main board CPU failure 11: Reverse calculation failure 12: Main board EEPROM failure 13: Main board EEPROM default 14: Sensor board failure 15: Sensor communication error 16: A/D1 failure[Signal] 17: A/D2 failure[Exciter] 18: Coil open 19: Coil short 20: Exciter failure 21: PWM1 stop 22: PWM2 stop 23: Option board mismatch 24: Option board EEPROM failure 25: Option board A/D failure 26: Option board SPI failure 27: Parameter restore incomplete 28: Indicator board failure 29: Indicator board EEPROM failure 30: LCD driver failure 31: Indicator board mismatch 32: Indicator communication error 33: microSD failure 50: Signal overflow 51: Empty pipe detection 52: H/L or HH/LL alarm 53: Adhesion over level 4 85: Cable misconnect 130:Device ID not entered	All Space 010: Main CPU FAIL 011: Rev calc FAIL 012: Main EEP FAIL 013:EEPROM dflt 014: Snsr bd FAIL 015: Snsr comm ERR 016: AD 1 FAIL[Sig] 017: AD 2 FAIL[Excit] 018: Coil open 019: Coil short 020: Exciter FAIL 021:PWM1 stop 022:PWM2 stop 023:Opt bd mismatch 024: Opt bd EEP FAIL 025: Opt bd A/D FAIL 026: Opt bd SPI FAIL 027: Restore FAIL 028: Ind bd FAIL 029: Ind bd EEP FAIL 030: LCD drv FAIL 031: Ind bd mismatch 032: Ind comm ERR 033: microSD FAIL 050: Signal overflow 051: Empty detect 052: H/L HH/LL alm 053: Adh over lv 4 085: Cable miscon 130: DevID not enter	All Space	-	Indicates the name of new alarm 3.
9-14	Diagnostic root menu ▶ Status/Self test ▶ Alarm ▶ Alarm record ▶ Alarm record time 3	Device setup ▶ Diag/Service ▶ Sts/Self test ▶ Alarm ▶ Alarm record ▶ Record time 3	R	00000D 00: 00 to 99999D 23: 59	00000D 00: 00 to 99999D 23: 59	00000D 00: 00	-	Indicates the operating time at which new alarm 3 has occurred.

(**): The range of single precision float (IEEE 754).

No.	Name		Setting	Range		Default value	Unit	Description
	HART communication	Display		HART communication	Display			
9-15	Diagnostic root menu ▶ Status/Self test ▶ Alarm ▶ Alarm record ▶ Alarm record 4	Device setup ▶ Diag/Service ▶ Sts/Self test ▶ Alarm ▶ Alarm record ▶ Record alarm 4	R	All Space 10: Main board CPU failure 11: Reverse calculation failure 12: Main board EEPROM failure 13: Main board EEPROM default 14: Sensor board failure 15: Sensor communication error 16: A/D1 failure[Signal] 17: A/D2 failure[Exciter] 18: Coil open 19: Coil short 20: Exciter failure 21: PWM1 stop 22: PWM2 stop 23: Option board mismatch 24: Option board EEPROM failure 25: Option board A/D failure 26: Option board SPI failure 27: Parameter restore incomplete 28: Indicator board failure 29: Indicator board EEPROM failure 30: LCD driver failure 31: Indicator board mismatch 32: Indicator communication error 33: microSD failure 50: Signal overflow 51: Empty pipe detection 52: H/L or HH/LL alarm 53: Adhesion over level 4 85: Cable misconnect 130:Device ID not entered	All Space 010: Main CPU FAIL 011: Rev calc FAIL 012: Main EEP FAIL 013:EEPROM dflt 014: Snsr bd FAIL 015: Snsr comm ERR 016: AD 1 FAIL[Sig] 017: AD 2 FAIL[Excit] 018: Coil open 019: Coil short 020: Exciter FAIL 021:PWM1 stop 022:PWM2 stop 023:Opt bd mismatch 024: Opt bd EEP FAIL 025: Opt bd A/D FAIL 026: Opt bd SPI FAIL 027: Restore FAIL 028: Ind bd FAIL 029: Ind bd EEP FAIL 030: LCD drv FAIL 031: Ind bd mismatch 032: Ind comm ERR 033: microSD FAIL 050: Signal overflow 051: Empty detect 052: H/L HH/LL alm 053: Adh over lv 4 085: Cable miscon 130: DevID not enter	All Space	-	Indicates the name of new alarm 4.
9-16	Diagnostic root menu ▶ Status/Self test ▶ Alarm ▶ Alarm record ▶ Alarm record time 4	Device setup ▶ Diag/Service ▶ Sts/Self test ▶ Alarm ▶ Alarm record ▶ Record time 4	R	00000D 00: 00 to 99999D 23: 59	00000D 00: 00 to 99999D 23: 59	00000D 00: 00	-	Indicates the operating time at which new alarm 4 has occurred.

(**): The range of single precision float (IEEE 754).

(10) Display configuration parameters

This list shows the parameters related to display settings.

No.	Name		Setting	Range		Default value	Unit	Description
	HART communication	Display		HART communication	Display			
10-1	Device root menu ▶ Detailed setup ▶ Display ▶ Line select ▶ Display select1	Device setup▶ Detailed setup▶ Display set▶ Line select▶ Line 1	RW	Flow rate(%) PV Velocity Volume flow Mass flow Flow rate(%Bar) Totalizer1 Totalizer2 Totalizer3 Tag number Long tag Commun protocol Adhesion Analog out1	Flow rate(%) PV Velocity Volume flow Mass flow Flow rate(%Bar) Totalizer1 Totalizer2 Totalizer3 Tag number Long tag Commun protocol Adhesion Analog out1	PV	-	Specify item 1 to be shown on the display. Synchronized with No. 2-11.
10-2	Device root menu ▶ Detailed setup ▶ Display ▶ Line select ▶ Display select2	Device setup▶ Detailed setup▶ Display set▶ Line select▶ Line 2	RW	None Flow rate(%) PV Velocity Volume flow	None Flow rate(%) PV Velocity Volume flow	Flow rate(%)	-	Specify item 2 to be shown on the display. Synchronized with No. 2-12.
10-3	Device root menu ▶ Detailed setup ▶ Display ▶ Line select ▶ Display select3	Device setup▶ Detailed setup▶ Display set▶ Line select▶ Line 3	RW	Mass flow Flow rate(%Bar) Totalizer1 Totalizer2	Mass flow Flow rate(%Bar) Totalizer1 Totalizer2	Analog out1	-	Specify item 3 to be shown on the display. Synchronized with No. 2-13.
10-4	Device root menu ▶ Detailed setup ▶ Display ▶ Line select ▶ Display select4	Device setup▶ Detailed setup▶ Display set▶ Line select▶ Line 4	RW	Totalizer3 Tag number Long tag Commun protocol Adhesion Analog out1	Totalizer3 Tag number Long tag Commun protocol Adhesion Analog out1	None	-	Specify item 4 to be shown on the display.
10-5	Device root menu ▶ Detailed setup ▶ Display ▶ Line select ▶ Display select5	Device setup▶ Detailed setup▶ Display set▶ Line select▶ Line 5	RW			None	-	Specify item 5 to be shown on the display.
10-6	Device root menu ▶ Detailed setup ▶ Display ▶ Line select ▶ Display select6	Device setup▶ Detailed setup▶ Display set▶ Line select▶ Line 6	RW			None	-	Specify item 6 to be shown on the display.
10-7	Device root menu ▶ Detailed setup ▶ Display ▶ Line select ▶ Display select7	Device setup▶ Detailed setup▶ Display set▶ Line select▶ Line 7	RW			None	-	Specify item 7 to be shown on the display.
10-8	Device root menu ▶ Detailed setup ▶ Display ▶ Line select ▶ Display select8	Device setup▶ Detailed setup▶ Display set▶ Line select▶ Line 8	RW			None	-	Specify item 8 to be shown on the display.
10-9	Device root menu ▶ Detailed setup ▶ Display ▶ Display format ▶ Display format PV	Device setup▶ Detailed setup▶ Display set▶ Disp format▶ Format PV	RW	Auto 0 digit 1 digit 2 digit 3 digit 4 digit 5 digit	Auto 0 digit 1 digit 2 digit 3 digit 4 digit 5 digit	Auto	-	Specify the number of decimal places. Auto: Automatically adjusts the number of decimal places. 0 digit: Fixes the number of decimal places to "0". 1 digit: Fixes the number of decimal places to "1". 2 digit: Fixes the number of decimal places to "2". 3 digit: Fixes the number of decimal places to "3". 4 digit: Fixes the number of decimal places to "4". 5 digit: Fixes the number of decimal places to "5".

(*): Determined based on the information about specified items at the time of ordering and the sensor to be combined with.

(**): The range of single precision float (IEEE 754).

(***): When Main soft rev (Main board revision/Main soft rev) is R1.01.06 or earlier, the default value is Manual.

No.	Name		Setting	Range		Default value	Unit	Description
	HART communication	Display		HART communication	Display			
10-10	Device root menu ▶ Detailed setup ▶ Display ▶ Display format ▶ Display format total 1	Device setup ▶ Detailed setup ▶ Display set ▶ Disp format ▶ Format total 1	RW	Auto 0 digit 1 digit 2 digit 3 digit 4 digit 5 digit 6 digit 7 digit	Auto 0 digit 1 digit 2 digit 3 digit 4 digit 5 digit 6 digit 7 digit	Auto	-	Specify the decimal-point position of the totalized value for Totalizer 1. Auto: Automatically adjusts the number of decimal places. 0 digit: Fixes the number of decimal places to "0". 1 digit: Fixes the number of decimal places to "1". 2 digit: Fixes the number of decimal places to "2". 3 digit: Fixes the number of decimal places to "3". 4 digit: Fixes the number of decimal places to "4". 5 digit: Fixes the number of decimal places to "5". 6 digit: Fixes the number of decimal places to "6". 7 digit: Fixes the number of decimal places to "7".
10-11	Device root menu ▶ Detailed setup ▶ Display ▶ Display format ▶ Display format total 2	Device setup ▶ Detailed setup ▶ Display set ▶ Disp format ▶ Format total 2	RW					Specify the decimal-point position of the totalized value for Totalizer 2. Auto: Automatically adjusts the number of decimal places. 0 digit: Fixes the number of decimal places to "0". 1 digit: Fixes the number of decimal places to "1". 2 digit: Fixes the number of decimal places to "2". 3 digit: Fixes the number of decimal places to "3". 4 digit: Fixes the number of decimal places to "4". 5 digit: Fixes the number of decimal places to "5". 6 digit: Fixes the number of decimal places to "6". 7 digit: Fixes the number of decimal places to "7".
10-12	Device root menu ▶ Detailed setup ▶ Display ▶ Display format ▶ Display format total 3	Device setup ▶ Detailed setup ▶ Display set ▶ Disp format ▶ Format total 3	RW					Specify the decimal-point position of the totalized value for Totalizer 3. Auto: Automatically adjusts the number of decimal places. 0 digit: Fixes the number of decimal places to "0". 1 digit: Fixes the number of decimal places to "1". 2 digit: Fixes the number of decimal places to "2". 3 digit: Fixes the number of decimal places to "3". 4 digit: Fixes the number of decimal places to "4". 5 digit: Fixes the number of decimal places to "5". 6 digit: Fixes the number of decimal places to "6". 7 digit: Fixes the number of decimal places to "7".
10-13	Device root menu ▶ Detailed setup ▶ Display ▶ Display operation configuration ▶ Display contrast	Device setup ▶ Detailed setup ▶ Display set ▶ Optional config ▶ Contrast	RW	-5 -4 -3 -2 -1 0 +1 +2 +3 +4 +5	-5 -4 -3 -2 -1 0 1 2 3 4 5	0	-	Specify the contrast of the display. -: Light, +: Dark
10-14	Device root menu ▶ Detailed setup ▶ Display ▶ Display operation configuration ▶ Display line	Device setup ▶ Detailed setup ▶ Display set ▶ Optional config ▶ Line mode	RW	1 Line(Big) 1 Line 2 Line 3 Line 4 Line	1 Line(Big) 1 Line 2 Line 3 Line 4 Line	3 Line	-	Specify the number of lines to be shown on the display. 1 Line(Big): 1-line display without unit. The numeric value is displayed in large text. 1 Line: 1-line display with unit 2 Line: 2-line display with unit 3 Line: 3-line display with unit 4 Line: 4-line display with unit
10-15	Device root menu ▶ Detailed setup ▶ Display ▶ Display operation configuration ▶ Display period	Device setup ▶ Detailed setup ▶ Display set ▶ Optional config ▶ Period	RW	0.2 s 0.4 s 1.0 s 2.0 s 4.0 s 8.0 s	0.2 s 0.4 s 1.0 s 2.0 s 4.0 s 8.0 s	0.4 s	-	Specify the process value update period for the display.
10-16	Device root menu ▶ Detailed setup ▶ Display ▶ Display operation configuration ▶ Display NE107	Device setup ▶ Detailed setup ▶ Display set ▶ Optional config ▶ NE107 display	RW	Normal NE107	Normal NE107	Normal	-	Specify whether to show or hide an alarm based on NAMUR NE107. Normal: Normal alarm display NE107: Alarm display based on NAMUR NE107
10-17	Device root menu ▶ Detailed setup ▶ Display ▶ Display operation configuration ▶ Display alarm	Device setup ▶ Detailed setup ▶ Display set ▶ Optional config ▶ Alarm display	RW	Normal Detail	Normal Detail	Normal	-	Specify the alarm display format. Normal: Normal alarm display (Process value and alarm name) Detail: Detailed alarm display (Alarm name and action)
10-18	Device root menu ▶ Detailed setup ▶ Display ▶ Display operation configuration ▶ Display scroll	Device setup ▶ Detailed setup ▶ Display set ▶ Optional config ▶ Scroll mode	RW	Off Manual Auto(2 s) Auto(4 s) Auto(8 s)	Off Manual Auto(2 s) Auto(4 s) Auto(8 s)	Off (***)	-	Specify the display scroll method. Off: Does not scroll. Manual: Scroll by infrared switch Auto(2 s): Automatic scroll (2-second cycle) Auto(4 s): Automatic scroll (4-second cycle) Auto(8 s): Automatic scroll (8-second cycle)

(*): Determined based on the information about specified items at the time of ordering and the sensor to be combined with.

(**): The range of single precision float (IEEE 754).

(***): When Main soft rev (Main board revision/Main soft rev) is R1.01.06 or earlier, the default value is Manual.

No.	Name		Setting	Range		Default value	Unit	Description
	HART communication	Display		HART communication	Display			
10-19	Device root menu ▶ Detailed setup ▶ Display ▶ Display operation configuration ▶ Display damping	Device setup ▶ Detailed setup ▶ Display set ▶ Optional config ▶ Damp	RW	0.0 to 200.0 Number of decimal places: 1	0.0 to 200.0 Number of decimal places: 1	0.0	s	Specify the damping time constant of the display.
10-20	Device root menu ▶ Detailed setup ▶ Display ▶ Display operation configuration ▶ Display format date	Device setup ▶ Detailed setup ▶ Display set ▶ Optional config ▶ Format date	RW	MM/DD/YYYY DD/MM/YYYY YYYY/MM/DD	MM/DD/YYYY DD/MM/YYYY YYYY/MM/DD	MM/DD/YYYY	-	Specify the date display format. YYYY: Year, MM: Month, DD: Day
10-21	Device root menu ▶ Detailed setup ▶ Display ▶ Display operation configuration ▶ Language	Device setup ▶ Language	RW	English French German Italian Spanish Portuguese Russian Chinese Japanese	English French German Italian Spanish Portuguese Russian Chinese Japanese	English	-	Specify the language to be used on the display. Synchronized with No. 2-1.
10-22	Device root menu ▶ Detailed setup ▶ Display ▶ Display operation configuration ▶ Display measure mode	Device setup ▶ Detailed setup ▶ Display set ▶ Optional config ▶ Display mode	RW	Normal Trend	Normal Trend	Normal	-	Specify whether to execute the trend graph display function. Normal: Normal display (Displays no trend graph.) Trend: Displays a trend graph
10-23	Device root menu ▶ Detailed setup ▶ Display ▶ Display operation configuration ▶ Trend offline lrv	Device setup ▶ Detailed setup ▶ Display set ▶ Optional config ▶ Trend offIn LRV	RW	-INF(**) to +INF(**) Number of decimal places: 1 to 5	-999999 to +999999 Number of decimal places: 1 to 5	0.0	-	Specify the low limit value to display a trend graph.
10-24	Device root menu ▶ Detailed setup ▶ Display ▶ Display operation configuration ▶ Trend offline urv	Device setup ▶ Detailed setup ▶ Display set ▶ Optional config ▶ Trend offIn URV	RW	-INF(**) to +INF(**) Number of decimal places: 1 to 5	-999999 to +999999 Number of decimal places: 1 to 5	10.0	-	Specify the high limit value to display a trend graph.
10-25	Device root menu ▶ Detailed setup ▶ Display ▶ Trend select ▶ Trend select 1	Device setup ▶ Detailed setup ▶ Display set ▶ Trend select ▶ Trend 1	RW	Flow rate(%) PV Velocity Volume flow Mass flow Analog out1 Totalizer1 Totalizer2 Totalizer3	Flow rate(%) PV Velocity Volume flow Mass flow Analog out1 Totalizer1 Totalizer2 Totalizer3	PV	-	Specify item 1 to be shown in a trend graph.
10-26	Device root menu ▶ Detailed setup ▶ Display ▶ Trend select ▶ Trend select 2	Device setup ▶ Detailed setup ▶ Display set ▶ Trend select ▶ Trend 2	RW	None Flow rate(%) PV Velocity Volume flow	None Flow rate(%) PV Velocity Volume flow	None	-	Specify item 2 to be shown in a trend graph.
10-27	Device root menu ▶ Detailed setup ▶ Display ▶ Trend select ▶ Trend select 3	Device setup ▶ Detailed setup ▶ Display set ▶ Trend select ▶ Trend 3	RW	Mass flow Analog out1 Totalizer1 Totalizer2 Totalizer3	Mass flow Analog out1 Totalizer1 Totalizer2 Totalizer3	None	-	Specify item 3 to be shown in a trend graph.
10-28	Device root menu ▶ Detailed setup ▶ Display ▶ Trend select ▶ Trend select 4	Device setup ▶ Detailed setup ▶ Display set ▶ Trend select ▶ Trend 4	RW			None	-	Specify item 4 to be shown in a trend graph.
10-29	Device root menu ▶ Detailed setup ▶ Display ▶ Display operation configuration ▶ Display inversion	Device setup ▶ Detailed setup ▶ Display set ▶ Optional config ▶ Inversion	RW	Normal Invert	Normal Invert	Normal	-	Specify whether to execute the black/white inverse function of the display. Normal: Normal display (Character color: Black, Background color: White) Invert: Black/white inverse display (Character color: White, Background color: Black)
10-30	Maintenance root menu ▶ Display indication ▶ LCD test	Devicesetup ▶ Diag/Service ▶ Disp indicator ▶ LCD test	RW	Not execute Execute Show Pattern1 Show Pattern2 Show Pattern3 Show Pattern4	Not execute Execute Show Pattern1 Show Pattern2 Show Pattern3 Show Pattern4	Not execute	-	Specify the test display function of the display. Not execute: No test display Execute: Test display (All LED ON -> All LED OFF -> Hound's tooth check -> Hound's tooth check (inversion) Show Pattern1: Test display (All LED ON) Show Pattern2: Test display (All LED OFF) Show Pattern3: Test display (Hound's tooth check) Show Pattern4: Test display (Hound's tooth check (inversion))

(*): Determined based on the information about specified items at the time of ordering and the sensor to be combined with.

(**): The range of single precision float (IEEE 754).

(***): When Main soft rev (Main board revision/Main soft rev) is R1.01.06 or earlier, the default value is Manual.

No.	Name		Setting	Range		Default value	Unit	Description
	HART communication	Display		HART communication	Display			
10-31	Maintenance root menu ▶ Display indication ▶ Squawk	Device setup ▶ Diag/Service ▶ Disp indicator ▶ Squawk	RW	Off On Squawk Once	Off On Squawk Once	Off	-	Specify whether to execute the display squawk function (backlight squawk on the display). Off: Disables the squawk display. On: Enables the squawk display (Continuous) Squawk Once: Enables the squawk display (once only).
10-32	Device root menu ▶ Detailed setup ▶ Display ▶ Display operation configuration ▶ Language package	Device setup ▶ Detailed setup ▶ Display set ▶ Optional config ▶ Language package	R	Package 1 Package 2	Package 1 Package 2	- (*)	-	Indicates the language package.
10-33	Device root menu ▶ Detailed setup ▶ Display ▶ Display operation configuration ▶ Display installation	Device setup ▶ Detailed setup ▶ Device info ▶ Order info ▶ Disp install	RW	No disp With disp	No disp With disp	With disp (*)	-	Specify whether the display is provided or not.

(*): Determined based on the information about specified items at the time of ordering and the sensor to be combined with.

(**): The range of single precision float (IEEE 754).

(***): When Main soft rev (Main board revision/Main soft rev) is R1.01.06 or earlier, the default value is Manual.

(11) Device information configuration parameters

This list shows the parameters related to device information settings.

No.	Name		Setting	Range		Default value	Unit	Description
	HART communication	Display		HART communication	Display			
11-1	Device root menu ▶ Detailed setup ▶ Device information ▶ Order information ▶ Tag	Device setup ▶ Detailed setup ▶ Device info ▶ Order info ▶ Tag No	RW	ASCII 8 characters	ASCII 8 characters	All Space (*)	-	Specify the tag number.
	Device root menu ▶ Detailed setup ▶ Device information ▶ Order information ▶ Long tag	Device setup ▶ Detailed setup ▶ Device info ▶ Order info ▶ Long tag	RW	ASCII 32 characters	ASCII 32 characters	All Space (*)	-	Specify the long tag.
11-2	Maintenance root menu ▶ Time stamp ▶ Operation time	Device setup ▶ Detailed setup ▶ Device info ▶ Date/Time ▶ Operation time	R	00000D 00: 00 to 99999D 23: 59	00000D 00: 00 to 99999D 23: 59	00000D 00: 00	-	Indicates the operating time of the device.
11-3	Maintenance root menu ▶ Time stamp ▶ Current Date	Device setup ▶ Detailed setup ▶ Device info ▶ Date/Time ▶ Current date	R	1900/01/01 to 2155/12/31	1900/01/01 to 2155/12/31	1900/01/01	-	Indicates the current date (month, day, and year).
11-4	Maintenance root menu ▶ Time stamp ▶ Current Time	Device setup ▶ Detailed setup ▶ Device info ▶ Date/Time ▶ Current time	R	00: 00: 00 to 23: 59: 59	00: 00: 00 to 23: 59: 59	00: 00: 00	-	Indicates the current time (hour, minute, and second).
11-5	-	Device setup ▶ Detailed setup ▶ Device info ▶ Date/Time ▶ Set date	RW	01/01/1900 to 12/31/2155	01/01/1900 to 12/31/2155	01/01/1900	-	Specify the current date (month, day, and year).
	-	Device setup ▶ Detailed setup ▶ Device info ▶ Date/Time ▶ Set time	RW	00: 00: 00 to 23: 59: 59	00: 00: 00 to 23: 59: 59	00: 00: 00	-	Specify the current time (hour, minute, and second).
	Maintenance root menu ▶ Time stamp ▶ Set Date/Time	-	RW	01/01/1900 00: 00: 00 to 12/31/2155 23: 59: 59	01/01/1900 00: 00: 00 to 12/31/2155 23: 59: 59	01/01/1900 00: 00: 00	-	Specify the current date (month, day, and year) and the current time (hour, minute, and second).
11-6	Device root menu ▶ Detailed setup ▶ Device information ▶ Version/Number information ▶ Transmitter type	Device setup ▶ Detailed setup ▶ Device info ▶ Ver/Num info ▶ Transmitter type	R	Non 4A Type	Non 4A Type	-	-	Indicates the types of transmitters to be combined.
11-7	Device root menu ▶ Detailed setup ▶ Device information ▶ Version/Number information ▶ Option board ID	Device setup ▶ Detailed setup ▶ Device info ▶ Ver/Num info ▶ Option board ID	R	Non Multi	Non Multi	-	-	Indicates the type of the option board.
11-8	Device root menu ▶ Detailed setup ▶ Device information ▶ Order information ▶ Electrode size	Device setup ▶ Detailed setup ▶ Device info ▶ Order info ▶ Electrode size	RW	1 mm 3 mm 8 mm 10 mm	1 mm 3 mm 8 mm 10 mm	3 mm	-	Specify the electrode size.
11-9	Device root menu ▶ Detailed setup ▶ Device information ▶ Order information ▶ Basic model code	Device setup ▶ Detailed setup ▶ Device info ▶ Order info ▶ MS code ▶ Model code	RW	ASCII 16 characters	ASCII 16 characters	All Space (*)	-	Specify the model name.
11-10	Device root menu ▶ Detailed setup ▶ Device information ▶ Order information ▶ Suffix config 1	Device setup ▶ Detailed setup ▶ Device info ▶ Order info ▶ MS code ▶ Suffix config 1	RW	ASCII 16 characters	ASCII 16 characters	All Space (*)	-	Specify suffix code 1.
	Device root menu ▶ Detailed setup ▶ Device information ▶ Order information ▶ Suffix config 2	Device setup ▶ Detailed setup ▶ Device info ▶ Order info ▶ MS code ▶ Suffix config 2	RW	ASCII 16 characters	ASCII 16 characters	All Space (*)	-	Specify suffix code 2.

(*): Determined based on the information about specified items at the time of ordering and the sensor to be combined with.

(**): Set at the factory before shipment.

No.	Name		Setting	Range		Default value	Unit	Description
	HART communication	Display		HART communication	Display			
11-11	Device root menu ▶ Detailed setup ▶ Device information ▶ Order information ▶ Option 1	Device setup ▶ Detailed setup ▶ Device info ▶ Order info ▶ MS code ▶ Option 1	RW	ASCII 16 characters	ASCII 16 characters	All Space (*)	-	Specify optional code 1.
	Device root menu ▶ Detailed setup ▶ Device information ▶ Order information ▶ Option 2	Device setup ▶ Detailed setup ▶ Device info ▶ Order info ▶ MS code ▶ Option 2	RW	ASCII 16 characters	ASCII 16 characters	All Space (*)	-	Specify optional code 2.
	Device root menu ▶ Detailed setup ▶ Device information ▶ Order information ▶ Option 3	Device setup ▶ Detailed setup ▶ Device info ▶ Order info ▶ MS code ▶ Option 3	RW	ASCII 16 characters	ASCII 16 characters	All Space (*)	-	Specify optional code 3.
	Device root menu ▶ Detailed setup ▶ Device information ▶ Order information ▶ Option 4	Device setup ▶ Detailed setup ▶ Device info ▶ Order info ▶ MS code ▶ Option 4	RW	ASCII 16 characters	ASCII 16 characters	All Space (*)	-	Specify optional code 4.
11-12	Device root menu ▶ Detailed setup ▶ Device information ▶ Order information ▶ Remote sensor basic model code	Device setup ▶ Detailed setup ▶ Device info ▶ Order info ▶ RS MS code ▶ Model code	RW	ASCII 16 characters	ASCII 16 characters	All Space (*)	-	Specify the model name.
11-13	Device root menu ▶ Detailed setup ▶ Device information ▶ Order information ▶ Remote sensor suffix config 1	Device setup ▶ Detailed setup ▶ Device info ▶ Order info ▶ RSMS code ▶ Suffix config 1	RW	ASCII 16 characters	ASCII 16 characters	All Space (*)	-	Specify optional code 1.
	Device root menu ▶ Detailed setup ▶ Device information ▶ Order information ▶ Remote sensor suffix config 2	Device setup ▶ Detailed setup ▶ Device info ▶ Order info ▶ RSMS code ▶ Suffix config 2	RW	ASCII 16 characters	ASCII 16 characters	All Space (*)	-	Specify optional code 2.
11-14	Device root menu ▶ Detailed setup ▶ Device information ▶ Order information ▶ Remote sensor option 1	Device setup ▶ Detailed setup ▶ Device info ▶ Order info ▶ RS MS code ▶ Option 1	RW	ASCII 16 characters	ASCII 16 characters	All Space (*)	-	Specify optional code 1.
	Device root menu ▶ Detailed setup ▶ Device information ▶ Order information ▶ Remote sensor option 2	Device setup ▶ Detailed setup ▶ Device info ▶ Order info ▶ RS MS code ▶ Option 2	RW	ASCII 16 characters	ASCII 16 characters	All Space (*)	-	Specify optional code 2.
	Device root menu ▶ Detailed setup ▶ Device information ▶ Order information ▶ Remote sensor option 3	Device setup ▶ Detailed setup ▶ Device info ▶ Order info ▶ RS MS code ▶ Option 3	RW	ASCII 16 characters	ASCII 16 characters	All Space (*)	-	Specify optional code 3.
	Device root menu ▶ Detailed setup ▶ Device information ▶ Order information ▶ Remote sensor option 4	Device setup ▶ Detailed setup ▶ Device info ▶ Order info ▶ RS MS code ▶ Option 4	RW	ASCII 16 characters	ASCII 16 characters	All Space (*)	-	Specify optional code 4.
11-15	Device root menu ▶ Detailed setup ▶ Device information ▶ Version/Number information ▶ Transmitter serial No	Device setup ▶ Detailed setup ▶ Device info ▶ Ver/Num info ▶ Trans serial No	RW	ASCII 16 characters	ASCII 16 characters	All Space	-	Specify the transmitter's serial number.
11-16	Device root menu ▶ Detailed setup ▶ Device information ▶ Version/Number information ▶ Sensor serial No	Device setup ▶ Detailed setup ▶ Device info ▶ Ver/Num info ▶ Sensor serial No	RW	ASCII 16 characters	ASCII 16 characters	All Space	-	Specify the sensor's serial number.
11-17	Device root menu ▶ Detailed setup ▶ Device information ▶ Memo ▶ Memo 1	Device setup ▶ Detailed setup ▶ Device info ▶ Memo ▶ Memo 1	RW	ASCII 16 characters	ASCII 16 characters	All Space	-	Specify memo 1.
	Device root menu ▶ Detailed setup ▶ Device information ▶ Memo ▶ Memo 2	Device setup ▶ Detailed setup ▶ Device info ▶ Memo ▶ Memo 2	RW	ASCII 16 characters	ASCII 16 characters	All Space	-	Specify memo 2.
	Device root menu ▶ Detailed setup ▶ Device information ▶ Memo ▶ Memo 3	Device setup ▶ Detailed setup ▶ Device info ▶ Memo ▶ Memo 3	RW	ASCII 16 characters	ASCII 16 characters	All Space	-	Specify memo 3.

(*): Determined based on the information about specified items at the time of ordering and the sensor to be combined with.

(**): Set at the factory before shipment.

No.	Name		Setting	Range		Default value	Unit	Description
	HART communication	Display		HART communication	Display			
11-18	Device root menu ▶ Detailed setup ▶ Device information ▶ Version/Number information ▶ Main board revision	Device setup ▶ Detailed setup ▶ Device info ▶ Ver/Num info ▶ Main soft rev	R	R1.01.01(***)	R1.01.01(***)	-	-	Indicates the firmware revision of the main board.
11-19	Device root menu ▶ Detailed setup ▶ Device information ▶ Version/Number information ▶ Sensor board revision	Device setup ▶ Detailed setup ▶ Device info ▶ Ver/Num info ▶ Snsr soft rev	R	R1.01.01(***)	R1.01.01(***)	-	-	Indicates the firmware revision of the sensor board.
11-20	Device root menu ▶ Detailed setup ▶ Device information ▶ Version/Number information ▶ Indicator board revision	Device setup ▶ Detailed setup ▶ Device info ▶ Ver/Num info ▶ Ind soft rev	R	R1.01.01(***)	R1.01.01(***)	-	-	Indicates the firmware revision of the display board.

(*): Determined based on the information about specified items at the time of ordering and the sensor to be combined with.

(**): Set at the factory before shipment.

(12)Diagnosis function configuration parameters

This list shows the parameters related to the electrode adhesion detection, and verification function settings.

No.	Name		Setting	Range		Default value	Unit	Description
	HART communication	Display		HART communication	Display			
12-1	Diagnostic root menu ▶ Diagnosis ▶ Adhesion ▶ Adhesion function	Device setup▶ Diag/Service▶ Diagnosis▶ Adhesion▶ Function	RW	Disable Enable	Disable Enable	Enable	-	Specify whether to enable or disable the electrode adhesion detecting function.
12-2	Diagnostic root menu ▶ Diagnosis ▶ Adhesion ▶ Adhesion level 1	Device setup▶ Diag/Service▶ Diagnosis▶ Adhesion▶ Threshold level 1	RW	0.00 to +100.00 Number of decimal places: 2	0.00 to +100.00 Number of decimal places: 2	0.10	M ohm	Specify the level 1 value used to judge the electrode adhesion detection.
12-3	Diagnostic root menu ▶ Diagnosis ▶ Adhesion ▶ Adhesion level 2	Device setup▶ Diag/Service▶ Diagnosis▶ Adhesion▶ Threshold level 2	RW	0.00 to +100.00 Number of decimal places: 2	0.00 to +100.00 Number of decimal places: 2	0.50	M ohm	Specify the level 2 value used to judge the electrode adhesion detection.
12-4	Diagnostic root menu ▶ Diagnosis ▶ Adhesion ▶ Adhesion level 3	Device setup▶ Diag/Service▶ Diagnosis▶ Adhesion▶ Threshold level 3	RW	0.00 to +100.00 Number of decimal places: 2	0.00 to +100.00 Number of decimal places: 2	4.00	M ohm	Specify the level 3 value used to judge the electrode adhesion detection.
12-5	Diagnostic root menu ▶ Diagnosis ▶ Adhesion ▶ Adhesion level 4	Device setup▶ Diag/Service▶ Diagnosis▶ Adhesion▶ Threshold level 4	RW	0.00 to +100.00 Number of decimal places: 2	0.00 to +100.00 Number of decimal places: 2	12.00	M ohm	Specify the level 4 value used to judge the electrode adhesion detection.
12-6	Diagnostic root menu ▶ Diagnosis ▶ Adhesion ▶ Result ▶ Adhesion value	Device setup▶ Diag/Service▶ Diagnosis▶ Adhesion▶ Result▶ Value	R	0.00000 to +1000.0 Number of decimal places: 0 to 5	0.00000 to +1000.0 Number of decimal places: 0 to 5	-	M ohm	Indicates the resistance value used to judge the electrode adhesion detection.
12-7	Diagnostic root menu ▶ Diagnosis ▶ Adhesion ▶ Result ▶ Adhesion status	Device setup▶ Diag/Service▶ Diagnosis▶ Adhesion▶ Result▶ Status	R	Level0 Level1 Level2 Level3 Level4	Level0 Level1 Level2 Level3 Level4	-	-	Indicates the electrode adhesion detection level.
12-8	Diagnostic root menu ▶ Diagnosis ▶ Adhesion ▶ Adhesion check cycle	Device setup▶ Diag/Service▶ Diagnosis▶ Adhesion▶ Check cycle	RW	0.5 min 1 min 2 min 10 min	0.5 min 1 min 2 min 10 min	2 min	-	Specify the update cycle for electrode adhesion detection.
12-21	Diagnostic root menu ▶ Diagnosis ▶ Diagnostic Exe	Device setup▶ Diag/Service▶ Diagnosis▶ Diagnostic execute	RW	Not execute Conn chk exe	Not execute Conn chk exe	Not execute	-	Specify whether to execute the misconnection detecting function. Not execute: Does not execute the functions. Conn chk exe: Executes the misconnection detecting function.
12-22	Diagnostic root menu ▶ Diagnosis ▶ Coil insulation threshold	Device setup▶ Diag/Service▶ Diagnosis▶ Coil insul threshold	RW	0.0 to 100.0 Number of decimal places: 1	0.0 to 100.0 Number of decimal places: 1	25.0	%	Specify the value used to judge the deterioration of coil insulation.
12-23	Diagnostic root menu ▶ Diagnosis ▶ IEX compare	Device setup▶ Diag/Service▶ Diagnosis▶ IEX compare	R	0.0 to 999.9 Number of decimal places: 1	0.0 to 999.9 Number of decimal places: 1	260.0	mA	Indicates the reference excitation current value used to judge the deterioration of coil insulation.
12-25	Diagnostic root menu ▶ Diagnosis ▶ IEX coil resistance	Device setup▶ Diag/Service▶ Diagnosis▶ IEX resistance	R	0 to +9999.9 Number of decimal places: 1	0 to +9999.9 Number of decimal places: 1	-	ohm	Indicates the coil resistance value when the excitation current is applied.
12-26	Diagnostic root menu ▶ Diagnosis ▶ Empty ▶ Electrode voltage A	Device setup▶ Diag/Service▶ Diagnosis▶ Empty check▶ Electrode voltage A	R	-3.00 to 3.00 Number of decimal places: 2	-3.00 to 3.00 Number of decimal places: 2	-	V	Indicates the voltage between electrode A and electrode C.
12-27	Diagnostic root menu ▶ Diagnosis ▶ Empty ▶ Electrode voltage B	Device setup▶ Diag/Service▶ Diagnosis▶ Empty check▶ Electrode voltage B	R	-3.00 to +3.00 Number of decimal places: 2	-3.00 to +3.00 Number of decimal places: 2	-	V	Indicates the voltage between electrode B and electrode C.
12-28	Diagnostic root menu ▶ Diagnosis ▶ Empty ▶ Result ▶ Empty status	Device setup▶ Diag/Service▶ Diagnosis▶ Empty check▶ Empty status	R	Full Empty	Full Empty	-	-	Indicates the result of the sensor empty pipe state function.
12-29	Maintenance root menu ▶ Verification ▶ Diagnostic output	Device setup▶ Diag/Service▶ Diagnosis▶ Diagnostic output	RW	Zero Measured value Hold	Zero Measured value Hold	Zero	-	Specify the output to use the verification function.
12-30	Maintenance root menu ▶ Verification ▶ VF mode	Device setup▶ Diag/Service▶ Verification▶ Mode	RW	No flow Flow	No flow Flow	No flow	-	Specify the fluid status to which the verification function is to be applied. No flow: No fluid flows. Flow: Fluid flows.

No.	Name		Setting	Range		Default value	Unit	Description
	HART communication	Display		HART communication	Display			
12-31	Maintenance root menu ▶ Verification ▶ Verification Exe	Device setup ▶ Diag/Service ▶ Verification ▶ Execute	RW	Not execute Execute	Not execute Execute	Not execute	-	Specify whether to execute the verification function.
12-32	Maintenance root menu ▶ Verification ▶ VF No	Device setup ▶ Diag/Service ▶ Verification ▶ VF No	RW	Factory Previous Present	Factory Previous Present	Factory	-	Specify the timing to display the diagnosis result of the verification function.
12-33	Maintenance root menu ▶ Verification ▶ Result ▶ VF check result	Device setup ▶ Diag/Service ▶ Verification ▶ Result ▶ Failed/Passed	R	Passed Failed Canceled No Data Unknown	Passed Failed Canceled No Data Unknown	No Data	-	Indicates the result of executing the verification function.
12-34	Maintenance root menu ▶ Verification ▶ Result ▶ VF operation time	Device setup ▶ Diag/Service ▶ Verification ▶ Result ▶ VF operate time	R	00000D 00: 00 to 99999D 23: 59	00000D 00: 00 to 99999D 23: 59	00000D 00: 00	-	Indicates the operating time of the verification function.
12-35	Maintenance root menu ▶ Verification ▶ Result ▶ Magnetic circuit result	Device setup ▶ Diag/Service ▶ Verification ▶ Result ▶ Magnetic circuit	R	Passed Failed Canceled No Data Unknown	Passed Failed Canceled No Data Unknown	No Data	-	Indicates the result of executing the verification function (the diagnosis result of the magnetic circuit).
12-36	Maintenance root menu ▶ Verification ▶ Result ▶ Excitation circuit result	Device setup ▶ Diag/Service ▶ Verification ▶ Result ▶ Excite circuit	R	Passed Failed Canceled No Data Unknown	Passed Failed Canceled No Data Unknown	No Data	-	Indicates the result of executing the verification function (the diagnosis result of the excitation circuit).
12-37	Maintenance root menu ▶ Verification ▶ Result ▶ Calculation circuit result	Device setup ▶ Diag/Service ▶ Verification ▶ Result ▶ Calc circuit	R	Passed Failed Canceled No Data Unknown	Passed Failed Canceled No Data Unknown	No Data	-	Indicates the result of executing the verification function (the diagnosis result of the calculation circuit).
12-38	Maintenance root menu ▶ Verification ▶ Result ▶ VF device status result	Device setup ▶ Diag/Service ▶ Verification ▶ Result ▶ Device status	R	Passed Failed Canceled No Data Unknown	Passed Failed Canceled No Data Unknown	No Data	-	Indicates the result of executing the verification function (the diagnosis result of the device alarm).
12-39	Maintenance root menu ▶ Verification ▶ Result ▶ Connection status result	Device setup ▶ Diag/Service ▶ Verification ▶ Result ▶ Connect status	R	Passed Failed Canceled No Data Unknown	Passed Failed Canceled No Data Unknown	No Data	-	Indicates the result of executing the verification function (wiring misconnection check result).

(13) Test mode configuration parameters

This list shows the parameters related to the test mode setting.

No.	Name		Setting	Range		Default value	Unit	Description
	HART communication	Display		HART communication	Display			
13-1	Maintenance root menu ▶ Test ▶ Release time	Device setup ▶ Diag/Service ▶ Test ▶ Release time	RW	10 min 30 min 1 h 3 h 12 h	10 min 30 min 1 h 3 h 12 h	10 min	-	Specify the time to automatically reset the test mode.
13-2	Maintenance root menu ▶ Test ▶ Test mode	-	RW	Velocity test on Volume flow test on Mass flow test on AO1 test on Pulse1 test on SO1 test on Pulse2 test on SO2 test on SI3 test on	Velocity test on Volume flow test on Mass flow test on AO1 test on Pulse1 test on SO1 test on Pulse2 test on SO2 test on SI3 test on	All Space	-	Specify whether to set the test mode on or off.
	-	Device setup ▶ Diag/Service ▶ Test ▶ Input test ▶ Test mode	RW	Velocity test Volume test Mass test SI3 test	Velocity test Volume test Mass test SI3 test	-	-	Specify whether to set the test mode (input) on/off.
	-	Device setup ▶ Diag/Service ▶ Test ▶ Output test ▶ Test mode	RW	AO1 test PO1 test SO1 test PO2 test SO2 test	AO1 test PO1 test SO1 test PO2 test SO2 test	-	-	Specify whether to set the test mode (output) on/off.
13-3	Maintenance root menu ▶ Test ▶ Input test ▶ Velocity	Device setup ▶ Diag/Service ▶ Test ▶ Input test ▶ Velocity	RW	-INF(**) to +INF(**) Number of decimal places: 0 to 5	-999999 to +999999 Number of decimal places: 0 to 5	0.0	Specified in No.3-15	Specify the test value of the flow velocity.
13-3	Maintenance root menu ▶ Test ▶ Input test ▶ Volume flow	Device setup ▶ Diag/Service ▶ Test ▶ Input test ▶ Volume	RW	-INF(**) to +INF(**) Number of decimal places: 0 to 5	-999999 to +999999 Number of decimal places: 0 to 5	0.0	Specified in No.3-16/No.3-19	Specify the test value of the volumetric flow rate.
13-4	Maintenance root menu ▶ Test ▶ Input test ▶ Mass flow	Device setup ▶ Diag/Service ▶ Test ▶ Input test ▶ Mass	RW	-INF(**) to +INF(**) Number of decimal places: 0 to 5	-999999 to +999999 Number of decimal places: 0 to 5	0.0	Specified in No.3-17/No.3-19	Specify the test value of the mass flow rate.
13-6	Maintenance root menu ▶ Test ▶ Output test ▶ AO1	Device setup ▶ Diag/Service ▶ Test ▶ Output test ▶ AO1	RW	2.400 to 21.600 Number of decimal places: 3	2.400 to 21.600 Number of decimal places: 3	4.000	mA	Specify the test value of the current output for the I/O1 terminal.
13-7	Maintenance root menu ▶ Test ▶ Output test ▶ Pulse1	Device setup ▶ Diag/Service ▶ Test ▶ Output test ▶ PO1	RW	0 to 12500 Number of decimal places: 0	0 to 12500 Number of decimal places: 0	0.0	pps (pulse/s)	Specify the test value of the pulse output for the I/O2 terminal.
13-8	Maintenance root menu ▶ Test ▶ Output test ▶ SO1	Device setup ▶ Diag/Service ▶ Test ▶ Output test ▶ SO1	RW	Open Close	Open Close	Open	-	Specify the test value of the status output for the I/O2 terminal.
13-10	Maintenance root menu ▶ Test ▶ Output test ▶ Pulse2	Device setup ▶ Diag/Service ▶ Test ▶ Output test ▶ PO2	RW	0 to 12500 Number of decimal places: 0	0 to 12500 Number of decimal places: 0	0	pps (pulse/s)	Specify the test value of the pulse output for the I/O3 or I/O4 terminal.
13-11	Maintenance root menu ▶ Test ▶ Output test ▶ SO2	Device setup ▶ Diag/Service ▶ Test ▶ Output test ▶ SO2	RW	Open Close	Open Close	Open	-	Specify the test value of the status output for the I/O3 or I/O4 terminal.
13-14	Maintenance root menu ▶ Test ▶ Input test ▶ SI3	Device setup ▶ Diag/Service ▶ Test ▶ Input test ▶ SI3	RW	Open Short	Open Close	Open	-	Specify the test value of the status input for the I/O3 terminal.

(**): The range of single precision float (IEEE 754).

(14)Backup, restore, and data log configuration parameters

This list shows the parameters related to the parameter backup function, restore function, and data logging function.

No.	Name		Setting	Range		Default value	Unit	Description
	HART communication	Display		HART communication	Display			
14-1	Maintenance root menu ▶ Param bkup/restore ▶ Factory backup name	Device setup▶ Diag/Service▶ Param bkup/restore▶ F backup name	R	ASCII 16 characters	ASCII 16 characters	Factory Delivery	-	Indicates the name of the file that is backed up (for factory).
14-2	Maintenance root menu ▶ Param bkup/restore ▶ Factory backup date	Device setup▶ Diag/Service▶ Param bkup/restore▶ F backup date	R	ASCII 16 characters	ASCII 16 characters	06/30/2017(***)	-	Indicates the date when backup has been made (for factory).
14-3	Maintenance root menu ▶ Param bkup/restore ▶ SD backup name	Device setup▶ Diag/Service▶ Param bkup/restore▶ SD backup name	RW	ASCII 8 characters	ASCII 8 characters	SD_FILE	-	Specify the name of the file to be backed up onto a microSD card or restored from a microSD card.
14-4	Maintenance root menu ▶ Param bkup/restore ▶ Backup name 1	Device setup▶ Diag/Service▶ Param bkup/restore▶ Backup name 1	RW	ASCII 16 characters	ASCII 16 characters	Backup 1	-	Specify the name of the file to be backed up (1 for user).
14-5	Maintenance root menu ▶ Param bkup/restore ▶ Backup date 1	Device setup▶ Diag/Service▶ Param bkup/restore▶ Backup date 1	RW	ASCII 16 characters	ASCII 16 characters	01/01/2016	-	Specify the date when backup has been made (1 for user).
14-6	Maintenance root menu ▶ Param bkup/restore ▶ Backup name 2	Device setup▶ Diag/Service▶ Param bkup/restore▶ Backup name 2	RW	ASCII 16 characters	ASCII 16 characters	Backup 2	-	Specify the name of the file to be backed up (2 for user).
14-7	Maintenance root menu ▶ Param bkup/restore ▶ Backup date 2	Device setup▶ Diag/Service▶ Param bkup/restore▶ Backup date 2	RW	ASCII 16 characters	ASCII 16 characters	01/01/2016	-	Specify the date when backup has been made (2 for user).
14-8	Maintenance root menu ▶ Param bkup/restore ▶ Backup name 3	Device setup▶ Diag/Service▶ Param bkup/restore▶ Backup name 3	RW	ASCII 16 characters	ASCII 16 characters	Backup 3	-	Specify the name of the file to be backed up (3 for user).
14-9	Maintenance root menu ▶ Param bkup/restore ▶ Backup date 3	Device setup▶ Diag/Service▶ Param bkup/restore▶ Backup date 3	RW	ASCII 16 characters	ASCII 16 characters	01/01/2016	-	Specify the date when backup has been made (3 for user).
14-10	Maintenance root menu ▶ Param bkup/restore ▶ Backup Exe	Device setup▶ Diag/Service▶ Param bkup/restore▶ Backup execute	RW	Not execute Store Main to 1 Store Main to 2 Store Main to 3 Store Main to SD Store EEP1 to SD Store EEP2 to SD Store EEP3 to SD	Not execute Store Main to 1 Store Main to 2 Store Main to 3 Store Main to SD Store EEP1 to SD Store EEP2 to SD Store EEP3 to SD	Not execute	-	Specify whether to execute the backup function as well as the backup location. Not execute: No backup Store main to 1: Makes a backup from the main board of the instrument to memory 1 on the display board. Store main to 2: Makes a backup from the main board of the instrument to memory 2 on the display board. Store main to 3: Makes a backup from the main board of the instrument to memory 3 on the display board. Store main to SD: Makes a backup from the main board of the instrument to a microSD card. Store EEP1 to SD: Makes a backup from memory 1 on the display board onto a microSD card. Store EEP2 to SD: Makes a backup from memory 2 on the display board onto a microSD card. Store EEP3 to SD: Makes a backup from memory 3 on the display board onto a microSD card.

(***) : Set at the factory before shipment.

No.	Name		Setting	Range		Default value	Unit	Description
	HART communication	Display		HART communication	Display			
14-11	Maintenance root menu ► Param bkup/restore ► Restore Exe	Device setup ► Diag/Service ► Param bkup/restore ► Restore execute	RW	Not execute Duplicate Data 1 Duplicate Data 2 Duplicate Data 3 Duplicate SD Restore Data 1 Restore Data 2 Restore Data 3 Restore SD Compulsion Data 1 Compulsion Data 2 Compulsion Data 3 Compulsion SD Restore Factory	Not execute Duplicate Data 1 Duplicate Data 2 Duplicate Data 3 Duplicate SD Restore Data 1 Restore Data 2 Restore Data 3 Restore SD Compulsion Data 1 Compulsion Data 2 Compulsion Data 3 Compulsion SD Restore Factory	Not execute	-	Specify whether to execute the restore function, the restoration location, and data to be restored. Not execute: Does not restore data. Duplicate Data1: Restores Duplicate Data from memory 1 on the indicator board to the main board of the instrument. Duplicate Data2: Restores Duplicate Data from memory 2 on the display board to the main board of the instrument. Duplicate Data3: Restores Duplicate Data from memory 3 on the display board to the main board of the instrument. Duplicate SD: Restores Duplicate Data from a microSD card to the main board of the instrument. Restore Data1: Restores Restore Data from memory 1 on the display board to the main board of the instrument. Restore Data2: Restores Restore Data from memory 2 on the display board to the main board of the instrument. Restore Data3: Restores Restore Data from memory 3 on the display board to the main board of the instrument. Restore SD: Restores Restore Data from a microSD card to the main board of the instrument. Compulsion Data1: Restores Compulsion Data from memory 1 on the display board to the main board of the instrument. Compulsion Data2: Restores Compulsion Data from memory 2 on the display board to the main board of the instrument. Compulsion Data3: Restores Compulsion Data from memory 3 on the display board to the main board of the instrument. Compulsion SD: Restores Compulsion Data from a microSD card to the main board of the instrument. Restore Factory: Restores to the status that is set upon shipment from the manufacturing plant.
14-12		Device setup ► Diag/Service ► Param bkup/restore ► Restore result	R	Unexecuted Success Failure Running	Unexecuted Success Failure Running	Unexecuted	-	Indicates the result of executing the restore function. Unexecuted: Does not restore data. Success: Succeeded in restoration. Failure: Failed in restoration. Running: Parameter restore running
14-13	Maintenance root menu ► Data logging ► File name	Device setup ► Diag/Service ► Data log ► File name	RW	ASCII 8 characters	ASCII 8 characters	LOG_FILE	-	Specify the name of the file to be stored by data log.
14-14	Maintenance root menu ► Data logging ► Interval time	Device setup ► Diag/Service ► Data log ► Interval time	RW	1 s 10 s 30 s 1 min 5 min 30 min 1 h	1 s 10 s 30 s 1 min 5 min 30 min 1 h	1 min	-	Specify the data log storage interval.
14-15	Maintenance root menu ► Data logging ► Start date	Device setup ► Diag/Service ► Data log ► Start date	R	2016/01/01 to 2155/12/31	2016/01/01 to 2155/12/31	-	-	Indicates the date to start the data logging function.
14-16	Maintenance root menu ► Data logging ► Start time	Device setup ► Diag/Service ► Data log ► Start time	R	00: 00: 00 to 23: 59: 59	00: 00: 00 to 23: 59: 59	-	-	Indicates the time to start the data logging function.
14-17	Maintenance root menu ► Data logging ► End time	Device setup ► Diag/Service ► Data log ► End time	RW	10 min 30 min 1 h 3 h 12 h 24 h 72 h 240 h	10 min 30 min 1 h 3 h 12 h 24 h 72 h 240 h	12 h	-	Specify the time to end the data logging function.

(***) : Set at the factory before shipment.

No.	Name		Setting	Range		Default value	Unit	Description
	HART communication	Display		HART communication	Display			
14-18	Maintenance root menu ► Data logging ► Log1 select	Device setup ► Diag/Service ► Data log ► Log 1	RW	Velocity Volume flow Mass flow	Velocity Volume flow Mass flow	PV	-	Specify process value 1 to be stored by data log.
14-19	Maintenance root menu ► Data logging ► Log2 select	Device setup ► Diag/Service ► Data log ► Log 2	RW	PV Adhesion	PV Adhesion	Velocity	-	Specify process value 2 to be stored by data log.
14-20	Maintenance root menu ► Data logging ► Log3 select	Device setup ► Diag/Service ► Data log ► Log 3	RW			Volume flow	-	Specify process value 3 to be stored by data log.
14-21	Maintenance root menu ► Data logging ► Log4 select	Device setup ► Diag/Service ► Data log ► Log 4	RW			Mass flow	-	Specify process value 4 to be stored by data log.
14-22	Maintenance root menu ► Data logging ► Logging Exe	Device setup ► Diag/Service ► Data log ► Execute	RW	Not execute Execute	Not execute Execute	Not execute	-	Specify whether to execute the data logging function.

(***) : Set at the factory before shipment.

(15)Parameter protection parameters

This list shows the parameters related to the write protection function.

No.	Name		Setting	Range		Default value	Unit	Description
	HART communication	Display		HART communication	Display			
15-1	-	Device setup▶ Detailed setup▶ Protection▶ Key code	RW	0000 to 9999 Number of decimal places: 0	0000 to 9999 Number of decimal places: 0	0000	-	Display-limited parameter (for service)
15-2	Device root menu ▶ Detailed setup ▶ Protection ▶ Write protect	Device setup▶ Detailed setup▶ Protection▶ Write protect sts	R	No Yes	No Yes	No	-	Indicates whether to use the write protection function.
15-3	Device root menu ▶ Detailed setup ▶ Protection ▶ Enable write 10 min	Device setup▶ Detailed setup▶ Protection▶ Enable write	RW	ASCII 8 characters	ASCII 8 characters	All Space	-	Enter the password to cancel the write protection function for 10 minutes.
15-4	Device root menu ▶ Detailed setup ▶ Protection ▶ New password	Device setup▶ Detailed setup▶ Protection▶ New password	RW	ASCII 8 characters	ASCII 8 characters	All Space	-	Specify a new password to use the write protection function.
15-5	Device root menu ▶ Detailed setup ▶ Protection ▶ Software seal	Device setup▶ Detailed setup▶ Protection▶ Soft seal status	R	Keep Break	Keep Break	Keep	-	Indicates whether to use the Joker password.

5.2 Menu Tree of Display

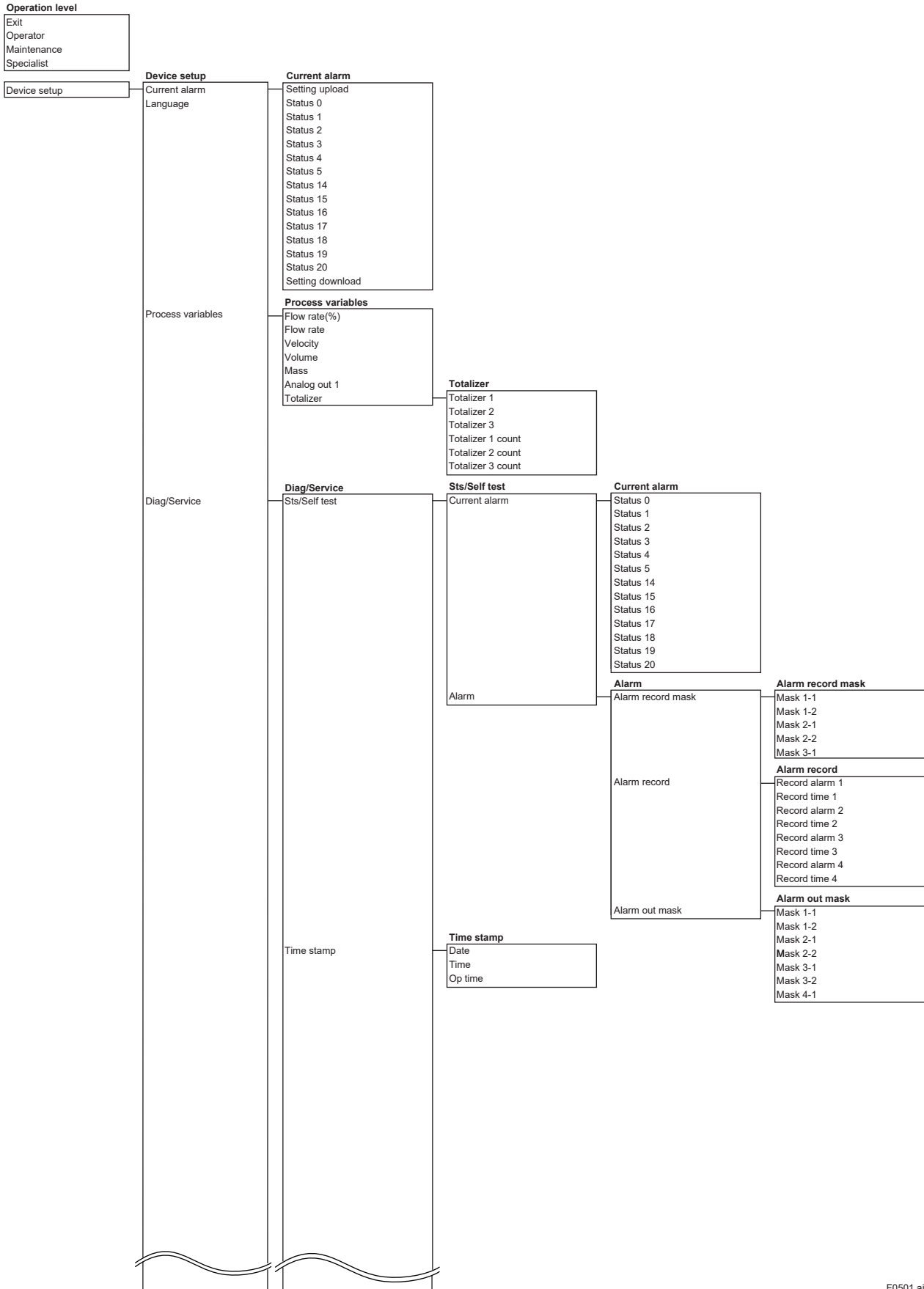

F0501.ai

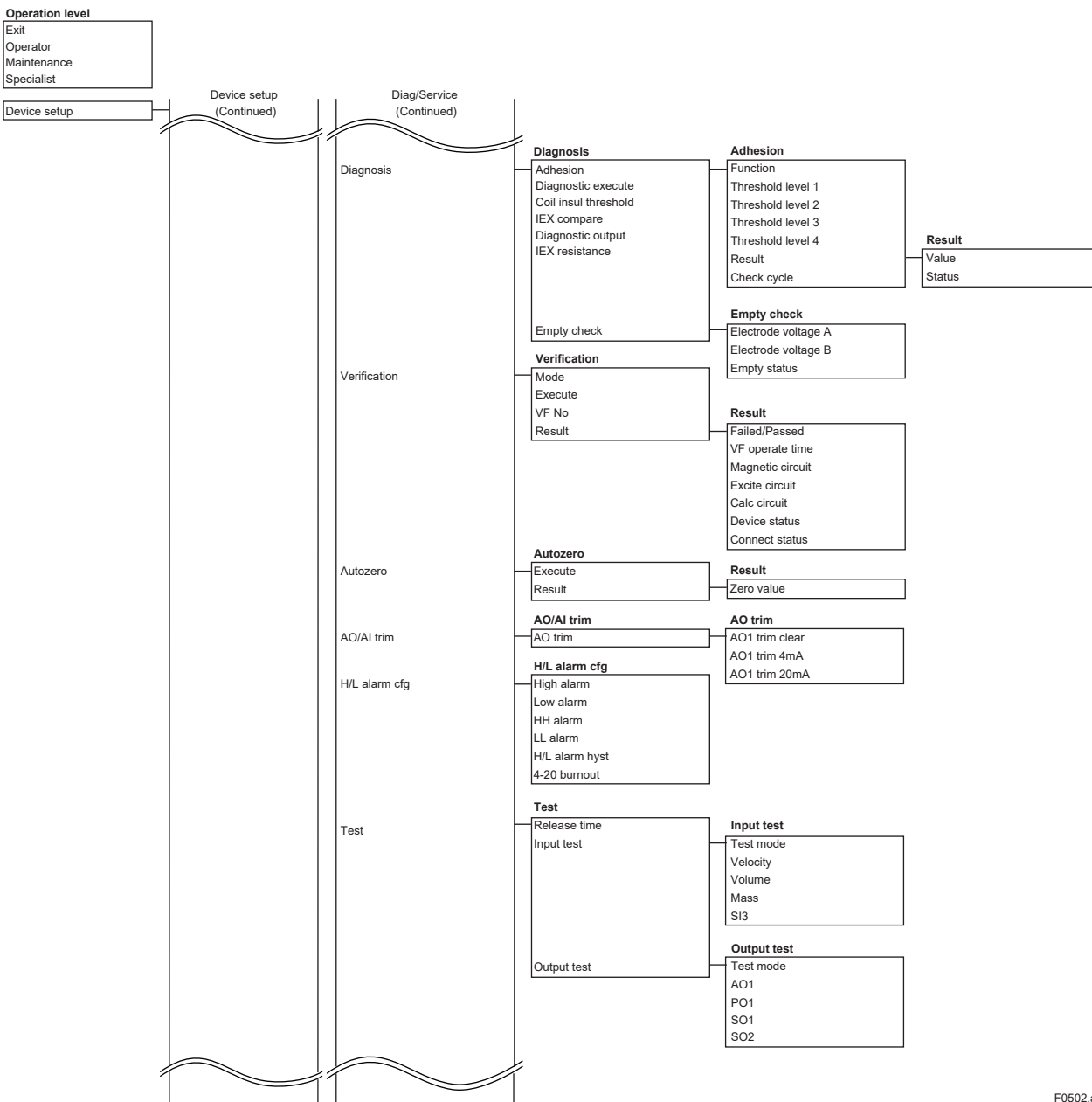

F0502.ai

Operation level

- Exit
- Operator
- Maintenance
- Specialist

Device setup

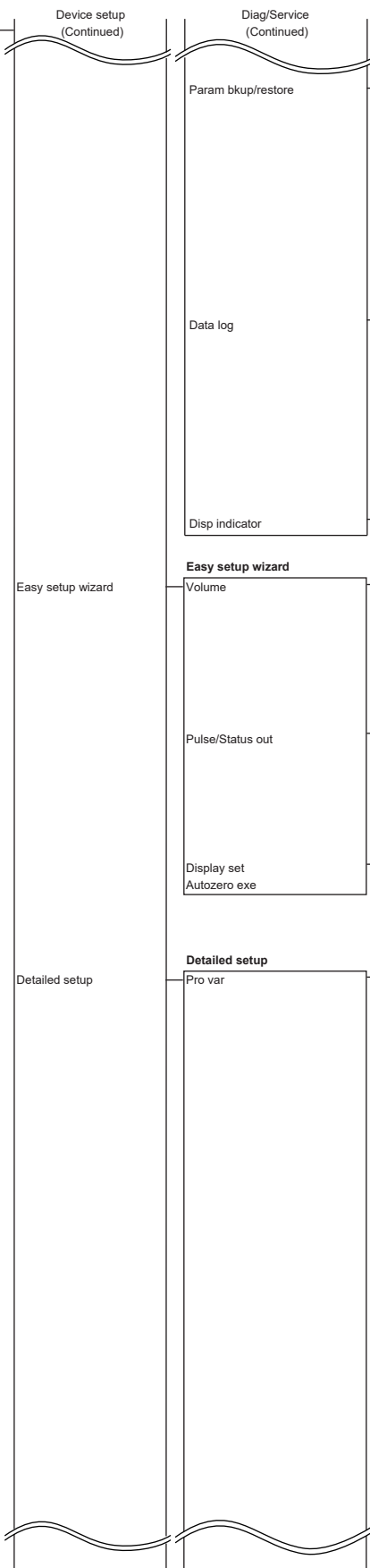

Param bkup/restore

- F backup name
- F backup date
- SD backup name
- Backup execute
- Restore execute
- Restore result
- Backup name 1
- Backup date 1
- Backup name 2
- Backup date 2
- Backup name 3
- Backup date 3

Data log

- File name
- Interval time
- Start date
- Start time
- End time
- Execute
- Log 1
- Log 2
- Log 3
- Log 4

Disp indicator

- LCD test
- Squawk

Easy setup wizard

- Volume

Volume

- Setting upload
- Damp AO/F
- Damp pls/ttl
- Unit
- Time unit
- Span
- Setting download

Pulse/Status out

Pulse/Status out

- Setting upload
- P1 unit
- P1 val
- F1 at 0%
- F1 at 100%
- Setting download

Display set

- Autozero exe

Display set

- Setting upload
- Line 1
- Line 2
- Line 3
- Setting download

Detailed setup

- Pro var

Pro var

- PV flow select
- Velocity
- Volume
- Mass
- Density
- Velocity check

Velocity

- Damp AO/F
- Damp pls/ttl
- Unit
- Span

Volume

- Damp AO/F
- Damp pls/ttl
- Unit
- Time unit
- Span

Mass

- Damp AO/F
- Damp pls/ttl
- Unit
- Time unit
- Span

Density

- Unit
- Fixed density

Operation level

- Exit
- Operator
- Maintenance
- Specialist

Device setup

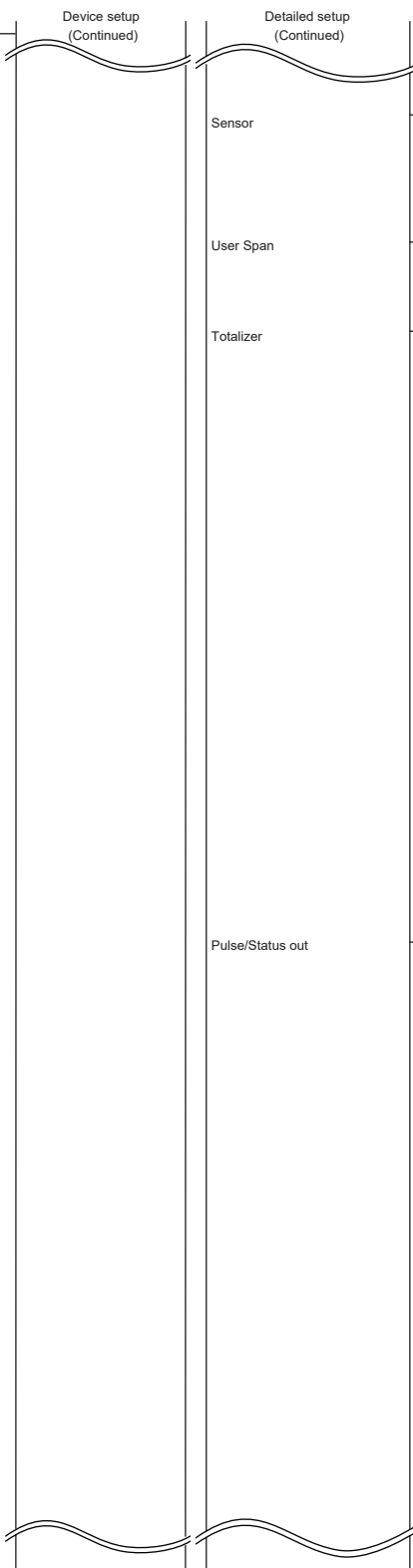

Sensor

- Low MF
- High MF
- Flow sensor sel
- Nominal size unit
- Nominal size

User Span

- User span AO1

User span AO1

- Select
- Span
- Unit

Totalizer

- Totalizer 1
- Totalizer 2
- Totalizer 3

Totalizer 1

- Unit
- Conv factor
- Low cut
- Failure opts
- Options
- Start/Stop
- Reset/Preset
- Preset value
- Set point

Totalizer 2

- Unit
- Conv factor
- Low cut
- Failure opts
- Options
- Start/Stop
- Reset/Preset
- Preset value
- Set point

Totalizer 3

- Unit
- Conv factor
- Low cut
- Failure opts
- Options
- Start/Stop
- Reset/Preset
- Preset value
- Set point

Pulse/Status out

- PO1/SO1
- PO2/SO2

PO1/SO1

- Output mode
- Active mode
- Fix width
- Rate unit
- Rate value
- Low cut
- Alarm out
- Frequency at 0%
- Frequency at 100%
- SO1 function

PO2/SO2

- Active pulse
- Output mode
- Pulse select
- Active mode
- Fix width
- Rate unit
- Rate value
- Low cut
- Alarm out
- Frequency at 0%
- Frequency at 100%
- SO2 function

F0504.ai

Operation level

- Exit
- Operator
- Maintenance
- Specialist

Device setup

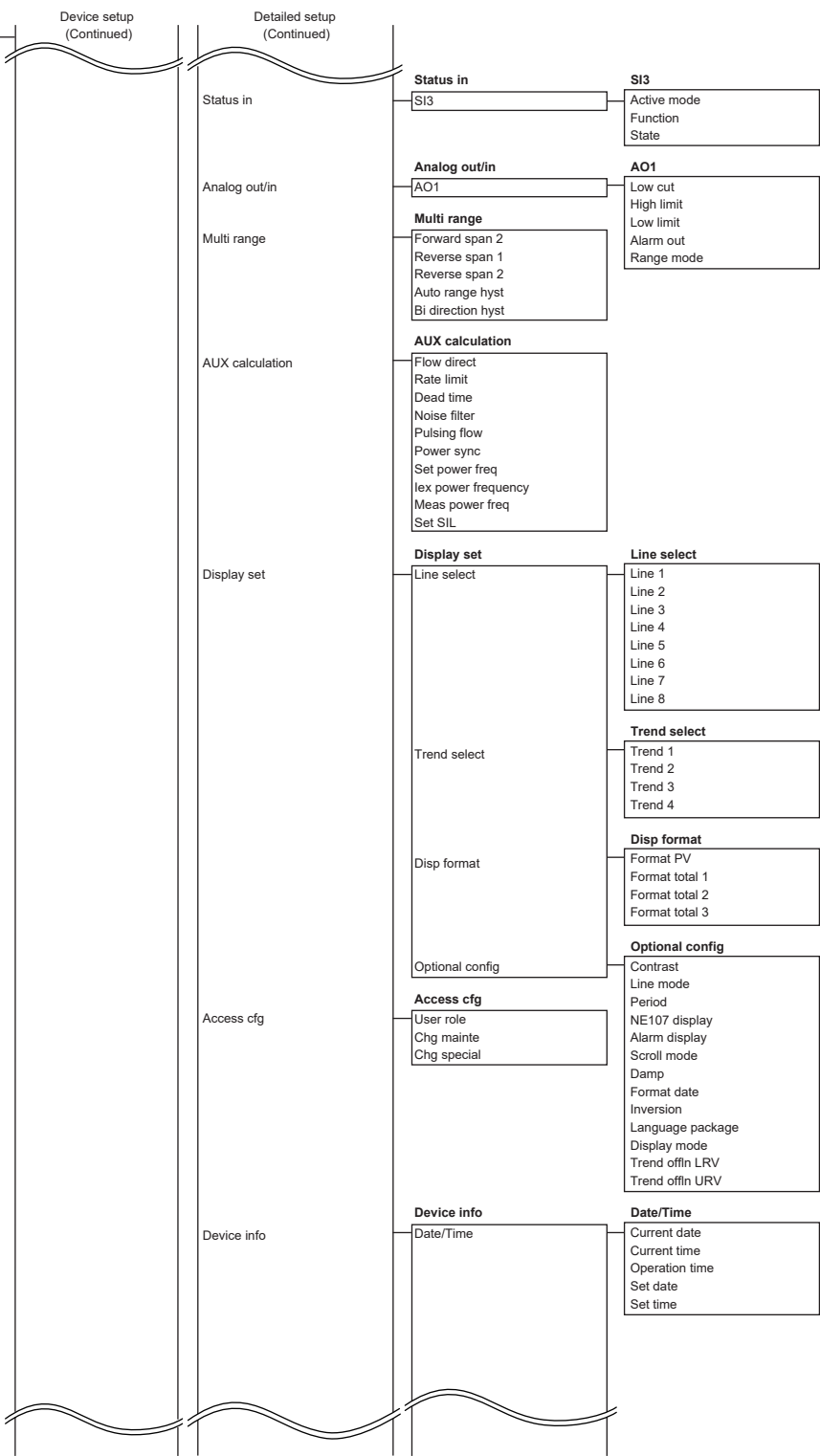

F0505.ai

Operation level

- Exit
- Operator
- Maintenance
- Specialist

Device setup

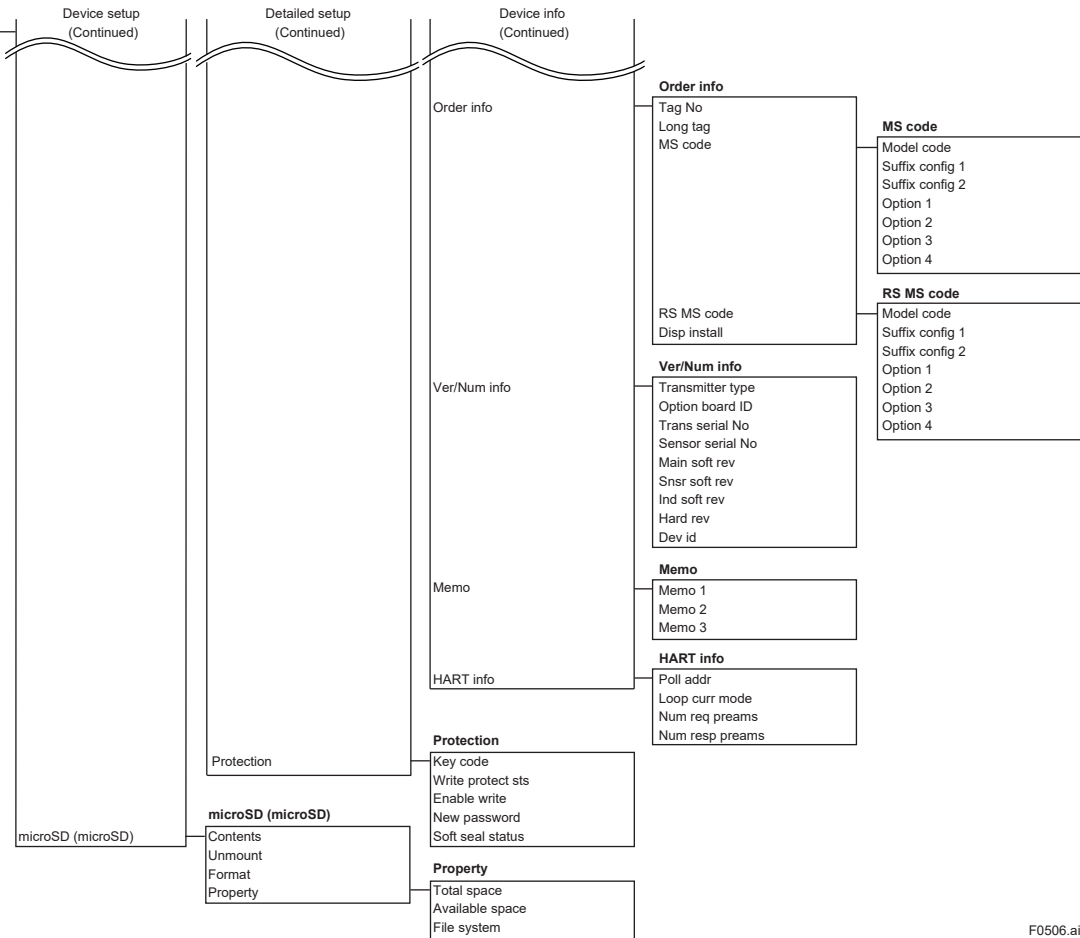

F0506.ai

Status 0
010:Main CPU FAIL
011:Rev calc FAIL
012:Main EEP FAIL
013:Main EEP dflt

Status 1
014:Snsr bd FAIL
015:Snsr comm ERR
016:AD 1 FAIL[Sig]
017:AD 2 FAIL[Excit]
018:Coil open
019:Coil short
020:Exciter FAIL

Status 2
021:PWM 1 stop
022:PWM 2 stop
023:Opt bd mismatch
024:Opt bd EEP FAIL
025:Opt bd A/D FAIL
026:Opt bd SPI FAIL

Status 3
027:Restore FAIL
028:Ind bd FAIL
029:Ind bd EEP FAIL
030:LCD drv FAIL
031:Ind bd mismatch
032:Ind comm ERR
033:microSD FAIL

Status 4
050:Signal overflow
051:Empty detect
052:H/L HH/LL alm
053:Adh over lv 4

Status 5
060:Span cfg ERR
062:AO 1 4-20 lmt
064:AO 1 mlt rng
065:H/L cfg ERR
066:Density cfg ERR
066:Density cfg ERR

Status 14
067:Pls 1 cfg ERR
068:Pls 2 cfg ERR
069:Nomi size cfg
070:Adh cfg ERR
072:Log not start

Status 15
080:AO 1 saturate
082:Pls 1 saturate
083:Pls 2 saturate
085:Cable miscon
086:Coil insulation
131:Trans mismatch

Status 16
087:Adhesion lv 3
092:AZ warn
093:Verif warn

Status 17
095:Simulate active
096:AO 1 fix
098:Pls 1 fix
099:Pls 2 fix

Status 18
101:Param restore run
102:Disp over
103:SD size warn
104:Bkup incmplt
105:SD mismatch
106:SD removal ERR

Status 19
120:Watchdog
121:Power off
122:Inst power FAIL
123:Param bkup run
124:Data log run

Status 20
130:DevID not enter

5.3 Menu Tree of HART Communication

The structure of DTM menu tree is as blow.

(1) Process variables root menu

- Dynamic variables
- Device variables
- Device variables status
- Totalizer count
- View outputs

(2) Diagnostic root menu

- Status/Self test
- Diagnosis

(3) Maintenance root menu

- Time stamp
- Test
- Autozero
- AO/AI trim
- High/Low alarm configuration
- Verification
- Param bkup/restore
- Data logging
- Display indication

(4) Device root menu

- Easy setup wizard
- Basic setup
- Detailed setup

(1) Process variables root menu

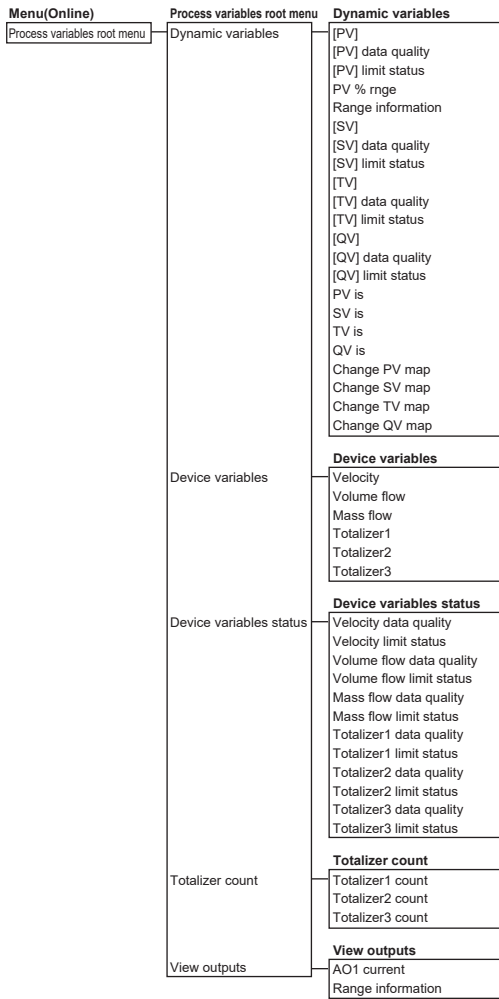

F0507.ai

(2) Diagnostic root menu

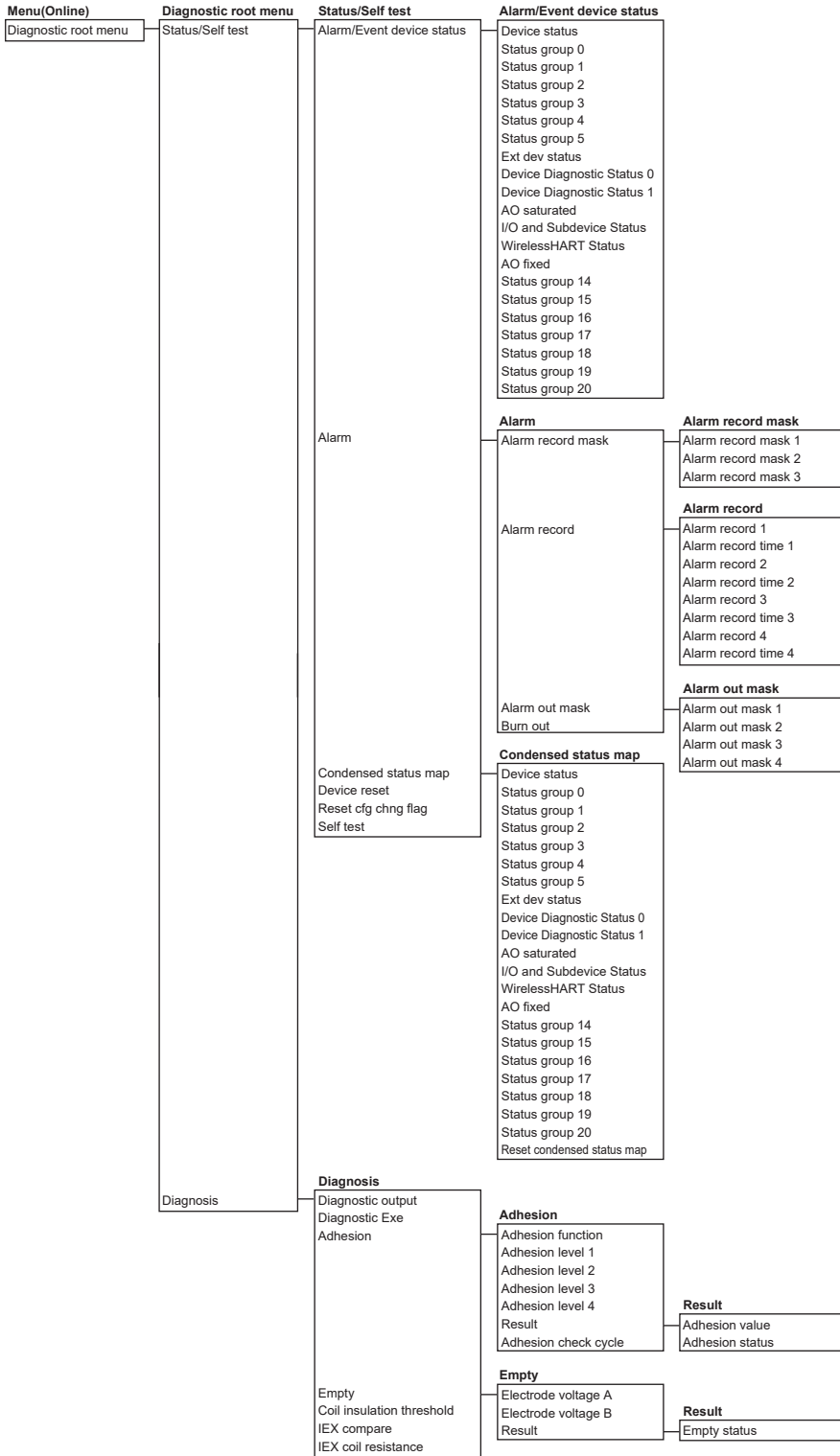

F0508.ai

(3) Maintenance root menu

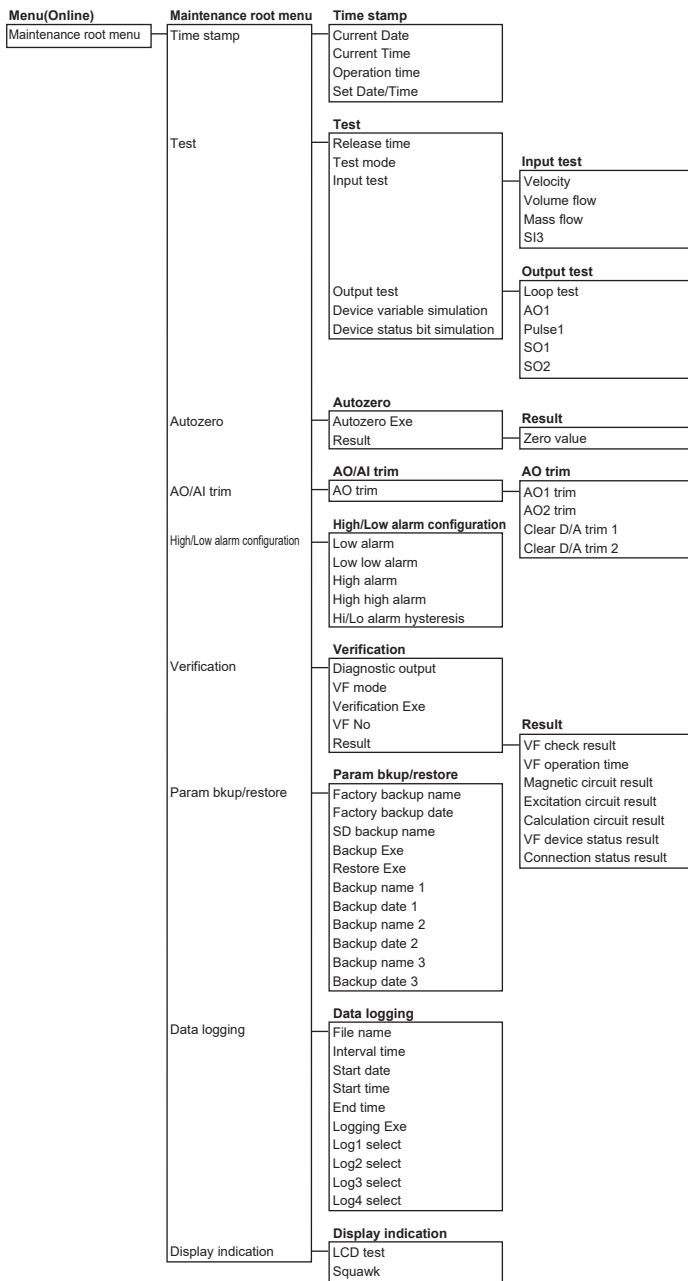

F0509.ai

(4) Device root menu

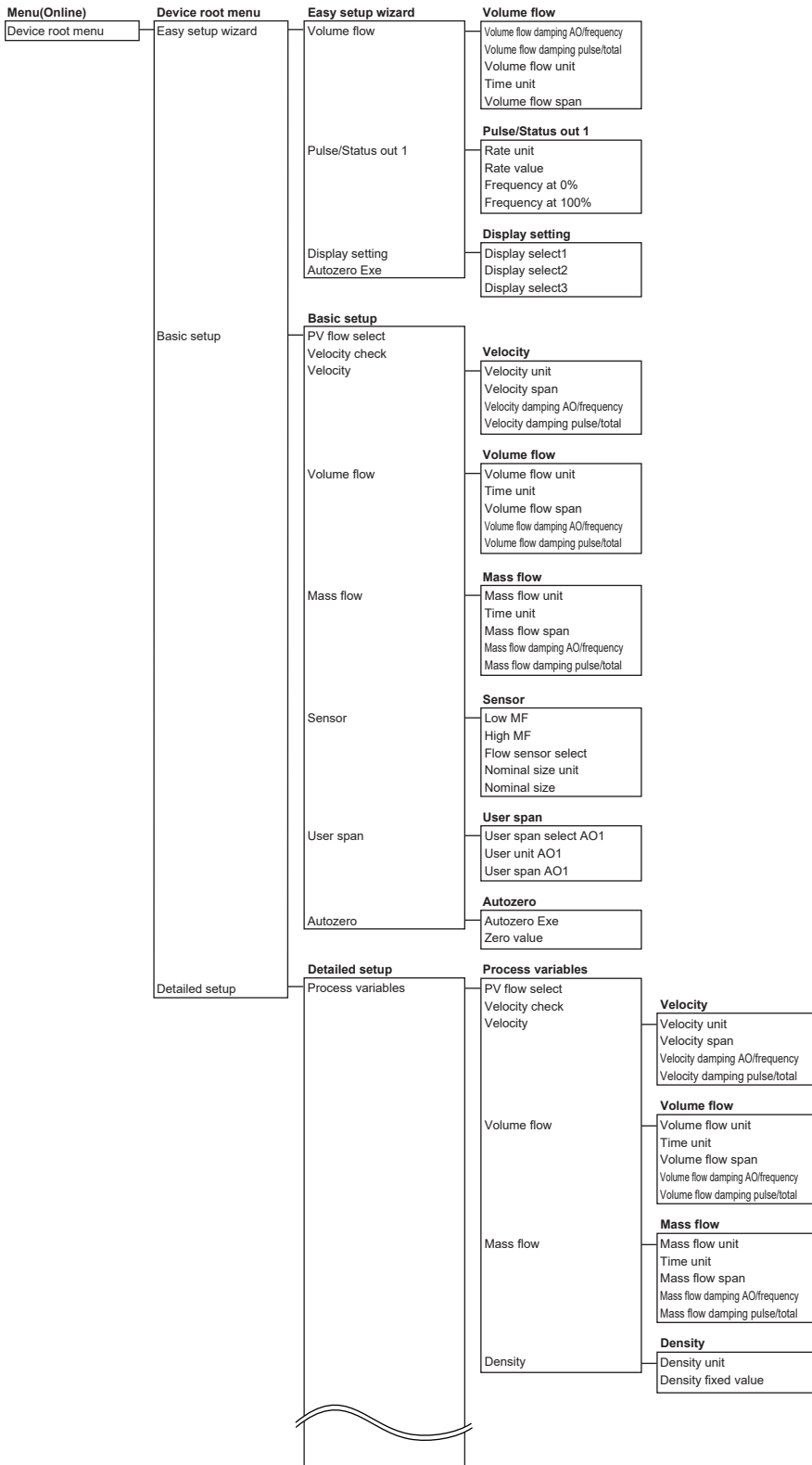

F0510.ai

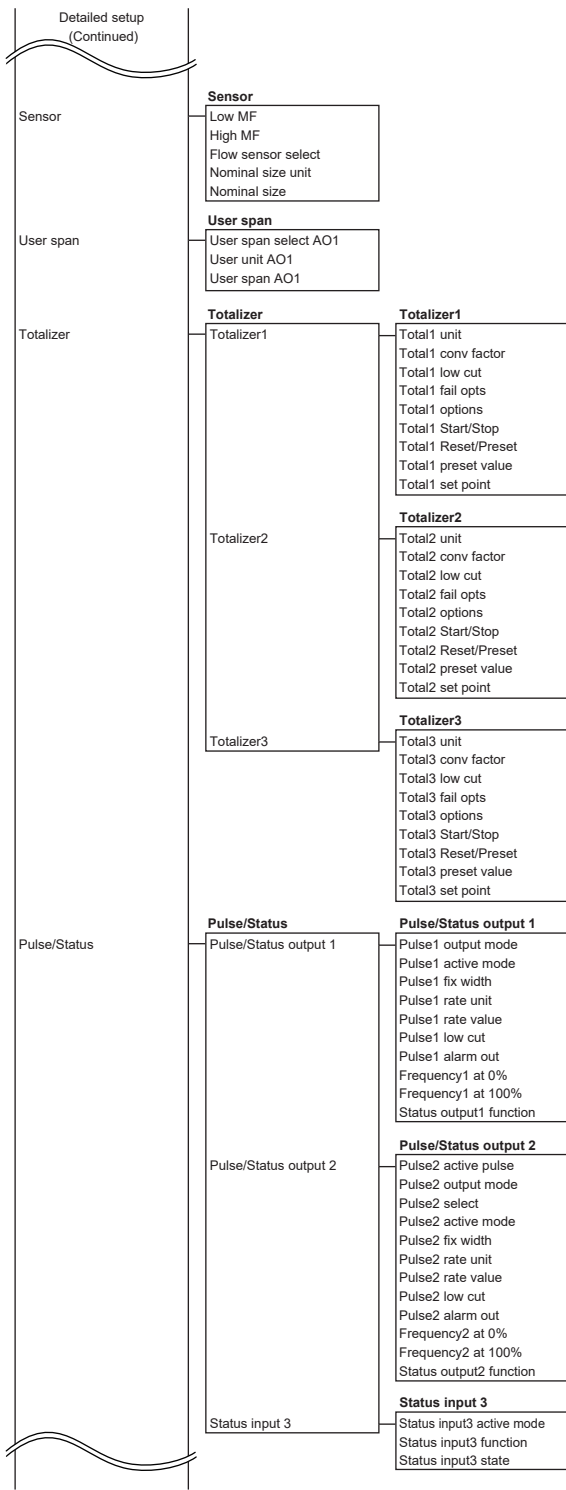

F0511.ai

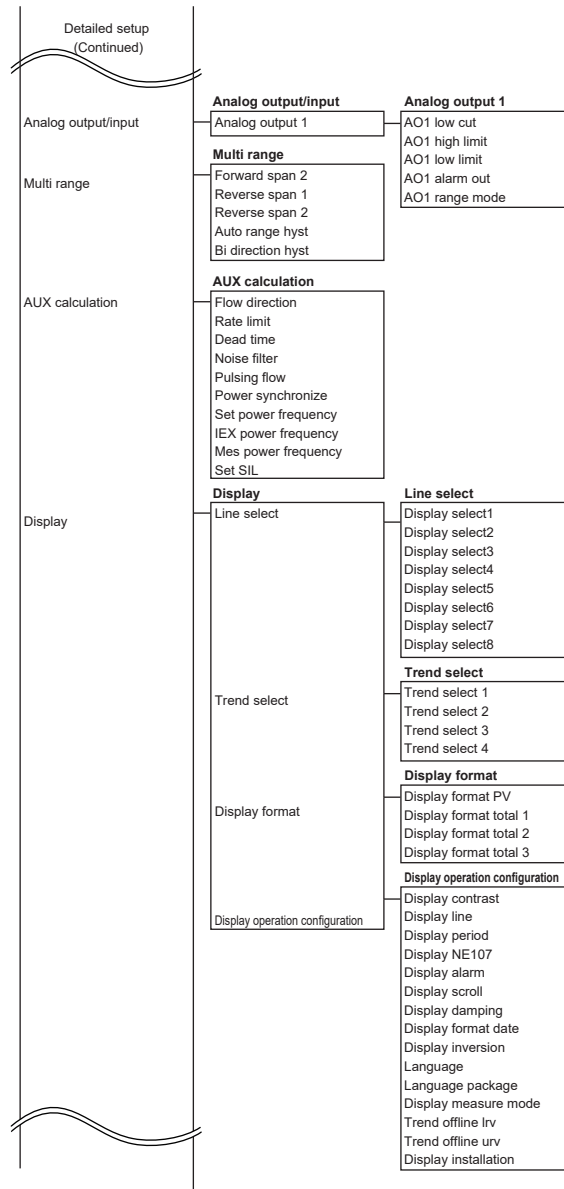

F0512.ai

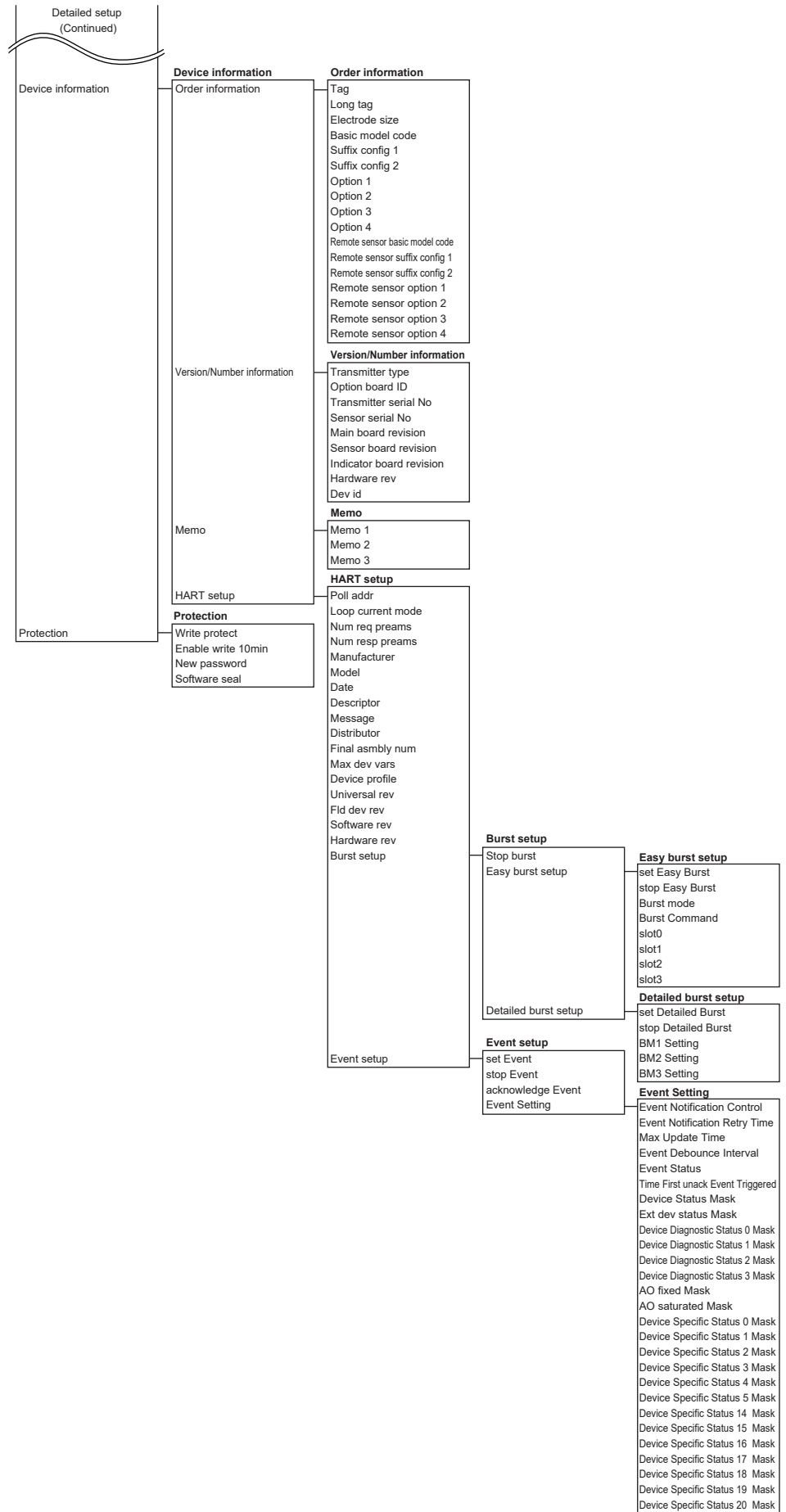

F0513.ai

Device status
Process applied to the primary variable is outside the operating limits of the field device
Process applied to the non-primary variable is outside the operating limits of the field device
PV Analog Channel Saturated
PV Analog Channel Fixed
Field device has more status available
A reset or self test of the field device has occurred, or power has been removed and reapplied
A modification has been made to the configuration of the field device
Field device has malfunctioned due to a hardware error or failure

Status group 0
10:Main board CPU failure
11:Reverse calculation failure
12:Main board EEPROM failure
13:Main board EEPROM default

Status group 1
14:Sensor board failure
15:Sensor communication error
16:A/D1 failure[Signal]
17:A/D2 failure[Exciter]
18:Coil open
19:Coil short
20:Exciter failure

Status group 2
21:PWM1 stop
22:PWM2 stop
23:Option board mismatch
24:Option board EEPROM failure
25:Option board A/D failure
26:Option board SPI failure

Status group 3
27:Parameter restore incomplete
28:Indicator board failure
29:Indicator board EEPROM failure
30:LCD driver failure
31:Indicator board mismatch
32:Indicator communication error
33:microSD failure

Status group 4
50:Signal overflow
51:Empty pipe detection
52:H/L or HH/LL alarm
53:Adhesion over level 4

Status group 5
60:Span configuration error
62:Analog output 1 4-20mA limit error
64:Analog output 1 multi range error
65:H/L HH/LL configuration error
66:Density configuration error

Ext dev status
Maintenance required
Device variable alert
Critical Power Failure
Failure
Out of Specification
Function Check

Device Diagnostic Status 0
Simulation Active
Non-Volatile Memory failure
Volatile Memory error
Watchdog reset executed
Voltage conditions out of range
Environmental conditions out of range
Electronic failure
Device Configuration Locked

Device Diagnostic Status 1
Status Simulation Active
Discrete Variables Simulation Active
Event Notification Overflow

AO saturated
Secondary Analog Channel Saturated
Tertiary Analog Channel Saturated
Quaternary Analog Channel Saturated
Quinary Analog Channel Saturated

I/O and Subdevice Status
Subdevice list changed
Duplicate master detected
Subdevice Mismatch
Subdevice with Duplicate IDs Found
Stale Data Notice

WirelessHART Status
Capacity Denied
Bandwidth Allocation Pending
Block Transfer Pending
Radio Failure

AO fixed
Secondary Analog Channel Fixed
Tertiary Analog Channel Fixed
Quaternary Analog Channel Fixed
Quinary Analog Channel Fixed

Status group 14
67:Pulse output 1 configuration error
68:Pulse output 2 configuration error
69:Nominal size configuration error
70:Adhesion configuration error
72:Data logging not started

Status group 15
80:Analog output 1 saturated
82:Pulse output 1 saturated
83:Pulse output 2 saturated
85:Cable misconnect
86:Coil insulation warning
131:Transmitter type mismatch

Status group 16
87:Adhesion over level 3
92:Autozero warning
93:Verification warning

Status group 17
95:Simulation active
96:Analog output 1 fixed
98:Pulse output 1 fixed
99:Pulse output 2 fixed

Status group 18
101:Parameter restore running
102:Display over warning
103:microSD size warning
104:Parameter backup incomplete
105:microSD card mismatch
106:microSD card removal procedure error

Status group 19
120:Watchdog
121:Power off
122:Instant power failure
123:Parameter backup running
124:Data logging running

Status group 20
130:Device ID not entered

Revision Information

- Title : ADMAG TI Series AXW Magnetic Flowmeter HART Communication Type
- Manual No. : IM 01E24A02-02EN

Edition	Date	Page	Revised Item
1st	June 2017	—	New publication
2nd	Oct. 2017	27 35 67 69 74 90 107 118	4.1.7 Change the units in the example. 4.3.4 Delete NOTE about pulse output. 4.11.5 Change NOTE about wiring connection diagnostic function. 4.11.6 Add NOTE about verification function. 4.13.2 Add the description about display of the restore result. 5.1 (2) Change the default value of No.2-11. 5.1 (10) Change the default value of No.10-1. 5.1 (14) Change the HART communication menu path of No.14-12.
3rd	Mar. 2018	84 119	4.13.4 Change the choices of process values stored by data logging function. 5.1 (14) Change the range of No.14-18 to No.14-21.
4th	Mar. 2020	— 9 24 55 62 69	Incorporate the manual change 19-0018-E. Correction of errors. 2.2.1 Add NOTE. 4.1.2 Add the setting example. 4.8.4 Add the setting example. 4.9.4 Add NOTE. 4.11.4 Add IMPORTANT.