

GMS840

Enclosure for GMS800 Series

Description, Installation, Technical Data

SICK
Sensor Intelligence.



Described Product

Product name: GMS840
Variants: GMS840 (standard)
GMS841 (ATEX/ IECEx)
GMS842 (cCSA_{US})

Manufacturer

SICK AG
Erwin-Sick-Str. 1 · 79183 Waldkirch · Germany
Phone: +49 7641 469-0
Fax: +49 7641 469-1149
E-Mail: info.pa@sick.de

Place of Manufacture

SICK AG
Poppenbütteler Bogen 9b · 22399 Hamburg · Germany

Legal Information

This work is protected by copyright. All rights derived from the copyright shall be reserved for SICK AG. Reproduction of this document or parts of this document is only permissible within the limits of the legal determination of Copyright Law. Any modification, shortening or translation of this document is prohibited without the express written permission of SICK AG. The trademarks stated in this document are the property of their respective owner.

© SICK AG. All rights reserved.

Original document

This document is an original document of SICK AG.









1	For your Safety	5
1.1	Symbols and document conventions	5
1.1.1	Warning symbols	5
1.1.2	Warning levels and signal words.....	5
1.1.3	Information symbols	6
1.2	Responsibility of user.....	6
1.3	Scope of application	7
1.3.1	Principal application limitations.....	7
1.4	Main safety information.....	7
1.5	Additional documentation/information.....	7
2	Product Description.....	9
2.1	Product identification.....	9
2.1.1	Type plate.....	9
2.2	Product description.....	10
2.2.1	Product characteristics.....	10
2.2.2	Options	10
2.3	Opening the enclosure cover	11
2.3.1	Safety measures before opening the enclosure	11
2.3.2	Opening the enclosure	13
3	Installation.....	14
3.1	Safety during transport and assembly	14
3.1.1	For GMS841 (ATEX/ IECEx) and GMS842 (cCSA _{US}).....	14
3.2	Scope of delivery.....	14
3.3	Assembly	15
3.3.1	Ensuring ambient conditions	15
3.3.2	Fitting the enclosure.....	15
3.4	Special protective measures (as required).....	15
3.4.1	Protecting against dangerous sample gases	15
3.4.2	Protecting against corrosive atmospheres.....	15
3.4.3	For GMS841 (ATEX/ IECEx) and GMS842 (cCSA _{US}).....	16
3.5	Gas connections.....	16
3.5.1	Sample gas inlet	16
3.5.2	Sample gas outlet.....	16
3.5.3	Feeding purge gas to an Analyzer module (option).....	16
3.5.4	Feeding purge gas for the enclosure (option)	16
3.6	Electrical connections.....	17
3.6.1	Opening the enclosure	17
3.6.2	Connecting the power connection	18
3.6.3	Connecting the signal connections (as required).....	19
3.6.3.1	I/O module (standard)	19
3.6.3.2	Intrinsically safe signal connections (option)	19
3.6.4	Connecting the interfaces (as required)	19

- 3.7 Intrinsically safe signal connections (option) 20
 - 3.7.1 Technical design..... 20
 - 3.7.2 Installation information..... 21
 - 3.7.3 Limit values for intrinsically safe signal connections 21
- 3.8 Closing the enclosure tight..... 21
- 4 Start-up of GMS841 (ATEX/ IECEx) and GMS842 (cCSA_{US}) 22**
- 5 Maintenance..... 23**
 - 5.1 Safety information 23
 - 5.2 Maintenance interval..... 23
 - 5.3 Maintenance work on the enclosure 23
 - 5.4 Cleaning of the enclosure 23
 - 5.5 Leak tightness check..... 24
 - 5.5.1 Checking the leak tightness of sample gas lines 24
 - 5.5.2 Checking the leak tightness of purge gas paths..... 24
- 6 Shutdown 25**
 - 6.1 Preparations for shutdown..... 25
 - 6.2 Before shutdown..... 25
 - 6.3 Shutdown with GMS841 (ATEX/ IECEx) and GMS842 (cCSA_{US})..... 25
 - 6.3.1 Shipping for repair..... 25
- 7 Compliances and Standards 26**
- 8 Technical Data 27**
 - 8.1 Dimensions, fitting position and connections 27
 - 8.1.1 Dimensions..... 27
 - 8.1.2 Torques 28
 - 8.1.3 Position of connections..... 29
 - 8.2 Enclosure specifications 30
 - 8.3 Ambient conditions..... 30
 - 8.4 Gas connections 30
 - 8.5 Power connection 31
 - 8.6 Electrical safety/ EMC 32
 - 8.7 Technical data for intrinsically safe signal connections 32
 - 8.7.1 Limit values for intrinsically safe analog outputs 32
 - 8.7.2 Limit values for intrinsically safe digital inputs and digital outputs 32

1 For your Safety

1.1 Symbols and document conventions

1.1.1 Warning symbols

Symbol	Significance
	Hazard (general)
	Hazard by voltage
	Hazard in potentially explosive atmospheres
	Hazard by high temperature or hot surfaces
	Hazard by explosive substances/mixtures
	Hazard by toxic substances
	Hazard for the environment/nature/organic life

1.1.2 Warning levels and signal words

DANGER

Risk or hazardous situation which *will* result in severe personal injury or death.

WARNING

Risk or hazardous situation which *could* result in severe personal injury or death.





CAUTION

Hazard or unsafe practice which *could* result in less severe or minor injuries.

NOTICE

Hazard which *could* result in property damage.

1.1.3 Information symbols

Symbol	Significance
	Information on product condition with regard to protection against explosions (general)
	Note on product properties with regard to Explosion Protection Directive ATEX 2014/34/EU
	Important technical information for this product
	Important information on electric or electronic functions

1.2 Responsibility of user

- Make sure the user has read and understood this Addendum to the Operating Instructions, the Operating Instructions of the device and the safety instructions.
- Observe all safety instructions.
- If there is something you do not understand: Contact SICK Customer Service.
- This Manual presumes that the device has been delivered as specified during project planning (i.e., based on the SICK application questionnaire) and the relevant delivery state of the device (see delivered System Documentation).
 - Contact SICK Customer Service if you are not sure whether the device corresponds to the state defined during project planning or to the delivered system documentation.
- Only use the device as described in “intended use”; the manufacturer assumes no responsibility for any other use.
- Maintenance work should be performed as prescribed in this Manual.
- Do not attempt any work on or repairs to the device unless described in this Manual.
- Do not remove, add or change any components in or on the device unless such changes are officially allowed and specified by the manufacturer
Failure to observe these precautions could result in:
 - voiding the manufacturer's warranty
 - the device could become dangerous
 - the approval for use in potentially explosive atmospheres is no longer valid

1.3 Scope of application

1.3.1 Principal application limitations

- Do not use GMS840 and GMS842 to measure combustible gases when no additional safety precautions have been taken (see Info box).
- Do not use GMS840 in potentially explosive atmospheres.
- Only use GMS841 (ATEX/ IECEx), or GMS842 (CSA US) in the Ex zones stated on the type plate.
- GMS841 is not intended for measurement of combustible gases.
- GMS840, GMS841 and GMS842 are not intended for sample gas mixtures specified as explosive atmosphere.



If the sample gas is combustible or can create a flammable gas mixture with air, there can be a risk of explosions when a defect causes a leak in internal gas paths. Therefore, applications with combustible sample gas require additional safety precautions (e.g. permanent enclosure purging with a protective gas, warning devices).

1.4 Main safety information

Only for GMS841 (ATEX/ IECEx)



WARNING: Risk of explosions in potentially explosive atmospheres

- ▶ Do not open the enclosure when an explosive atmosphere is present
- ▶ If the enclosure has been opened: Check the enclosure for leak tightness before restarting, [page 22](#).



WARNING: Possibility of explosive gas in the enclosure

The enclosure is not gas-tight.

This means: Explosive gas can accumulate in the enclosure when used in Ex zones.

- ▶ Be aware that after use in Ex zones, explosive gas can still be in the enclosure outside of the Ex zone.



WARNING: Risk of explosion during transport and assembly

- ▶ Do not transport the device in potentially explosive atmospheres
- ▶ Do not carry out work on the device in potentially explosive atmospheres
- ▶ Only use tools approved for Ex zones.

Dangerous sample gases



WARNING: Risk of explosion due to combustible gases

- ▶ Do not use the enclosure GMS84x to measure combustible gases when no additional safety precautions have been taken.

In hazardous situations

- ▶ Actuate the emergency-stop switch or switch the main switch of the host system off.

1.5 Additional documentation/information

This document supplements the Operating Instructions “GMS800 Series”. It extends these Operating Instructions with technical information on the Enclosures GMS84x.

- ▶ Observe the Operating Instructions delivered with the “GMS800 Series”.

- ▶ If these Operating Instructions are not available in your language: Pay attention to the delivered safety information document (in 24 official EU languages). this safety information document is a summary of the safety information and warnings of the GMS800 series and of the enclosure variants.



The "GMS800 Series" Operating Instructions also specify all further documents belonging to the individual device.



NOTE:

- ▶ Pay primary attention to any individual information provided.

Other documents delivered

Operating Instructions of the safety barriers [1]

Operating Instructions RJ45 connector

[1] Only for versions with intrinsically safe signal connections, see ["Intrinsically safe signal connections \(option\)"](#), page 20.

2 Product Description

2.1 Product identification

Product name	Characteristic
GMS840 (standard)	---
GMS842 (cCSA _{US})	cCSA _{US} 500 (Class I, DIV2, Grp.A,B,C,D;T4) cCSA _{US} 505 (Class I, Zone 2, Ex nA nC IIC T4 Gc) Ex nA nC IIC T4 Gc
GMS841 (ATEX/ IECEx) 	Ex nA nC IIC T4 Gc Ex nA nC [ia Ga] IIC t4 Gc (intrinsically safe)

2.1.1 Type plate

► Observe the product identification on the type plate.

The type plate is located on the right side of the enclosure.

The product name of the enclosure is shown on the type plate.

The following type plates serve as examples:

Type plate GMS840 (standard)

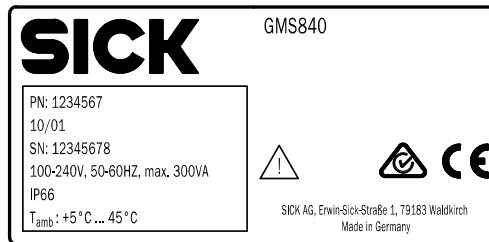

Type plate GMS841 (ATEX/ IECEx)

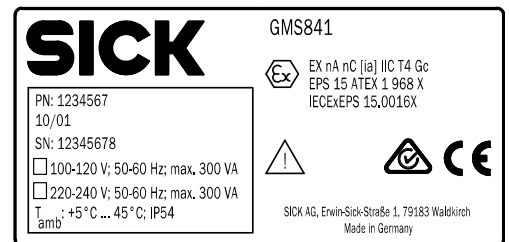
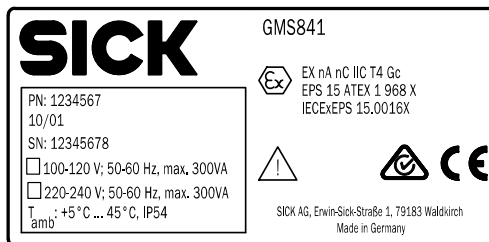

Type plate GMS842 (cCSA_{US})

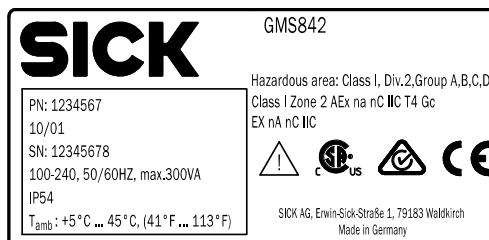

2.2 Product description

Fig. 1: GMS840



2.2.1 Product characteristics

Common characteristics

- Closed sheet steel enclosure for wall mounting
- For use indoors
- Degree of protection IP 66
- If required, the enclosure can be purged with inert gas; openings for purge gas connections are available (standard: Closed with sealing plugs, option: Screw fittings for hose or pipe connection)

2.2.2 Options

- Intrinsically safe signal connections
- Gas connections (alternative) for
 - Span gas
 - Second sample gas path
 - Purge gas for an Analyzer module
- Purge gas connections for the enclosure

2.3 Opening the enclosure cover

2.3.1 Safety measures before opening the enclosure

Only open the enclosure in a dry, dust-free room.



CAUTION: Risk of burns on hot components

Hot components are marked with a label (see left).
 ► Do not touch hot components



WARNING: Health risks/accident risks

If

- the GMS84x measures toxic, dangerous or combustible gases
 - the GMS84x is in a potentially explosive atmosphere
 - it is suspected that the internal gas paths have a leak
- then carry out the following measures before opening the enclosure:



- 1 Interrupt every gas feed to the GMS84x apart from the purge gas feed (when present).
 - 2 Switch the power supply to the GMS84x off at an external source.
 - 3 In potentially explosive atmospheres (only GMS841 (ATEX/ IECEx) and GMS842 (cCSA_{US}): Disconnect the GMS84x from all external voltages (e.g. signal lines).
 Exception: Connections to intrinsically safe power circuits can remain connected.
 - 4 If enclosure purging is installed: Wait for an appropriate time so that the enclosure is purged with inert gas.
 - 5 If necessary, take protective measures against escaping gases (e.g. breathing protection, suctioning off).
- Some components are hot: Before touching components: Observe the cooling time
 ► Only open the enclosure when it is safe to do so



WARNING: Risk of injury through contact with toxic sample gas

Accumulated sample gas can escape when the enclosure is opened. Depending on the quantity and composition of the gas, this can cause serious injuries when the respiratory system and the skin have direct contact with the gas.
 ► Always switch the device off before opening the enclosure.
 ► Perform all steps of the shutdown procedure, see [“Shutdown procedure”, page 25](#).
 ► Wear the specified protective clothing.

For GMS841 (ATEX/ IECEx) and GMS842 (cCSA_{US}):



WARNING: Risk of explosion when the enclosure is opened incorrectly

► Do not open the enclosure when an explosive atmosphere is present.



WARNING: Possibility of explosive gas in the enclosure

The enclosure is not gas-tight.
 This means: Explosive gas can accumulate in the enclosure when used in Ex zones.
 ► Be aware that after use in Ex zones, explosive gas can still be in the enclosure outside of the Ex zone



WARNING: Risk of explosion when the grounding cable to the enclosure cover is defective

► When the grounding cable has been put under traction during opening of the enclosure cover or the cover has been dropped: Check the grounding cable for damage and replace if necessary.

Electrical safety



NOTE:

Electrostatic discharges can severely damage electronic components.

- ▶ *Before touching electrical connections and internal components:* Ground your body and tools used to discharge electrostatic charges.

Recommended method:

- ▶ *If the protective conductor is connected:* Touch a blank metal part of the enclosure.
 - ▶ *Otherwise:* Touch a different blank metal surface that is connected to the protective conductor or has safe contact to the grounding.
-

2.3.2 Opening the enclosure



Hinges on enclosure cover

- If the cover is attached with hinges, it can be swiveled up.
- The hinges can be removed.
- Without hinges, the cover can only be removed downwards and then hung in.

Enclosure with hinges (opening to the top):

- 1 Loosen the lock.
- 2 Lift the cover on both sides with the whole palm of your hand and fold away upwards.

Fig. 2: Opening to the top

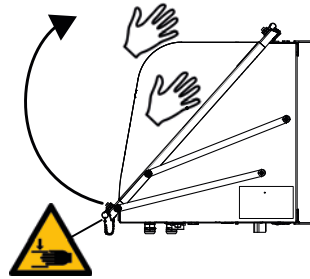

Enclosure without hinges (opening to the bottom)

- 1 Loosen 4 M5 screws (the screws are connected to the enclosure to prevent the risk of loss).
- 2 Hold the cover on both sides and pull forwards.
- 3 Hinge the cover in underneath in the enclosure tabs (the cover has appropriate recesses).



NOTICE:

Do not crimp the LAN cable and/or grounding cable.

- ▶ Lay the cable into the provided guide

Fig. 3: Opening to the bottom

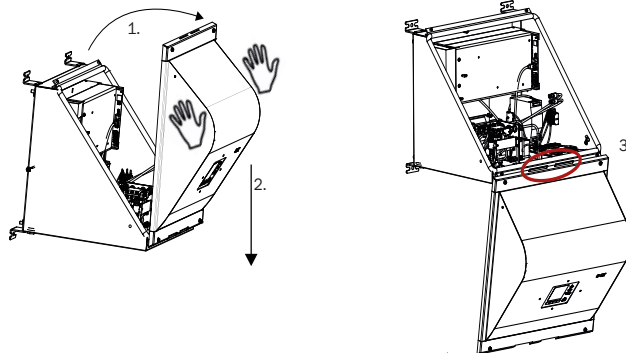

3 Installation

3.1 Safety during transport and assembly

**CAUTION: Risk of injury**

- ▶ Consider the weight of the enclosure before lifting, see “Enclosure specifications”, page 30.
 - ▶ Call in further personnel as assistants as required.
-

**CAUTION: Risk of injury**

There is a risk of injuries should the enclosure drop down due to the weight of the device and through hard, protruding enclosure parts.

During transport and assembly:

- ▶ Wear safety shoes. Wear non-slip gloves.
 - ▶ Handle the device carefully and safely. Secure during transport. Avoid falls and collisions.
 - ▶ Call in further personnel as assistants as required.
-

**NOTE: Risk of damage**

- ▶ Do not use gas connections and cable inlets as lifting points.
-

3.1.1 For GMS841 (ATEX/ IECEx) and GMS842 (cCSA_{US})

**WARNING: Risk of explosion through sparks**

- ▶ Do not carry out work on the device in potentially explosive atmospheres.
 - ▶ Do not unpack the device in potentially explosive atmospheres.
 - ▶ Only use an adequate packaging for transportation of the device
 - ▶ Only use tools approved for Ex zones.
-

3.2 Scope of delivery

Please see the delivery documents for the scope of delivery.

3.3 Assembly



Dimensions, see “Dimensions, fitting position and connections”, page 27.

3.3.1 Ensuring ambient conditions

Vibration

- ▶ Protect the device against heavy jolts and vibrations. Limit values, see “Ambient conditions”, page 30.

Temperature

- ▶ Avoid enclosure exposure to direct sunlight.
- ▶ Maintain the allowable ambient temperature during operation, see “Ambient conditions”, page 30.

Moisture

- ▶ Choose a dry installation location free from frost.
- ▶ Prevent moisture condensation – inside the device as well.
- ▶ Maintain the allowable air humidity, see “Ambient conditions”, page 30.

3.3.2 Fitting the enclosure



CAUTION: Accident risk through inadequate fastening of the enclosure

- ▶ Observe the weight of the enclosure of approx. 30 kg
 - ▶ Observe the sufficient carrying capacity of the wall or the rack.
Use adequate “Cavity dowels metal” with an allowable load of at least 30 kg for gypsum plasterboard walls.
-
- ▶ This enclosure is only suitable for attachment on a wall.
 - ▶ Secure the enclosure on a wall that can safely carry the weight of the enclosure.

3.4 Special protective measures (as required)

3.4.1 Protecting against dangerous sample gases

If the sample gas can be dangerous to health and/or corrosive:

- ▶ Make sure no dangerous situations can arise should a gas leak occur
- ▶ Check:
 - Whether a gas detector must be installed at the installation location.
 - Whether the enclosure must be purged continuously with a neutral gas during operation (with monitoring the discharged purge gas as required).
 Install appropriate additional devices as necessary.
- ▶ Check gas paths regularly for leak tightness.

3.4.2 Protecting against corrosive atmospheres

When the atmosphere at the installation location can contain corrosive gases:

- ▶ Install the GMS84x enclosure in an outer housing (e.g. closed cabinet). Purge the outer housing with an inert gas.

3.4.3 For GMS841 (ATEX/ IECEx) and GMS842 (cCSA_{US})



WARNING: Risk of explosion

- ▶ Assembly may only be carried out by trained personnel.
 - ▶ Do not carry out work on the device in potentially explosive atmospheres.
 - ▶ Only use tools approved for Ex zones.
 - ▶ If necessary: Install lightning protection.
-

3.5 Gas connections

3.5.1 Sample gas inlet

General notes

Information and safety information on sample gas connections

- ▶ See Operating Instructions, “GMS800 Series”.
- ▶ See Addenda to the Operating Instructions for the fitted Analyzer modules.



Gas connections see “Dimensions, fitting position and connections”, page 27

3.5.2 Sample gas outlet



WARNING: Risk of injury through contact with sample gas emerging uncontrolled when the sample gas discharge is incorrectly dimensioned

Depending on the composition of the sample gas, a leak of the exhaust gas line or improper design of the exit point of the gases can cause serious injuries to the skin and respiratory system. For safe disposal of the sample gases:

- ▶ Design and install the exhaust gas line according to the mandatory occupational safety regulations in the plant.
 - ▶ Determine the correct length of the exhaust hose and the maximum pressure head during the design of the exhaust gas lines.
 - ▶ Screw the connections of the exhaust gas line tight, e.g. using 6 mm Swagelok screws.
 - ▶ Regularly check the exhaust gas line for leaks.
-

3.5.3 Feeding purge gas to an Analyzer module (option)

Only valid for versions with purge gas connections for an Analyzer module.

- ▶ Feed and discharge the necessary purge gas via the purge gas connections “Purge” as described in the Addendum to the Operating Instructions of the Analyzer module, see “Dimensions, fitting position and connections”, page 27.
- ▶ Feed and channel off purge gas so that the purge gas pressure in the line is not above 30 mbar.
- ▶ Use nitrogen (techn.) as inert gas.

3.5.4 Feeding purge gas for the enclosure (option)

- ▶ Feed the desired inert gas through the enclosure (see “Dimensions, fitting position and connections”, page 27) via the purge gas connections.



CAUTION: Safety risk

- ▶ Keep unused purge gas connections closed with the delivered sealing plugs. Otherwise the specified enclosure degree of protection is not ensured.
-

3.6 Electrical connections

3.6.1 Opening the enclosure

- ▶ Open the enclosure, see “Opening the enclosure cover”, page 11.



WARNING: Observe the safety information

Observe the safety information in Chapter “Opening the enclosure cover”, page 11.

Fig. 4: Electrical connections

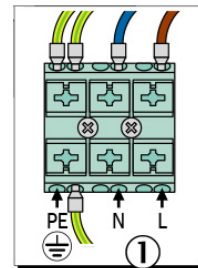
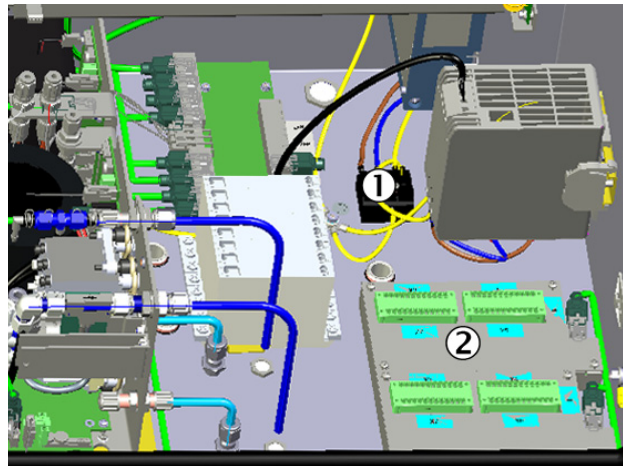

- ① Power connection terminals
- ② I/O module (signal connections)



The cable inlets are suitable for cables with outer diameter 7 ...12 mm

To connect the electric lines:

- ▶ Press on the power connection terminal with a screwdriver and insert the line.

3.6.2 Connecting the power connection

Safety information and standards

- ▶ Standards to be applied: IEC 60947-1 and IEC 60947-3
- ▶ Check whether the available power voltage matches the type plate specifications. If this is not the case: Do not connect the device.



WARNING: Health risk

Ensure electrical safety:

- ▶ Only connect the device to a main power supply which has a functional protective conductor (PE to PA, see “Position of connections”, page 29).
- ▶ Only start the device when a correct protective conductor is installed.
- ▶ Do not disconnect protective conductor connections.

Installing an external power fuse

Install an external circuit breaker in the main power supply.

- Fuse rating and trigger characteristic:
 - Power voltage 115V AC circuit breaker for 16 Ampere characteristic C
 - Power voltage 230V AC circuit breaker for 16 Ampere characteristic B



Internal power fuses:

- Primary: Fuse in internal power supply unit (6.3 A)
If this fuse triggers: Replace the power supply unit
- Secondary: Fusible cutout on the internal “distribution board” (on CANopen connections);
If this fuse triggers: Clear the malfunction cause and replace the fusible cutout with an identical type (F10AH250V)

Installing an external main power switch

- ▶ Install a power disconnecter switch close to the device (all poles).
- ▶ Mark the power disconnecter switch clearly.

Install the power connection



WARNING: Health risk

- ▶ *Before installing the power cable:* Make sure the external main power supply is switched off.



Technical requirements to the power cable, see “Power connection”, page 31.

- 1 Open the enclosure cover.
- 2 Insert the power cable through a cable inlet. Use an EMC connection.
- 3 Lay a shielding on the EMC connection.
- 4 Connect the power cable to the power connection terminals, see “Electrical connections”, page 17.
- 5 Close the cable gland on the cable.
- 6 Connect the external PA connection with the same electrical potential as the internal PE connection.



WARNING: Risk of explosion of GMS841 (ATEX/ IECEx) and GMS842 (cCSAUS)

- ▶ Only use “identical” material suitable for PA connections.
- ▶ Observe the start-up before switching on the power supply: see “Start-up of GMS841 (ATEX/ IECEx) and GMS842 (cCSAUS)”, page 22.

3.6.3 Connecting the signal connections (as required)

3.6.3.1 I/O module (standard)

The standard version has a built-in I/O module. A second I/O module can be fitted (option).

- ▶ Position of signal connections, see [“Electrical connections”, page 17](#).
- ▶ Function of signal connections → “I/O module” Addendum to Operating Instructions.
- ▶ The cables have to be approved for the relevant application.
 - Only use sufficiently screened cables.
 - The shielding braid has to end in the cable duct.
 - Shorten the shielding braid accordingly.

Fig. 5: Shielding braid



3.6.3.2 Intrinsically safe signal connections (option)

see [“Intrinsically safe signal connections \(option\)”, page 20](#).

3.6.4 Connecting the interfaces (as required)



Function of interfaces → Operating Instructions “GMS800 Series”.

To use an interface:

- ▶ Connect the interface cable to the corresponding interface inside the enclosure, see [“Electrical connections”, page 17](#).

3.7 Intrinsically safe signal connections (option)

3.7.1 Technical design

When the GMS841 (ATEX/ IECEx) is used in Ex zones, the analog outputs, digital inputs and outputs have to be realized as intrinsically safe signal connections when the signals are used in an Ex zone.

Additional modules are fitted for this purpose (safety barriers). All intrinsically safe connections are configured according to customer requirements.

- Terminal assignment → Individual information delivered with the device
- Technical information on intrinsically safe signal connections and switching, see delivered Operating Instructions of the safety barriers.

Fig. 6: Safety barriers

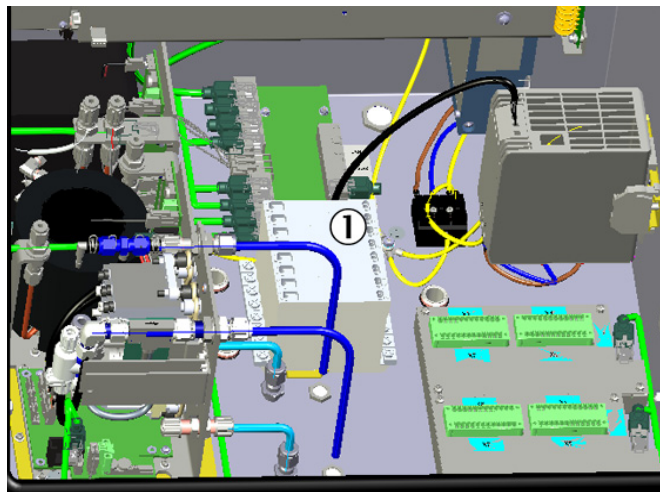

① Location of safety barriers

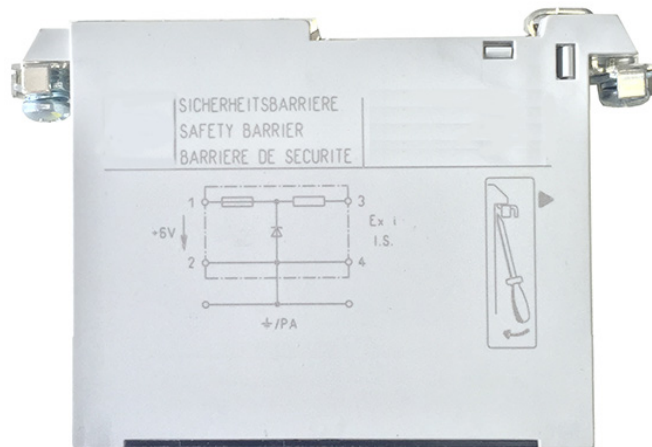

Intrinsically safe values, see “Technical data for intrinsically safe signal connections”, page 32.

3.7.2 Installation information



NOTE:
Execute cable installation according to EN 60079-14.

Cable installation

- ▶ Connect each signal cable for intrinsically safe signal connections to one built-in additional module, see “Safety barriers”, page 20.
- ▶ Install the signal cables in compliance with EN 60079-11 (“Explosive Atmospheres - Part 11: Equipment protection by intrinsic safety “i””).
- ▶ Maintain electronic limit values, see “Limit values for intrinsically safe signal connections”, page 21.
- ▶ Install all components of a signal circuit intrinsically safe.



WARNING: Risk of explosion

Intrinsically safe installations must maintain a certain clearance from other electrical equipment (specifications see EN 60079-11).

- ▶ Install cables of “intrinsic safety” circuits in such a way that the required distance to other electrical devices is always maintained.

3.7.3 Limit values for intrinsically safe signal connections

Intrinsic safety of the connected intrinsically safe signal circuit is only ensured when the power circuit, including cables, maintains the limit values specified below.



CAUTION: Lower limit values could possibly be applicable

Lower limit values could be applicable for the individual application case. The composition of the potentially explosive atmosphere is decisive here.

- ▶ Determine the highest allowable limit values for the individual application case using the European standard EN 60079-0 “Explosive atmospheres. Equipment. General requirements”.
- ▶ *If this results in limitations:* Note these limitations (e.g. in this document) and consider during installation.



- Limit values for intrinsically safe analog outputs, see “Limit values for intrinsically safe analog outputs”, page 32.
- Limit values for intrinsically safe digital inputs and digital outputs, see “Limit values for intrinsically safe digital inputs and digital outputs”, page 32.

3.8 Closing the enclosure tight



Observe the following in order to maintain the IP66 qualification of the enclosure:

- The sealing surfaces must have complete, undamaged and full surface contact.
- Tighten the screws to the stop.
- Check the state of the cable glands for completeness and functionality.
- Close unused connections with the dummy plugs provided.

4 Start-up of GMS841 (ATEX/ IECEX) and GMS842 (cCSAUS)



WARNING: Risk of explosion

- ▶ Do not carry out work on the device in potentially explosive atmospheres.
- ▶ Only use tools approved for Ex zones.

Before start-up

- ▶ Make a visual leak check of the enclosure (enclosure cover, cable inlet and gas inlets). If the enclosure is deformed or damaged: Do not put the enclosure GMS84x into operation and secure against unauthorized start-up.
- ▶ If the enclosure was opened: Make sure the atmosphere in the enclosure is not inflammable.

Fig. 7: Power supply unit

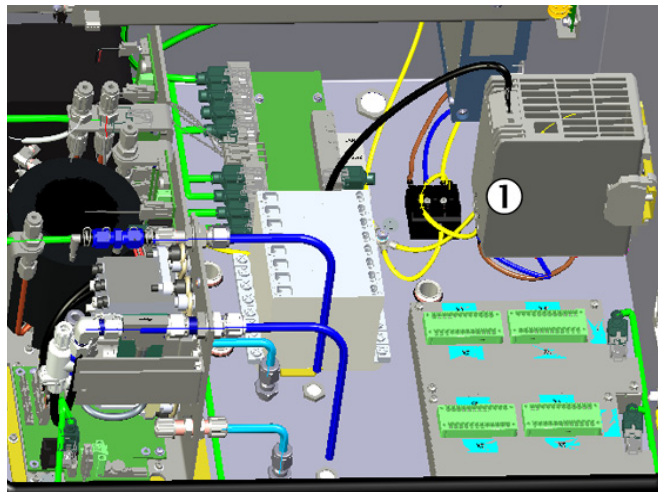

① Power supply unit

- 1 Before switching on: If work was carried out on the power supply unit: Before switching on make sure that a correct power supply unit (compliant with CCSAUS or ATEX/IECEX) has been installed.
- 2 Seal the enclosure tight, see [“Closing the enclosure tight”](#), page 21.
- 3 If the enclosure has purge gas connections (option): Put the purge gas supply into operation.
- 4 Put the device into operation.

5 Maintenance

5.1 Safety information



WARNING: Observe the safety information

Observe the safety information in Chapter [“Opening the enclosure cover”](#), page 11.

For GMS841 (ATEX/ IECEx) and GMS842 (cCSA_{US})



WARNING: Risk of explosion

- ▶ Do not carry out work on the device in potentially explosive atmospheres.
- ▶ Only use tools approved for Ex zones.

Before commencing maintenance work

Purge the sample gas path for 15 minutes with 60l/h with a dry, neutral gas before commencing maintenance work.

5.2 Maintenance interval

- Maintenance interval: 1 year

5.3 Maintenance work on the enclosure

- ▶ Check all connections for tight seat. Especially check the grounding cable to the cover.
- ▶ Check the device and the connections for corrosion.
- ▶ Switch device free from voltage.
- ▶ Open the device.

Also observe: [“Safety measures before opening the enclosure”](#), page 11.

- Check the inside of the device for contamination.
- Check if the seals are clean and free of damage.
- Check all lines for tight seat.

5.4 Cleaning of the enclosure



WARNING: Endangerment of electrical safety by cleaning the enclosure with liquids.

Cleaning with water or other cleaning liquids can damage the electronics and therefore compromise safe operation of the device.

- ▶ Always clean signs and other surfaces only with a damp cloth.



WARNING: Hazardous situation when liquids penetrate the system

If liquids have penetrated the equipment:

- ▶ Do not touch the device any more.
- ▶ Shut the device down immediately by disconnecting the main power voltage at an external station (e.g. pull out the power cable at the socket or switch off the external power fuse).
- ▶ Contact the manufacturer’s customer service or other trained skilled persons able to repair the device.

5.5 Leak tightness check

5.5.1 Checking the leak tightness of sample gas lines



This check is an approval condition for the enclosures GMS841 (ATEX/ IECEx) and GMS842 (cCSA_{US}), see [“Main safety information”, page 7](#).

If the sample gas path was opened during maintenance work:

- ▶ Check the leak tightness of the connected sample gas lines after the maintenance work.

If it is suspected that the sample gas path could become leaky during operation (e.g. due to special sample gas properties):

- ▶ Check the leak tightness of the connected sample gas lines in regular intervals.



Leak tightness check procedure → “GMS800 Series” Operating Instructions

5.5.2 Checking the leak tightness of purge gas paths

Only valid for versions with purge gas connections, see [“Feeding purge gas for the enclosure \(option\)”, page 16](#)/[“Feeding purge gas for the enclosure \(option\)”](#).

- ▶ Check the leak tightness of purge gas paths at least once a year.
- ▶ Check in the same manner as for leak tightness of sample gas lines (procedure → Operating Instructions “GMS800 Series”).

6 Shutdown



WARNING: Observe the safety information

Observe the safety information in Chapter [“Opening the enclosure cover”](#), page 11.

6.1 Preparations for shutdown

- ▶ Purge the sample gas path with a dry, neutral gas (e.g. instrument air).

6.2 Before shutdown

- ▶ Purge the sample gas path for 15 minutes with 60l/h with a dry, neutral gas before commencing shutdown.
- ▶ Switch device free from voltage.

6.3 Shutdown with GMS841 (ATEX/ IECEx) and GMS842 (cCSAUS)



WARNING: Risk of explosion

- ▶ Disassembly may only be carried out by trained personnel.
- ▶ Do not carry out work on the device in potentially explosive atmospheres.
- ▶ Only use tools approved for Ex zones.

Also observe: [“Safety measures before opening the enclosure”](#), page 11.

Shutdown procedure

- ▶ Carry out the preparations for shutdown (→ “GMS800 Series” Operating Instructions).

After shutdown



WARNING: Risk of explosion

- ▶ Do not open the enclosure when an explosive atmosphere is present.



WARNING: Possibility of explosive gas in the enclosure

The enclosure is not gas-tight.

This means: Explosive gas can accumulate in the enclosure when used in Ex zones.

- ▶ Be aware that after use in Ex zones, explosive gas can still be in the enclosure outside of the Ex zone.

6.3.1 Shipping for repair

When the device is being sent to the manufacturer or a Service company for repairs:

Please enclose the following information so that the device can be repaired as quickly as possible:

- ▶ An error description, as precise as possible (meaningful keywords suffice)
- ▶ *For unclear functional problems:* A short description of the operating conditions and installations (connected devices etc.).
- ▶ *If shipping was agreed with the manufacturer:* The contact person at the manufacturer's who is informed about the matter.
- ▶ A contact person in the user's company (for possible questions).



Please add the information even if your matter has already been discussed with a manufacturer's employee.

7 Compliances and Standards

- EU Directive: LVD (Low Voltage Directive)
EN 61010-1: Safety requirements for electrical equipment for measurement, control, and laboratory use
- EU Directive: EMC (Electromagnetic Compatibility)
EN 61326-1: Electrical equipment for measurement, control and laboratory use - EMC requirements
- EU 2014/34/EU ATEX

Product name	Characteristic
GMS840 (standard)	---
GMS842 (cCSA _{US})	cCSA _{US} 500 (Class I, Div. 2 Grp.A;B;C;D) cCSA _{US} 505 (Class I, Zone 2, AEx nA nC IIC T4 Gc) Ex nA nC IIC
GMS841 (ATEX/ IECEx) 	Ex nA nC IIC T4 Gc Ex nA nC [ia Ga] IIC t4 Gc (intrinsically safe)

Further standards and guidelines: Refer to the Certificate of Conformity delivered with this device.

8 Technical Data

8.1 Dimensions, fitting position and connections

8.1.1 Dimensions

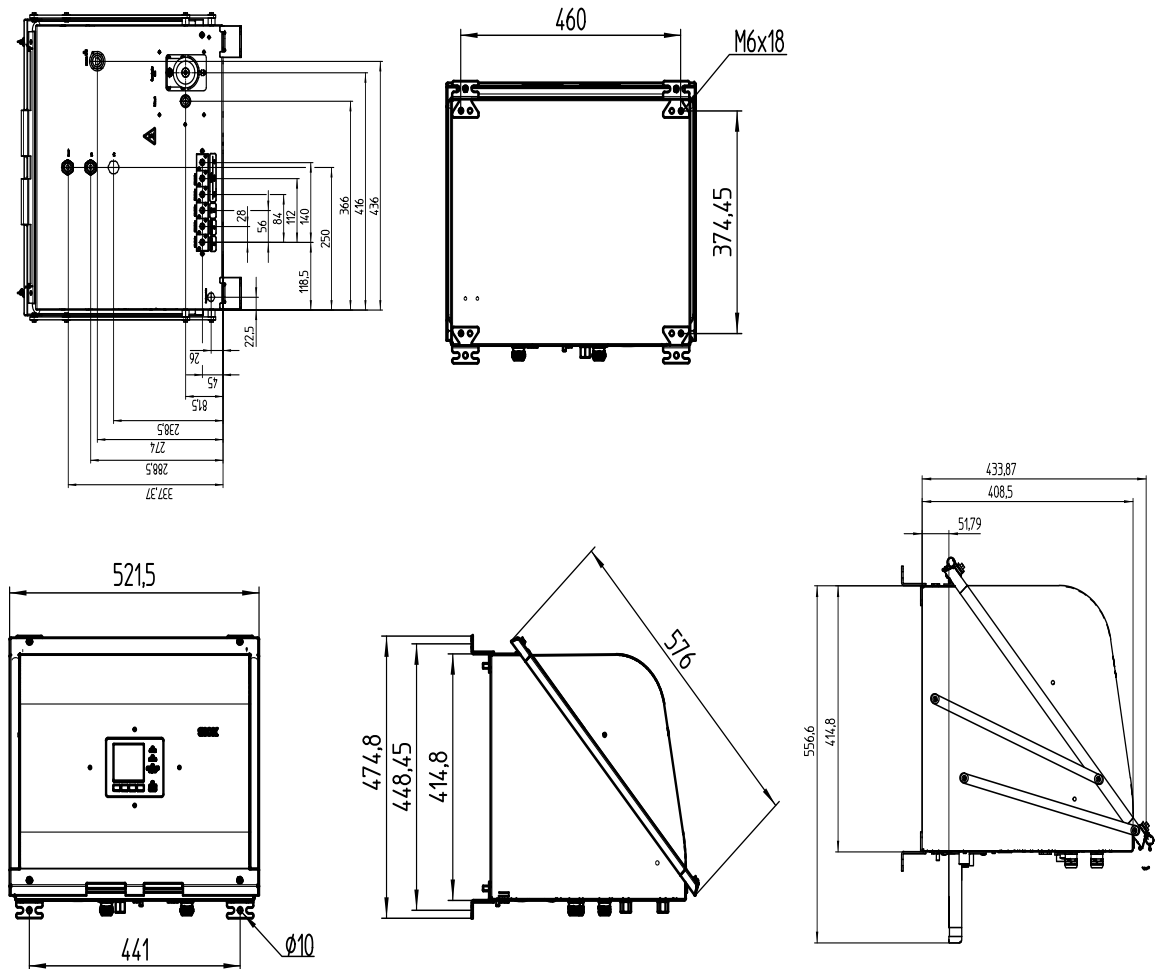

Only install the enclosure horizontally (cover opens downwards).



NOTE: Observe clearance

- For lines: Leave a clearance of approx. 200 mm under the cover.
- For the cover placement area: Leave a downward clearance of approx. 600 mm from the bottom edge of the enclosure and approx. 100 mm to the rear.

Fig. 8: Hinged cover

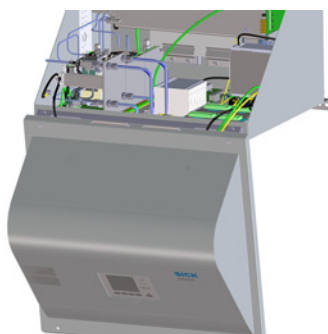

8.1.2 Torques

All screw connections for which no tightening torque or preload force is stated in drawings or assembly instructions are to be tightened according to VDI 2230.

All connections with screws which are not classic screw connections are excluded from this rule. This means strap retainers, cable glands, screw fittings, gas connections, screws for circuit boards etc. Here, the screw fittings have to be tightened as evenly as possible with a significantly lower tightening torque (strap retainers 1 Nm, other screw fittings according to manufacturer specification).

Select the next lower valid tightening torque for the screw for mixed materials and special screws as well as relieved screws.

The basic friction coefficient is (screw fittings without lubrication) $\mu_k = \mu_G = 0.14$. The calculated values are valid for room temperature ($T = 20^\circ\text{C}$).

Dimension	Rise P	Tightening torque Ma (Nm)					
		3.6	4.6	5.6	8.8, A2 a. A4-80	10.9	12.9
M 1.6	0.4	0.05		0.05	0.17		0.28
M 2	0.45	0.1		0.11	0.35		0.6
M 2.5	0.45	0.21		0.23	0.73		1.23
M 3	0.5		0.54	1	1.3	1.7	2
M 3.5	0.6		0.85	1.3	1.9	2.6	3.2
M 4	0.7		1.02	2	2.5	4.4	5.1
M 5	0.8		2	2.7	5	8.7	10
M 6	1		3.5	4.6	10	15	18
M 8	1.25		8.4	11	25	36	43
M 10	1.5		17	22	49	72	84
M 12	1.75		29	39	85	125	145
M 14	2		46	62	135	200	235
M 16	2		71	95	210	310	365
M 18	2.5		97	130	300	430	500
M 20	2.5		138	184	425	610	710
M 22	2.5		186	250	580	830	970
M 24	3		235	315	730	1050	1220
M 27	3		350	470	1100	1550	1800
M 30	3.5		475	635	1450	2100	2450
M 33	3.5		645	865	2000	2800	3400
M 36	4		1080	1440	2600	3700	4300
M 39	4		1330	1780	3400	4800	5600

8.1.3 Position of connections

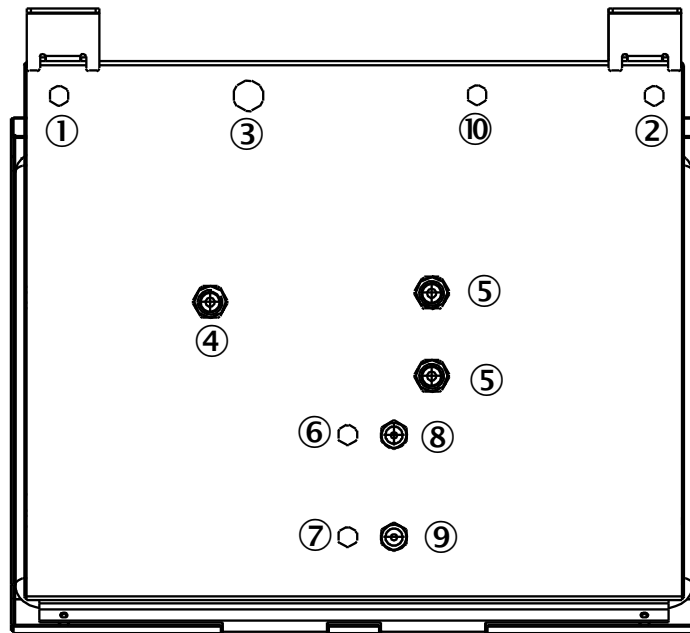

- ① Purging of enclosure (option), gas inlet
- ② Purging of enclosure (option), gas outlet
- ③ LAN
- ④ Power supply. The cable inlets are suitable for cables with outer diameter 7 ...12 mm.
- ⑤ I/O. The cable inlets are suitable for cables with outer diameter 7 ...12 mm.
- ⑥ Second gas path, gas inlet
- ⑦ Second gas path, gas outlet
- ⑧ Gas inlet
- ⑨ Gas outlet
- ⑩ Bonding load connection

8.2 Enclosure specifications

Design:	Closed steel sheet enclosure
Degree of protection:	IP 66 (Nema 4X)
Dimensions:	See 27
Weight:	Depending on equipment: max. approx. 30 kg
Identification for GMS84x:	see "Product identification", page 9

8.3 Ambient conditions

Atmospheric influences:	Only for use indoors
Allowable contamination:	Degree of contamination 2 ^[1]
Fitting position (allowable offset):	Only install the enclosure horizontally (cover opens downwards).
Geographic height at installation location:	Max. 2000 m
Allowable oscillations (amplitude): ^[2]	0.035 mm in range 5 ... 59 Hz
Allowable vibrations (acceleration): ^[2]	5 m/s ² in range 59 ... 160 Hz
Jolts:	≤ 15 g over 11 ms ^[3]
Relative humidity:	10 ... 95%, non-condensing
Ambient temperature during operation:	+5 ... +45 °C (41 ... 113 °F)
Transport /storage temperature:	-10 ... +70 °C (14 ... 158 °F)

[1] Dry and wet contamination that can be electrically conductive.

[2] Observe DIN 15267-3, DIN EN 60068-2-26; as well as specifications for built-in Analyzer modules.

[3] Shock test in accordance with DIN EN 60068-2-27.

8.4 Gas connections

Version

Description	Material	Suitable for
Inner thread G ¼" ^[1] :	Stainless steel	Screw-in screw fittings
Plastic clamping ring screw connection	PVDF	Hose 6x1 mm
Swagelok 6 mm	Stainless steel	Metal tube with 6 mm outer Ø
Swagelok ¼"	Stainless steel	Metal tube with ¼" outer Ø

[1] Standard version.

Approval conditions

For GMS841 (ATEX/ IECEx)

Parameter	Allowable value
Sample gas pressure in sample gas line:	-500 ... +1000 hPa (-0.5 ... +1.0 bar)
Sample gas volume flow:	Max. 100 dm ³ /hour



- Sample gas connection positions, [see "Dimensions, fitting position and connections", page 27](#)
- Sample gas connections function → "GMS800 Series" Operating Instructions.
- Other sample gas specifications (pressure, volume flow etc.) → Addendum to Operating Instructions for the Analyzer modules fitted.

For GMS842 (cCSA_{US})

Parameter	Allowable value
Sample gas pressure in sample gas line:	-500 ... +1000 hPa (-0.5 ... +1.0 bar)
Sample gas volume flow:	Max. 100 dm ³ /hour
Maximum purge gas pressure in enclosure:	30 hPa (30 mbar)



- Sample gas connection positions, .see “Dimensions, fitting position and connections”, page 27
- Sample gas connections function → “GMS800 Series” Operating Instructions.
- Other sample gas specifications (pressure, volume flow etc.) → Addendum to Operating Instructions for the Analyzer modules fitted.

8.5 Power connection



WARNING: A wrong power supply unit voids the approval

- ▶ Only replace the power supply unit with a power supply unit of the same type.

Power supply unit version: GMS842 (cCSA_{US}) and GMS840

Approval	cSAUL _{US} ClassI Div2 Group A-D T4
Power voltage:	85 ... 264 V AC (automatic switchover)
Power frequency (AC):	47 ... 63 Hz
Power input:	50 ... 300 VA (depending on equipment)
Secondary fuse:	10 A (exchangeable fusible cutout) [1]
Required connection cable Conductor cross-section: Version:	3 times 1.5 mm ² (AGW 16) Cable listed according to CSA / UL, oil resistance and flame retardancy have to be observed according to the requirements

[1] F1 on the “fuse board”. Spare part: “ET fuse F10A0”, Part No. 2062251.

Power supply unit version: GMS841 (ATEX/ IECEx)

Approval	IEC/EN 60079-15 Ex II3G EX nA IIC (T4) Gc
Power voltage	85 ... 132 V AC 187 ... 264 V AC
Power frequency (AC):	47 ... 63 Hz
Power input:	50 ... 300 VA (depending on equipment)
Secondary fuse:	10 A (exchangeable fusible cutout) [1]
Required connection cable Conductor cross-section: Version:	3 times 1.5 mm ² (AGW 16) Oil resistance and flame retardancy have to be observed according to the requirements

[1] F1 on the “fuse board”. Spare part: “ET fuse F10AH250V”.

8.6 Electrical safety/ EMC

Protection class:	Protection class I [1]
Degree of soiling	2
Electrical safety:	Tested according to CSA/EN 61010-1 Low Voltage Directive 2014/35/EU
Electromagnetic compatibility:	In accordance with EN 61326-1, EN 61326-2-1, EN 61000-6-2, EN 61000-6-4 and Directive 2014/30/EU

[1] VDE 0411 Part 1 / IEC 348

8.7 Technical data for intrinsically safe signal connections

Signal connection	Parameter	Specification
Analog outputs ^[1]	Maximum voltage on connection terminals:	13 V
	Allowable load:	0 ... 200 Ω
Digital inputs	Maximum voltage on connection terminals:	26.5 V
Digital outputs	Internal resistance:	300 Ω

[1] Observe information on zero potential

8.7.1 Limit values for intrinsically safe analog outputs

Parameters of the intrinsically safe power circuit	Allowable value
Total inductivity L_A	≤ 0.5 mH
Total capacity C_A	≤ 478 nF
Maximum output current I_{max}	≤ 200 mA

8.7.2 Limit values for intrinsically safe digital inputs and digital outputs

Parameters of the intrinsically safe power circuit	Allowable value
Total inductivity L_A	≤ 1.6 mH
Total capacity C_A	≤ 83 nF
Maximum output current I_{max}	≤ 75 mA

9 Index

A

Additional documentation (information)	7
Ambient conditions	30
- Corrosive atmospheres	15
- General	15
Application limitations	7
Assembly	15
Atmosphere	30

C

Characteristics	10
Climate (at installation location)	15
Closing	21
Combustible sample gas (approval conditions)	7
Connections	16
- Electrical connections	17
- Gas connections	16
- Purge gas connections	16

D

Dimensions	27, 30
------------------	--------

E

Explosion protection	9, 26
Explosive atmosphere	7

F

Fitting (assembly)	15
Fuses	31

G

Gas connections	16
- Position	27, 30
- Purge gas	16
- Technical data	30

I

Identification	9
Important information	
- Main hazards	7
- Main operating information	7
Intrinsically safe signal connections	20
- Allowable capacity/inductivity	21
- Electronic limit values	21
- Technical layout	20

L

Leak tightness, checking	
- Purge gas paths	24
- Sample gas lines	24

M

Maintenance	
- Care of the enclosure	23

O

Open	
- Front door	13, 17
- Safety information	11
Options	10

P

Power connection	
- Connecting	18
- External fuse (Note)	18
- External main power switch (Note)	18
- Internal fuse	31
- Technical data	31
Product description	10
Product identification	9
Product options	10
Purge gas	
- Composition	16
- Connections	16
- Maximum pressure in enclosure	16
- Regular leak tightness check	24
Purge gas connections	16

S

Safety information	
- Enclosure, opening	11
- Main hazards	7
- Main operating information	7
- Penetrating liquids	23
- Transport and assembly	14
Sample gas	
- Leak tightness check	24
- Protection against dangerous sample gases	15
Sample gas connections	16
Scope of delivery	14
Screw fittings (technical data)	30
Sealing	21
Shutdown	25
Signal connections	
- Intrinsically safe (option)	20
- To the I/O module (standard)	19
Specifications	see "Technical Data"
Start-up	22
Swagelok	30

T

Technical data	
- Ambient conditions	30
- Dimensions	30
- Enclosure specifications	27, 30
- For intrinsically safe signal connections	21
- Gas connections	30
- Power connection data	31
Temperature	30
Type plate	9

Z

Zener barriers	20
----------------------	----

Australia

Phone +61 3 9457 0600
1800 334 802 – tollfree
E-Mail sales@sick.com.au

Austria

Phone +43 (0)22 36 62 28 8-0
E-Mail office@sick.at

Belgium/Luxembourg

Phone +32 (0)2 466 55 66
E-Mail info@sick.be

Brazil

Phone +55 11 3215-4900
E-Mail marketing@sick.com.br

Canada

Phone +1 905 771 14 44
E-Mail information@sick.com

Czech Republic

Phone +420 2 57 91 18 50
E-Mail sick@sick.cz

Chile

Phone +56 2 2274 7430
E-Mail info@schadler.com

China

Phone +86 4000 121 000
E-Mail info.china@sick.net.cn

Denmark

Phone +45 45 82 64 00
E-Mail sick@sick.dk

Finland

Phone +358-9-2515 800
E-Mail sick@sick.fi

France

Phone +33 1 64 62 35 00
E-Mail info@sick.fr

Germany

Phone +49 211 5301-301
E-Mail info@sick.de

Great Britain

Phone +44 (0)1727 831121
E-Mail info@sick.co.uk

Hong Kong

Phone +852 2153 6300
E-Mail ghk@sick.com.hk

Hungary

Phone +36 1 371 2680
E-Mail office@sick.hu

India

Phone +91-22-4033 8333
E-Mail info@sick-india.com

Israel

Phone +972-4-6881000
E-Mail info@sick-sensors.com

Italy

Phone +39 02 27 43 41
E-Mail info@sick.it

Japan

Phone +81 (0)3 5309 2112
E-Mail support@sick.jp

Malaysia

Phone +603 808070425
E-Mail enquiry.my@sick.com

Netherlands

Phone +31 (0)30 229 25 44
E-Mail info@sick.nl

New Zealand

Phone +64 9 415 0459
0800 222 278 – tollfree
E-Mail sales@sick.co.nz

Norway

Phone +47 67 81 50 00
E-Mail sick@sick.no

Poland

Phone +48 22 837 40 50
E-Mail info@sick.pl

Romania

Phone +40 356 171 120
E-Mail office@sick.ro

Russia

Phone +7-495-775-05-30
E-Mail info@sick.ru

Singapore

Phone +65 6744 3732
E-Mail sales.gsg@sick.com

Slovakia

Phone +421 482 901201
E-Mail mail@sick-sk.sk

Slovenia

Phone +386 (0)1-47 69 990
E-Mail office@sick.si

South Africa

Phone +27 11 472 3733
E-Mail info@sickautomation.co.za

South Korea

Phone +82 2 786 6321
E-Mail info@sickkorea.net

Spain

Phone +34 93 480 31 00
E-Mail info@sick.es

Sweden

Phone +46 10 110 10 00
E-Mail info@sick.se

Switzerland

Phone +41 41 619 29 39
E-Mail contact@sick.ch

Taiwan

Phone +886 2 2375-6288
E-Mail sales@sick.com.tw

Thailand

Phone +66 2645 0009
E-Mail tawiwat@sicksgp.com.sg

Turkey

Phone +90 (216) 528 50 00
E-Mail info@sick.com.tr

United Arab Emirates

Phone +971 (0) 4 88 65 878
E-Mail info@sick.ae

USA/Mexico

Phone +1(952) 941-6780
1 (800) 325-7425 – tollfree
E-Mail info@sick.com

Vietnam

Phone +84 8 62920204
E-Mail Ngo.Duy.Linh@sicksgp.com.sg

More representatives and agencies
at www.sick.com